

Power Spectral Density spectrum plot of Chain B value:

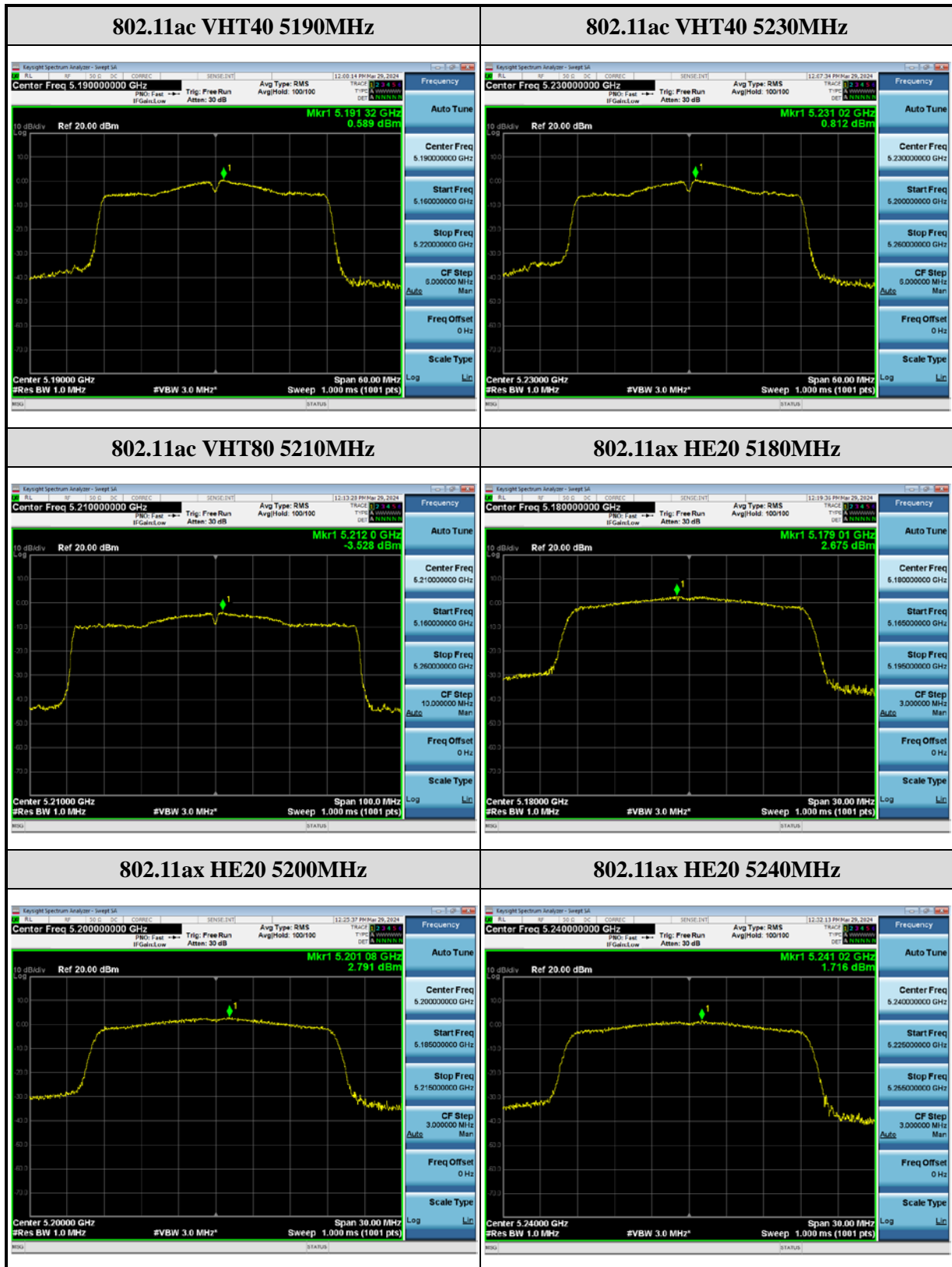

Power Spectral Density spectrum plot of Chain B value:

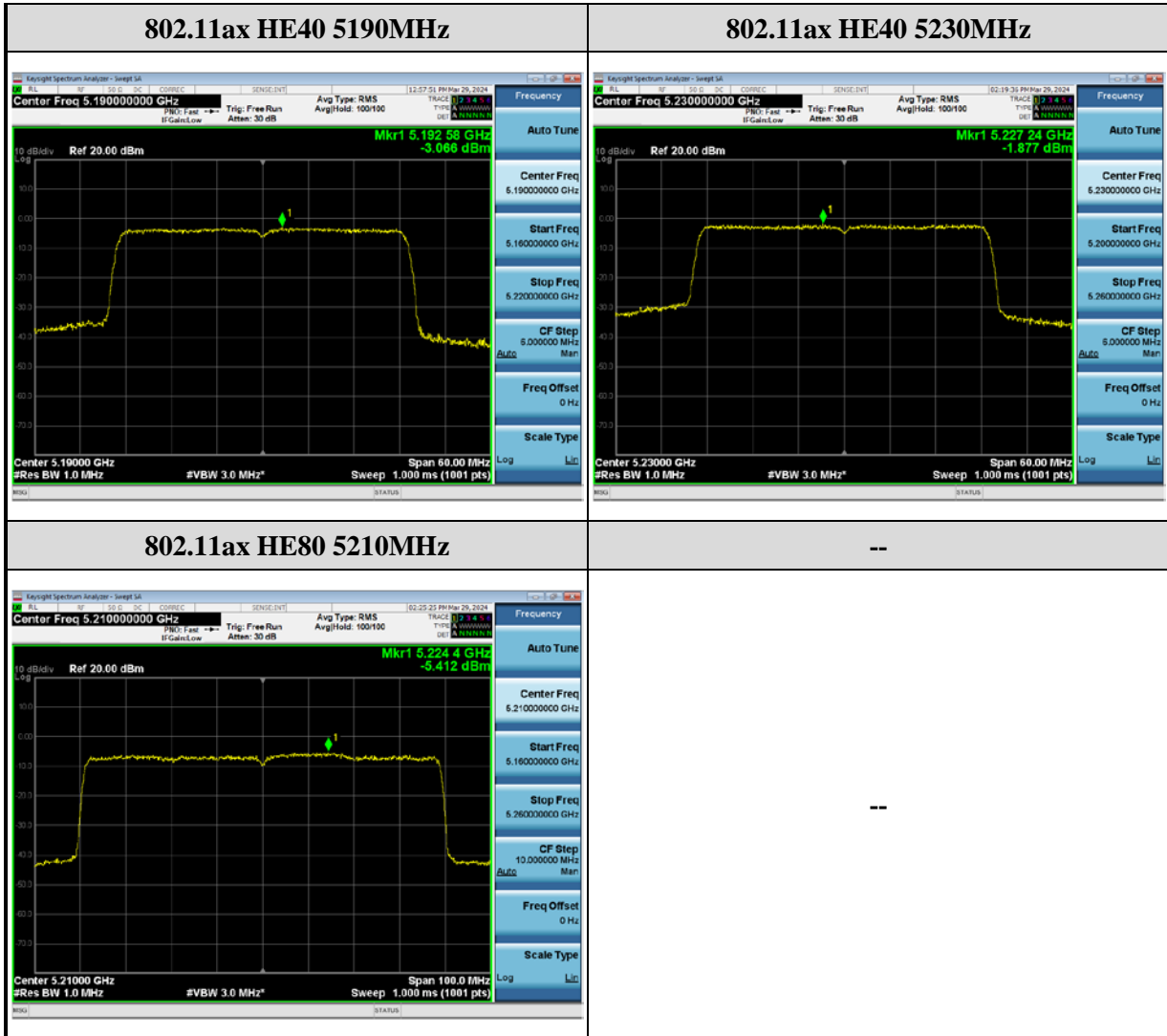

For 5725 MHz ~ 5850 MHz
802.11a

Frequency (MHz)	PSD (dBm)		Total PSD (dBm/500kHz)	Limit (dBm/500kHz)	Result
	Chain A	Chain B			
5745	--	6.35	--	< 30	Pass
5785	--	6.15	--	< 30	Pass
5825	--	5.51	--	< 30	Pass

Remark:

1. Measured value = Reading value on a spectrum analyzer + cable loss + duty factor
2. $\text{PSD}(\text{dBm}/500\text{kHz}) = \text{Measured value} + 10 \cdot \log(500\text{kHz}/1\text{MHz})$

802.11ac VHT20

Frequency (MHz)	PSD (dBm)		Total PSD (dBm/500kHz)	Limit (dBm/500kHz)	Result
	Chain A	Chain B			
5745	2.61	2.66	5.64	< 29.45	Pass
5785	1.90	2.82	5.39	< 29.45	Pass
5825	1.89	3.09	5.54	< 29.45	Pass

Remark:

1. Measured value = Reading value on a spectrum analyzer + cable loss + duty factor
2. $\text{PSD}(\text{dBm}/500\text{kHz}) = \text{Measured value} + 10 \cdot \log(500\text{kHz}/1\text{MHz})$

802.11ac VHT40

Frequency (MHz)	PSD (dBm)		Total PSD (dBm/500kHz)	Limit (dBm/500kHz)	Result
	Chain A	Chain B			
5755	-0.51	-0.01	2.76	< 29.45	Pass
5795	-0.31	0.30	3.02	< 29.45	Pass

Remark:

1. Measured value = Reading value on a spectrum analyzer + cable loss + duty factor
2. $\text{PSD}(\text{dBm}/500\text{kHz}) = \text{Measured value} + 10 \cdot \log(500\text{kHz}/1\text{MHz})$

802.11ac VHT80

Frequency (MHz)	PSD (dBm)		Total PSD (dBm/500kHz)	Limit (dBm/500kHz)	Result
	Chain A	Chain B			
5775	-3.46	-2.24	0.20	< 29.45	Pass

Remark:

1. Measured value = Reading value on a spectrum analyzer + cable loss + duty factor
2. $\text{PSD}(\text{dBm}/500\text{kHz}) = \text{Measured value} + 10 \cdot \log(500\text{kHz}/1\text{MHz})$

802.11ax HE20

Frequency (MHz)	PSD (dBm)		Total PSD (dBm/500kHz)	Limit (dBm/500kHz)	Result
	Chain A	Chain B			
5745	0.55	1.46	4.04	< 29.45	Pass
5785	0.77	1.12	3.96	< 29.45	Pass
5825	-0.64	0.57	3.02	< 29.45	Pass

Remark:

1. Measured value = Reading value on a spectrum analyzer + cable loss + duty factor
2. $PSD(dBm/500kHz) = \text{Measured value} + 10 \cdot \log(500kHz/1MHz)$

802.11ax HE40

Frequency (MHz)	PSD (dBm)		Total PSD (dBm/500kHz)	Limit (dBm/500kHz)	Result
	Chain A	Chain B			
5755	-3.49	-2.72	-0.08	< 29.45	Pass
5795	-3.07	-2.35	0.32	< 29.45	Pass

Remark:

1. Measured value = Reading value on a spectrum analyzer + cable loss + duty factor
2. $PSD(dBm/500kHz) = \text{Measured value} + 10 \cdot \log(500kHz/1MHz)$

802.11ax HE80

Frequency (MHz)	PSD (dBm)		Total PSD (dBm/500kHz)	Limit (dBm/500kHz)	Result
	Chain A	Chain B			
5775	-6.61	-5.49	-3.00	< 29.45	Pass

Remark:

1. Measured value = Reading value on a spectrum analyzer + cable loss + duty factor
2. $PSD(dBm/500kHz) = \text{Measured value} + 10 \cdot \log(500kHz/1MHz)$

Power Spectral Density spectrum plot of Chain A value:

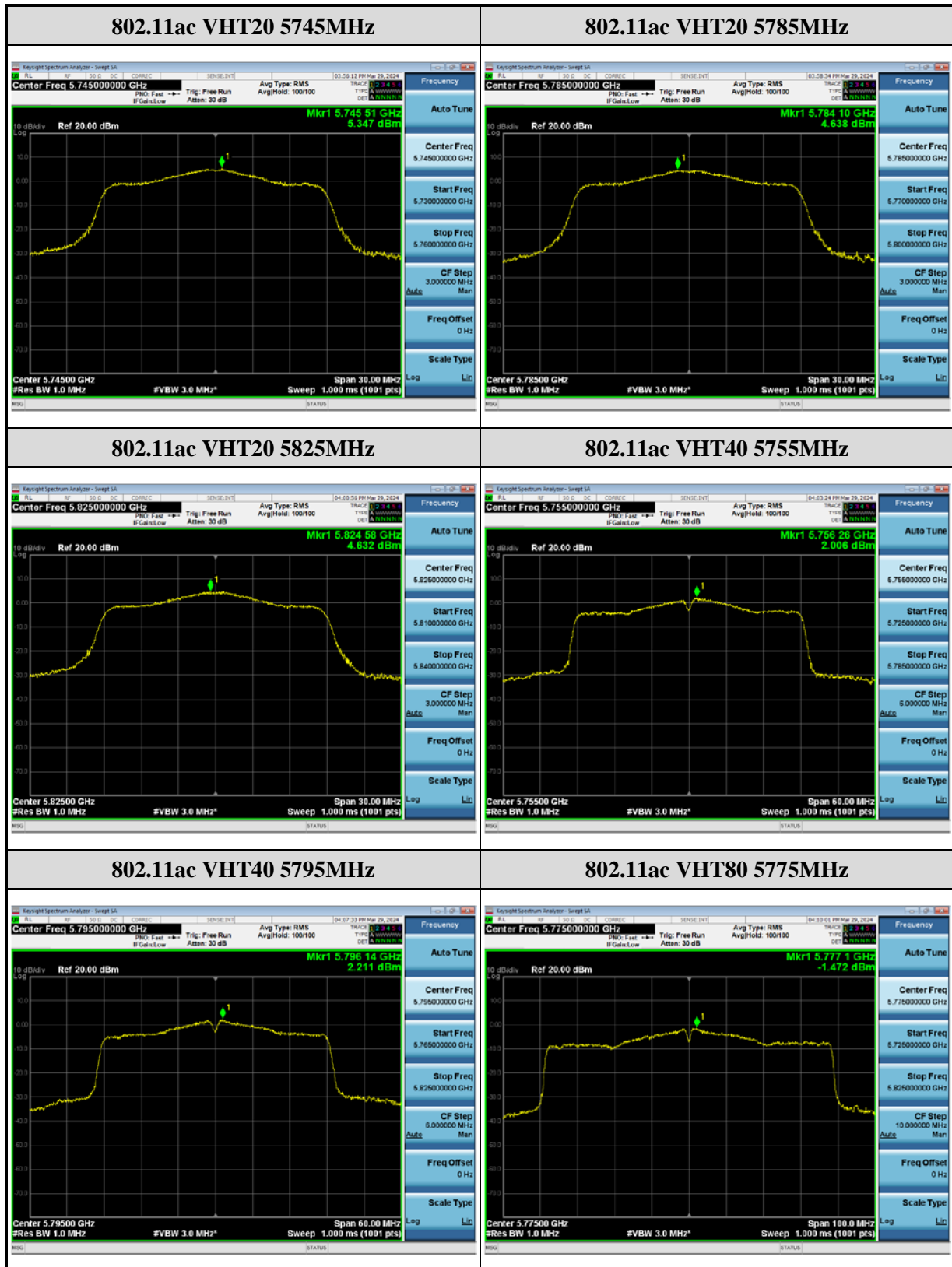

Power Spectral Density spectrum plot of Chain A value:

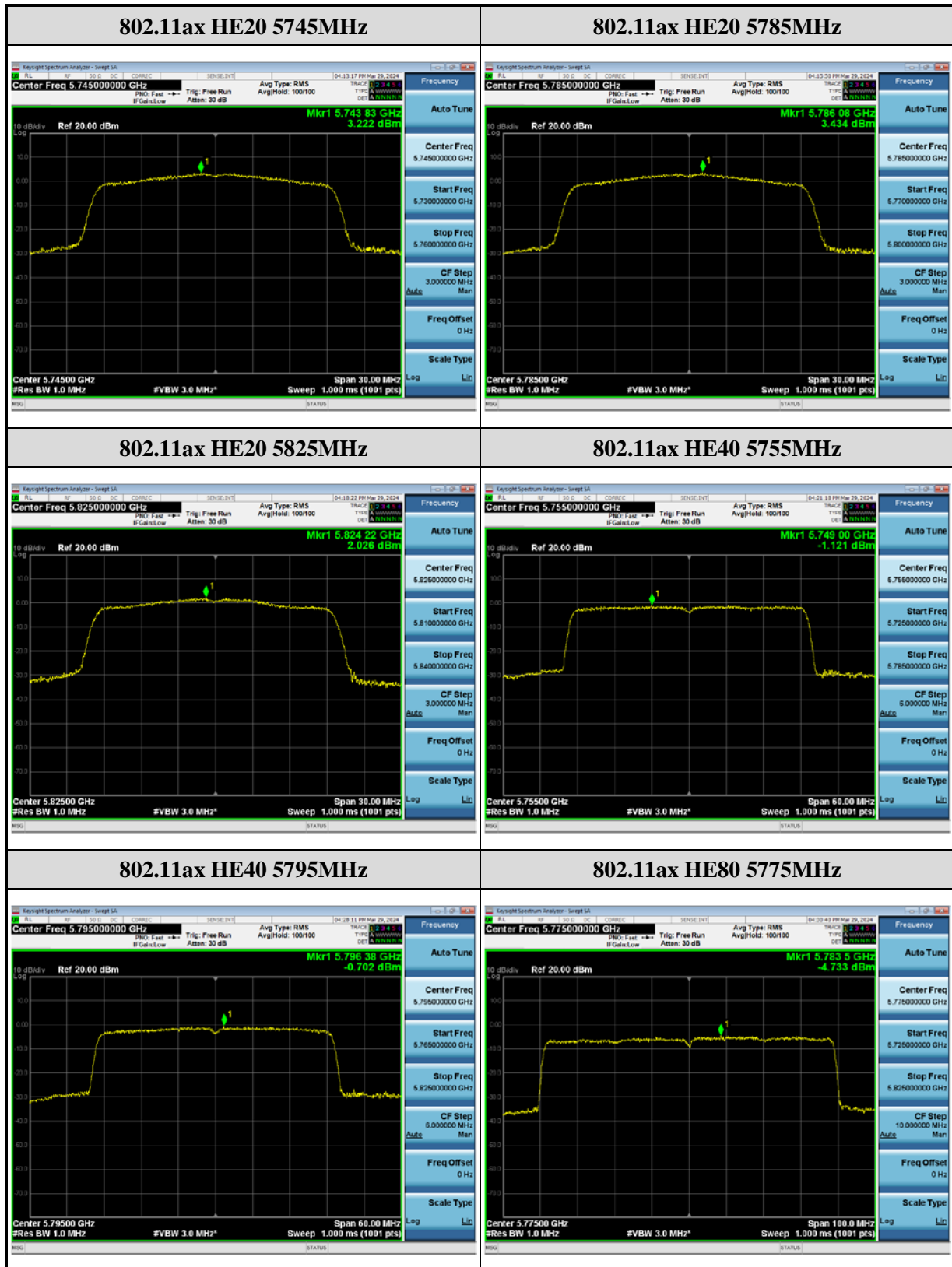

Power Spectral Density spectrum plot of Chain B value:

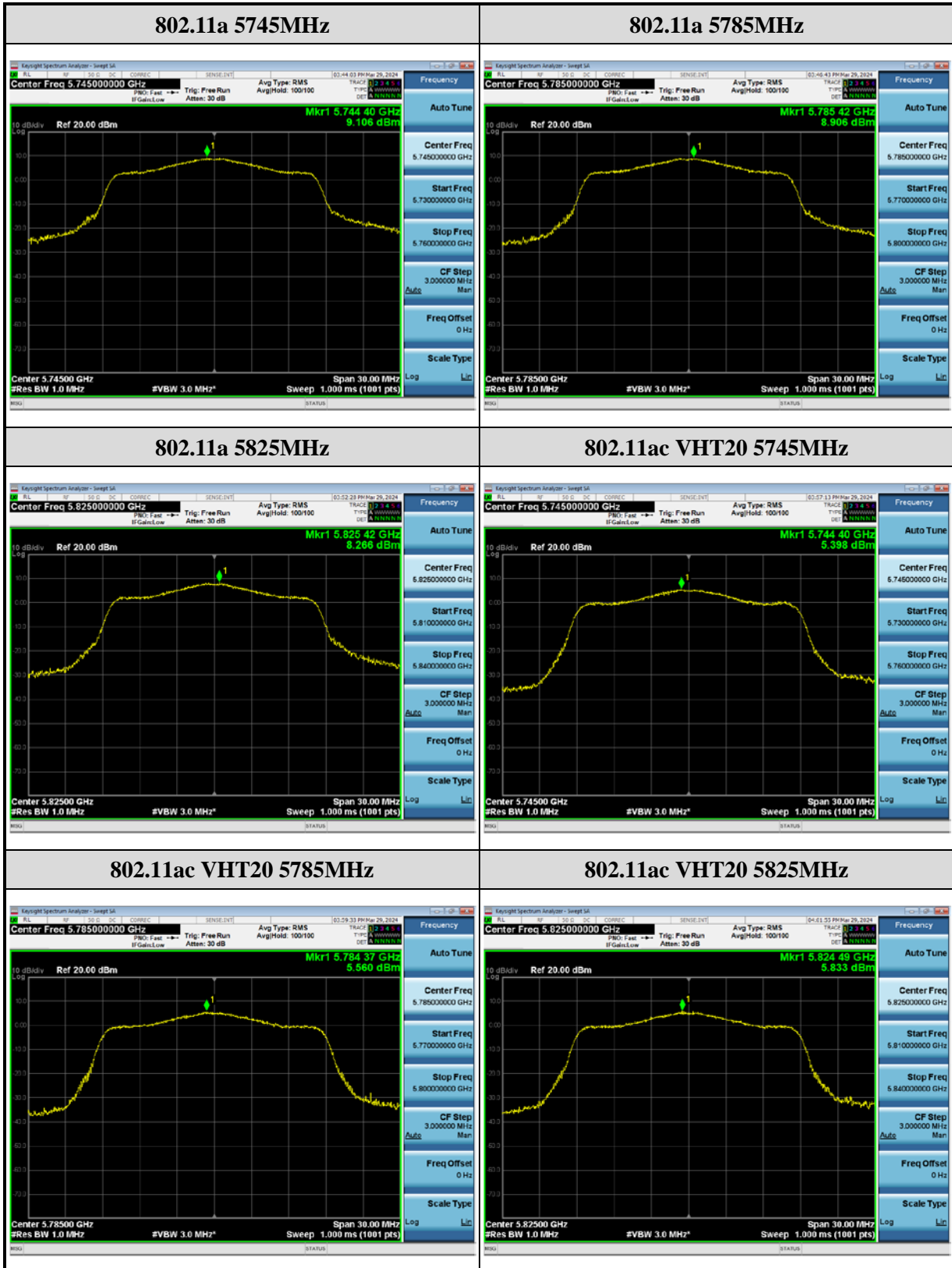

Power Spectral Density spectrum plot of Chain B value:

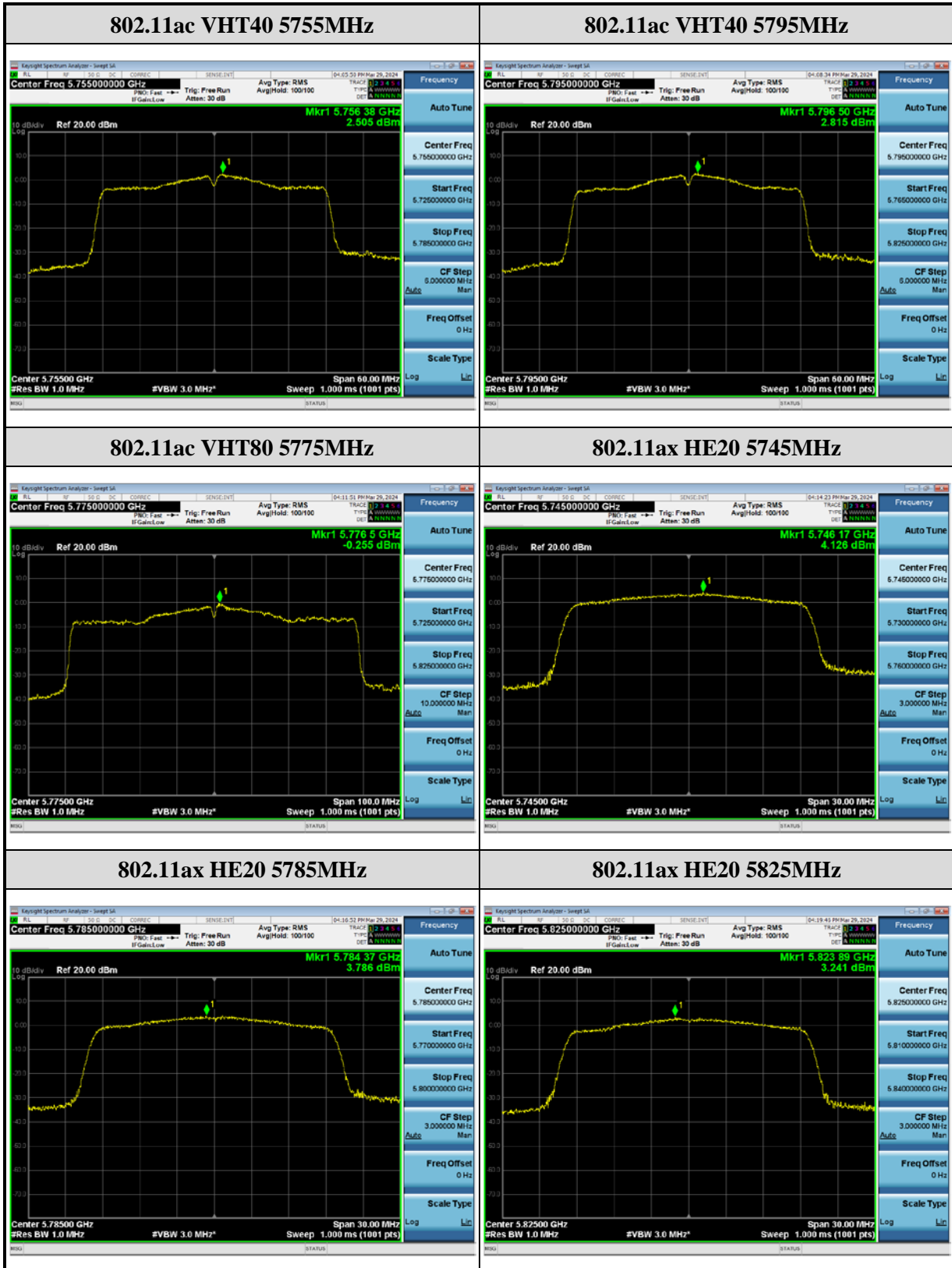

Power Spectral Density spectrum plot of Chain B value:

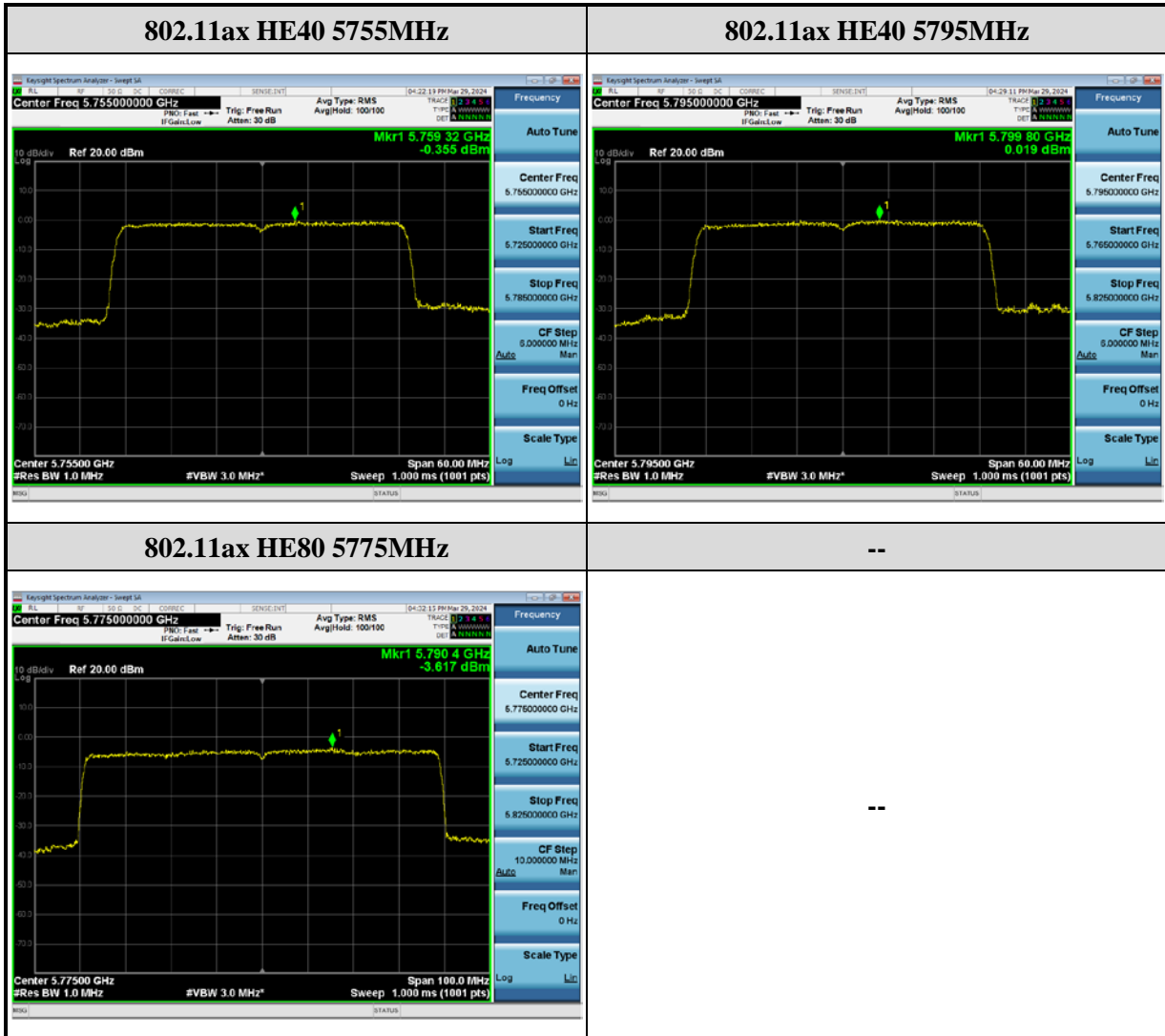

2.5 Unwanted Emission Measurement

2.5.1 Limit

1. Un- restricted bands unwanted emission limit :

Operating Band (MHz)	Limit of all emissions outside of the operating band
5150 ~ 5250	-27dBm/MHz, EIRP
5250 ~ 5350	-27dBm/MHz, EIRP
5470 ~ 5725	-27dBm/MHz, EIRP
5725 ~ 5850	All emissions shall be limited to a level of -27 dBm/MHz at 75 MHz or more above or below the band edge increasing linearly to 10 dBm/MHz at 25 MHz above or below the band edge, and from 25 MHz above or below the band edge increasing linearly to a level of 15.6 dBm/MHz at 5 MHz above or below the band edge, and from 5 MHz above or below the band edge increasing linearly to a level of 27 dBm/MHz at the band edge.

EIRP (dBm)	Field Strength at 3m (dBμV/m)
- 27	68.2

2. Restricted bands unwanted emission limit :

Frequency (MHz)	Field Strength (μV/m)	Measurement Distance (m)
0.009 – 0.490	2400/F(kHz)	300
0.490 – 1.705	24000/F(kHz)	30
1.705 – 30.0	30	30
30 – 88	100	3
88 – 216	150	3
216 - 960	200	3
Above 960	500	3

Remarks:

1. RF Voltage (dBuV) = 20 log RF Voltage(uV)
2. In the Above Table, the tighter limit applies at the band edges.
3. Distance refers to the distance in meters between the measuring instrument antenna and the closed point of any part of the device or system

2.5.2 Test Setup

Below 30MHz

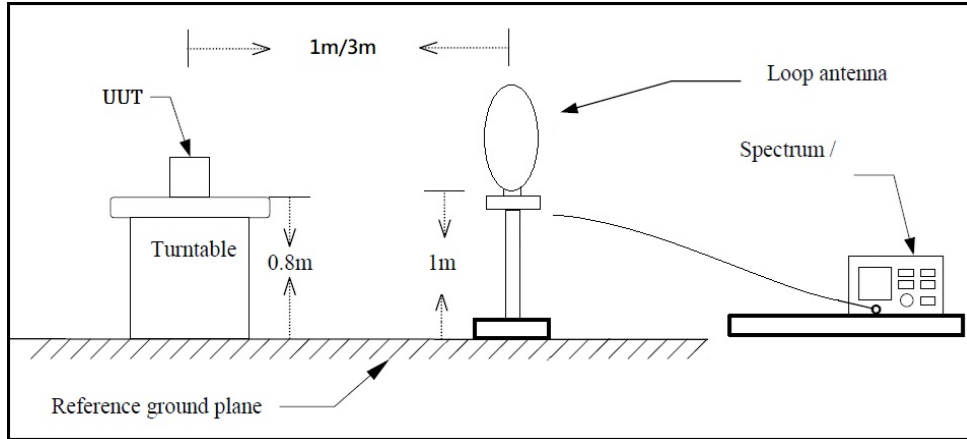

30MHz~1GHz

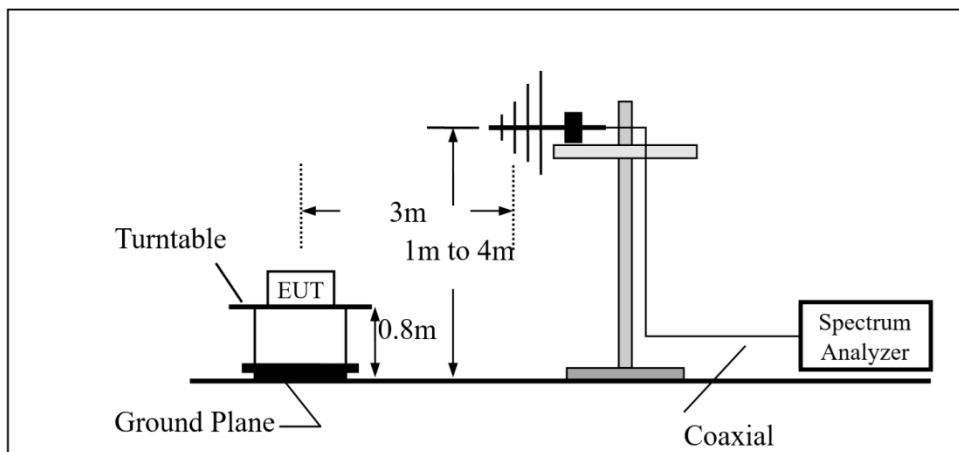

Above 1GHz

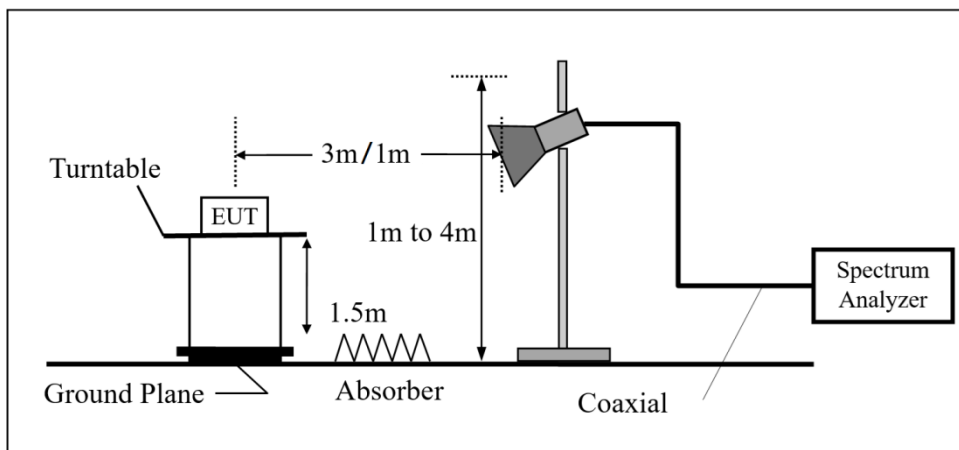

2.5.3 Test Procedure

The EUT was setup according to ANSI C63.10, 2013 and tested according test procedure of KDB 789033 for compliance to FCC 47CFR 15.407 requirements.

The following bandwidths were used during emissions testing.

Frequency	RBW	VBW
9 kHz to 150 kHz	200 Hz to 300 Hz	3 × RBW
0.15 MHz to 30 MHz	9 kHz to 10 kHz	3 × RBW
30 MHz to 1000 MHz	100 kHz to 120 kHz	3 × RBW
>1000 MHz	1 MHz	3 × RBW

For Radiated emission below 30MHz

- (1) The EUT was placed on the top of a rotating table 0.8 meters above the ground in a 3 meter chamber room. The table was rotated 360 degrees to determine the position of the highest radiation.
- (2) The EUT was set 3 meters away from the interference-receiving antenna, which was mounted on the top of a variable-height antenna tower.
- (3) Parallel, perpendicular, and ground-parallel orientations of the antenna are set to make the measurement.
- (4) For each suspected emission, the EUT was arranged to its worst case and the rotatable table was turned from 0 degrees to 360 degrees to find the maximum reading.
- (5) The test-receiver system was set to Quasi-Peak Detect Function and Specified Bandwidth with Maximum Hold Mode.

For Radiated emission Above 30MHz

- (1) The EUT was placed on the top of a rotating table 0.8 meters (for below 1GHz) / 1.5 meters (for above 1GHz) above the ground at 3 meter chamber room for the test. The table was rotated 360 degrees to determine the position of the highest radiation.
- (2) The EUT was set 3 meters away from the interference-receiving antenna, the height of the antenna is varied from 1 meter to 4 meters above the ground to determine the maximum value of the field strength.
- (3) Parallel, perpendicular, and ground-parallel orientations of the antenna are set to make the measurement.
- (4) For each suspected emission, the EUT was arranged to its worst case and the rotatable table was turned from 0 degrees to 360 degrees to find the maximum reading.
- (5) The test-receiver system was set to quasi-peak detect function and specified bandwidth with maximum hold mode when the test frequency is below 1 GHz.
- (6) The test-receiver system was set to peak and average detect function and specified bandwidth with maximum hold mode when the test frequency is above 1 GHz. If the peak reading value also meets the average limit, measurement with the average detector is unnecessary.

2.5.4 Duty Cycle

Type of Modulation	Frequency (MHz)	on time (ms)	on+off time (ms)	Duty cycle	Duty Factor (dB)	1/T Minimum VBW (kHz)
802.11a	5180	1.415	1.500	0.943	0.253	0.707
802.11ac VHT20	5180	1.330	1.415	0.940	0.269	0.752
802.11ac VHT40	5190	0.681	0.763	0.893	0.494	1.468
802.11ac VHT80	5210	0.333	0.421	0.790	1.022	3.005
802.11ax HE20	5180	1.035	1.120	0.924	0.343	0.966
802.11ax HE40	5190	0.549	0.637	0.862	0.646	1.821
802.11ax HE80	5210	0.301	0.391	0.770	1.136	3.327

2.5.5 Test Result of Radiated Band Edge Measurement

The following tables for radiated measurement, pre-scanned in three orthogonal panels, X, Y, Z. The worst cases (X axis) were recorded in this report.

Test Frequency			
RF	802.11a / 802.11ac VHT20 802.11ax HE20	802.11ac VHT40 802.11ax HE40	802.11ac VHT80 802.11ax HE80
Tx	CH36 (5180MHz) CH149 (5745MHz) CH165 (5825MHz)	CH38 (5190MHz) CH151 (5755MHz) CH159 (5795MHz)	CH42 (5210MHz) CH155 (5775MHz)

Test Mode :	Transmit (802.11a 6Mbps)	Test Date :	2024/03/25
Test Channel :	CH36(5180MHz)	Temperature :	23.5 °C
Polarization :	Horizontal	Relative Humidity :	46 %

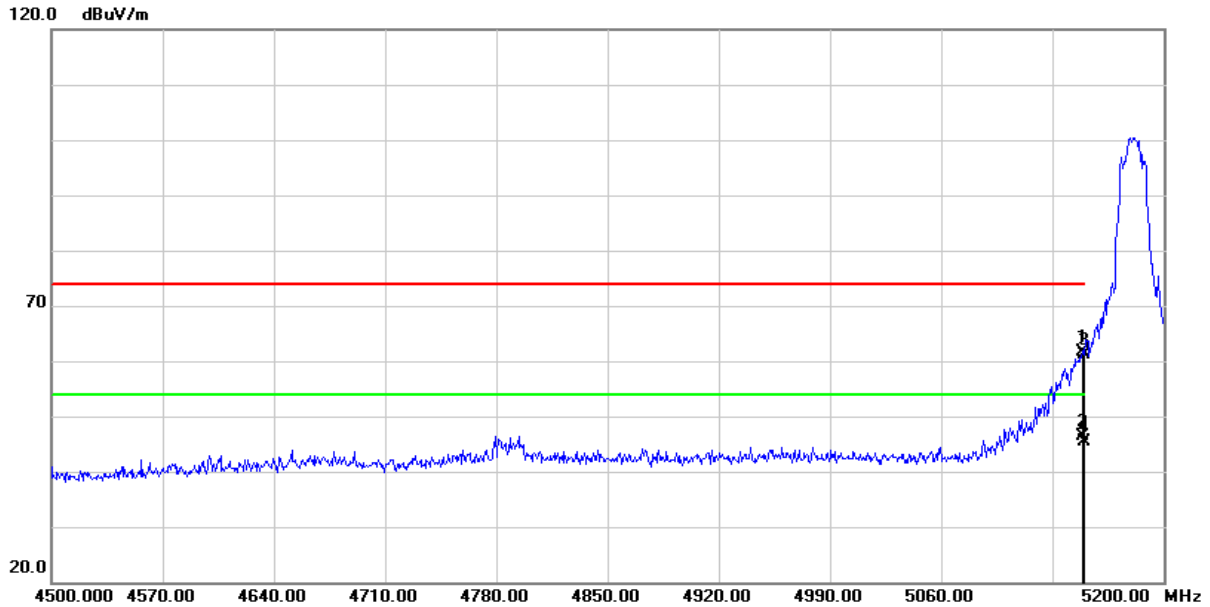

No.	Frequency (MHz)	Reading (dBuV/m)	Correct Factor (dB/m)	Result (dBuV/m)	Limit (dBuV/m)	Margin (dB)	Remark
1	5148.900	58.41	3.14	61.55	74.00	-12.45	peak
2	5148.900	43.34	3.14	46.48	54.00	-7.52	AVG
3	5150.000	57.91	3.14	61.05	74.00	-12.95	peak
4	5150.000	42.32	3.14	45.46	54.00	-8.54	AVG

Remark :

1. Correction Factor = Antenna factor + Cable loss – Amplifier gain
2. Result Value = Reading Level + Correct Factor
3. Margin Level = Result Value – Limit Value
4. The other emission levels were very low against the limit

Test Mode :	Transmit (802.11a 6Mbps)	Test Date :	2024/03/25
Test Channel :	CH36(5180MHz)	Temperature :	23.5 °C
Polarization :	Vertical	Relative Humidity :	46 %

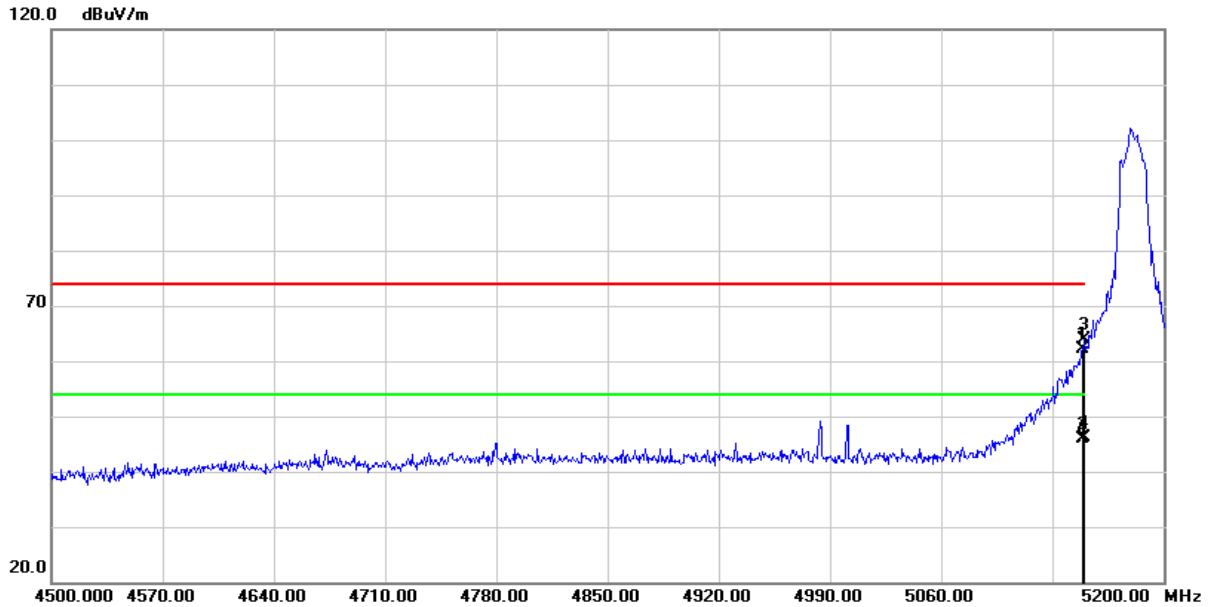

No.	Frequency (MHz)	Reading (dBuV/m)	Correct Factor (dB/m)	Result (dBuV/m)	Limit (dBuV/m)	Margin (dB)	Remark
1	5148.900	59.01	3.14	62.15	74.00	-11.85	peak
2	5148.900	42.77	3.14	45.91	54.00	-8.09	AVG
3	5150.000	60.83	3.14	63.97	74.00	-10.03	peak
4	5150.000	42.98	3.14	46.12	54.00	-7.88	AVG

Remark :

1. Correction Factor = Antenna factor + Cable loss – Amplifier gain
2. Result Value = Reading Level + Correct Factor
3. Margin Level = Result Value – Limit Value
4. The other emission levels were very low against the limit

Test Mode :	Transmit (802.11a 6Mbps)	Test Date :	2024/03/25
Test Channel :	CH149(5745MHz)	Temperature :	23.5 °C
Polarization :	Horizontal	Relative Humidity :	46 %

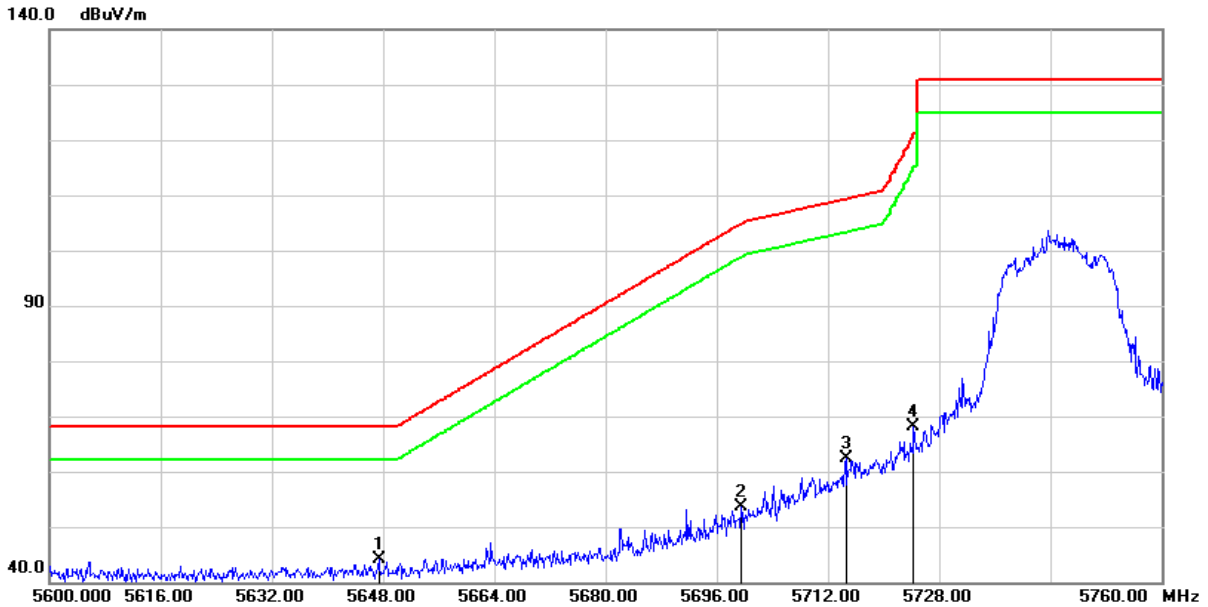

No.	Frequency (MHz)	Reading (dBuV/m)	Correct Factor (dB/m)	Result (dBuV/m)	Limit (dBuV/m)	Margin (dB)	Remark
1	5647.360	40.87	3.14	44.01	68.20	-24.19	peak
2	5699.520	50.29	3.41	53.70	104.84	-51.14	peak
3	5714.560	59.06	3.42	62.48	109.28	-46.80	peak
4	5724.320	64.72	3.43	68.15	120.65	-52.50	peak

Remark :

1. Correction Factor = Antenna factor + Cable loss – Amplifier gain
2. Result Value = Reading Level + Correct Factor
3. Margin Level = Result Value – Limit Value
4. The other emission levels were very low against the limit

Test Mode :	Transmit (802.11a 6Mbps)	Test Date :	2024/03/25
Test Channel :	CH149(5745MHz)	Temperature :	23.5 °C
Polarization :	Vertical	Relative Humidity :	46 %

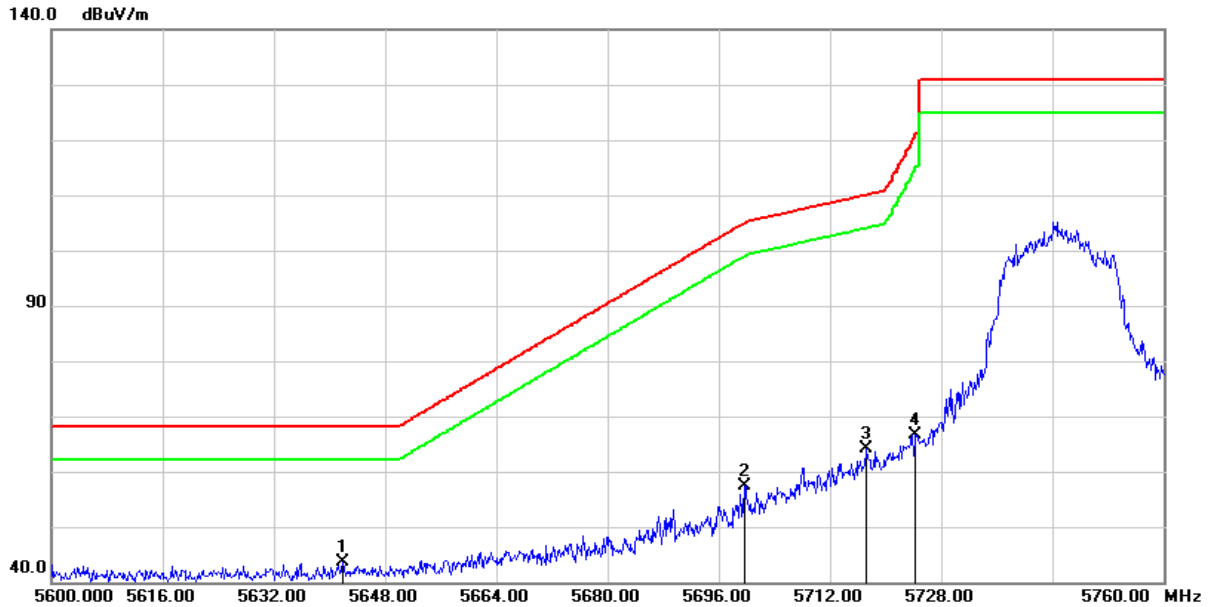

No.	Frequency (MHz)	Reading (dBuV/m)	Correct Factor (dB/m)	Result (dBuV/m)	Limit (dBuV/m)	Margin (dB)	Remark
1	5641.920	40.45	3.13	43.58	68.20	-24.62	peak
2	5699.680	54.07	3.41	57.48	104.96	-47.48	peak
3	5717.280	60.59	3.42	64.01	110.04	-46.03	peak
4	5724.320	63.32	3.43	66.75	120.65	-53.90	peak

Remark :

1. Correction Factor = Antenna factor + Cable loss – Amplifier gain
2. Result Value = Reading Level + Correct Factor
3. Margin Level = Result Value – Limit Value
4. The other emission levels were very low against the limit

Test Mode :	Transmit (802.11a 6Mbps)	Test Date :	2024/03/25
Test Channel :	CH165(5825MHz)	Temperature :	23.5 °C
Polarization :	Horizontal	Relative Humidity :	46 %



No.	Frequency (MHz)	Reading (dBuV/m)	Correct Factor (dB/m)	Result (dBuV/m)	Limit (dBuV/m)	Margin (dB)	Remark
1	5851.400	54.22	3.70	57.92	119.01	-61.09	peak
2	5855.200	50.09	3.72	53.81	110.74	-56.93	peak
3	5880.200	44.11	3.90	48.01	101.35	-53.34	peak
4	5940.600	41.23	4.10	45.33	68.20	-22.87	peak

Remark :

1. Correction Factor = Antenna factor + Cable loss – Amplifier gain
2. Result Value = Reading Level + Correct Factor
3. Margin Level = Result Value – Limit Value
4. The other emission levels were very low against the limit

Test Mode :	Transmit (802.11a 6Mbps)	Test Date :	2024/03/25
Test Channel :	CH165(5825MHz)	Temperature :	23.5 °C
Polarization :	Vertical	Relative Humidity :	46 %



No.	Frequency (MHz)	Reading (dBuV/m)	Correct Factor (dB/m)	Result (dBuV/m)	Limit (dBuV/m)	Margin (dB)	Remark
1	5851.400	54.63	3.70	58.33	119.01	-60.68	peak
2	5855.400	50.80	3.72	54.52	110.69	-56.17	peak
3	5876.400	46.17	3.88	50.05	104.16	-54.11	peak
4	5926.600	41.76	4.08	45.84	68.20	-22.36	peak

Remark :

1. Correction Factor = Antenna factor + Cable loss – Amplifier gain
2. Result Value = Reading Level + Correct Factor
3. Margin Level = Result Value – Limit Value
4. The other emission levels were very low against the limit

Test Mode :	Transmit (802.11ac VHT20 MCS0)	Test Date :	2024/03/25
Test Channel :	CH36(5180MHz)	Temperature :	23.5 °C
Polarization :	Horizontal	Relative Humidity :	46 %

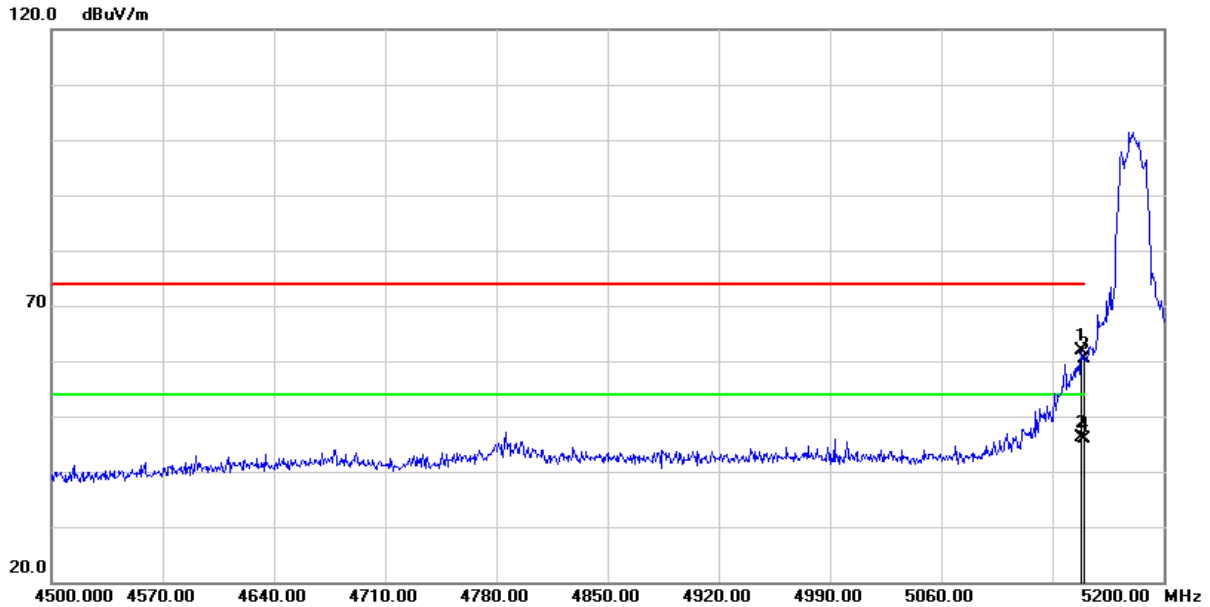

No.	Frequency (MHz)	Reading (dBuV/m)	Correct Factor (dB/m)	Result (dBuV/m)	Limit (dBuV/m)	Margin (dB)	Remark
1	5148.200	58.81	3.15	61.96	74.00	-12.04	peak
2	5148.200	43.07	3.15	46.22	54.00	-7.78	AVG
3	5150.000	57.35	3.14	60.49	74.00	-13.51	peak
4	5150.000	42.79	3.14	45.93	54.00	-8.07	AVG

Remark :

1. Correction Factor = Antenna factor + Cable loss – Amplifier gain
2. Result Value = Reading Level + Correct Factor
3. Margin Level = Result Value – Limit Value
4. The other emission levels were very low against the limit

Test Mode :	Transmit (802.11ac VHT20 MCS0)	Test Date :	2024/03/25
Test Channel :	CH36(5180MHz)	Temperature :	23.5 °C
Polarization :	Vertical	Relative Humidity :	46 %

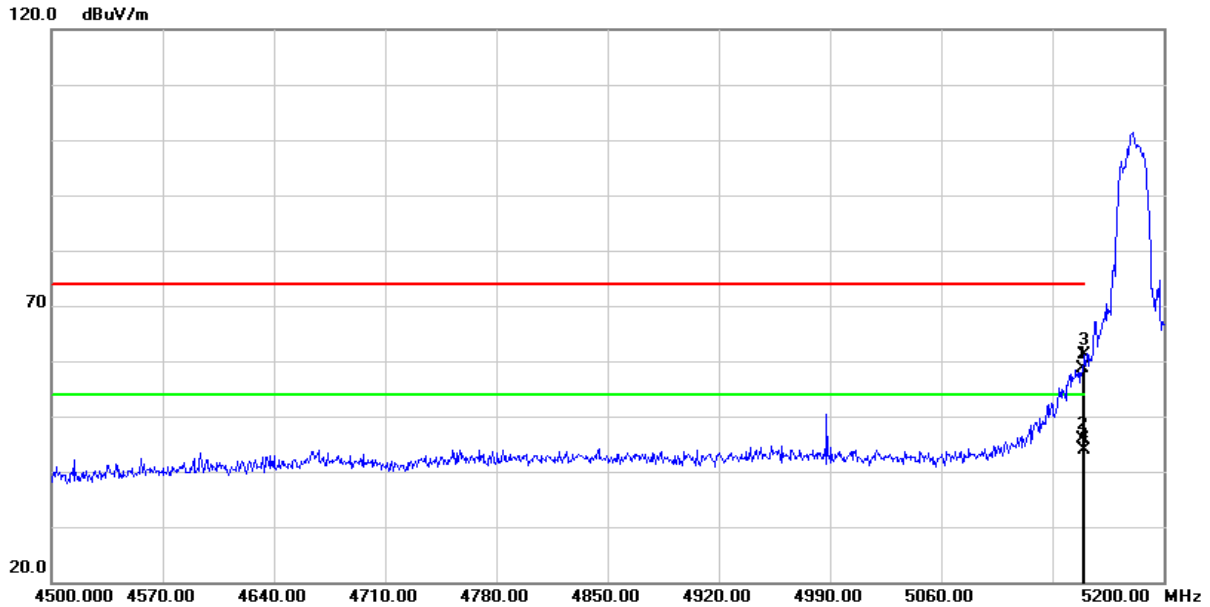

No.	Frequency (MHz)	Reading (dBuV/m)	Correct Factor (dB/m)	Result (dBuV/m)	Limit (dBuV/m)	Margin (dB)	Remark
1	5148.900	55.42	3.14	58.56	74.00	-15.44	peak
2	5148.900	42.68	3.14	45.82	54.00	-8.18	AVG
3	5150.000	57.89	3.14	61.03	74.00	-12.97	peak
4	5150.000	40.73	3.14	43.87	54.00	-10.13	AVG

Remark :

1. Correction Factor = Antenna factor + Cable loss – Amplifier gain
2. Result Value = Reading Level + Correct Factor
3. Margin Level = Result Value – Limit Value
4. The other emission levels were very low against the limit

Test Mode :	Transmit (802.11ac VHT20 MCS0)	Test Date :	2024/03/25
Test Channel :	CH149(5745MHz)	Temperature :	23.5 °C
Polarization :	Horizontal	Relative Humidity :	46 %

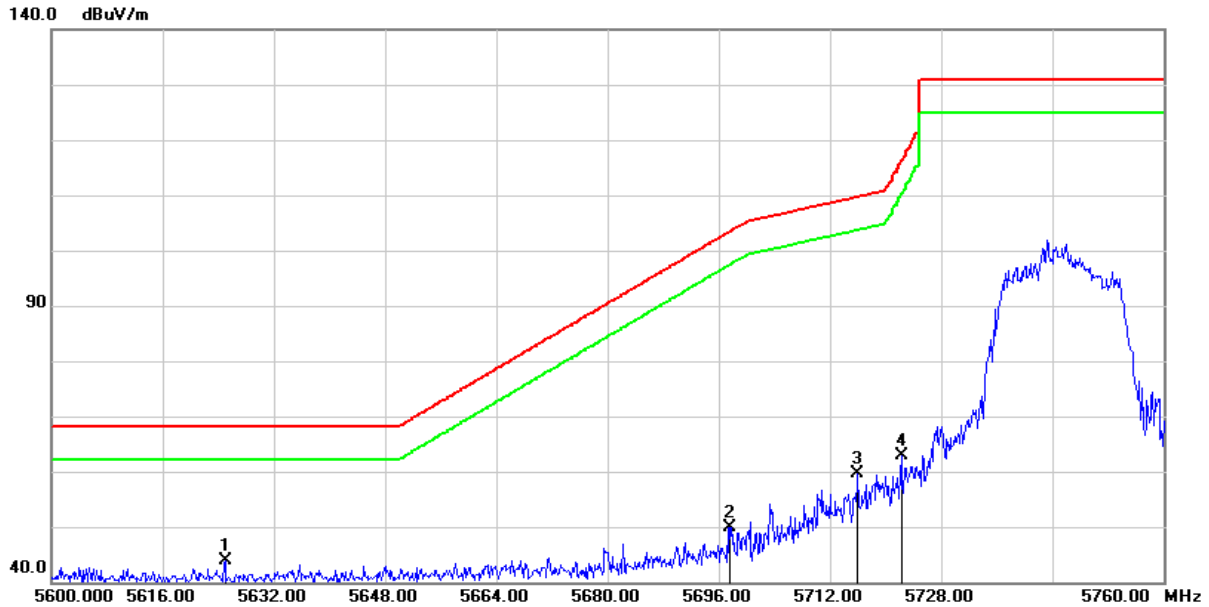

No.	Frequency (MHz)	Reading (dBuV/m)	Correct Factor (dB/m)	Result (dBuV/m)	Limit (dBuV/m)	Margin (dB)	Remark
1	5624.960	40.71	3.11	43.82	68.20	-24.38	peak
2	5697.600	46.51	3.39	49.90	103.42	-53.52	peak
3	5716.000	56.26	3.42	59.68	109.68	-50.00	peak
4	5722.240	59.47	3.43	62.90	115.91	-53.01	peak

Remark :

1. Correction Factor = Antenna factor + Cable loss – Amplifier gain
2. Result Value = Reading Level + Correct Factor
3. Margin Level = Result Value – Limit Value
4. The other emission levels were very low against the limit

Test Mode :	Transmit (802.11ac VHT20 MCS0)	Test Date :	2024/03/25
Test Channel :	CH149(5745MHz)	Temperature :	23.5 °C
Polarization :	Vertical	Relative Humidity :	46 %

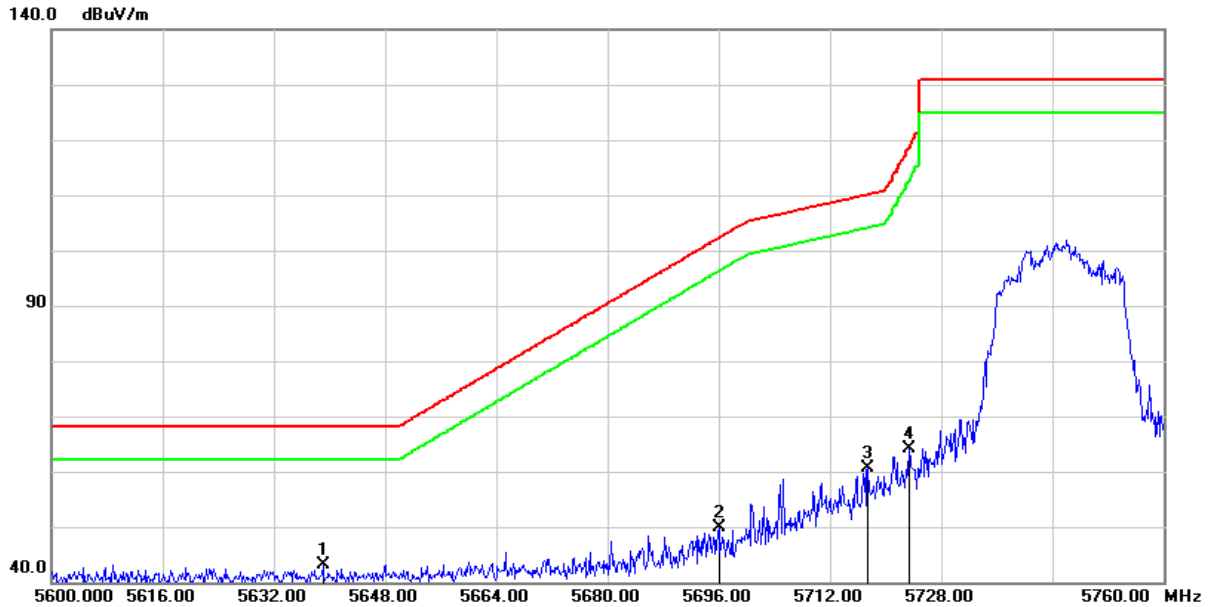

No.	Frequency (MHz)	Reading (dBuV/m)	Correct Factor (dB/m)	Result (dBuV/m)	Limit (dBuV/m)	Margin (dB)	Remark
1	5639.040	40.07	3.13	43.20	68.20	-25.00	peak
2	5696.000	46.43	3.38	49.81	102.24	-52.43	peak
3	5717.440	57.14	3.42	60.56	110.08	-49.52	peak
4	5723.360	60.82	3.43	64.25	118.46	-54.21	peak

Remark :

1. Correction Factor = Antenna factor + Cable loss – Amplifier gain
2. Result Value = Reading Level + Correct Factor
3. Margin Level = Result Value – Limit Value
4. The other emission levels were very low against the limit

Test Mode :	Transmit (802.11ac VHT20 MCS0)	Test Date :	2024/03/25
Test Channel :	CH165(5825MHz)	Temperature :	23.5 °C
Polarization :	Horizontal	Relative Humidity :	46 %

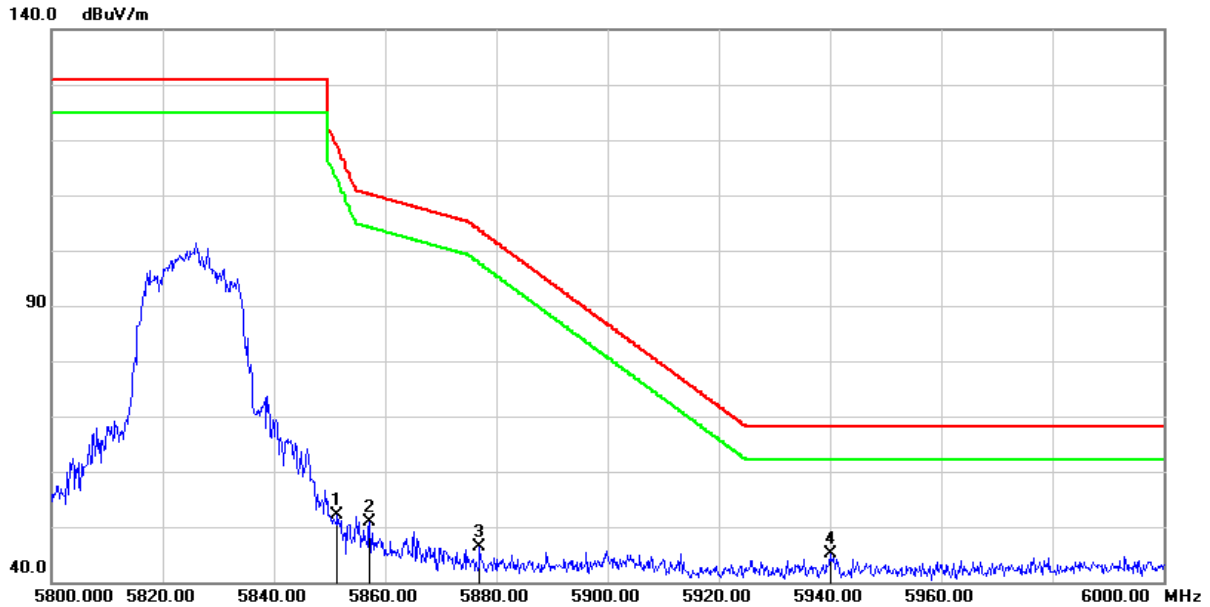

No.	Frequency (MHz)	Reading (dBuV/m)	Correct Factor (dB/m)	Result (dBuV/m)	Limit (dBuV/m)	Margin (dB)	Remark
1	5851.400	48.42	3.70	52.12	119.01	-66.89	peak
2	5857.200	47.26	3.74	51.00	110.18	-59.18	peak
3	5877.000	42.51	3.88	46.39	103.72	-57.33	peak
4	5940.000	41.06	4.10	45.16	68.20	-23.04	peak

Remark :

1. Correction Factor = Antenna factor + Cable loss – Amplifier gain
2. Result Value = Reading Level + Correct Factor
3. Margin Level = Result Value – Limit Value
4. The other emission levels were very low against the limit

Test Mode :	Transmit (802.11ac VHT20 MCS0)	Test Date :	2024/03/25
Test Channel :	CH165(5825MHz)	Temperature :	23.5 °C
Polarization :	Vertical	Relative Humidity :	46 %

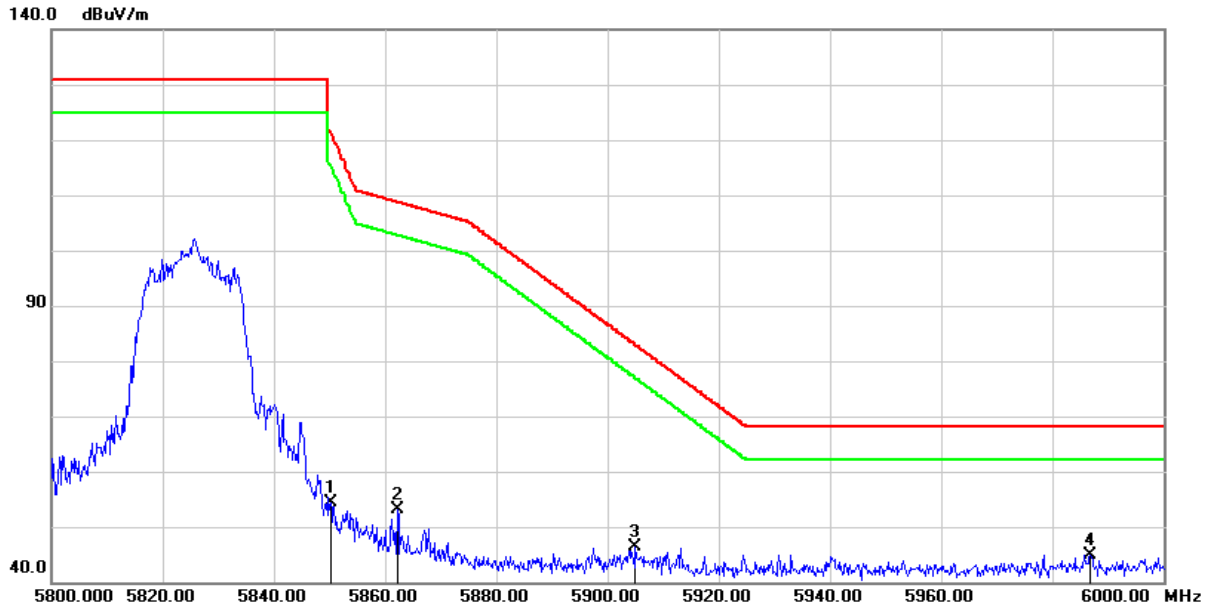

No.	Frequency (MHz)	Reading (dBuV/m)	Correct Factor (dB/m)	Result (dBuV/m)	Limit (dBuV/m)	Margin (dB)	Remark
1	5850.200	50.61	3.69	54.30	121.74	-67.44	peak
2	5862.200	49.43	3.77	53.20	108.78	-55.58	peak
3	5905.000	42.27	4.06	46.33	83.00	-36.67	peak
4	5986.800	40.71	4.23	44.94	68.20	-23.26	peak

Remark :

1. Correction Factor = Antenna factor + Cable loss – Amplifier gain
2. Result Value = Reading Level + Correct Factor
3. Margin Level = Result Value – Limit Value
4. The other emission levels were very low against the limit

Test Mode :	Transmit (802.11ac VHT40 MCS0)	Test Date :	2024/03/25
Test Channel :	CH38(5190MHz)	Temperature :	23.5 °C
Polarization :	Horizontal	Relative Humidity :	46 %

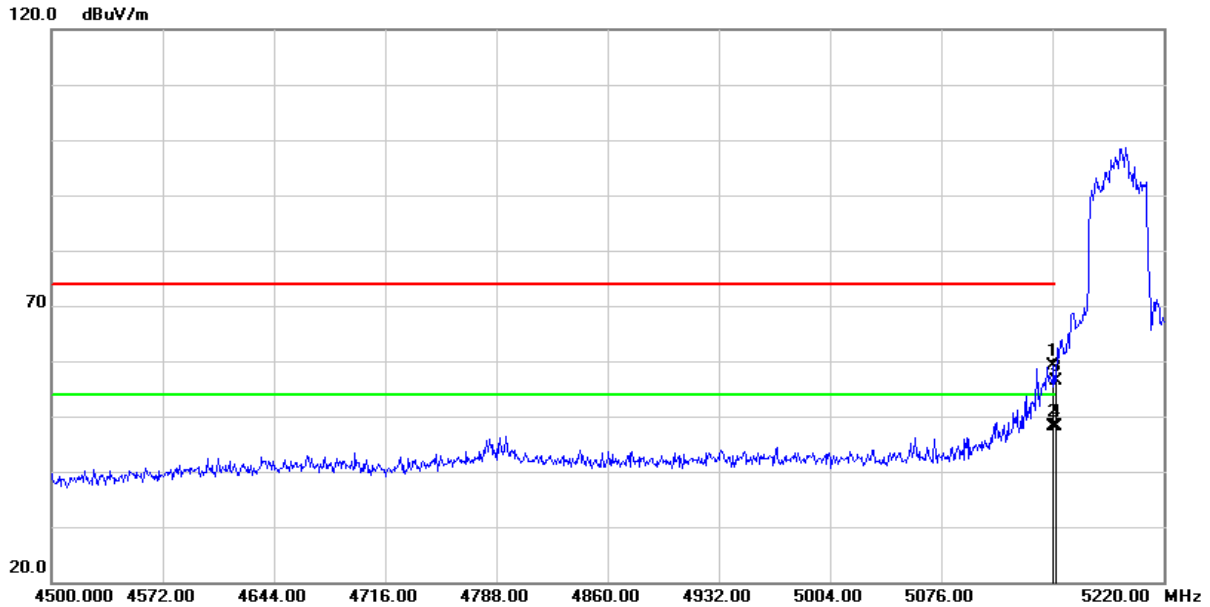

No.	Frequency (MHz)	Reading (dBuV/m)	Correct Factor (dB/m)	Result (dBuV/m)	Limit (dBuV/m)	Margin (dB)	Remark
1	5148.720	55.87	3.15	59.02	74.00	-14.98	peak
2	5148.720	45.04	3.15	48.19	54.00	-5.81	AVG
3	5150.000	53.32	3.14	56.46	74.00	-17.54	peak
4	5150.000	44.94	3.14	48.08	54.00	-5.92	AVG

Remark :

1. Correction Factor = Antenna factor + Cable loss – Amplifier gain
2. Result Value = Reading Level + Correct Factor
3. Margin Level = Result Value – Limit Value
4. The other emission levels were very low against the limit

Test Mode :	Transmit (802.11ac VHT40 MCS0)	Test Date :	2024/03/25
Test Channel :	CH38(5190MHz)	Temperature :	23.5 °C
Polarization :	Vertical	Relative Humidity :	46 %

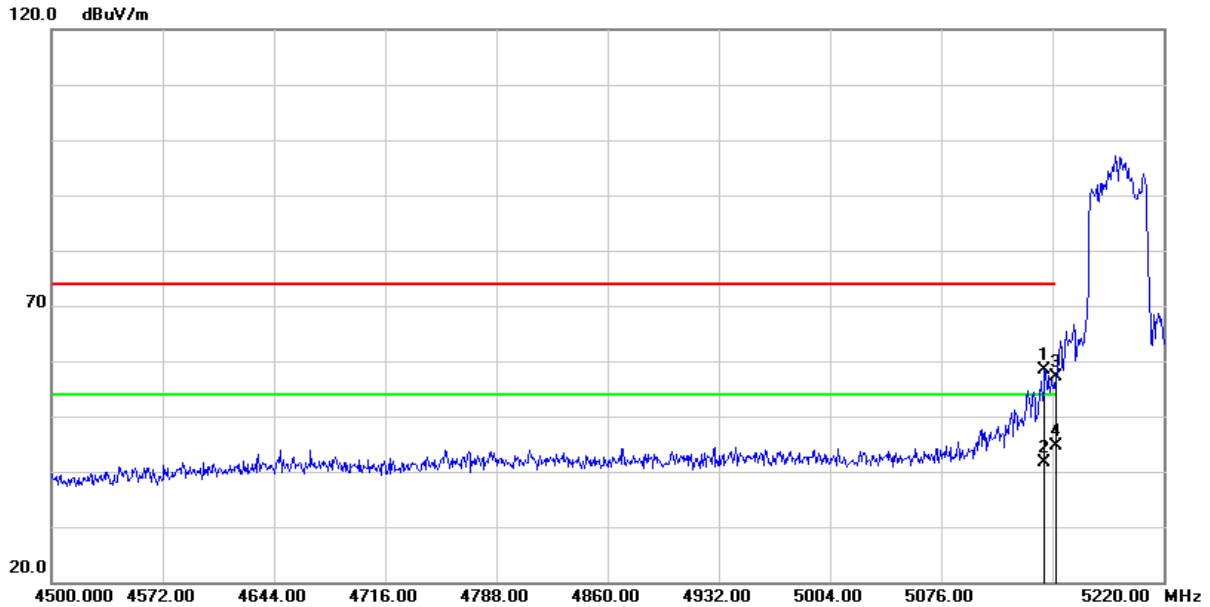

No.	Frequency (MHz)	Reading (dBuV/m)	Correct Factor (dB/m)	Result (dBuV/m)	Limit (dBuV/m)	Margin (dB)	Remark
1	5142.960	55.27	3.14	58.41	74.00	-15.59	peak
2	5142.960	38.49	3.14	41.63	54.00	-12.37	AVG
3	5150.000	54.05	3.14	57.19	74.00	-16.81	peak
4	5150.000	41.53	3.14	44.67	54.00	-9.33	AVG

Remark :

1. Correction Factor = Antenna factor + Cable loss – Amplifier gain
2. Result Value = Reading Level + Correct Factor
3. Margin Level = Result Value – Limit Value
4. The other emission levels were very low against the limit

Test Mode :	Transmit (802.11ac VHT40 MCS0)	Test Date :	2024/03/26
Test Channel :	CH151(5755MHz)	Temperature :	23.5 °C
Polarization :	Horizontal	Relative Humidity :	46 %

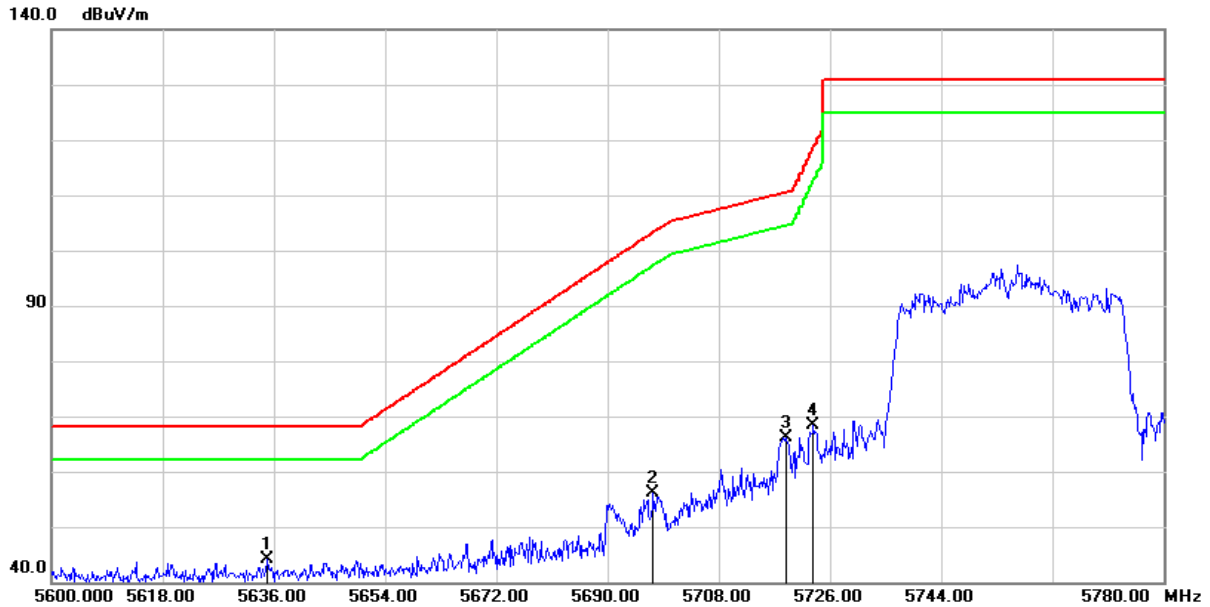

No.	Frequency (MHz)	Reading (dBuV/m)	Correct Factor (dB/m)	Result (dBuV/m)	Limit (dBuV/m)	Margin (dB)	Remark
1	5634.920	40.98	3.13	44.11	68.20	-24.09	peak
2	5697.380	52.83	3.39	56.22	103.26	-47.04	peak
3	5718.800	62.72	3.43	66.15	110.46	-44.31	peak
4	5723.300	64.86	3.43	68.29	118.32	-50.03	peak

Remark :

1. Correction Factor = Antenna factor + Cable loss – Amplifier gain
2. Result Value = Reading Level + Correct Factor
3. Margin Level = Result Value – Limit Value
4. The other emission levels were very low against the limit

Test Mode :	Transmit (802.11ac VHT40 MCS0)	Test Date :	2024/03/26
Test Channel :	CH151(5755MHz)	Temperature :	23.5 °C
Polarization :	Vertical	Relative Humidity :	46 %

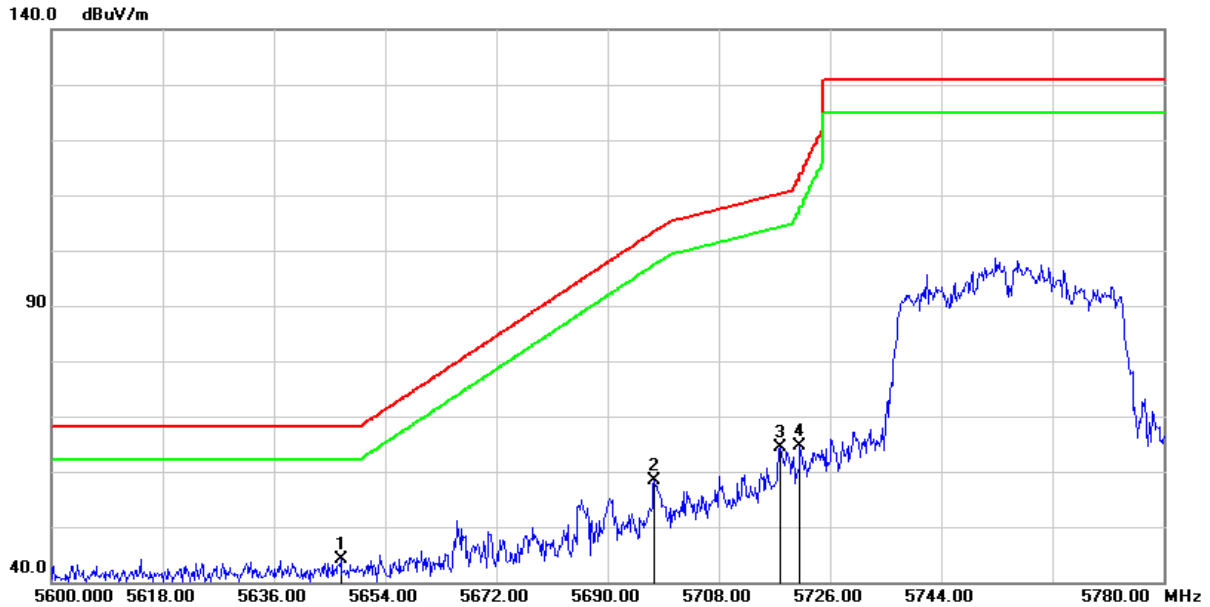

No.	Frequency (MHz)	Reading (dBuV/m)	Correct Factor (dB/m)	Result (dBuV/m)	Limit (dBuV/m)	Margin (dB)	Remark
1	5646.800	41.10	3.14	44.24	68.20	-23.96	peak
2	5697.560	54.94	3.39	58.33	103.39	-45.06	peak
3	5717.900	60.93	3.43	64.36	110.21	-45.85	peak
4	5721.140	61.21	3.43	64.64	113.40	-48.76	peak

Remark :

1. Correction Factor = Antenna factor + Cable loss – Amplifier gain
2. Result Value = Reading Level + Correct Factor
3. Margin Level = Result Value – Limit Value
4. The other emission levels were very low against the limit

Test Mode :	Transmit (802.11ac VHT40 MCS0)	Test Date :	2024/03/26
Test Channel :	CH159(5795MHz)	Temperature :	23.5 °C
Polarization :	Horizontal	Relative Humidity :	46 %

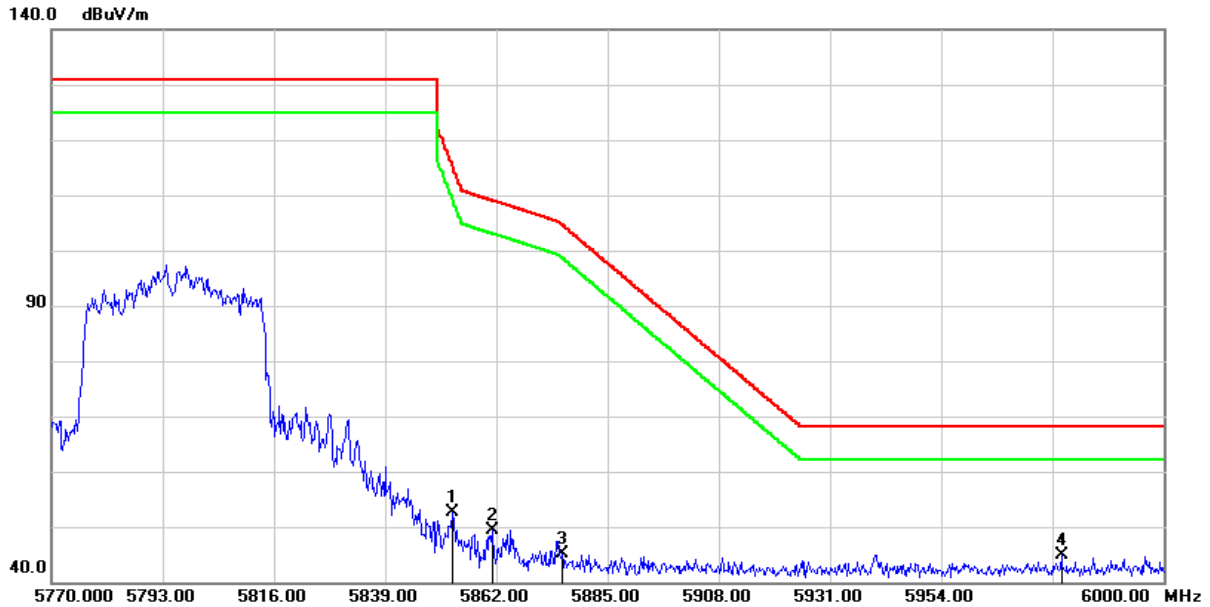

No.	Frequency (MHz)	Reading (dBuV/m)	Correct Factor (dB/m)	Result (dBuV/m)	Limit (dBuV/m)	Margin (dB)	Remark
1	5852.800	48.82	3.71	52.53	115.82	-63.29	peak
2	5861.080	45.63	3.77	49.40	109.10	-59.70	peak
3	5875.570	41.21	3.87	45.08	104.78	-59.70	peak
4	5978.840	40.76	4.21	44.97	68.20	-23.23	peak

Remark :

1. Correction Factor = Antenna factor + Cable loss – Amplifier gain
2. Result Value = Reading Level + Correct Factor
3. Margin Level = Result Value – Limit Value
4. The other emission levels were very low against the limit

Test Mode :	Transmit (802.11ac VHT40 MCS0)	Test Date :	2024/03/26
Test Channel :	CH159(5795MHz)	Temperature :	23.5 °C
Polarization :	Vertical	Relative Humidity :	46 %



No.	Frequency (MHz)	Reading (dBuV/m)	Correct Factor (dB/m)	Result (dBuV/m)	Limit (dBuV/m)	Margin (dB)	Remark
1	5853.260	51.61	3.71	55.32	114.77	-59.45	peak
2	5856.020	46.84	3.73	50.57	110.51	-59.94	peak
3	5906.850	41.61	4.06	45.67	81.63	-35.96	peak
4	5985.970	41.06	4.22	45.28	68.20	-22.92	peak

Remark :

1. Correction Factor = Antenna factor + Cable loss – Amplifier gain
2. Result Value = Reading Level + Correct Factor
3. Margin Level = Result Value – Limit Value
4. The other emission levels were very low against the limit

Test Mode :	Transmit (802.11ac VHT80 MCS0)	Test Date :	2024/03/26
Test Channel :	CH42(5210MHz)	Temperature :	23.5 °C
Polarization :	Horizontal	Relative Humidity :	46 %

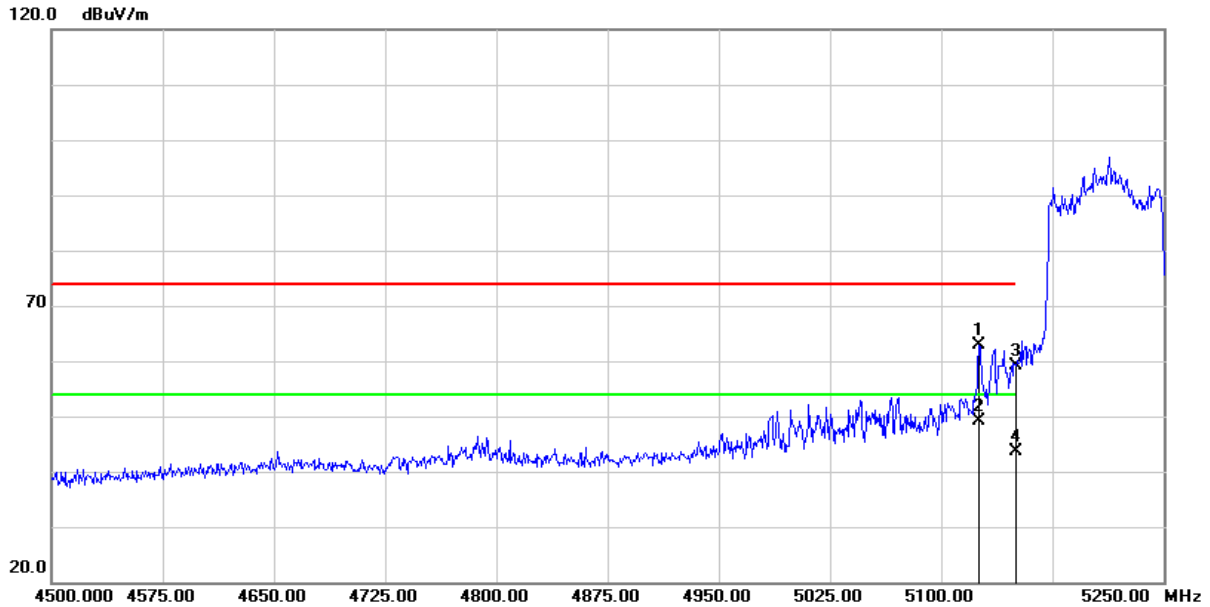

No.	Frequency (MHz)	Reading (dBuV/m)	Correct Factor (dB/m)	Result (dBuV/m)	Limit (dBuV/m)	Margin (dB)	Remark
1	5125.500	59.86	3.09	62.95	74.00	-11.05	peak
2	5125.500	46.07	3.09	49.16	54.00	-4.84	AVG
3	5150.000	55.87	3.14	59.01	74.00	-14.99	peak
4	5150.000	40.57	3.14	43.71	54.00	-10.29	AVG

Remark :

1. Correction Factor = Antenna factor + Cable loss – Amplifier gain
2. Result Value = Reading Level + Correct Factor
3. Margin Level = Result Value – Limit Value
4. The other emission levels were very low against the limit

Test Mode :	Transmit (802.11ac VHT80 MCS0)	Test Date :	2024/03/26
Test Channel :	CH42(5210MHz)	Temperature :	23.5 °C
Polarization :	Vertical	Relative Humidity :	46 %

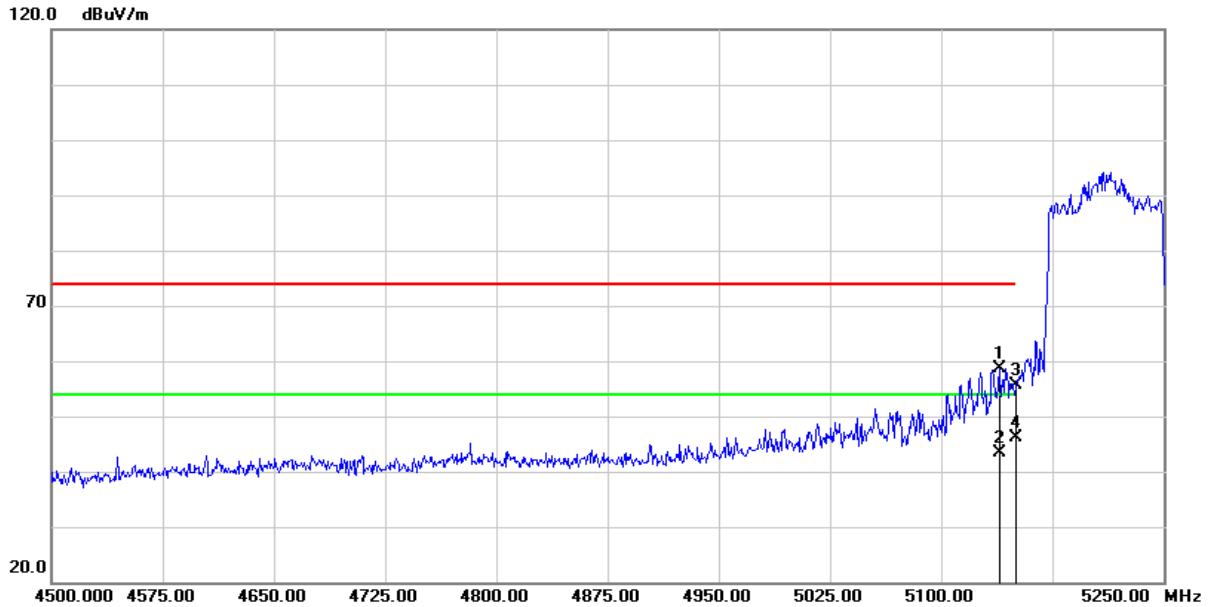

No.	Frequency (MHz)	Reading (dBuV/m)	Correct Factor (dB/m)	Result (dBuV/m)	Limit (dBuV/m)	Margin (dB)	Remark
1	5139.000	55.49	3.12	58.61	74.00	-15.39	peak
2	5139.000	40.27	3.12	43.39	54.00	-10.61	AVG
3	5150.000	52.61	3.14	55.75	74.00	-18.25	peak
4	5150.000	42.87	3.14	46.01	54.00	-7.99	AVG

Remark :

1. Correction Factor = Antenna factor + Cable loss – Amplifier gain
2. Result Value = Reading Level + Correct Factor
3. Margin Level = Result Value – Limit Value
4. The other emission levels were very low against the limit

Test Mode :	Transmit (802.11ac VHT80 MCS0)	Test Date :	2024/03/26
Test Channel :	CH155(5775MHz)	Temperature :	23.5 °C
Polarization :	Horizontal	Relative Humidity :	46 %

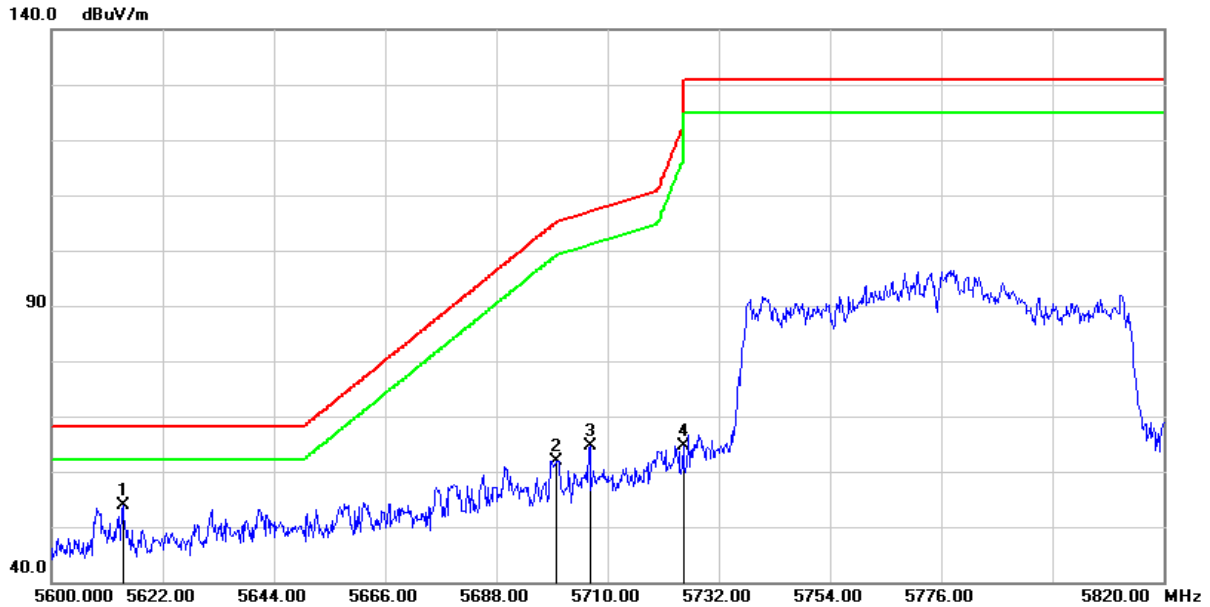

No.	Frequency (MHz)	Reading (dBuV/m)	Correct Factor (dB/m)	Result (dBuV/m)	Limit (dBuV/m)	Margin (dB)	Remark
1	5614.080	50.70	3.10	53.80	68.20	-14.40	peak
2	5699.880	58.46	3.41	61.87	105.11	-43.24	peak
3	5706.480	61.21	3.41	64.62	107.01	-42.39	peak
4	5724.960	61.21	3.43	64.64	122.11	-57.47	peak

Remark :

1. Correction Factor = Antenna factor + Cable loss – Amplifier gain
2. Result Value = Reading Level + Correct Factor
3. Margin Level = Result Value – Limit Value
4. The other emission levels were very low against the limit

Test Mode :	Transmit (802.11ac VHT80 MCS0)	Test Date :	2024/03/26
Test Channel :	CH155(5775MHz)	Temperature :	23.5 °C
Polarization :	Vertical	Relative Humidity :	46 %

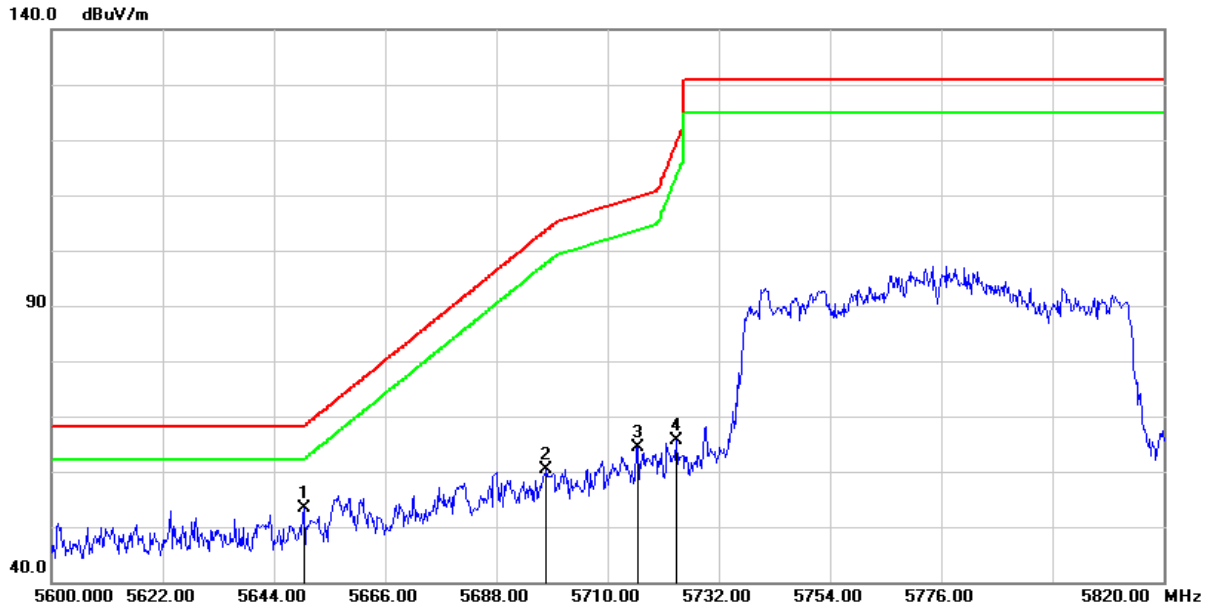

No.	Frequency (MHz)	Reading (dBuV/m)	Correct Factor (dB/m)	Result (dBuV/m)	Limit (dBuV/m)	Margin (dB)	Remark
1	5649.940	50.23	3.14	53.37	68.20	-14.83	peak
2	5697.900	56.87	3.39	60.26	103.65	-43.39	peak
3	5715.940	61.04	3.42	64.46	109.66	-45.20	peak
4	5723.640	62.27	3.43	65.70	119.10	-53.40	peak

Remark :

1. Correction Factor = Antenna factor + Cable loss – Amplifier gain
2. Result Value = Reading Level + Correct Factor
3. Margin Level = Result Value – Limit Value
4. The other emission levels were very low against the limit

Test Mode :	Transmit (802.11ac VHT80 MCS0)	Test Date :	2024/03/26
Test Channel :	CH155(5775MHz)	Temperature :	23.5 °C
Polarization :	Horizontal	Relative Humidity :	46 %

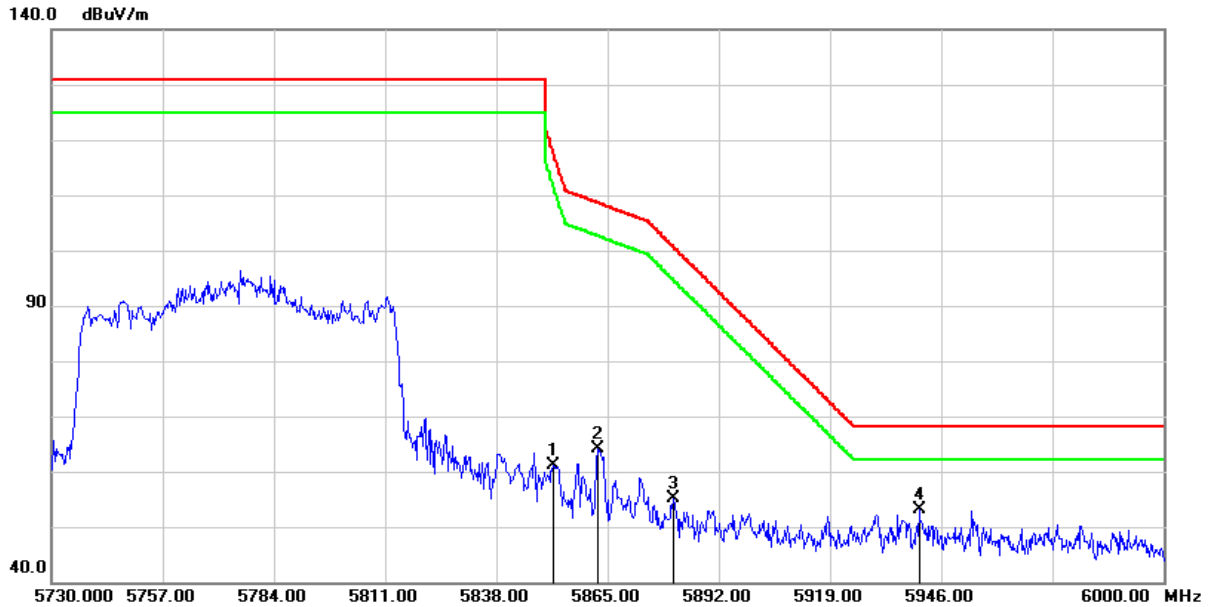

No.	Frequency (MHz)	Reading (dBuV/m)	Correct Factor (dB/m)	Result (dBuV/m)	Limit (dBuV/m)	Margin (dB)	Remark
1	5851.770	57.43	3.70	61.13	118.16	-57.03	peak
2	5862.570	60.25	3.78	64.03	108.68	-44.65	peak
3	5880.930	51.32	3.91	55.23	100.81	-45.58	peak
4	5940.600	49.01	4.10	53.11	68.20	-15.09	peak

Remark :

1. Correction Factor = Antenna factor + Cable loss – Amplifier gain
2. Result Value = Reading Level + Correct Factor
3. Margin Level = Result Value – Limit Value
4. The other emission levels were very low against the limit

Test Mode :	Transmit (802.11ac VHT80 MCS0)	Test Date :	2024/03/26
Test Channel :	CH155(5775MHz)	Temperature :	23.5 °C
Polarization :	Vertical	Relative Humidity :	46 %

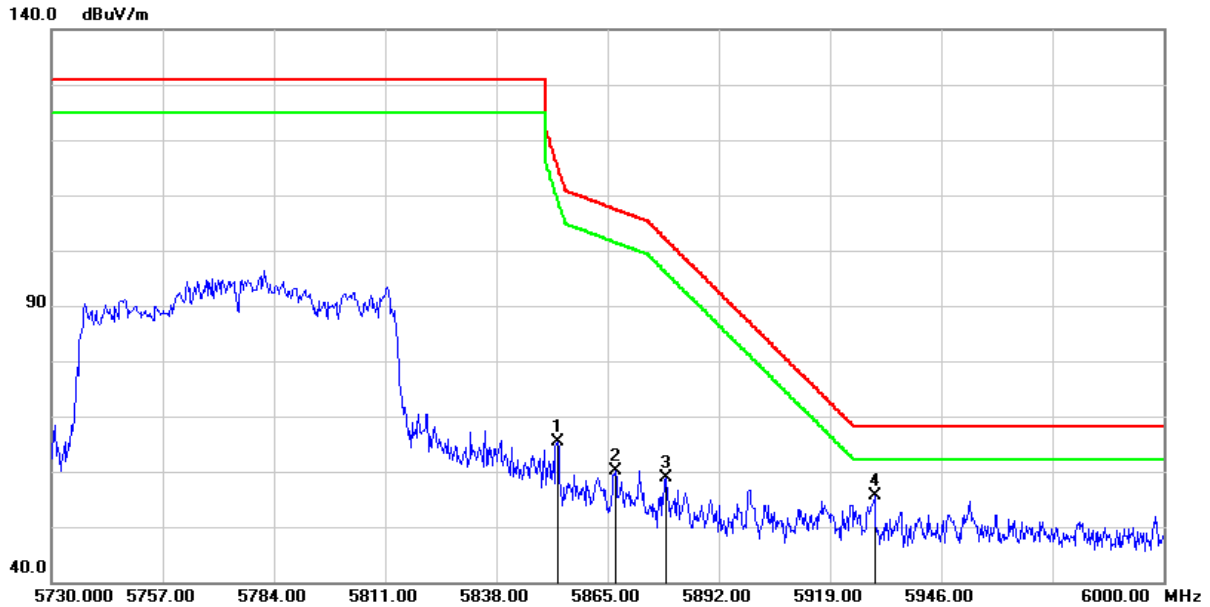

No.	Frequency (MHz)	Reading (dBuV/m)	Correct Factor (dB/m)	Result (dBuV/m)	Limit (dBuV/m)	Margin (dB)	Remark
1	5852.850	61.70	3.71	65.41	115.70	-50.29	peak
2	5866.890	56.28	3.81	60.09	107.47	-47.38	peak
3	5879.040	54.99	3.89	58.88	102.21	-43.33	peak
4	5929.800	51.55	4.08	55.63	68.20	-12.57	peak

Remark :

1. Correction Factor = Antenna factor + Cable loss – Amplifier gain
2. Result Value = Reading Level + Correct Factor
3. Margin Level = Result Value – Limit Value
4. The other emission levels were very low against the limit

Test Mode :	Transmit (802.11ax HE20 MCS0)	Test Date :	2024/03/26
Test Channel :	CH36(5180MHz)	Temperature :	23.5 °C
Polarization :	Horizontal	Relative Humidity :	46 %

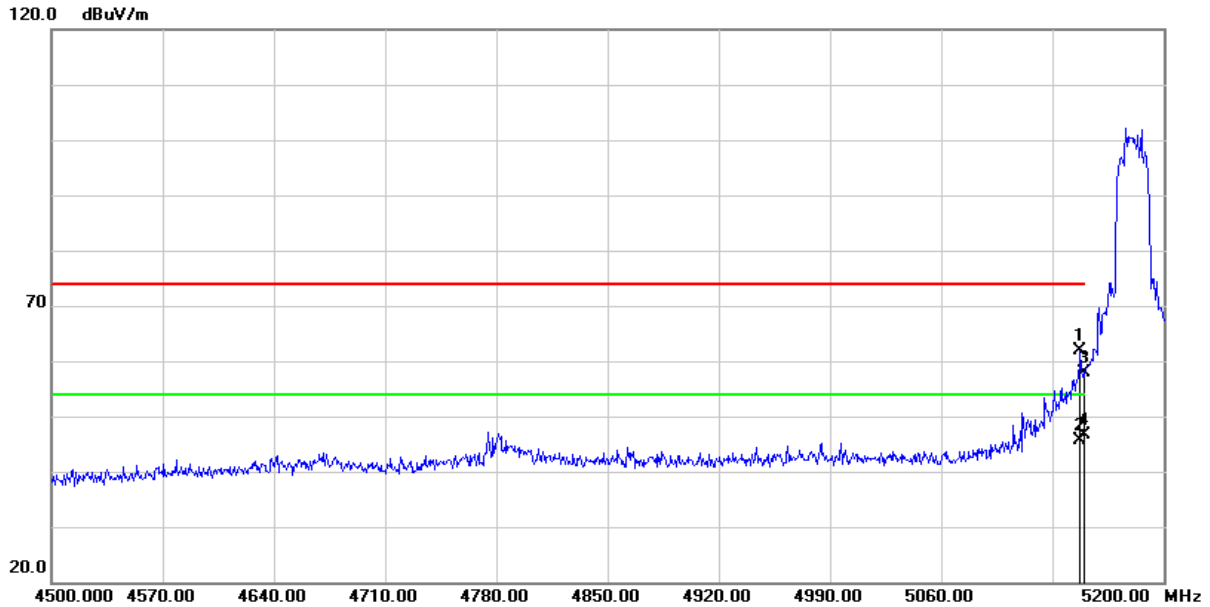

No.	Frequency (MHz)	Reading (dBuV/m)	Correct Factor (dB/m)	Result (dBuV/m)	Limit (dBuV/m)	Margin (dB)	Remark
1	5147.500	58.81	3.14	61.95	74.00	-12.05	peak
2	5147.500	42.43	3.14	45.57	54.00	-8.43	AVG
3	5150.000	54.72	3.14	57.86	74.00	-16.14	peak
4	5150.000	43.61	3.14	46.75	54.00	-7.25	AVG

Remark :

1. Correction Factor = Antenna factor + Cable loss – Amplifier gain
2. Result Value = Reading Level + Correct Factor
3. Margin Level = Result Value – Limit Value
4. The other emission levels were very low against the limit

Test Mode :	Transmit (802.11ax HE20 MCS0)	Test Date :	2024/03/26
Test Channel :	CH36(5180MHz)	Temperature :	23.5 °C
Polarization :	Vertical	Relative Humidity :	46 %

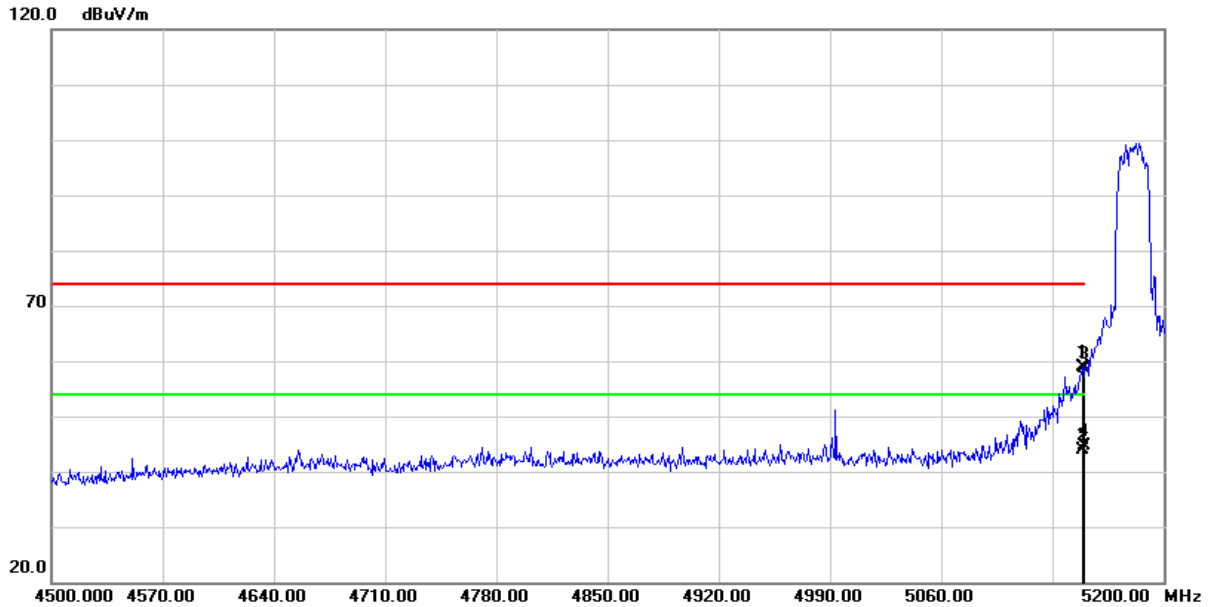

No.	Frequency (MHz)	Reading (dBuV/m)	Correct Factor (dB/m)	Result (dBuV/m)	Limit (dBuV/m)	Margin (dB)	Remark
1	5148.900	55.82	3.14	58.96	74.00	-15.04	peak
2	5148.900	40.75	3.14	43.89	54.00	-10.11	AVG
3	5150.000	55.53	3.14	58.67	74.00	-15.33	peak
4	5150.000	41.46	3.14	44.60	54.00	-9.40	AVG

Remark :

1. Correction Factor = Antenna factor + Cable loss – Amplifier gain
2. Result Value = Reading Level + Correct Factor
3. Margin Level = Result Value – Limit Value
4. The other emission levels were very low against the limit

Test Mode :	Transmit (802.11ax HE20 MCS0)	Test Date :	2024/03/26
Test Channel :	CH149(5745MHz)	Temperature :	23.5 °C
Polarization :	Horizontal	Relative Humidity :	46 %

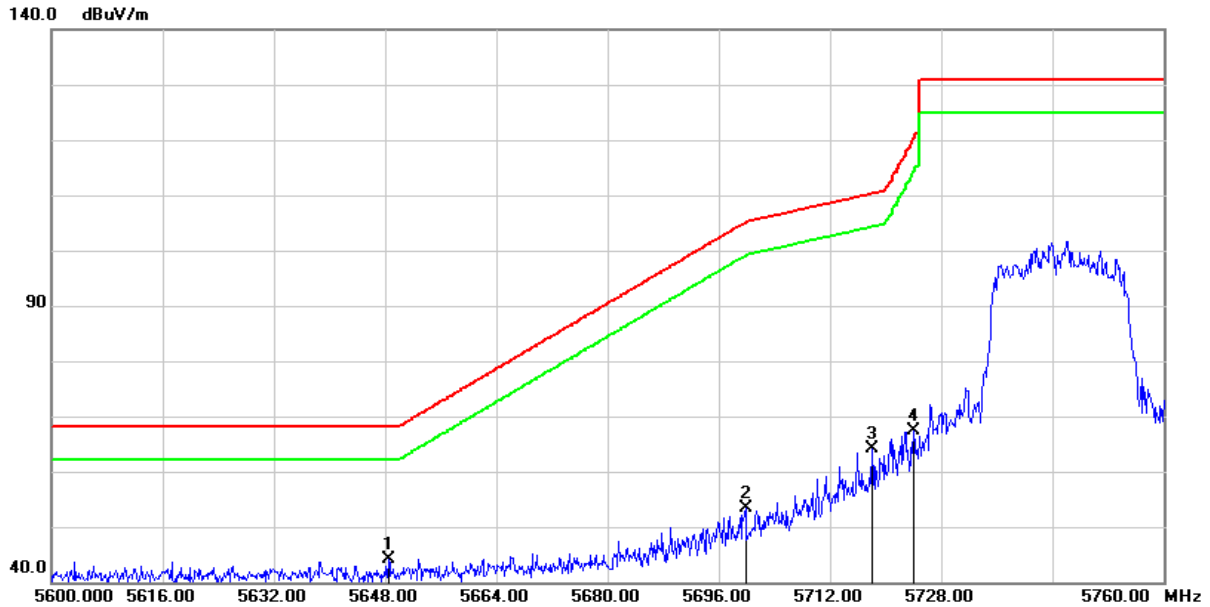

No.	Frequency (MHz)	Reading (dBuV/m)	Correct Factor (dB/m)	Result (dBuV/m)	Limit (dBuV/m)	Margin (dB)	Remark
1	5648.480	41.04	3.14	44.18	68.20	-24.02	peak
2	5699.840	49.85	3.41	53.26	105.08	-51.82	peak
3	5718.080	60.79	3.43	64.22	110.26	-46.04	peak
4	5724.000	64.00	3.43	67.43	119.92	-52.49	peak

Remark :

1. Correction Factor = Antenna factor + Cable loss – Amplifier gain
2. Result Value = Reading Level + Correct Factor
3. Margin Level = Result Value – Limit Value
4. The other emission levels were very low against the limit

Test Mode :	Transmit (802.11ax HE20 MCS0)	Test Date :	2024/03/26
Test Channel :	CH149(5745MHz)	Temperature :	23.5 °C
Polarization :	Vertical	Relative Humidity :	46 %

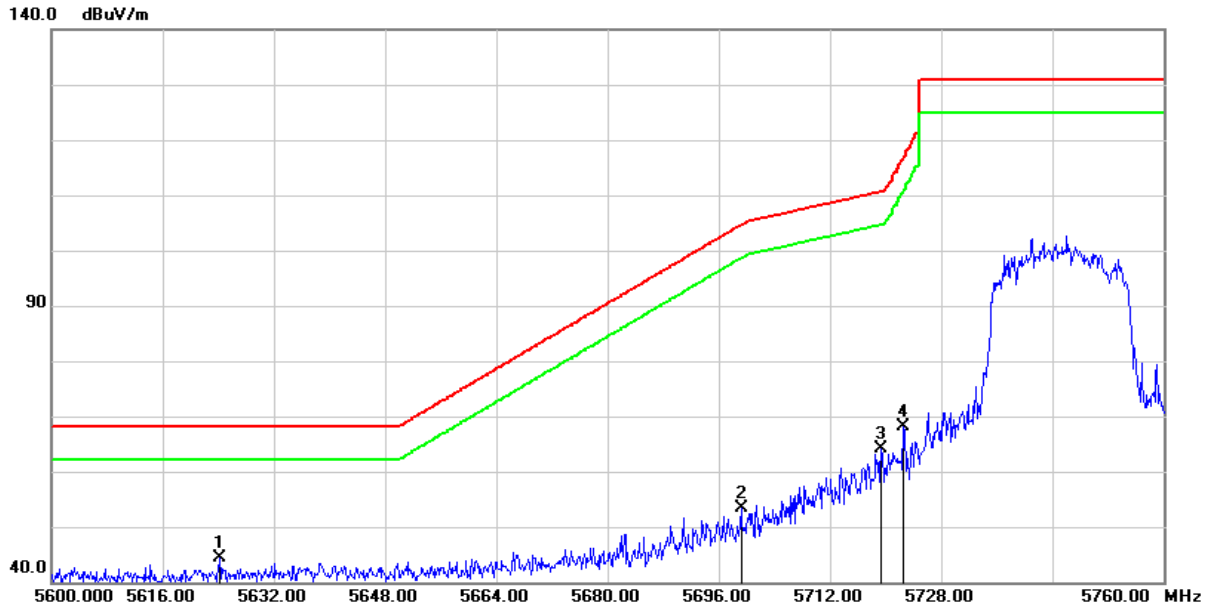

No.	Frequency (MHz)	Reading (dBuV/m)	Correct Factor (dB/m)	Result (dBuV/m)	Limit (dBuV/m)	Margin (dB)	Remark
1	5624.160	41.22	3.11	44.33	68.20	-23.87	peak
2	5699.200	49.98	3.41	53.39	104.61	-51.22	peak
3	5719.360	60.74	3.43	64.17	110.62	-46.45	peak
4	5722.560	64.70	3.43	68.13	116.64	-48.51	peak

Remark :

1. Correction Factor = Antenna factor + Cable loss – Amplifier gain
2. Result Value = Reading Level + Correct Factor
3. Margin Level = Result Value – Limit Value
4. The other emission levels were very low against the limit

Test Mode :	Transmit (802.11ax HE20 MCS0)	Test Date :	2024/03/26
Test Channel :	CH165(5825MHz)	Temperature :	23.5 °C
Polarization :	Horizontal	Relative Humidity :	46 %

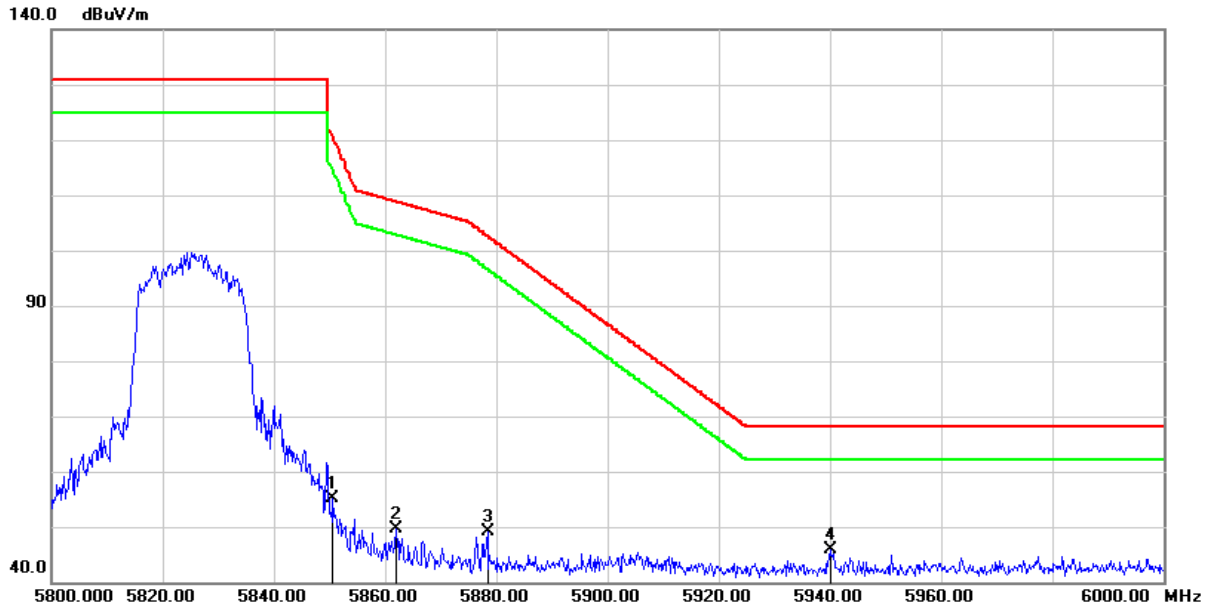

No.	Frequency (MHz)	Reading (dBuV/m)	Correct Factor (dB/m)	Result (dBuV/m)	Limit (dBuV/m)	Margin (dB)	Remark
1	5850.600	51.32	3.69	55.01	120.83	-65.82	peak
2	5862.000	45.91	3.77	49.68	108.84	-59.16	peak
3	5878.400	45.16	3.89	49.05	102.68	-53.63	peak
4	5940.000	41.79	4.10	45.89	68.20	-22.31	peak

Remark :

1. Correction Factor = Antenna factor + Cable loss – Amplifier gain
2. Result Value = Reading Level + Correct Factor
3. Margin Level = Result Value – Limit Value
4. The other emission levels were very low against the limit

Test Mode :	Transmit (802.11ax HE20 MCS0)	Test Date :	2024/03/26
Test Channel :	CH165(5825MHz)	Temperature :	23.5 °C
Polarization :	Vertical	Relative Humidity :	46 %

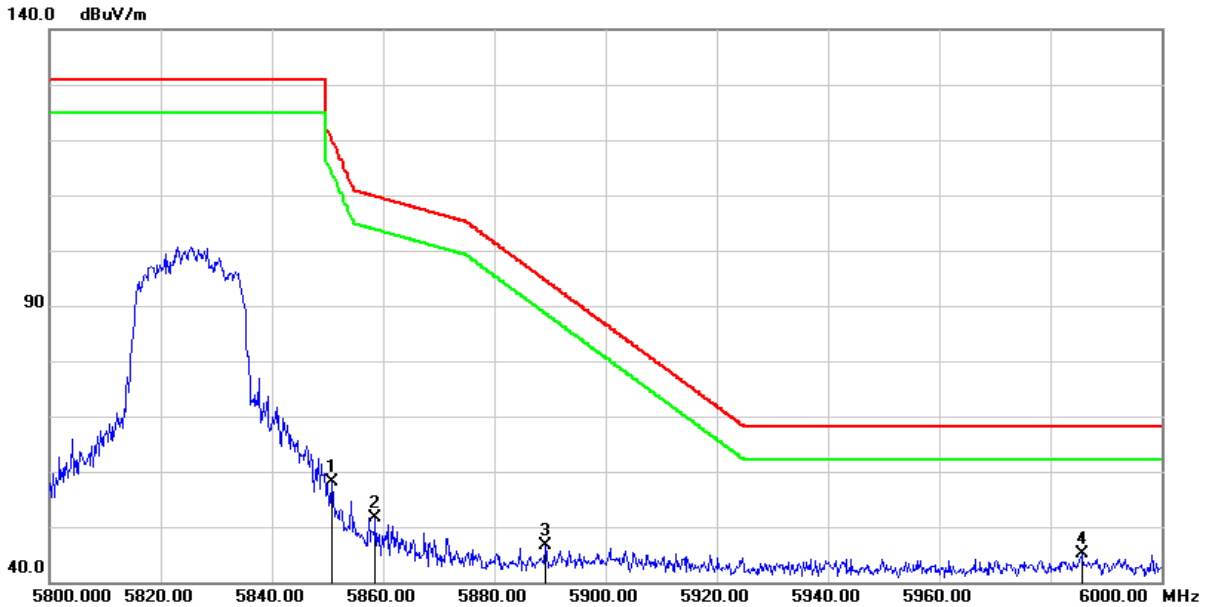

No.	Frequency (MHz)	Reading (dBuV/m)	Correct Factor (dB/m)	Result (dBuV/m)	Limit (dBuV/m)	Margin (dB)	Remark
1	5850.800	54.52	3.69	58.21	120.38	-62.17	peak
2	5858.600	48.00	3.75	51.75	109.79	-58.04	peak
3	5889.200	42.66	3.97	46.63	94.69	-48.06	peak
4	5985.600	41.01	4.22	45.23	68.20	-22.97	peak

Remark :

1. Correction Factor = Antenna factor + Cable loss – Amplifier gain
2. Result Value = Reading Level + Correct Factor
3. Margin Level = Result Value – Limit Value
4. The other emission levels were very low against the limit

Test Mode :	Transmit (802.11ax HE40 MCS0)	Test Date :	2024/03/27
Test Channel :	CH38(5190MHz)	Temperature :	23.4 °C
Polarization :	Horizontal	Relative Humidity :	53 %

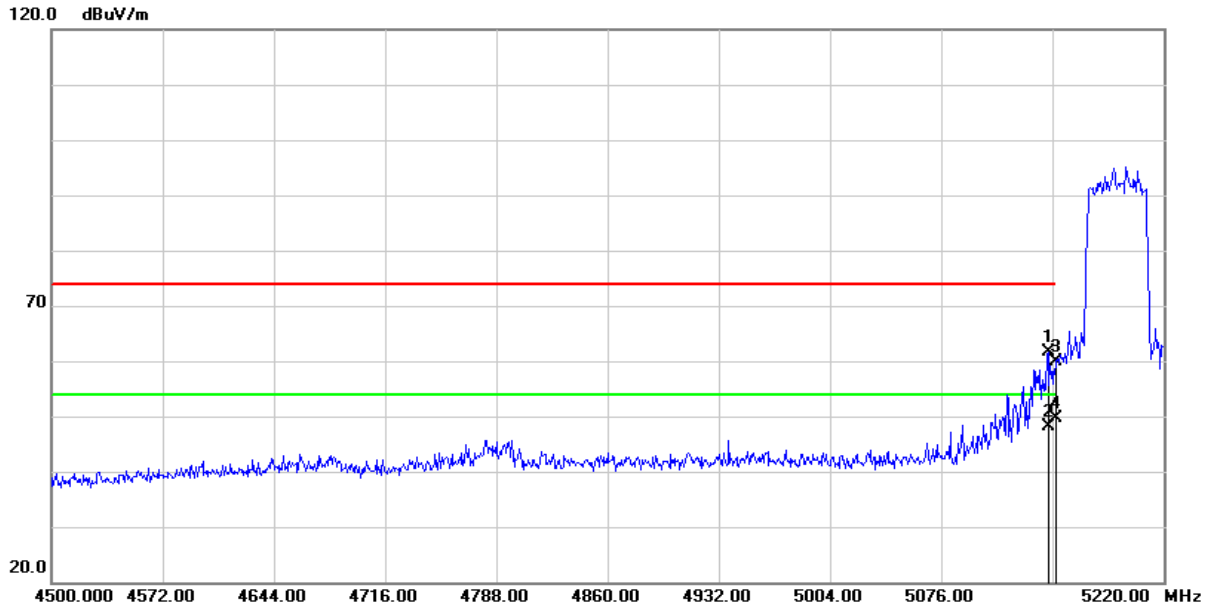

No.	Frequency (MHz)	Reading (dBuV/m)	Correct Factor (dB/m)	Result (dBuV/m)	Limit (dBuV/m)	Margin (dB)	Remark
1	5145.120	58.49	3.14	61.63	74.00	-12.37	peak
2	5145.120	44.91	3.14	48.05	54.00	-5.95	AVG
3	5150.000	56.72	3.14	59.86	74.00	-14.14	peak
4	5150.000	46.40	3.14	49.54	54.00	-4.46	AVG

Remark :

1. Correction Factor = Antenna factor + Cable loss – Amplifier gain
2. Result Value = Reading Level + Correct Factor
3. Margin Level = Result Value – Limit Value
4. The other emission levels were very low against the limit

Test Mode :	Transmit (802.11ax HE40 MCS0)	Test Date :	2024/03/27
Test Channel :	CH38(5190MHz)	Temperature :	23.4 °C
Polarization :	Vertical	Relative Humidity :	53 %

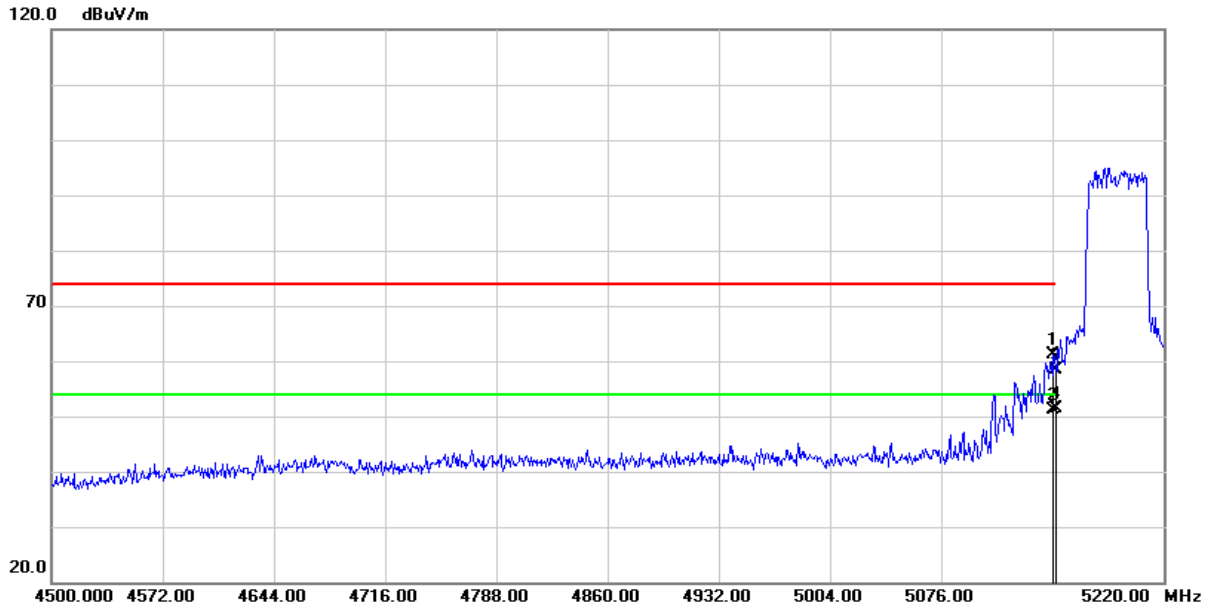

No.	Frequency (MHz)	Reading (dBuV/m)	Correct Factor (dB/m)	Result (dBuV/m)	Limit (dBuV/m)	Margin (dB)	Remark
1	5148.720	57.95	3.15	61.10	74.00	-12.90	peak
2	5148.720	47.91	3.15	51.06	54.00	-2.94	AVG
3	5150.000	55.27	3.14	58.41	74.00	-15.59	peak
4	5150.000	48.12	3.14	51.26	54.00	-2.74	AVG

Remark :

1. Correction Factor = Antenna factor + Cable loss – Amplifier gain
2. Result Value = Reading Level + Correct Factor
3. Margin Level = Result Value – Limit Value
4. The other emission levels were very low against the limit

Test Mode :	Transmit (802.11ax HE40 MCS0)	Test Date :	2024/03/27
Test Channel :	CH151(5755MHz)	Temperature :	23.4 °C
Polarization :	Horizontal	Relative Humidity :	53 %

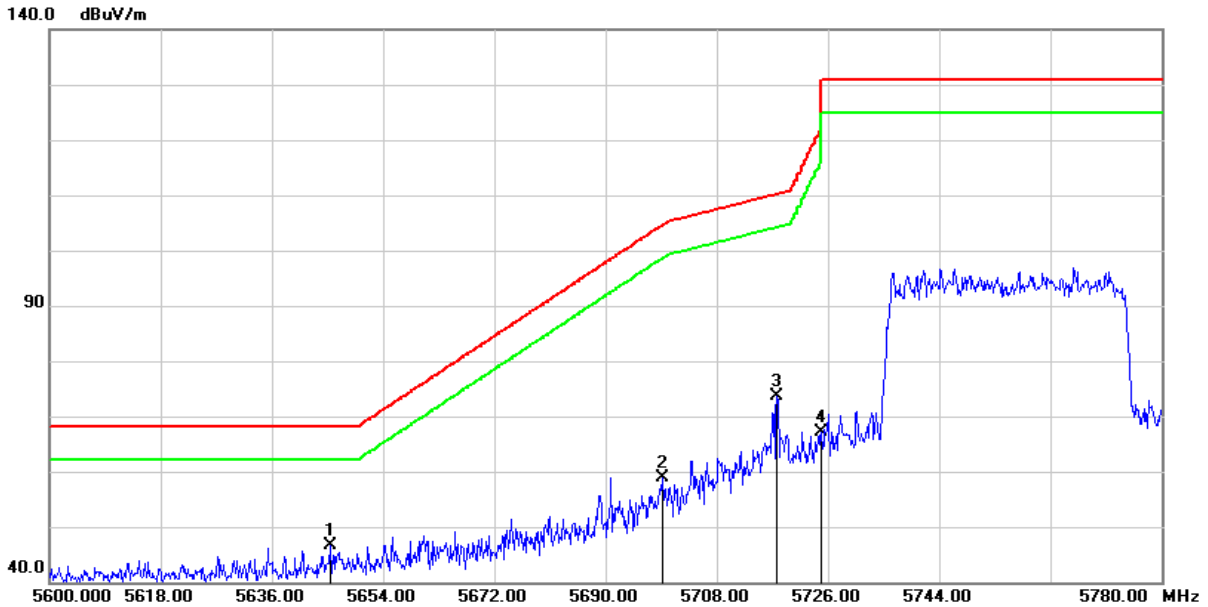

No.	Frequency (MHz)	Reading (dBuV/m)	Correct Factor (dB/m)	Result (dBuV/m)	Limit (dBuV/m)	Margin (dB)	Remark
1	5645.540	43.59	3.14	46.73	68.20	-21.47	peak
2	5699.180	55.47	3.41	58.88	104.59	-45.71	peak
3	5717.720	70.15	3.43	73.58	110.16	-36.58	peak
4	5724.920	63.68	3.43	67.11	122.02	-54.91	peak

Remark :

1. Correction Factor = Antenna factor + Cable loss – Amplifier gain
2. Result Value = Reading Level + Correct Factor
3. Margin Level = Result Value – Limit Value
4. The other emission levels were very low against the limit

Test Mode :	Transmit (802.11ax HE40 MCS0)	Test Date :	2024/03/27
Test Channel :	CH151(5755MHz)	Temperature :	23.4 °C
Polarization :	Vertical	Relative Humidity :	53 %

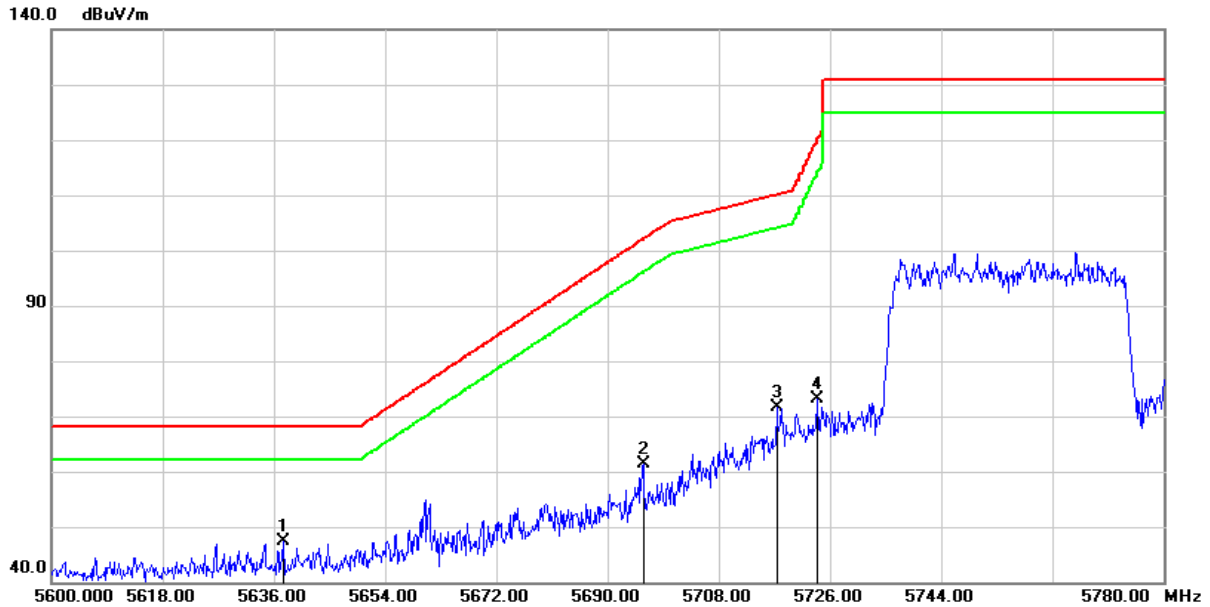

No.	Frequency (MHz)	Reading (dBuV/m)	Correct Factor (dB/m)	Result (dBuV/m)	Limit (dBuV/m)	Margin (dB)	Remark
1	5637.440	44.17	3.13	47.30	68.20	-20.90	peak
2	5695.760	57.88	3.38	61.26	102.06	-40.80	peak
3	5717.360	68.13	3.42	71.55	110.06	-38.51	peak
4	5723.840	69.71	3.43	73.14	119.56	-46.42	peak

Remark :

1. Correction Factor = Antenna factor + Cable loss – Amplifier gain
2. Result Value = Reading Level + Correct Factor
3. Margin Level = Result Value – Limit Value
4. The other emission levels were very low against the limit

Test Mode :	Transmit (802.11ax HE40 MCS0)	Test Date :	2024/03/27
Test Channel :	CH159(5795MHz)	Temperature :	23.4 °C
Polarization :	Horizontal	Relative Humidity :	53 %

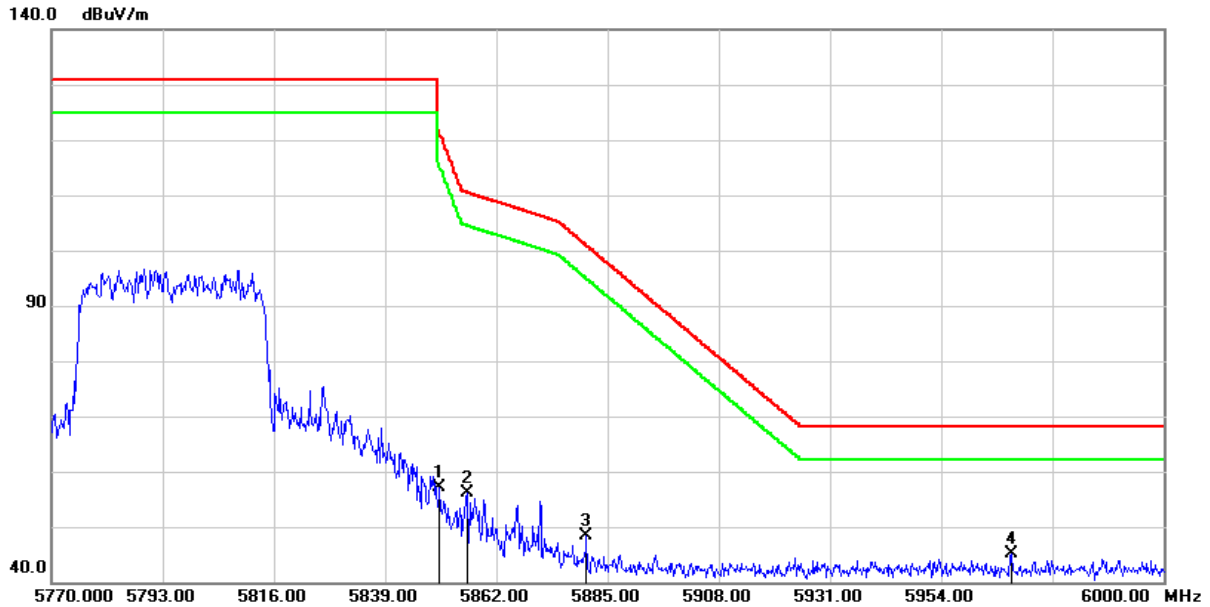

No.	Frequency (MHz)	Reading (dBuV/m)	Correct Factor (dB/m)	Result (dBuV/m)	Limit (dBuV/m)	Margin (dB)	Remark
1	5850.270	53.47	3.69	57.16	121.58	-64.42	peak
2	5856.020	52.33	3.73	56.06	110.51	-54.45	peak
3	5880.630	44.52	3.90	48.42	101.03	-52.61	peak
4	5968.490	41.03	4.18	45.21	68.20	-22.99	peak

Remark :

1. Correction Factor = Antenna factor + Cable loss – Amplifier gain
2. Result Value = Reading Level + Correct Factor
3. Margin Level = Result Value – Limit Value
4. The other emission levels were very low against the limit

Test Mode :	Transmit (802.11ax HE40 MCS0)	Test Date :	2024/03/27
Test Channel :	CH159(5795MHz)	Temperature :	23.4 °C
Polarization :	Vertical	Relative Humidity :	53 %

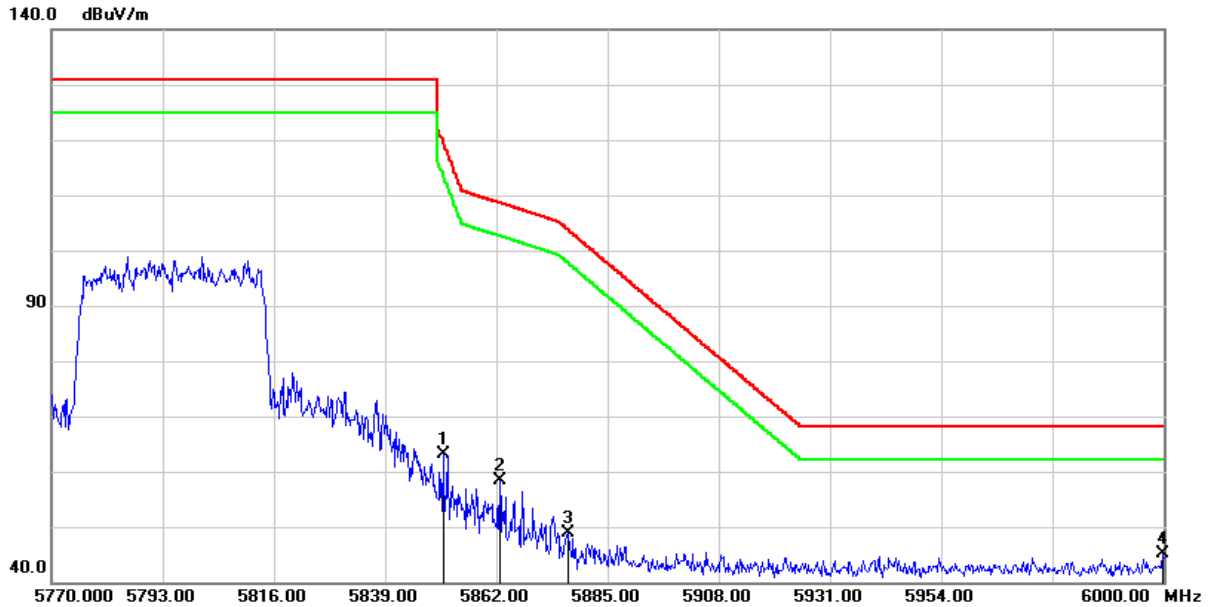

No.	Frequency (MHz)	Reading (dBuV/m)	Correct Factor (dB/m)	Result (dBuV/m)	Limit (dBuV/m)	Margin (dB)	Remark
1	5850.960	59.49	3.70	63.19	120.01	-56.82	peak
2	5862.690	54.53	3.78	58.31	108.65	-50.34	peak
3	5876.720	44.88	3.88	48.76	103.93	-55.17	peak
4	5999.770	40.83	4.27	45.10	68.20	-23.10	peak

Remark :

1. Correction Factor = Antenna factor + Cable loss – Amplifier gain
2. Result Value = Reading Level + Correct Factor
3. Margin Level = Result Value – Limit Value
4. The other emission levels were very low against the limit

Test Mode :	Transmit (802.11ax HE80 MCS0)	Test Date :	2024/03/27
Test Channel :	CH42(5210MHz)	Temperature :	23.4 °C
Polarization :	Horizontal	Relative Humidity :	53 %

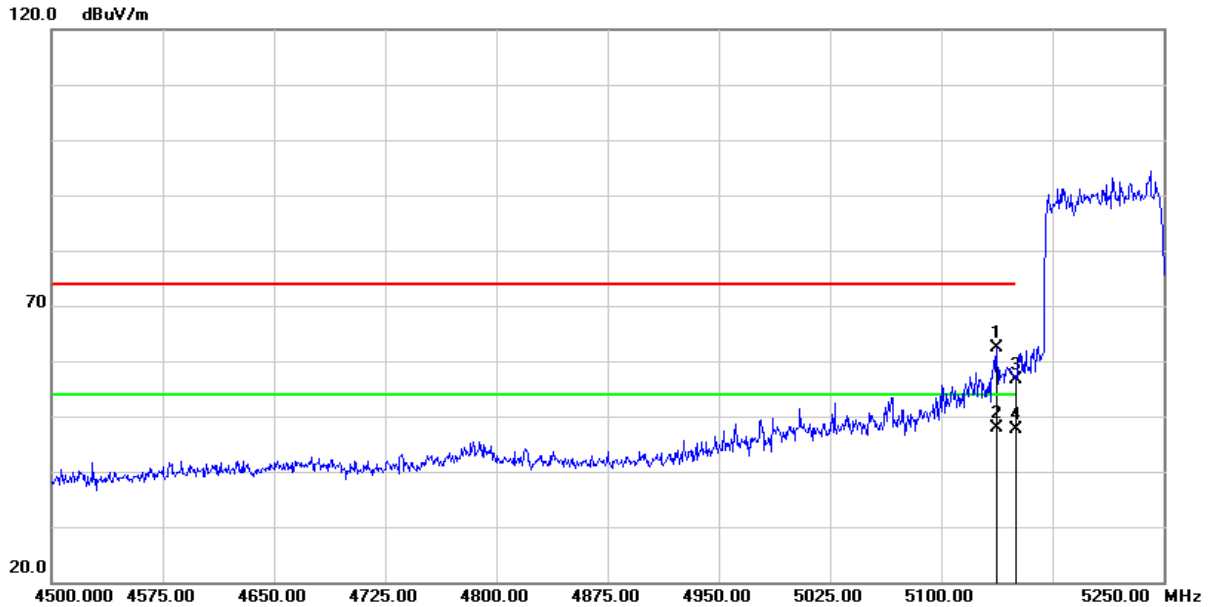

No.	Frequency (MHz)	Reading (dBuV/m)	Correct Factor (dB/m)	Result (dBuV/m)	Limit (dBuV/m)	Margin (dB)	Remark
1	5137.500	59.21	3.11	62.32	74.00	-11.68	peak
2 *	5137.500	44.73	3.11	47.84	54.00	-6.16	AVG
3	5150.000	53.49	3.14	56.63	74.00	-17.37	peak
4	5150.000	44.53	3.14	47.67	54.00	-6.33	AVG

Remark :

1. Correction Factor = Antenna factor + Cable loss – Amplifier gain
2. Result Value = Reading Level + Correct Factor
3. Margin Level = Result Value – Limit Value
4. The other emission levels were very low against the limit

Test Mode :	Transmit (802.11ax HE80 MCS0)	Test Date :	2024/03/27
Test Channel :	CH42(5210MHz)	Temperature :	23.4 °C
Polarization :	Vertical	Relative Humidity :	53 %

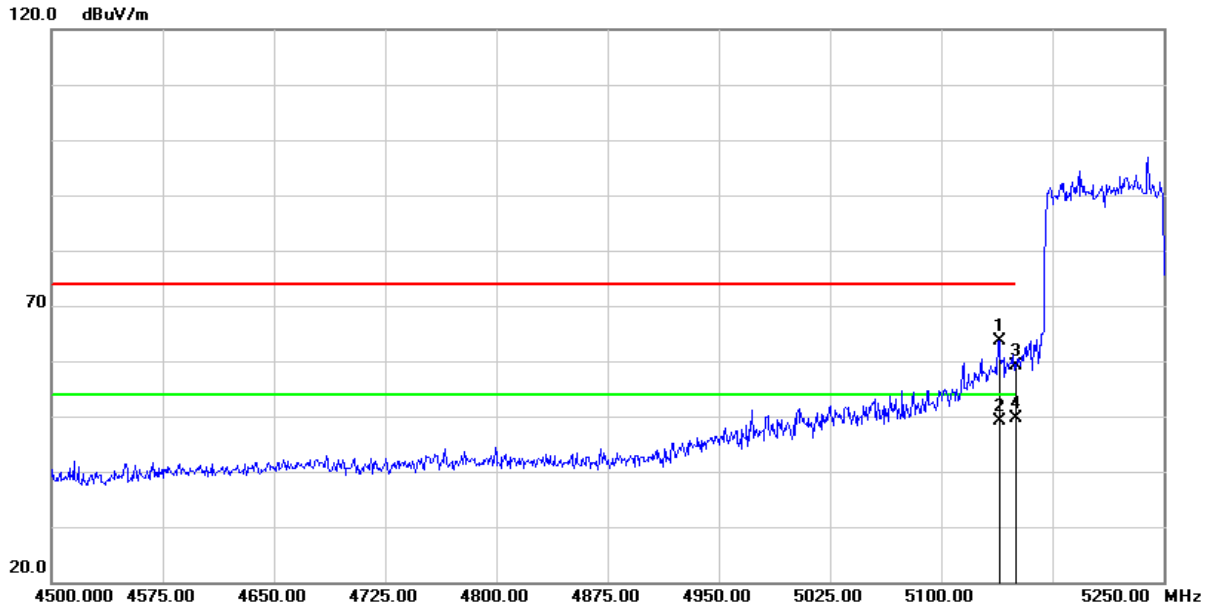

No.	Frequency (MHz)	Reading (dBuV/m)	Correct Factor (dB/m)	Result (dBuV/m)	Limit (dBuV/m)	Margin (dB)	Remark
1	5139.000	60.51	3.12	63.63	74.00	-10.37	peak
2	5139.000	46.09	3.12	49.21	54.00	-4.79	AVG
3	5150.000	55.93	3.14	59.07	74.00	-14.93	peak
4	5150.000	46.59	3.14	49.73	54.00	-4.27	AVG

Remark :

1. Correction Factor = Antenna factor + Cable loss – Amplifier gain
2. Result Value = Reading Level + Correct Factor
3. Margin Level = Result Value – Limit Value
4. The other emission levels were very low against the limit

Test Mode :	Transmit (802.11ax HE80 MCS0)	Test Date :	2024/03/27
Test Channel :	CH155(5775MHz)	Temperature :	23.4 °C
Polarization :	Horizontal	Relative Humidity :	53 %

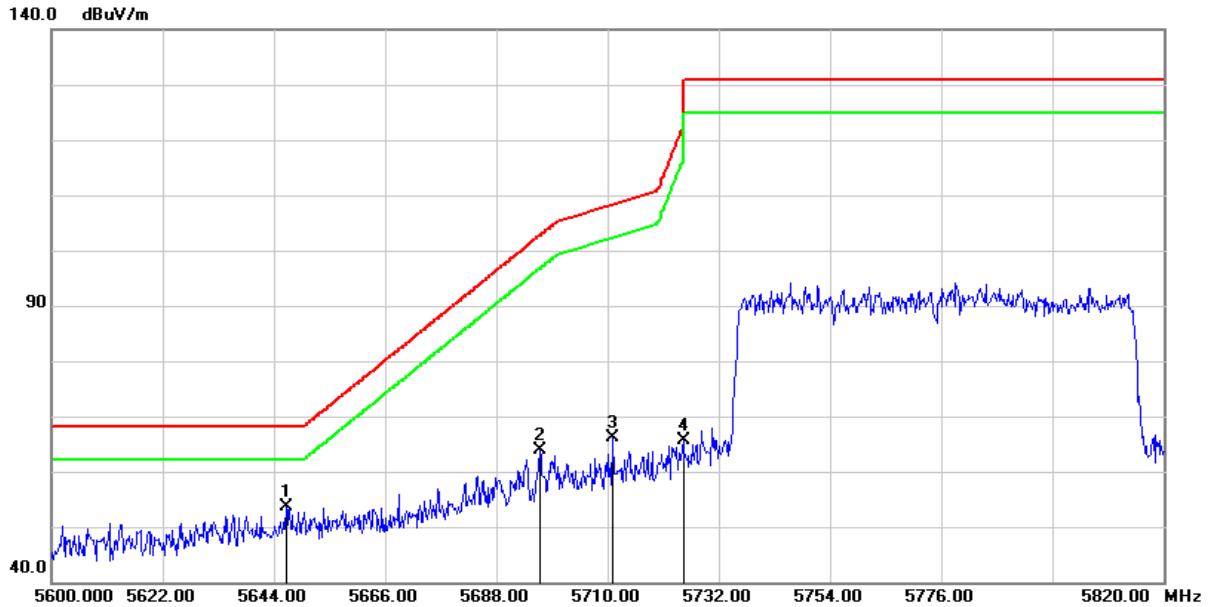

No.	Frequency (MHz)	Reading (dBuV/m)	Correct Factor (dB/m)	Result (dBuV/m)	Limit (dBuV/m)	Margin (dB)	Remark
1	5646.420	50.41	3.14	53.55	68.20	-14.65	peak
2	5696.580	60.39	3.39	63.78	102.67	-38.89	peak
3	5711.100	62.68	3.42	66.10	108.31	-42.21	peak
4	5724.960	62.13	3.43	65.56	122.11	-56.55	peak

Remark :

1. Correction Factor = Antenna factor + Cable loss – Amplifier gain
2. Result Value = Reading Level + Correct Factor
3. Margin Level = Result Value – Limit Value
4. The other emission levels were very low against the limit

Test Mode :	Transmit (802.11ax HE80 MCS0)	Test Date :	2024/03/27
Test Channel :	CH155(5775MHz)	Temperature :	23.4 °C
Polarization :	Vertical	Relative Humidity :	53 %

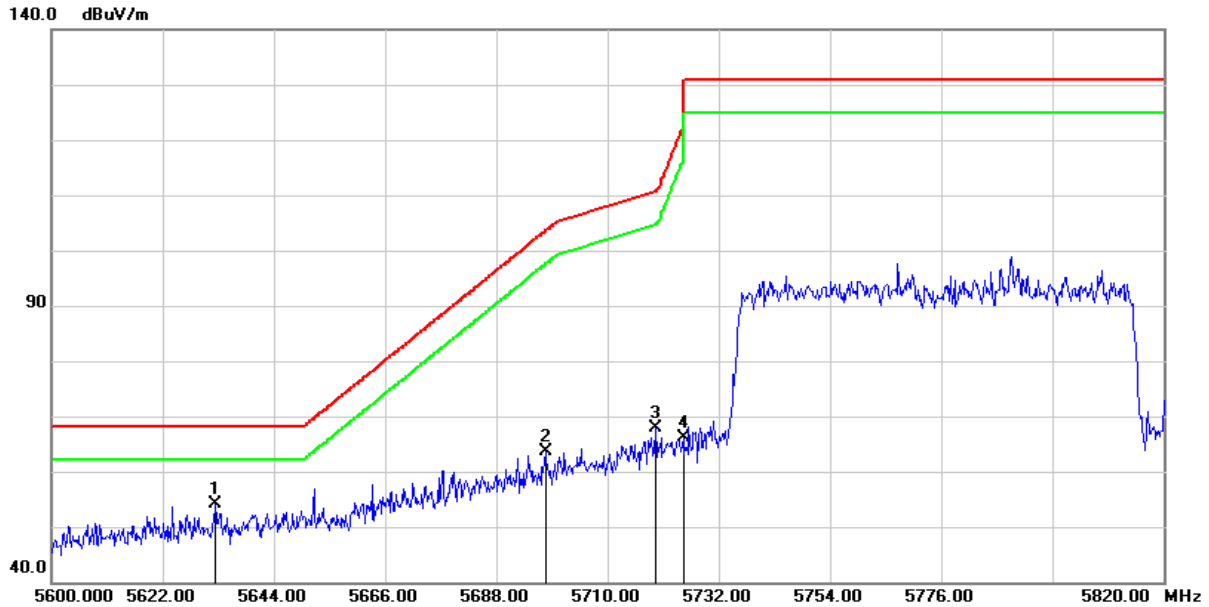

No.	Frequency (MHz)	Reading (dBuV/m)	Correct Factor (dB/m)	Result (dBuV/m)	Limit (dBuV/m)	Margin (dB)	Remark
1	5632.340	51.11	3.12	54.23	68.20	-13.97	peak
2	5697.680	60.18	3.39	63.57	103.48	-39.91	peak
3	5719.460	64.56	3.43	67.99	110.65	-42.66	peak
4	5724.960	62.70	3.43	66.13	122.11	-55.98	peak

Remark :

1. Correction Factor = Antenna factor + Cable loss – Amplifier gain
2. Result Value = Reading Level + Correct Factor
3. Margin Level = Result Value – Limit Value
4. The other emission levels were very low against the limit

Test Mode :	Transmit (802.11ax HE80 MCS0)	Test Date :	2024/03/27
Test Channel :	CH155(5775MHz)	Temperature :	23.4 °C
Polarization :	Horizontal	Relative Humidity :	53 %

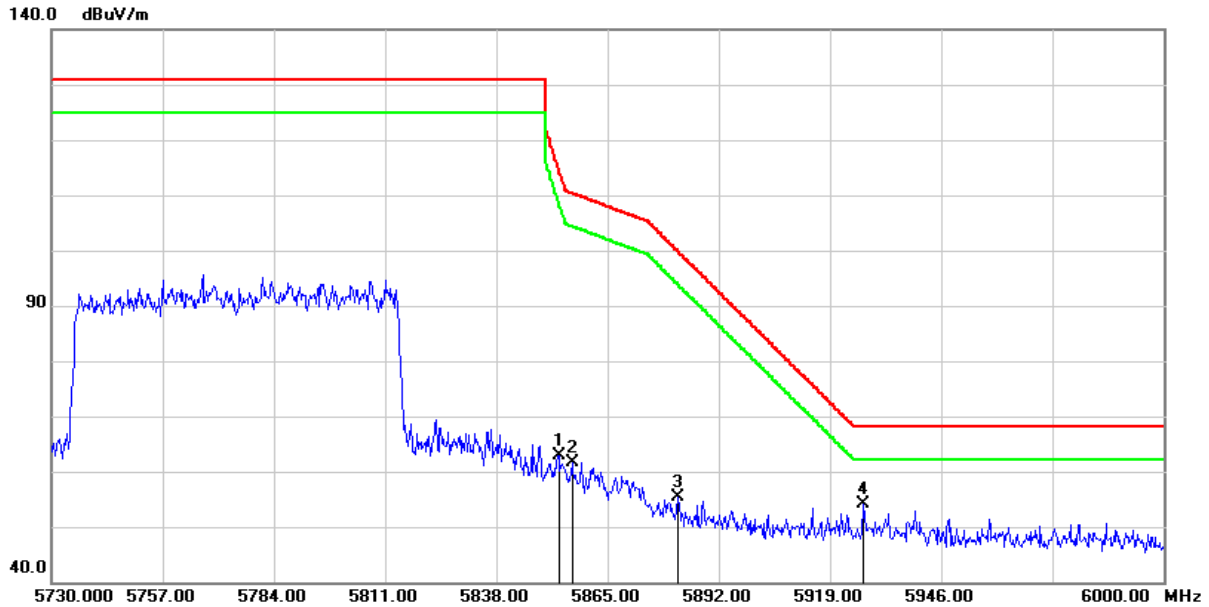

No.	Frequency (MHz)	Reading (dBuV/m)	Correct Factor (dB/m)	Result (dBuV/m)	Limit (dBuV/m)	Margin (dB)	Remark
1	5853.120	59.16	3.71	62.87	115.09	-52.22	peak
2	5856.360	57.97	3.73	61.70	110.42	-48.72	peak
3	5882.010	51.53	3.91	55.44	100.01	-44.57	peak
4	5927.100	49.97	4.08	54.05	68.20	-14.15	peak

Remark :

1. Correction Factor = Antenna factor + Cable loss – Amplifier gain
2. Result Value = Reading Level + Correct Factor
3. Margin Level = Result Value – Limit Value
4. The other emission levels were very low against the limit

Test Mode :	Transmit (802.11ax HE80 MCS0)	Test Date :	2024/03/27
Test Channel :	CH155(5775MHz)	Temperature :	23.4 °C
Polarization :	Vertical	Relative Humidity :	53 %



No.	Frequency (MHz)	Reading (dBuV/m)	Correct Factor (dB/m)	Result (dBuV/m)	Limit (dBuV/m)	Margin (dB)	Remark
1	5851.230	60.64	3.70	64.34	119.40	-55.06	peak
2	5860.950	60.21	3.77	63.98	109.13	-45.15	peak
3	5880.390	53.58	3.90	57.48	101.21	-43.73	peak
4	5953.020	48.27	4.12	52.39	68.20	-15.81	peak

Remark :

1. Correction Factor = Antenna factor + Cable loss – Amplifier gain
2. Result Value = Reading Level + Correct Factor
3. Margin Level = Result Value – Limit Value
4. The other emission levels were very low against the limit

2.5.6 Test Result of Radiated Spurious Emission Measurement

- (1) The radiation measurement frequency is 9kHz ~ 30MHz. The interference value of this frequency range is less than the limit value of 20 dB. It is considered that the background noise value is not recorded.
- (2) The following table shows the radiation measurement frequency from 30MHz to 40GHz, pre-scanning in the X, Y and Z axes. The worst case (X-axis) is documented in this report.

Test Frequency			
RF	802.11a / 802.11ac VHT20 802.11ax HE20	802.11ac VHT40 802.11ax HE40	802.11ac VHT80 802.11ax HE80
Tx	CH36 (5180MHz) CH40 (5200MHz) CH48 (5240MHz) CH149 (5745MHz) CH157 (5785MHz) CH165 (5825MHz)	CH38 (5190MHz) CH46 (5230MHz) CH151 (5755MHz) CH159 (5795MHz)	CH42 (5210MHz) CH155 (5775MHz)

Above 1GHz Data

Test Mode :	Transmit (802.11a 6Mbps)	Test Date :	2024/03/27
Test Channel :	CH36(5180MHz)	Temperature :	23.4 °C
Polarization :	Horizontal	Relative Humidity :	53 %

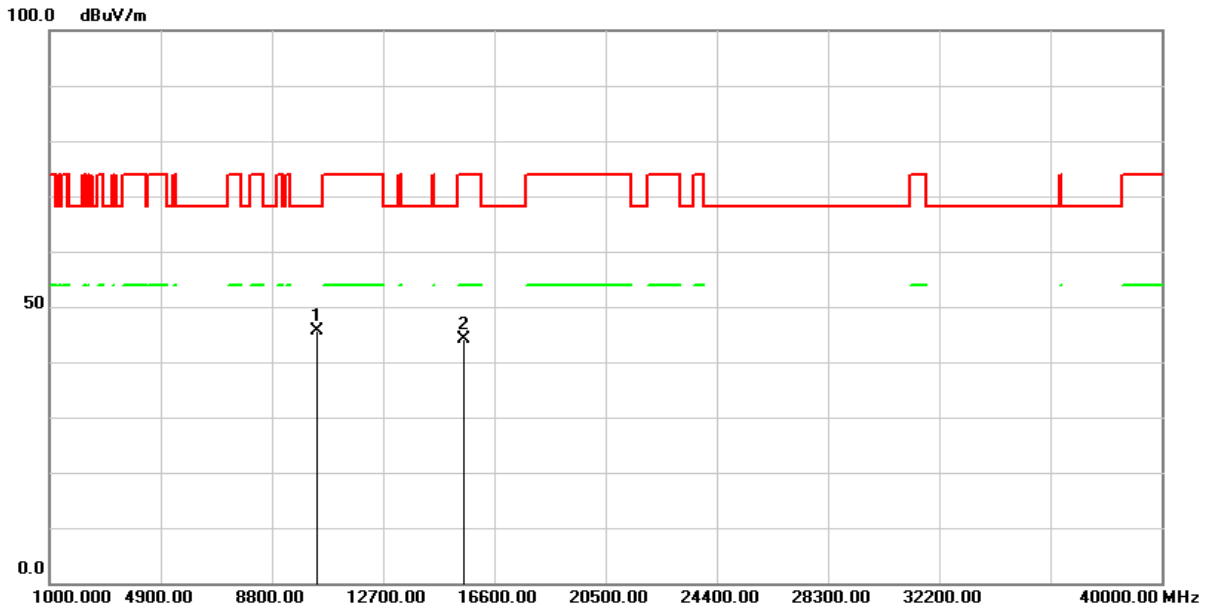

No.	Frequency (MHz)	Reading (dBuV/m)	Correct Factor (dB/m)	Result (dBuV/m)	Limit (dBuV/m)	Margin (dB)	Remark
1	10360.000	55.74	-10.05	45.69	68.20	-22.51	peak
2	15540.000	51.99	-7.80	44.19	74.00	-29.81	peak

Remark :

1. Correction Factor = Antenna factor + Cable loss – Amplifier gain
2. Result Value = Reading Level + Correct Factor
3. Margin Level = Result Value – Limit Value
4. The other emission levels were very low against the limit

Test Mode :	Transmit (802.11a 6Mbps)	Test Date :	2024/03/27
Test Channel :	CH36(5180MHz)	Temperature :	23.4 °C
Polarization :	Vertical	Relative Humidity :	53 %

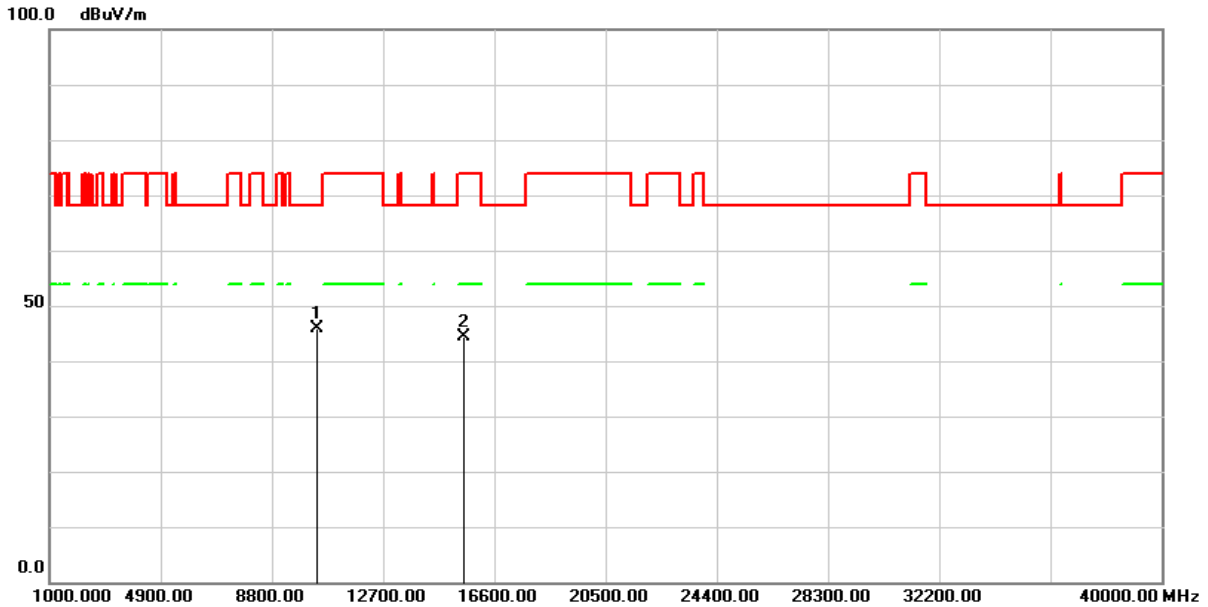

No.	Frequency (MHz)	Reading (dBuV/m)	Correct Factor (dB/m)	Result (dBuV/m)	Limit (dBuV/m)	Margin (dB)	Remark
1	10360.000	55.82	-10.05	45.77	68.20	-22.43	peak
2	15540.000	52.19	-7.80	44.39	74.00	-29.61	peak

Remark :

1. Correction Factor = Antenna factor + Cable loss – Amplifier gain
2. Result Value = Reading Level + Correct Factor
3. Margin Level = Result Value – Limit Value
4. The other emission levels were very low against the limit

Test Mode :	Transmit (802.11a 6Mbps)	Test Date :	2024/03/27
Test Channel :	CH40(5200MHz)	Temperature :	23.4 °C
Polarization :	Horizontal	Relative Humidity :	53 %

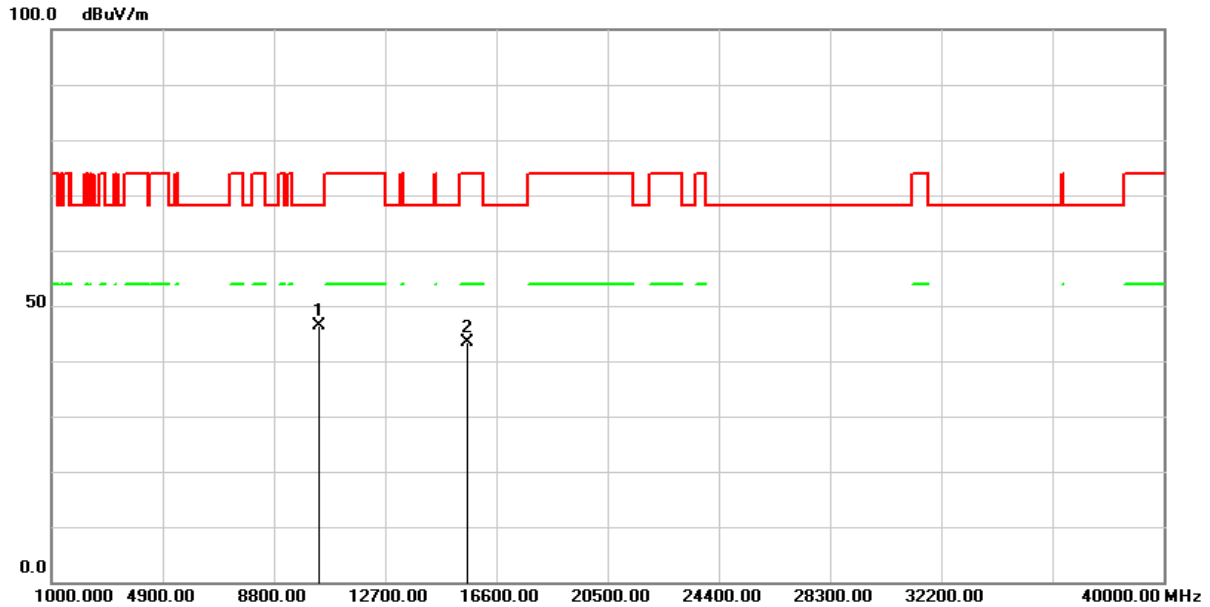

No.	Frequency (MHz)	Reading (dBuV/m)	Correct Factor (dB/m)	Result (dBuV/m)	Limit (dBuV/m)	Margin (dB)	Remark
1	10400.000	56.25	-9.95	46.30	68.20	-21.90	peak
2	15600.000	51.15	-7.79	43.36	74.00	-30.64	peak

Remark :

1. Correction Factor = Antenna factor + Cable loss – Amplifier gain
2. Result Value = Reading Level + Correct Factor
3. Margin Level = Result Value – Limit Value
4. The other emission levels were very low against the limit

Test Mode :	Transmit (802.11a 6Mbps)	Test Date :	2024/03/27
Test Channel :	CH40(5200MHz)	Temperature :	23.4 °C
Polarization :	Vertical	Relative Humidity :	53 %

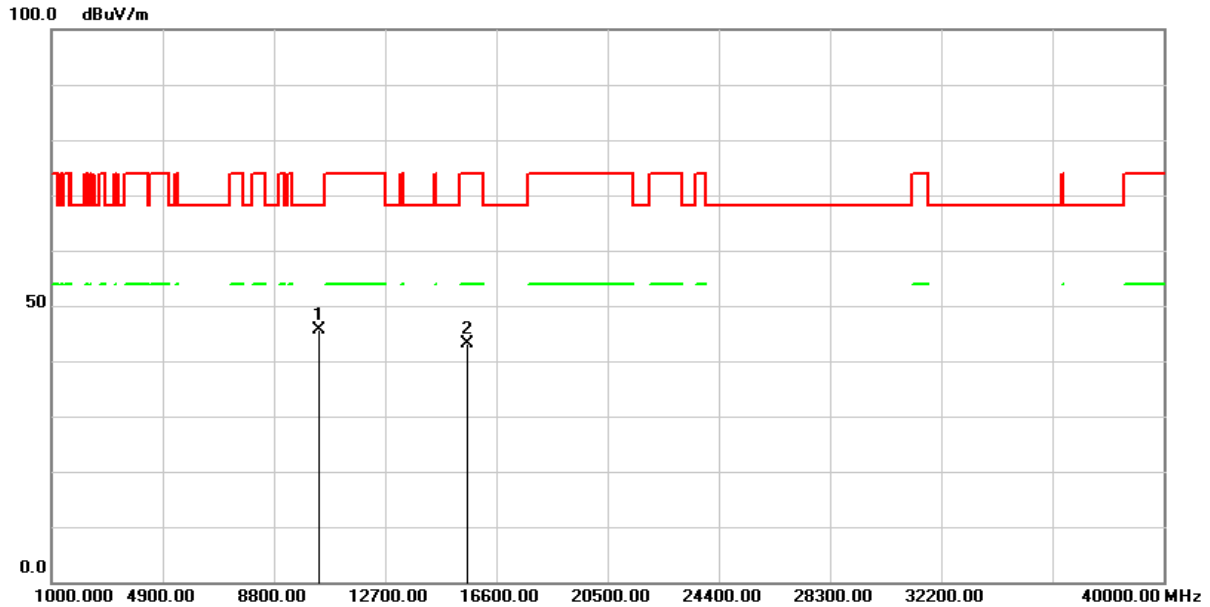

No.	Frequency (MHz)	Reading (dBuV/m)	Correct Factor (dB/m)	Result (dBuV/m)	Limit (dBuV/m)	Margin (dB)	Remark
1	10400.000	55.54	-9.95	45.59	68.20	-22.61	peak
2	15600.000	50.81	-7.79	43.02	74.00	-30.98	peak

Remark :

1. Correction Factor = Antenna factor + Cable loss – Amplifier gain
2. Result Value = Reading Level + Correct Factor
3. Margin Level = Result Value – Limit Value
4. The other emission levels were very low against the limit

Test Mode :	Transmit (802.11a 6Mbps)	Test Date :	2024/03/27
Test Channel :	CH48(5240MHz)	Temperature :	23.4 °C
Polarization :	Horizontal	Relative Humidity :	53 %

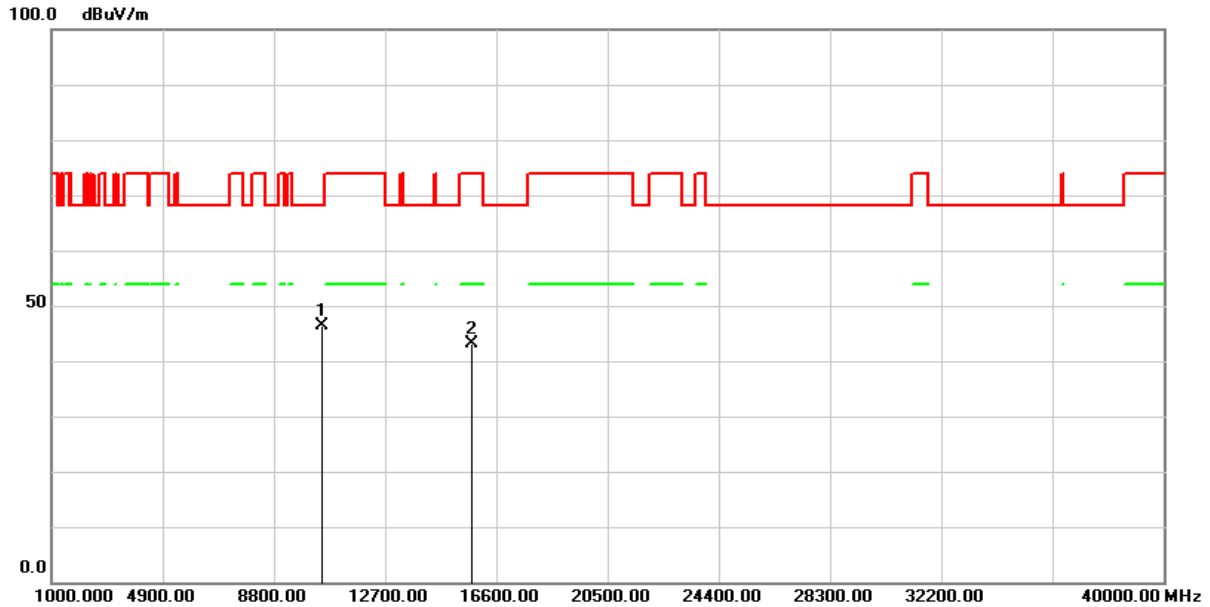

No.	Frequency (MHz)	Reading (dBuV/m)	Correct Factor (dB/m)	Result (dBuV/m)	Limit (dBuV/m)	Margin (dB)	Remark
1	10480.000	56.31	-9.97	46.34	68.20	-21.86	peak
2	15720.000	50.79	-7.62	43.17	74.00	-30.83	peak

Remark :

1. Correction Factor = Antenna factor + Cable loss – Amplifier gain
2. Result Value = Reading Level + Correct Factor
3. Margin Level = Result Value – Limit Value
4. The other emission levels were very low against the limit

Test Mode :	Transmit (802.11a 6Mbps)	Test Date :	2024/03/27
Test Channel :	CH48(5240MHz)	Temperature :	23.4 °C
Polarization :	Vertical	Relative Humidity :	53 %

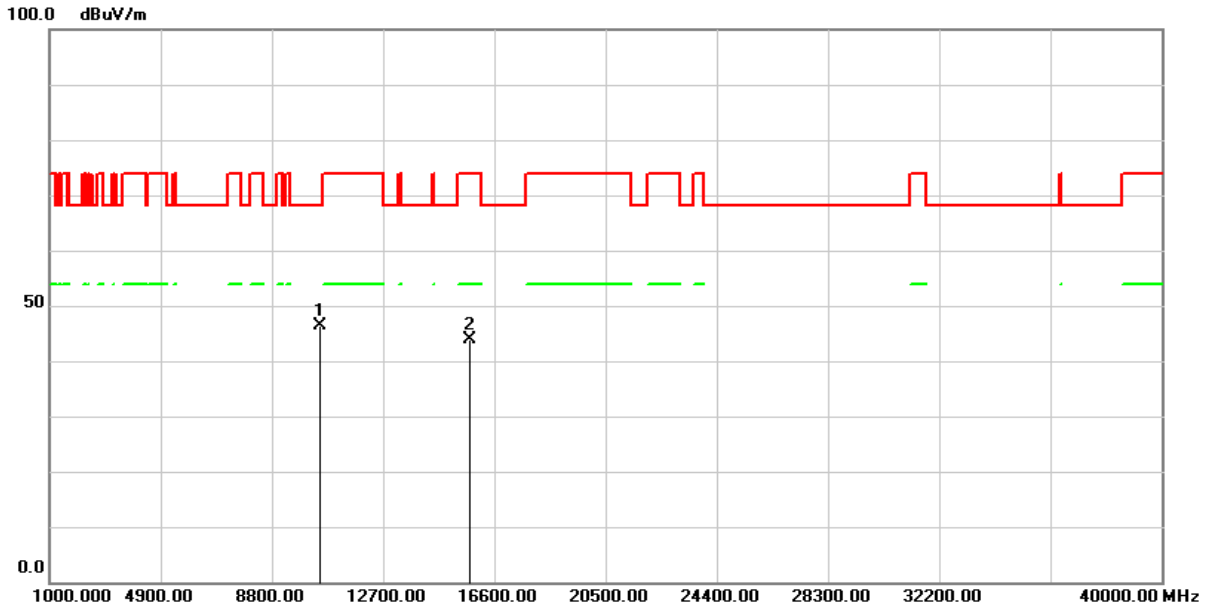

No.	Frequency (MHz)	Reading (dBuV/m)	Correct Factor (dB/m)	Result (dBuV/m)	Limit (dBuV/m)	Margin (dB)	Remark
1	10480.000	56.35	-9.97	46.38	68.20	-21.82	peak
2	15720.000	51.38	-7.62	43.76	74.00	-30.24	peak

Remark :

1. Correction Factor = Antenna factor + Cable loss – Amplifier gain
2. Result Value = Reading Level + Correct Factor
3. Margin Level = Result Value – Limit Value
4. The other emission levels were very low against the limit

Test Mode :	Transmit (802.11a 6Mbps)	Test Date :	2024/03/27
Test Channel :	CH149(5745MHz)	Temperature :	23.4 °C
Polarization :	Horizontal	Relative Humidity :	53 %

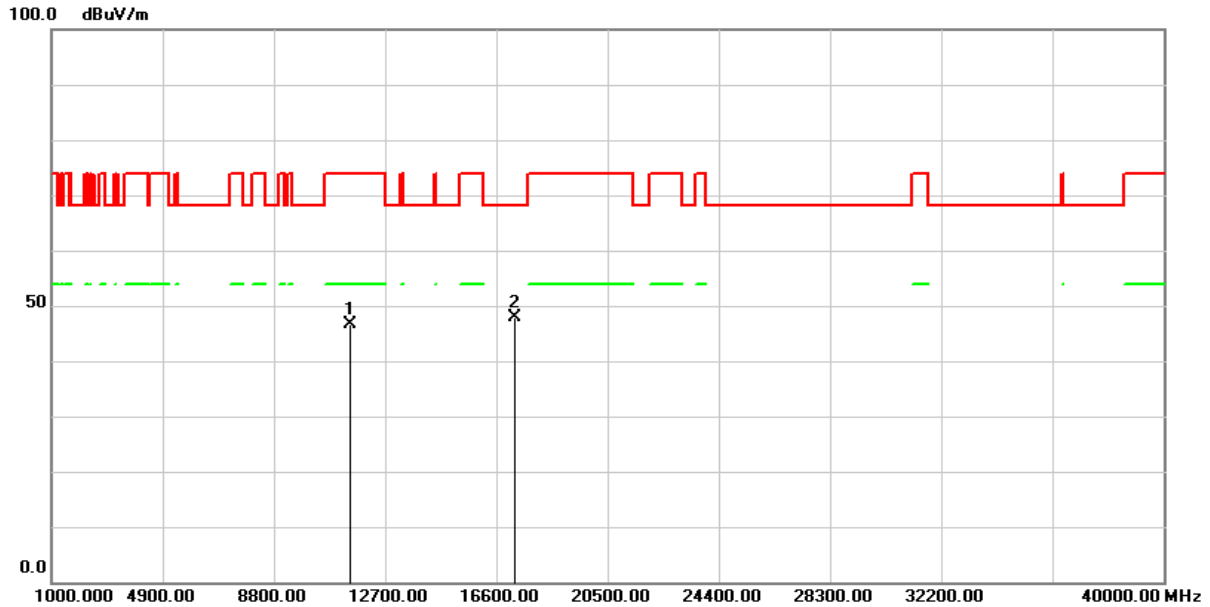

No.	Frequency (MHz)	Reading (dBuV/m)	Correct Factor (dB/m)	Result (dBuV/m)	Limit (dBuV/m)	Margin (dB)	Remark
1	11490.000	55.96	-9.45	46.51	74.00	-27.49	peak
2	17235.000	50.10	-2.24	47.86	68.20	-20.34	peak

Remark :

1. Correction Factor = Antenna factor + Cable loss – Amplifier gain
2. Result Value = Reading Level + Correct Factor
3. Margin Level = Result Value – Limit Value
4. The other emission levels were very low against the limit

Test Mode :	Transmit (802.11a 6Mbps)	Test Date :	2024/03/27
Test Channel :	CH149(5745MHz)	Temperature :	23.4 °C
Polarization :	Vertical	Relative Humidity :	53 %

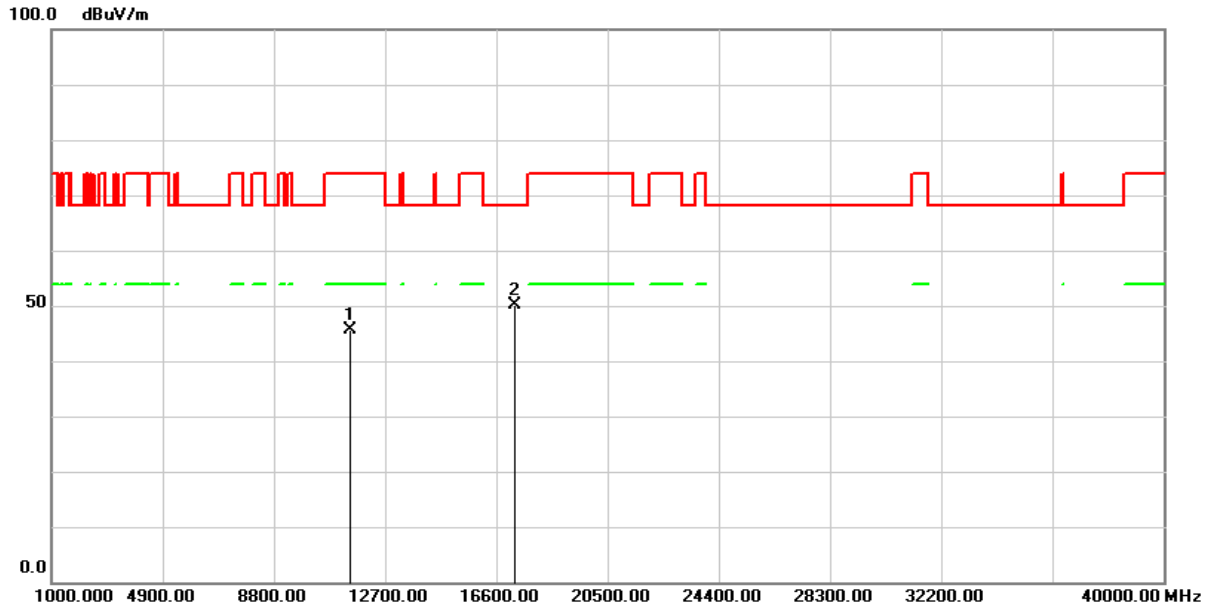

No.	Frequency (MHz)	Reading (dBuV/m)	Correct Factor (dB/m)	Result (dBuV/m)	Limit (dBuV/m)	Margin (dB)	Remark
1	11490.000	55.06	-9.45	45.61	74.00	-28.39	peak
2	17235.000	52.26	-2.24	50.02	68.20	-18.18	peak

Remark :

1. Correction Factor = Antenna factor + Cable loss – Amplifier gain
2. Result Value = Reading Level + Correct Factor
3. Margin Level = Result Value – Limit Value
4. The other emission levels were very low against the limit

Test Mode :	Transmit (802.11a 6Mbps)	Test Date :	2024/03/27
Test Channel :	CH157(5785MHz)	Temperature :	23.4 °C
Polarization :	Horizontal	Relative Humidity :	53 %

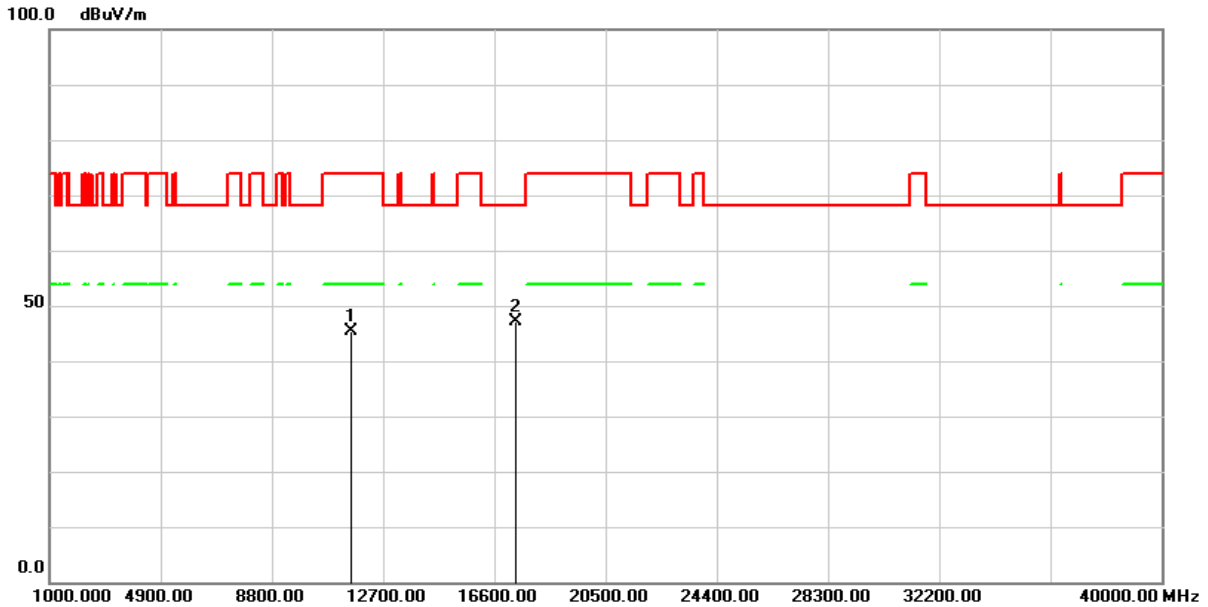

No.	Frequency (MHz)	Reading (dBuV/m)	Correct Factor (dB/m)	Result (dBuV/m)	Limit (dBuV/m)	Margin (dB)	Remark
1	11570.000	54.87	-9.40	45.47	74.00	-28.53	peak
2	17355.000	48.79	-1.65	47.14	68.20	-21.06	peak

Remark :

1. Correction Factor = Antenna factor + Cable loss – Amplifier gain
2. Result Value = Reading Level + Correct Factor
3. Margin Level = Result Value – Limit Value
4. The other emission levels were very low against the limit

Test Mode :	Transmit (802.11a 6Mbps)	Test Date :	2024/03/27
Test Channel :	CH157(5785MHz)	Temperature :	23.4 °C
Polarization :	Vertical	Relative Humidity :	53 %

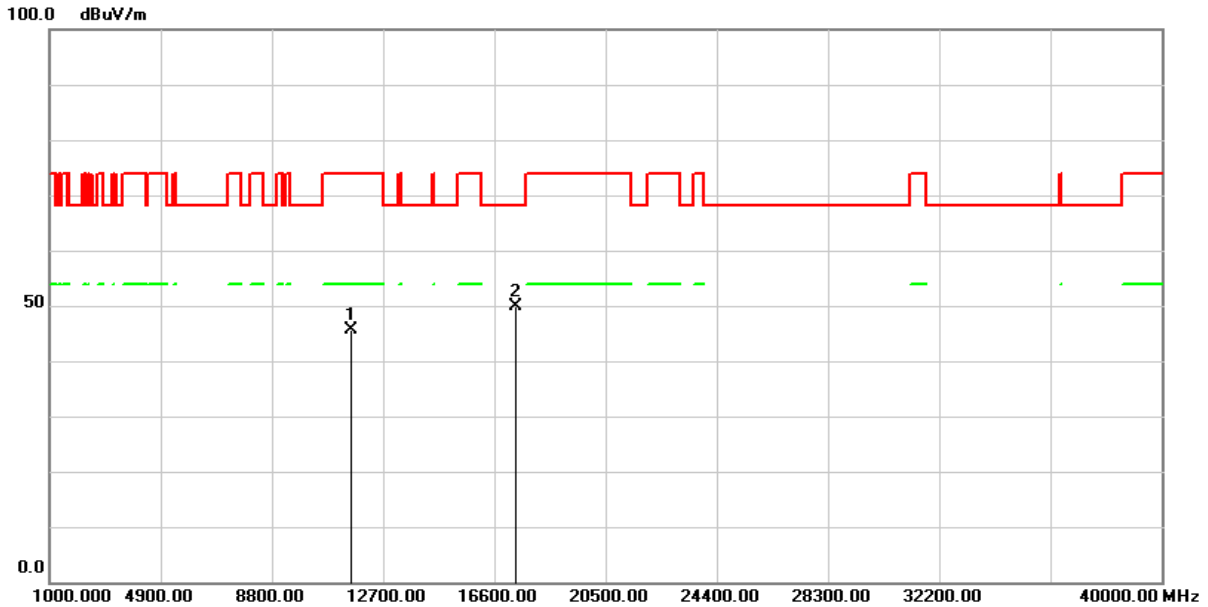

No.	Frequency (MHz)	Reading (dBuV/m)	Correct Factor (dB/m)	Result (dBuV/m)	Limit (dBuV/m)	Margin (dB)	Remark
1	11570.000	55.12	-9.40	45.72	74.00	-28.28	peak
2	17355.000	51.45	-1.65	49.80	68.20	-18.40	peak

Remark :

1. Correction Factor = Antenna factor + Cable loss – Amplifier gain
2. Result Value = Reading Level + Correct Factor
3. Margin Level = Result Value – Limit Value
4. The other emission levels were very low against the limit

Test Mode :	Transmit (802.11a 6Mbps)	Test Date :	2024/03/27
Test Channel :	CH165(5825MHz)	Temperature :	23.4 °C
Polarization :	Horizontal	Relative Humidity :	53 %

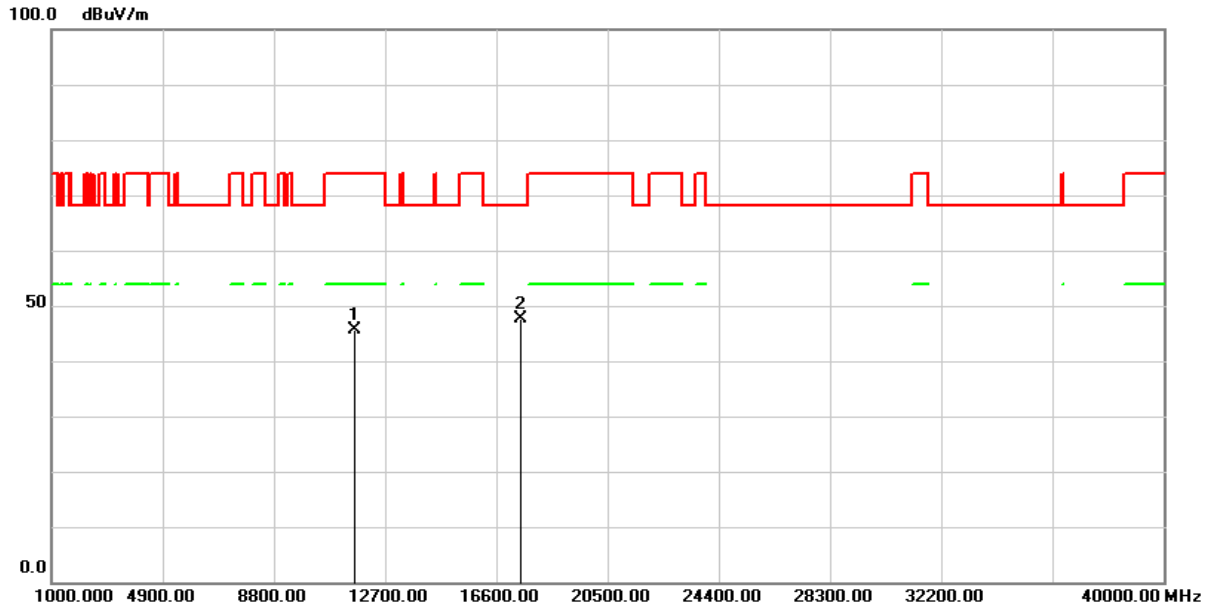

No.	Frequency (MHz)	Reading (dBuV/m)	Correct Factor (dB/m)	Result (dBuV/m)	Limit (dBuV/m)	Margin (dB)	Remark
1	11650.000	55.38	-9.82	45.56	74.00	-28.44	peak
2	17475.000	48.37	-0.85	47.52	68.20	-20.68	peak

Remark :

1. Correction Factor = Antenna factor + Cable loss – Amplifier gain
2. Result Value = Reading Level + Correct Factor
3. Margin Level = Result Value – Limit Value
4. The other emission levels were very low against the limit

Test Mode :	Transmit (802.11a 6Mbps)	Test Date :	2024/03/27
Test Channel :	CH165(5825MHz)	Temperature :	23.4 °C
Polarization :	Vertical	Relative Humidity :	53 %

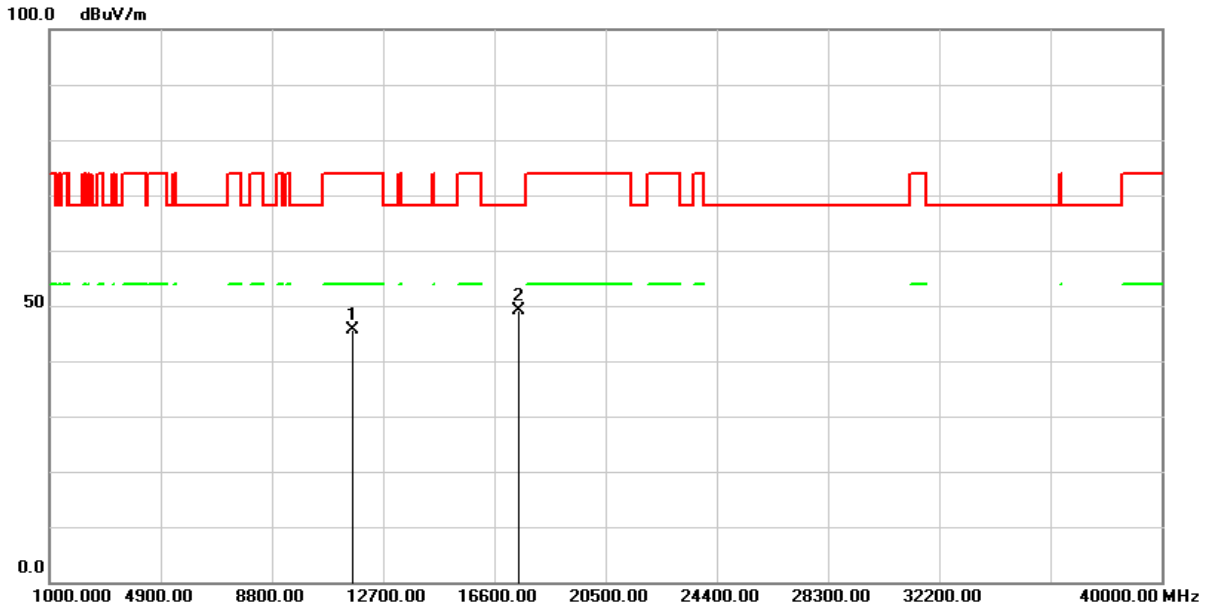

No.	Frequency (MHz)	Reading (dBuV/m)	Correct Factor (dB/m)	Result (dBuV/m)	Limit (dBuV/m)	Margin (dB)	Remark
1	11650.000	55.43	-9.82	45.61	74.00	-28.39	peak
2	17475.000	50.00	-0.85	49.15	68.20	-19.05	peak

Remark :

1. Correction Factor = Antenna factor + Cable loss – Amplifier gain
2. Result Value = Reading Level + Correct Factor
3. Margin Level = Result Value – Limit Value
4. The other emission levels were very low against the limit

Test Mode :	Transmit (802.11ac VHT20 MCS0)	Test Date :	2024/03/27
Test Channel :	CH36(5180MHz)	Temperature :	23.4 °C
Polarization :	Horizontal	Relative Humidity :	53 %

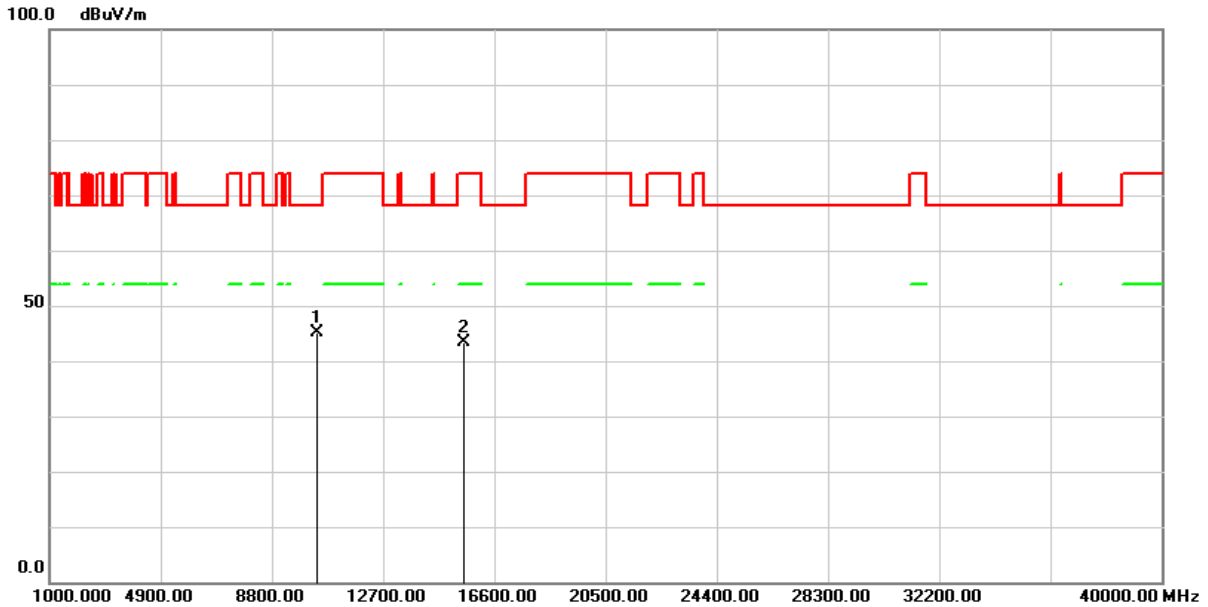

No.	Frequency (MHz)	Reading (dBuV/m)	Correct Factor (dB/m)	Result (dBuV/m)	Limit (dBuV/m)	Margin (dB)	Remark
1	10360.000	55.09	-10.05	45.04	68.20	-23.16	peak
2	15540.000	51.22	-7.80	43.42	74.00	-30.58	peak

Remark :

1. Correction Factor = Antenna factor + Cable loss – Amplifier gain
2. Result Value = Reading Level + Correct Factor
3. Margin Level = Result Value – Limit Value
4. The other emission levels were very low against the limit

Test Mode :	Transmit (802.11ac VHT20 MCS0)	Test Date :	2024/03/27
Test Channel :	CH36(5180MHz)	Temperature :	23.4 °C
Polarization :	Vertical	Relative Humidity :	53 %

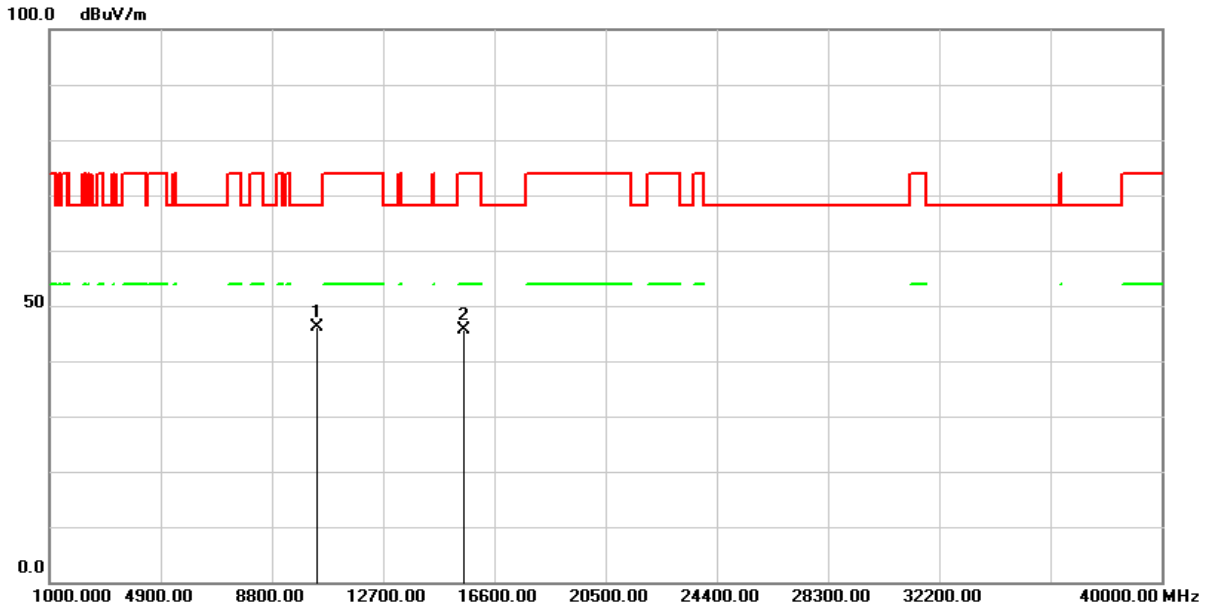

No.	Frequency (MHz)	Reading (dBuV/m)	Correct Factor (dB/m)	Result (dBuV/m)	Limit (dBuV/m)	Margin (dB)	Remark
1	10360.000	56.11	-10.05	46.06	68.20	-22.14	peak
2	15540.000	53.45	-7.80	45.65	74.00	-28.35	peak

Remark :

1. Correction Factor = Antenna factor + Cable loss – Amplifier gain
2. Result Value = Reading Level + Correct Factor
3. Margin Level = Result Value – Limit Value
4. The other emission levels were very low against the limit

Test Mode :	Transmit (802.11ac VHT20 MCS0)	Test Date :	2024/03/27
Test Channel :	CH40(5200MHz)	Temperature :	23.4 °C
Polarization :	Horizontal	Relative Humidity :	53 %

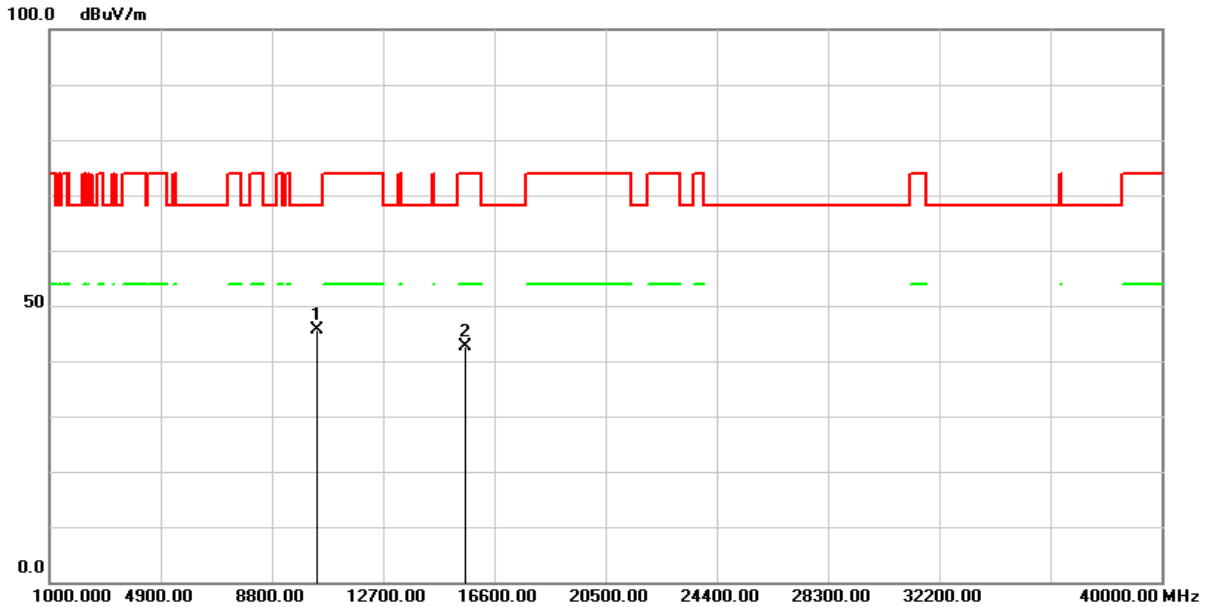

No.	Frequency (MHz)	Reading (dBuV/m)	Correct Factor (dB/m)	Result (dBuV/m)	Limit (dBuV/m)	Margin (dB)	Remark
1	10400.000	55.50	-9.95	45.55	68.20	-22.65	peak
2	15600.000	50.50	-7.79	42.71	74.00	-31.29	peak

Remark :

1. Correction Factor = Antenna factor + Cable loss – Amplifier gain
2. Result Value = Reading Level + Correct Factor
3. Margin Level = Result Value – Limit Value
4. The other emission levels were very low against the limit

Test Mode :	Transmit (802.11ac VHT20 MCS0)	Test Date :	2024/03/27
Test Channel :	CH40(5200MHz)	Temperature :	23.4 °C
Polarization :	Vertical	Relative Humidity :	53 %

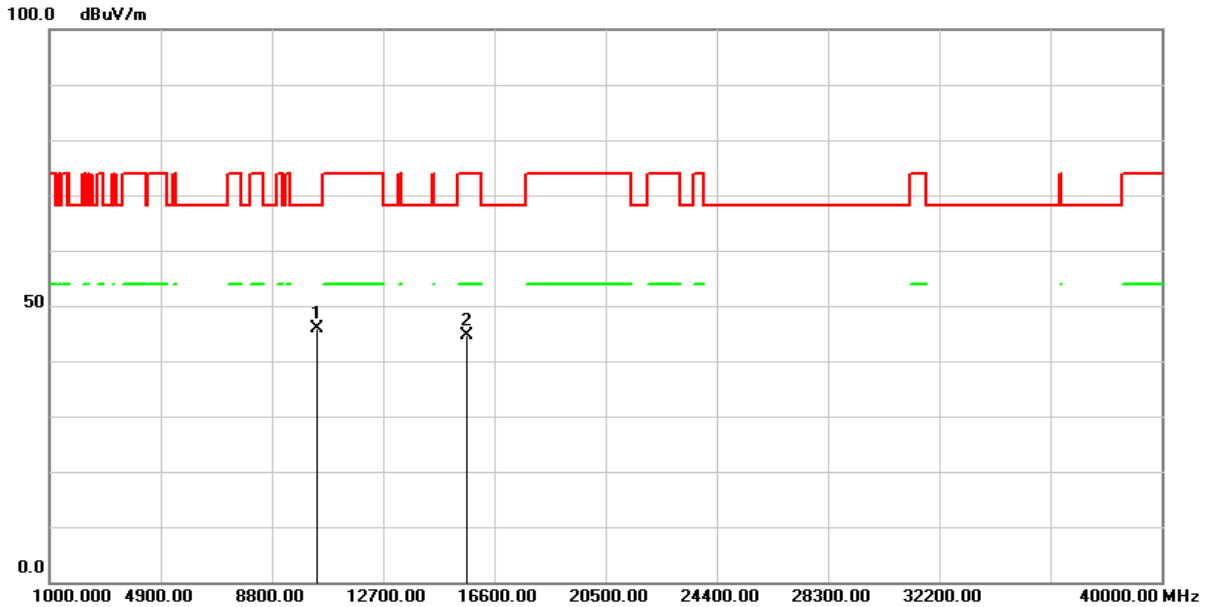

No.	Frequency (MHz)	Reading (dBuV/m)	Correct Factor (dB/m)	Result (dBuV/m)	Limit (dBuV/m)	Margin (dB)	Remark
1	10400.000	55.74	-9.95	45.79	68.20	-22.41	peak
2	15600.000	52.43	-7.79	44.64	74.00	-29.36	peak

Remark :

1. Correction Factor = Antenna factor + Cable loss – Amplifier gain
2. Result Value = Reading Level + Correct Factor
3. Margin Level = Result Value – Limit Value
4. The other emission levels were very low against the limit

Test Mode :	Transmit (802.11ac VHT20 MCS0)	Test Date :	2024/03/27
Test Channel :	CH48(5240MHz)	Temperature :	23.4 °C
Polarization :	Horizontal	Relative Humidity :	53 %

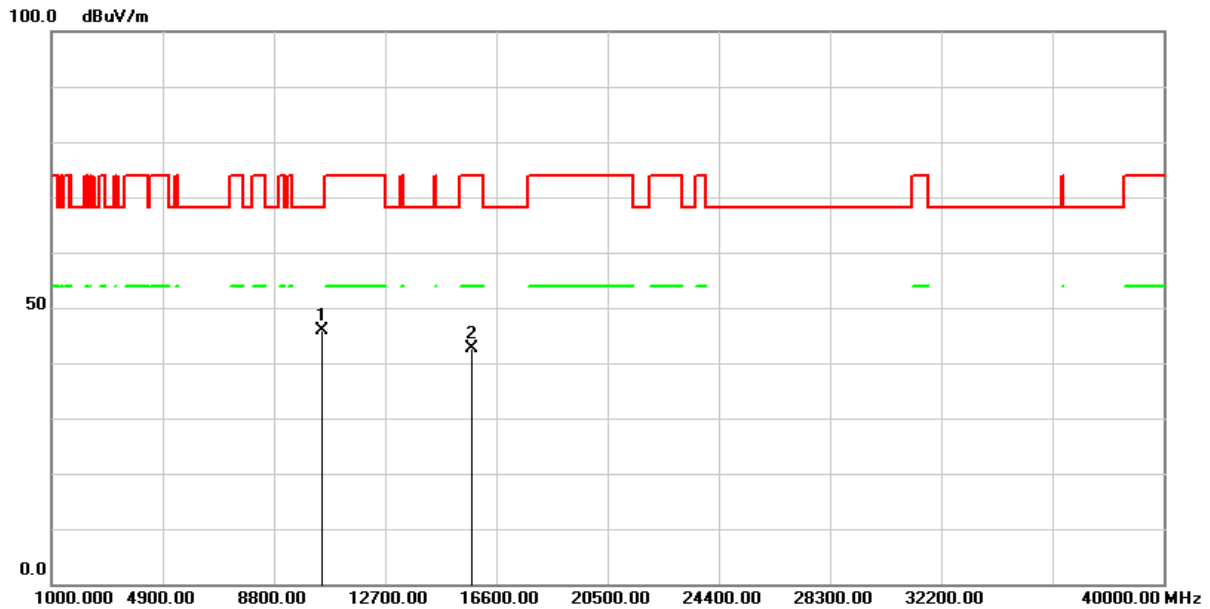

No.	Frequency (MHz)	Reading (dBuV/m)	Correct Factor (dB/m)	Result (dBuV/m)	Limit (dBuV/m)	Margin (dB)	Remark
1	10480.000	55.86	-9.97	45.89	68.20	-22.31	peak
2	15720.000	50.22	-7.62	42.60	74.00	-31.40	peak

Remark :

1. Correction Factor = Antenna factor + Cable loss – Amplifier gain
2. Result Value = Reading Level + Correct Factor
3. Margin Level = Result Value – Limit Value
4. The other emission levels were very low against the limit

Test Mode :	Transmit (802.11ac VHT20 MCS0)	Test Date :	2024/03/27
Test Channel :	CH48(5240MHz)	Temperature :	23.4 °C
Polarization :	Vertical	Relative Humidity :	53 %

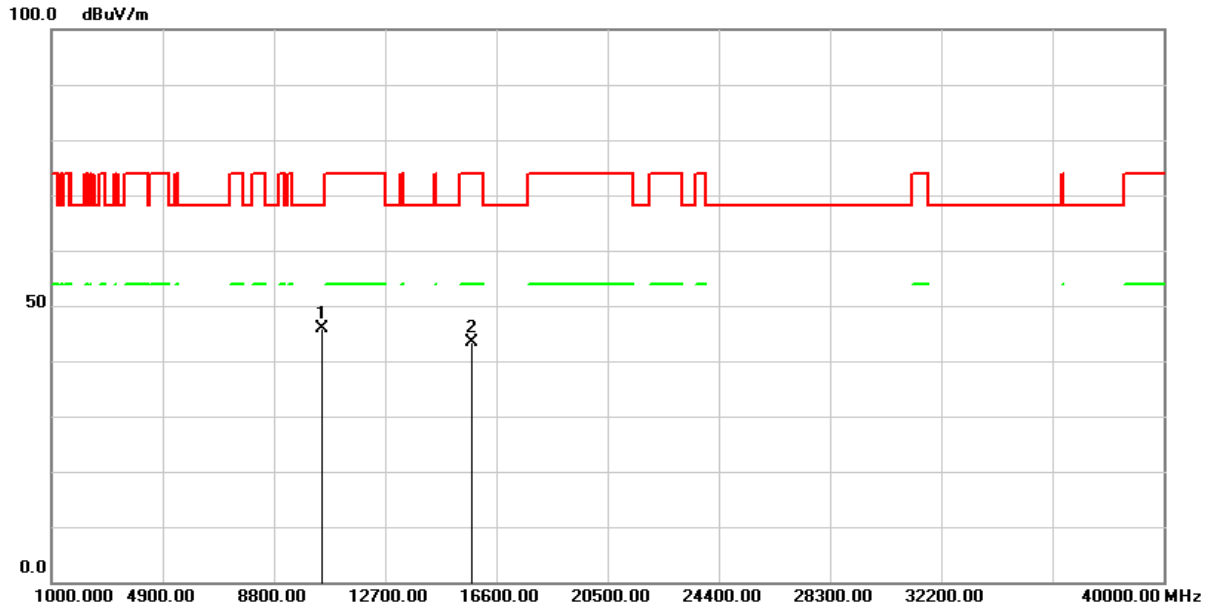

No.	Frequency (MHz)	Reading (dBuV/m)	Correct Factor (dB/m)	Result (dBuV/m)	Limit (dBuV/m)	Margin (dB)	Remark
1	10480.000	55.84	-9.97	45.87	68.20	-22.33	peak
2	15720.000	51.12	-7.62	43.50	74.00	-30.50	peak

Remark :

1. Correction Factor = Antenna factor + Cable loss – Amplifier gain
2. Result Value = Reading Level + Correct Factor
3. Margin Level = Result Value – Limit Value
4. The other emission levels were very low against the limit

Test Mode :	Transmit (802.11ac VHT20 MCS0)	Test Date :	2024/03/27
Test Channel :	CH149(5745MHz)	Temperature :	23.4 °C
Polarization :	Horizontal	Relative Humidity :	53 %

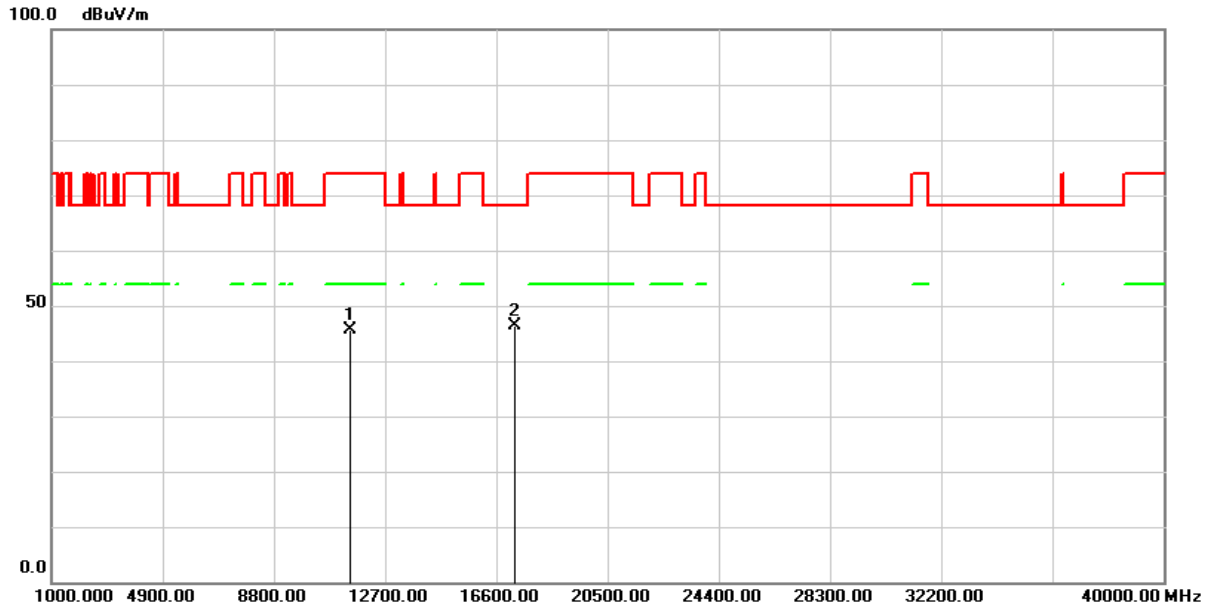

No.	Frequency (MHz)	Reading (dBuV/m)	Correct Factor (dB/m)	Result (dBuV/m)	Limit (dBuV/m)	Margin (dB)	Remark
1	11490.000	55.03	-9.45	45.58	74.00	-28.42	peak
2	17235.000	48.67	-2.24	46.43	68.20	-21.77	peak

Remark :

1. Correction Factor = Antenna factor + Cable loss – Amplifier gain
2. Result Value = Reading Level + Correct Factor
3. Margin Level = Result Value – Limit Value
4. The other emission levels were very low against the limit

Test Mode :	Transmit (802.11ac VHT20 MCS0)	Test Date :	2024/03/27
Test Channel :	CH149(5745MHz)	Temperature :	23.4 °C
Polarization :	Vertical	Relative Humidity :	53 %

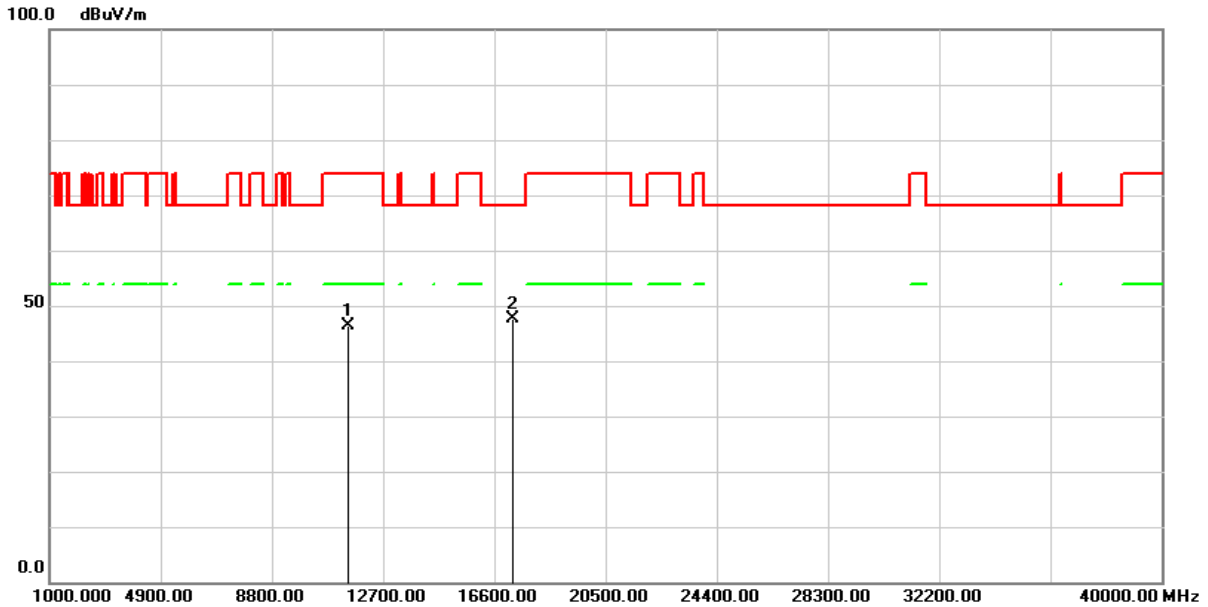

No.	Frequency (MHz)	Reading (dBuV/m)	Correct Factor (dB/m)	Result (dBuV/m)	Limit (dBuV/m)	Margin (dB)	Remark
1	11490.000	55.83	-9.45	46.38	74.00	-27.62	peak
2	17235.000	49.78	-2.24	47.54	68.20	-20.66	peak

Remark :

1. Correction Factor = Antenna factor + Cable loss – Amplifier gain
2. Result Value = Reading Level + Correct Factor
3. Margin Level = Result Value – Limit Value
4. The other emission levels were very low against the limit

Test Mode :	Transmit (802.11ac VHT20 MCS0)	Test Date :	2024/03/27
Test Channel :	CH157(5785MHz)	Temperature :	23.4 °C
Polarization :	Horizontal	Relative Humidity :	53 %

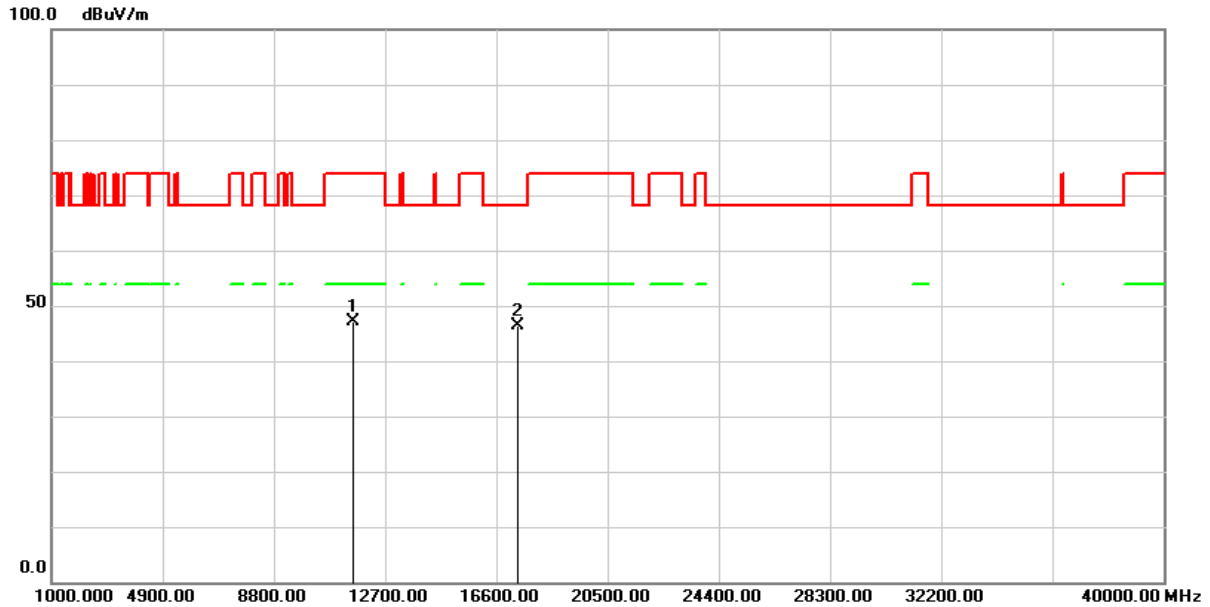

No.	Frequency (MHz)	Reading (dBuV/m)	Correct Factor (dB/m)	Result (dBuV/m)	Limit (dBuV/m)	Margin (dB)	Remark
1	11570.000	56.50	-9.40	47.10	74.00	-26.90	peak
2	17355.000	48.10	-1.65	46.45	68.20	-21.75	peak

Remark :

1. Correction Factor = Antenna factor + Cable loss – Amplifier gain
2. Result Value = Reading Level + Correct Factor
3. Margin Level = Result Value – Limit Value
4. The other emission levels were very low against the limit

Test Mode :	Transmit (802.11ac VHT20 MCS0)	Test Date :	2024/03/27
Test Channel :	CH157(5785MHz)	Temperature :	23.4 °C
Polarization :	Vertical	Relative Humidity :	53 %

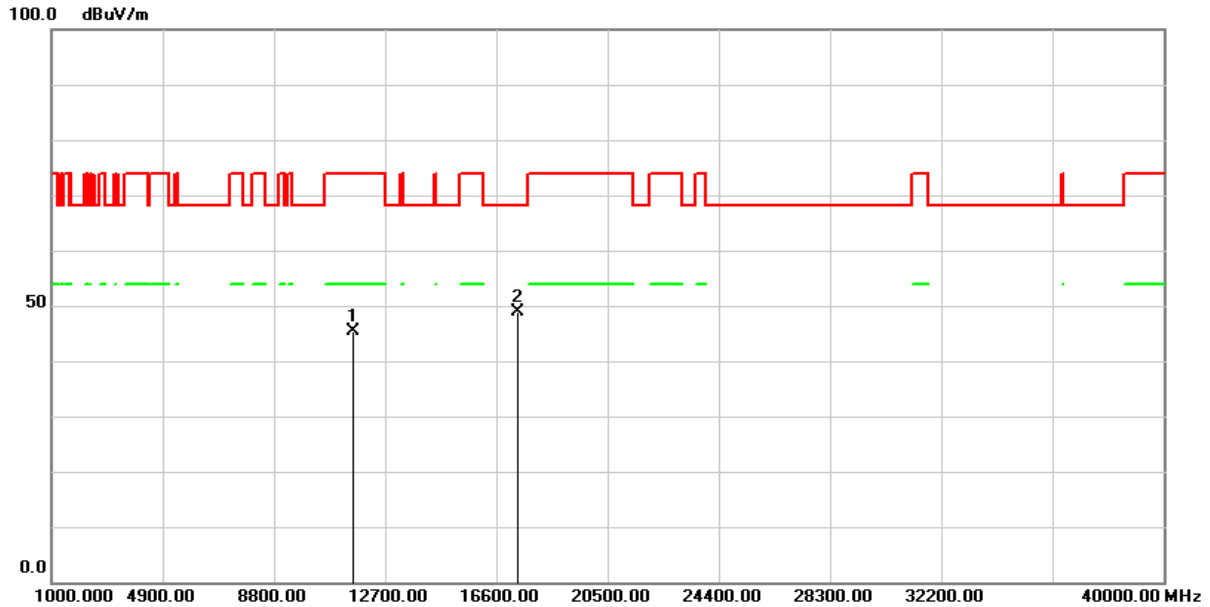

No.	Frequency (MHz)	Reading (dBuV/m)	Correct Factor (dB/m)	Result (dBuV/m)	Limit (dBuV/m)	Margin (dB)	Remark
1	11570.000	54.66	-9.40	45.26	74.00	-28.74	peak
2	17355.000	50.49	-1.65	48.84	68.20	-19.36	peak

Remark :

1. Correction Factor = Antenna factor + Cable loss – Amplifier gain
2. Result Value = Reading Level + Correct Factor
3. Margin Level = Result Value – Limit Value
4. The other emission levels were very low against the limit

Test Mode :	Transmit (802.11ac VHT20 MCS0)	Test Date :	2024/03/27
Test Channel :	CH165(5825MHz)	Temperature :	23.4 °C
Polarization :	Horizontal	Relative Humidity :	53 %

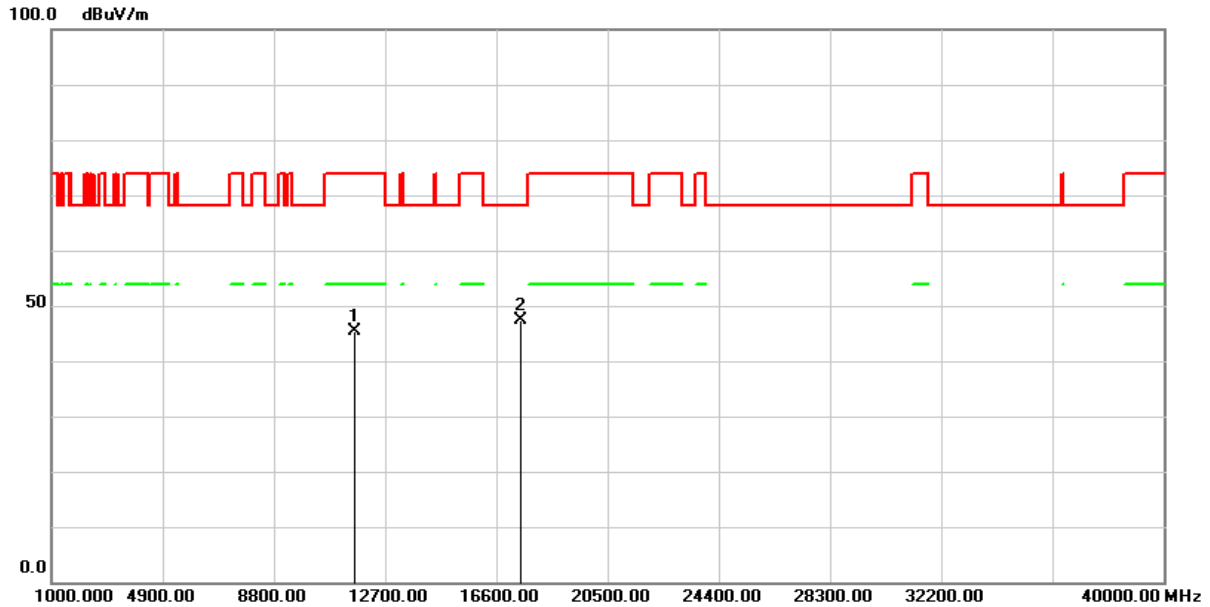

No.	Frequency (MHz)	Reading (dBuV/m)	Correct Factor (dB/m)	Result (dBuV/m)	Limit (dBuV/m)	Margin (dB)	Remark
1	11650.000	55.27	-9.82	45.45	74.00	-28.55	peak
2	17475.000	48.27	-0.85	47.42	68.20	-20.78	peak

Remark :

1. Correction Factor = Antenna factor + Cable loss – Amplifier gain
2. Result Value = Reading Level + Correct Factor
3. Margin Level = Result Value – Limit Value
4. The other emission levels were very low against the limit

Test Mode :	Transmit (802.11ac VHT20 MCS0)	Test Date :	2024/03/27
Test Channel :	CH165(5825MHz)	Temperature :	23.4 °C
Polarization :	Vertical	Relative Humidity :	53 %

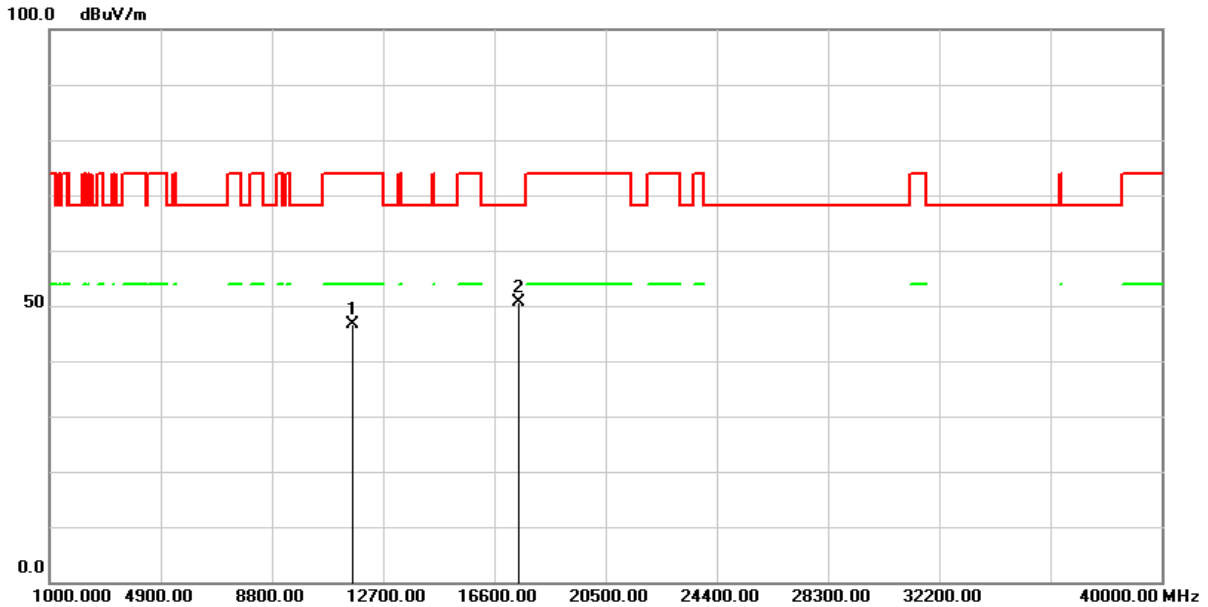

No.	Frequency (MHz)	Reading (dBuV/m)	Correct Factor (dB/m)	Result (dBuV/m)	Limit (dBuV/m)	Margin (dB)	Remark
1	11650.000	56.57	-9.82	46.75	74.00	-27.25	peak
2	17475.000	51.46	-0.85	50.61	68.20	-17.59	peak

Remark :

1. Correction Factor = Antenna factor + Cable loss – Amplifier gain
2. Result Value = Reading Level + Correct Factor
3. Margin Level = Result Value – Limit Value
4. The other emission levels were very low against the limit

Test Mode :	Transmit (802.11ac VHT40 MCS0)	Test Date :	2024/03/27
Test Channel :	CH38(5190MHz)	Temperature :	23.4 °C
Polarization :	Horizontal	Relative Humidity :	53 %

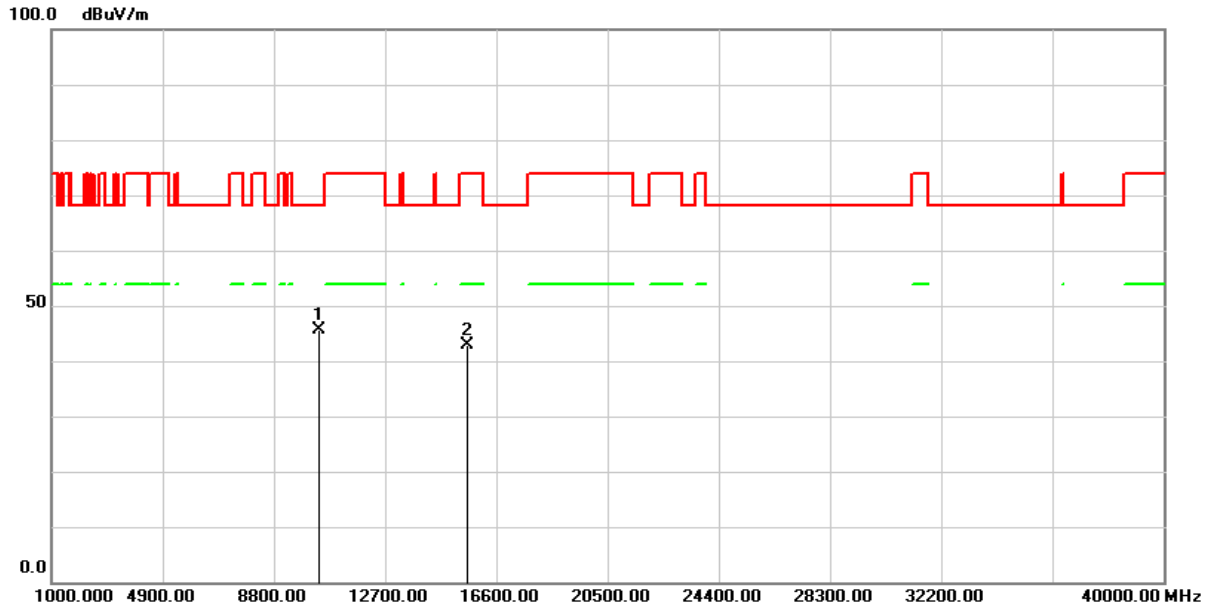

No.	Frequency (MHz)	Reading (dBuV/m)	Correct Factor (dB/m)	Result (dBuV/m)	Limit (dBuV/m)	Margin (dB)	Remark
1	10380.000	55.52	-10.00	45.52	68.20	-22.68	peak
2	15570.000	50.79	-7.79	43.00	74.00	-31.00	peak

Remark :

1. Correction Factor = Antenna factor + Cable loss – Amplifier gain
2. Result Value = Reading Level + Correct Factor
3. Margin Level = Result Value – Limit Value
4. The other emission levels were very low against the limit

Test Mode :	Transmit (802.11ac VHT40 MCS0)	Test Date :	2024/03/27
Test Channel :	CH38(5190MHz)	Temperature :	23.4 °C
Polarization :	Vertical	Relative Humidity :	53 %

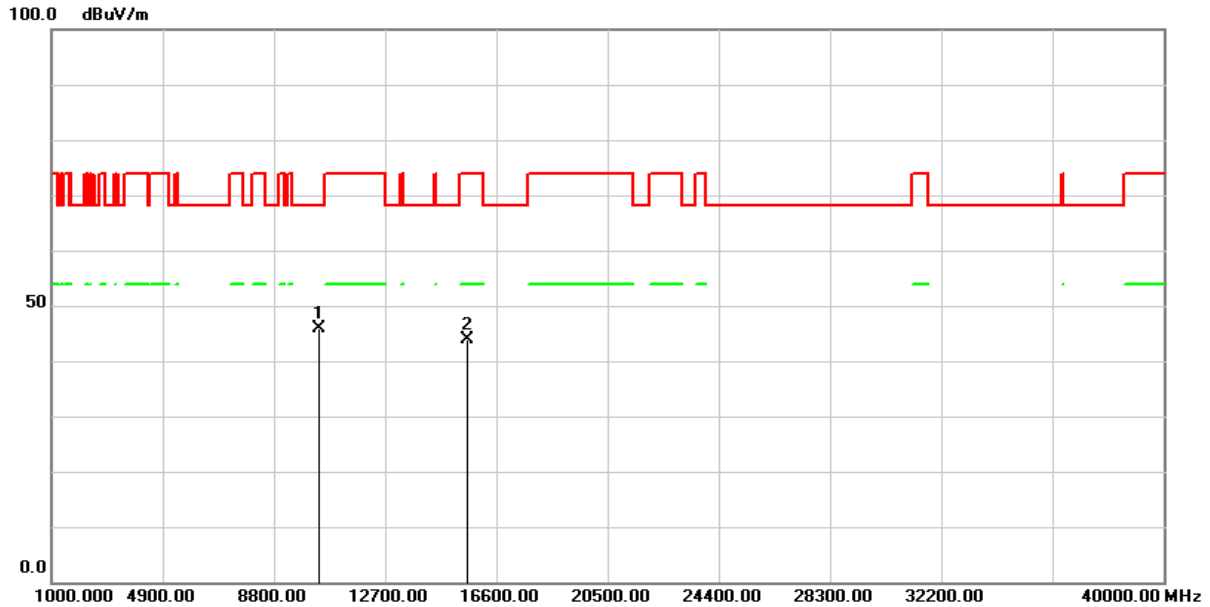

No.	Frequency (MHz)	Reading (dBuV/m)	Correct Factor (dB/m)	Result (dBuV/m)	Limit (dBuV/m)	Margin (dB)	Remark
1	10380.000	55.84	-10.00	45.84	68.20	-22.36	peak
2	15570.000	51.62	-7.79	43.83	74.00	-30.17	peak

Remark :

1. Correction Factor = Antenna factor + Cable loss – Amplifier gain
2. Result Value = Reading Level + Correct Factor
3. Margin Level = Result Value – Limit Value
4. The other emission levels were very low against the limit

Test Mode :	Transmit (802.11ac VHT40 MCS0)	Test Date :	2024/03/27
Test Channel :	CH46(5230MHz)	Temperature :	23.4 °C
Polarization :	Horizontal	Relative Humidity :	53 %

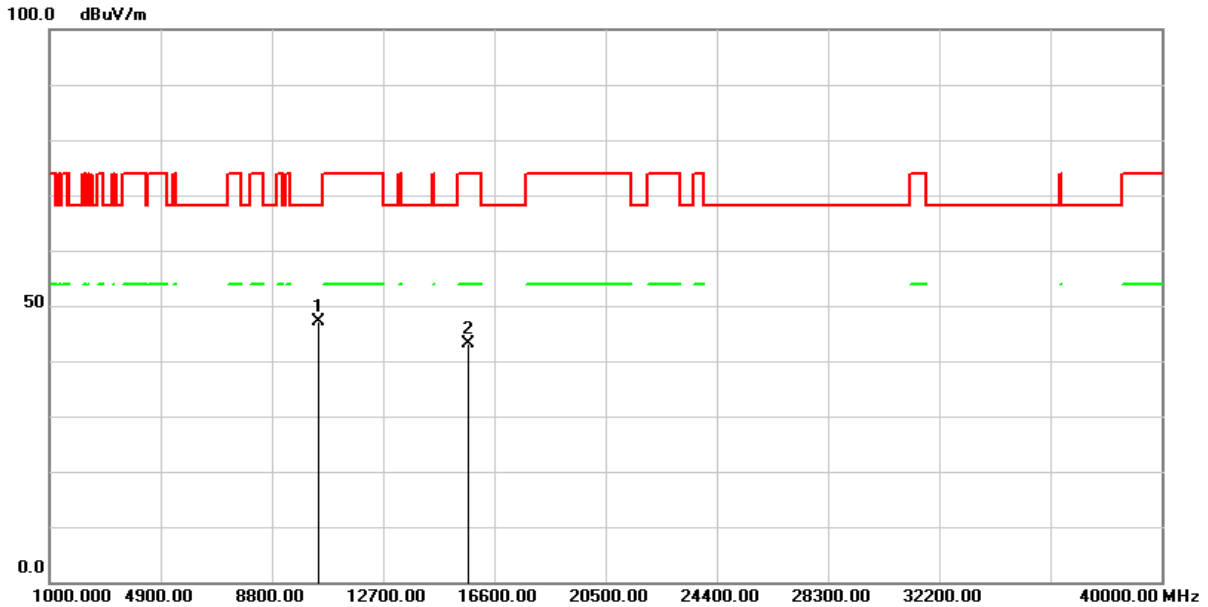

No.	Frequency (MHz)	Reading (dBuV/m)	Correct Factor (dB/m)	Result (dBuV/m)	Limit (dBuV/m)	Margin (dB)	Remark
1	10460.000	57.08	-9.94	47.14	68.20	-21.06	peak
2	15690.000	50.83	-7.81	43.02	74.00	-30.98	peak

Remark :

1. Correction Factor = Antenna factor + Cable loss – Amplifier gain
2. Result Value = Reading Level + Correct Factor
3. Margin Level = Result Value – Limit Value
4. The other emission levels were very low against the limit

Test Mode :	Transmit (802.11ac VHT40 MCS0)	Test Date :	2024/03/27
Test Channel :	CH46(5230MHz)	Temperature :	23.4 °C
Polarization :	Vertical	Relative Humidity :	53 %

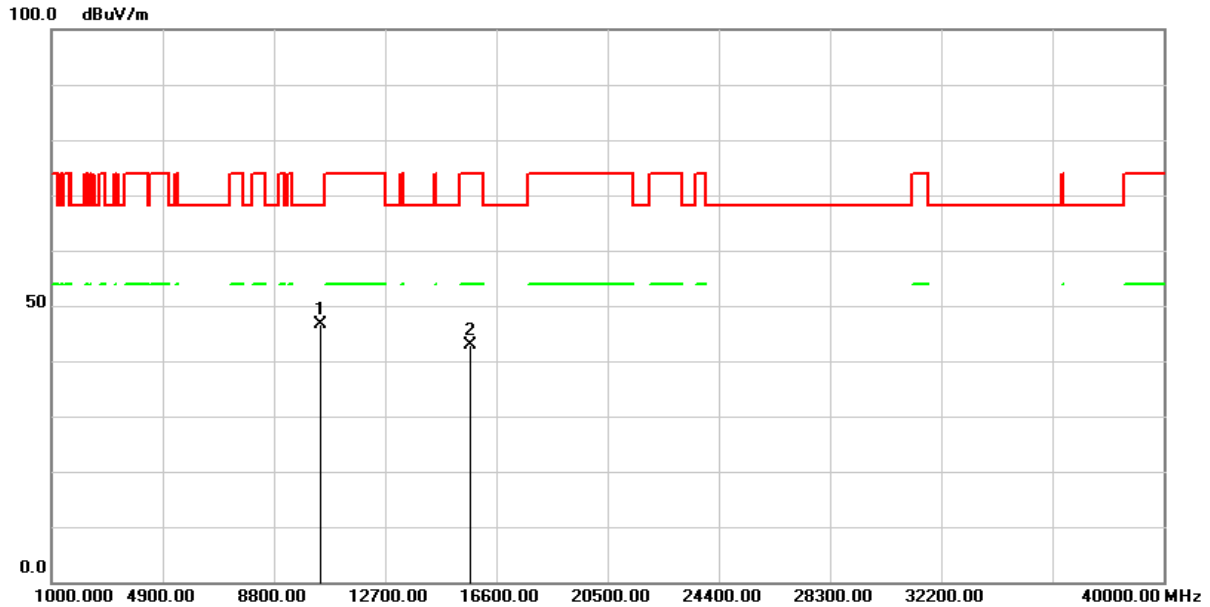

No.	Frequency (MHz)	Reading (dBuV/m)	Correct Factor (dB/m)	Result (dBuV/m)	Limit (dBuV/m)	Margin (dB)	Remark
1	10460.000	56.51	-9.94	46.57	68.20	-21.63	peak
2	15690.000	50.69	-7.81	42.88	74.00	-31.12	peak

Remark :

1. Correction Factor = Antenna factor + Cable loss – Amplifier gain
2. Result Value = Reading Level + Correct Factor
3. Margin Level = Result Value – Limit Value
4. The other emission levels were very low against the limit

Test Mode :	Transmit (802.11ac VHT40 MCS0)	Test Date :	2024/03/27
Test Channel :	CH151(5755MHz)	Temperature :	23.4 °C
Polarization :	Horizontal	Relative Humidity :	53 %

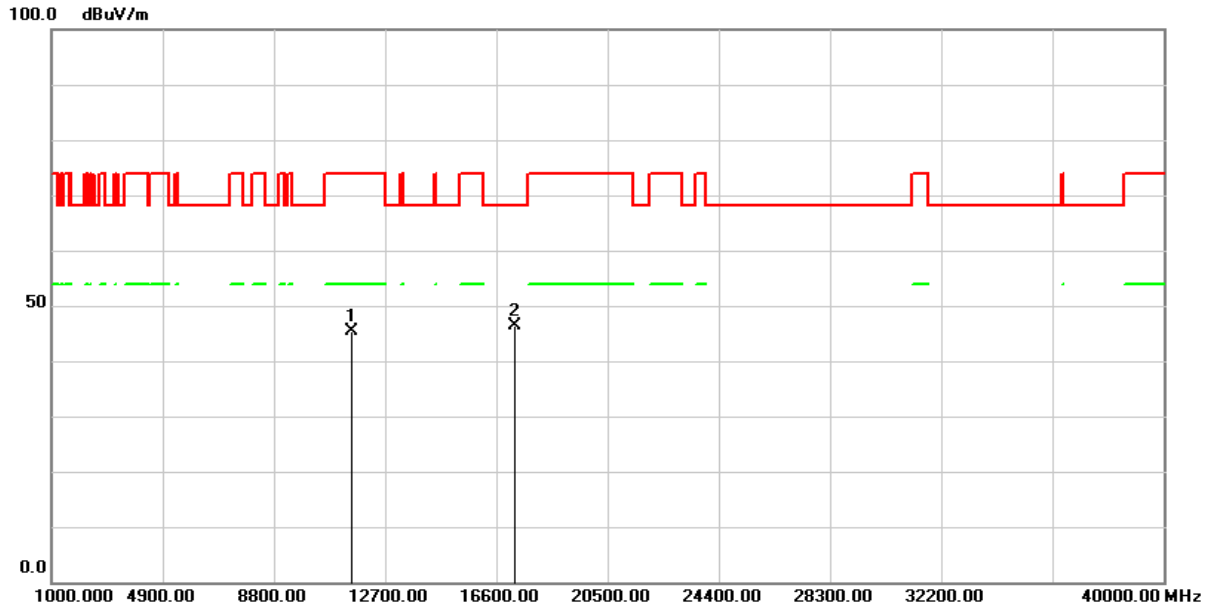

No.	Frequency (MHz)	Reading (dBuV/m)	Correct Factor (dB/m)	Result (dBuV/m)	Limit (dBuV/m)	Margin (dB)	Remark
1	11510.000	54.82	-9.40	45.42	74.00	-28.58	peak
2	17265.000	48.49	-2.19	46.30	68.20	-21.90	peak

Remark :

1. Correction Factor = Antenna factor + Cable loss – Amplifier gain
2. Result Value = Reading Level + Correct Factor
3. Margin Level = Result Value – Limit Value
4. The other emission levels were very low against the limit

Test Mode :	Transmit (802.11ac VHT40 MCS0)	Test Date :	2024/03/27
Test Channel :	CH151(5755MHz)	Temperature :	23.4 °C
Polarization :	Vertical	Relative Humidity :	53 %

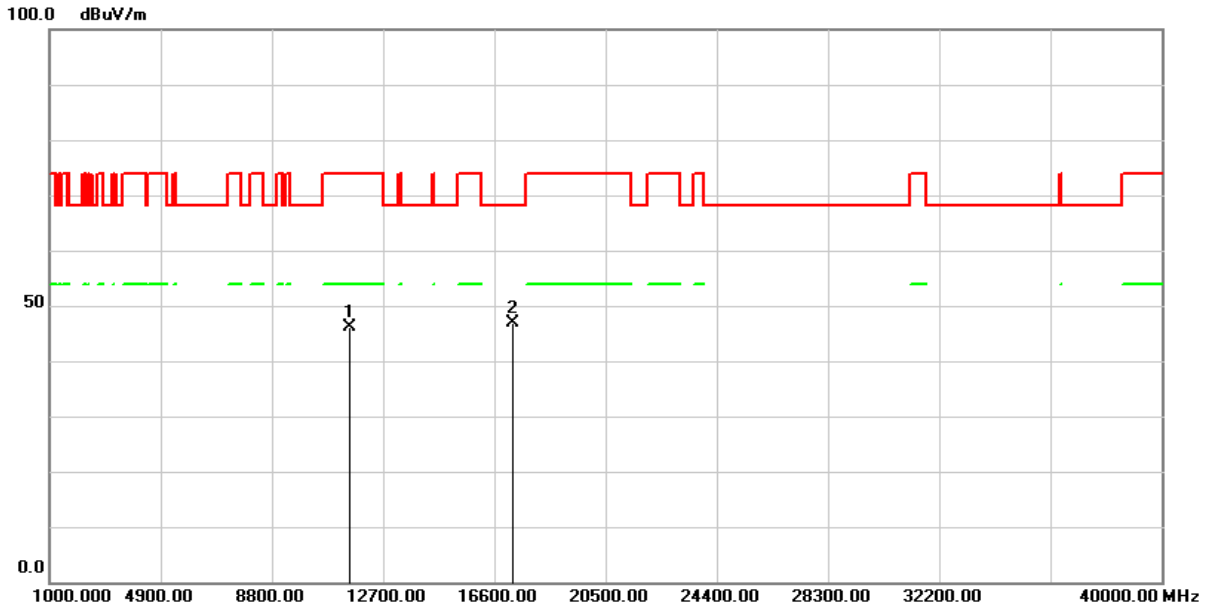

No.	Frequency (MHz)	Reading (dBuV/m)	Correct Factor (dB/m)	Result (dBuV/m)	Limit (dBuV/m)	Margin (dB)	Remark
1	11510.000	55.53	-9.40	46.13	74.00	-27.87	peak
2	17265.000	48.96	-2.19	46.77	68.20	-21.43	peak

Remark :

1. Correction Factor = Antenna factor + Cable loss – Amplifier gain
2. Result Value = Reading Level + Correct Factor
3. Margin Level = Result Value – Limit Value
4. The other emission levels were very low against the limit

Test Mode :	Transmit (802.11ac VHT40 MCS0)	Test Date :	2024/03/27
Test Channel :	CH159(5795MHz)	Temperature :	23.4 °C
Polarization :	Horizontal	Relative Humidity :	53 %

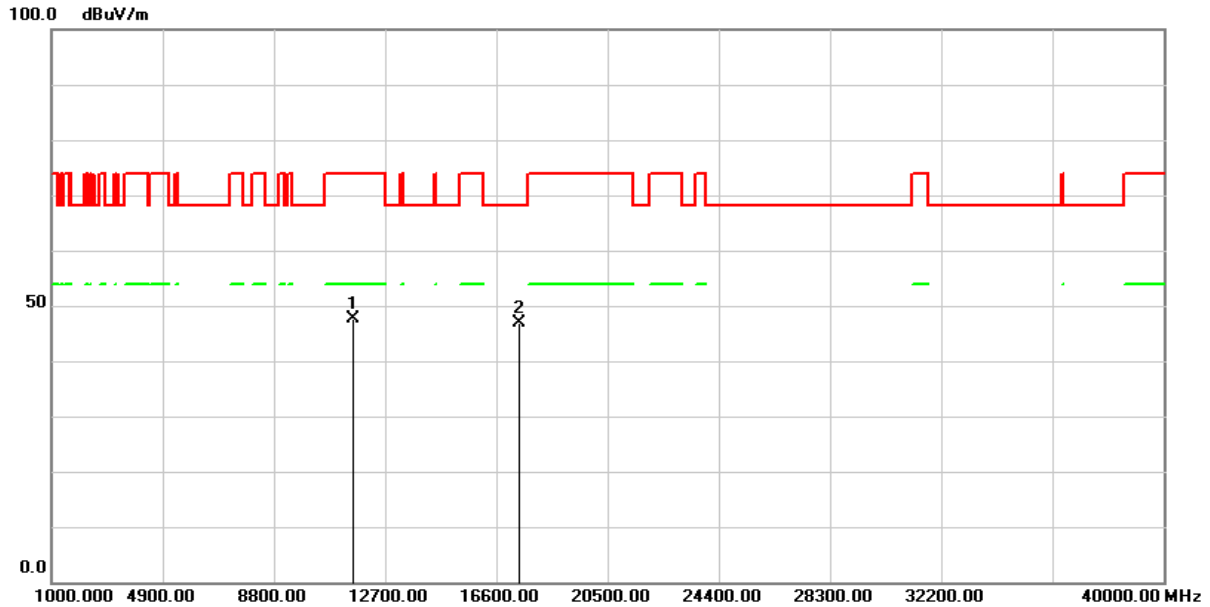

No.	Frequency (MHz)	Reading (dBuV/m)	Correct Factor (dB/m)	Result (dBuV/m)	Limit (dBuV/m)	Margin (dB)	Remark
1	11590.000	57.06	-9.48	47.58	74.00	-26.42	peak
2	17385.000	48.38	-1.42	46.96	68.20	-21.24	peak

Remark :

1. Correction Factor = Antenna factor + Cable loss – Amplifier gain
2. Result Value = Reading Level + Correct Factor
3. Margin Level = Result Value – Limit Value
4. The other emission levels were very low against the limit

Test Mode :	Transmit (802.11ac VHT40 MCS0)	Test Date :	2024/03/27
Test Channel :	CH159(5795MHz)	Temperature :	23.4 °C
Polarization :	Vertical	Relative Humidity :	53 %

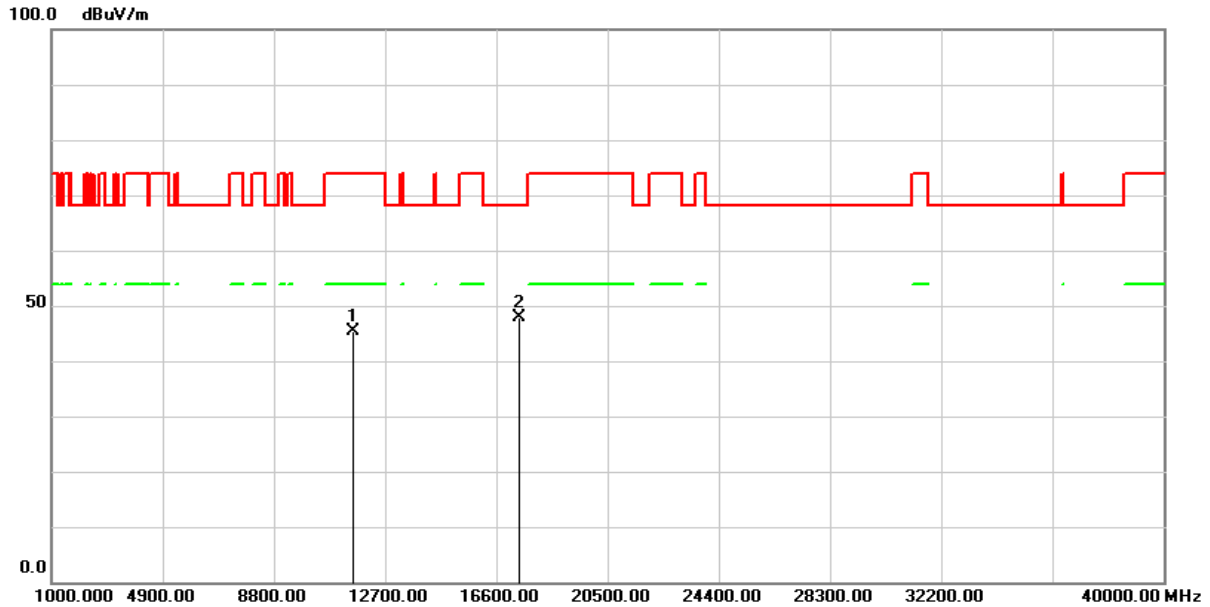

No.	Frequency (MHz)	Reading (dBuV/m)	Correct Factor (dB/m)	Result (dBuV/m)	Limit (dBuV/m)	Margin (dB)	Remark
1	11590.000	54.80	-9.48	45.32	74.00	-28.68	peak
2	17385.000	49.24	-1.42	47.82	68.20	-20.38	peak

Remark :

1. Correction Factor = Antenna factor + Cable loss – Amplifier gain
2. Result Value = Reading Level + Correct Factor
3. Margin Level = Result Value – Limit Value
4. The other emission levels were very low against the limit

Test Mode :	Transmit (802.11ac VHT80 MCS0)	Test Date :	2024/03/27
Test Channel :	CH42(5210MHz)	Temperature :	23.4 °C
Polarization :	Horizontal	Relative Humidity :	53 %

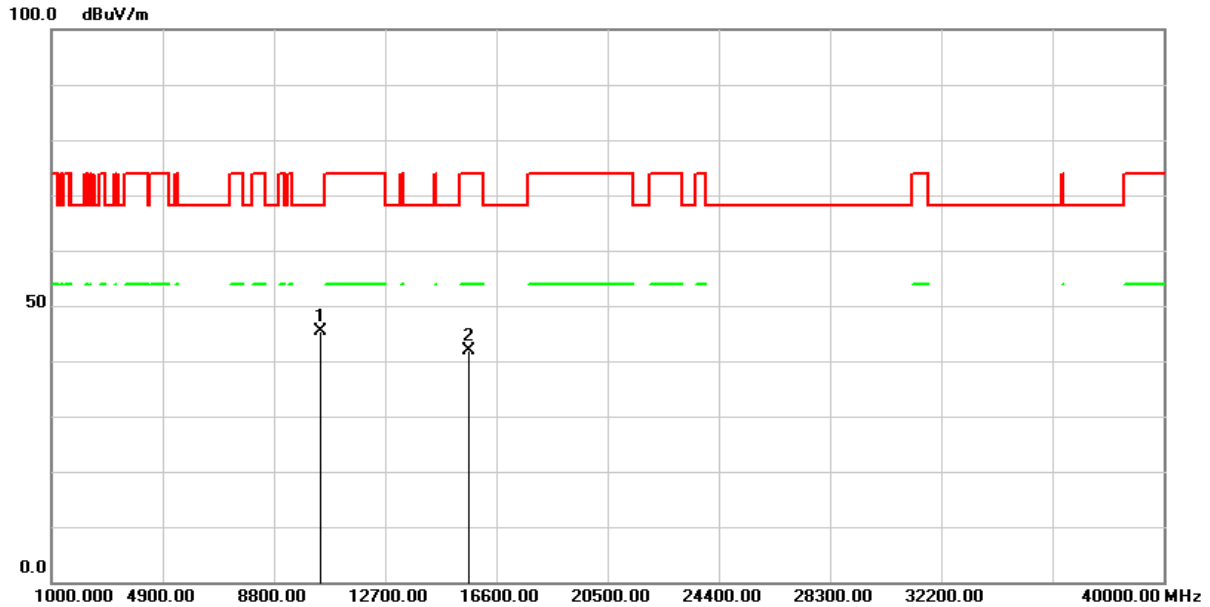

No.	Frequency (MHz)	Reading (dBuV/m)	Correct Factor (dB/m)	Result (dBuV/m)	Limit (dBuV/m)	Margin (dB)	Remark
1	10420.000	55.28	-9.94	45.34	68.20	-22.86	peak
2	15630.000	49.98	-7.98	42.00	74.00	-32.00	peak

Remark :

1. Correction Factor = Antenna factor + Cable loss – Amplifier gain
2. Result Value = Reading Level + Correct Factor
3. Margin Level = Result Value – Limit Value
4. The other emission levels were very low against the limit

Test Mode :	Transmit (802.11ac VHT80 MCS0)	Test Date :	2024/03/27
Test Channel :	CH42(5210MHz)	Temperature :	23.4 °C
Polarization :	Vertical	Relative Humidity :	53 %

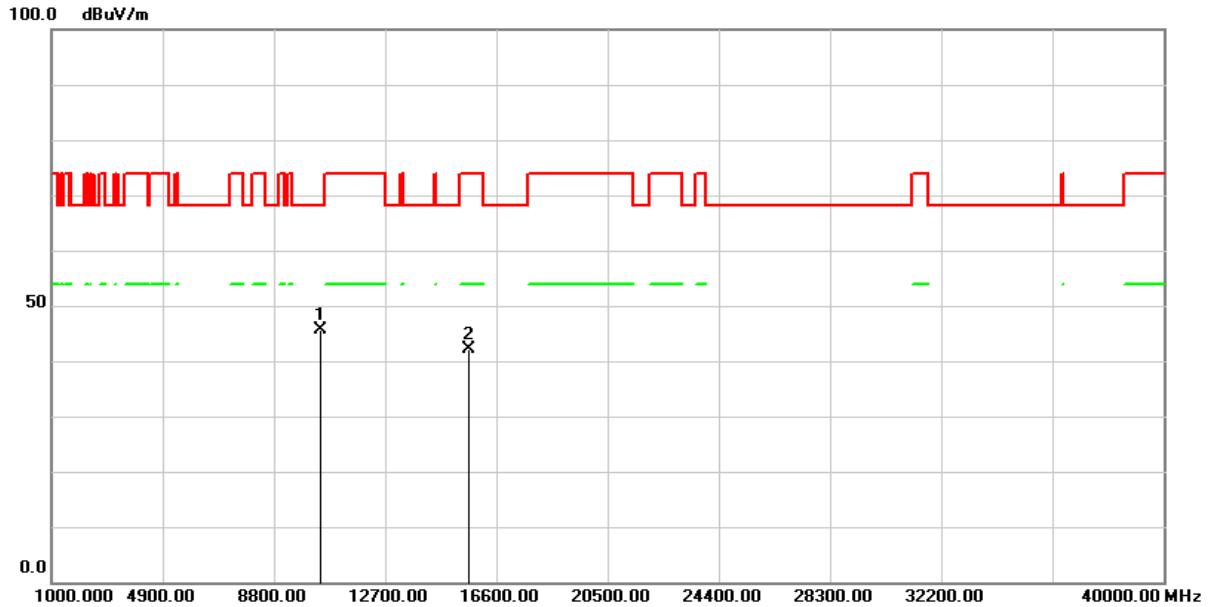

No.	Frequency (MHz)	Reading (dBuV/m)	Correct Factor (dB/m)	Result (dBuV/m)	Limit (dBuV/m)	Margin (dB)	Remark
1	10420.000	55.66	-9.94	45.72	68.20	-22.48	peak
2	15630.000	50.10	-7.98	42.12	74.00	-31.88	peak

Remark :

1. Correction Factor = Antenna factor + Cable loss – Amplifier gain
2. Result Value = Reading Level + Correct Factor
3. Margin Level = Result Value – Limit Value
4. The other emission levels were very low against the limit

Test Mode :	Transmit (802.11ac VHT80 MCS0)	Test Date :	2024/03/27
Test Channel :	CH155(5775MHz)	Temperature :	23.4 °C
Polarization :	Horizontal	Relative Humidity :	53 %

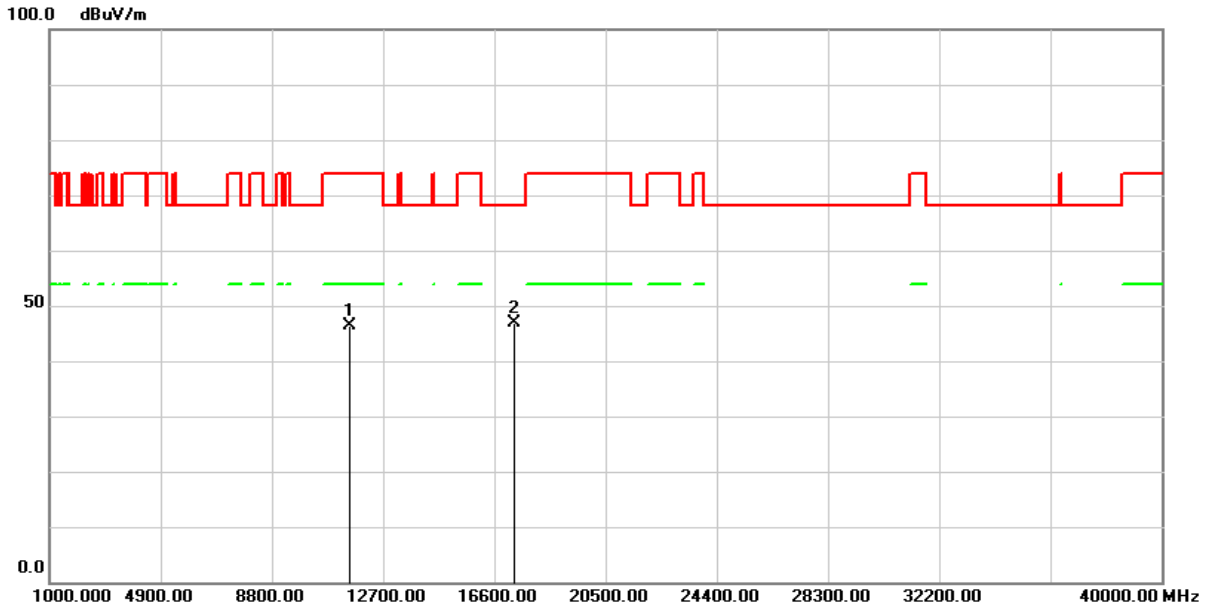

No.	Frequency (MHz)	Reading (dBuV/m)	Correct Factor (dB/m)	Result (dBuV/m)	Limit (dBuV/m)	Margin (dB)	Remark
1	11550.000	55.62	-9.32	46.30	74.00	-27.70	peak
2	17325.000	48.93	-1.95	46.98	68.20	-21.22	peak

Remark :

1. Correction Factor = Antenna factor + Cable loss – Amplifier gain
2. Result Value = Reading Level + Correct Factor
3. Margin Level = Result Value – Limit Value
4. The other emission levels were very low against the limit

Test Mode :	Transmit (802.11ac VHT80 MCS0)	Test Date :	2024/03/27
Test Channel :	CH155(5775MHz)	Temperature :	23.4 °C
Polarization :	Vertical	Relative Humidity :	53 %

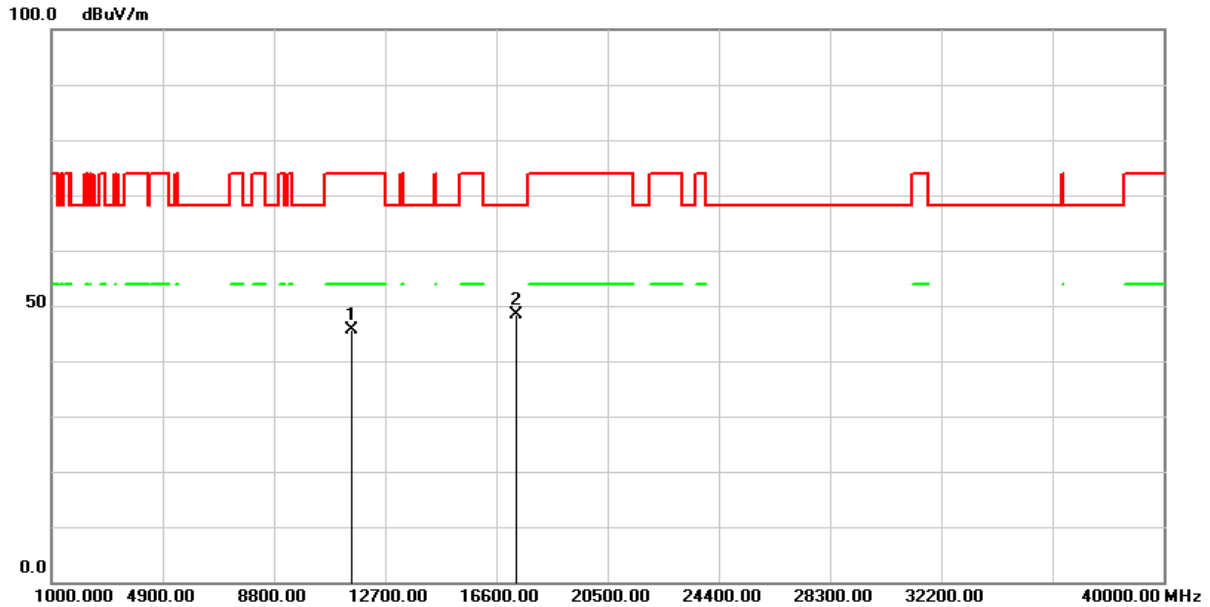

No.	Frequency (MHz)	Reading (dBuV/m)	Correct Factor (dB/m)	Result (dBuV/m)	Limit (dBuV/m)	Margin (dB)	Remark
1	11550.000	54.87	-9.32	45.55	74.00	-28.45	peak
2	17325.000	50.37	-1.95	48.42	68.20	-19.78	peak

Remark :

1. Correction Factor = Antenna factor + Cable loss – Amplifier gain
2. Result Value = Reading Level + Correct Factor
3. Margin Level = Result Value – Limit Value
4. The other emission levels were very low against the limit

Test Mode :	Transmit (802.11ax HE20 MCS0)	Test Date :	2024/03/27
Test Channel :	CH36(5180MHz)	Temperature :	23.4 °C
Polarization :	Horizontal	Relative Humidity :	53 %

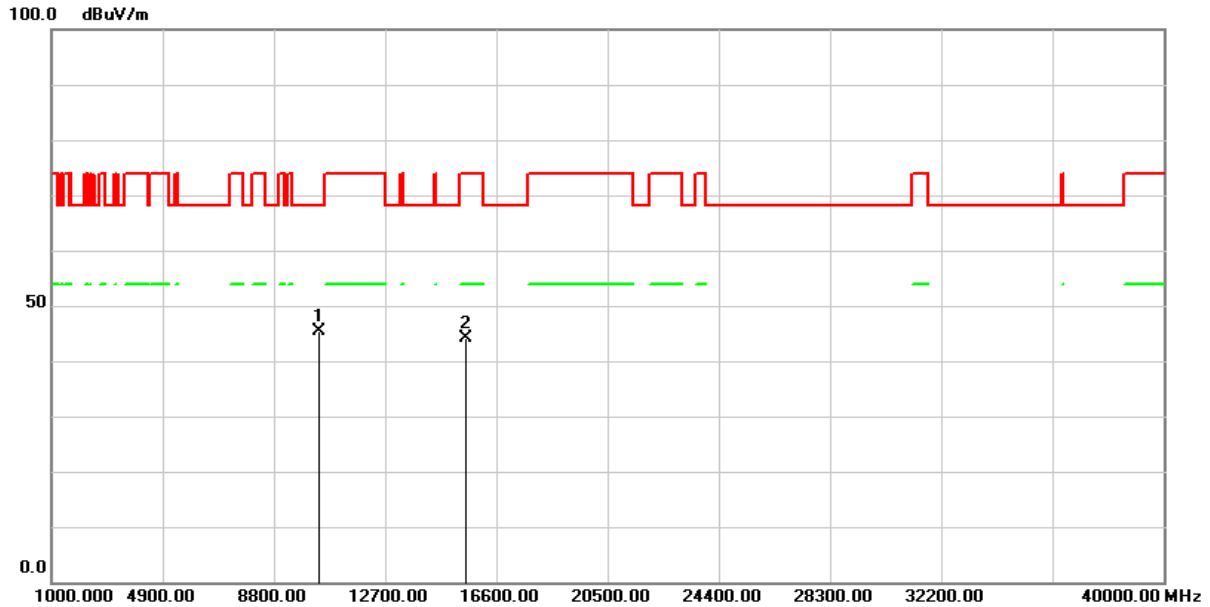

No.	Frequency (MHz)	Reading (dBuV/m)	Correct Factor (dB/m)	Result (dBuV/m)	Limit (dBuV/m)	Margin (dB)	Remark
1	10360.000	55.38	-10.05	45.33	68.20	-22.87	peak
2	15540.000	51.89	-7.80	44.09	74.00	-29.91	peak

Remark :

1. Correction Factor = Antenna factor + Cable loss – Amplifier gain
2. Result Value = Reading Level + Correct Factor
3. Margin Level = Result Value – Limit Value
4. The other emission levels were very low against the limit

Test Mode :	Transmit (802.11ax HE20 MCS0)	Test Date :	2024/03/27
Test Channel :	CH36(5180MHz)	Temperature :	23.4 °C
Polarization :	Vertical	Relative Humidity :	53 %

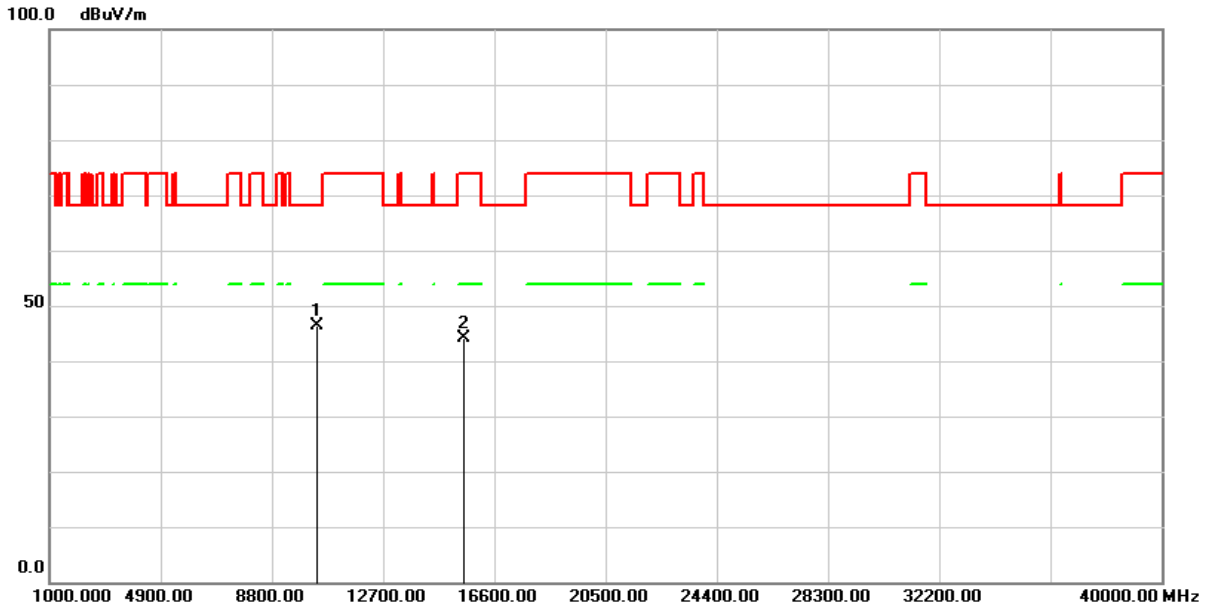

No.	Frequency (MHz)	Reading (dBuV/m)	Correct Factor (dB/m)	Result (dBuV/m)	Limit (dBuV/m)	Margin (dB)	Remark
1	10360.000	56.36	-10.05	46.31	68.20	-21.89	peak
2	15540.000	51.81	-7.80	44.01	74.00	-29.99	peak

Remark :

1. Correction Factor = Antenna factor + Cable loss – Amplifier gain
2. Result Value = Reading Level + Correct Factor
3. Margin Level = Result Value – Limit Value
4. The other emission levels were very low against the limit

Test Mode :	Transmit (802.11ax HE20 MCS0)	Test Date :	2024/03/27
Test Channel :	CH40(5200MHz)	Temperature :	23.4 °C
Polarization :	Horizontal	Relative Humidity :	53 %

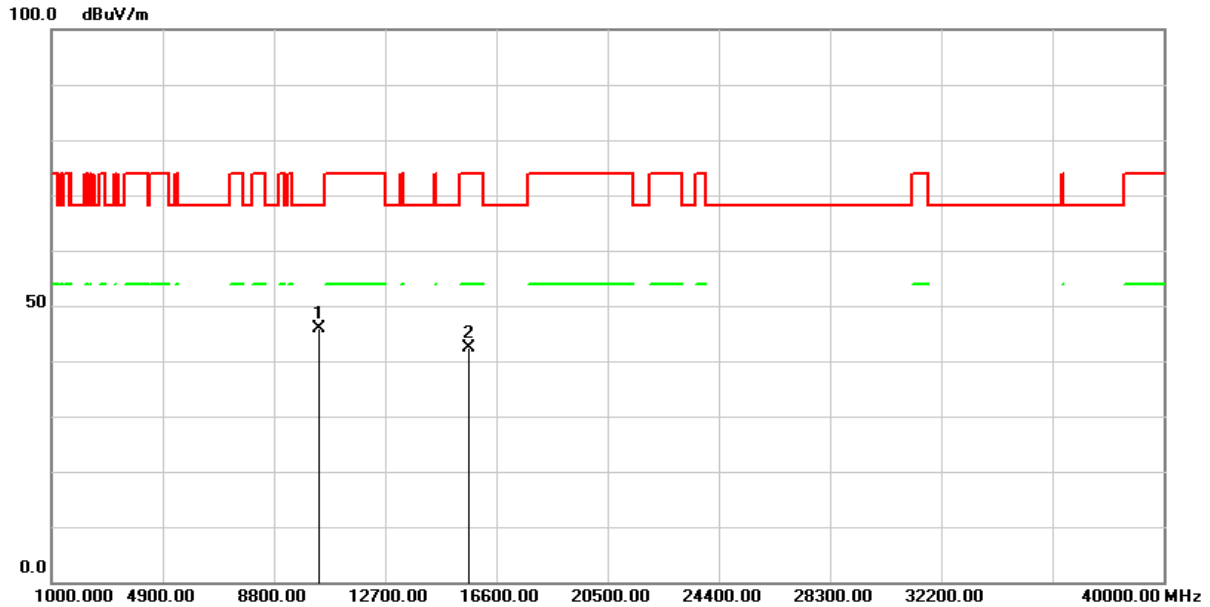

No.	Frequency (MHz)	Reading (dBuV/m)	Correct Factor (dB/m)	Result (dBuV/m)	Limit (dBuV/m)	Margin (dB)	Remark
1	10400.000	55.81	-9.95	45.86	68.20	-22.34	peak
2	15600.000	50.10	-7.79	42.31	74.00	-31.69	peak

Remark :

1. Correction Factor = Antenna factor + Cable loss – Amplifier gain
2. Result Value = Reading Level + Correct Factor
3. Margin Level = Result Value – Limit Value
4. The other emission levels were very low against the limit

Test Mode :	Transmit (802.11ax HE20 MCS0)	Test Date :	2024/03/27
Test Channel :	CH40(5200MHz)	Temperature :	23.4 °C
Polarization :	Vertical	Relative Humidity :	53 %

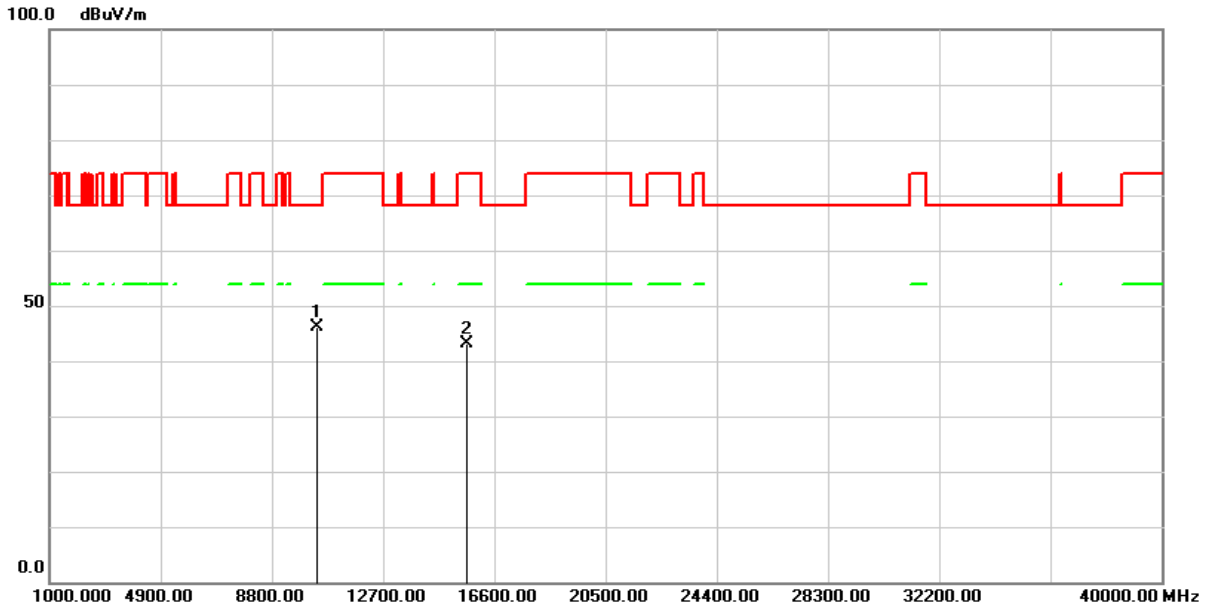

No.	Frequency (MHz)	Reading (dBuV/m)	Correct Factor (dB/m)	Result (dBuV/m)	Limit (dBuV/m)	Margin (dB)	Remark
1	10400.000	56.10	-9.95	46.15	68.20	-22.05	peak
2	15600.000	50.95	-7.79	43.16	74.00	-30.84	peak

Remark :

1. Correction Factor = Antenna factor + Cable loss – Amplifier gain
2. Result Value = Reading Level + Correct Factor
3. Margin Level = Result Value – Limit Value
4. The other emission levels were very low against the limit

Test Mode :	Transmit (802.11ax HE20 MCS0)	Test Date :	2024/03/27
Test Channel :	CH48(5240MHz)	Temperature :	23.4 °C
Polarization :	Horizontal	Relative Humidity :	53 %

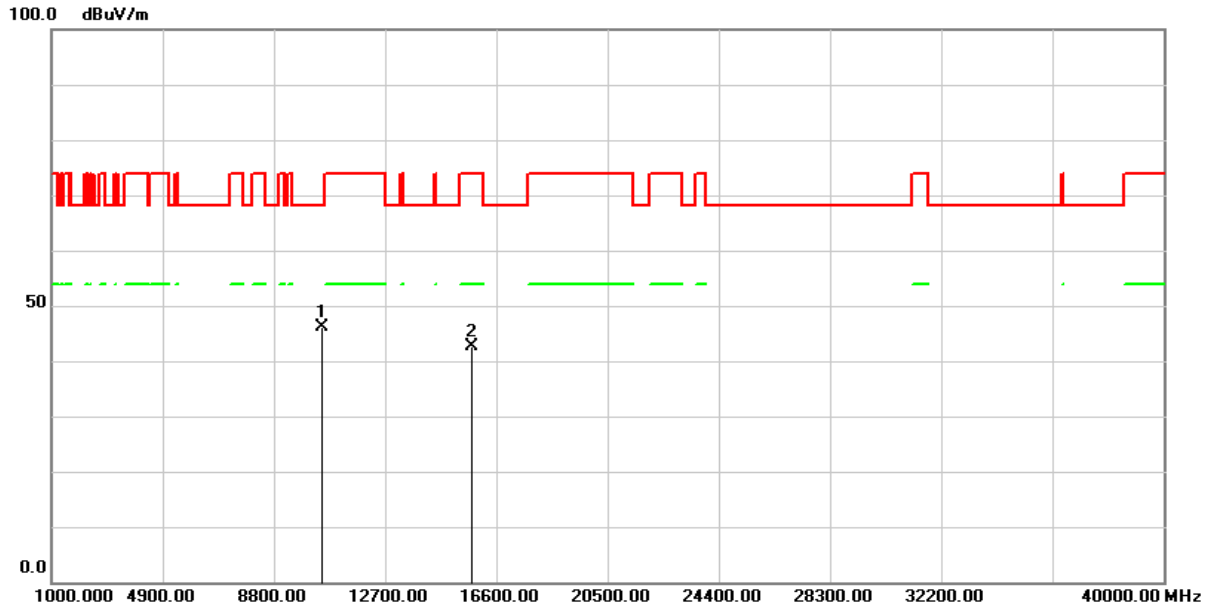

No.	Frequency (MHz)	Reading (dBuV/m)	Correct Factor (dB/m)	Result (dBuV/m)	Limit (dBuV/m)	Margin (dB)	Remark
1	10480.000	56.08	-9.97	46.11	68.20	-22.09	peak
2	15720.000	50.32	-7.62	42.70	74.00	-31.30	peak

Remark :

1. Correction Factor = Antenna factor + Cable loss – Amplifier gain
2. Result Value = Reading Level + Correct Factor
3. Margin Level = Result Value – Limit Value
4. The other emission levels were very low against the limit

Test Mode :	Transmit (802.11ax HE20 MCS0)	Test Date :	2024/03/28
Test Channel :	CH48(5240MHz)	Temperature :	23.4 °C
Polarization :	Vertical	Relative Humidity :	53 %

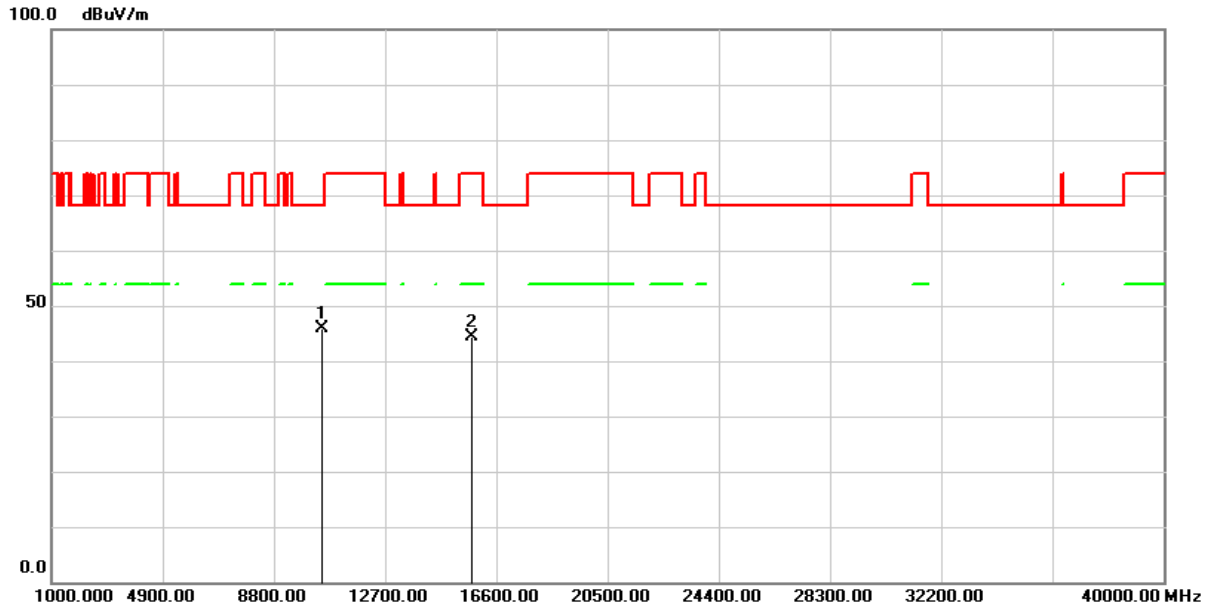

No.	Frequency (MHz)	Reading (dBuV/m)	Correct Factor (dB/m)	Result (dBuV/m)	Limit (dBuV/m)	Margin (dB)	Remark
1	10480.000	55.86	-9.97	45.89	68.20	-22.31	peak
2	15720.000	51.94	-7.62	44.32	74.00	-29.68	peak

Remark :

1. Correction Factor = Antenna factor + Cable loss – Amplifier gain
2. Result Value = Reading Level + Correct Factor
3. Margin Level = Result Value – Limit Value
4. The other emission levels were very low against the limit

Test Mode :	Transmit (802.11ax HE20 MCS0)	Test Date :	2024/03/28
Test Channel :	CH149(5745MHz)	Temperature :	23.4 °C
Polarization :	Horizontal	Relative Humidity :	53 %

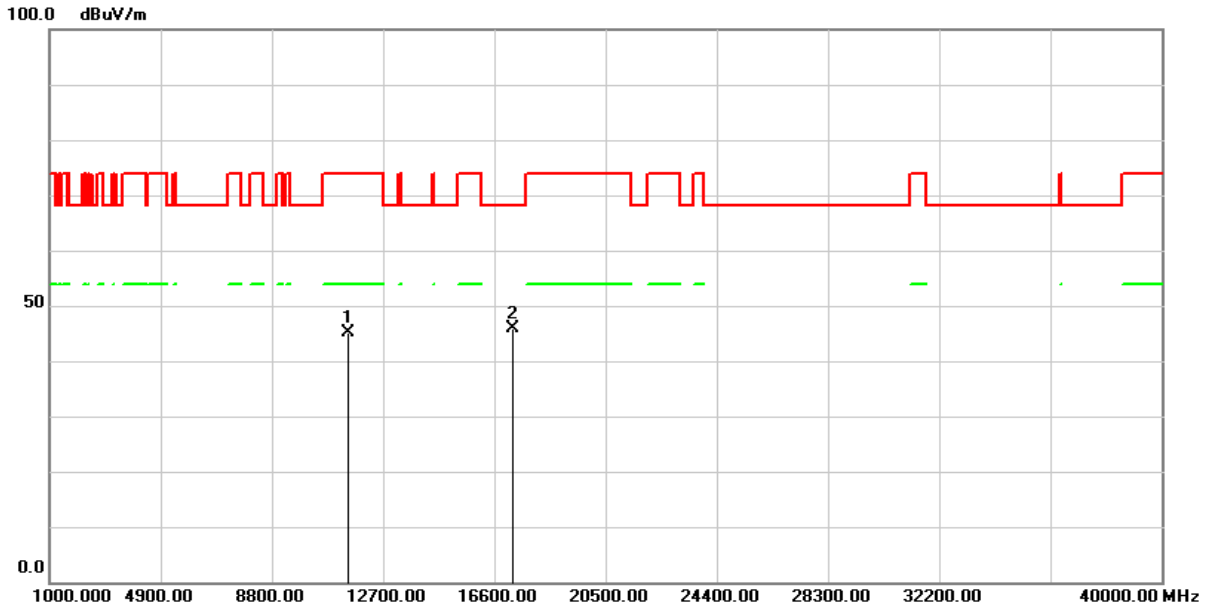

No.	Frequency (MHz)	Reading (dBuV/m)	Correct Factor (dB/m)	Result (dBuV/m)	Limit (dBuV/m)	Margin (dB)	Remark
1	11490.000	54.64	-9.45	45.19	74.00	-28.81	peak
2	17235.000	48.00	-2.24	45.76	68.20	-22.44	peak

Remark :

1. Correction Factor = Antenna factor + Cable loss – Amplifier gain
2. Result Value = Reading Level + Correct Factor
3. Margin Level = Result Value – Limit Value
4. The other emission levels were very low against the limit

Test Mode :	Transmit (802.11ax HE20 MCS0)	Test Date :	2024/03/28
Test Channel :	CH149(5745MHz)	Temperature :	23.4 °C
Polarization :	Vertical	Relative Humidity :	53 %

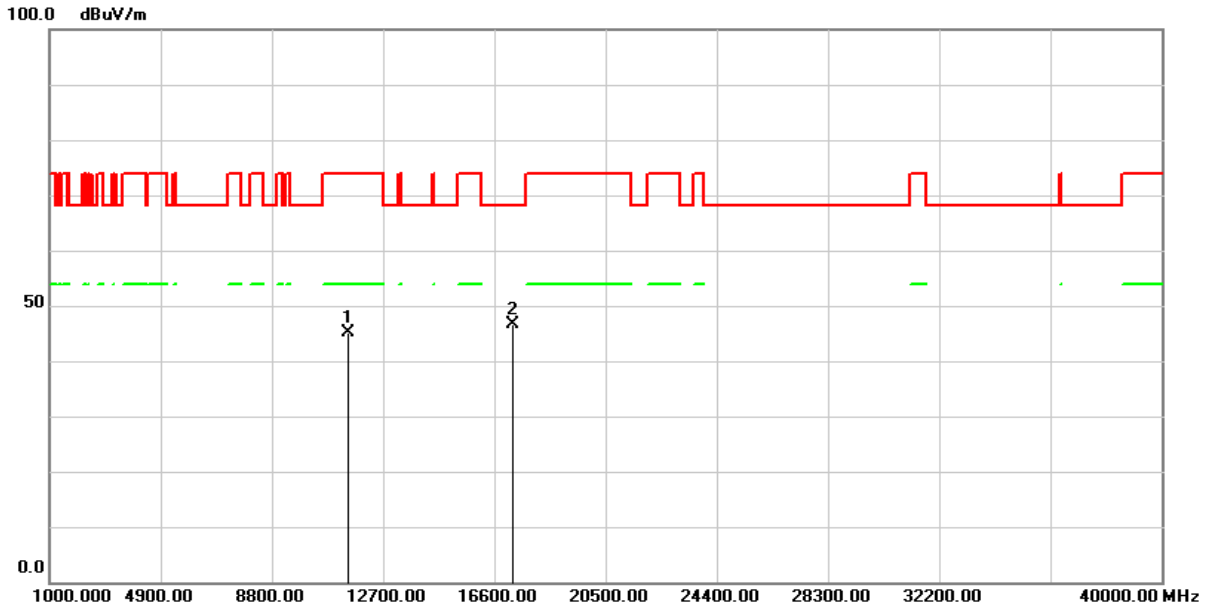

No.	Frequency (MHz)	Reading (dBuV/m)	Correct Factor (dB/m)	Result (dBuV/m)	Limit (dBuV/m)	Margin (dB)	Remark
1	11490.000	54.54	-9.45	45.09	74.00	-28.91	peak
2	17235.000	48.88	-2.24	46.64	68.20	-21.56	peak

Remark :

1. Correction Factor = Antenna factor + Cable loss – Amplifier gain
2. Result Value = Reading Level + Correct Factor
3. Margin Level = Result Value – Limit Value
4. The other emission levels were very low against the limit

Test Mode :	Transmit (802.11ax HE20 MCS0)	Test Date :	2024/03/28
Test Channel :	CH157(5785MHz)	Temperature :	23.4 °C
Polarization :	Horizontal	Relative Humidity :	53 %

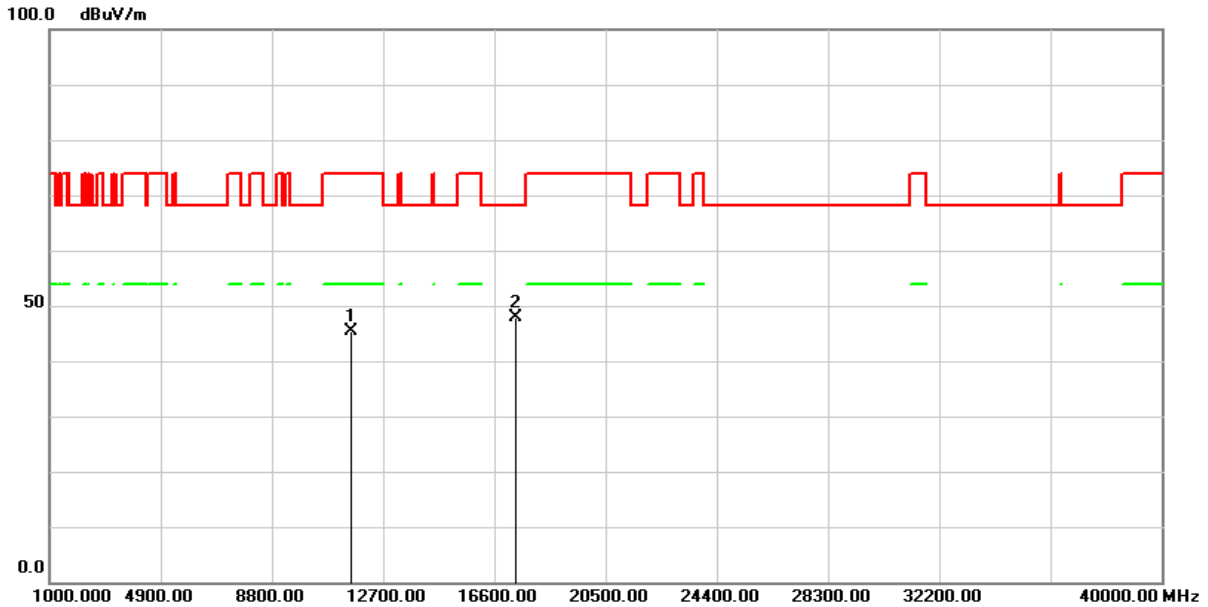

No.	Frequency (MHz)	Reading (dBuV/m)	Correct Factor (dB/m)	Result (dBuV/m)	Limit (dBuV/m)	Margin (dB)	Remark
1	11570.000	54.82	-9.40	45.42	74.00	-28.58	peak
2	17355.000	49.63	-1.65	47.98	68.20	-20.22	peak

Remark :

1. Correction Factor = Antenna factor + Cable loss – Amplifier gain
2. Result Value = Reading Level + Correct Factor
3. Margin Level = Result Value – Limit Value
4. The other emission levels were very low against the limit

Test Mode :	Transmit (802.11ax HE20 MCS0)	Test Date :	2024/03/28
Test Channel :	CH157(5785MHz)	Temperature :	23.4 °C
Polarization :	Vertical	Relative Humidity :	53 %

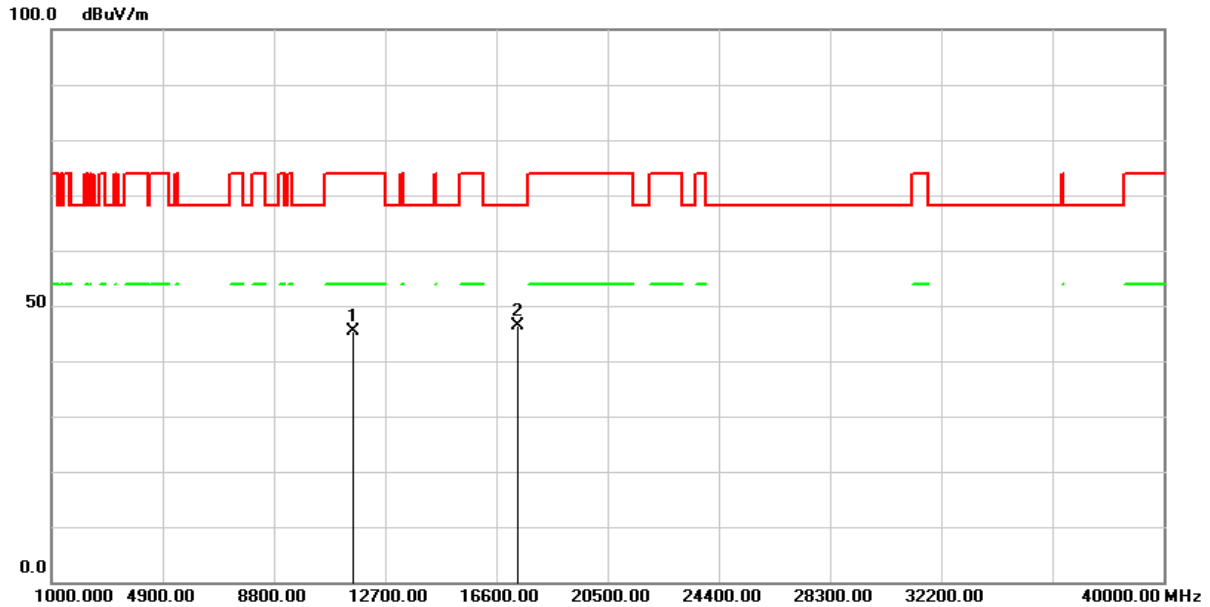

No.	Frequency (MHz)	Reading (dBuV/m)	Correct Factor (dB/m)	Result (dBuV/m)	Limit (dBuV/m)	Margin (dB)	Remark
1	11570.000	54.78	-9.40	45.38	74.00	-28.62	peak
2	17355.000	48.13	-1.65	46.48	68.20	-21.72	peak

Remark :

1. Correction Factor = Antenna factor + Cable loss – Amplifier gain
2. Result Value = Reading Level + Correct Factor
3. Margin Level = Result Value – Limit Value
4. The other emission levels were very low against the limit

Test Mode :	Transmit (802.11ax HE20 MCS0)	Test Date :	2024/03/28
Test Channel :	CH165(5825MHz)	Temperature :	23.4 °C
Polarization :	Horizontal	Relative Humidity :	53 %

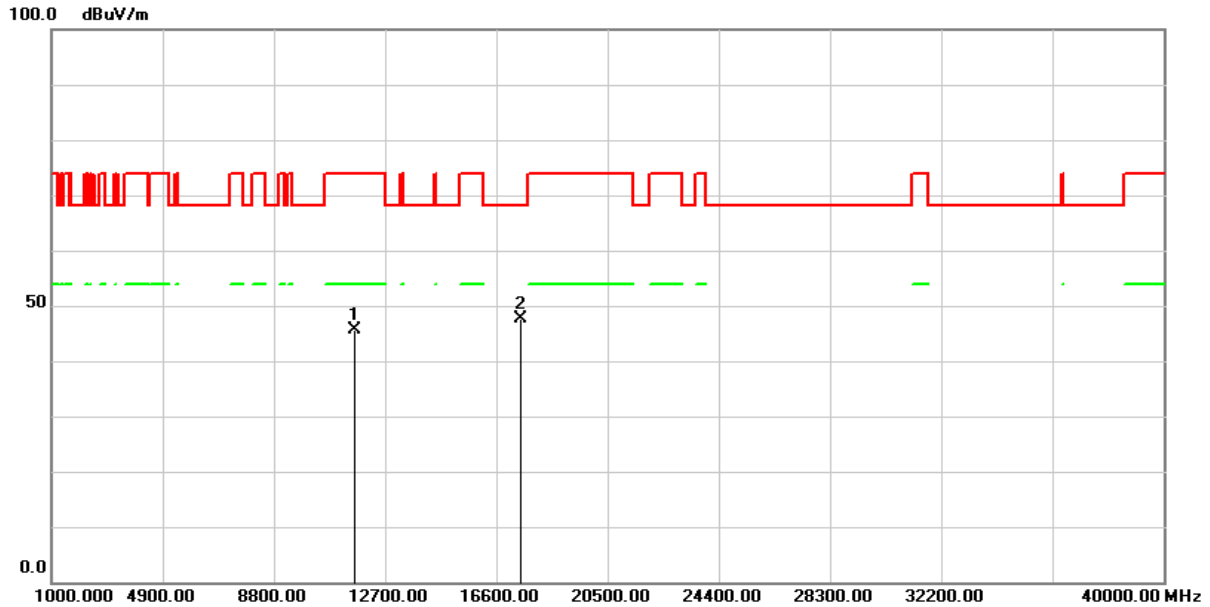

No.	Frequency (MHz)	Reading (dBuV/m)	Correct Factor (dB/m)	Result (dBuV/m)	Limit (dBuV/m)	Margin (dB)	Remark
1	11650.000	55.46	-9.82	45.64	74.00	-28.36	peak
2	17475.000	48.50	-0.85	47.65	68.20	-20.55	peak

Remark :

1. Correction Factor = Antenna factor + Cable loss – Amplifier gain
2. Result Value = Reading Level + Correct Factor
3. Margin Level = Result Value – Limit Value
4. The other emission levels were very low against the limit

Test Mode :	Transmit (802.11ax HE20 MCS0)	Test Date :	2024/03/28
Test Channel :	CH165(5825MHz)	Temperature :	23.4 °C
Polarization :	Vertical	Relative Humidity :	53 %

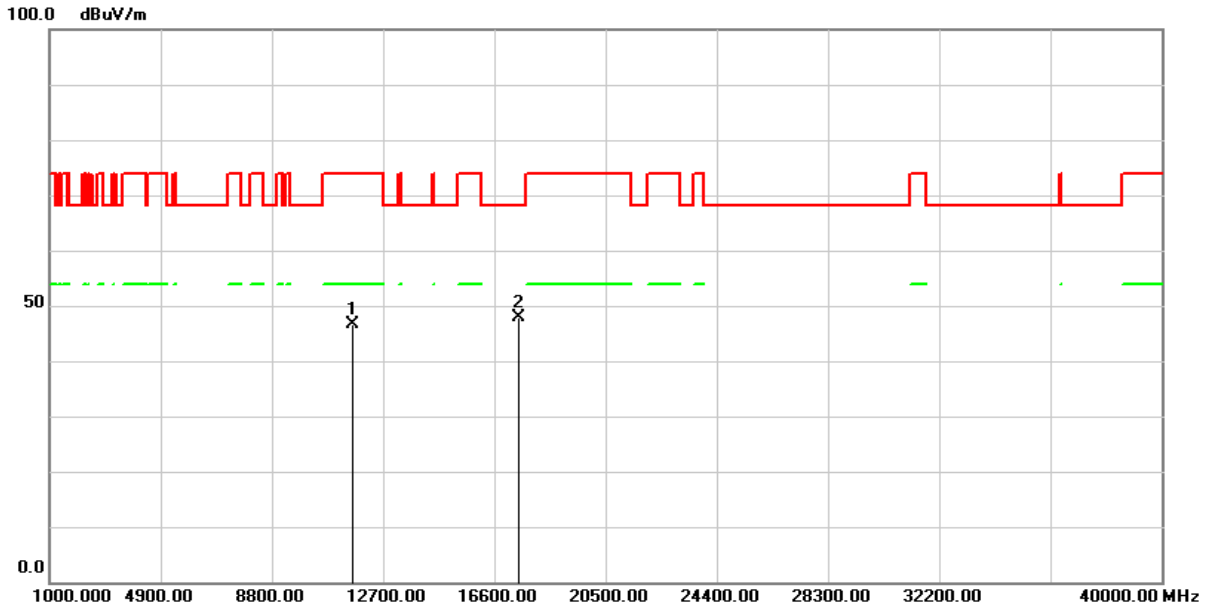

No.	Frequency (MHz)	Reading (dBuV/m)	Correct Factor (dB/m)	Result (dBuV/m)	Limit (dBuV/m)	Margin (dB)	Remark
1	11650.000	56.39	-9.82	46.57	74.00	-27.43	peak
2	17475.000	48.80	-0.85	47.95	68.20	-20.25	peak

Remark :

1. Correction Factor = Antenna factor + Cable loss – Amplifier gain
2. Result Value = Reading Level + Correct Factor
3. Margin Level = Result Value – Limit Value
4. The other emission levels were very low against the limit

Test Mode :	Transmit (802.11ax HE40 MCS0)	Test Date :	2024/03/28
Test Channel :	CH38(5190MHz)	Temperature :	23.4 °C
Polarization :	Horizontal	Relative Humidity :	53 %

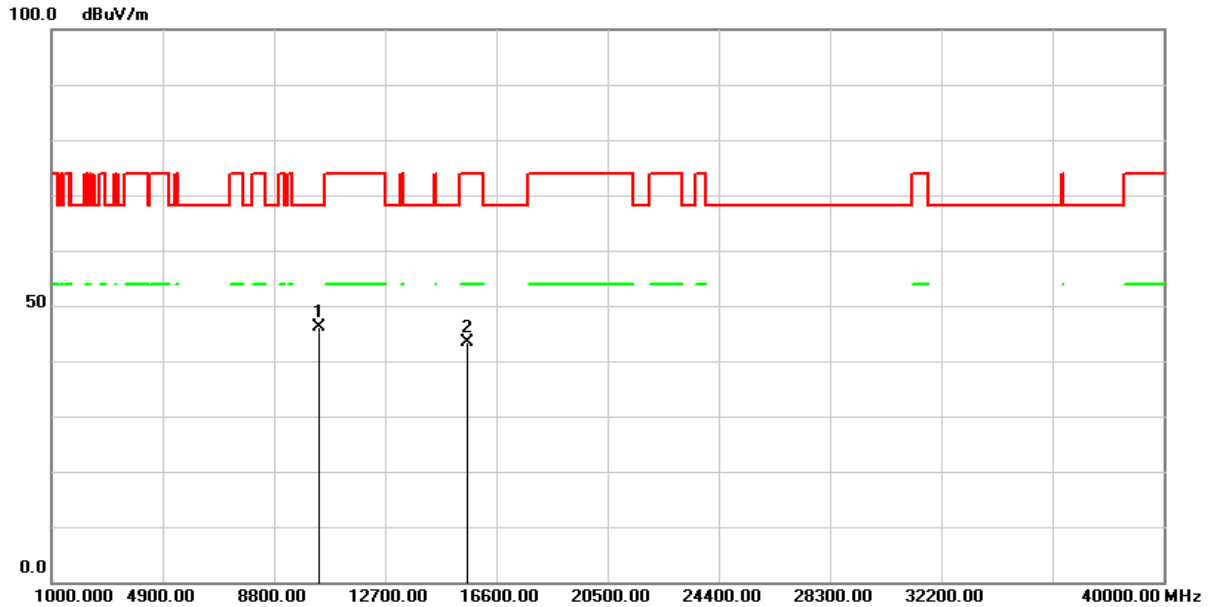

No.	Frequency (MHz)	Reading (dBuV/m)	Correct Factor (dB/m)	Result (dBuV/m)	Limit (dBuV/m)	Margin (dB)	Remark
1	10380.000	56.01	-10.00	46.01	68.20	-22.19	peak
2	15570.000	51.09	-7.79	43.30	74.00	-30.70	peak

Remark :

1. Correction Factor = Antenna factor + Cable loss – Amplifier gain
2. Result Value = Reading Level + Correct Factor
3. Margin Level = Result Value – Limit Value
4. The other emission levels were very low against the limit

Test Mode :	Transmit (802.11ax HE40 MCS0)	Test Date :	2024/03/28
Test Channel :	CH38(5190MHz)	Temperature :	23.4 °C
Polarization :	Vertical	Relative Humidity :	53 %

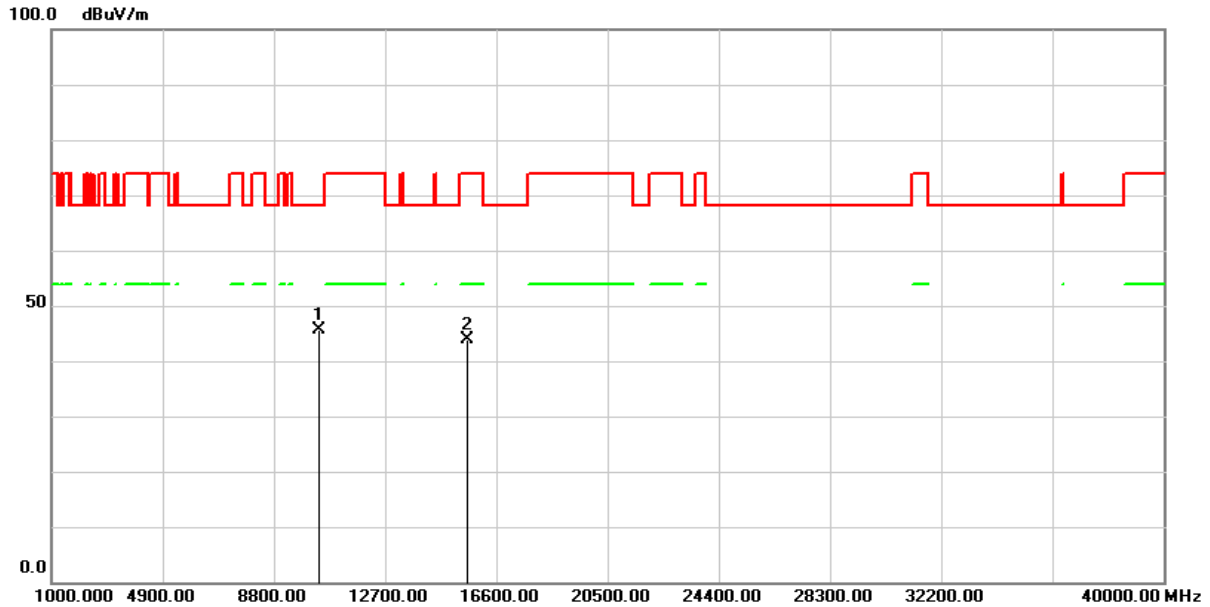

No.	Frequency (MHz)	Reading (dBuV/m)	Correct Factor (dB/m)	Result (dBuV/m)	Limit (dBuV/m)	Margin (dB)	Remark
1	10380.000	55.63	-10.00	45.63	68.20	-22.57	peak
2	15570.000	51.61	-7.79	43.82	74.00	-30.18	peak

Remark :

1. Correction Factor = Antenna factor + Cable loss – Amplifier gain
2. Result Value = Reading Level + Correct Factor
3. Margin Level = Result Value – Limit Value
4. The other emission levels were very low against the limit

Test Mode :	Transmit (802.11ax HE40 MCS0)	Test Date :	2024/03/28
Test Channel :	CH46(5230MHz)	Temperature :	23.4 °C
Polarization :	Horizontal	Relative Humidity :	53 %

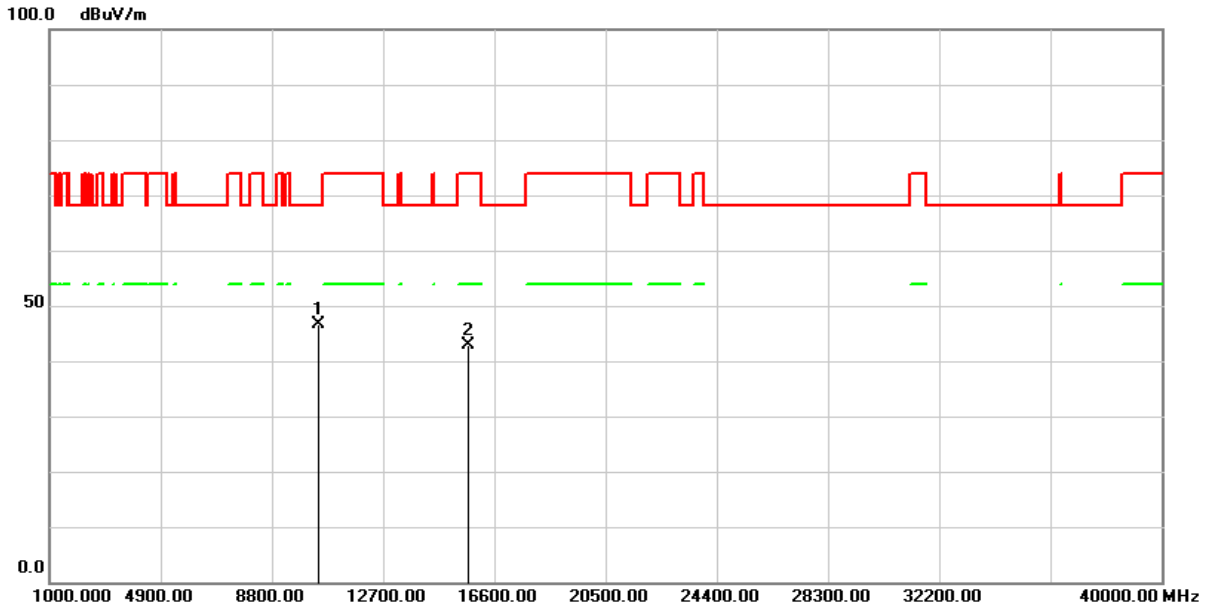

No.	Frequency (MHz)	Reading (dBuV/m)	Correct Factor (dB/m)	Result (dBuV/m)	Limit (dBuV/m)	Margin (dB)	Remark
1	10460.000	56.60	-9.94	46.66	68.20	-21.54	peak
2	15690.000	50.72	-7.81	42.91	74.00	-31.09	peak

Remark :

1. Correction Factor = Antenna factor + Cable loss – Amplifier gain
2. Result Value = Reading Level + Correct Factor
3. Margin Level = Result Value – Limit Value
4. The other emission levels were very low against the limit

Test Mode :	Transmit (802.11ax HE40 MCS0)	Test Date :	2024/03/28
Test Channel :	CH46(5230MHz)	Temperature :	23.4 °C
Polarization :	Vertical	Relative Humidity :	53 %

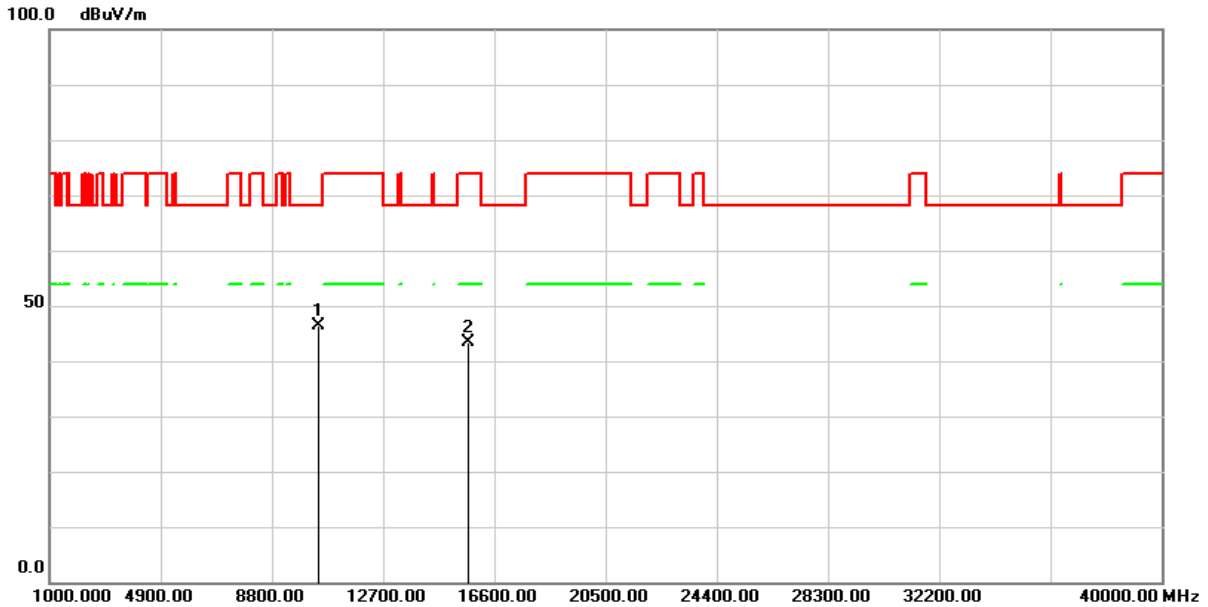

No.	Frequency (MHz)	Reading (dBuV/m)	Correct Factor (dB/m)	Result (dBuV/m)	Limit (dBuV/m)	Margin (dB)	Remark
1	10460.000	56.25	-9.94	46.31	68.20	-21.89	peak
2	15690.000	51.19	-7.81	43.38	74.00	-30.62	peak

Remark :

1. Correction Factor = Antenna factor + Cable loss – Amplifier gain
2. Result Value = Reading Level + Correct Factor
3. Margin Level = Result Value – Limit Value
4. The other emission levels were very low against the limit

Test Mode :	Transmit (802.11ax HE40 MCS0)	Test Date :	2024/03/28
Test Channel :	CH151(5755MHz)	Temperature :	23.4 °C
Polarization :	Horizontal	Relative Humidity :	53 %

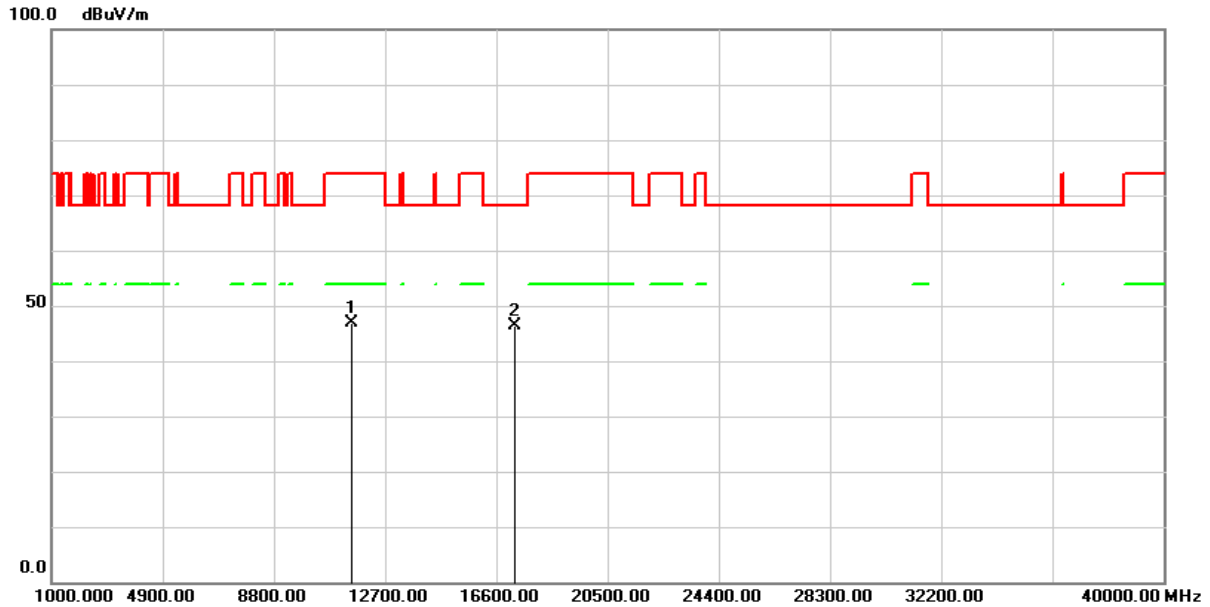

No.	Frequency (MHz)	Reading (dBuV/m)	Correct Factor (dB/m)	Result (dBuV/m)	Limit (dBuV/m)	Margin (dB)	Remark
1	11510.000	56.38	-9.40	46.98	74.00	-27.02	peak
2	17265.000	48.60	-2.19	46.41	68.20	-21.79	peak

Remark :

1. Correction Factor = Antenna factor + Cable loss – Amplifier gain
2. Result Value = Reading Level + Correct Factor
3. Margin Level = Result Value – Limit Value
4. The other emission levels were very low against the limit

Test Mode :	Transmit (802.11ax HE40 MCS0)	Test Date :	2024/03/28
Test Channel :	CH151(5755MHz)	Temperature :	23.4 °C
Polarization :	Vertical	Relative Humidity :	53 %

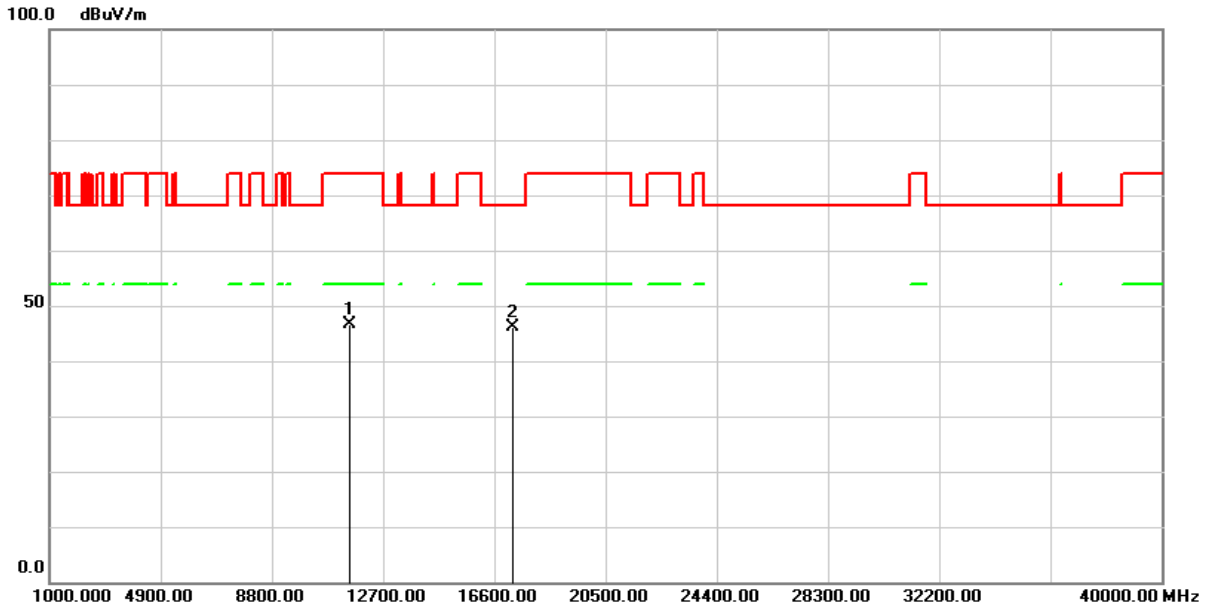

No.	Frequency (MHz)	Reading (dBuV/m)	Correct Factor (dB/m)	Result (dBuV/m)	Limit (dBuV/m)	Margin (dB)	Remark
1	11510.000	55.97	-9.40	46.57	74.00	-27.43	peak
2	17265.000	48.43	-2.19	46.24	68.20	-21.96	peak

Remark :

1. Correction Factor = Antenna factor + Cable loss – Amplifier gain
2. Result Value = Reading Level + Correct Factor
3. Margin Level = Result Value – Limit Value
4. The other emission levels were very low against the limit

Test Mode :	Transmit (802.11ax HE40 MCS0)	Test Date :	2024/03/28
Test Channel :	CH159(5795MHz)	Temperature :	23.4 °C
Polarization :	Horizontal	Relative Humidity :	53 %

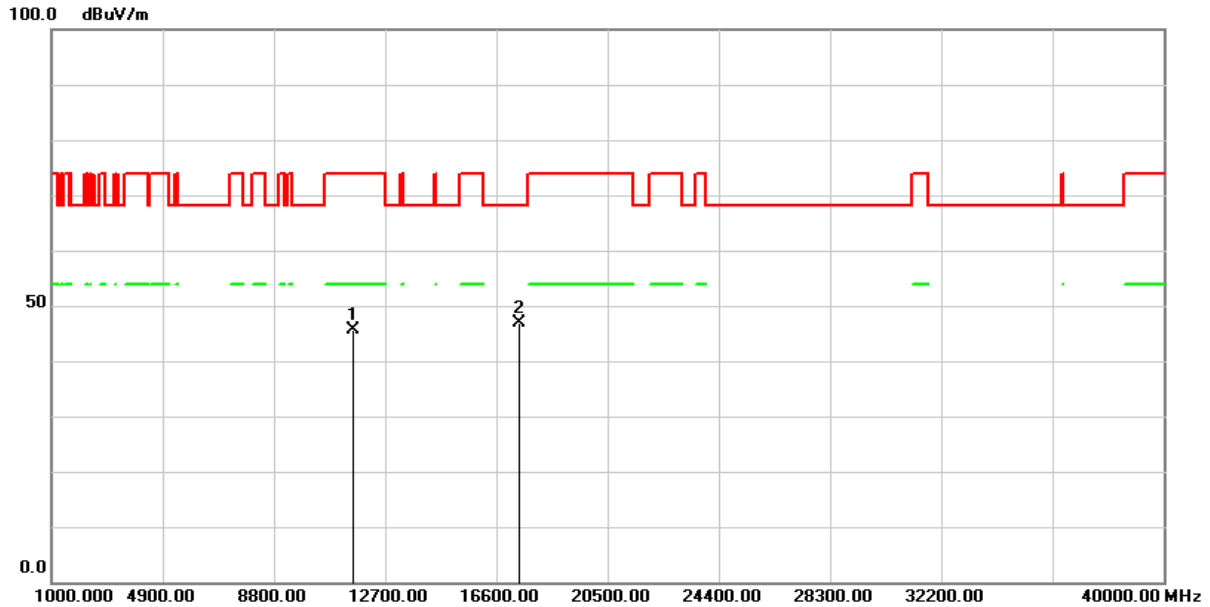

No.	Frequency (MHz)	Reading (dBuV/m)	Correct Factor (dB/m)	Result (dBuV/m)	Limit (dBuV/m)	Margin (dB)	Remark
1	11590.000	55.13	-9.48	45.65	74.00	-28.35	peak
2	17385.000	48.36	-1.42	46.94	68.20	-21.26	peak

Remark :

1. Correction Factor = Antenna factor + Cable loss – Amplifier gain
2. Result Value = Reading Level + Correct Factor
3. Margin Level = Result Value – Limit Value
4. The other emission levels were very low against the limit

Test Mode :	Transmit (802.11ax HE40 MCS0)	Test Date :	2024/03/28
Test Channel :	CH159(5795MHz)	Temperature :	23.4 °C
Polarization :	Vertical	Relative Humidity :	53 %

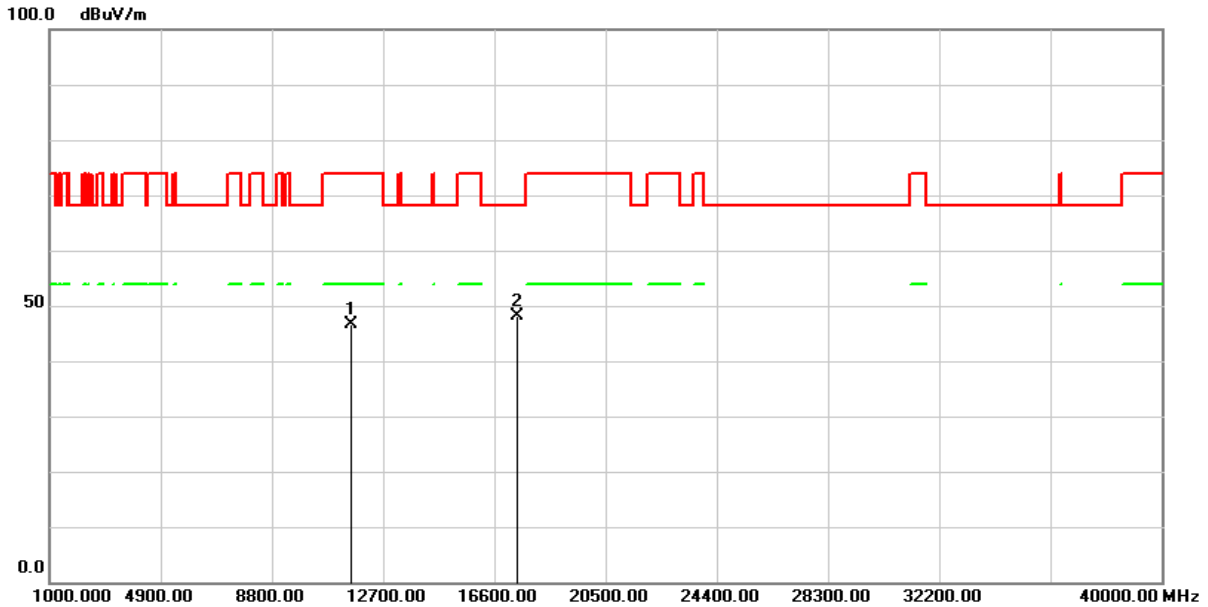

No.	Frequency (MHz)	Reading (dBuV/m)	Correct Factor (dB/m)	Result (dBuV/m)	Limit (dBuV/m)	Margin (dB)	Remark
1	11590.000	56.13	-9.48	46.65	74.00	-27.35	peak
2	17385.000	49.47	-1.42	48.05	68.20	-20.15	peak

Remark :

1. Correction Factor = Antenna factor + Cable loss – Amplifier gain
2. Result Value = Reading Level + Correct Factor
3. Margin Level = Result Value – Limit Value
4. The other emission levels were very low against the limit

Test Mode :	Transmit (802.11ax HE80 MCS0)	Test Date :	2024/03/28
Test Channel :	CH42(5210MHz)	Temperature :	23.4 °C
Polarization :	Horizontal	Relative Humidity :	53 %

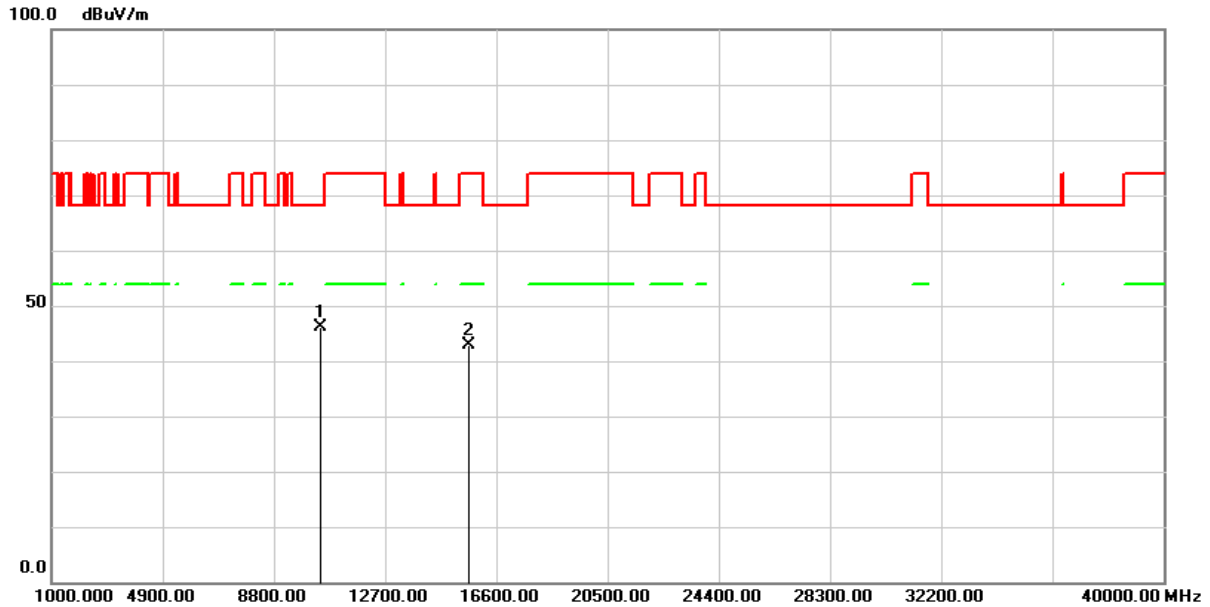

No.	Frequency (MHz)	Reading (dBuV/m)	Correct Factor (dB/m)	Result (dBuV/m)	Limit (dBuV/m)	Margin (dB)	Remark
1	10420.000	56.09	-9.94	46.15	68.20	-22.05	peak
2	15630.000	50.80	-7.98	42.82	74.00	-31.18	peak

Remark :

1. Correction Factor = Antenna factor + Cable loss – Amplifier gain
2. Result Value = Reading Level + Correct Factor
3. Margin Level = Result Value – Limit Value
4. The other emission levels were very low against the limit

Test Mode :	Transmit (802.11ax HE80 MCS0)	Test Date :	2024/03/28
Test Channel :	CH42(5210MHz)	Temperature :	23.4 °C
Polarization :	Vertical	Relative Humidity :	53 %

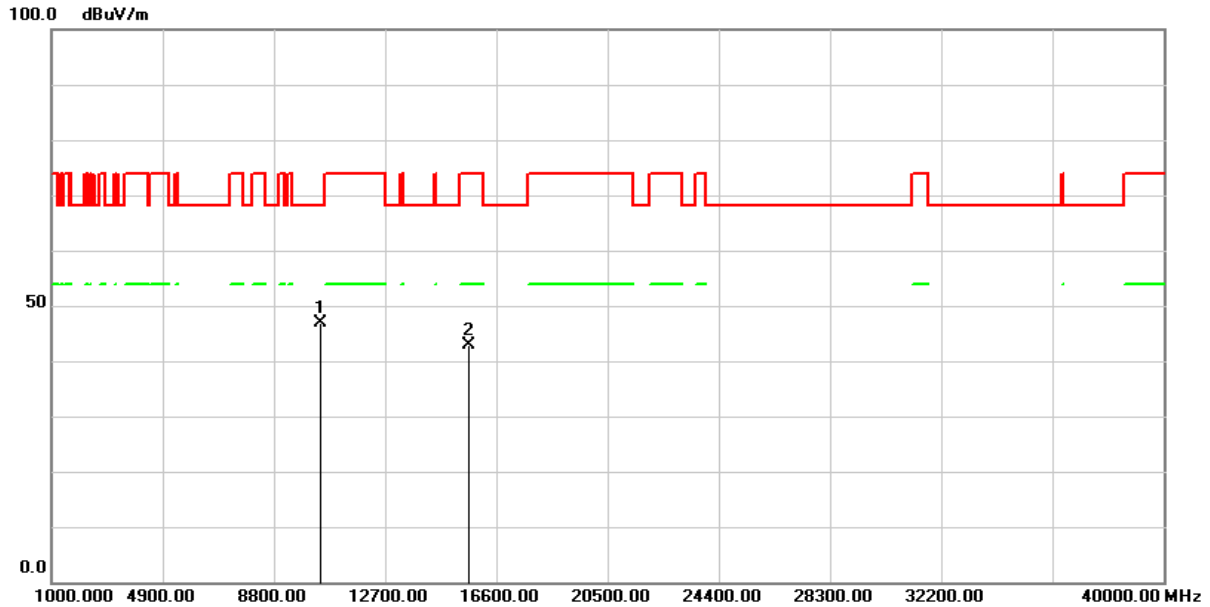

No.	Frequency (MHz)	Reading (dBuV/m)	Correct Factor (dB/m)	Result (dBuV/m)	Limit (dBuV/m)	Margin (dB)	Remark
1	10420.000	56.91	-9.94	46.97	68.20	-21.23	peak
2	15630.000	50.75	-7.98	42.77	74.00	-31.23	peak

Remark :

1. Correction Factor = Antenna factor + Cable loss – Amplifier gain
2. Result Value = Reading Level + Correct Factor
3. Margin Level = Result Value – Limit Value
4. The other emission levels were very low against the limit

Test Mode :	Transmit (802.11ax HE80 MCS0)	Test Date :	2024/03/28
Test Channel :	CH155(5775MHz)	Temperature :	23.4 °C
Polarization :	Horizontal	Relative Humidity :	53 %

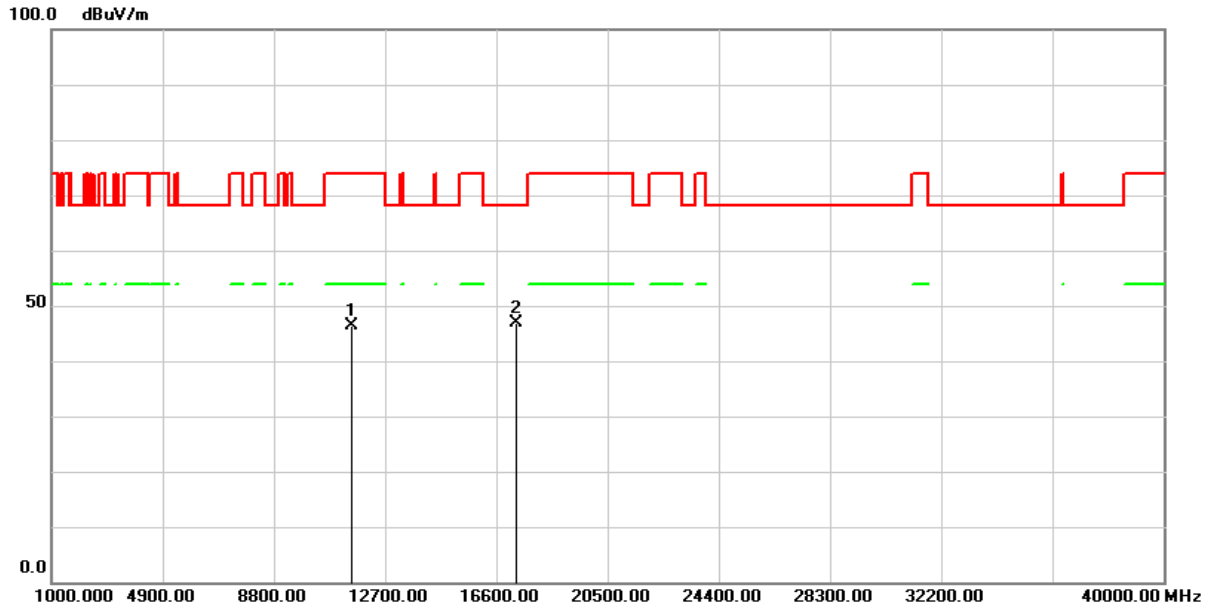

No.	Frequency (MHz)	Reading (dBuV/m)	Correct Factor (dB/m)	Result (dBuV/m)	Limit (dBuV/m)	Margin (dB)	Remark
1	11550.000	55.60	-9.32	46.28	74.00	-27.72	peak
2	17325.000	48.73	-1.95	46.78	68.20	-21.42	peak

Remark :

1. Correction Factor = Antenna factor + Cable loss – Amplifier gain
2. Result Value = Reading Level + Correct Factor
3. Margin Level = Result Value – Limit Value
4. The other emission levels were very low against the limit

Test Mode :	Transmit (802.11ax HE80 MCS0)	Test Date :	2024/03/28
Test Channel :	CH155(5775MHz)	Temperature :	23.4 °C
Polarization :	Vertical	Relative Humidity :	53 %

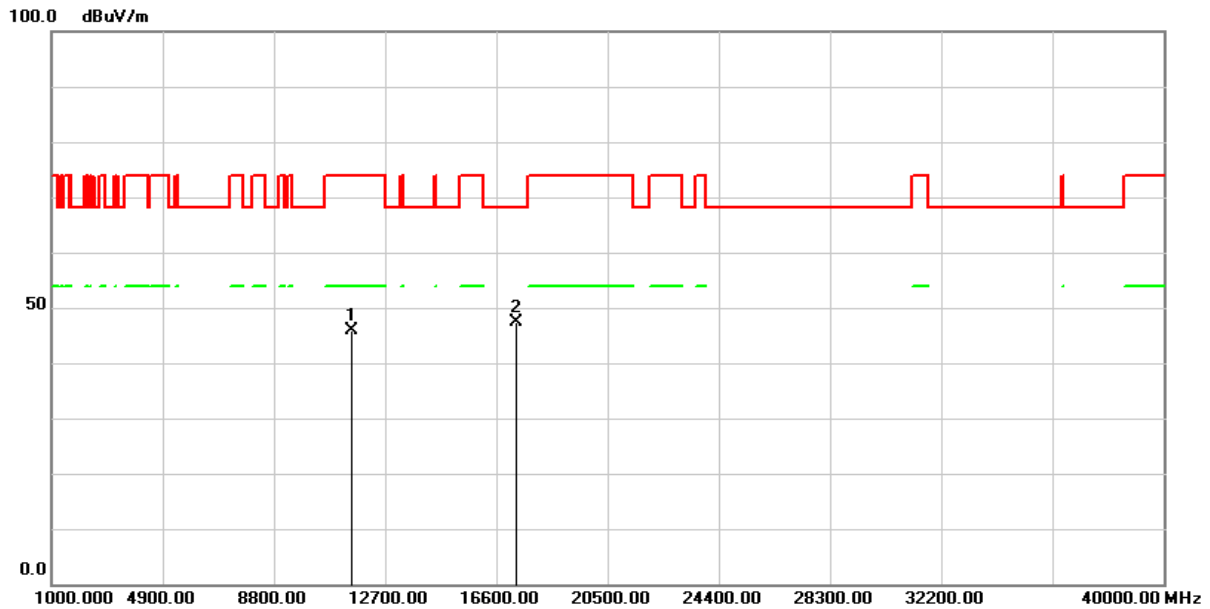

No.	Frequency (MHz)	Reading (dBuV/m)	Correct Factor (dB/m)	Result (dBuV/m)	Limit (dBuV/m)	Margin (dB)	Remark
1	11550.000	55.31	-9.32	45.99	74.00	-28.01	peak
2	17325.000	49.34	-1.95	47.39	68.20	-20.81	peak

Remark :

1. Correction Factor = Antenna factor + Cable loss – Amplifier gain
2. Result Value = Reading Level + Correct Factor
3. Margin Level = Result Value – Limit Value
4. The other emission levels were very low against the limit

Below 1GHz Data

Test Mode :	Transmit (802.11a 6Mbps)	Test Date :	2024/03/21
Test Channel :	CH48 (5240MHz)	Temperature :	20.4 °C
Polarization :	Horizontal	Relative Humidity :	49 %

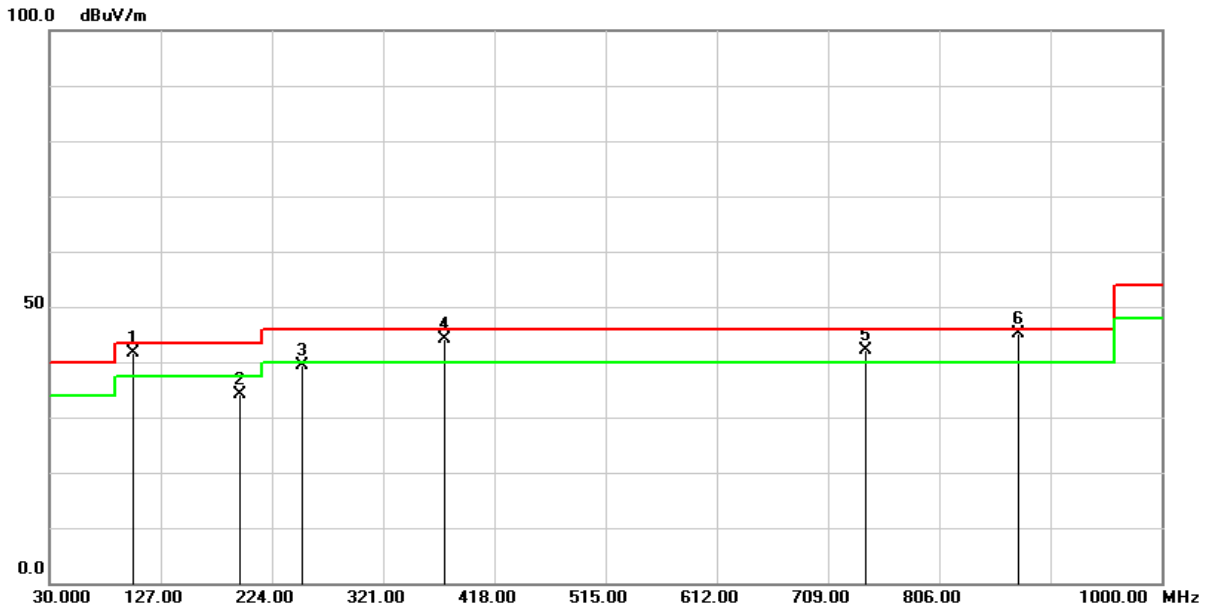

No.	Frequency (MHz)	Reading (dBuV/m)	Correct Factor (dB/m)	Result (dBuV/m)	Limit (dBuV/m)	Margin (dB)	Remark
1	103.5080	56.83	-15.18	41.65	43.50	-1.85	QP
2	196.4957	48.13	-13.99	34.14	43.50	-9.36	QP
3	250.1900	51.48	-12.11	39.37	46.00	-6.63	QP
4	375.0052	52.02	-7.98	44.04	46.00	-1.96	QP
5	742.5014	41.48	0.75	42.23	46.00	-3.77	QP
6	875.0030	42.42	2.64	45.06	46.00	-0.94	QP

Remark :

1. Correction Factor = Antenna factor + Cable loss – Amplifier gain
2. Result Value = Reading Level + Correct Factor
3. Margin Level = Result Value – Limit Value
4. The other emission levels were very low against the limit

Test Mode :	Transmit (802.11a 6Mbps)	Test Date :	2024/03/21
Test Channel :	CH48 (5240MHz)	Temperature :	20.4 °C
Polarization :	Vertical	Relative Humidity :	49 %

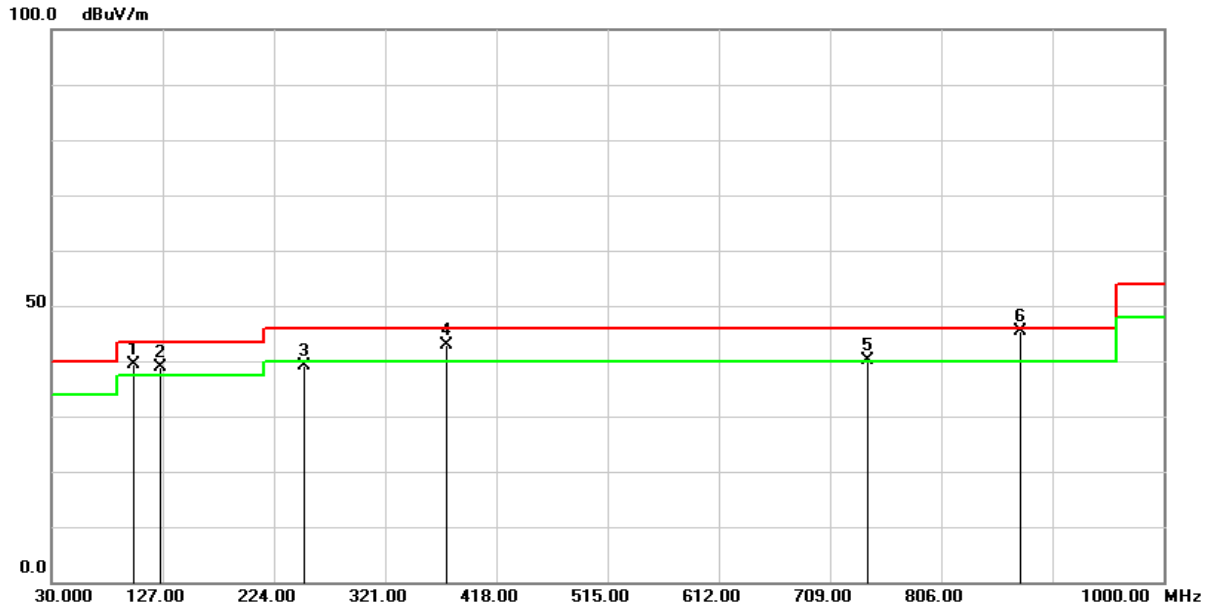

No.	Frequency (MHz)	Reading (dBuV/m)	Correct Factor (dB/m)	Result (dBuV/m)	Limit (dBuV/m)	Margin (dB)	Remark
1	101.9932	54.70	-15.34	39.36	43.50	-4.14	QP
2	125.0057	52.16	-13.16	39.00	43.50	-4.50	QP
3	250.1900	51.27	-12.11	39.16	46.00	-6.84	QP
4	374.9914	50.77	-7.99	42.78	46.00	-3.22	QP
5	742.5076	39.30	0.75	40.05	46.00	-5.95	QP
6	874.9970	42.83	2.63	45.46	46.00	-0.54	QP

Remark :

1. Correction Factor = Antenna factor + Cable loss – Amplifier gain
2. Result Value = Reading Level + Correct Factor
3. Margin Level = Result Value – Limit Value
4. The other emission levels were very low against the limit

Test Mode :	Transmit (802.11a 6Mbps)	Test Date :	2024/03/21
Test Channel :	CH149 (5745MHz)	Temperature :	20.4 °C
Polarization :	Horizontal	Relative Humidity :	49 %

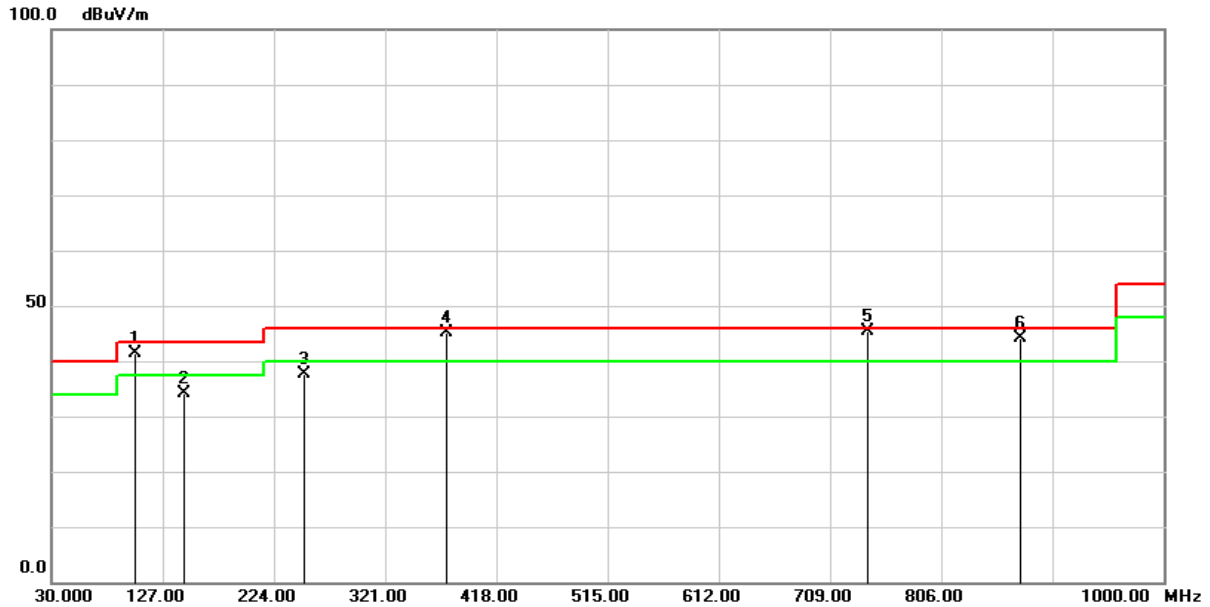

No.	Frequency (MHz)	Reading (dBuV/m)	Correct Factor (dB/m)	Result (dBuV/m)	Limit (dBuV/m)	Margin (dB)	Remark
1	103.5120	56.52	-15.18	41.34	43.50	-2.16	QP
2	145.5105	45.64	-11.46	34.18	43.50	-9.32	QP
3	250.0042	49.67	-12.11	37.56	46.00	-8.44	QP
4	375.0062	53.05	-7.98	45.07	46.00	-0.93	QP
5	742.4988	44.67	0.75	45.42	46.00	-0.58	QP
6	875.0030	41.59	2.64	44.23	46.00	-1.77	QP

Remark :

1. Correction Factor = Antenna factor + Cable loss – Amplifier gain
2. Result Value = Reading Level + Correct Factor
3. Margin Level = Result Value – Limit Value
4. The other emission levels were very low against the limit

Test Mode :	Transmit (802.11a 6Mbps)	Test Date :	2024/03/21
Test Channel :	CH149 (5745MHz)	Temperature :	20.4 °C
Polarization :	Vertical	Relative Humidity :	49 %

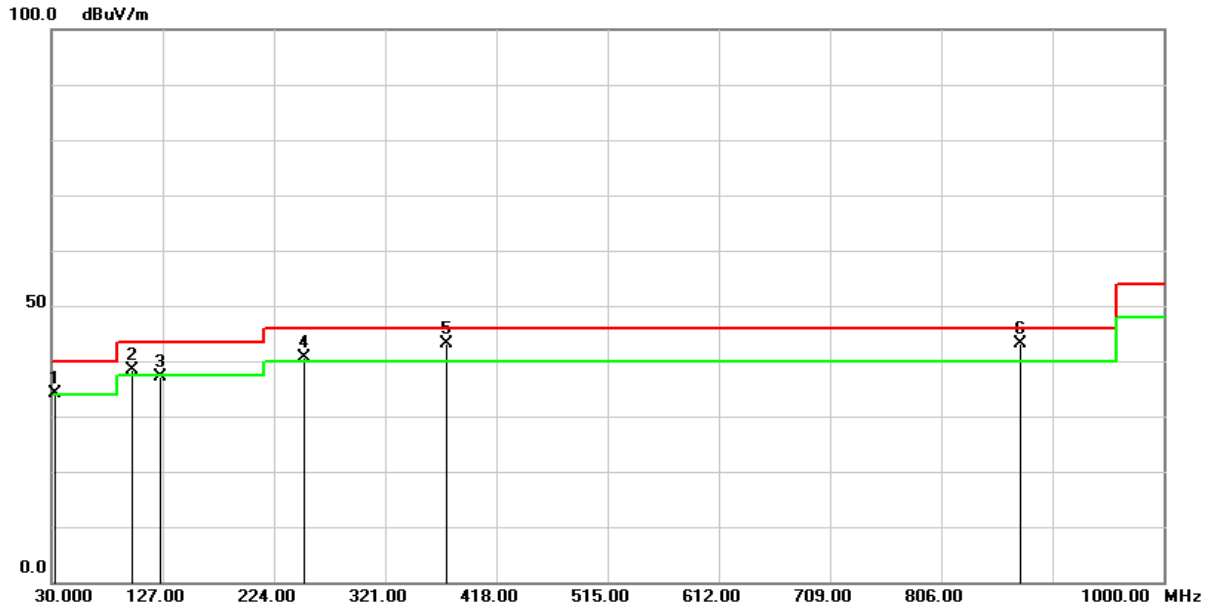

No.	Frequency (MHz)	Reading (dBuV/m)	Correct Factor (dB/m)	Result (dBuV/m)	Limit (dBuV/m)	Margin (dB)	Remark
1	32.6468	47.32	-13.23	34.09	40.00	-5.91	QP
2	100.5056	54.01	-15.61	38.40	43.50	-5.10	QP
3	125.0076	50.36	-13.16	37.20	43.50	-6.30	QP
4	249.9951	52.64	-12.12	40.52	46.00	-5.48	QP
5	375.0014	51.20	-7.98	43.22	46.00	-2.78	QP
6	874.9970	40.45	2.63	43.08	46.00	-2.92	QP

Remark :

1. Correction Factor = Antenna factor + Cable loss – Amplifier gain
2. Result Value = Reading Level + Correct Factor
3. Margin Level = Result Value – Limit Value
4. The other emission levels were very low against the limit

2.6 Frequency Stability

2.6.1 Limit

Manufacturers of U-NII devices are responsible for ensuring frequency stability such that an emission is maintained within the band of operation under all conditions of normal operation as specified in the user's manual.

2.6.2 Test Setup

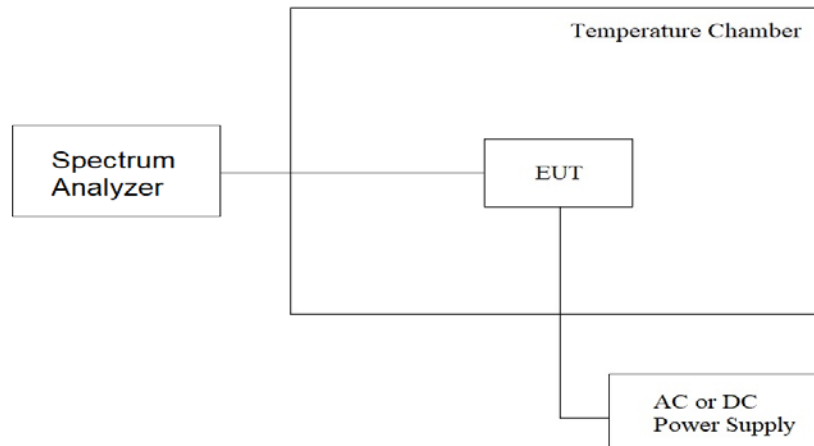

2.6.3 Test Procedure

1. The test shall be performed under 85% ~115% of the nominal voltage.
2. Set the temperature control on the chamber to the highest specified in the regulatory requirements for the type of device and allow the oscillator heater and the chamber temperature to stabilize.
3. The frequency deviation was calculated by adding the upper frequency point and the lower frequency point divided by two. Those detailed values of frequency deviation are provided in table below.

2.6.4 Test Result

Band I selected frequency: 5180MHz

Temperature (°C)	Voltage (V)	Tolerance (ppm)				Limit (ppm)	Result
		Start	2 min	5 min	10 min		
20	108	-2.896	-15.444	11.583	19.305	20	Pass
	120	-1.931	-13.514	1.931	-17.375	20	Pass
	132	0.965	-13.514	13.514	-5.792	20	Pass

Temperature (°C)	Voltage (V)	Tolerance (ppm)				Limit (ppm)	Result
		Start	2 min	5 min	10 min		
0	120	5.792	-13.514	1.931	-1.931	20	Pass
10		11.583	0.000	-1.931	-5.792	20	Pass
20		-3.861	-17.375	-15.444	-11.583	20	Pass
30		9.653	3.861	5.792	-17.375	20	Pass
40		-9.653	-1.931	13.514	-1.931	20	Pass

Band III selected frequency: 5745MHz

Temperature (°C)	Voltage (V)	Tolerance (ppm)				Limit (ppm)	Result
		Start	2 min	5 min	10 min		
20	108	-10.444	-1.741	-6.963	-1.741	20	Pass
	120	0.000	1.741	-1.741	8.703	20	Pass
	132	-10.444	-1.741	8.703	1.741	20	Pass

Temperature (°C)	Voltage (V)	Tolerance (ppm)				Limit (ppm)	Result
		Start	2 min	5 min	10 min		
0	120	1.741	15.666	-15.666	-10.444	20	Pass
10		-3.481	-8.703	-3.481	0.000	20	Pass
20		-15.666	0.000	-10.444	0.000	20	Pass
30		6.963	-15.666	-13.925	-10.444	20	Pass
40		6.963	15.666	-8.703	-5.222	20	Pass

2.7 Antenna Requirement

2.7.1 Applicable Standard

An intentional radiator shall be designed to ensure that no antenna other than that furnished by the responsible party shall be used with the device. The use of a permanently attached antenna or of an antenna that uses a unique coupling to the intentional radiator shall be considered sufficient to comply with the provisions of this section. The manufacturer may design the unit so that a broken antenna can be replaced by the user, but the use of a standard antenna jack or electrical connector is prohibited.

An intentional radiator shall be designed to ensure that no antenna other than as furnished by the responsible party shall be used with the device. If transmitting antennas of directional gain greater than 6dBi are using the power shall be reduced by the amount in dB that the directional gain of the antenna exceeds 6 dBi, for compliance to FCC 47CFR 15.407 (a) requirements.

2.7.2 Antenna Connected Construction

Non-standard antenna connector is used.

2.7.3 Antenna Gain

No.	Manufacturer	Model No.	Antenna Type	Peak Gain
1	SHENZHEN ZCONN PRECISION ELECTRONIC CO.,LTD	2901-01110003506	FPC Antenna	3.48 dBi for 5.15 ~ 5.25 GHz 3.54 dBi for 5.725 ~ 5.85 GHz
2	SHENZHEN ZCONN PRECISION ELECTRONIC CO.,LTD	2901-01110003506	FPC Antenna	3.48 dBi for 5.15~5.25GHz 3.54 dBi for 5.725~5.85GHz

2.8 AC Conducted Emissions Measurement

2.8.1 Limit

Frequency (MHz)	FCC Part 15 Subpart C Paragraph 15.207 (dB μ V) Limit	
	Quasi-peak	Average
0.15 to 0.5	66 to 56*	56 to 46*
0.50 to 5.0	56	46
5.0 to 30.0	60	50

*Decreases with the logarithm of the frequency

2.8.2 Test Setup

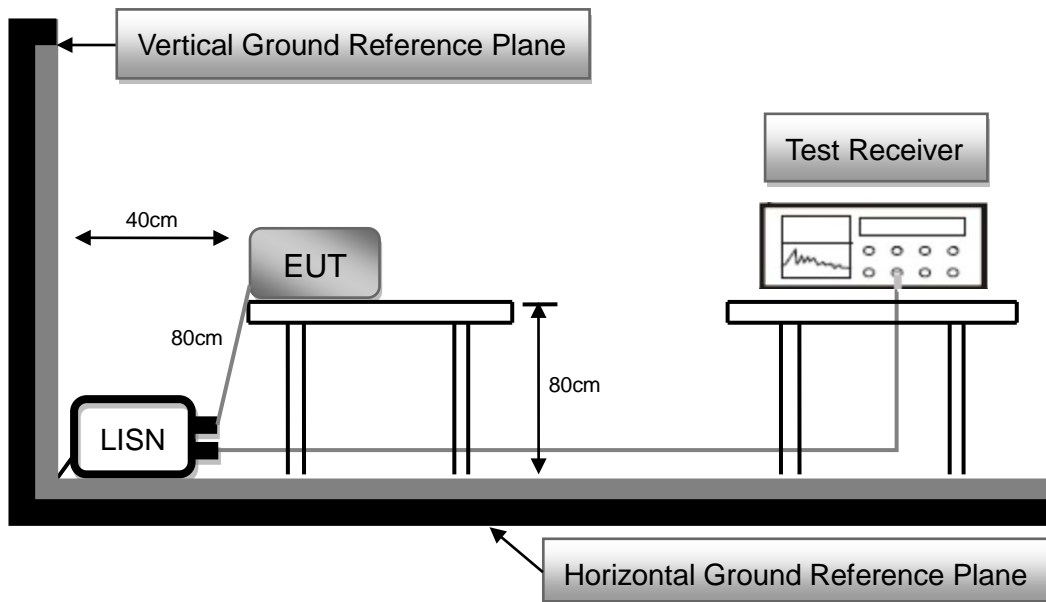

2.8.3 Test Procedure

1. The EUT was placed 0.8 meter height wooden table from the horizontal ground plane with EUT being connected to power source through a line impedance stabilization network (LISN). The LISN at least be 80 cm from nearest chassis of EUT.
2. The line impedance stabilization network (LISN) provides 50 ohm/50uH of coupling impedance for the measuring instrument. All other support equipments powered from additional LISN(s).
3. Interrelating cables that hang closer than 40 cm to the ground plane shall be folded back and forth in the center forming a bundle. All I/O cables were positioned to simulate typical usage.
4. All I/O cables that are not connected to a peripheral shall be bundle in the center. The end of the cable may be terminated, if required, using the correct terminating impedance. The overall length shall not exceed 1 m.
5. The EMI test receiver connected to LISN powering the EUT. The actual test configuration, please refer to EUT test photos.
6. The receiver scanned from 150kHz to 30MHz for emissions in each of test modes. Conducted emissions were invested over the frequency range from 0.15MHz to 30MHz using a receiver bandwidth of 9kHz. A scan was taken on both power lines, Line and Neutral, recording at least six highest emissions.
7. The EUT and cable configuration of the above highest emission levels were recorded. The Test Data of the worst case was recorded.

2.8.4 Test Result

Test Voltage :	120Vac, 60Hz	Frequency Range:	0.15-30 MHz
Test Mode :	Transmit (802.11a 6Mbps)	6dB Bandwidth :	9 kHz
Test Date :	2024/03/26	Phase :	L
Temperature :	20.4°C	Humidity :	57 %

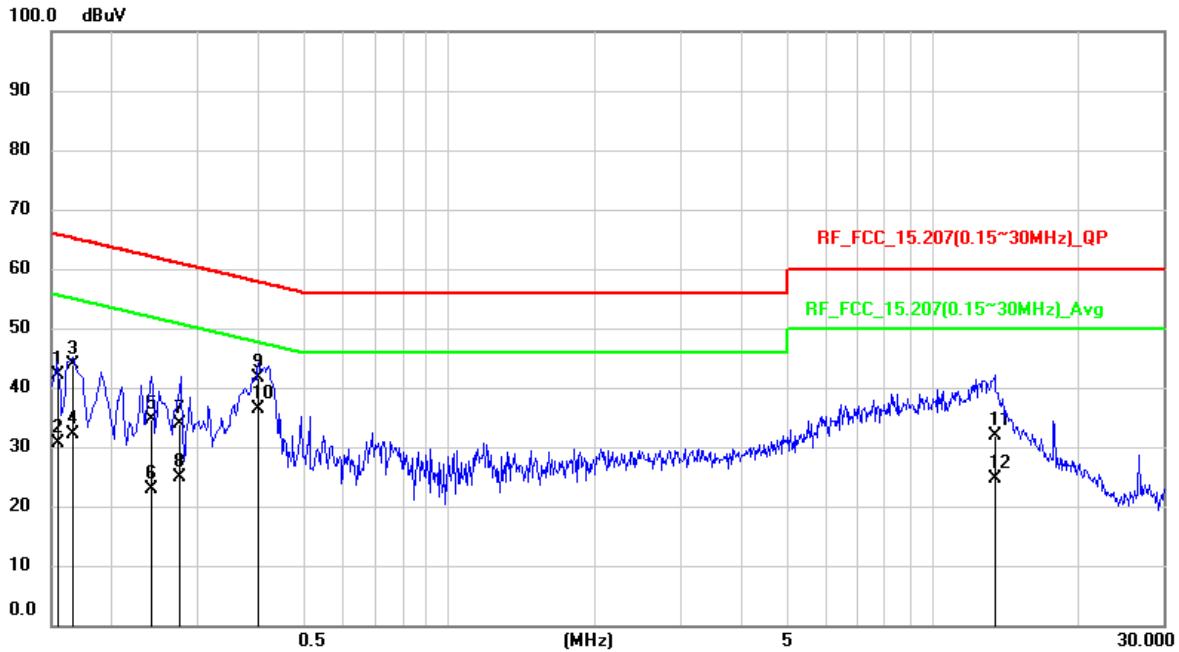

No.	Frequency (MHz)	Reading Level (dBuV)	Correct Factor (dB)	Measurement (dBuV)	Limit (dBuV)	Margin (dB)	Detector
1	0.1556	32.41	9.84	42.25	65.7	-23.45	QP
2	0.1556	20.89	9.84	30.73	55.7	-24.97	AVG
3	0.1659	33.97	9.84	43.81	65.16	-21.35	QP
4	0.1659	22.36	9.84	32.2	55.16	-22.96	AVG
5	0.2406	24.85	9.82	34.67	62.08	-27.41	QP
6	0.2406	13.08	9.82	22.9	52.08	-29.18	AVG
7	0.2744	23.95	9.82	33.77	60.98	-27.21	QP
8	0.2744	14.95	9.82	24.77	50.98	-26.21	AVG
9	0.4019	31.77	9.84	41.61	57.81	-16.2	QP
10	0.4019	26.59	9.84	36.43	47.81	-11.38	AVG
11	13.4191	21.85	10.15	32	60	-28	QP
12	13.4191	14.59	10.15	24.74	50	-25.26	AVG

Remark:

1. QP = Quasi Peak, AVG = Average
2. Correction Factor = Insertion loss of LISN + Cable loss
3. Measurement Value = Reading Level + Correct Factor
4. Margin Level = Measurement Value – Limit Value

Test Voltage :	120Vac, 60Hz	Frequency Range:	0.15-30 MHz
Test Mode :	Transmit (802.11a 6Mbps)	6dB Bandwidth :	9 kHz
Test Date :	2024/03/26	Phase :	N
Temperature :	20.4°C	Humidity :	57 %

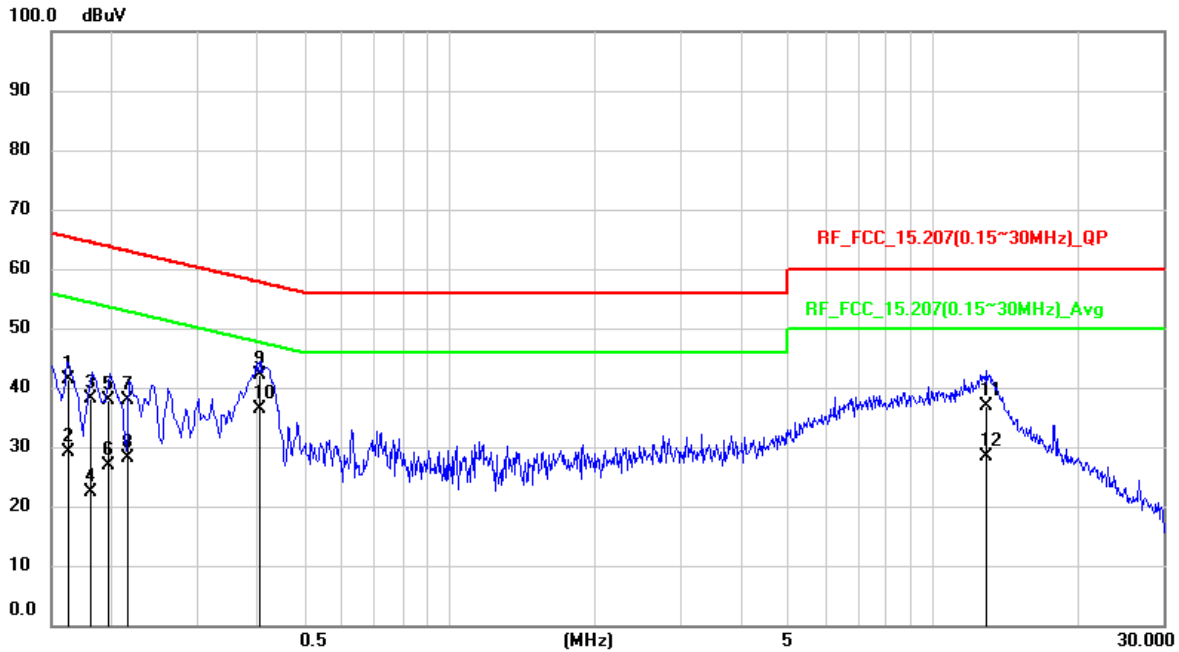

No.	Frequency (MHz)	Reading Level (dBuV)	Correct Factor (dB)	Measurement (dBuV)	Limit (dBuV)	Margin (dB)	Detector
1	0.163	31.42	9.84	41.26	65.31	-24.05	QP
2	0.163	19.32	9.84	29.16	55.31	-26.15	AVG
3	0.1801	28.36	9.83	38.19	64.48	-26.29	QP
4	0.1801	12.61	9.83	22.44	54.48	-32.04	AVG
5	0.1964	27.96	9.83	37.79	63.76	-25.97	QP
6	0.1964	16.96	9.83	26.79	53.76	-26.97	AVG
7	0.2155	27.97	9.83	37.8	62.99	-25.19	QP
8	0.2155	18.29	9.83	28.12	52.99	-24.87	AVG
9	0.4023	32.25	9.84	42.09	57.81	-15.72	QP
10	0.4023	26.63	9.84	36.47	47.81	-11.34	AVG
11	12.9227	26.64	10.16	36.8	60	-23.2	QP
12	12.9227	18.34	10.16	28.5	50	-21.5	AVG

Remark:

1. QP = Quasi Peak, AVG = Average
2. Correction Factor = Insertion loss of LISN + Cable loss
3. Measurement Value = Reading Level + Correct Factor
4. Margin Level = Measurement Value – Limit Value

--- END ---