

# SAR TEST REPORT

**Application No.:** KSEM2102000226CR  
**Applicant:** WWZN Information Technology Company Limited  
**Address of Applicant:** Room -101, B1 Floor, Building 1, No.42, Gaoliangqiao Xiejie, Haidian District, Beijing, China  
**Manufacturer:** WWZN Information Technology Company Limited  
**Address of Manufacturer:** Room -101, B1 Floor, Building 1, No.42, Gaoliangqiao Xiejie, Haidian District, Beijing, China  
**Factory:** Luxshare Electronic Technology(Kunshan) Co.,Ltd.  
**Address of Factory:** No.158 Jinchang Road, Jinxi Town, Kunshan City, Jiangsu, China  
**Product Name:** Smart Watch  
**Model No.(EUT):** WH12068  
**Trade mark:** Mobvoi  
**FCC ID:** 2AP42-WH12068  
**IC:** 24006-WH12068  
**Standard(s) :** FCC 47CFR §2.1093  
 RSS 102 Issue 5  
**Date of Receipt:** 2021-02-21  
**Date of Test:** 2021-02-25 to 2021-02-25  
**Date of Issue:** 2021-02-29

**Test Result:****Pass\***

\* In the configuration tested, the EUT complied with the standards specified above.

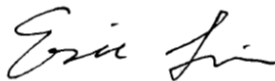

Eric Lin

Laboratory Manager

The manufacturer should ensure that all products in series production are in conformity with the product sample detailed in this report.

If the product in this report is used in any configuration other than that detailed in the report, the manufacturer must ensure the new system complies with all relevant standards. Any mention of SGS International Electrical Approvals or testing done by SGS International Electrical Approvals in connection with, distribution or use of the product described in this report must be approved by SGS International Electrical Approvals in writing.



Unless otherwise agreed in writing, this document is issued by the Company subject to its General Conditions of Service printed overleaf, available on request or accessible at <http://www.sgs.com/en/Terms-and-Conditions.aspx> and, for electronic format documents, subject to Terms and Conditions for Electronic Documents at <http://www.sgs.com/en/Terms-and-Conditions/Terms-e-Documents.aspx>. Attention is drawn to the limitation of liability, indemnification and jurisdiction issues defined therein. Any holder of this document is advised that information contained hereon reflects the Company's findings at the time of its intervention only and within the limits of Client's instructions, if any. The Company's sole responsibility is to its Client and this document does not exonerate parties to a transaction from exercising all their rights and obligations under the transaction documents. This document cannot be reproduced except in full, without prior written approval of the Company. Any unauthorized alteration, forgery or falsification of the content or appearance of this document is unlawful and offenders may be prosecuted to the fullest extent of the law. Unless otherwise stated the results shown in this test report refer only to the sample(s) tested and such sample(s) are retained for 30 days only.  
**Attention: To check the authenticity of testing / inspection report & certificate, please contact us at telephone: (86-755) 8307 1443, or email: CN.Doccheck@sgs.com**

No.10, Weiye Road, Innovation Park, Kunshan, Jiangsu, China 215300  
 中国·江苏·昆山市留学院创业园伟业路10号 邮编 215300

t(86-512)57355888 f(86-512)57370818 www.sgs.com.cn  
 t(86-512)57355888 f(86-512)57370818 sgs.china@sgs.com

## REVISION HISTORY

Revision Record			
Version	Description	Date	Remark
00	Original	2021-02-29	/

<b>Authorized for issue by:</b>				
		<b>Richard.Kong/ Project Engineer</b>		
		<b>Eric.Lin/Reviewer</b>		

**TEST SUMMARY**

Frequency Band	Test position	Test mode	Max Reported SAR1g (W/kg)	Max Reported SAR10g (W/kg)	SAR limit (W/kg)	Verdict
WI-FI (2.4GHz)	Next to the mouth	802.11b	0.40	/	1.6	PASS
	Extremity	802.11b	/	0.42	4.0	PASS
Bluetooth	Next to the mouth	GFSK	0.07	/	1.6	PASS
	Extremity	GFSK	/	0.08	4.0	PASS

## CONTENTS

<b>1</b>	<b>GENERAL INFORMATION.....</b>	<b>6</b>
1.1	GENERAL DESCRIPTION OF EUT.....	6
1.1.1	<i>DUT Antenna Locations(Unit: mm)</i> .....	7
1.2	TEST SPECIFICATION.....	8
1.3	RF EXPOSURE LIMITS .....	9
1.4	TEST LOCATION .....	10
1.5	TEST FACILITY .....	10
<b>2</b>	<b>LABORATORY ENVIRONMENT .....</b>	<b>11</b>
<b>3</b>	<b>SAR MEASUREMENTS SYSTEM CONFIGURATION.....</b>	<b>12</b>
3.1	THE SAR MEASUREMENT SYSTEM.....	12
3.2	ISOTROPIC E-FIELD PROBE EX3DV4 .....	13
3.3	DATA ACQUISITION ELECTRONICS (DAE) .....	14
3.4	SAM TWIN PHANTOM.....	14
3.5	ELI PHANTOM.....	15
3.6	DEVICE HOLDER FOR TRANSMITTERS.....	16
3.7	MEASUREMENT PROCEDURE.....	17
3.7.1	<i>Scanning procedure</i> .....	17
3.7.2	<i>Data Storage</i> .....	19
3.7.3	<i>Data Evaluation by SEMCAD</i> .....	19
<b>4</b>	<b>SAR MEASUREMENT VARIABILITY AND UNCERTAINTY .....</b>	<b>21</b>
4.1	SAR MEASUREMENT VARIABILITY .....	21
4.2	SAR MEASUREMENT UNCERTAINTY .....	22
<b>5</b>	<b>DESCRIPTION OF TEST POSITION .....</b>	<b>23</b>
5.1	NEXT TO THE MOUTH EXPOSURE CONDITION .....	23
5.2	EXTREMITY EXPOSURE CONDITION .....	24
<b>6</b>	<b>SAR SYSTEM VERIFICATION PROCEDURE.....</b>	<b>25</b>
6.1	TISSUE SIMULATE LIQUID.....	25
6.1.1	<i>Recipes for Tissue Simulate Liquid</i> .....	25
6.1.2	<i>Test Liquids Confirmation</i> .....	26
6.1.3	<i>Measurement for Tissue Simulate Liquid</i> .....	27
6.2	SAR SYSTEM CHECK .....	28
6.2.1	<i>Justification for Extended SAR Dipole Calibrations</i> .....	29
6.2.2	<i>Summary System Check Result(s)</i> .....	30
6.2.3	<i>Detailed System Check Results</i> .....	30
<b>7</b>	<b>TEST CONFIGURATION.....</b>	<b>31</b>
7.1	OPERATION CONFIGURATIONS.....	31
7.1.1	<i>Wi-Fi Test Configuration</i> .....	31
7.1.2	<i>Bluetooth Test Configuration</i> .....	34
<b>8</b>	<b>TEST RESULT .....</b>	<b>35</b>
8.1	MEASUREMENT OF RF CONDUCTED POWER .....	35
8.1.1	<i>Conducted Power Of Wi-Fi and BT</i> .....	35
8.2	STAND-ALONE SAR TEST EVALUATION FOR FCC.....	36
8.3	STAND-ALONE SAR TEST EVALUATION FOR IC.....	37
8.4	MEASUREMENT OF SAR DATA.....	38
8.4.1	<i>SAR Result Of 2.4GHz Wi-Fi</i> .....	38
8.4.2	<i>SAR Result Of Bluetooth</i> .....	39



8.5	MULTIPLE TRANSMITTER EVALUATION.....	40
8.5.1	<i>Simultaneous SAR SAR test evaluation.....</i>	40
9	EQUIPMENT LIST .....	41
10	CALIBRATION CERTIFICATE.....	42
11	PHOTOGRAPHS .....	42
	APPENDIX A: DETAILED SYSTEM CHECK RESULTS .....	43
	APPENDIX B: DETAILED TEST RESULTS.....	45
	APPENDIX C: CALIBRATION CERTIFICATE .....	50
	APPENDIX D: PHOTOGRAPHS.....	50

# 1 General Information

## 1.1 General Description of EUT

Device Type :	portable device		
Exposure Category:	uncontrolled environment / general population		
Product Phase:	production unit		
SN:	AC01A0C XXXXX		
Hardware Version:	DVT1		
Software Version:	PMKB.210129.00A		
Firmware Version:	PMKB.210129.00A		
Antenna Type:	LDS		
Device Operating Configurations :			
Modulation Mode:	<b>WI-FI:</b> CCK, DSSS, OFDM; <b>BT:</b> GFSK, π/4DQPSK,8DPSK		
Antenna Gain:	WiFi2.4GHz: -4.4dBi Bluetooth: -4.4dBi		
Device Class:	B		
Frequency Bands:	Band	Tx (MHz)	Rx (MHz)
	WI-FI2.4G	2412~2462	2412~2462
	Bluetooth	2402~2480	2402~2480
Battery1 Information:	Model: WBL-K		
	Rated capacity: 380mAh, 3.88V		
	Manufacturer: AMPRIUS (WUXI) CO., LTD		

Note:

The antenna gain value is provided by the customer. The test lab will not be responsible for wrong test result due to incorrect information about antenna gain values.

### 1.1.1 DUT Antenna Locations(Unit: mm)

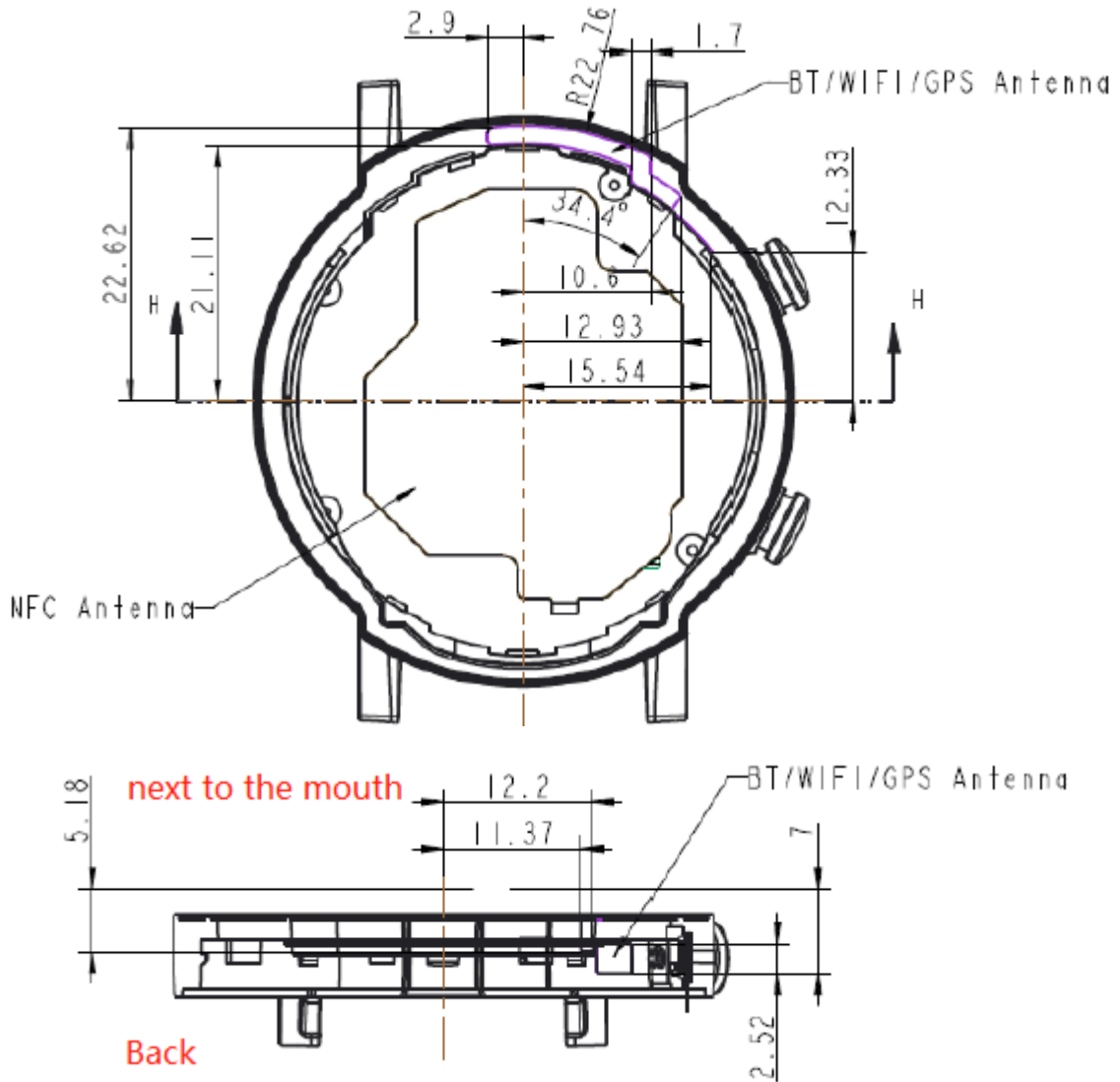

The test device is a smart watch.

## 1.2 Test Specification

Identity	Document Title
FCC 47CFR §2.1093	Radio frequency Radiation Exposure Evaluation: Portable Devices
ANSI/IEEE Std C95.1 – 2019	IEEE Standard for Safety Levels with Respect to Human Exposure to Electric, Magnetic, and Electromagnetic Fields, 0 Hz to 300 GHz
RSS-102 Issue 5	Radio Frequency Exposure Compliance of Radio Communication Apparatus (All Frequency Bands) Issue 5 of March 2015
Canada's Safety Code 6	Limits of Human Exposure to Radiofrequency Electromagnetic Fields in the Frequency Range from 3 kHz to 300 GHz (99-EHD-237)
IEEE 1528-2013	Recommended Practice for Determining the Peak Spatial-Average Specific Absorption Rate (SAR) in the Human Head from Wireless Communications Devices: Measurement Techniques
KDB 248227 D01 802.11 Wi-Fi SAR v02r02	SAR GUIDANCE FOR IEEE 802.11 (Wi-Fi) TRANSMITTERS
KDB447498 D01 General RF Exposure Guidance v06	Mobile and Portable Devices RF Exposure Procedures and Equipment Authorization Policies
KDB 865664 D01 SAR Measurement 100 MHz to 6 GHz v01r04	SAR Measurement Requirements for 100 MHz to 6 GHz
KDB 865664 D02 RF Exposure Reporting v01r02	RF Exposure Compliance Reporting and Documentation Considerations



### 1.3 RF exposure limits

Human Exposure	Uncontrolled Environment General Population	Controlled Environment Occupational
<b>Spatial Peak SAR*</b> (Brain*Trunk)	<b>1.60 W/kg</b>	8.00 W/kg
<b>Spatial Average SAR**</b> (Whole Body)	0.08 W/kg	0.40 W/kg
<b>Spatial Peak SAR***</b> (Hands/Feet/Ankle/Wrist)	<b>4.00 W/kg</b>	20.00 W/kg

**Notes:**

\* The Spatial Peak value of the SAR averaged over any 1 gram of tissue (defined as a tissue volume in the shape of a cube) and over the appropriate averaging time

\*\* The Spatial Average value of the SAR averaged over the whole body.

\*\*\* The Spatial Peak value of the SAR averaged over any 10 grams of tissue (defined as a tissue volume in the shape of a cube) and over the appropriate averaging time.

**Uncontrolled Environments** are defined as locations where there is the exposure of individuals who have no knowledge or control of their exposure.

**Controlled Environments** are defined as locations where there is exposure that may be incurred by persons who are aware of the potential for exposure, (i.e. as a result of employment or occupation.)

## 1.4 Test Location

Company: Compliance Certification Services (Kunshan) Inc.  
Address: No.10 Weiye Rd., Innovation park, Eco&Tec, Development Zone, Kunshan City, Jiangsu, China  
Post code: 215300  
Telephone: 86-512-57355888  
Fax: 86-512-57370818  
E-mail: [sgs.china@sgs.com](mailto:sgs.china@sgs.com)

## 1.5 Test Facility

The test facility is recognized, certified, or accredited by the following organizations:

- **CNAS (No. CNAS L4354)**

CNAS has accredited Compliance Certification Services (Kunshan) Inc. to ISO/IEC 17025:2017 General Requirements for the Competence of Testing and Calibration Laboratories (CNAS-CL01 Accreditation Criteria for the Competence of Testing and Calibration Laboratories) for the competence in the field of testing.

- **A2LA (Certificate No. 2541.01)**

Compliance Certification Services (Kunshan) Inc. is accredited by the American Association for Laboratory Accreditation (A2LA). Certificate No. 2541.01.

- **FCC –Designation Number: CN1172**

Compliance Certification Services Inc. has been recognized as an accredited testing laboratory.  
Designation Number: CN1172.

- **ISED (CAB identifier: CN0072)**

Compliance Certification Services (Kunshan) Inc. has been recognized by Innovation, Science and Economic Development Canada (ISED) as an accredited testing laboratory  
CAB Identifier: CN0072.

- **VCCI (Member No.: 1938)**

The 3m and 10m Semi-anechoic chamber and Shielded Room of Compliance Certification Services (Kunshan) Inc. has been registered in accordance with the Regulations for Voluntary Control Measures with Registration No.: R-1600, C-1707, T-1499, G-10216 respectively.

## 2 Laboratory Environment

Temperature	Min. = 18°C, Max. = 25 °C
Relative humidity	Min. = 30%, Max. = 70%
Ground system resistance	< 0.5 Ω
Ambient noise is checked and found very low and in compliance with requirement of standards.	
Reflection of surrounding objects is minimized and in compliance with requirement of standards.	

Table 2: The Ambient Conditions

### 3 SAR Measurements System Configuration

#### 3.1 The SAR Measurement System

This SAR Measurement System uses a Computer-controlled 3-D stepper motor system (SPEAG DASY5 professional system). A E-field probe is used to determine the internal electric fields. The SAR can be obtained from the equation  $SAR = \sigma (|E|^2) / \rho$  where  $\sigma$  and  $\rho$  are the conductivity and mass density of the tissue-Simulate.

The DASY5 system for performing compliance tests consists of the following items:

A standard high precision 6-axis robot (Stabile RX family) with controller, teach pendant and software .An arm extension for accommodation the data acquisition electronics (DAE).

A dosimetric probe, i.e., an isotropic E-field probe optimized and calibrated for usage in tissue simulating liquid. The probe is equipped with an optical surface detector system.

A data acquisition electronics (DAE) which performs the signal amplification, signal multiplexing, AD-conversion, offset measurements, mechanical surface detection, collision detection, etc. The unit is battery powered with standard or rechargeable batteries. The signal is optically transmitted to the EOC.

The Electro-optical converter (EOC) performs the conversion between optical and electrical of the signals for the digital communication to DAE and for the analog signal from the optical surface detection. The EOC is connected to the measurement server.

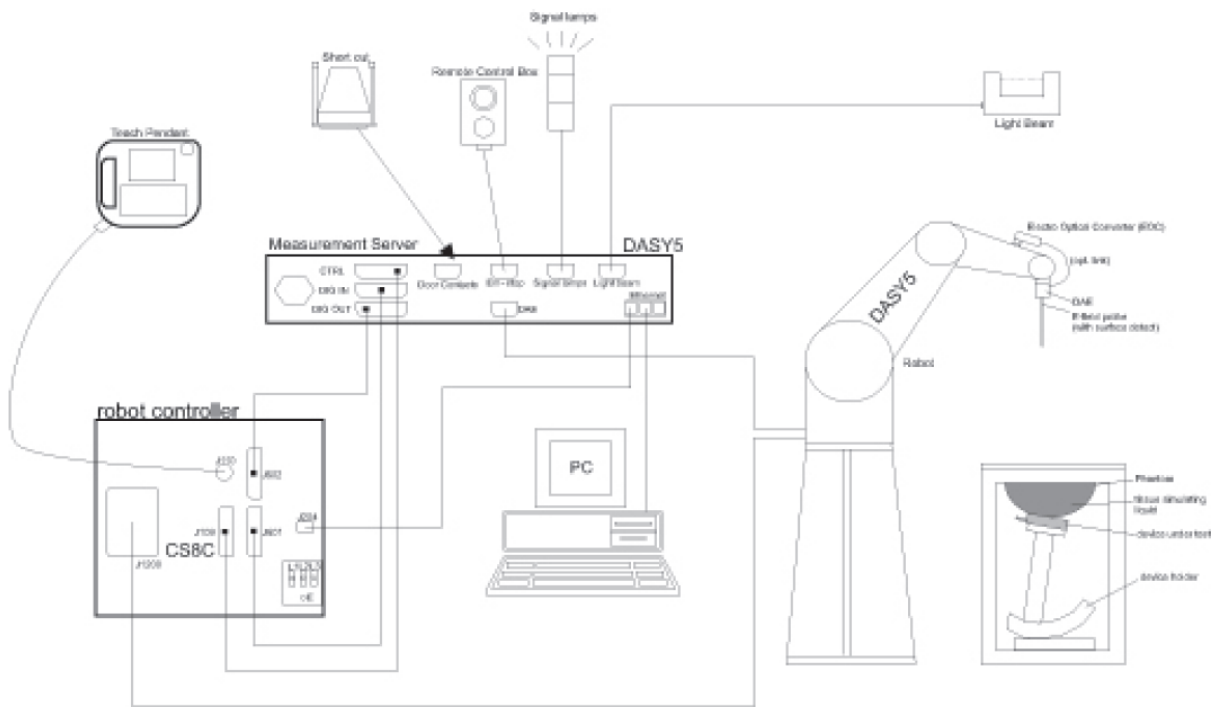

F-1. SAR Measurement System Configuration

- The function of the measurement server is to perform the time critical tasks such as signal filtering, control of the robot operation and fast movement interrupts.

- A probe alignment unit which improves the (absolute) accuracy of the probe positioning.
- A computer operating Windows 7.
- DASY5 software.
- Remote control with teach pendant and additional circuitry for robot safety such as warning lamps, etc.
- The SAM twin phantom enabling testing left-hand, right-hand and Body Worn usage.
- The device holder for handheld mobile phones.
- Tissue simulating liquid mixed according to the given recipes.
- Validation dipole kits allowing to validate the proper functioning of the system.

### 3.2 Isotropic E-field Probe EX3DV4

	<p>Symmetrical design with triangular core Built-in shielding against static charges PEEK enclosure material (resistant to organic solvents, e.g., DGBE)</p>
<p><b>Calibration</b></p>	<p>ISO/IEC 17025 <a href="#">calibration service</a> available.</p>
<p><b>Frequency</b></p>	<p>10 MHz to &gt; 6 GHz Linearity: <math>\pm 0.2</math> dB (30 MHz to 6 GHz)</p>
<p><b>Directivity</b></p>	<p><math>\pm 0.3</math> dB in TSL (rotation around probe axis) <math>\pm 0.5</math> dB in TSL (rotation normal to probe axis)</p>
<p><b>Dynamic Range</b></p>	<p>10 <math>\mu</math>W/g to &gt; 100 mW/g Linearity: <math>\pm 0.2</math> dB (noise: typically &lt; 1 <math>\mu</math>W/g)</p>
<p><b>Dimensions</b></p>	<p>Overall length: 337 mm (Tip: 20 mm) Tip diameter: 2.5 mm (Body: 12 mm) Typical distance from probe tip to dipole centers: 1 mm</p>
<p><b>Application</b></p>	<p>High precision dosimetric measurements in any exposure scenario (e.g., very strong gradient fields); the only probe that enables compliance testing for frequencies up to 6 GHz with precision of better 30%.</p>
<p><b>Compatibility</b></p>	<p>DASY3, DASY4, DASY52 SAR and higher, EASY4/MRI</p>

### 3.3 Data Acquisition Electronics (DAE)

<b>Model</b>	DAE4	
<b>Construction</b>	Signal amplifier, multiplexer, A/D converter and control logic. Serial optical link for communication with DASY4/5 embedded system (fully remote controlled). Two step probe touch detector for mechanical surface detection and emergency robot stop.	
<b>Measurement Range</b>	-100 to +300 mV (16 bit resolution and two range settings: 4mV,400mV)	
<b>Input Offset Voltage</b>	< 5μV (with auto zero)	
<b>Input Bias Current</b>	< 50 f A	
<b>Dimensions</b>	60 x 60 x 68 mm	

### 3.4 SAM Twin Phantom

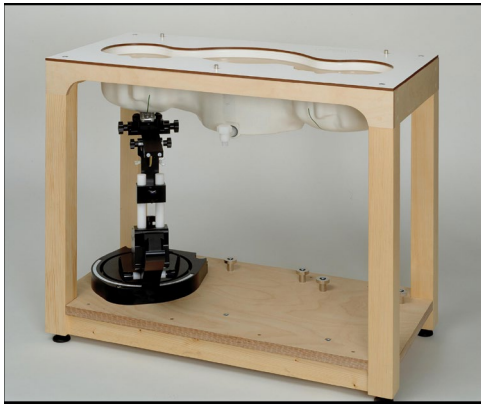
<b>Material</b>	Vinylester, glass fiber reinforced (VE-GF)	
<b>Liquid Compatibility</b>	Compatible with all SPEAG tissue simulating liquids (incl. DGBE type)	
<b>Shell Thickness</b>	2 ± 0.2 mm (6 ± 0.2 mm at ear point)	
<b>Dimensions (incl. Wooden Support)</b>	Length: 1000 mm Width: 500 mm Height: adjustable feet	
<b>Filling Volume</b>	approx. 25 liters	
<b>Wooden Support</b>	SPEAG standard phantom table	

The shell corresponds to the specifications of the Specific Anthropomorphic Mannequin (SAM) phantom defined in IEEE 1528 and IEC 62209-1. It enables the dosimetric evaluation of left and right hand phone usage as well as body mounted usage at the flat phantom region. A cover prevents evaporation of the liquid. Reference markings on the phantom allow the complete setup of all predefined phantom positions and measurement grids by teaching three points with the robot.

Twin SAM V5.0 has the same shell geometry and is manufactured from the same material as Twin SAM V4.0, but has reinforced top structure.

### 3.5 ELI Phantom

<b>Material</b>	Vinylester, glass fiber reinforced (VE-GF)	
<b>Liquid Compatibility</b>	Compatible with all SPEAG tissue simulating liquids (incl. DGBE type)	
<b>Shell Thickness</b>	2.0 ± 0.2 mm (bottom plate)	
<b>Dimensions</b>	Major axis: 600 mm Minor axis: 400 mm	
<b>Filling Volume</b>	approx. 30 liters	
<b>Wooden Support</b>	SPEAG standard phantom table	

Phantom for compliance testing of handheld and body-mounted wireless devices in the frequency range of 30 MHz to 6 GHz. ELI is fully compatible with the IEC 62209-2 standard and all known tissue simulating liquids. ELI has been optimized regarding its performance and can be integrated into our standard phantom tables. A cover prevents evaporation of the liquid. Reference markings on the phantom allow installation of the complete setup, including all predefined phantom positions and measurement grids, by teaching three points. The phantom is compatible with all SPEAG dosimetric probes and dipoles.

ELI V5.0 has the same shell geometry and is manufactured from the same material as ELI4, but has reinforced top structure.



### 3.6 Device Holder for Transmitters



F-2. Device Holder for Transmitters

- The DASY device holder is designed to cope with different positions given in the standard. It has two scales for the device rotation (with respect to the body axis) and the device inclination (with respect to the line between the ear reference points). The rotation centres for both scales are the ear reference point (ERP). Thus the device needs no repositioning when changing the angles.
- The DASY device holder has been made out of low-loss POM material having the following dielectric parameters: relative permittivity  $\epsilon=3$  and loss tangent  $\delta=0.02$ . The amount of dielectric material has been reduced in the closest vicinity of the device, since measurements have suggested that the influence of the clamp on the test results could thus be lowered.



## 3.7 Measurement procedure

### 3.7.1 Scanning procedure

#### Step 1: Power reference measurement

The “reference” and “drift” measurements are located at the beginning and end of the batch process. They measure the field drift at one single point in the liquid over the complete procedure.

#### Step 2: Area scan

The SAR distribution at the exposed side of the head was measured at a distance of 4mm from the inner surface of the shell. The area covered the entire dimension of the head and the horizontal grid spacing was 15mm\*15mm or 12mm\*12mm or 10mm\*10mm. Based on the area scan data, the area of the maximum absorption was determined by spline interpolation.

#### Step 3: Zoom scan

Around this point, a volume of 30mm\*30mm\*30mm (fine resolution volume scan, zoom scan) was assessed by measuring 5x5x7 points ( $\leq 2$ GHz) and 7x7x7 points ( $\geq 2$ GHz). On this basis of this data set, the spatial peak SAR value was evaluated with the following procedure:

The data at the surface was extrapolated, since the centre of the dipoles is 2.0mm away from the tip of the probe and the distance between the surface and the lowest measuring point is 1.2mm. (This can be variable. Refer to the probe specification). The extrapolation was based on a least square algorithm. A polynomial of the fourth order was calculated through the points in z-axes. This polynomial was then used to evaluate the points between the surface and the probe tip. The maximum interpolated value was searched with a straight-forward algorithm. Around this maximum the SAR values averaged over the spatial volumes (1g or 10g) were computed using the 3D-Spline interpolation algorithm. The volume was integrated with the trapezoidal algorithm. One thousand points were interpolated to calculate the average. All neighbouring volumes were evaluated until no neighboring volume with a higher average value was found.

The area and zoom scan resolutions specified in the table below must be applied to the SAR measurements. Probe boundary effect error compensation is required for measurements with the probe tip closer than half a probe tip diameter to the phantom surface. Both the probe tip diameter and sensor offset distance must satisfy measurement protocols; to ensure probe boundary effect errors are minimized and the higher fields closest to the phantom surface can be correctly measured and extrapolated to the phantom surface for computing 1-g SAR. Tolerances of the post-processing algorithms must be verified by the test laboratory for the scan resolutions used in the SAR measurements, according to the reference distribution functions specified in IEEE Std. 1528-2013.

		$\leq 3$ GHz	$> 3$ GHz
Maximum distance from closest measurement point (geometric center of probe sensors) to phantom surface		$5 \pm 1$ mm	$\frac{1}{2} \cdot \delta \cdot \ln(2) \pm 0.5$ mm
Maximum probe angle from probe axis to phantom surface normal at the measurement location		$30^\circ \pm 1^\circ$	$20^\circ \pm 1^\circ$
Maximum area scan spatial resolution: $\Delta x_{Area}$ , $\Delta y_{Area}$		$\leq 2$ GHz: $\leq 15$ mm 2 – 3 GHz: $\leq 12$ mm	3 – 4 GHz: $\leq 12$ mm 4 – 6 GHz: $\leq 10$ mm
		When the x or y dimension of the test device, in the measurement plane orientation, is smaller than the above, the measurement resolution must be $\leq$ the corresponding x or y dimension of the test device with at least one measurement point on the test device.	
Maximum zoom scan spatial resolution: $\Delta x_{Zoom}$ , $\Delta y_{Zoom}$		$\leq 2$ GHz: $\leq 8$ mm 2 – 3 GHz: $\leq 5$ mm*	3 – 4 GHz: $\leq 5$ mm* 4 – 6 GHz: $\leq 4$ mm*
Maximum zoom scan spatial resolution, normal to phantom surface	uniform grid: $\Delta z_{Zoom}(n)$	$\leq 5$ mm	3 – 4 GHz: $\leq 4$ mm 4 – 5 GHz: $\leq 3$ mm 5 – 6 GHz: $\leq 2$ mm
	graded grid	$\Delta z_{Zoom}(1)$ : between 1 <sup>st</sup> two points closest to phantom surface	$\leq 4$ mm
		$\Delta z_{Zoom}(n>1)$ : between subsequent points	$\leq 1.5 \cdot \Delta z_{Zoom}(n-1)$
Minimum zoom scan volume	x, y, z	$\geq 30$ mm	3 – 4 GHz: $\geq 28$ mm 4 – 5 GHz: $\geq 25$ mm 5 – 6 GHz: $\geq 22$ mm
<p>Note: <math>\delta</math> is the penetration depth of a plane-wave at normal incidence to the tissue medium; see draft standard IEEE P1528-2011 for details.</p> <p>* When zoom scan is required and the <i>reported</i> SAR from the <i>area scan based 1-g SAR estimation</i> procedures of KDB 447498 is <math>\leq 1.4</math> W/kg, <math>\leq 8</math> mm, <math>\leq 7</math> mm and <math>\leq 5</math> mm zoom scan resolution may be applied, respectively, for 2 GHz to 3 GHz, 3 GHz to 4 GHz and 4 GHz to 6 GHz.</p>			

#### Step 4: Power reference measurement (drift)

The Power Drift Measurement job measures the field at the same location as the most recent power reference measurement job within the same procedure, and with the same settings. The indicated drift is mainly the variation of the DUT's output power and should vary max.  $\pm 5\%$

### 3.7.2 Data Storage

The DASY software stores the acquired data from the data acquisition electronics as raw data (in microvolt readings from the probe sensors), together with all necessary software parameters for the data evaluation (probe calibration data, liquid parameters and device frequency and modulation data) in measurement files with the extension “.DAE3”. The software evaluates the desired unit and format for output each time the data is visualized or exported. This allows verification of the complete software setup even after the measurement and allows correction of incorrect parameter settings. For example, if a measurement has been performed with a wrong crest factor parameter in the device setup, the parameter can be corrected afterwards and the data can be re-evaluated. The measured data can be visualized or exported in different units or formats, depending on the selected probe type ([V/m], [A/m], [°C], [m W/g], [m W/cm<sup>2</sup>], [dBrel], etc.). Some of these units are not available in certain situations or show meaningless results, e.g., a SAR output in a lossless media will always be zero. Raw data can also be exported to perform the evaluation with other software packages.

### 3.7.3 Data Evaluation by SEMCAD

The SEMCAD software automatically executes the following procedures to calculate the field units from the microvolt readings at the probe connector. The parameters used in the evaluation are stored in the configuration modules of the software:

Probe parameters:	- Sensitivity	Normi, ai0, ai1, ai2
	- Conversion factor	ConvFi
	- Diode compression point	Dcpi
Device parameters:	- Frequency	f
	- Crest factor	cf
Media parameters:	- Conductivity	ε
	- Density	ρ

These parameters must be set correctly in the software. They can be found in the component documents or they can be imported into the software from the configuration files issued for the DASY components. In the direct measuring mode of the multimeter option, the parameters of the actual system setup are used. In the scan visualization and export modes, the parameters stored in the corresponding document files are used.

The first step of the evaluation is a linearization of the filtered input signal to account for the compression characteristics of the detector diode. The compensation depends on the input signal, the diode type and the DC-transmission factor from the diode to the evaluation electronics.

If the exciting field is pulsed, the crest factor of the signal must be known to correctly compensate for peak power. The formula for each channel can be given as:

$$V_i = U_i + U_i^2 \cdot cf / dcpi$$

With  $V_i$  = compensated signal of channel  $i$  ( $i = x, y, z$ )

$U_i$  = input signal of channel  $i$  ( $i = x, y, z$ )

cf = crest factor of exciting field (DASY parameter)

dcpi = diode compression point (DASY parameter)

From the compensated input signals the primary field data for each channel can be evaluated:

E-field probes:

$$E_i = (V_i / Norm_i \cdot ConvF)^{1/2}$$

H-field probes:

$$H_i = (V_i)^{1/2} \cdot (a_{i0} + a_{i1}f + a_{i2}f^2) / f$$

With  $V_i$  = compensated signal of channel  $i$  ( $i = x, y, z$ )

Normi = sensor sensitivity of channel  $i$  ( $i = x, y, z$ )

[mV/(V/m)<sup>2</sup>] for E-field Probes

ConvF = sensitivity enhancement in solution

$a_{ij}$  = sensor sensitivity factors for H-field probes

$f$  = carrier frequency [GHz]

$E_i$  = electric field strength of channel  $i$  in V/m

$H_i$  = magnetic field strength of channel  $i$  in A/m

The RSS value of the field components gives the total field strength (Hermitian magnitude):

$$E_{tot} = (E_x^2 + E_y^2 + E_z^2)^{1/2}$$

The primary field data are used to calculate the derived field units.

$$SAR = (E_{tot}^2 \cdot \sigma) / (\epsilon \cdot 1000)$$

With SAR = local specific absorption rate in mW/g

$E_{tot}$  = total field strength in V/m

$\sigma$  = conductivity in [mho/m] or [Siemens/m]

$\epsilon$  = equivalent tissue density in g/cm<sup>3</sup>

Note that the density is normally set to 1 (or 1.06), to account for actual brain density rather than the density of the simulation liquid. The power flow density is calculated assuming the excitation field to be a free space field.

$$P_{pwe} = E_{tot}^2 / 3770 \quad \text{or} \quad P_{pwe} = H_{tot}^2 \cdot 37.7$$

with  $P_{pwe}$  = equivalent power density of a plane wave in mW/cm<sup>2</sup>

$E_{tot}$  = total electric field strength in V/m

$H_{tot}$  = total magnetic field strength in A/m

## 4 SAR measurement variability and uncertainty

### 4.1 SAR measurement variability

Per KDB865664 D01 SAR measurement 100 MHz to 6 GHz v01r04, SAR measurement variability must be assessed for each frequency band, which is determined by the SAR probe calibration point and tissue-equivalent medium used for the device measurements. The additional measurements are repeated after the completion of all measurements requiring the same head or body tissue-equivalent medium in a frequency band. The test device should be returned to ambient conditions (normal room temperature) with the battery fully charged before it is re-mounted on the device holder for the repeated measurement(s) to minimize any unexpected variations in the repeated results.

1) Repeated measurement is not required when the original highest measured SAR is  $< 0.80$  W/kg; steps 2) through 4) do not apply.

2) When the original highest measured SAR is  $\geq 0.80$  W/kg, repeat that measurement once.

3) Perform a second repeated measurement only if the ratio of largest to smallest SAR for the original and first repeated measurements is  $> 1.20$  or when the original or repeated measurement is  $\geq 1.45$  W/kg ( $\sim 10\%$  from the 1-g SAR limit).

4) Perform a third repeated measurement only if the original, first or second repeated measurement is  $\geq 1.5$  W/kg and the ratio of largest to smallest SAR for the original, first and second repeated measurements is  $> 1.20$ .

The same procedures should be adapted for measurements according to extremity and occupational exposure limits by applying a factor of 2.5 for extremity exposure and a factor of 5 for occupational exposure to the corresponding SAR thresholds.

## 4.2 SAR measurement uncertainty

Measurements and results are all in compliance with the standards listed in this report. All measurements and results are recorded and maintained at the laboratory performing the tests and measurement uncertainties are taken into account when comparing measurements to pass/ fail criteria. The Expanded uncertainty (95% CONFIDENCE INTERVAL) is **20.45% for 1g SAR and 20.28% for 10g SAR.**

A	b1	c	d	e=f(d,K)	f	g	i=C*g/e	i=C*g/e	k
Uncertainty Component	Section in P1528	Tol (%)	Prob. Dist	Div.	C <sub>i</sub> (1g)	C <sub>i</sub> (10g)	1-g ui(%)	10-g ui(%)	V <sub>i</sub> (V <sub>eff</sub> )
<b>Measurement System</b>									
Probe Calibration (k=1)	E.2.1	6.3	N	1	1	1	6.30	6.30	∞
Axial Isotropy	E.2.2	0.5	R	√3	0.7	0.7	0.20	0.20	∞
Hemispherical Isotropy	E.2.2	2.6	R	√3	0.7	0.7	1.06	1.06	∞
Boundary Effect	E.2.3	1.0	R	√3	1	1	0.58	0.58	∞
Linearity	E.2.4	0.6	R	√3	1	1	0.35	0.35	∞
System Detection LimitS	E.2.4	0.25	R	√3	1	1	0.14	0.14	∞
Modulation Response	E.2.5	2.4	R	√3	1	1	1.39	1.39	∞
Readout Electronics	E.2.6	0.3	N	1	1	1	0.30	0.30	∞
Response Time	E.2.7	0.0	R	√3	1	1	0.00	0.00	∞
Integration Time	E.2.8	2.6	R	√3	1	1	1.50	1.50	∞
RF Ambient Condition-Noise	E.6.1	3.0	R	√3	1	1	1.73	1.73	∞
RF Ambient Condition-Reflections	E.6.1	3.0	R	√3	1	1	1.73	1.73	∞
Probe Positioning-Mechanical Tolerance	E.6.2	1.5	R	√3	1	1	0.87	0.87	∞
Probe Positioning-with Respect to Phantom	E.6.3	2.9	R	√3	1	1	1.67	1.67	∞
Max. SAR Evaluation	E.5	1.0	R	√3	1	1	0.58	0.58	∞
<b>Test sample Related</b>									
Test sample Positioning	E.4.2	3.7	N	1	1	1	3.70	3.70	9
Device Holder Uncertainty	E.4.1	3.6	N	1	1	1	3.60	3.60	∞
Output Power Variation-SAR Drift Measurement	E.2.9	5	R	√3	1	1	2.89	2.89	∞
Output Power Variation-SAR Drift Measurement	E.6.5	0	R	√3	1	1	0.00	0.00	∞
<b>Phantom and Tissue Parameters</b>									
Phantom Uncertainty(Shape and Thickness Tolerances)	E.3.1	4	R	√3	1	1	2.31	2.31	∞
SAR Correction	E.3.2	1.9	N	1	1	0.84	1.90	1.60	∞
Liquid Conductivity (Measurement Uncertainty)	E.3.3	1.28	N	1	0.78	0.71	1.00	0.909	5
Liquid Permittivity (Measurement Uncertainty)	E.3.3	2.35	N	1	0.23	0.26	0.54	0.611	5
Liquid Conductivity (Temperature Uncertainty)	E.3.4	4.2	R	√3	0.78	0.71	1.89	1.72	∞
Liquid Permittivity ((Temperature Uncertainty)	E.3.4	3.7	R	√3	0.23	0.26	0.49	0.56	∞
<b>Combined Standard Uncertainty</b>				RSS			10.22	10.14	430
<b>Expanded Uncertainty (95% Confidence Interval)</b>				k=2			<b>20.45%</b>	<b>20.28%</b>	



## 5 Description of Test Position

### 5.1 Next to the Mouth Exposure Condition

Transmitters that are built-in within a wrist watch or similar wrist-worn devices typically operate in speaker mode for voice communication, with the device worn on the wrist and positioned next to the mouth. When SAR evaluation is required, next to the mouth use is evaluated with the front of the device positioned at 10 mm from a flat phantom filled with head tissue-equivalent medium. The wrist bands should be strapped together to represent normal use conditions

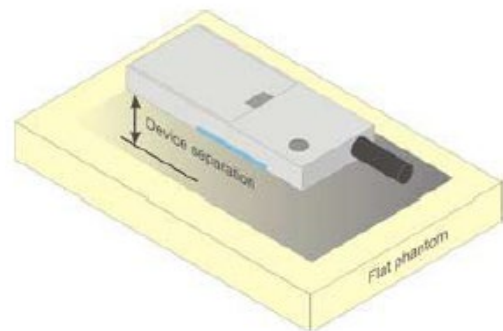
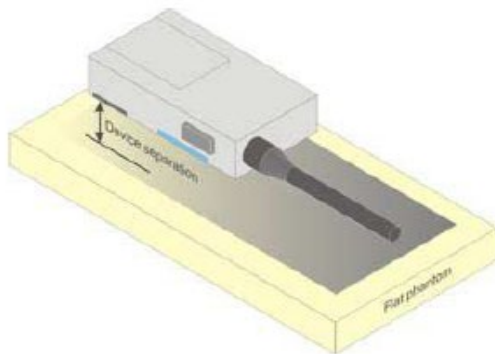

## 5.2 Extremity Exposure Condition

A limb-worn device is a unit whose intended use includes being strapped to the arm or leg of the user while transmitting (except in idle mode). The strap shall be opened so that it is divided into two parts as shown in the following. The device shall be positioned directly against the phantom surface with the strap straightened as much as possible and the back of the device towards the phantom. If the strap cannot normally be opened to allow placing in direct contact with the phantom surface, it may be necessary to break the strap of the device but ensuring to not damage the antenna.

The wrist bands should be strapped together to represent normal use conditions. SAR for wrist exposure is evaluated with the back of the device positioned in direct contact against a flat phantom filled with body tissue-equivalent medium. The wrist bands should be unstrapped and touching the phantom. The space introduced by the watch or wrist bands and the phantom must be representative of actual use conditions; otherwise, if applicable, the neck or a curved head region of the SAM phantom may be used, provided the device positioning and SAR probe access issues have been addressed through a KDB inquiry. When other device positioning and SAR measurement considerations are necessary, a KDB inquiry is also required for the test results to be acceptable; for example, devices with rigid wrist bands or electronic circuitry and/or antenna(s) incorporated in the wrist bands. These test configurations are applicable only to devices that are worn on the wrist and cannot support other use conditions; therefore, the operating restrictions must be fully demonstrated in both the test reports and user manuals.

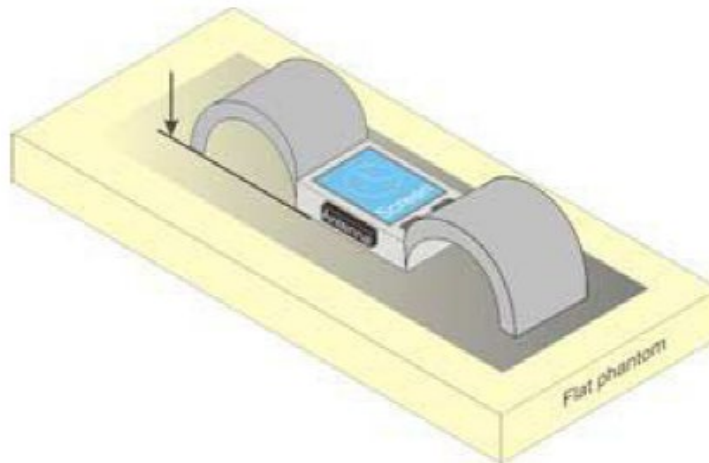

The EUT has two normal use condition, they are Next to the mouth device and wrist worn, and the test separation is 10mm and 0mm respectively.



## 6 SAR System Verification Procedure

### 6.1 Tissue Simulate Liquid

#### 6.1.1 Recipes for Tissue Simulate Liquid

The following tables give the recipes for tissue simulating liquids to be used in different frequency bands:

Ingredients (% by weight)	Frequency (MHz)									
	450		835		915		1900		2450	
Tissue Type	Head	Body	Head	Body	Head	Body	Head	Body	Head	Body
Water	38.56	51.16	41.45	52.4	41.05	56.0	54.9	40.4	62.7	73.2
Salt (NaCl)	3.95	1.49	1.45	1.4	1.35	0.76	0.18	0.5	0.5	0.04
Sugar	56.32	46.78	56.0	45.0	56.5	41.76	0.0	58.0	0.0	0.0
HEC	0.98	0.52	1.0	1.0	1.0	1.21	0.0	1.0	0.0	0.0
Bactericide	0.19	0.05	0.1	0.1	0.1	0.27	0.0	0.1	0.0	0.0
Triton X-100	0.0	0.0	0.0	0.0	0.0	0.0	0.0	0.0	36.8	0.0
DGBE	0.0	0.0	0.0	0.0	0.0	0.0	44.92	0.0	0.0	26.7
Dielectric Constant	43.42	58.0	42.54	56.1	42.0	56.8	39.9	54.0	39.8	52.5
Conductivity (S/m)	0.85	0.83	0.91	0.95	1.0	1.07	1.42	1.45	1.88	1.78
<p>HSL5GHz is composed of the following ingredients:</p> <p>Water: 50-65%</p> <p>Mineral oil: 10-30%</p> <p>Emulsifiers: 8-25%</p> <p>Sodium salt: 0-1.5%</p>										
<p>MSL5GHz is composed of the following ingredients:</p> <p>Water: 64-78%</p> <p>Mineral oil: 11-18%</p> <p>Emulsifiers: 9-15%</p> <p>Sodium salt: 2-3%</p>										

Table 3: Recipe of Tissue Simulate Liquid

## 6.1.2 Test Liquids Confirmation

### Simulated tissue liquid parameter confirmation

The dielectric parameters were checked prior to assessment using the SPEAG DAK3.5 dielectric probe kit. The dielectric parameters measured are reported in each correspondent section.

### **IEEE SCC-34/SC-2 P1528 recommended tissue dielectric parameters**

The head tissue dielectric parameters recommended by the IEEE SCC-34/SC-2 in P1528 have been incorporated in the following table. These head parameters are derived from planar layer models simulating the highest expected SAR for the dielectric properties and tissue thickness variations in a human head. Other head and body tissue parameters that have not been specified in P1528 are derived from the tissue dielectric parameters computed from the 4-Cole-Cole equations and extrapolated according to the head parameters specified in P1528

Target Frequency (MHz)	Head		Body	
	$\epsilon_r$	$\sigma$ (S/m)	$\epsilon_r$	$\sigma$ (S/m)
150	52.3	0.76	61.9	0.80
300	45.3	0.87	58.2	0.92
450	43.5	0.87	56.7	0.94
835	41.5	0.90	55.2	0.97
900	41.5	0.97	55.0	1.05
915	41.5	0.98	55.0	1.06
1450	40.5	1.20	54.0	1.30
1610	40.3	1.29	53.8	1.40
1800-2000	40.0	1.40	53.3	1.52
2450	39.2	1.80	52.7	1.95
3000	38.5	2.40	52.0	2.73
5800	35.3	5.27	48.2	6.00

( $\epsilon_r$  = relative permittivity,  $\sigma$  = conductivity and  $\rho = 1000 \text{ kg/m}^3$ )

### 6.1.3 Measurement for Tissue Simulate Liquid

The dielectric properties for this Tissue Simulate Liquids were measured by using the Agilent Model 85070E Dielectric Probe in conjunction with Agilent E5071C Network Analyzer (300 KHz-8500 MHz). The Conductivity ( $\sigma$ ) and Permittivity ( $\rho$ ) are listed in bellow table. For the SAR measurement given in this report. The temperature variation of the Tissue Simulate Liquids was  $22\pm 2^{\circ}\text{C}$ .

Tissue Type	Measured Frequency (MHz)	Conductivity ( $\sigma$ )	Permittivity ( $\epsilon_r$ )	Conductivity Target ( $\sigma$ )	Permittivity Target ( $\epsilon_r$ )	Delta ( $\sigma$ ) (%)	Delta ( $\epsilon_r$ ) (%)	Limit (%)	Liquid Temp. ( $^{\circ}\text{C}$ )	Date
2450 Head	2450	1.823	40.121	1.80	39.20	1.28	2.35	$\pm 5$	22	2021/2/25

Table 4: Measurement result of Tissue electric parameters

CH	Frequency (MHz)	Liquid Type	Conductivity ( $\sigma$ )	Permittivity ( $\epsilon_r$ )	Conductivity Target ( $\sigma$ )	Permittivity Target ( $\epsilon_r$ )	Delta ( $\sigma$ ) (%)	Delta ( $\epsilon_r$ ) (%)	Limit (%)	Date
1	2412	Head	1.791	40.3	1.77	39.27	1.19	2.54	$\pm 5$	2021/2/25
6	2437	Head	1.813	40.189	1.79	39.22	1.28	2.52	$\pm 5$	2021/2/25
11	2462	Head	1.836	40.063	1.81	39.18	1.44	2.20	$\pm 5$	2021/2/25
0	2402	Head	1.781	40.321	1.76	39.29	1.19	2.60	$\pm 5$	2021/2/25
39	2441	Head	1.815	40.173	1.79	39.22	1.40	2.48	$\pm 5$	2021/2/25
78	2480	Head	1.863	40.025	1.80	39.20	3.50	2.10	$\pm 5$	2021/2/25

Table 5: Measurement result of Tissue electric parameters for 3 channels

## 6.2 SAR System Check

The microwave circuit arrangement for system check is sketched in bellow figure. The daily system accuracy verification occurs within the flat section of the SAM phantom. A SAR measurement was performed to see if the measured SAR was within +/- 10% from the target SAR values. The tests were conducted on the same days as the measurement of the EUT. The obtained results from the system accuracy verification are displayed in the following table. During the tests, the ambient temperature of the laboratory was in the range  $22\pm 2^{\circ}\text{C}$ , the relative humidity was in the range 60% and the liquid depth above the ear reference points was above 15 cm in all the cases. It is seen that the system is operating within its specification, as the results are within acceptable tolerance of the reference values.

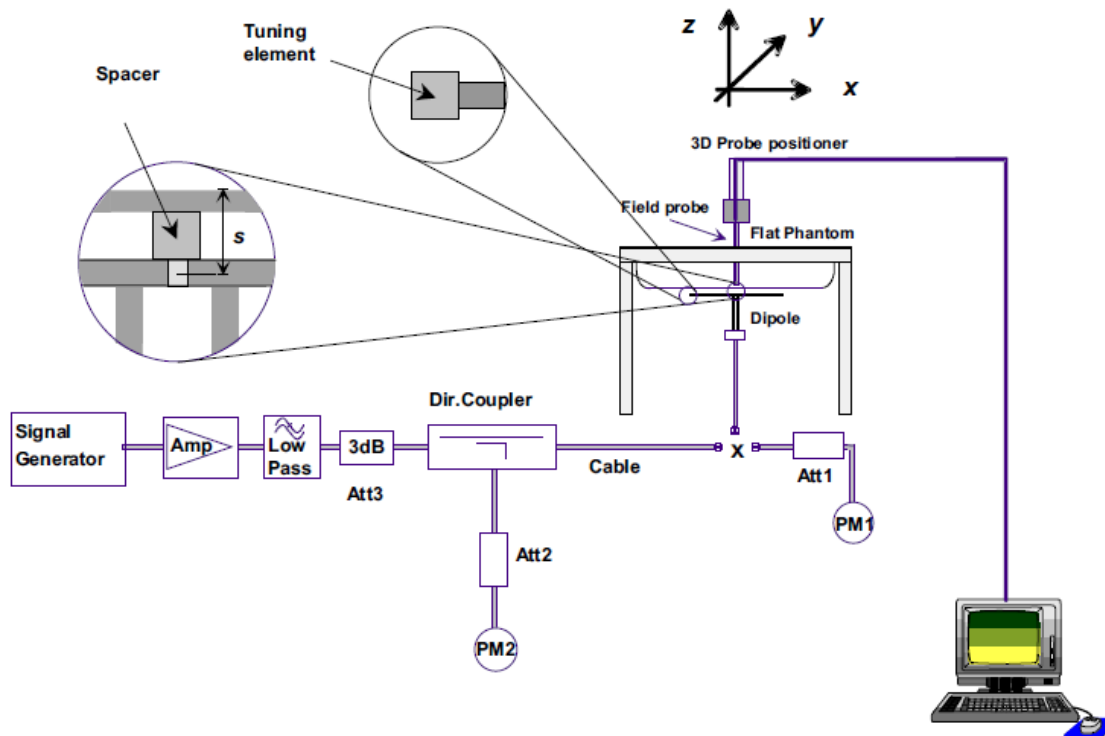

F-3. the microwave circuit arrangement used for SAR system verification

### 6.2.1 Justification for Extended SAR Dipole Calibrations

1) Referring to KDB865664 D01 requirements for dipole calibration, instead of the typical annual calibration recommended by measurement standards, longer calibration intervals of up to three years may be considered when it is demonstrated that the SAR target, impedance and return loss of a dipole have remain stable according to the following requirements. Each measured dipole is expected to evaluate with the following criteria at least on annual interval in Appendix C.

- a) There is no physical damage on the dipole;
- b) System check with specific dipole is within 10% of calibrated value;
- c) Return-loss is within 10% of calibrated measurement;
- d) Impedance is within  $5\Omega$  from the previous measurement.

2) Network analyzer probe calibration against air, distilled water and a shorting block performed before measuring liquid parameters.

### 6.2.2 Summary System Check Result(s)

Validation Kit	Measured SAR 250mW	Measured SAR 250mW	Measured SAR (normalized to 1W)	Measured SAR (normalized to 1W)	Target SAR (normalized to 1W) (±10%)	Target SAR (normalized to 1W) (±10%)	Liquid Temp. (°C)	Measured Date	
					1g (W/kg)	10g (W/kg)			1g (W/kg)
D2450 V2	Head	12.6	5.91	50.4	23.64	53 (47.70~58.30)	24.6 (22.14~27.60)	22	2021/2/25

Table 6: SAR System Check Result

### 6.2.3 Detailed System Check Results

Please see the Appendix A

## 7 Test Configuration

### 7.1 Operation Configurations

#### 7.1.1 Wi-Fi Test Configuration

A Wi-Fi device must be configured to transmit continuously at the required data rate, channel bandwidth and signal modulation, using the highest transmission duty factor supported by the test mode tools for SAR measurement.

##### 7.1.1.1 Duty cycle

1) 2.4GHz Wi-Fi 802.11b:

WI-FI1 802.11b 1M: Duty cycle=  $(47.54-38.94)/(47.64-38.94) = 98.85\%$

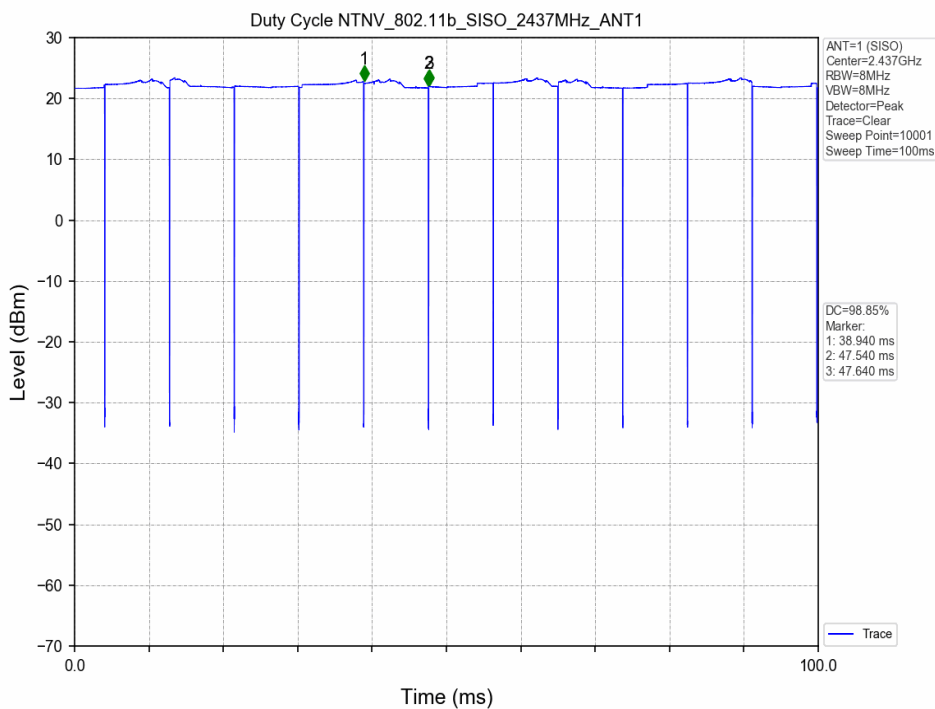

##### 7.1.1.2 Initial Test Position SAR Test Reduction Procedure

DSSS and OFDM configurations are considered separately according to the required SAR procedures. SAR is measured in the initial test position using the 802.11 transmission mode configuration required by the DSSS procedure or initial test configuration and subsequent test configuration(s) according to the OFDM procedures. The initial test position procedure is described in the following:

- 1) .When the reported SAR of the initial test position is  $\leq 0.4$  W/kg, further SAR measurement is not required for the other (remaining) test positions in that exposure configuration and 802.11 transmission mode combinations within the frequency band or aggregated band. SAR is also not required for that exposure configuration in the subsequent test configuration(s).
- 2) .When the reported SAR of the initial test position is  $> 0.4$  W/kg, SAR is repeated for the 802.11 transmission mode configuration tested in the initial test position using subsequent highest extrapolated or estimated 1-g SAR conditions determined by area scans or next closest/smallest test separation distance and maximum RF coupling test positions based on manufacturer justification, on the highest maximum output power channel, until the reported SAR is  $\leq 0.8$  W/kg or all required test positions (left, right, touch, tilt or subsequent

surfaces and edges) are tested.

- 3) . For all positions/configurations tested using the initial test position and subsequent test positions, when the reported SAR is  $> 0.8$  W/kg, SAR is measured for these test positions/configurations on the subsequent next highest measured output power channel(s) until the reported SAR is  $\leq 1.2$  W/kg or all required channels are tested. a) Additional power measurements may be required for this step, which should be limited to those necessary for identifying the subsequent highest output power channels.

### 7.1.1.3 Initial Test Configuration Procedures

An initial test configuration is determined for OFDM transmission modes according to the channel bandwidth, modulation and data rate combination(s) with the highest maximum output power specified for production units in each standalone and aggregated frequency band. SAR is measured using the highest measured maximum output power channel. For configurations with the same specified or measured maximum output power, additional transmission mode and test channel selection procedures are required. SAR test reduction for subsequent highest output test channels is determined according to *reported* SAR of the initial test configuration.

For next to the ear, hotspot mode and UMC mini-tablet exposure configurations where multiple test positions are required, the initial test position procedure is applied to minimize the number of test positions required for SAR measurement using the initial test configuration transmission mode. For fixed exposure conditions that do not have multiple SAR test positions, SAR is measured in the transmission mode determined by the initial test configuration.

When the *reported* SAR of the initial test configuration is  $> 0.8$  W/kg, SAR measurement is required for subsequent next highest measured output power channel(s) in the initial test configuration until *reported* SAR is  $\leq 1.2$  W/kg or all required channels are tested.

### 7.1.1.4 Subsequent Test Configuration Procedures

SAR measurement requirements for the remaining 802.11 transmission mode configurations that have not been tested in the initial test configuration are determined separately for each standalone and aggregated frequency band, in each exposure condition, according to the maximum output power specified for production units. The initial test position procedure is applied to next to the ear, UMPC mini-tablet and hotspot mode configurations. When the same maximum output power is specified for multiple transmission modes, additional power measurements may be required to determine if SAR measurements are required for subsequent highest output power channels in a subsequent test configuration. The subsequent test configuration and SAR measurement procedures are described in the following.

- 1) . When SAR test exclusion provisions of KDB Publication 447498 are applicable and SAR measurement is not required for the initial test configuration, SAR is also not required for the next highest maximum output power transmission mode subsequent test configuration(s) in that frequency band or aggregated band and exposure configuration.
- 2) . When the highest *reported* SAR for the initial test configuration (when applicable, include subsequent highest output channels), according to the initial test position or fixed exposure position requirements, is adjusted by the ratio of the subsequent test configuration to initial test configuration specified maximum output power and the adjusted SAR is  $\leq 1.2$  W/kg, SAR is not required for that subsequent test configuration.
- 3) . The number of channels in the initial test configuration and subsequent test configuration can be different due to differences in channel bandwidth. When SAR measurement is required for a subsequent test configuration and the channel bandwidth is smaller than that in the initial test configuration, all channels in the subsequent test configuration that overlap with the larger bandwidth channel tested in the initial test configuration should be used to determine the highest maximum output power channel. This step requires additional power measurement to identify the highest maximum output power channel in the subsequent test configuration to determine SAR test reduction.
  - a) SAR should first be measured for the channel with highest measured output power in the subsequent test configuration.
  - b) SAR for subsequent highest measured maximum output power channels in the subsequent test configuration is required only when the *reported* SAR of the preceding higher maximum output power channel(s) in the subsequent test configuration is  $> 1.2$  W/kg or until all required channels are tested. i) For channels with the same measured maximum output power, SAR should be measured using the channel closest to the center frequency of the larger channel bandwidth channel in the initial test configuration.



- 4) . SAR measurements for the remaining highest specified maximum output power OFDM transmission mode configurations that have not been tested in the initial test configuration (highest maximum output) or subsequent test configuration(s) (subsequent next highest maximum output power) is determined by recursively applying the subsequent test configuration procedures in this section to the remaining configurations according to the following:
- replace “subsequent test configuration” with “next subsequent test configuration” (i.e., subsequent next highest specified maximum output power configuration)
  - replace “initial test configuration” with “all tested higher output power configurations”

#### 7.1.1.5 2.4 GHz Wi-Fi SAR Procedures

Separate SAR procedures are applied to DSSS and OFDM configurations in the 2.4 GHz band to simplify DSSS test requirements. For 802.11b DSSS SAR measurements, DSSS SAR procedure applies to fixed exposure test position and initial test position procedure applies to multiple exposure test positions. When SAR measurement is required for an OFDM configuration, the initial test configuration, subsequent test configuration and initial test position procedures are applied. The SAR test exclusion requirements for 802.11g/n OFDM configurations are described in following.

- **802.11b DSSS SAR Test Requirements**

SAR is measured for 2.4 GHz 802.11b DSSS using either a fixed test position or, when applicable, the initial test position procedure. SAR test reduction is determined according to the following:

- 1) . When the reported SAR of the highest measured maximum output power channel for the exposure configuration is  $\leq 0.8$  W/kg, no further SAR testing is required for 802.11b DSSS in that exposure configuration.
- 2) . When the reported SAR is  $> 0.8$  W/kg, SAR is required for that exposure configuration using the next highest measured output power channel. When any reported SAR is  $> 1.2$  W/kg, SAR is required for the third channel; i.e., all channels require testing.

- **2.4 GHz 802.11g/n OFDM SAR Test Exclusion Requirements**

When SAR measurement is required for 2.4 GHz 802.11g/n OFDM configurations, the measurement and test reduction procedures for OFDM are applied (section 5.3, including sub-sections). SAR is not required for the following 2.4 GHz OFDM conditions.

- 1) . When KDB Publication 447498 SAR test exclusion applies to the OFDM configuration.
- 2) . When the highest reported SAR for DSSS is adjusted by the ratio of OFDM to DSSS specified maximum output power and the adjusted SAR is  $\leq 1.2$  W/kg.

### 7.1.2 BluetoothTest Configuration

For the Bluetooth SAR tests, a communication link is set up with the test mode software for BT mode test. Bluetooth USES frequency hopping technology to divide the transmitted data into packets and transmit the packets respectively through 79 designated Bluetooth channels, 1MHz Bandwidth, frequency hops at 1600 hops/second per the Bluetooth standard. The Radio Frequency Channel Number (RFCN) is allocated to 0, 39 and 78 respectively in the case of 2402~2480 MHz during the test at each test frequency channel, the EUT is operated at the RF continuous emission mode.

#### 7.1.2.1 Duty cycle

Bluetooth duty cycle:  $(5.882-2.994)/(6.744-2.994) = 77.01\%$

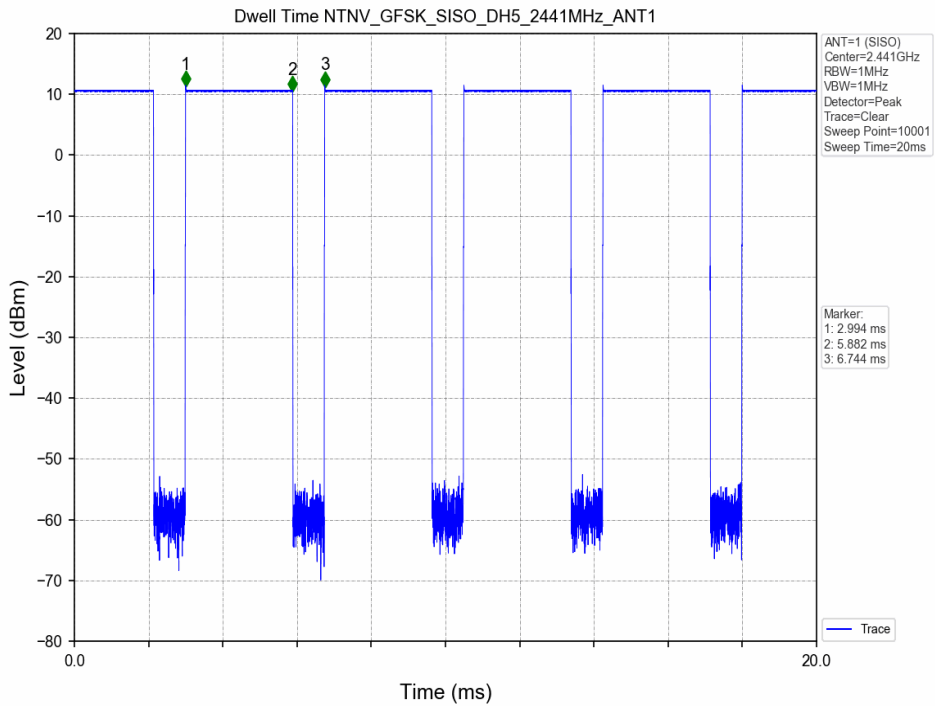

## 8 Test Result

### 8.1 Measurement of RF Conducted Power

#### 8.1.1 Conducted Power Of Wi-Fi and BT

Mode	Channel	Frequency (MHz)	Data Rate (Mbps)	Average Power (dBm)	Tune up	Power setting
802.11b	1	2412	1	15.15	17	18
	6	2437		<b>15.95</b>	17	18
	11	2462		15.64	17	18
802.11g	1	2412	6	14.81	16	17
	6	2437		15.52	16	17
	11	2462		14.32	16	17
802.11n HT20 SISO	1	2412	MCS0	14.53	16	17
	6	2437		15.32	16	17
	11	2462		15.08	16	17

Table 7: Conducted Power Of Wi-Fi

Note:

a) Power must be measured at each transmit antenna port according to the DSSS and OFDM transmission configurations in each standalone and aggregated frequency band.

b) Power measurement is required for the transmission mode configuration with the highest maximum output power specified for production units.

1) When the same highest maximum output power specification applies to multiple transmission modes, the largest channel bandwidth configuration with the lowest order modulation and lowest data rate is measured.

2) When the same highest maximum output power is specified for multiple largest channel bandwidth configurations with the same lowest order modulation or lowest order modulation and lowest data rate, power measurement is required for all equivalent 802.11 configurations with the same maximum output power.

c) For each transmission mode configuration, power must be measured for the highest and lowest channels; and at the mid-band channel(s) when there are at least 3 channels. For configurations with multiple mid-band channels, due to an even number of channels, both channels should be measured.

BT			Average Conducted Power (dBm)	Tune up (dBm)	Power setting
Modulation	Channel	Frequency (MHz)			
GFSK	0	2402	8.9	10.5	default
	39	2441	<b>9.6</b>	10.5	default
	78	2480	8.5	10.5	default
π/4DQPSK	0	2402	6.1	6.5	default
	39	2441	6.2	6.5	default
	78	2480	5.7	6.5	default
8DPSK	0	2402	5.4	6.5	default
	39	2441	6.1	6.5	default
	78	2480	5.3	6.5	default
BLE_1Mbps			Average Conducted Power (dBm)	Tune up (dBm)	Power setting
Modulation	Channel	Frequency (MHz)			
GFSK	0	2402	7.57	9.5	default
	19	2440	8.2	9.5	default
	39	2480	7.44	9.5	default

Table 8: Conducted Power Of BT

## 8.2 Stand-alone SAR test evaluation for FCC

Unless specifically required by the published RF exposure KDB procedures, standalone 1-g head or body and 10-g extremity SAR evaluation for general population exposure conditions, by measurement or numerical simulation, is not required when the corresponding SAR Test Exclusion Threshold condition is satisfied. These test exclusion conditions are based on source-based time-averaged maximum conducted output power of the RF channel requiring evaluation, adjusted for tune-up tolerance, and the minimum test separation distance required for the exposure conditions.

Freq. Band	Frequency (GHz)	Position	Average Power		Test Separation (mm)	Calculate Value	Exclusion Threshold	Exclusion (Y/N)
			dBm	mW				
Wi-Fi	2.45	Extremity	17	50.1	0	15.7	7.5	N
		Next to mouth	17	50.1	10	7.8	3	N
Bluetooth	2.48	Extremity	10.5	11.2	0	3.5	7.5	Y
		Next to mouth	10.5	11.2	10	1.8	3	Y

The 1-g and 10-g SAR test exclusion thresholds for 100 MHz to 6 GHz at test separation distances  $\leq 50$  mm are determined by:

$[(\text{max. power of channel, including tune-up tolerance, mW}) / (\text{min. test separation distance, mm})] \cdot [\sqrt{f(\text{GHz})}] \leq 3.0$  for 1-g SAR and  $\leq 7.5$  for 10-g extremity SAR, where

- $f(\text{GHz})$  is the RF channel transmit frequency in GHz
- Power and distance are rounded to the nearest mW and mm before calculation
- The result is rounded to one decimal place for comparison

The test exclusions are applicable only when the minimum test separation distance is  $\leq 50$  mm and for transmission frequencies between 100 MHz and 6 GHz. When the minimum test separation distance is  $< 5$  mm, a distance of 5 mm is applied to determine SAR test exclusion.

### 8.3 Stand-alone SAR test evaluation for IC

SAR evaluation is required if the separation distance between the user and/or bystander and the antenna and/or radiating element of the device is less than or equal to 20 cm, except when the device operates at or below the applicable output power level (adjusted for tune-up tolerance) for the specified separation distance defined in the following table.

Frequency (MHz)	Exemption Limits (mW)				
	At separation distance of ≤5 mm	At separation distance of 10 mm	At separation distance of 15 mm	At separation distance of 20 mm	At separation distance of 25 mm
≤300	71 mW	101 mW	132 mW	162 mW	193 mW
450	52 mW	70 mW	88 mW	106 mW	123 mW
835	17 mW	30 mW	42 mW	55 mW	67 mW
1900	7 mW	10 mW	18 mW	34 mW	60 mW
2450	4 mW	7 mW	15 mW	30 mW	52 mW
3500	2 mW	6 mW	16 mW	32 mW	55 mW
5800	1 mW	6 mW	15 mW	27 mW	41 mW

Frequency (MHz)	Exemption Limits (mW)				
	At separation distance of 30 mm	At separation distance of 35 mm	At separation distance of 40 mm	At separation distance of 45 mm	At separation distance of ≥50 mm
≤300	223 mW	254 mW	284 mW	315 mW	345 mW
450	141 mW	159 mW	177 mW	195 mW	213 mW
835	80 mW	92 mW	105 mW	117 mW	130 mW
1900	99 mW	153 mW	225 mW	316 mW	431 mW
2450	83 mW	123 mW	173 mW	235 mW	309 mW
3500	86 mW	124 mW	170 mW	225 mW	290 mW
5800	56 mW	71 mW	85 mW	97 mW	106 mW

Note:

- Output power level shall be the higher of the maximum conducted or equivalent isotropically radiated power (e.i.r.p.) source-based, time-averaged output power. For controlled use devices where the 8 W/kg for 1 gram of tissue applies, the exemption limits for routine evaluation in the above table are multiplied by a factor of 5. For limb-worn devices where the 10gram value applies, the exemption limits for routine evaluation in the above table are multiplied by a factor of 2.5. If the operating frequency of the device is between two frequencies located in the above table linear interpolation shall be applied for the applicable separation distance. For test separation distance less than 5 mm, the exemption limits for a separation distance of 5 mm can be applied to determine if a routine evaluation is required.
- For medical implants devices, the exemption limit for routine evaluation is set at 1mW. The output power of a medical implants device is defined as the higher of the conducted or e.i.r.p to determine whether the device is exempt from the SAR evaluation.

Freq.Band	Frequency (MHz)	Position	Max Power (dBm)	Antenna Gain (dBi)	Max Power (mW)	Test Separation (mm)	Exemption Limits (mW)	Exclusion (Yes/No)
WiFi2.4GHz	2450	Extremity	17	-4.40	50.1	0	10	No
	2450	Next to mouth	17	-4.40	50.1	10	7	No
Bluetooth	2450	Extremity	10.5	-4.40	11.2	0	10	No
	2450	Next to mouth	10.5	-4.40	11.2	10	7	No

## 8.4 Measurement of SAR Data

### 8.4.1 SAR Result Of 2.4GHz Wi-Fi

Test position	Test mode	Test Ch./Freq.	Duty Cycle	Duty Cycle Scaled factor	SAR (W/kg) 1-g	SAR (W/kg) 10-g	Power drift (dB)	Conducted power (dBm)	Tune up Limit (dBm)	Scaled factor	Scaled SAR (W/kg) 1-g	Liquid Temp.
Next to the mouth test data (Separate 10mm)												
Next to the mouth	802.11b	6/2437	98.85%	1.012	0.306	0.155	0.03	15.95	17.00	1.273	0.390	22.0
Next to the mouth	802.11b	1/2412	98.85%	1.012	0.257	0.133	0.04	15.15	17.00	1.528	0.393	22.0
Next to the mouth	802.11b	11/2462	98.85%	1.012	0.294	0.149	0.07	15.64	17.00	1.365	<b>0.401</b>	22.0
Test position	Test mode	Test Ch./Freq.	Duty Cycle	Duty Cycle Scaled factor	SAR (W/kg) 1-g	SAR (W/kg) 10-g	Power drift (dB)	Conducted power (dBm)	Tune up Limit (dBm)	Scaled factor	Scaled SAR (W/kg) 10-g	Liquid Temp.
Extremity test data (Separate 0mm)												
Back side	802.11b	6/2437	98.85%	1.012	0.651	0.325	-0.03	15.95	17.00	1.273	0.414	22.0
Back side	802.11b	1/2412	98.85%	1.012	0.549	0.276	-0.16	15.15	17.00	1.528	<b>0.422</b>	22.0
Back side	802.11b	11/2462	98.85%	1.012	0.597	0.293	-0.03	15.64	17.00	1.365	0.400	22.0

Table 9: SAR Result Of 2.4GHz Wi-Fi

Note:

- 1) The maximum Scaled SAR value is marked in bold. Graph results refer to Appendix B
- 2) If the reported (scaled) SAR measured at the middle channel or highest output power channel for each test configuration is  $\leq 0.8$  W/kg then testing at the other channels is not required for such test configuration(s). Per Kdb248227 D01, When the reported SAR is  $> 0.8$  W/kg, SAR is required for that exposure configuration using the next highest measured output power channel.
- 3) Each channel was tested at the lowest data rate.
- 4) Per KDB248227 D01, for Body SAR test of Wi-Fi 2.4G, SAR is measured for 2.4 GHz 802.11b DSSS using the initial test position procedure. The highest reported SAR for DSSS is adjusted by the ratio of OFDM 802.11g/n to DSSS specified maximum output power and the adjusted SAR is  $< 1.2$  W/kg, so SAR for 802.11g/n is not required.

### 8.4.2 SAR Result Of Bluetooth

Test position	Test mode	Test Ch./Freq.	Duty Cycle	Duty Cycle Scaled factor	SAR (W/kg) 1-g	SAR (W/kg) 10-g	Power drift (dB)	Conducted power (dBm)	Tune up Limit (dBm)	Scaled factor	Scaled SAR (W/kg) 1-g	Liquid Temp.
Next to the mouth test data (Separate 10mm)												
Next to the mouth	GFSK	39/2441	77.01%	1.299	0.043	0.022	0.17	9.60	10.50	1.230	<b>0.069</b>	22.0
Next to the mouth	GFSK	0/2402	77.01%	1.299	0.034	0.018	0.06	8.90	10.50	1.445	0.064	22.0
Next to the mouth	GFSK	78/2480	77.01%	1.299	0.026	0.014	0.02	8.50	10.50	1.585	0.054	22.0
Test position	Test mode	Test Ch./Freq.	Duty Cycle	Duty Cycle Scaled factor	SAR (W/kg) 1-g	SAR (W/kg) 10-g	Power drift (dB)	Conducted power (dBm)	Tune up Limit (dBm)	Scaled factor	Scaled SAR (W/kg) 10-g	Liquid Temp.
Extremity test data (Separate 0mm)												
Back side	GFSK	39/2441	77.01%	1.299	0.097	0.047	-0.13	9.60	10.50	1.230	<b>0.075</b>	22.0
Back side	GFSK	0/2402	77.01%	1.299	0.081	0.040	0.01	8.90	10.50	1.445	0.075	22.0
Back side	GFSK	78/2480	77.01%	1.299	0.074	0.035	0.10	8.50	10.50	1.585	0.072	22.0

Table 10: SAR Result Of Bluetooth

Note:

- 1) The maximum Scaled SAR value is marked in bold. Graph results refer to Appendix B
- 2) If the reported (scaled) SAR measured at the middle channel or highest output power channel for each test configuration is  $\leq 0.8$  W/kg then testing at the other channels is not required for such test configuration(s).



## 8.5 Multiple Transmitter Evaluation

### 8.5.1 Simultaneous SAR SAR test evaluation

#### Simultaneous Transmission

NO.	Simultaneous Transmission Configuration	Next to the mouth	Extremity
1	Bluetooth + Wi-Fi2.4GHz	No	No

Note:

1) Wi-Fi and Bluetooth share the same Tx antenna and can't transmit simultaneously.

## 9 Equipment list

Test Platform	SPEAG DASY5 Professional					
Location	Compliance Certification Services (Kunshan) Inc.					
Description	SAR Test System (Frequency range 300MHz-6GHz)					
Software Reference	DASY52 52.8.8(1222); SEMCAD X 14.6.10(7331)					
<b>Hardware Reference</b>						
Equipment	Manufacturer	Model	Serial Number	Calibration Date	Due date of calibration	
<input checked="" type="checkbox"/> P C	HP	Core(rm)3.16G	CZCO48171H	N/A	N/A	
<input checked="" type="checkbox"/> Signal Generator	Agilent	N5182A	MY50142015	2020/09/25	2021/09/24	
<input checked="" type="checkbox"/> S-Parameter Network Analyzer	Agilent	E5071B	MY42301382	2021/02/01	2022/01/31	
<input checked="" type="checkbox"/> DAK-3.5 probe	SPEAG	DAK-3.5	1102	N/A	N/A	
<input checked="" type="checkbox"/> Power meter	Anritsu	ML2495A	1445010	2020/04/21	2021/04/20	
<input checked="" type="checkbox"/> Power sensor	Anritsu	MA2411B	1339220	2020/04/21	2021/04/20	
<input checked="" type="checkbox"/> DAE	SPEAG	DAE4	1245	2020/05/27	2021/05/26	
<input checked="" type="checkbox"/> E-field PROBE	SPEAG	EX3DV4	3798	2020/05/29	2021/05/28	
<input checked="" type="checkbox"/> Dipole	SPEAG	D2450V2	817	2019/06/10	2022/06/09	
<input checked="" type="checkbox"/> Electro Thermometer	DTM	DTM3000	3030	2020/10/24	2021/10/23	
<input checked="" type="checkbox"/> Amplifier	Mini-circuits	ZVE-8G	110405	N/A	N/A	
<input checked="" type="checkbox"/> Amplifier	Mini-circuits	ZHL-42	QA1331003	N/A	N/A	
<input checked="" type="checkbox"/> 3db ATTENUATOR	MINI	MCL BW-S3W5	0533	N/A	N/A	
<input checked="" type="checkbox"/> DUMMY PROBE	SPEAG	DP_2	SPDP2001AA	N/A	N/A	
<input checked="" type="checkbox"/> Dual Directional Coupler	Woken	20W couple	DOM2BHW1A1	N/A	N/A	
<input checked="" type="checkbox"/> SAM PHANTOM (ELI4 v4.0)	SPEAG	QDOVA001BB	1102	N/A	N/A	
<input checked="" type="checkbox"/> Twin SAM Phantom	SPEAG	QD000P40CD	1609	N/A	N/A	
<input checked="" type="checkbox"/> ROBOT	SPEAG	TX60	F10/5E6AA1/A101	N/A	N/A	
<input checked="" type="checkbox"/> ROBOT KRC	SPEAG	CS8C	F10/5E6AA1/C101	N/A	N/A	
<input checked="" type="checkbox"/> LIQUID CALIBRATION KIT	ANTENNESSA	41/05 OCP9	00425167	N/A	N/A	

Note: All the equipments are within the valid period when the tests are performed.

All measurement facilities used to collect the measurement data are located at

No.10, Weiye Rd., Innovation Park, Eco & Tec. Development Part, Kunshan City, Jiangsu Province, China.

## **10 Calibration certificate**

Please see the Appendix C

## **11 Photographs**

Please see the Appendix D



## **Appendix A: Detailed System Check Results**

The plots are showing as followings.

Date: 2021/02/25

Test Laboratory: Compliance Certification Services Inc.

**System Performance Check-Head 2450MHz**

**DUT: Dipole 2450 MHz; Type: D2450V2; Serial: 817**

Communication System: UID 0, CW; Frequency: 2450 MHz; Duty Cycle: 1:1  
 Medium parameters used:  $f = 2450 \text{ MHz}$ ;  $\sigma = 1.823 \text{ S/m}$ ;  $\epsilon_r = 40.121$ ;  $\rho = 1000 \text{ kg/m}^3$   
 Phantom section: Flat Section  
 Measurement Standard: DASYS (IEEE/IEC/ANSI C63.19-2007)

**DASY5 Configuration:**

- Probe: EX3DV4 - SN3798; ConvF(7.27, 7.27, 7.27); Calibrated: 2020/05/29;
- Sensor-Surface: 1.4mm (Mechanical Surface Detection)
- Electronics: DAE4 Sn1245; Calibrated: 2020/05/27
- Phantom: ELI v4.0; Type: QDOVA001BB; Serial: TP:1102
- Measurement SW: DASYS2, Version 52.8 (8); SEMCAD X Version 14.6.10 (7331)

**Body/d=10mm, Pin=250 mW, dist=2.0mm (EX-Probe)/Area Scan (8x9x1):**

Measurement grid:  $dx=12\text{mm}$ ,  $dy=12\text{mm}$   
 Maximum value of SAR (measured) = 16.3 W/kg

**Body/d=10mm, Pin=250 mW, dist=2.0mm (EX-Probe)/Zoom Scan (7x7x7) (7x7x7)/Cube 0:** Measurement grid:  $dx=5\text{mm}$ ,  $dy=5\text{mm}$ ,  $dz=5\text{mm}$

Reference Value = 93.58 V/m; Power Drift = -0.16 dB  
 Peak SAR (extrapolated) = 22.8 W/kg  
**SAR(1 g) = 12.6 W/kg; SAR(10 g) = 5.91 W/kg**  
 Maximum value of SAR (measured) = 16.8 W/kg

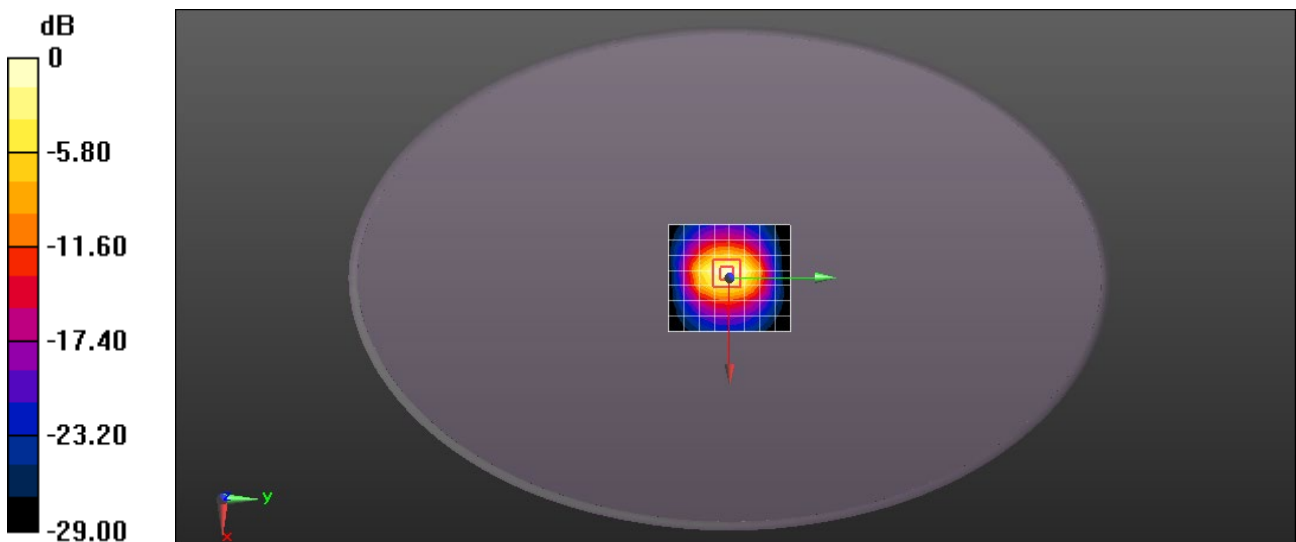

0 dB = 16.8 W/kg = 12.25 dBW/kg



## **Appendix B: Detailed Test Results**

**The plots of worse case are showing as followings.**

Date: 2021/02/25

Test Laboratory: Compliance Certification Services Inc.

**WLAN 2.4GHz 802.11b Next to the mouth 10mm Ch11**

**DUT: Smart Watch; Type: WH12068; Serial: AC01A0C XXXXX**

Communication System: UID 0, WiFi (0); Frequency: 2462 MHz; Duty Cycle: 1:1  
 Medium parameters used:  $f = 2462 \text{ MHz}$ ;  $\sigma = 1.836 \text{ S/m}$ ;  $\epsilon_r = 40.063$ ;  $\rho = 1000 \text{ kg/m}^3$   
 Phantom section: Flat Section  
 Measurement Standard: DASYS5 (IEEE/IEC/ANSI C63.19-2007)

**DASY5 Configuration:**

- Probe: EX3DV4 - SN3798; ConvF(7.27, 7.27, 7.27); Calibrated: 2020/05/29;
- Sensor-Surface: 1.4mm (Mechanical Surface Detection)
- Electronics: DAE4 Sn1245; Calibrated: 2020/05/27
- Phantom: ELI v4.0; Type: QDOVA001BB; Serial: TP:1102
- Measurement SW: DASYS52, Version 52.8 (8); SEMCAD X Version 14.6.10 (7331)

**Configuration/Body/Area Scan (7x7x1):** Measurement grid:  $dx=12\text{mm}$ ,  $dy=12\text{mm}$   
 Maximum value of SAR (measured) = 0.425 W/kg

**Configuration/Body/Zoom Scan (7x7x7)/Cube 0:** Measurement grid:  $dx=5\text{mm}$ ,  $dy=5\text{mm}$ ,  $dz=5\text{mm}$

Reference Value = 15.38 V/m; Power Drift = 0.07 dB

Peak SAR (extrapolated) = 0.587 W/kg

**SAR(1 g) = 0.294 W/kg; SAR(10 g) = 0.149 W/kg**

Maximum value of SAR (measured) = 0.464 W/kg

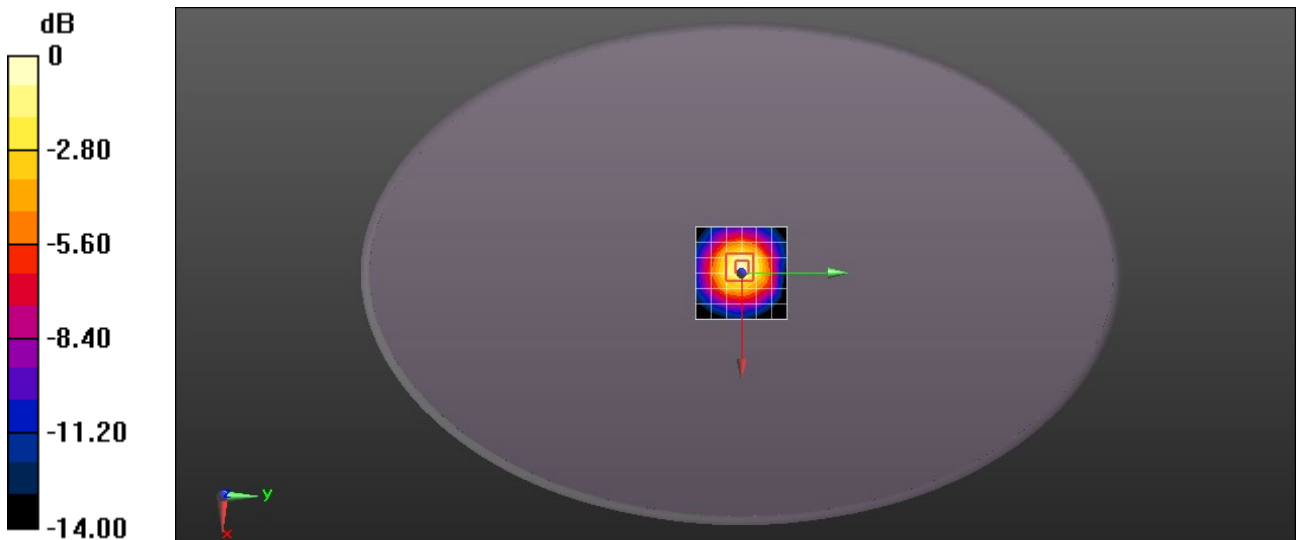

0 dB = 0.464 W/kg = -3.33 dBW/kg



Test Laboratory: Compliance Certification Services Inc.

**WLAN 2.4GHz 802.11b Back side 0mm Ch1**

**DUT: Smart Watch; Type: WH12068; Serial: AC01A0C XXXXX**

Communication System: UID 0, WiFi (0); Frequency: 2412 MHz; Duty Cycle: 1:1  
 Medium parameters used:  $f = 2412 \text{ MHz}$ ;  $\sigma = 1.791 \text{ S/m}$ ;  $\epsilon_r = 40.3$ ;  $\rho = 1000 \text{ kg/m}^3$   
 Phantom section: Flat Section  
 Measurement Standard: DASYS (IEEE/IEC/ANSI C63.19-2007)

**DASY5 Configuration:**

- Probe: EX3DV4 - SN3798; ConvF(7.27, 7.27, 7.27); Calibrated: 2020/05/29;
- Sensor-Surface: 1.4mm (Mechanical Surface Detection)
- Electronics: DAE4 Sn1245; Calibrated: 2020/05/27
- Phantom: ELI v4.0; Type: QDOVA001BB; Serial: TP:1102
- Measurement SW: DASYS2, Version 52.8 (8); SEMCAD X Version 14.6.10 (7331)

**Configuration/Body/Area Scan (6x6x1):** Measurement grid:  $dx=15\text{mm}$ ,  $dy=15\text{mm}$   
 Maximum value of SAR (measured) = 0.778 W/kg

**Configuration/Body/Zoom Scan (5x5x7)/Cube 0:** Measurement grid:  $dx=8\text{mm}$ ,  
 $dy=8\text{mm}$ ,  $dz=5\text{mm}$

Reference Value = 21.86 V/m; Power Drift = -0.16 dB

Peak SAR (extrapolated) = 1.05 W/kg

**SAR(1 g) = 0.549 W/kg; SAR(10 g) = 0.276 W/kg**

Maximum value of SAR (measured) = 0.820 W/kg

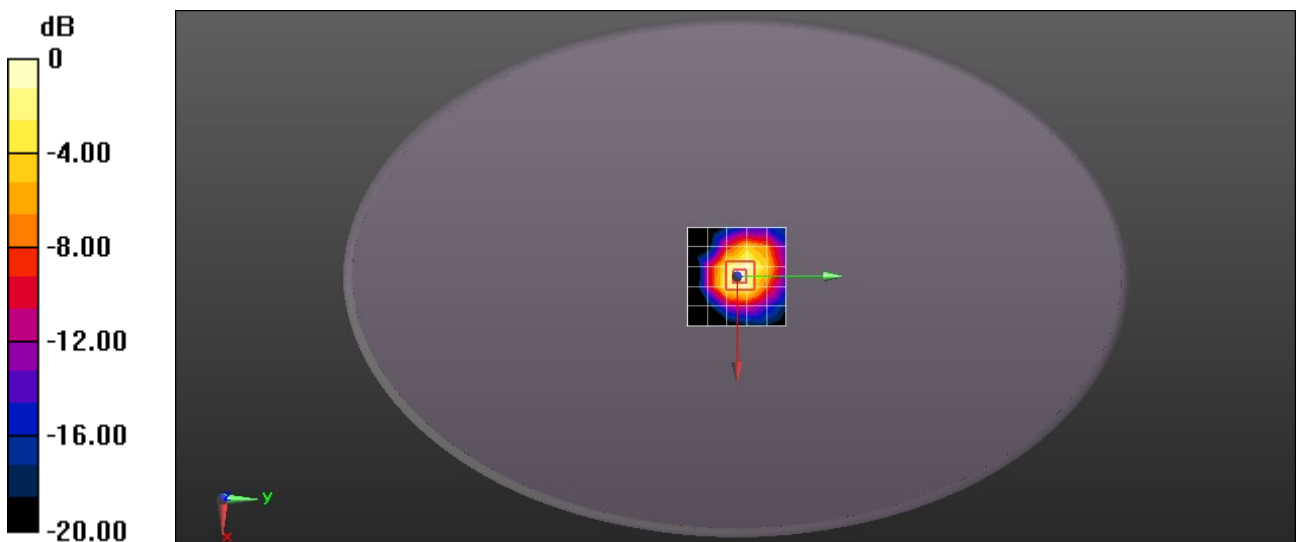

0 dB = 0.820 W/kg = -0.86 dBW/kg

Test Laboratory: Compliance Certification Services Inc.

**Bluetooth GFSK Next to the mouth 10mm Ch39**

**DUT: Smart Watch; Type: WH12068; Serial: AC01A0C XXXXX**

Communication System: UID 0, Bluetooth (0); Frequency: 2441 MHz; Duty Cycle: 1:1  
 Medium parameters used:  $f = 2441 \text{ MHz}$ ;  $\sigma = 1.815 \text{ S/m}$ ;  $\epsilon_r = 40.173$ ;  $\rho = 1000 \text{ kg/m}^3$   
 Phantom section: Flat Section  
 Measurement Standard: DASYS (IEEE/IEC/ANSI C63.19-2007)

**DASY5 Configuration:**

- Probe: EX3DV4 - SN3798; ConvF(7.27, 7.27, 7.27); Calibrated: 2020/05/29;
- Sensor-Surface: 1.4mm (Mechanical Surface Detection)
- Electronics: DAE4 Sn1245; Calibrated: 2020/05/27
- Phantom: ELI v4.0; Type: QDOVA001BB; Serial: TP:1102
- Measurement SW: DASYS2, Version 52.8 (8); SEMCAD X Version 14.6.10 (7331)

**Configuration/Body/Area Scan (7x7x1):** Measurement grid: dx=12mm, dy=12mm  
 Maximum value of SAR (measured) = 0.0678 W/kg

**Configuration/Body/Zoom Scan (7x7x7)/Cube 0:** Measurement grid: dx=5mm, dy=5mm, dz=5mm

Reference Value = 6.197 V/m; Power Drift = 0.17 dB

Peak SAR (extrapolated) = 0.0850 W/kg

**SAR(1 g) = 0.043 W/kg; SAR(10 g) = 0.022 W/kg**

Maximum value of SAR (measured) = 0.0668 W/kg

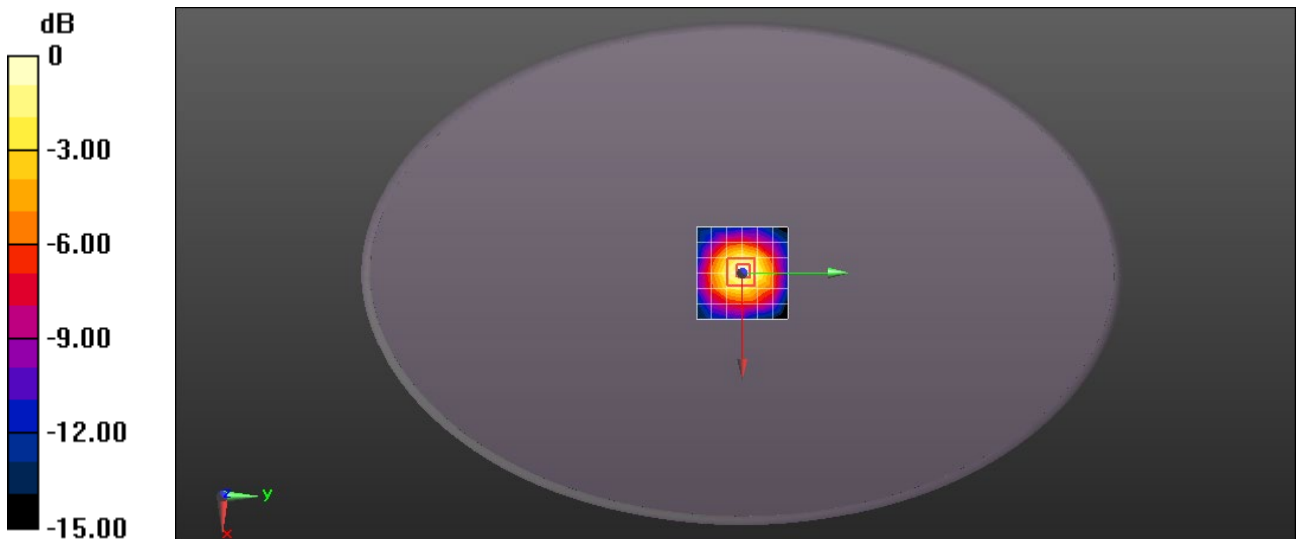

0 dB = 0.0668 W/kg = -11.75 dBW/kg

Test Laboratory: Compliance Certification Services Inc.

**Bluetooth GFSK Back side 0mm Ch39**

**DUT: Smart Watch; Type: WH12068; Serial: AC01A0C XXXXX**

Communication System: UID 0, Bluetooth (0); Frequency: 2441 MHz; Duty Cycle: 1:1  
 Medium parameters used:  $f = 2441 \text{ MHz}$ ;  $\sigma = 1.815 \text{ S/m}$ ;  $\epsilon_r = 40.173$ ;  $\rho = 1000 \text{ kg/m}^3$   
 Phantom section: Flat Section  
 Measurement Standard: DASYS (IEEE/IEC/ANSI C63.19-2007)

**DASY5 Configuration:**

- Probe: EX3DV4 - SN3798; ConvF(7.27, 7.27, 7.27); Calibrated: 2020/05/29;
- Sensor-Surface: 1.4mm (Mechanical Surface Detection)
- Electronics: DAE4 Sn1245; Calibrated: 2020/05/27
- Phantom: ELI v4.0; Type: QDOVA001BB; Serial: TP:1102
- Measurement SW: DASYS2, Version 52.8 (8); SEMCAD X Version 14.6.10 (7331)

**Configuration/Body/Area Scan (7x7x1):** Measurement grid:  $dx=12\text{mm}$ ,  $dy=12\text{mm}$   
 Maximum value of SAR (measured) = 0.144 W/kg

**Configuration/Body/Zoom Scan (7x7x7)/Cube 0:** Measurement grid:  $dx=5\text{mm}$ ,  $dy=5\text{mm}$ ,  $dz=5\text{mm}$

Reference Value = 8.545 V/m; Power Drift = -0.13 dB

Peak SAR (extrapolated) = 0.197 W/kg

**SAR(1 g) = 0.097 W/kg; SAR(10 g) = 0.047 W/kg**

Maximum value of SAR (measured) = 0.157 W/kg

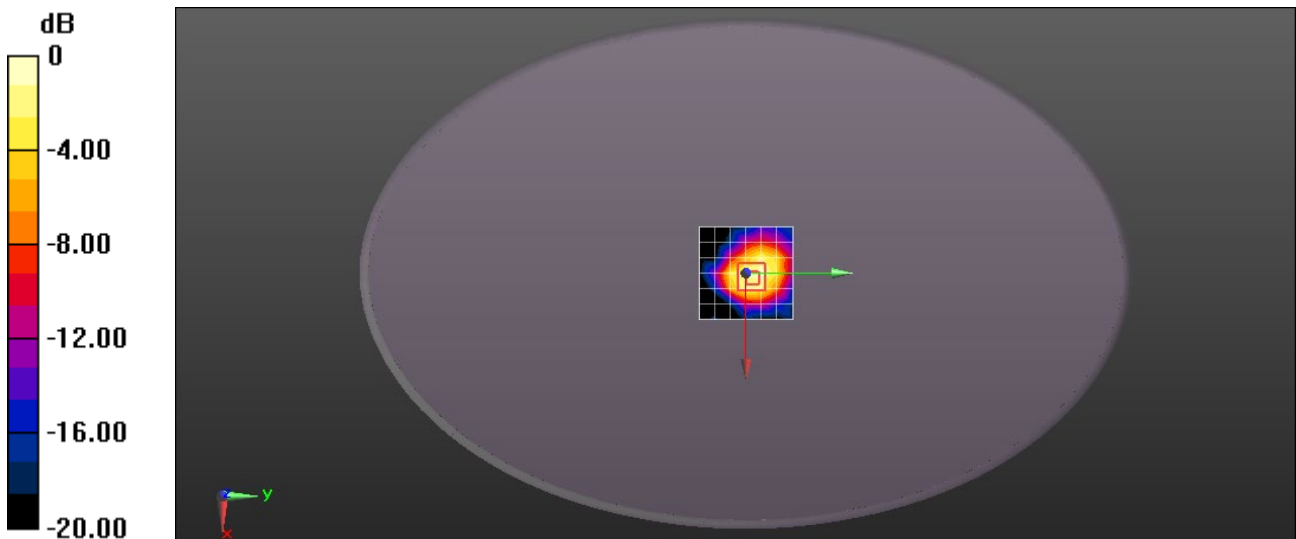

0 dB = 0.157 W/kg = -8.04 dBW/kg



## **Appendix C: Calibration certificate**

## **Appendix D: Photographs**

**---END---**

---