

  <p>ENSAYOS Nº 51/LE147</p>	FCC LISTED, REGISTRATION NUMBER: 720267  ISED LISTED REGISTRATION NUMBER ISED 4621A-4	Test report No: <b>NIE: 58741RRF.003</b>
<h2>Test report</h2> <p>REFERENCE STANDARD:                  USA FCC Part 27                  CANADA ISED RSS-139, RSS-130</p>		
Identification of item tested	IOT Module	
Trademark	nRF91	
Model and /or type reference	nRF9160	
Other identification of the product	FCC ID: 2ANPO00NRF9160 IC: 24529-NRF9160	
Features	LTE Cat-M1, LTE-NB1, GPS	
Applicant	Nordic Semiconductor ASA Yrttipellontie 1, 90230 Oulu, FINLAND	
Test method requested, standard	USA FCC Part 27 10-1-17 Edition. CANADA IC RSS-139 Issue 3, Jul. 2015. CANADA IC RSS-130 Issue 1, Oct. 2013. ANSI C63.26 – 2015.	
Summary	IN COMPLIANCE	
Approved by (name / position & signature)	A. Llamas RF Lab. Manager	
Date of issue	2018-11-23	
Report template No	FDT08_20	

## Index

Competences and guarantees .....	3
General conditions .....	3
Uncertainty .....	3
Usage of samples .....	4
Test sample description .....	4
Identification of the client.....	5
Testing period and place.....	5
Document history.....	5
Environmental conditions .....	5
Remarks and comments .....	6
Testing verdicts.....	7
Summary .....	7
Appendix A: Test results for FCC Part 27 / RSS-139 / RSS-130 .....	8

## Competences and guarantees

---

DEKRA Testing and Certification is a testing laboratory accredited by the National Accreditation Body (ENAC - Entidad Nacional de Acreditación), to perform the tests indicated in the Certificate No. 51/LE 147.

DEKRA Testing and Certification is a laboratory with a measurement facility in compliance with the requirements of Section 2.948 of the FCC rules and has been added to the list of facilities whose measurements data will be accepted in conjunction with applications for Certification under Parts 15 or 18 of the Commission's Rules. Registration Number: 720267.

DEKRA Testing and Certification is a laboratory with a measurement site in compliance with the requirements of RSS 212, Issue 1 (Provisional) and has been added to the list of filed sites of the Canadian Certification and Engineering Bureau. Reference File Number: ISED 4621A-4.

In order to assure the traceability to other national and international laboratories, DEKRA Testing and Certification has a calibration and maintenance program for its measurement equipment.

DEKRA Testing and Certification guarantees the reliability of the data presented in this report, which is the result of the measurements and the tests performed to the item under test on the date and under the conditions stated on the report and, it is based on the knowledge and technical facilities available at DEKRA Testing and Certification at the time of performance of the test.

DEKRA Testing and Certification is liable to the client for the maintenance of the confidentiality of all information related to the item under test and the results of the test.

The results presented in this Test Report apply only to the particular item under test established in this document.

**IMPORTANT:** No parts of this report may be reproduced or quoted out of context, in any form or by any means, except in full, without the previous written permission of DEKRA Testing and Certification.

## General conditions

---

1. This report is only referred to the item that has undergone the test.
2. This report does not constitute or imply on its own an approval of the product by the Certification Bodies or competent Authorities.
3. This document is only valid if complete; no partial reproduction can be made without previous written permission of DEKRA Testing and Certification.
4. This test report cannot be used partially or in full for publicity and/or promotional purposes without previous written permission of DEKRA Testing and Certification and the Accreditation Bodies.

## Uncertainty

---

Uncertainty (factor  $k=2$ ) was calculated according to the DEKRA Testing and Certification internal document PODT000.

## Usage of samples

Samples undergoing test have been selected by: the client.

Sample S/01 is composed of the following elements:

Control Nº	Description	Model	Serial Nº	Date of reception
58741C/025	IOT Module	nRF9160	IMEI: 352656100001406	2018-10-25

1. Sample S/01 has undergone the following test(s):

All tests indicated in Appendix A.

## Test sample description

Description of product .....	IOT Module that has Application CPU, LTE Cat-M1, Cat-NB1 Radio and GPS Receiver		
Rated power supply .....	Voltage and Frequency		
	<input type="checkbox"/>	AC:	
	<input checked="" type="checkbox"/>	DC: 3.8 Vdc.	
Software version .....	mfw-m1_nRF9160_0.6.7-31		
Hardware version .....	DEV2.1.6		
Mounting position .....	<input type="checkbox"/>	Table top equipment	
	<input type="checkbox"/>	Wall/Ceiling mounted equipment	
	<input type="checkbox"/>	Floor standing equipment	
	<input type="checkbox"/>	Hand-held equipment	
	<input checked="" type="checkbox"/>	Other: SMD Module	
Accessories (not part of the test item) .....	Description	Type	Manufacturer

## Identification of the client

NORDIC SEMIOCONDUCTOR ASA  
 P.O. Box 436, 0213 Oslo, NORWAY.

## Testing period and place

Test Location	DEKRA Testing and Certification S.A.U.
Date (start)	2018-11-01
Date (finish)	2018-11-19

## Document history

Report number	Date	Description
58741RRF.003	2018-11-23	First release

## Environmental conditions

In the control chamber, the following limits were not exceeded during the test:

Temperature	Min. = 15 °C Max. = 35 °C
Relative humidity	Min. = 20 % Max. = 75 %
Shielding effectiveness	> 100 dB
Electric insulation	> 10 kΩ
Reference resistance to earth	< 1 Ω

In the semianechoic chamber, the following limits were not exceeded during the test.

Temperature	Min. = 15 °C Max. = 35 °C
Relative humidity	Min. = 20 % Max. = 75 %
Air pressure	Min. = 860 mbar Max. = 1060 mbar
Shielding effectiveness	> 100 dB
Electric insulation	> 10 kΩ
Reference resistance to earth	< 1 Ω
Normal site attenuation (NSA)	< ±4 dB at 10 m distance between item under test and receiver antenna, (30 MHz to 1000 MHz)
Field homogeneity	More than 75% of illuminated surface is between 0 and 6 dB (26 MHz to 1000 MHz).

In the chamber for conducted measurements, the following limits were not exceeded during the test:

Temperature	Min. = 15 °C Max. = 35 °C
Relative humidity	Min. = 20 % Max. = 35 %
Air pressure	Min. = 860 mbar Max. = 1060 mbar
Shielding effectiveness	> 100 dB
Electric insulation	> 10 kΩ
Reference resistance to earth	< 1 Ω

## Remarks and comments

The tests have been performed by the technical personnel: José Alberto Aranda.

Used instrumentation:

### Conducted Measurements

	Last Cal. date	Cal. due date
1. Spectrum analyser Agilent E4440A	2017/10	2019/10
2. Vector signal analyzer Rohde & Schwarz FSQ8	2018/08	2020/08
3. Climatic chamber HERAEUS VM 04/35	2018/06	2020/06
4. DC power supply R&S NGPE 40/40	2018/02	2021/02
5. Universal Radio communication Tester R&S CMW50	2018/02	2019/02

### Radiated Measurements

	Last Cal. date	Cal. due date
1. Semianechoic Absorber Lined Chamber ETS FACT3 200STP	N.A.	N.A.
2. BiconicalLog antenna ETS LINDGREN 3142E	2018/07	2021/07
3. Multi Device Controller MESSTECHNIK DAV-RR	N.A.	N.A.
4. Double-ridge Guide Horn antenna 1-18 GHz SCHWARZBECK BBHA 9120 D	2018/01	2021/01
5. Spectrum analyser Rohde & Schwarz FSV40	2018/02	2020/02
6. EMI Test Receiver R&S ESR7	2017/08	2019/08
7. RF pre-amplifier 1-18 GHz Bonn Elektronik BLMA 0118-1M	2018/03	2019/03

## Testing verdicts

Not applicable :	N/A
Pass :	P
Fail :	F
Not measured :	N/M

## Summary

FCC PART 27 / RSS-139 / RSS-130 PARAGRAPH		
Requirement – Test case	Verdict	Remark
Clause 27.50 / RSS-139 Clause 6.5. / RSS-130 Clause 4.4.: RF output power	P	
Clause 2.1047 / RSS-139 Clause 6.2. / RSS-130 Clause 4.1.: Modulation characteristics	P	
Clause 27.54 / RSS-139 Clause 6.4. / RSS-130 Clause 4.3.: Frequency stability	P	
Clause 2.1049: Occupied Bandwidth	P	
Clause 27.53 / RSS-139 Clause 6.6. / RSS-130 Clause 4.6.: Spurious emissions at antenna terminals	P	
Clause 27.53 / RSS-139 Clause 6.6. / RSS-130 Clause 4.6.: Radiated emissions	P	
<u>Supplementary information and remarks:</u>		
None.		

## **Appendix A: Test results for FCC Part 27 / RSS-139 / RSS-130**



## INDEX

TEST CONDITIONS.....	10
RF Output Power .....	11
Frequency Stability .....	18
Occupied Bandwidth .....	22
Spurious emissions at antenna terminals.....	30
Spurious emissions at antenna terminals at Block Edges.....	38
Radiated emissions .....	57

## TEST CONDITIONS

Power supply (V):

Vnominal = 3.8 Vdc

Vmax = 4.37 Vdc

Vmin = 3.23 Vdc

The subscripts nom, min and max indicate voltage test conditions (nominal, minimum and maximum respectively, as declared by the applicant).

Type of power supply = DC Voltage from external power supply

Type of antenna = Integral antenna.

Declared Gain for antenna = 4.4 dBi for Band IV and 2.6 dBi for Band XIII

### TEST FREQUENCIES:

#### LTE. QPSK AND 16QAM MODULATION (BAND IV)

	Channel (Frequency. MHz)					
	BW = 1.4 MHz	BW = 3 MHz	BW = 5 MHz	BW = 10 MHz	BW = 15 MHz	BW = 20 MHz
Lowest	19957 (1710.7)	19965 (1711.5)	19975 (1712.5)	20000 (1715.0)	20025 (1717.5)	20050 (1720.0)
Middle	20175 (1732.5)	20175 (1732.5)	20175 (1732.5)	20175 (1732.5)	20175 (1732.5)	20175 (1732.5)
Highest	20393 (1754.3)	20385 (1753.5)	20375 (1752.5)	20350 (1750.0)	20325 (1747.5)	20300 (1745.0)

#### LTE. QPSK AND 16QAM MODULATION (BAND XIII)

	Channel (Frequency, MHz)	
	BW = 5 MHz	BW = 10 MHz
Lowest	23205 (779.5)	N/A
Middle	23230 (782.0)	23230 (782.0)
Highest	23255 (784.5)	N/A

## RF Output Power

### SPECIFICATION

FCC §27.50 (d) (4) & (5). RSS-139 Clause 6.5.

Fixed, mobile, and portable (hand-held) stations operating in the 1710-1755 MHz band are limited to 1 watt EIRP (30 dBm). Fixed stations operating in the 1710-1755 MHz band are limited to a maximum antenna height of 10 meters above ground. Mobile and portable stations operating in these bands must employ a means for limiting power to the minimum necessary for successful communications.

The peak-to-average ratio (PAR) of the transmission shall not exceed 13 dB.

FCC §27.50 (b) (9).

Control stations and mobile stations transmitting in the 746-757 MHz, 776-788 MHz, and 805-806 MHz bands and fixed stations transmitting in the 787-788 MHz and 805-806 MHz bands are limited to 30 watts ERP.

RSS-130 Clause 4.4.

The e.i.r.p. shall not exceed 50 watts (46.99 dBm) for mobile equipment or for outdoor fixed subscriber equipment nor shall it exceed 5 watts (36.99 dBm) for portable equipment or for indoor fixed subscriber equipment.

The peak-to-average power ratio (PAPR) of the transmission shall not exceed 13 dB.

### METHOD

The conducted RF output power measurements were made at the RF output terminals of the EUT using the power meter of the Universal Radio Communication tester R&S CMW500, selecting maximum transmission power of the EUT and different modes of modulation.

The maximum equivalent isotropically radiated power (e.i.r.p.) is calculated by adding the declared maximum antenna gain (dBi).

The maximum effective radiated power e.r.p. is calculated from the maximum equivalent isotropically radiated power (e.i.r.p.) by subtracting 2.15 dB:

$$E.R.P. = E.I.R.P. - 2.15 \text{ dB}$$

The peak-to-average power ratio (PAPR) is measured using an attenuator, power splitter and spectrum analyser with a Complementary Cumulative Distribution Function implemented.

The EUT was controlled via the Universal Radio Communication tester R&S CMW500 selecting maximum transmission power of the EUT and different modes of modulation.

## TEST SETUP

Conducted average power.



## Peak-to-average power ratio (PAPR)

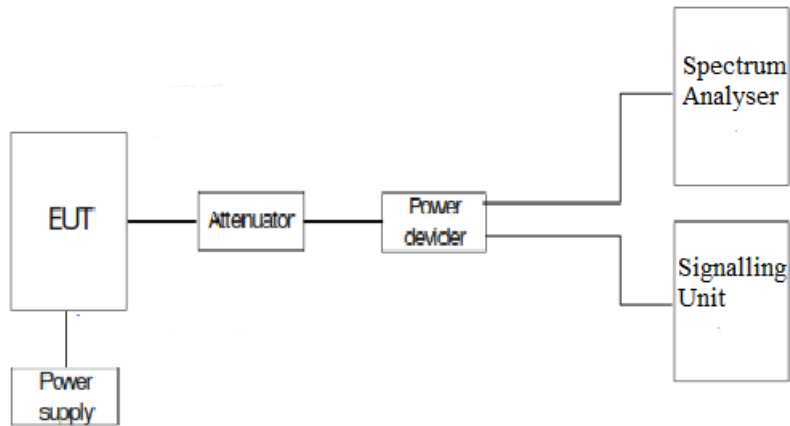

## RESULTS

MAXIMUM OUTPUT POWER (CONDUCTED).

LTE. BAND IV.

Preliminary measurements determined the narrow band = 1 and nominal bandwidth of 5 MHz as the worst case. The results in the next tables shows the results for this configuration.

Narrow band = 1

BANDWIDTH (MHz)	CHANNEL	FREQUENCY (MHz)	MODULATION	RB SIZE	RB OFFSET	AVERAGE POWER (dBm)	PAPR (dB)	
5	19975	1712.5	QPSK	1	0	22.10	6.28	
				6	0	21.24		
		16-QAM		1	0	22.27		
				5	0	20.34		
	20175	1732.5	QPSK	1	0	22.27		
				6	0	21.25		
	16-QAM		1	0	22.32	6.31		
			5	0	20.30			
2037	1752.5	QPSK	1	0	22.19			
			6	0	21.27			
	16-QAM		1	0	22.23	6.54		
			5	0	20.29			

LTE. BAND XIII.

Preliminary measurements determined the narrow band = 1 and nominal bandwidth of 5 MHz as the worst case. The results in the next tables shows the results for this configuration.

Narrow band = 1

BANDWIDTH (MHz)	CHANNEL	FREQUENCY (MHz)	MODULATION	RB SIZE	RB OFFSET	AVERAGE POWER (dBm)	PAPR (dB)	
5	23205	779.5	QPSK	1	0	22.53	6.17	
				6	0	21.60		
		16-QAM		1	0	22.61		
				5	0	20.68		
	23230	782	QPSK	1	0	22.54		6.17
				6	0	21.67		
	16-QAM		1	0	22.62			
			5	0	20.57			
23255	784.5	QPSK	1	0	22.49			
			6	0	21.62			
	16-QAM		1	0	22.60	6.12		
			5	0	20.65			

PEAK-TO-AVERAGE POWER RATIO (PAPR).

LTE. BAND IV.

Preliminary measurements determined the narrow band = 1, nominal bandwidth of 5 MHz, 16-QAM modulation and 5 RB size offset 0 as the worst case. The results in the next tables shows the results for this configuration.

Bandwidth = 5 MHz. Modulation 16-QAM. RB Size: 5. RB Offset: 0.

Channel Low:

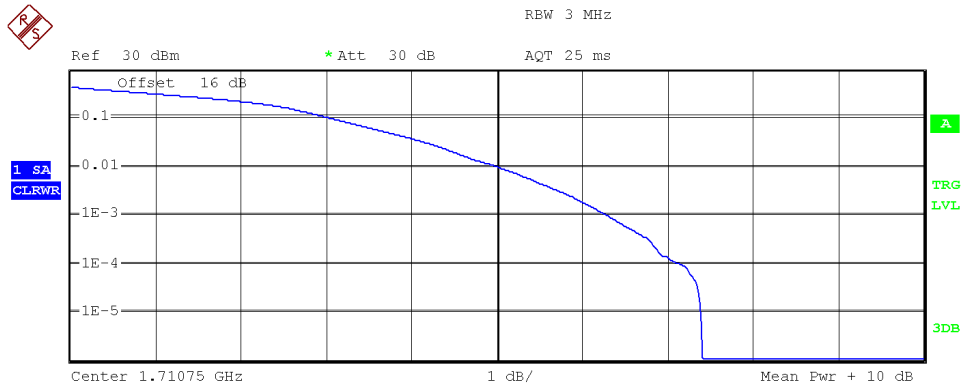

Complementary Cumulative Distribution Function  
 NOF samples: 100000, Usable BW: 3.5MHz

Trace 1	
Mean	20.05 dBm
Peak	27.45 dBm
Crest	7.40 dB
10 %	3.04 dB
1 %	5.00 dB
.1 %	6.28 dB
.01 %	7.13 dB

Channel Middle:

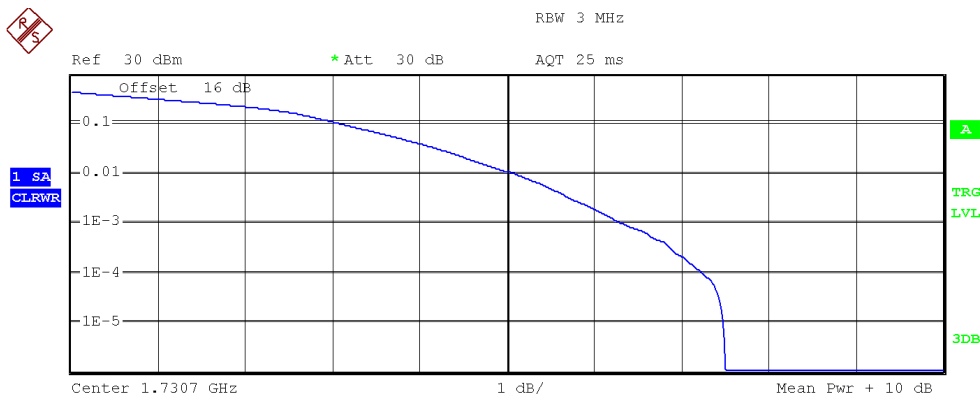

Complementary Cumulative Distribution Function  
 NOF samples: 100000, Usable BW: 3.5MHz

Trace 1	
Mean	20.09 dBm
Peak	27.59 dBm
Crest	7.50 dB
10 %	3.09 dB
1 %	5.08 dB
.1 %	6.31 dB
.01 %	7.23 dB

Channel High:

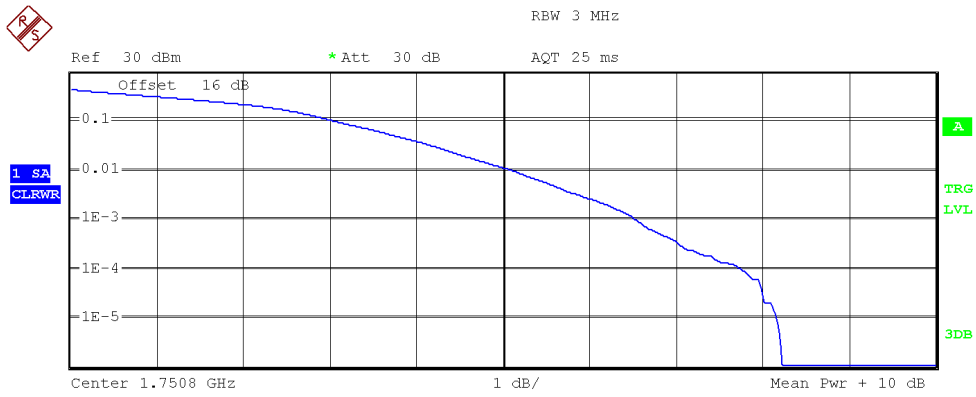

Center 1.7508 GHz 1 dB/ Mean Pwr + 10 dB  
 Complementary Cumulative Distribution Function  
 NOF samples: 100000, Usable BW: 3.5MHz

Trace 1	
Mean	20.07 dBm
Peak	28.30 dBm
Crest	8.23 dB
10 %	3.06 dB
1 %	5.10 dB
.1 %	6.54 dB
.01 %	7.74 dB

LTE. BAND XIII.

Preliminary measurements determined the narrow band = 1, nominal bandwidth of 5 MHz, 16-QAM modulation and 5 RB size offset 0 as the worst case. The results in the next tables shows the results for this configuration

Bandwidth = 5 MHz. Modulation 16 QAM. RB Size: 5. RB Offset: 0.

Channel Low:

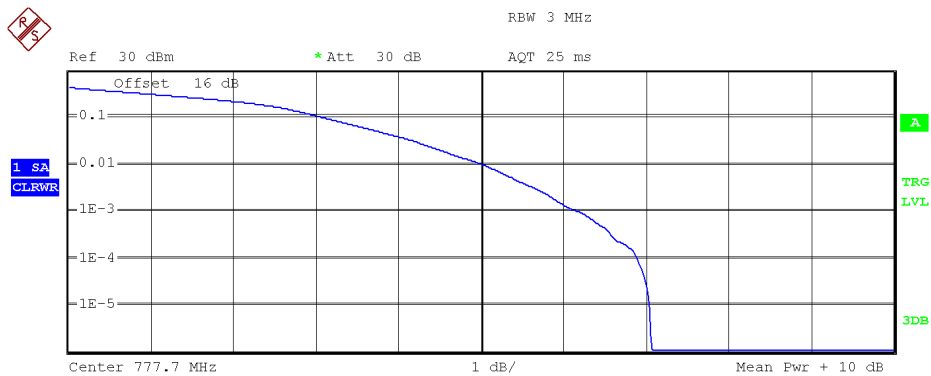

Center 777.7 MHz 1 dB/ Mean Pwr + 10 dB  
 Complementary Cumulative Distribution Function  
 NOF samples: 100000, Usable BW: 3.5MHz

Trace 1	
Mean	20.24 dBm
Peak	27.30 dBm
Crest	7.06 dB
10 %	3.09 dB
1 %	5.02 dB
.1 %	6.17 dB
.01 %	6.89 dB

Channel Middle:

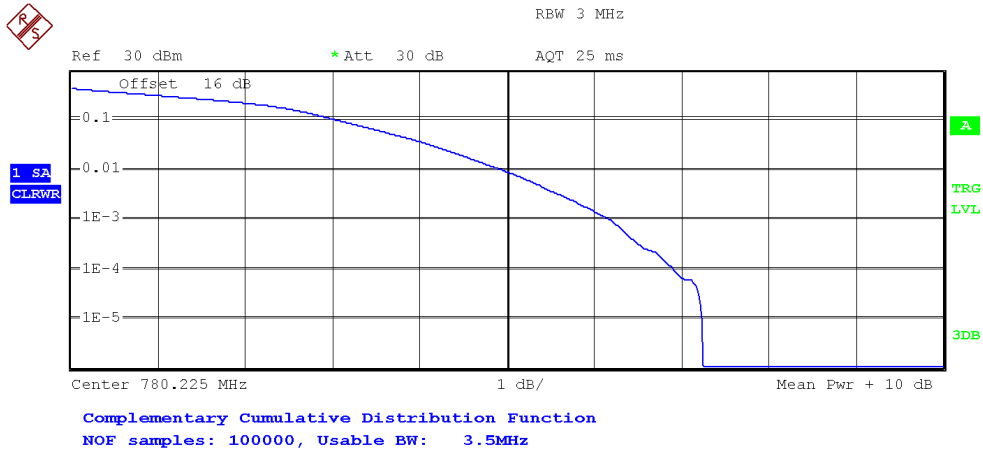

	Trace 1
Mean	20.34 dBm
Peak	27.59 dBm
Crest	7.25 dB
10 %	3.06 dB
1 %	4.94 dB
.1 %	6.17 dB
.01 %	6.91 dB

Channel High:

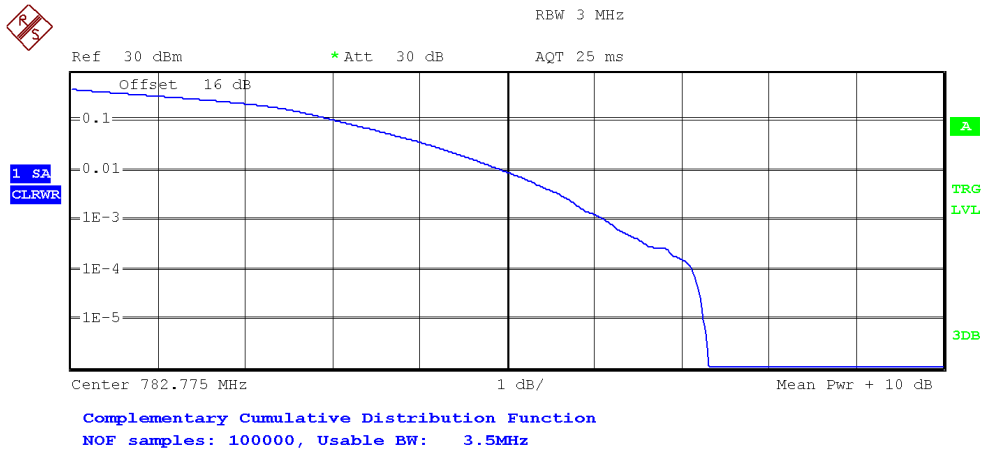

	Trace 1
Mean	20.34 dBm
Peak	27.66 dBm
Crest	7.31 dB
10 %	3.04 dB
1 %	4.95 dB
.1 %	6.12 dB
.01 %	7.13 dB



LTE BAND IV.

Channel	Measured maximum average power (dBm) at antenna port	Maximum declared antenna gain (dBi)	Maximum equivalent isotropically radiated power (E.I.R.P.) (dBm)	Maximum effective radiated power E.R.P. (dBm)	PAPR (dB)
Lowest	22.27	4.4	26.67	24.52	6.28
Middle	22.32	4.4	26.72	24.57	6.31
Highest	22.23	4.4	26.63	24.48	6.54
Measurement uncertainty (dB)	<±1.11				

LTE BAND XIII.

Channel	Measured maximum average power (dBm) at antenna port	Maximum declared antenna gain (dBi)	Maximum equivalent isotropically radiated power (E.I.R.P.) (dBm)	Maximum effective radiated power E.R.P. (dBm)	PAPR (dB)
Lowest	22.61	2.6	25.21	23.06	6.17
Middle	22.62	2.6	25.22	23.07	6.17
Highest	22.60	2.6	25.20	23.05	6.12
Measurement uncertainty (dB)	<±1.11				

Verdict: PASS

## Frequency Stability

### SPECIFICATION

FCC §2.1055 and §27.54.

The frequency stability shall be sufficient to ensure that the fundamental emission stays within the authorized frequency block.

RSS-139 Clause 6.4.

The frequency stability shall be sufficient to ensure that the occupied bandwidth stays within the operating frequency block when tested to the temperature and supply voltage variations specified in RSS-Gen.

RSS-130. Clause 4.3.

The applicant shall ensure frequency stability by showing that  $f_L$  minus the frequency offset and  $f_H$  plus the frequency offset shall be within the frequency range in which the equipment is designed to operate.

### METHOD

The frequency tolerance measurements over temperature variations were made over the temperature range of  $-30^{\circ}\text{C}$  to  $+50^{\circ}\text{C}$ . The EUT was placed inside a climatic chamber and the temperature was raised hourly in  $10^{\circ}\text{C}$  steps from  $-30^{\circ}\text{C}$  up to  $+50^{\circ}\text{C}$ .

The supply voltage was varied between 85% and 115% of nominal voltage.

The EUT was set in "Radio Resource Control (RRC) mode" in the middle channel using the Universal Radio Communication tester R&S CMW500 and the maximum frequency error was measured using the built-in calibrated frequency meter.

The worst case LTE mode for conducted power was used for the test.

In order to check that the frequency stability is sufficient such that the fundamental emissions stay within the authorized bands of operation, a reference point is established at the applicable unwanted emissions limit using a RBW equal to the RBW required by the unwanted emissions specification of the applicable regulatory standard. These reference points measured using the lowest and highest channel of operation are identified as  $f_L$  and  $f_H$  respectively. The worst-case frequency offset determined in the above methods is added or subtracted from the values of  $f_L$  and  $f_H$  to check that the resulting frequencies remain within the band.

The reference point measurements were made at the RF output terminals of the EUT using an attenuator, power splitter and spectrum analyser. The EUT was controlled via the Universal Radio Communication tester R&S CMW500 selecting maximum transmission power of the EUT and different modes of modulation.

## TEST SETUP

Frequency tolerance.

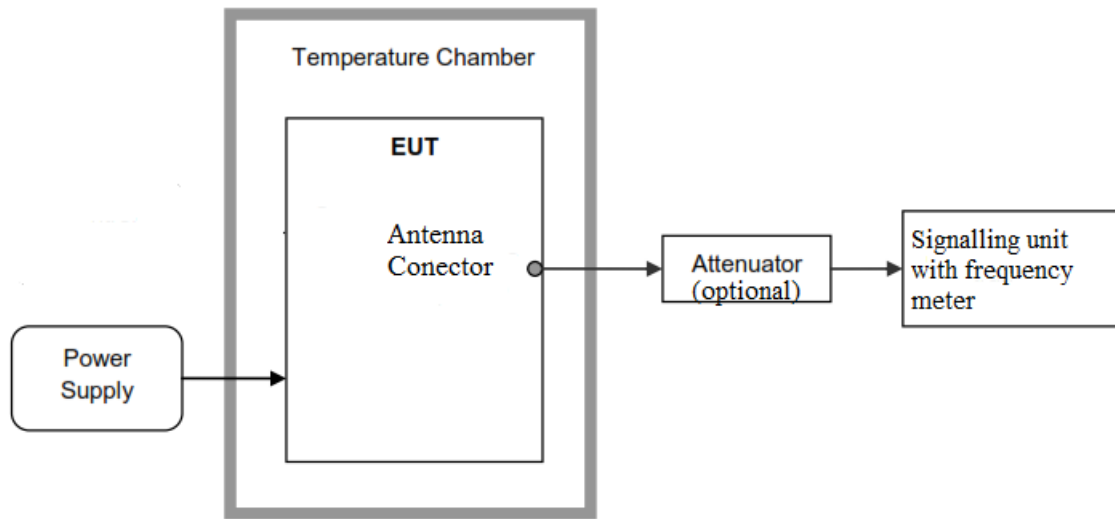

Reference points  $f_L$  and  $f_H$ .

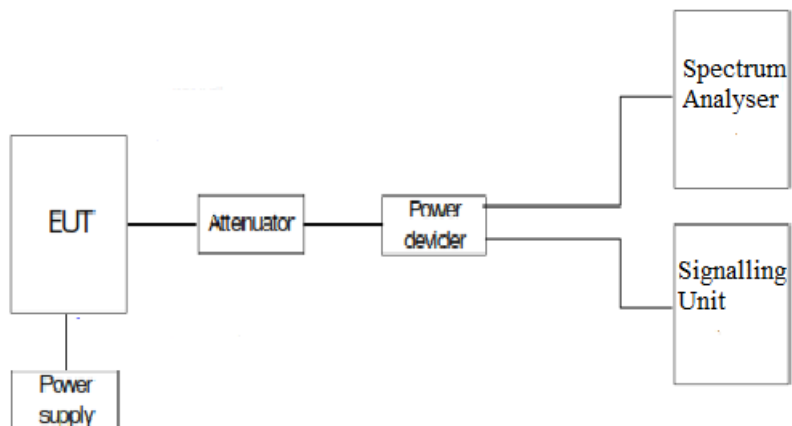

## RESULTS

### Frequency stability over temperature variations.

#### LTE Band IV

Temperature (°C)	Frequency Error (Hz)	Frequency Error (ppm)
+50	6.78	0.003913420
+40	-5.45	-0.003145743
+30	4.19	0.002418470
+20	-1.40	-0.000808081
+10	-4.19	-0.002418470
0	-3.99	-0.002303030
-10	-5.79	-0.003341991
-20	-1.75	-0.001010101
-30	-1.73	-0.000998557

#### LTE Band XIII

Temperature (°C)	Frequency Error (Hz)	Frequency Error (ppm)
+50	-2.98	-0.003810742
+40	3.18	0.004066496
+30	-6.47	-0.008273657
+20	5.39	0.006892583
+10	3.09	0.003951407
0	-5.65	-0.007225064
-10	-11.12	-0.014219949
-20	1.53	0.001956522
-30	0.73	0.000933504

### Frequency stability over voltage variations.

#### LTE Band IV

Battery Supply voltage	Voltage (V)	Frequency Error (Hz)	Frequency Error (ppm)
Vmax	4.37	-2.56	-0.001477633
Vmin	3.23	-3.19	-0.001841270

LTE Band XIII

Battery Supply voltage	Voltage (V)	Frequency Error (Hz)	Frequency Error (ppm)
Vmax	4.37	-6.98	-0.008925831
Vmin	3.23	-4.18	-0.005345269

Reference points established at the applicable unwanted emissions limit (worst case):

	LTE Band IV
$f_L$ (MHz)	1710.0511
$f_H$ (MHz)	1754.9530

	LTE Band XIII
$f_L$ (MHz)	777.0611
$f_H$ (MHz)	786.9489

Reference points  $f_L$  and  $f_H$  with the worst-case frequency offsets added or subtracted:

	LTE Band IV
$f_L$ (MHz)	1710.0511
$f_H$ (MHz)	1754.9530

	LTE Band XIII
$f_L$ (MHz)	777.0611
$f_H$ (MHz)	786.9489

The reference frequency points stay within the authorized blocks.

Verdict: PASS

## Occupied Bandwidth

### SPECIFICATION

§2.1049

### METHOD

The occupied bandwidth measurement was performed at the output terminals of the EUT using an attenuator, power splitter and spectrum analyser. The EUT was controlled via the Universal Radio Communication tester R&S CMW500 selecting maximum transmission power of the EUT and different modes of modulation. The 99% occupied bandwidth and the -26 dBc bandwidth were measured directly using the built-in bandwidth measuring option of spectrum analyser.

### TEST SETUP

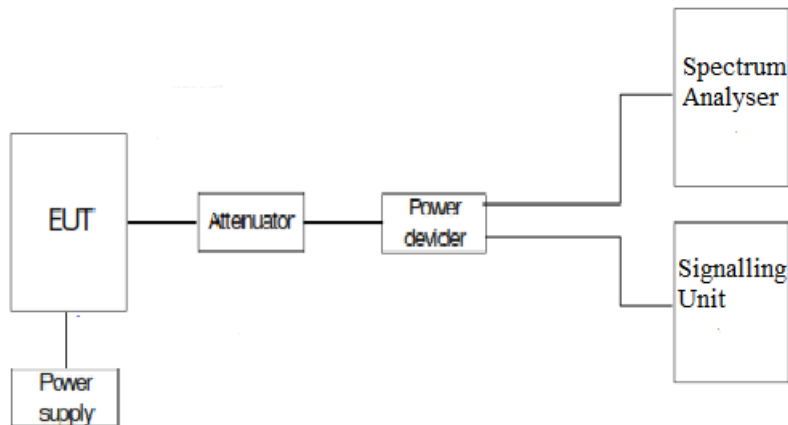

### RESULTS (see next plots)

The worst case of occupied bandwidth corresponds to all Resource Blocks (RB) offset 0 regardless either the Narrow band position or the nominal bandwidth selected.

LTE QPSK MODULATION. BW = 5 MHz (Band IV). Narrow band: 1.

Channel	Lowest	Middle	Highest
99% Occupied bandwidth (MHz)	1.1043	1.1018	1.1206
-26 dBc bandwidth (MHz)	1.3390	1.4780	1.3510
Measurement uncertainty (kHz)	<±16.67		

LTE 16QAM MODULATION. BW = 5 MHz (Band IV). Narrow band: 1.

Channel	Lowest	Middle	Highest
99% Occupied bandwidth (MHz)	0.9414	0.9398	0.9437
-26 dBc bandwidth (MHz)	1.2990	1.2950	1.3530
Measurement uncertainty (kHz)	<±16.67		

LTE QPSK MODULATION. BW = 5 MHz (Band XIII). Narrow band: 1.

Channel	Lowest	Middle	Highest
99% Occupied bandwidth (MHz)	1.1140	1.1036	1.1029
-26 dBc bandwidth (MHz)	1.3820	1.3610	1.4340
Measurement uncertainty (kHz)	<±16.67		

LTE 16QAM MODULATION. BW = 5 MHz (Band XIII). Narrow band: 1.

Channel	Lowest	Middle	Highest
99% Occupied bandwidth (MHz)	0.9470	0.9471	0.9319
-26 dBc bandwidth (MHz)	1.3560	1.3270	1.2720
Measurement uncertainty (kHz)	<±16.67		

LTE QPSK MODULATION. BW = 5 MHz (Band IV)

Lowest Channel

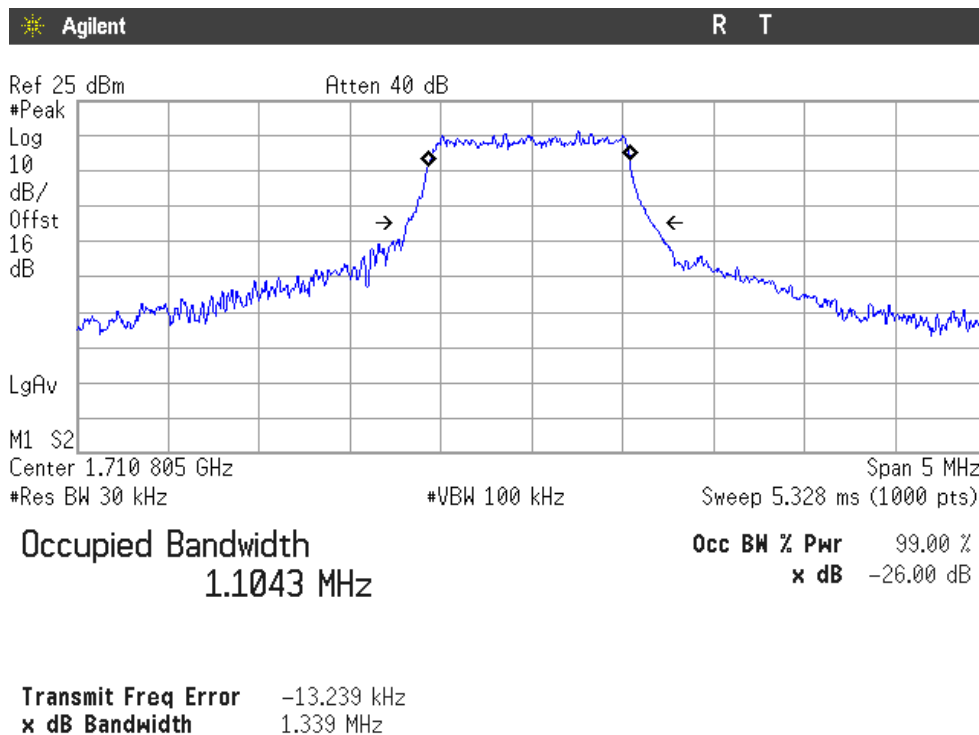

### Middle Channel

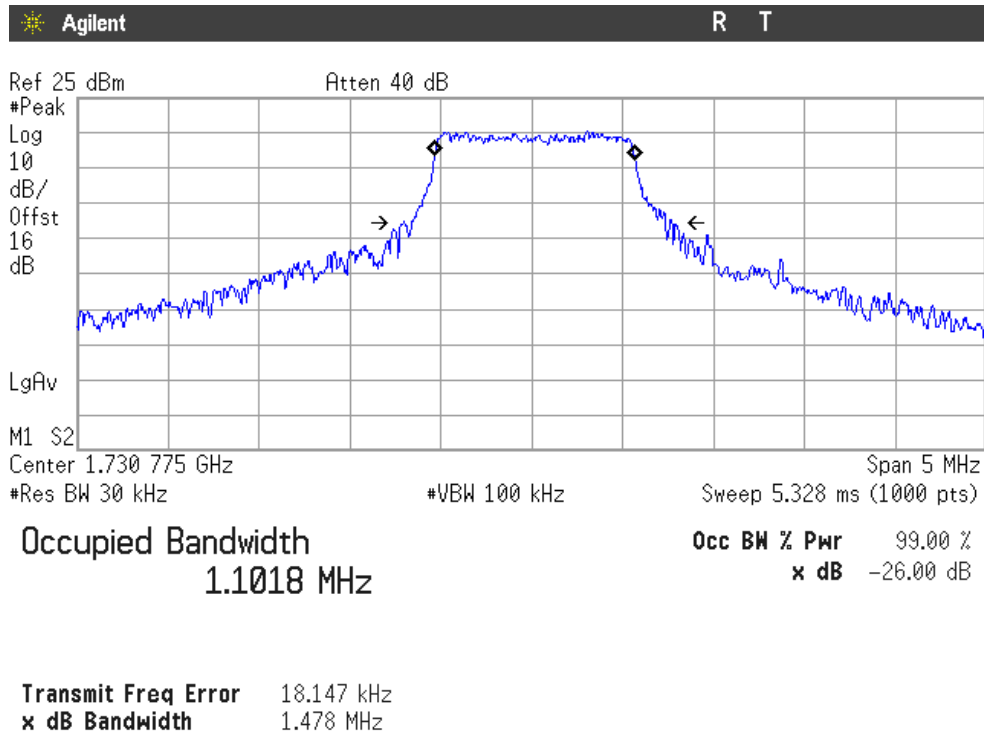

### Highest Channel

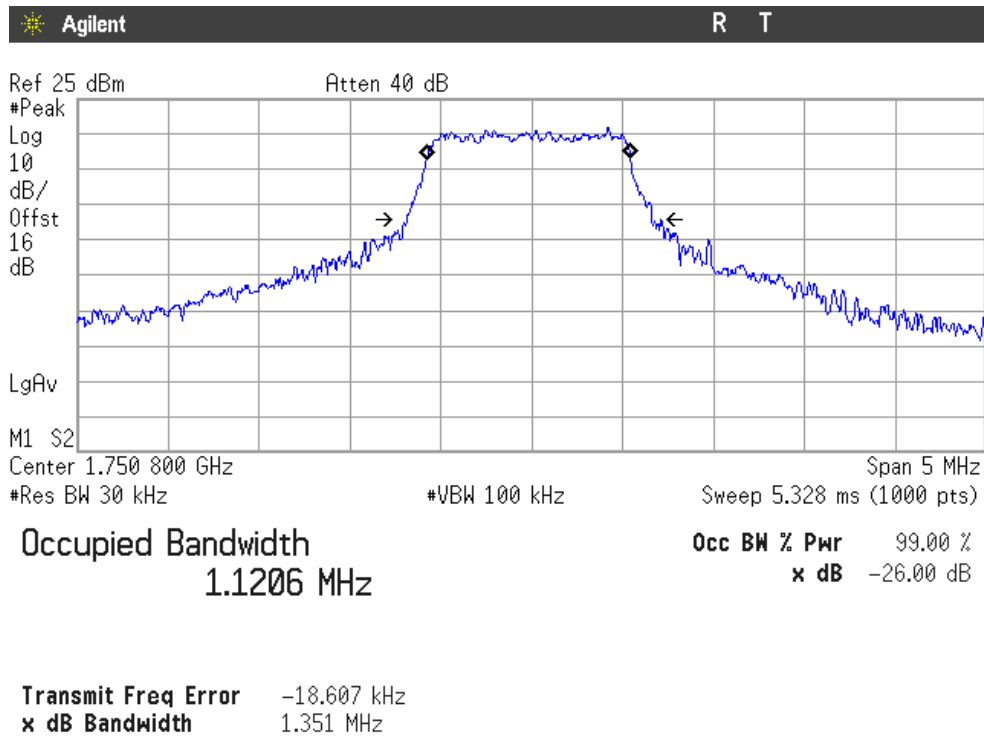



LTE 16QAM MODULATION. BW = 5 MHz (Band IV)

Lowest Channel

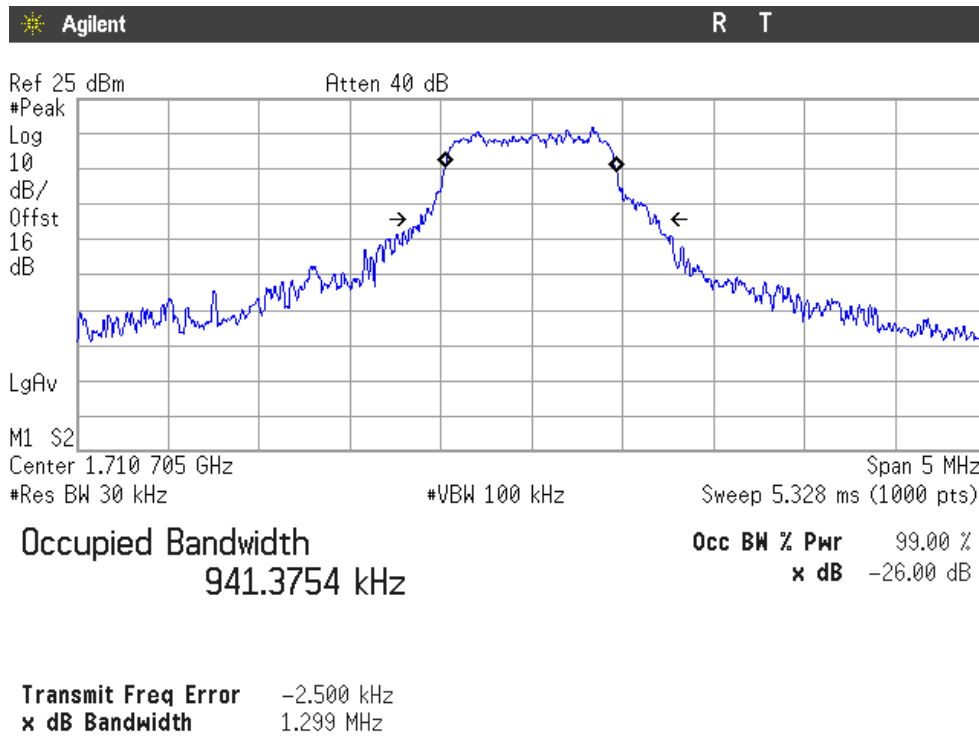

Middle Channel

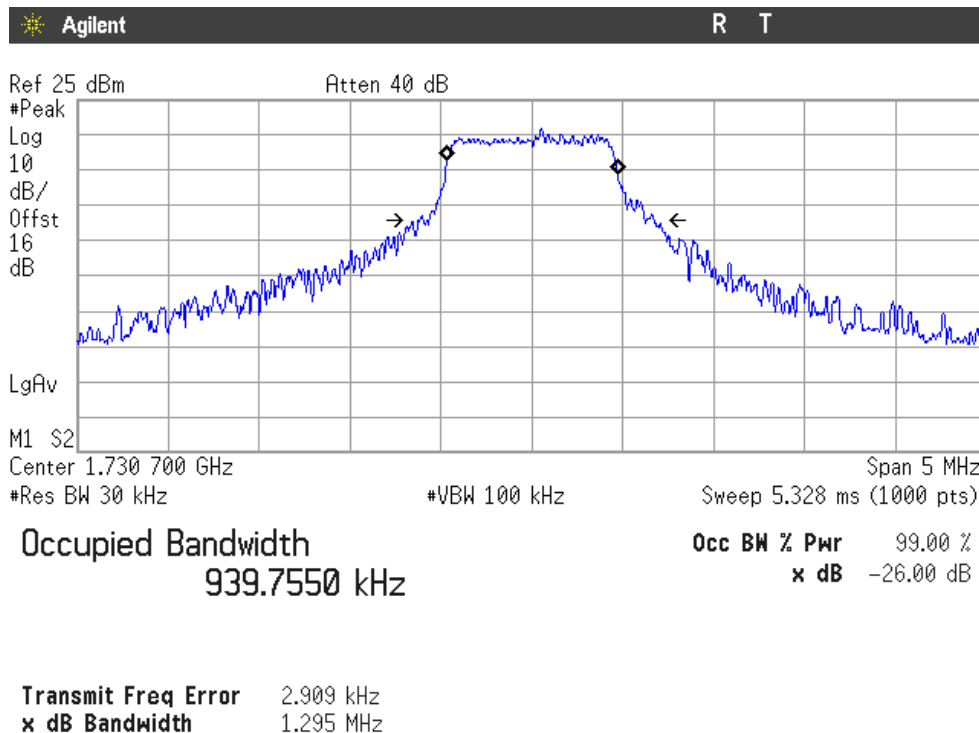

### Highest Channel

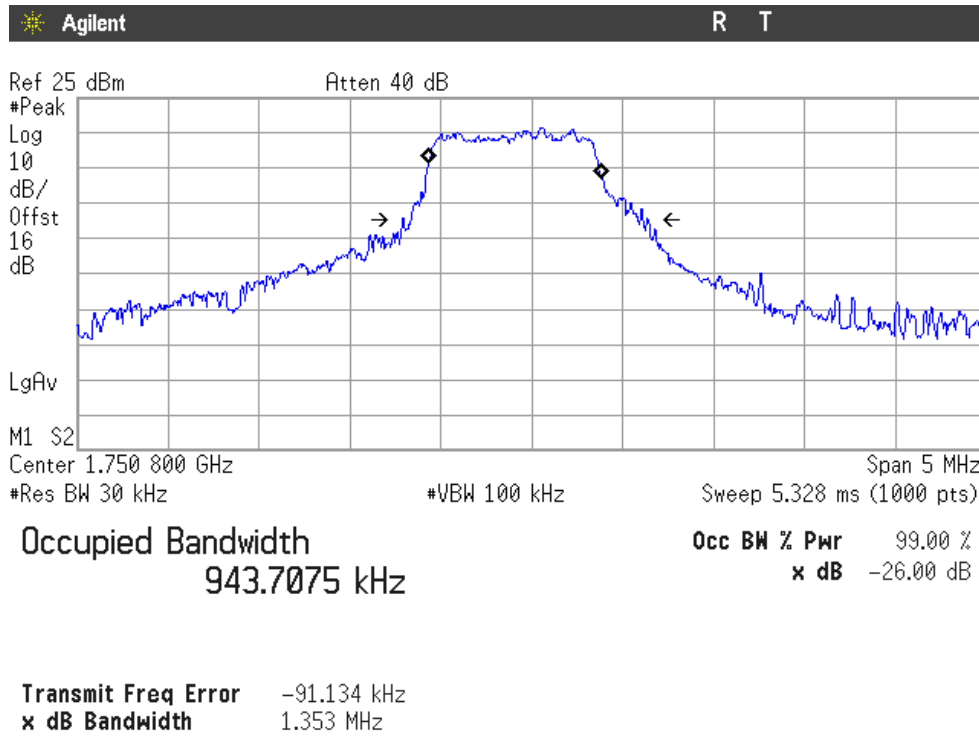

### LTE QPSK MODULATION. BW = 5 MHz (Band XIII)

#### Lowest Channel

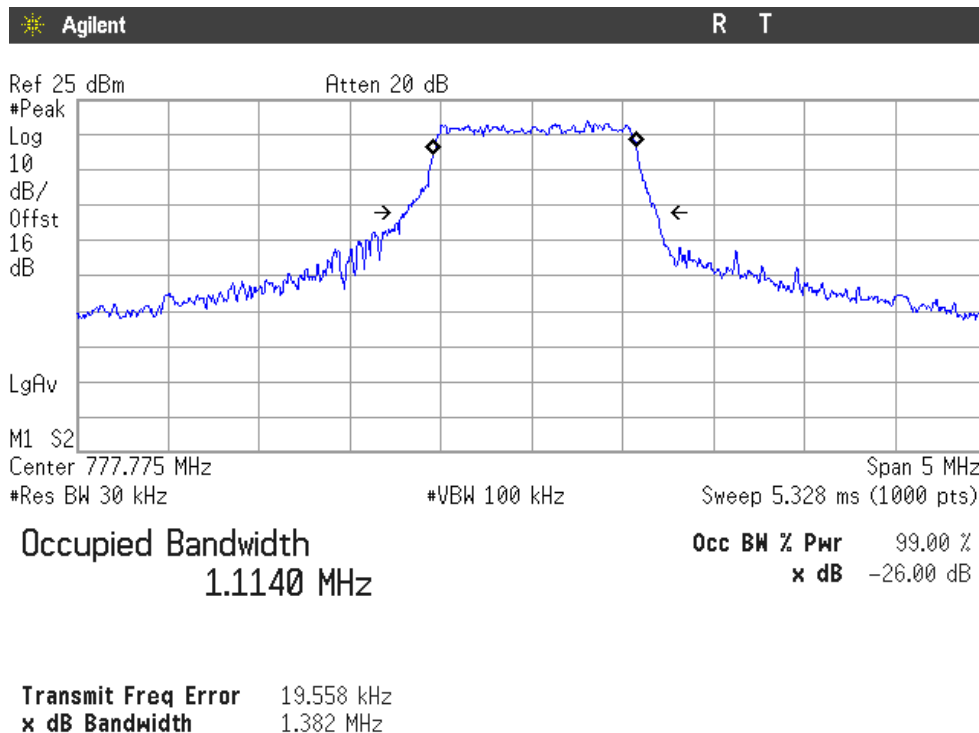

### Middle Channel

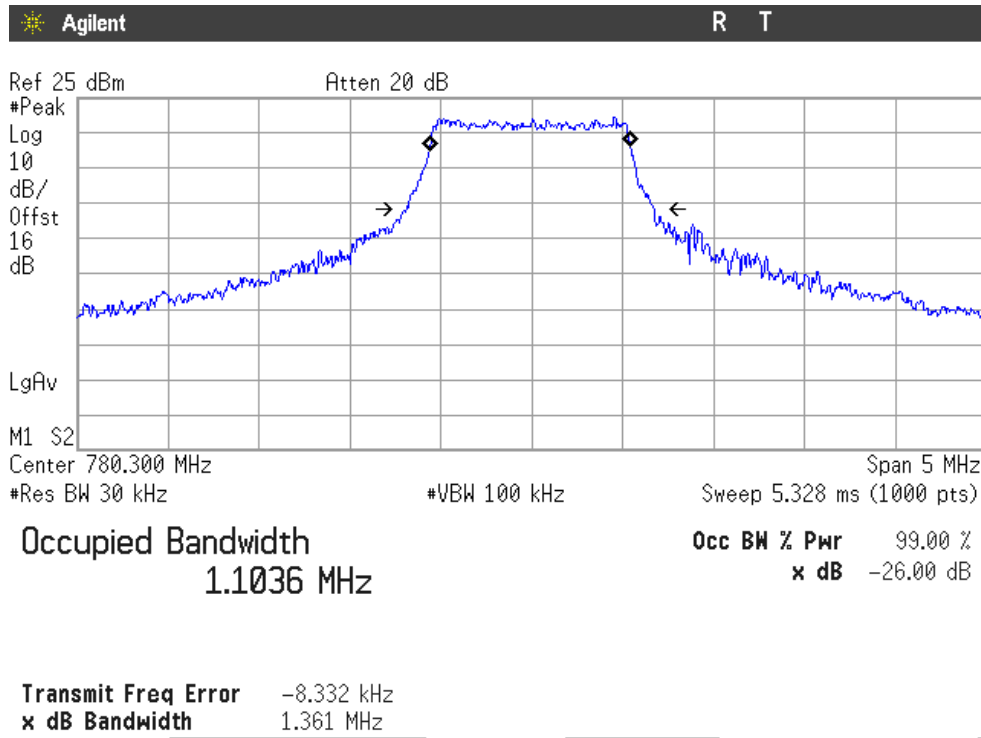

### Highest Channel

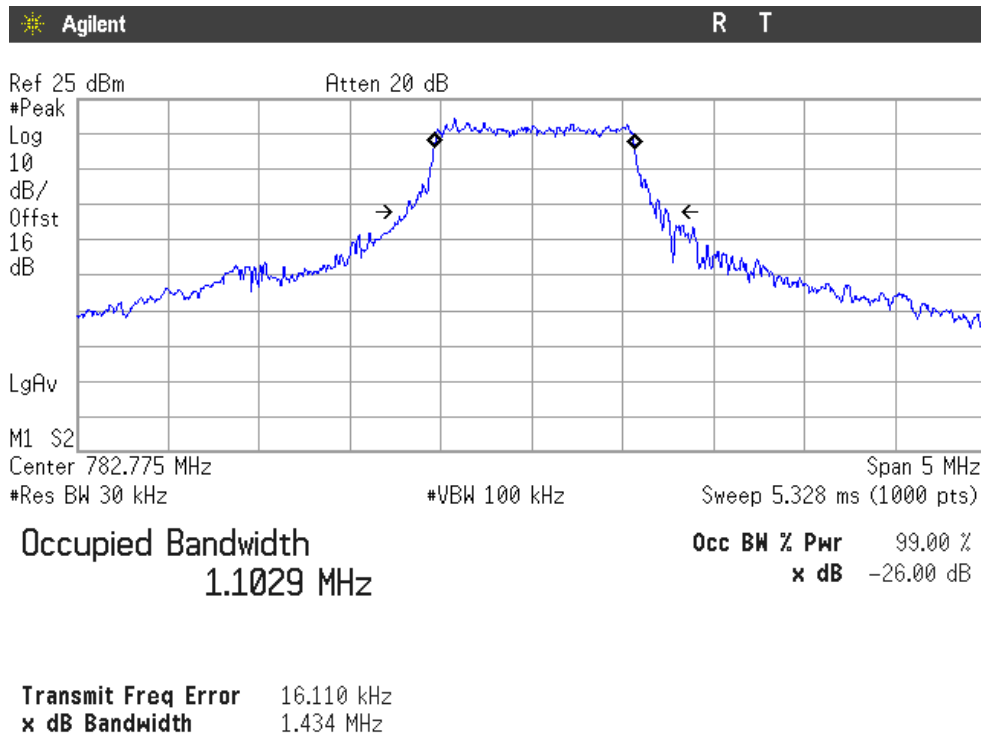

LTE 16QAM MODULATION. BW = 5 MHz (Band XIII)

Lowest Channel

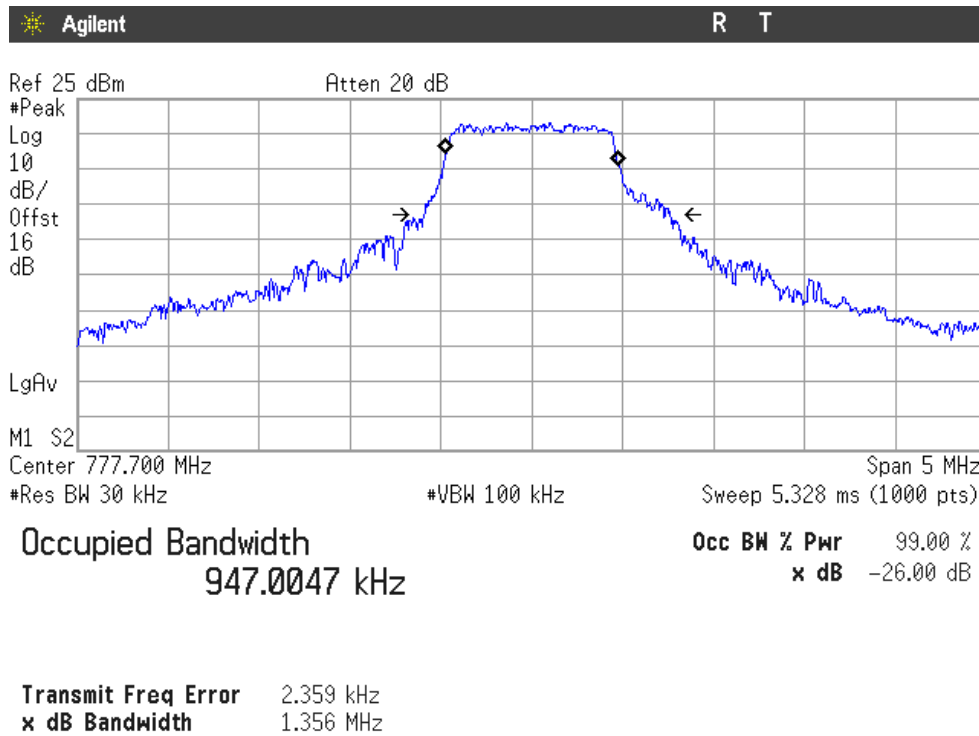

Middle Channel

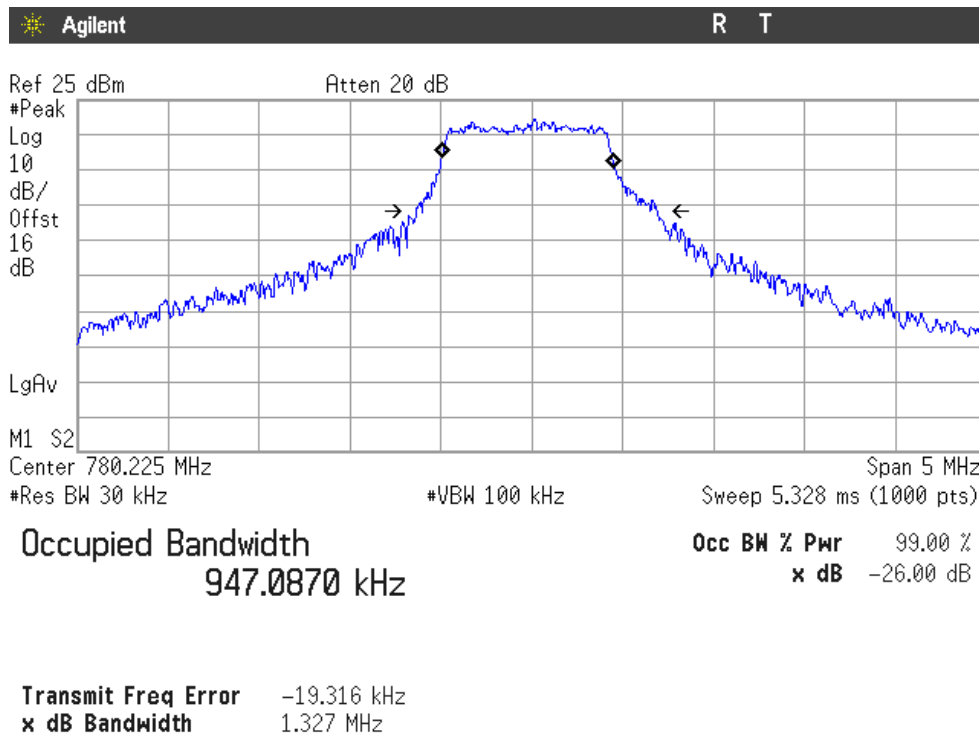

### Highest Channel

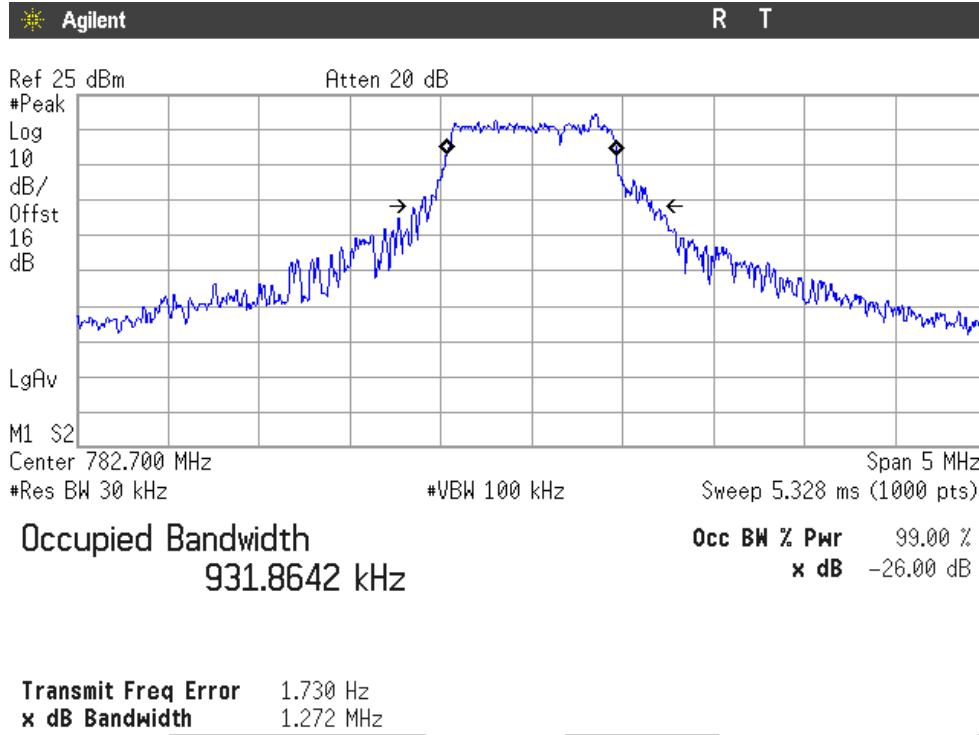

## Spurious emissions at antenna terminals

### SPECIFICATION

LTE BAND IV. FCC §27.53 (h). RSS-139 Clause 6.6.

According to specification, the power of emissions shall be attenuated below the transmitter power (P) by a factor of at least  $43 + 10 \log (P)$  dB. P in watts.

LTE BAND XIII.

FCC §27.53 (c).

On any frequency outside the 776-788 MHz band, the power of any emission shall be attenuated outside the band below the transmitter power (P) by at least  $43 + 10 \log (P)$  dB.

On all frequencies between 763-775 MHz and 793-805 MHz, by a factor not less than  $65 + 10 \log (P)$  dB in a 6.25 kHz band segment, for mobile and portable stations.

RSS-130 Clause 4.6.

The power of any unwanted emissions in any 100 kHz bandwidth on any frequency outside the frequency range(s) within which the equipment is designed to operate shall be attenuated below the transmitter power, P (dBW), by at least  $43 + 10 \log_{10} p$  (watts), dB.

The power of any unwanted emissions in any 6.25 kHz bandwidth for all frequencies between 763-775 MHz and 793-806 MHz shall be attenuated below the transmitter power, P (dBW), by at least  $65 + 10 \log_{10} p$ (watts), dB, for mobile and portable equipment.

At  $P_o$  transmitting power, the specified minimum attenuation becomes  $43+10 \log (P_o)$ , and the level in dBm relative  $P_o$  becomes:

$$P_o \text{ (dBm)} - [43 + 10 \log (P_o \text{ in mwatts}) - 30] = -13 \text{ dBm.}$$

At  $P_o$  transmitting power, the specified minimum attenuation becomes  $65+10 \log (P_o)$ , and the level in dBm relative  $P_o$  becomes:

$$P_o \text{ (dBm)} - [65 + 10 \log (P_o \text{ in mwatts}) - 30] = -35 \text{ dBm.}$$

### METHOD

The EUT RF output connector was connected to a spectrum analyser and to the Universal Radio Communication tester R&S CMW500 (selecting maximum transmission power of the EUT and different modes of modulation) using a 50 ohm attenuator and a power divider.

The spectrum was investigated from 9 kHz to 18 GHz for LTE Band IV and from 9 kHz to 8 GHz for LTE Band XIII.

The reading of the spectrum analyser is corrected with the attenuation loss of connection between output terminal of EUT and input of the spectrum analyser.

The configuration of Resource Blocks and modulation which is the worst case for conducted power was used.

TEST SETUP

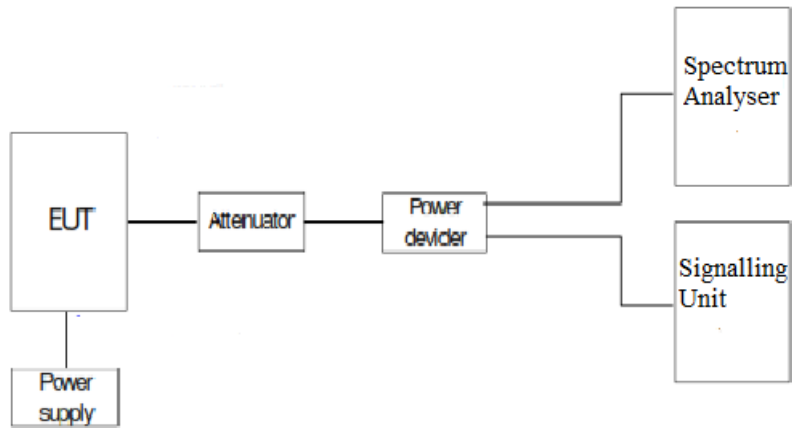

RESULTS (see plots in next pages)

LTE Band IV

1. CHANNEL: LOWEST

No spurious signals were found at less than 20dB respect to the limit in all the range.

2. CHANNEL: MIDDLE

No spurious signals were found at less than 20dB respect to the limit in all the range.

3. CHANNEL: HIGHEST

No spurious signals were found at less than 20dB respect to the limit in all the range.

LTE Band XIII

1. CHANNEL: LOWEST

No spurious signals were found at less than 20dB respect to the limit in all the range.

2. CHANNEL: MIDDLE

Frequency (MHz)	Level (dBm)	Limit (dBm)
774.980	-54.02	-35.00

3. CHANNEL: HIGHEST

No spurious signals were found at less than 20dB respect to the limit in all the range.

Verdict: PASS

LTE Band IV

1. CHANNEL: LOWEST

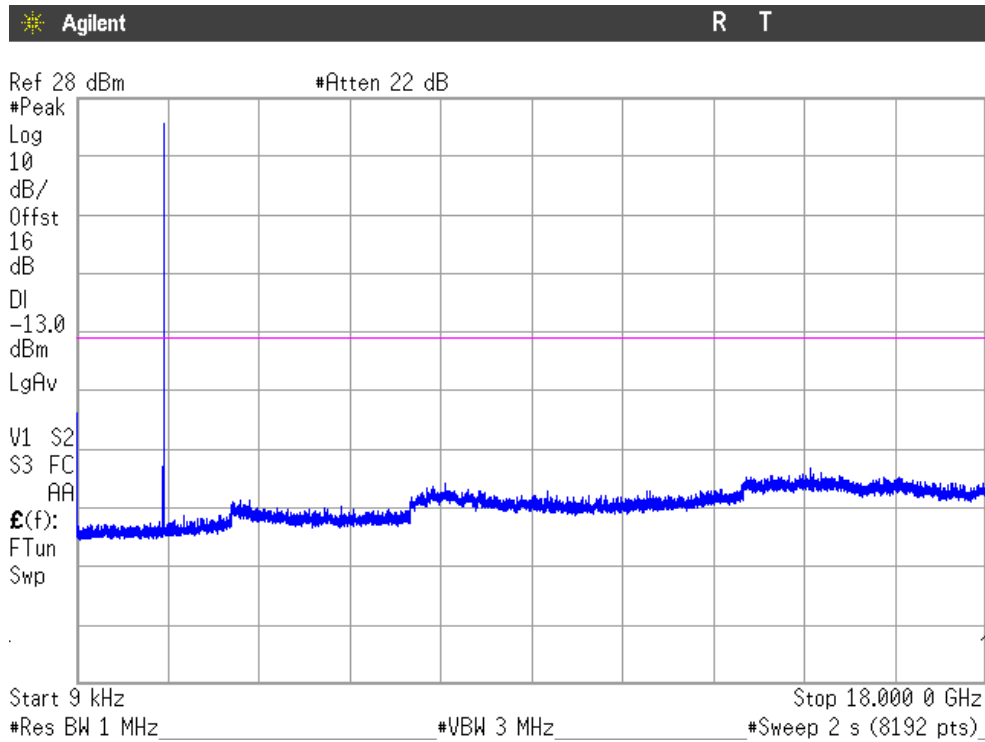

Note: The peak above the limit is the carrier frequency.

2. CHANNEL: MIDDLE

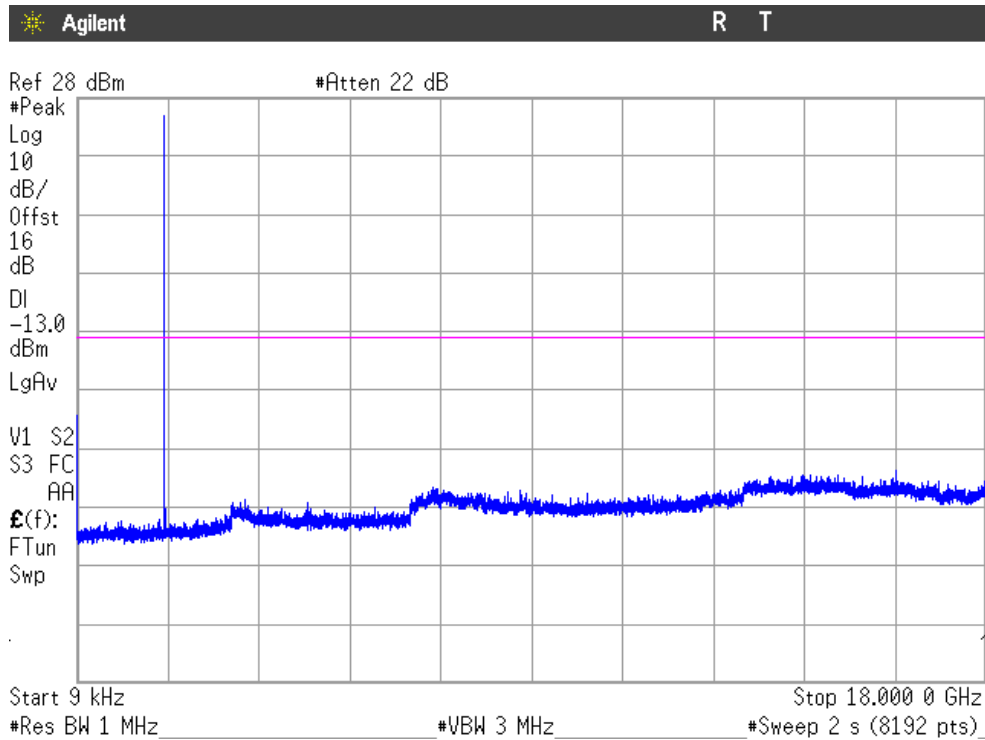

Note: The peak above the limit is the carrier frequency.



### 3. CHANNEL: HIGHEST

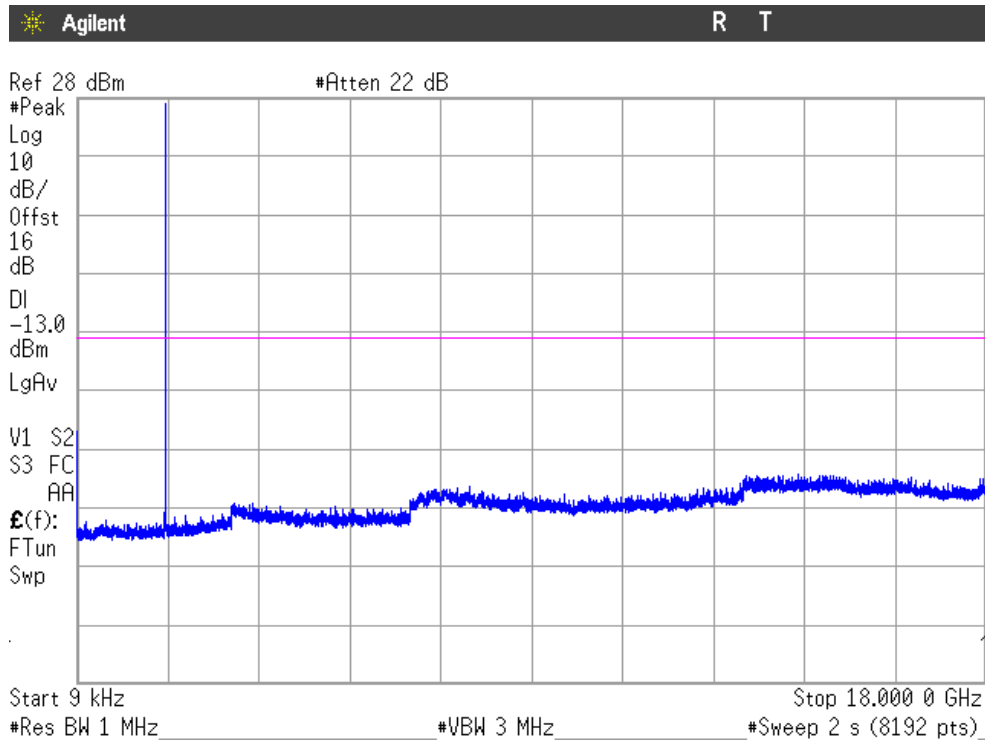

Note: The peak above the limit is the carrier frequency.

### LTE Band XIII

#### 1. CHANNEL: LOWEST

Frequency Range 9 kHz – 8 GHz

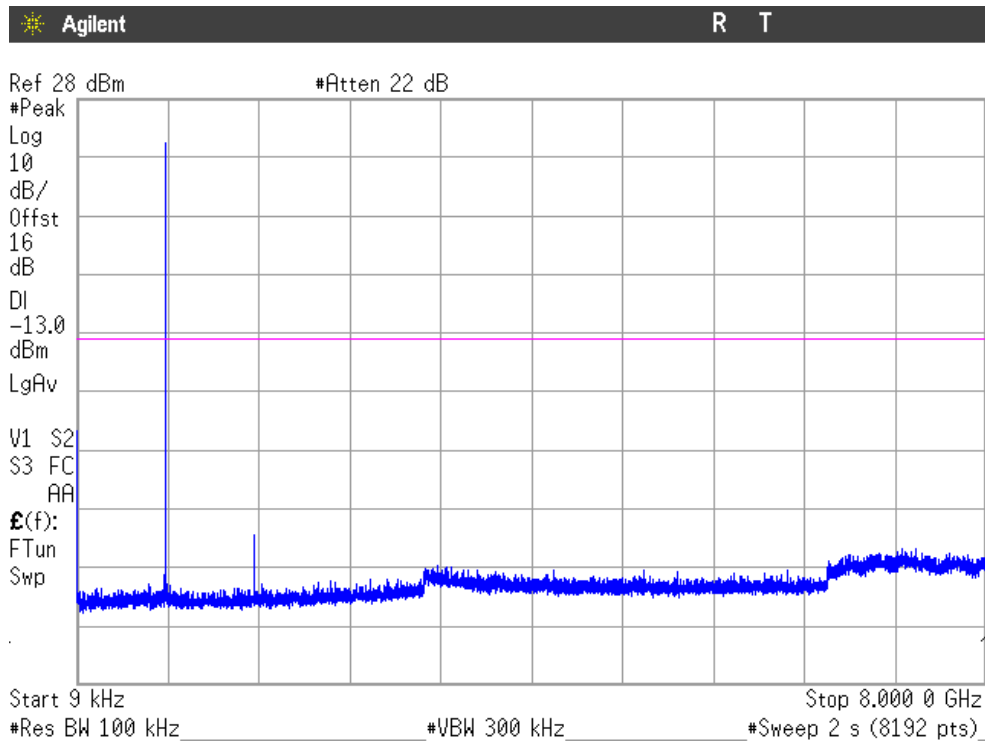

Note: The peak above the limit is the carrier frequency.

Frequency Range 763 MHz - 775 MHz

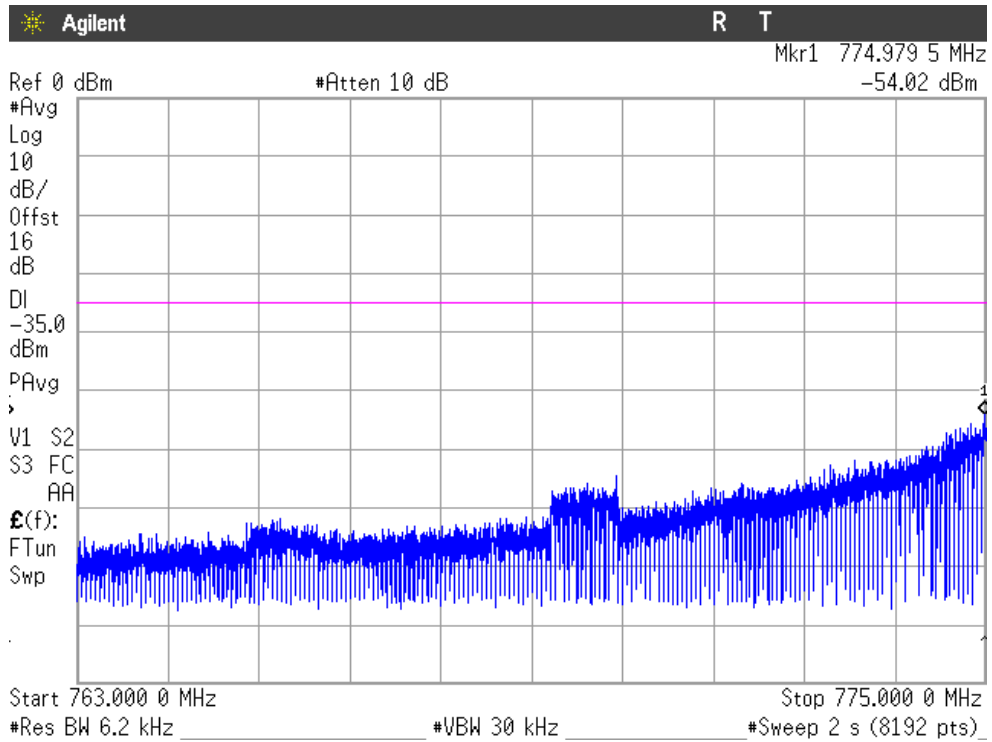

Frequency Range 793 MHz - 806 MHz

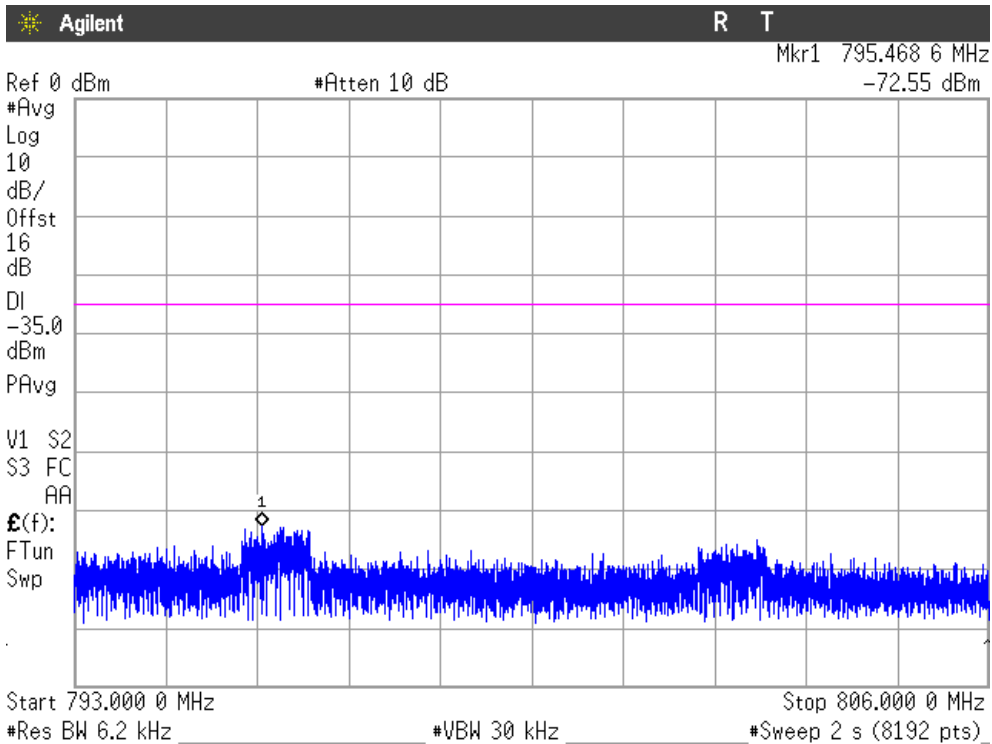

## 2. CHANNEL: MIDDLE

Frequency Range 9 kHz – 8 GHz

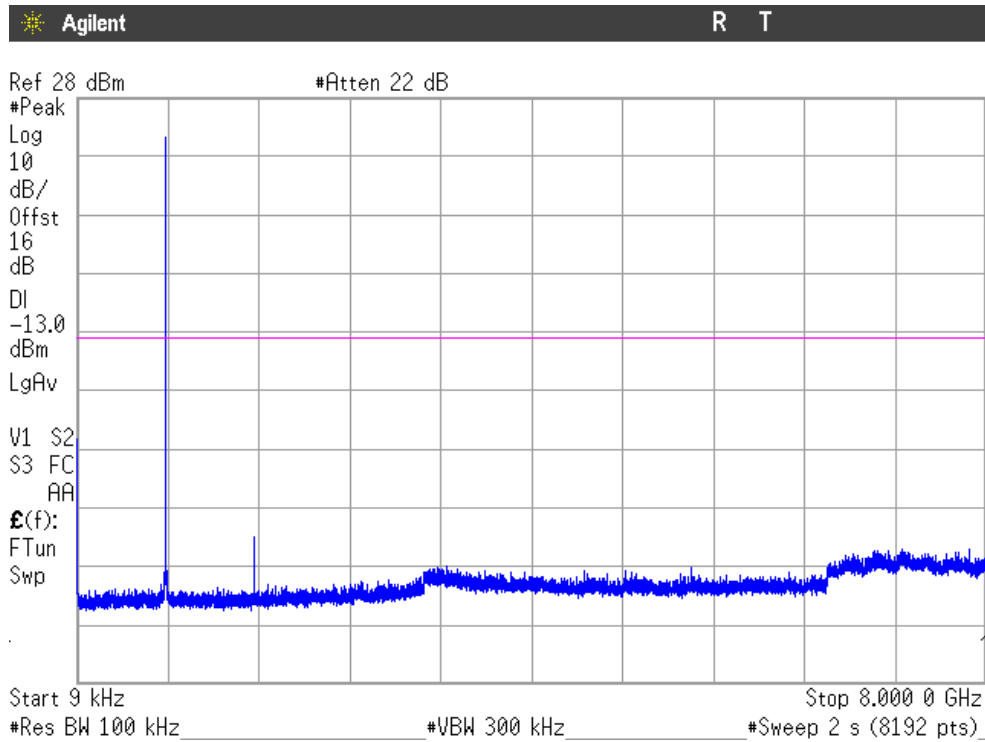

Note: The peak above the limit is the carrier frequency.

Frequency Range 763 MHz - 775 MHz

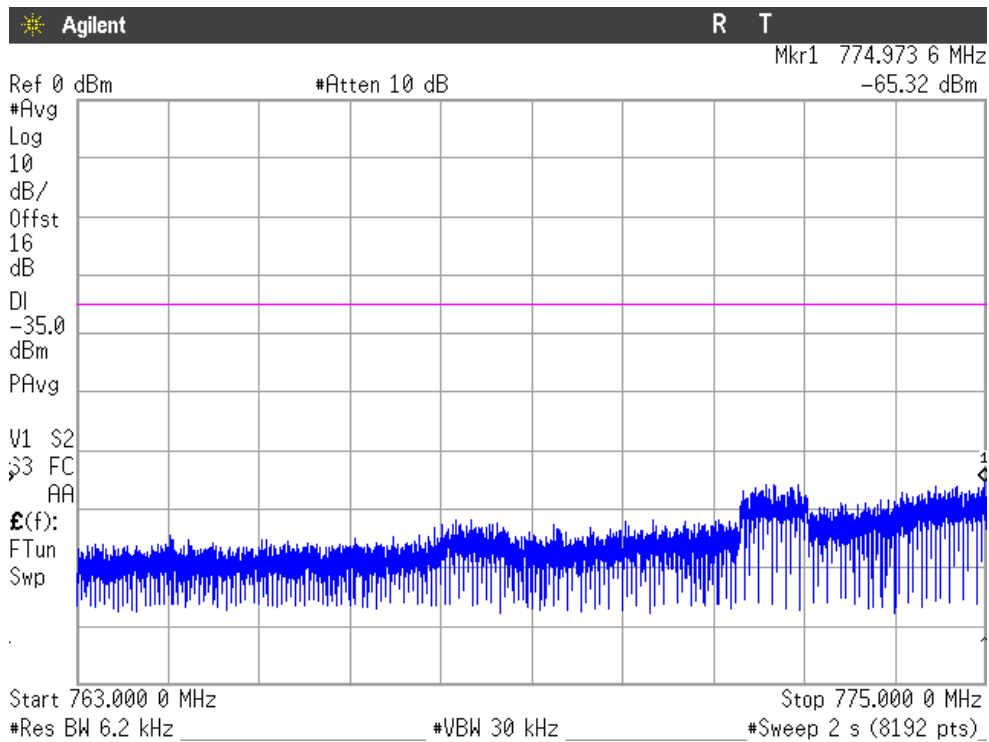

Frequency Range 793 MHz - 806 MHz

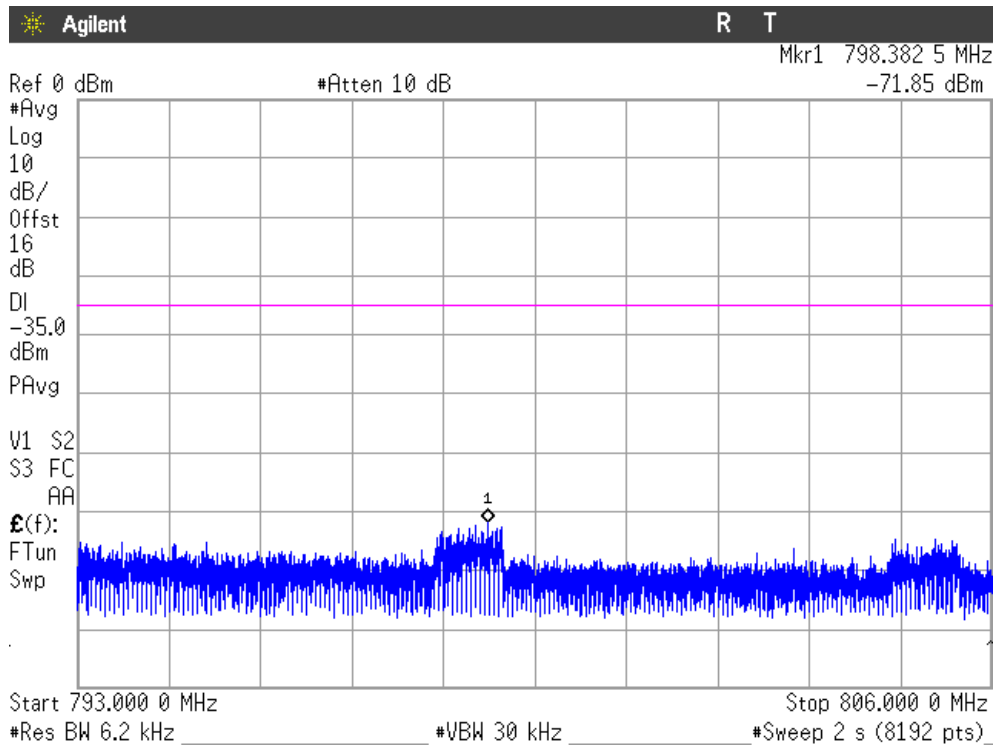

3. CHANNEL: HIGHEST

Frequency Range 9 kHz – 8 GHz

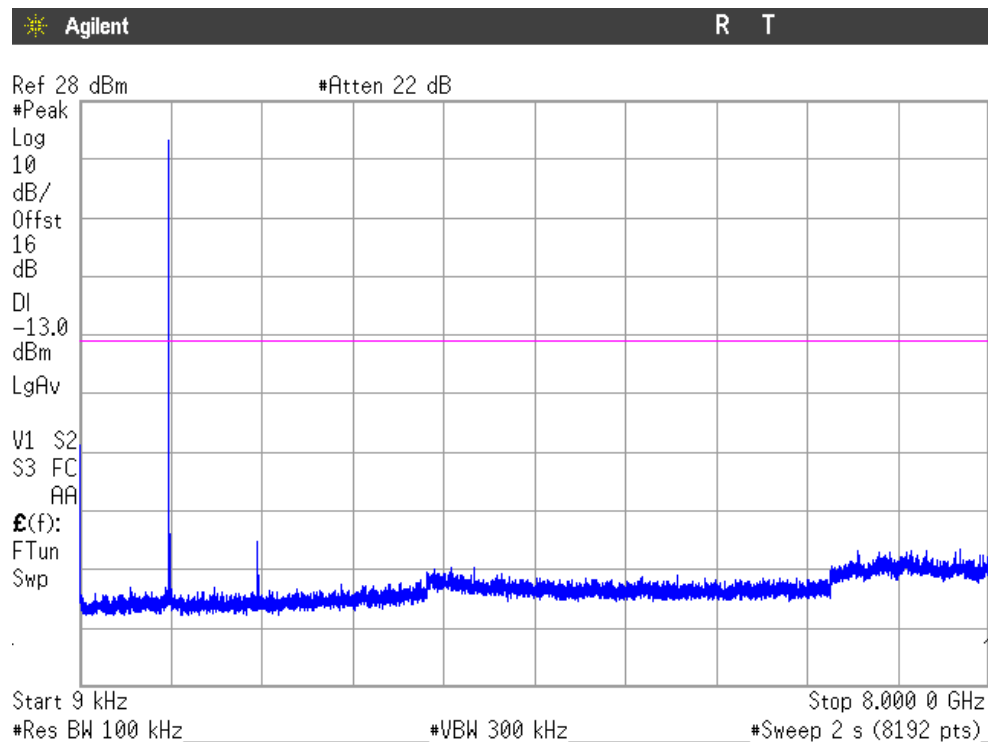

Note: The peak above the limit is the carrier frequency.

Frequency Range 763 MHz - 775 MHz

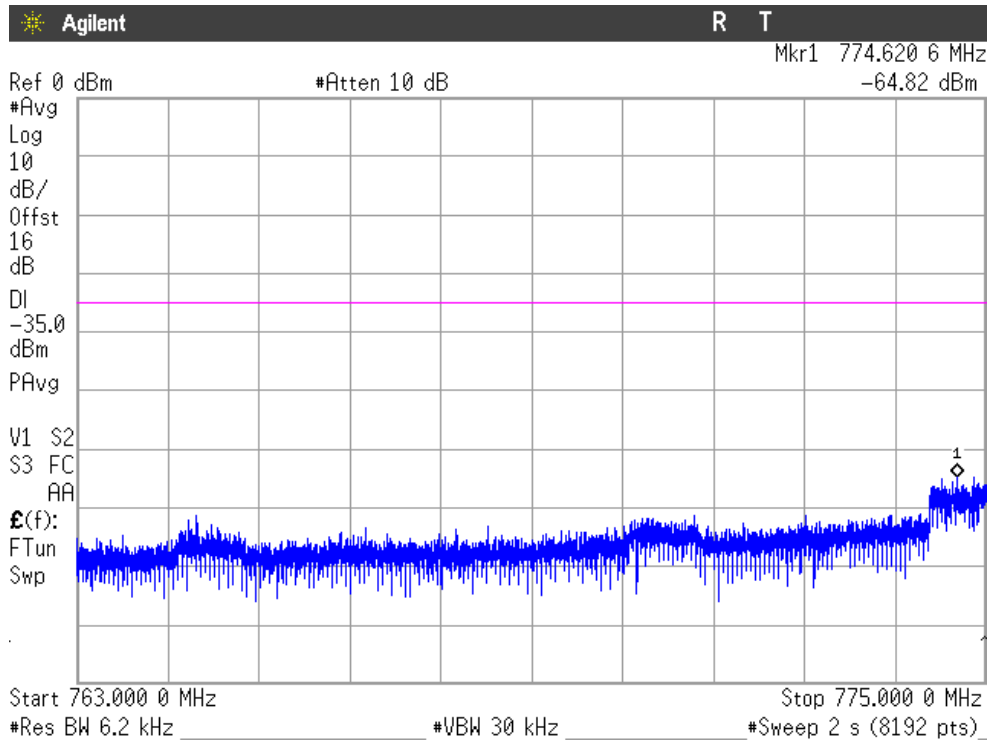

Frequency Range 793 MHz - 806 MHz

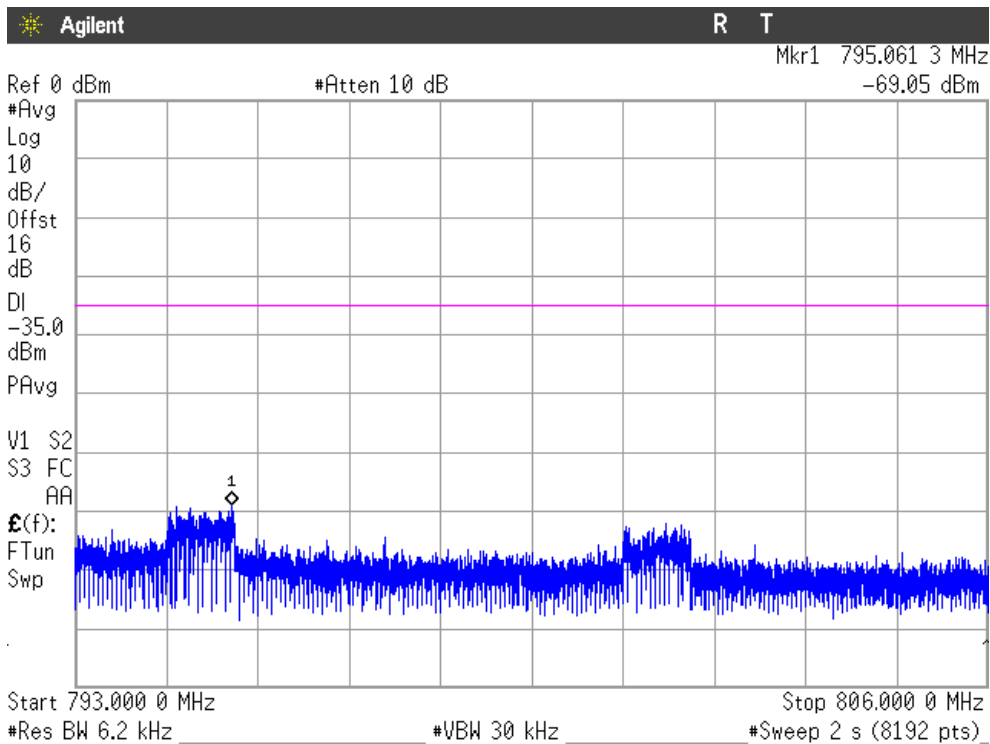

## Spurious emissions at antenna terminals at Block Edges

### SPECIFICATION

FCC §27.53 (h). RSS-139 Clause 6.6. RSS-130 Clause 4.6.

According to specification. the power of emissions shall be attenuated below the transmitter power (P) by a factor of at least  $43 + 10 \log (P)$  dB. P in watts.

At  $P_o$  transmitting power. the specified minimum attenuation becomes  $43+10\log (P_o)$ . and the level in dBm relative  $P_o$  becomes:

$$P_o \text{ (dBm)} - [43 + 10 \log (P_o \text{ in mwatts}) - 30] = -13 \text{ dBm}$$

### METHOD

The EUT RF output connector was connected to a spectrum analyser and to the Universal Radio Communication tester R&S CMW500 (selecting maximum transmission power of the EUT and different modes of modulation) using a 50 ohm attenuator and a power splitter.

The reading of the spectrum analyser is corrected with the attenuation loss of connection between output terminal of EUT and input of the spectrum analyser.

The configuration of modulation which is the worst case for conducted power was used.

For LTE Band IV, as indicated in FCC part 27.53 (h) (5) /RSS-139 Clause 6.6., in the 1 MHz bands immediately outside and adjacent to the licensee's frequency block, a resolution bandwidth of at least one percent of the emission bandwidth/occupied bandwidth of the fundamental emission of the transmitter may be employed.

For LTE Band XIII, as indicated in FCC part 27.53 (c) (5) /RSS-130 Clause 4.6., in the 100 kHz bands immediately outside and adjacent to the licensee's frequency block or band, a resolution bandwidth of 30 kHz may be employed.

### TEST SETUP

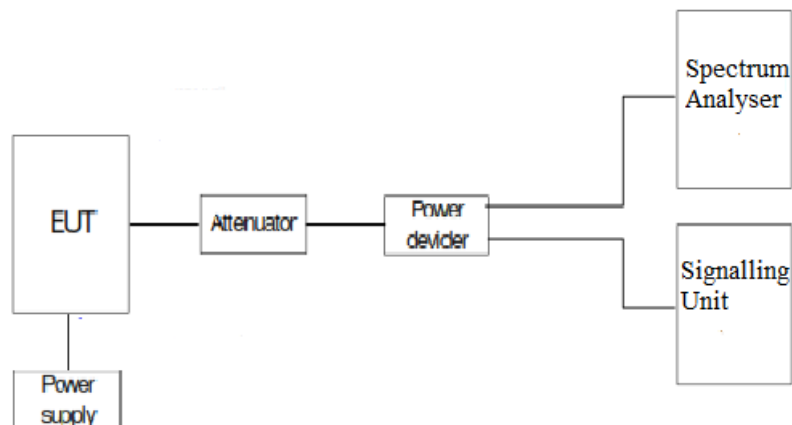

RESULTS (see plots in next pages)

(Channels in Band IV):	RB=1. Offset=0. Narrow band = 1 BW=1.4 MHz	RB=1 . Offset =0. Narrow band = 1 BW = 3 MHz	RB=1 . Offset =0. Narrow band = 1 BW = 5 MHz	RB=1 . Offset =0. Narrow band = 1 BW = 10 MHz	RB=1 . Offset =0. Narrow band = 1 BW = 15 MHz	RB=1 . Offset =0. Narrow band = 1 BW = 20 MHz
Maximum measured level at lowest Block Edge at antenna port (dBm)	-21.43	-29.7	-28.82	-40.83	-43.78	-41.81

(Channels in Band IV):	RB= All. Offset=0. Narrow band = 1 BW=1.4 MHz	RB= All. Offset =0. Narrow band = 1 BW = 3 MHz	RB= All. Offset =0. Narrow band = 1 BW = 5 MHz	RB= All. Offset =0. Narrow band = 1 BW = 10 MHz	RB= All. Offset =0. Narrow band = 1 BW = 15 MHz	RB= All. Offset =0. Narrow band = 1 BW = 20 MHz
Maximum measured level at lowest Block Edge at antenna port (dBm)	-26.59	-32.21	-31.25	-38.25	-41.23	-47.85

(Channels in Band IV):	RB= 1. Offset=Max. Narrow band = 1 BW=1.4 MHz	RB= 1. Offset=Max. Narrow band = 2 BW = 3 MHz	RB= 1. Offset=Max. Narrow band = 4 BW = 5 MHz	RB= 1. Offset=Max. Narrow band = 8 BW = 10 MHz	RB= 1. Offset=Max. Narrow band = 12 BW = 15 MHz	RB= 1. Offset=Max. Narrow band = 16 BW = 20 MHz
Maximum measured level at highest Block Edge at antenna port (dBm)	-23.22	-29.52	-28.49	-33.95	-41.64	-41.15

(Channels in Band IV):	RB= All. Offset=0. Narrow band = 1 BW=1.4 MHz	RB= All. Offset =0. Narrow band = 2 BW = 3 MHz	RB= All. Offset =0. Narrow band = 4 BW = 5 MHz	RB= All. Offset =0. Narrow band = 8 BW = 10 MHz	RB= All. Offset =0. Narrow band = 12 BW = 15 MHz	RB= All. Offset =0. Narrow band = 16 BW = 20 MHz
Maximum measured level at highest Block Edge at antenna port (dBm)	-26.42	-33.35	-30.78	-35.56	-40.71	-45.58

(Channels in Band XIII):	RB=1 , Offset =0, Narrow band = 1 BW = 5 MHz	RB=1 , Offset =0, Narrow band = 1 BW = 10 MHz
Maximum measured level at lowest Block Edge at antenna port (dBm)	-22.58	-34.62

(Channels in Band XIII):	RB= All, Offset =0, Narrow band = 1 BW = 5 MHz	RB= All, Offset =0, Narrow band = 1 BW = 10 MHz
Maximum measured level at lowest Block Edge at antenna port (dBm)	-23.84	-31.14

(Channels in Band XIII):	RB= 1, Offset=Max, Narrow band = 4 BW = 5 MHz	RB= 1, Offset=Max, Narrow band = 8 BW = 10 MHz
Maximum measured level at highest Block Edge at antenna port (dBm)	-21.87	-30.87

(Channels in Band XIII):	RB= All, Offset =0, Narrow band = 4 BW = 5 MHz	RB= All, Offset =0, Narrow band = 8 BW = 10 MHz
Maximum measured level at highest Block Edge at antenna port (dBm)	-24.78	-29.36

Measurement uncertainty = <math>\pm 2.03\text{ dB}</math>.

Verdict: PASS



Narrow band = 1. RB = 1. Offset = 0. BW = 1.4 MHz (Band IV)

CHANNEL LOWEST

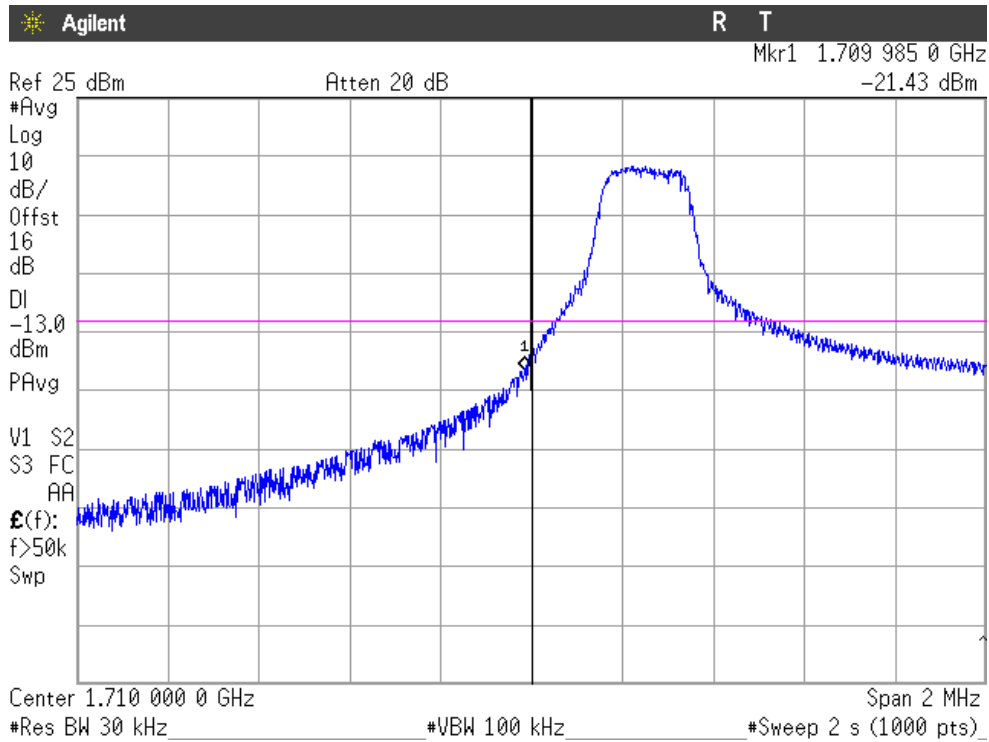

NOTE: The equipment transmits at the maximum output power

Narrow band = 1. RB = 1. Offset = Max. BW = 1.4 MHz (Band IV)

CHANNEL HIGHEST

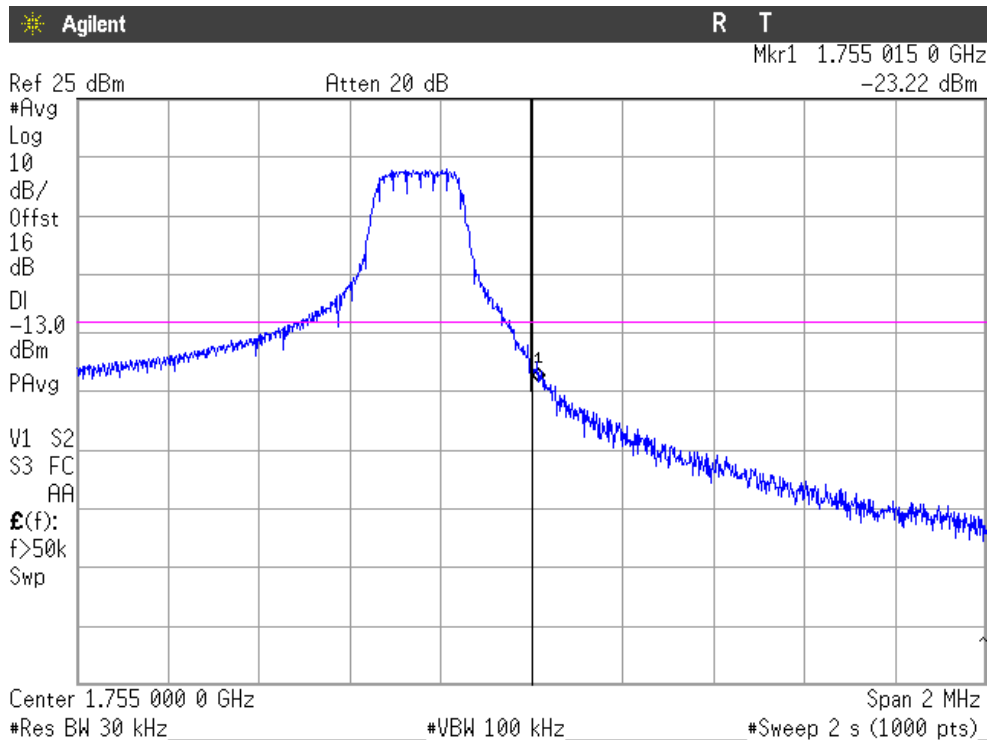

NOTE: The equipment transmits at the maximum output power

Narrow band = 1. RB = All. Offset = 0. BW = 1.4 MHz (Band IV)

CHANNEL LOWEST

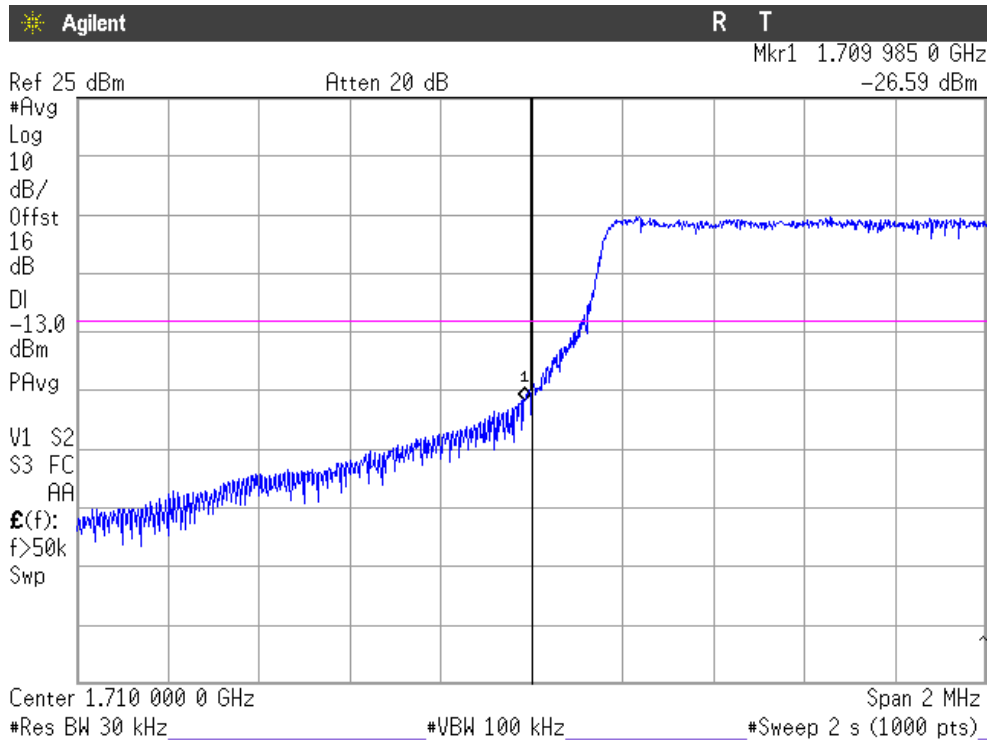

NOTE: The equipment transmits at the maximum output power

CHANNEL HIGHEST

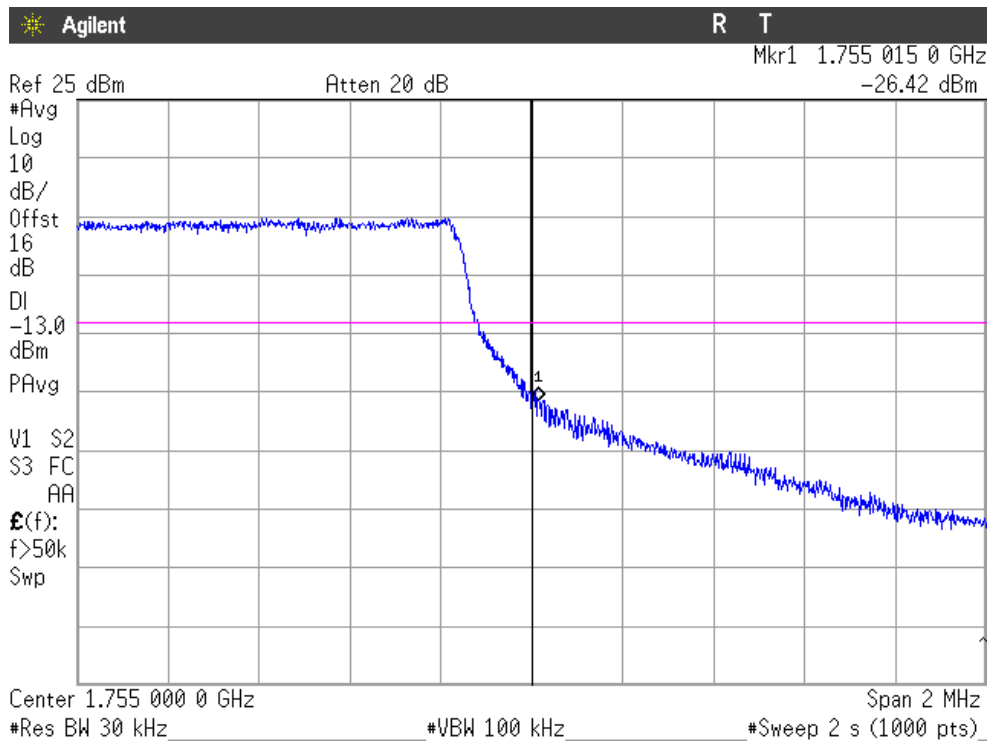

NOTE: The equipment transmits at the maximum output power

Verdict: PASS

Narrow band = 1. RB = 1. Offset = 0. BW = 3 MHz (Band IV)

CHANNEL LOWEST

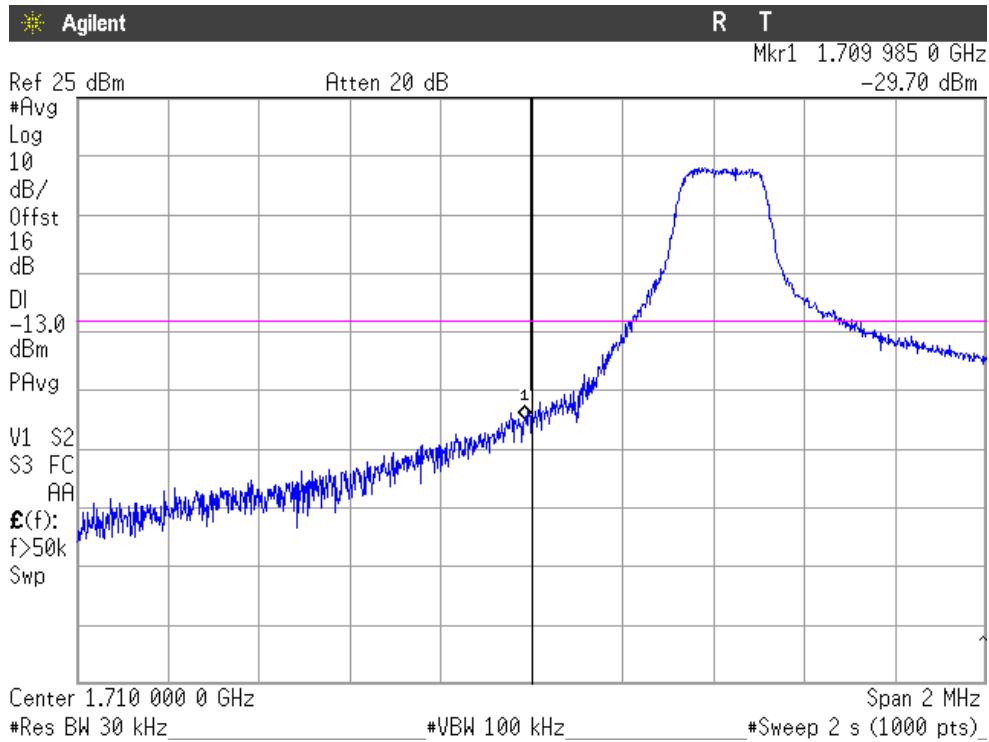

NOTE: The equipment transmits at the maximum output power

Narrow band = 2. RB = 1. Offset = Max. BW = 3 MHz (Band IV)

CHANNEL HIGHEST

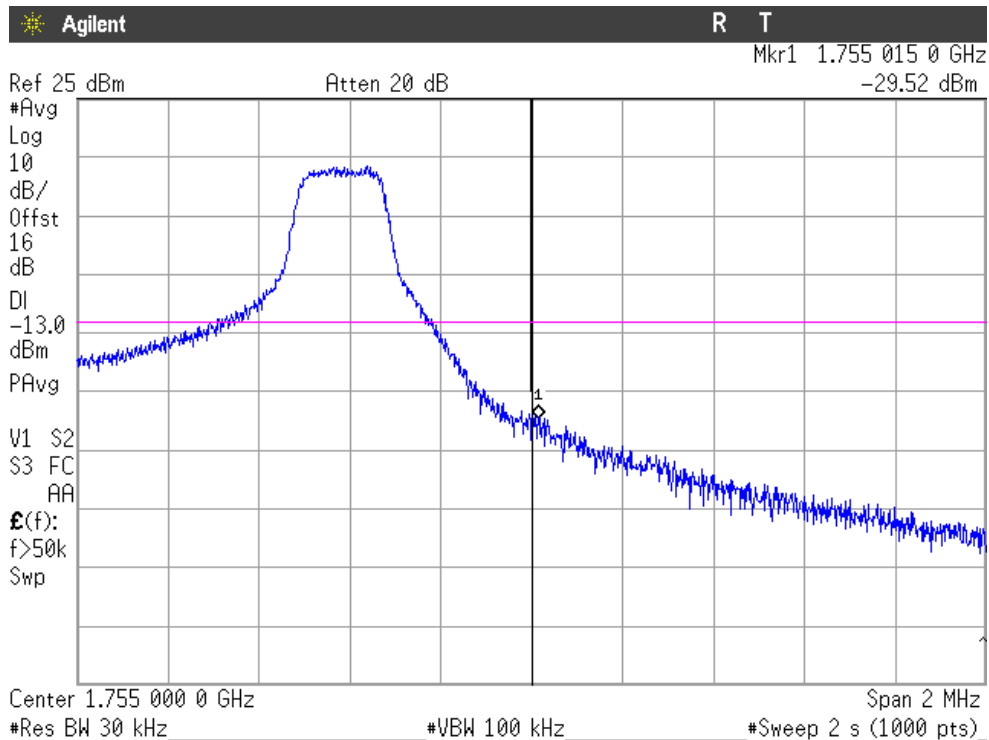

NOTE: The equipment transmits at the maximum output power

RB = All. Offset = 0. BW = 3 MHz (Band IV)

CHANNEL LOWEST. Narrow band = 1.

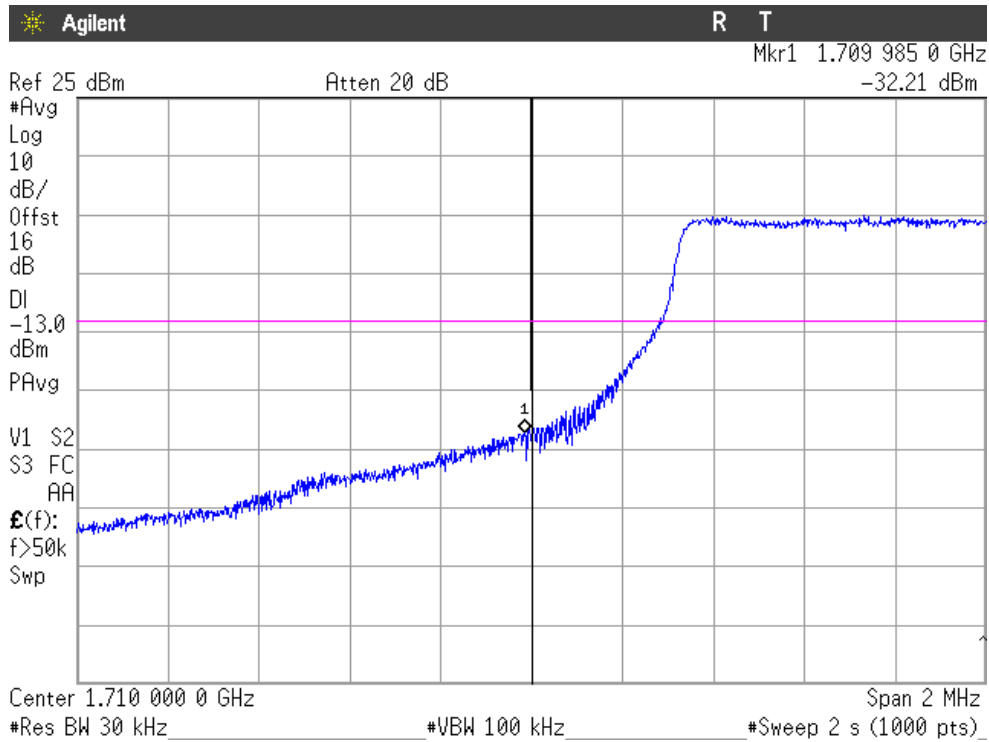

NOTE: The equipment transmits at the maximum output power

CHANNEL HIGHEST. Narrow band = 2.

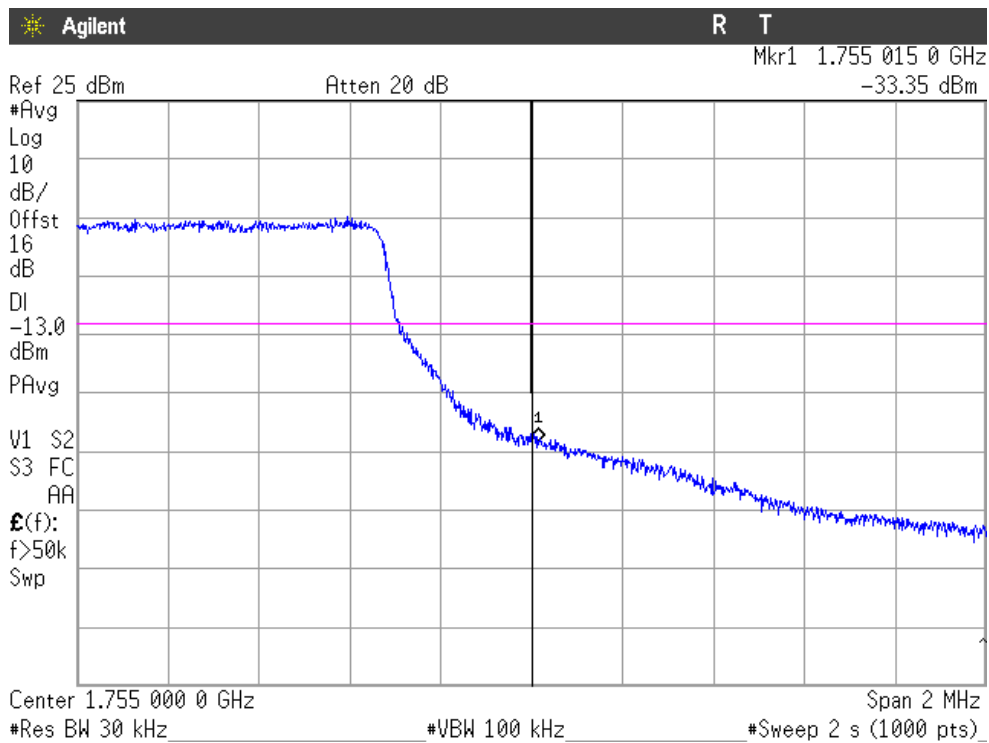

NOTE: The equipment transmits at the maximum output power

Verdict: PASS

Narrow band = 1. RB = 1. Offset = 0. BW = 5 MHz (Band IV)

CHANNEL LOWEST

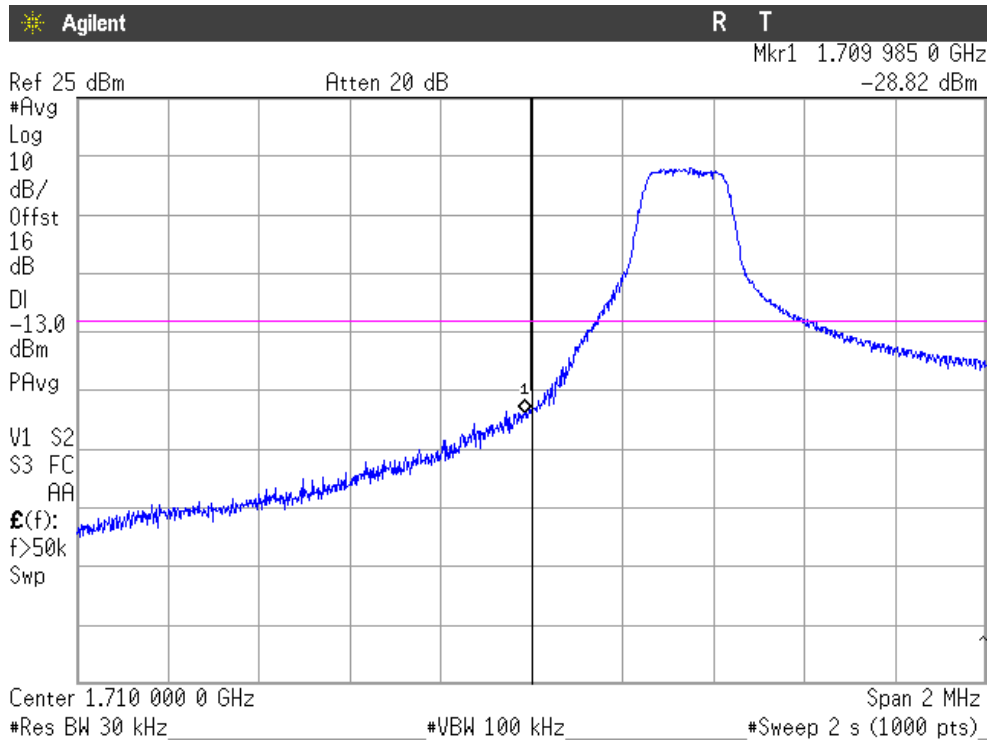

NOTE: The equipment transmits at the maximum output power

Narrow band = 4. RB = 1. Offset = Max. BW = 5 MHz (Band IV)

CHANNEL HIGHEST

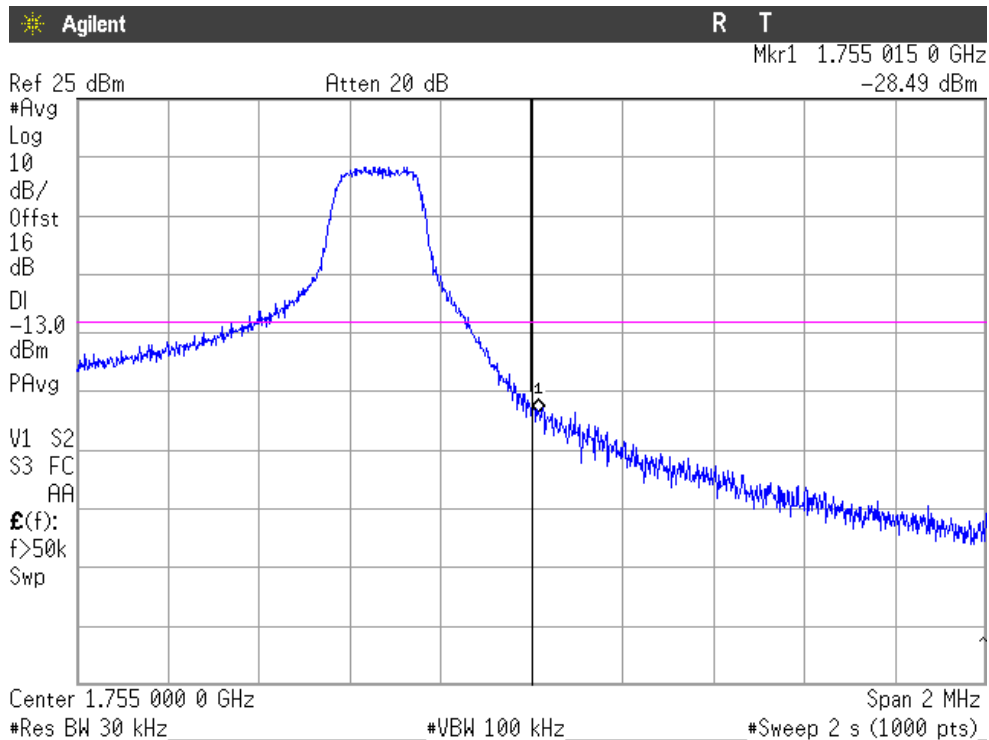

NOTE: The equipment transmits at the maximum output power

RB = All. Offset = 0. BW = 5 MHz (Band IV)

CHANNEL LOWEST. Narrow band = 1.

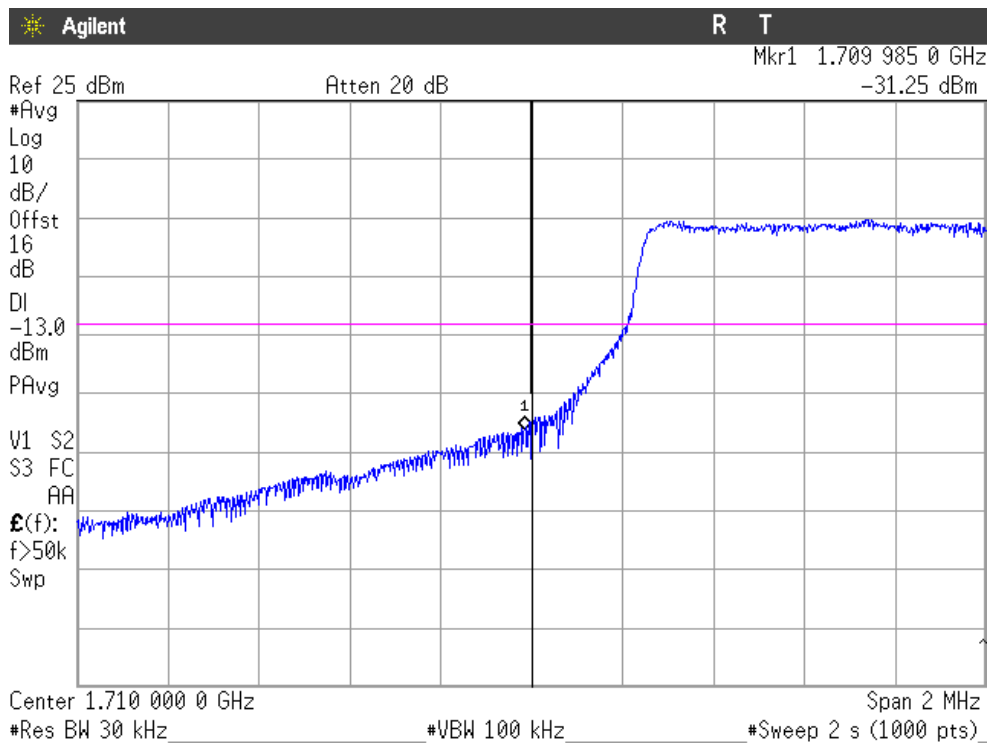

NOTE: The equipment transmits at the maximum output power

CHANNEL HIGHEST. Narrow band = 4.

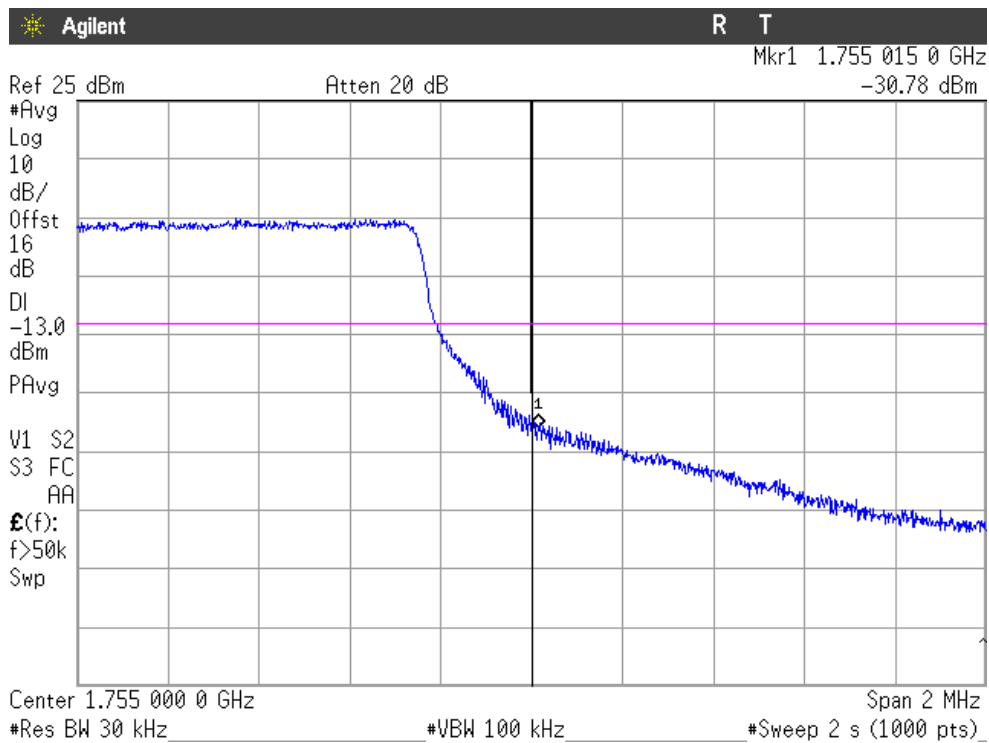

NOTE: The equipment transmits at the maximum output power

Verdict: PASS

Narrow band = 1. RB = 1. Offset = 0. BW = 10 MHz (Band IV)

CHANNEL LOWEST

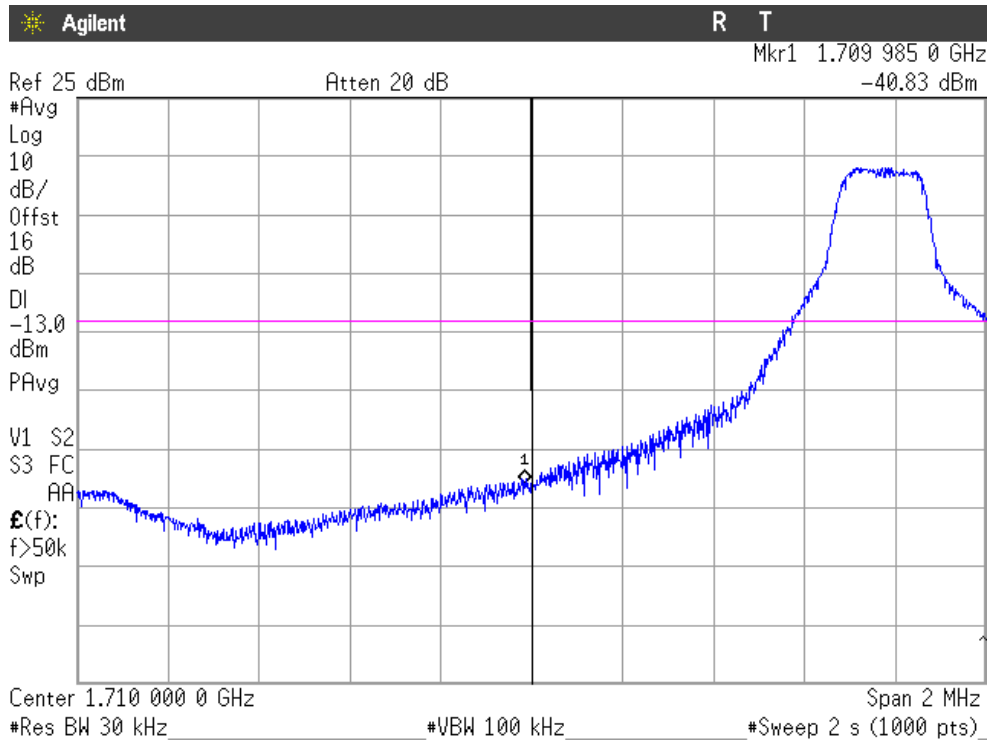

NOTE: The equipment transmits at the maximum output power

Narrow band = 8. RB = 1. Offset = Max. BW = 10 MHz (Band IV)

CHANNEL HIGHEST

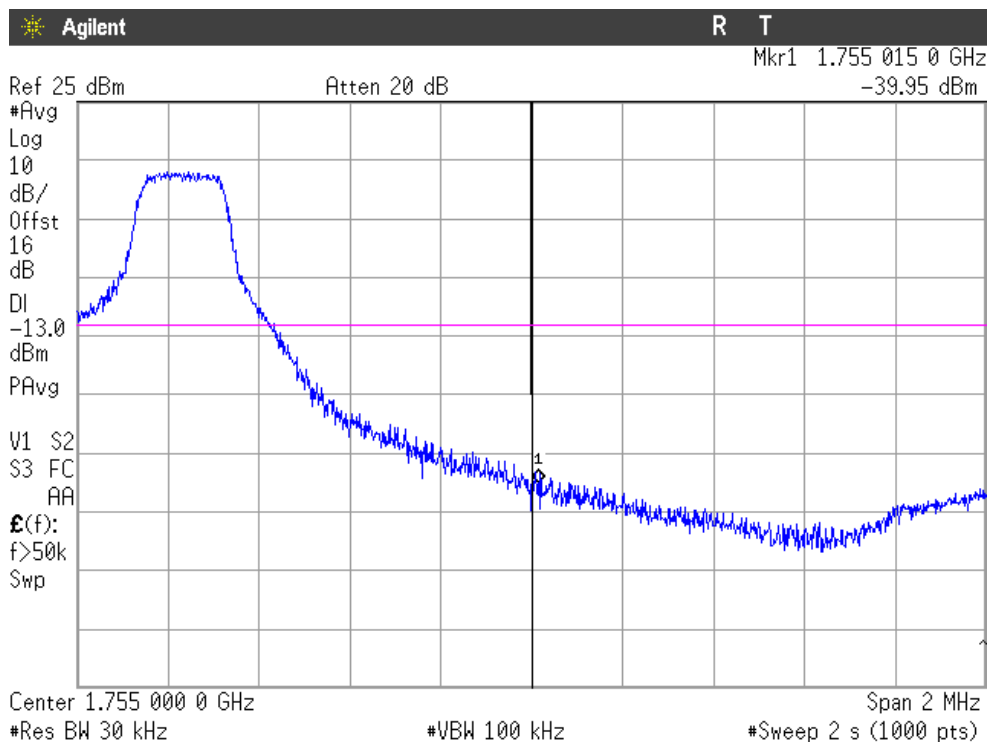

NOTE: The equipment transmits at the maximum output power

RB = All. Offset = 0. BW = 10 MHz (Band IV)

CHANNEL LOWEST. Narrow band = 1.

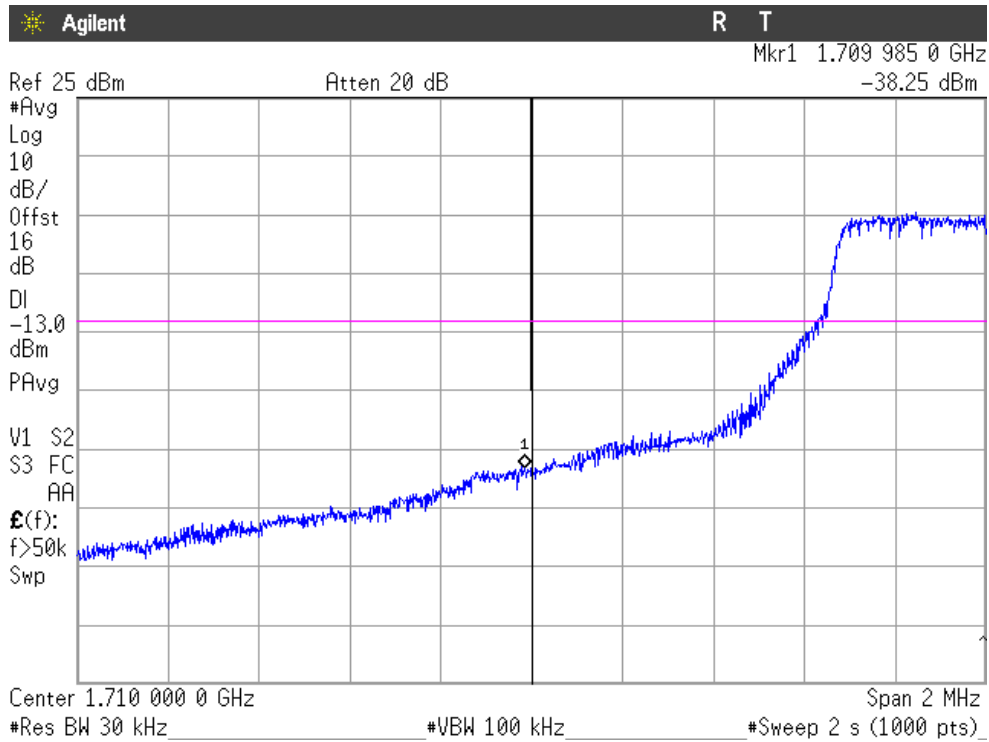

NOTE: The equipment transmits at the maximum output power

CHANNEL HIGHEST. Narrow band = 8.

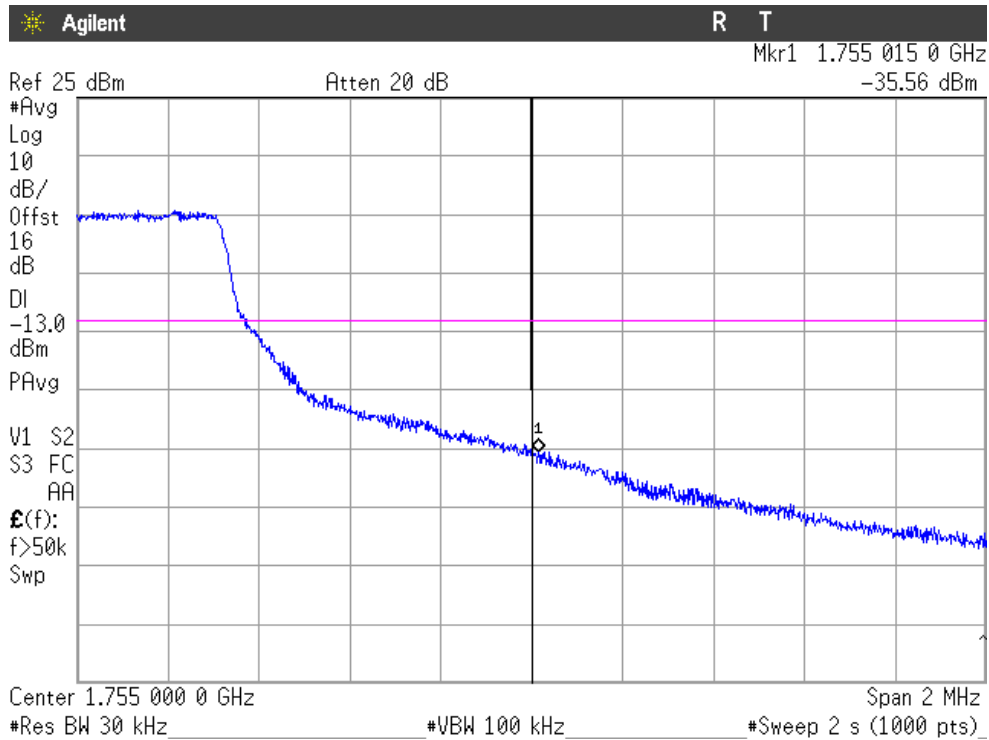

NOTE: The equipment transmits at the maximum output power

Verdict: PASS



Narrow band = 1. RB = 1. Offset = 0. BW = 15 MHz (Band IV)

CHANNEL LOWEST

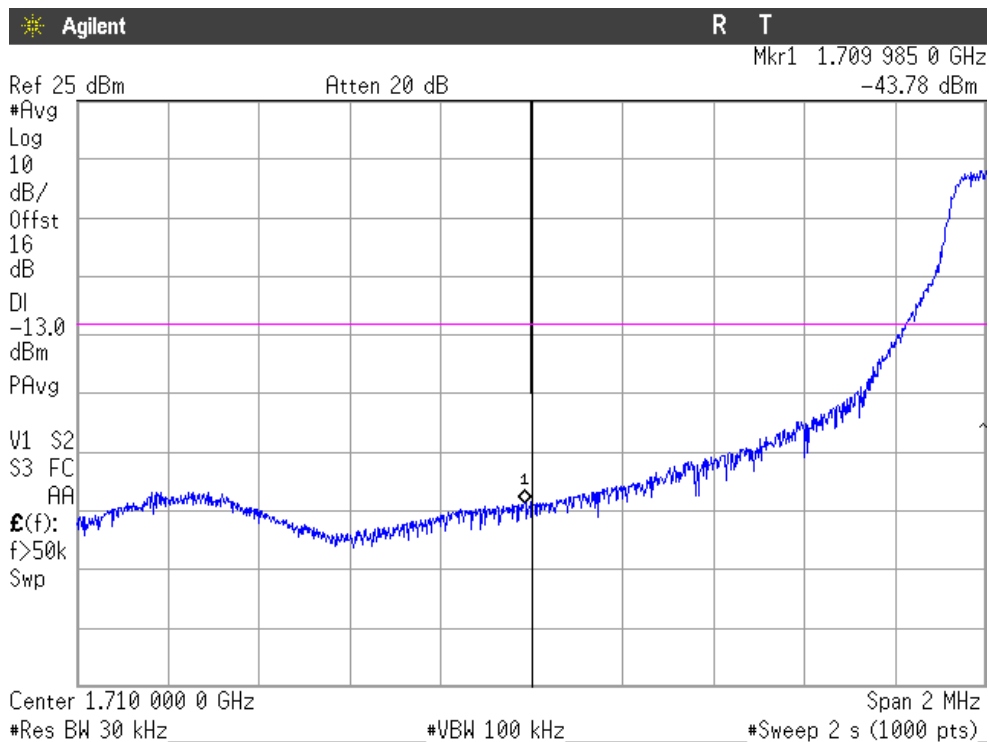

NOTE: The equipment transmits at the maximum output power

Narrow band = 12. RB = 1. Offset = Max. BW = 15 MHz (Band IV)

CHANNEL HIGHEST

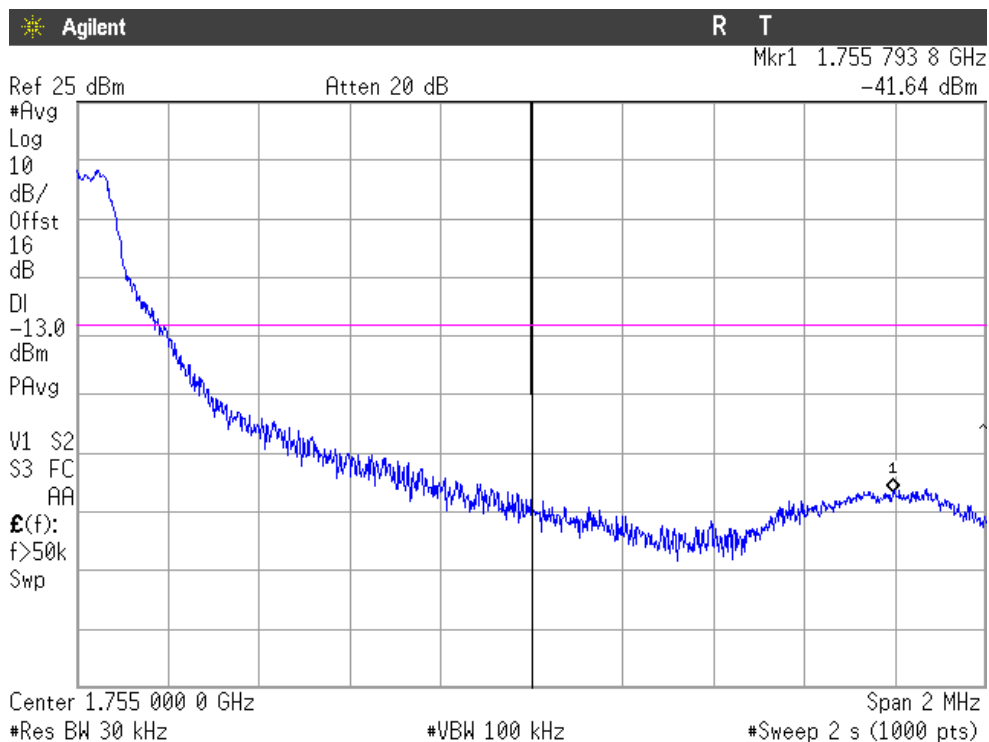

NOTE: The equipment transmits at the maximum output power

RB = All. Offset = 0. BW = 15 MHz (Band IV)

CHANNEL LOWEST. Narrow band = 1.

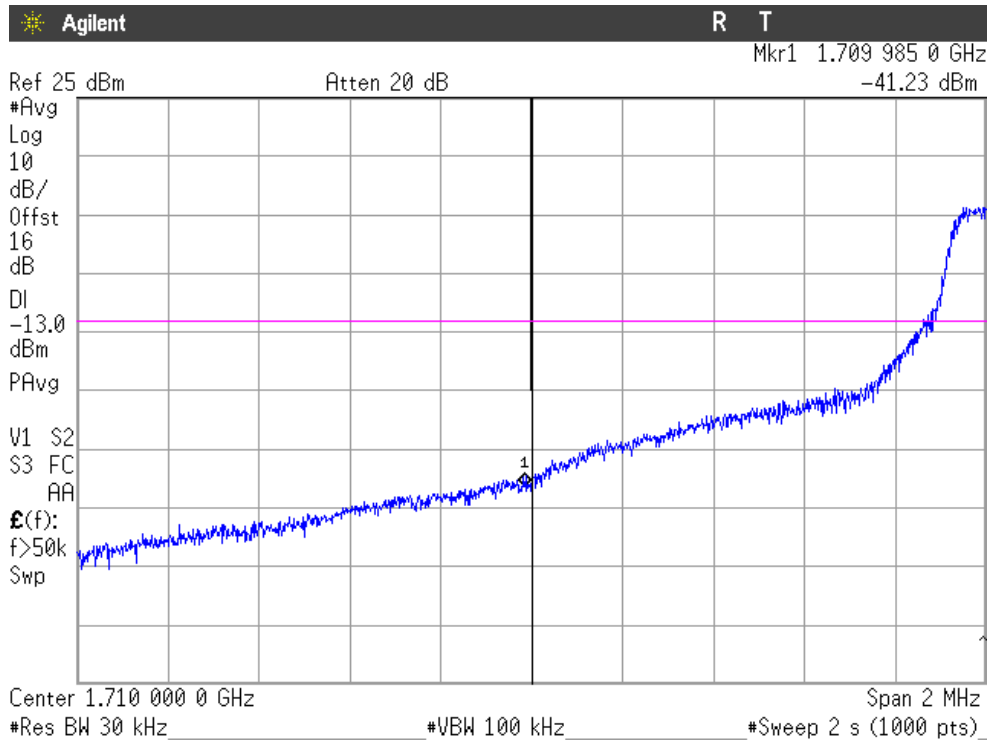

NOTE: The equipment transmits at the maximum output power

CHANNEL HIGHEST. Narrow band = 12.

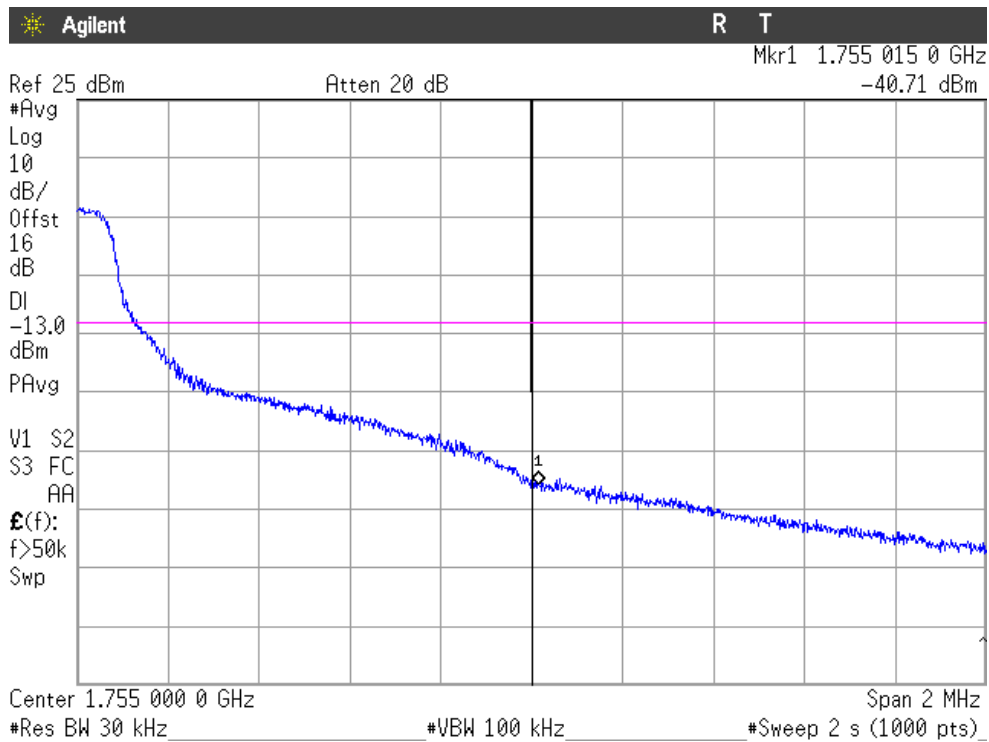

NOTE: The equipment transmits at the maximum output power

Verdict: PASS

Narrow band = 1. RB = 1. Offset = 0. BW = 20 MHz (Band IV)

CHANNEL LOWEST

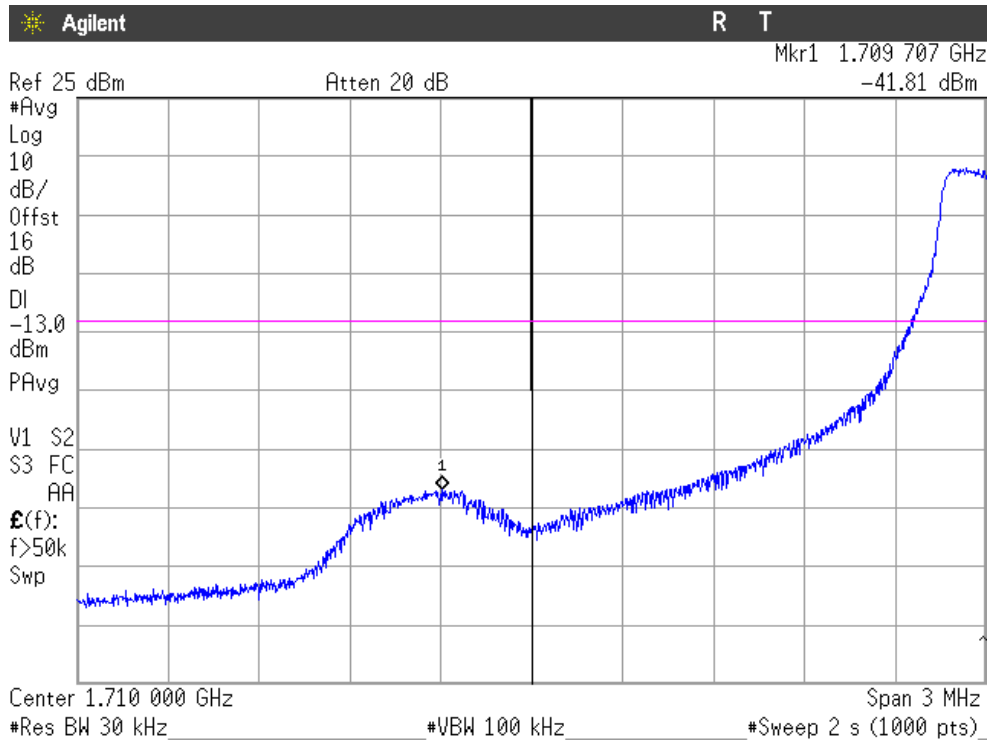

NOTE: The equipment transmits at the maximum output power

Narrow band = 16. RB = 1. Offset = Max. BW = 20 MHz (Band IV)

CHANNEL HIGHEST

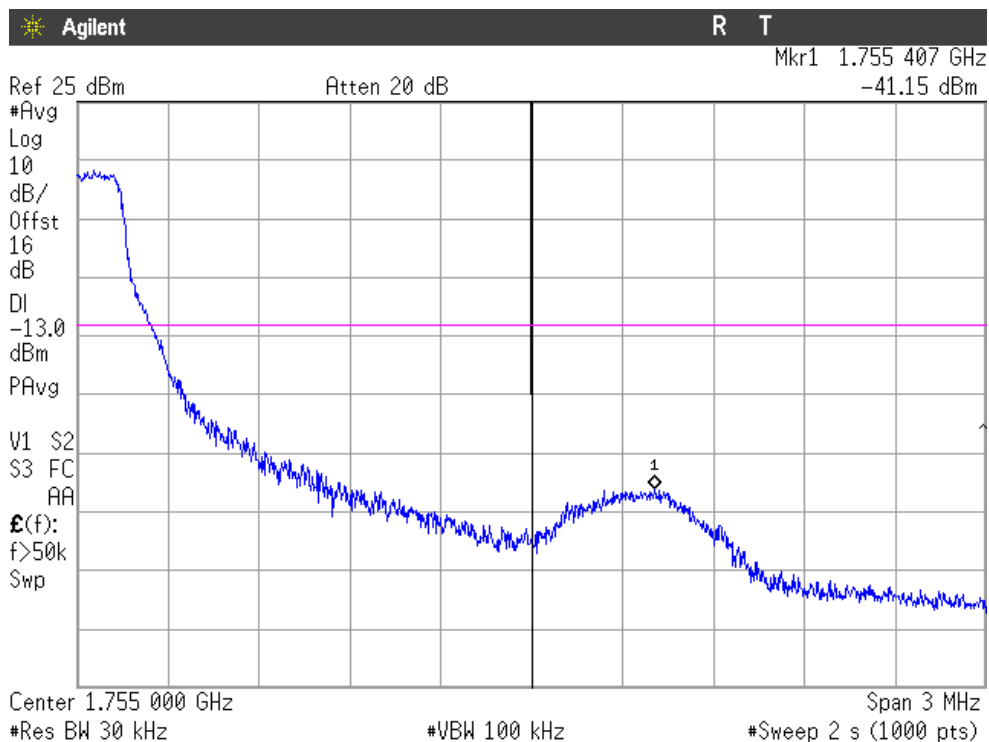

NOTE: The equipment transmits at the maximum output power

RB = All. Offset = 0. BW = 20 MHz (Band IV)

CHANNEL LOWEST. Narrow band = 1.

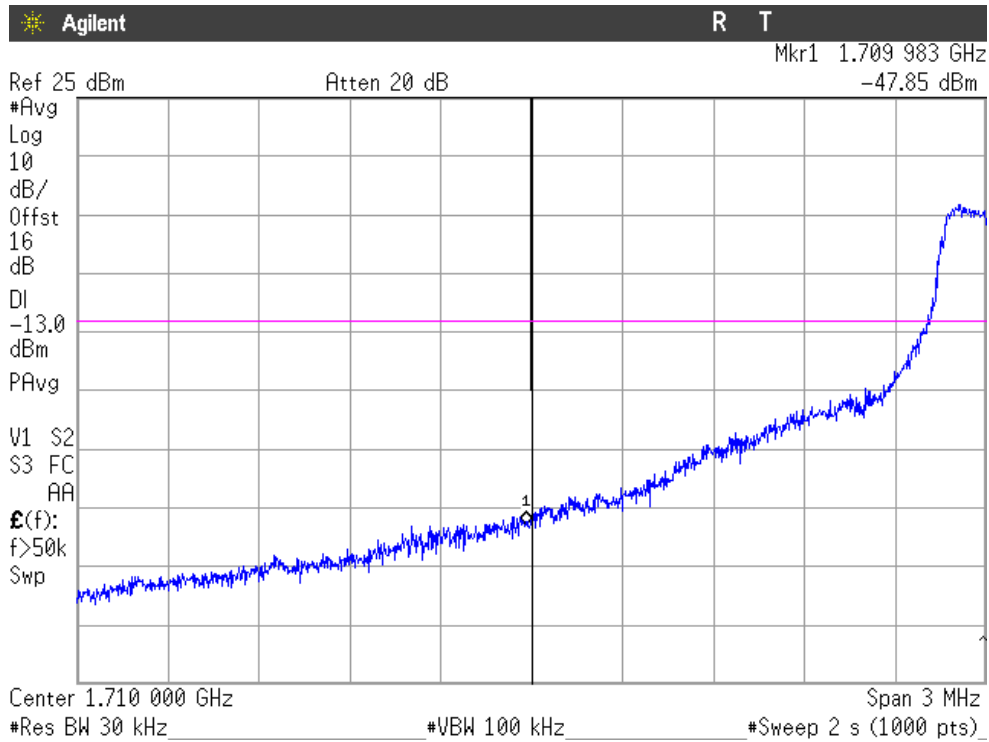

NOTE: The equipment transmits at the maximum output power

CHANNEL HIGHEST. Narrow band = 16.

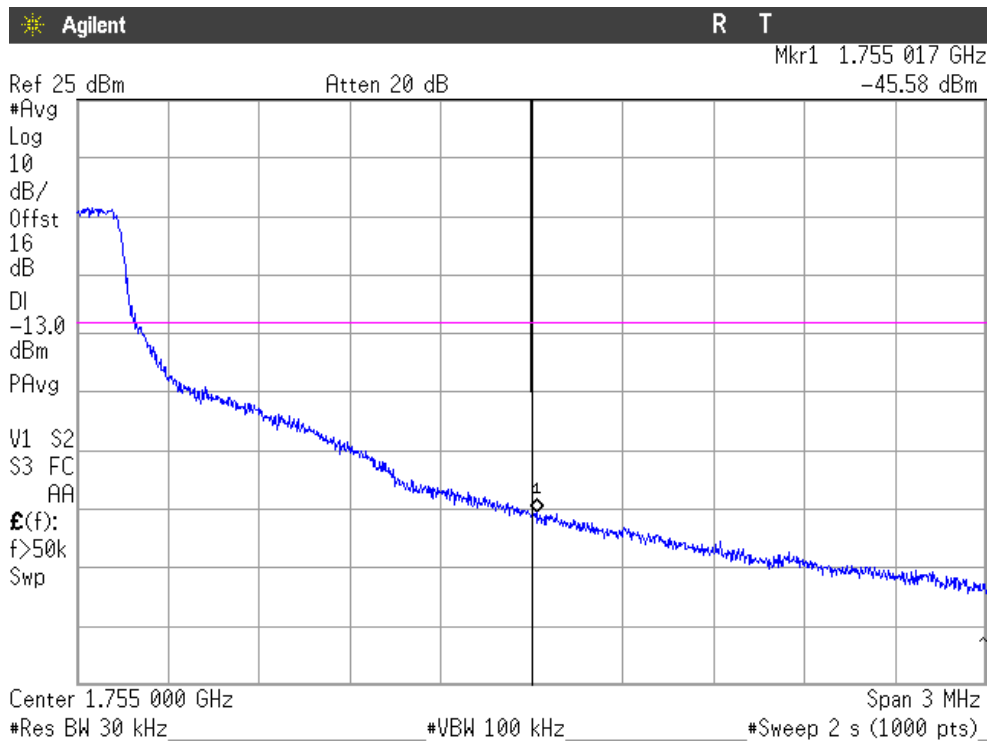

NOTE: The equipment transmits at the maximum output power

Verdict: PASS

Narrow band = 1. RB = 1. Offset = 0. BW = 5 MHz (Band XIII)

CHANNEL LOWEST

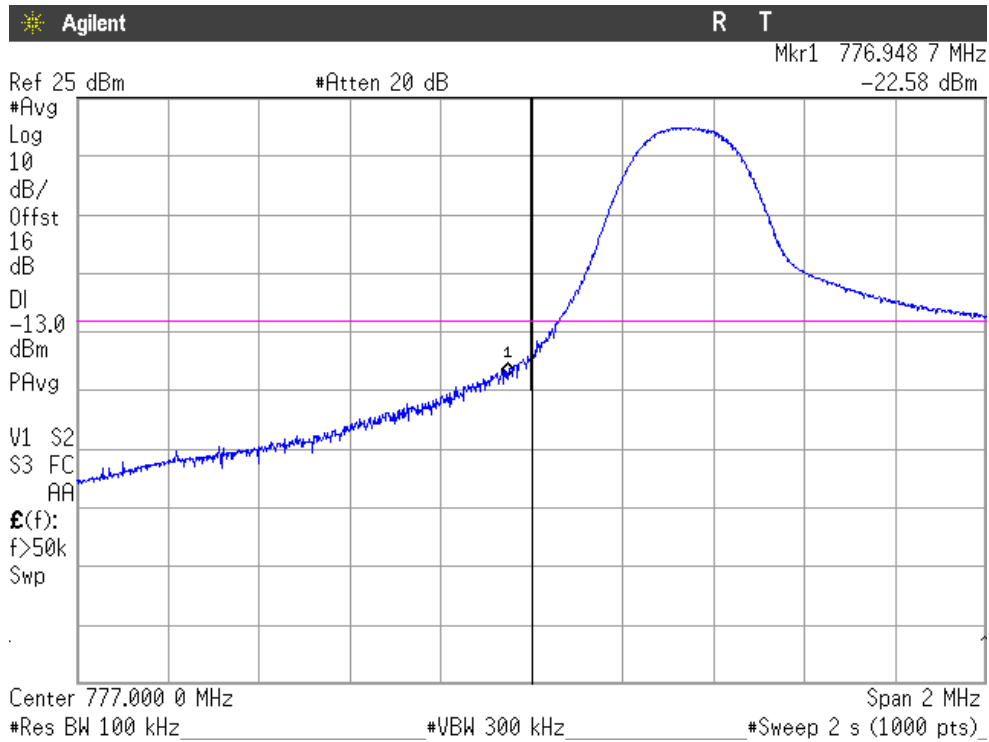

NOTE: The equipment transmits at the maximum output power

Narrow band = 4. RB = 1. Offset = Max. BW = 5 MHz (Band XIII)

CHANNEL HIGHEST

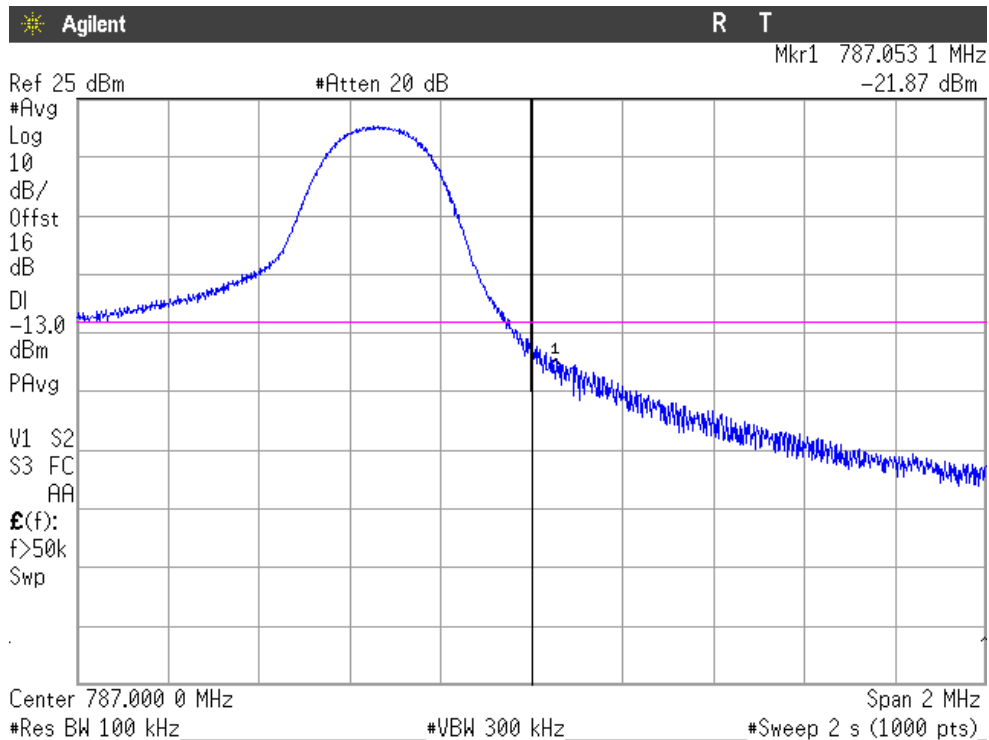

NOTE: The equipment transmits at the maximum output power

RB = All. Offset = 0. BW = 5 MHz (Band XIII)

CHANNEL LOWEST. Narrow band = 1.

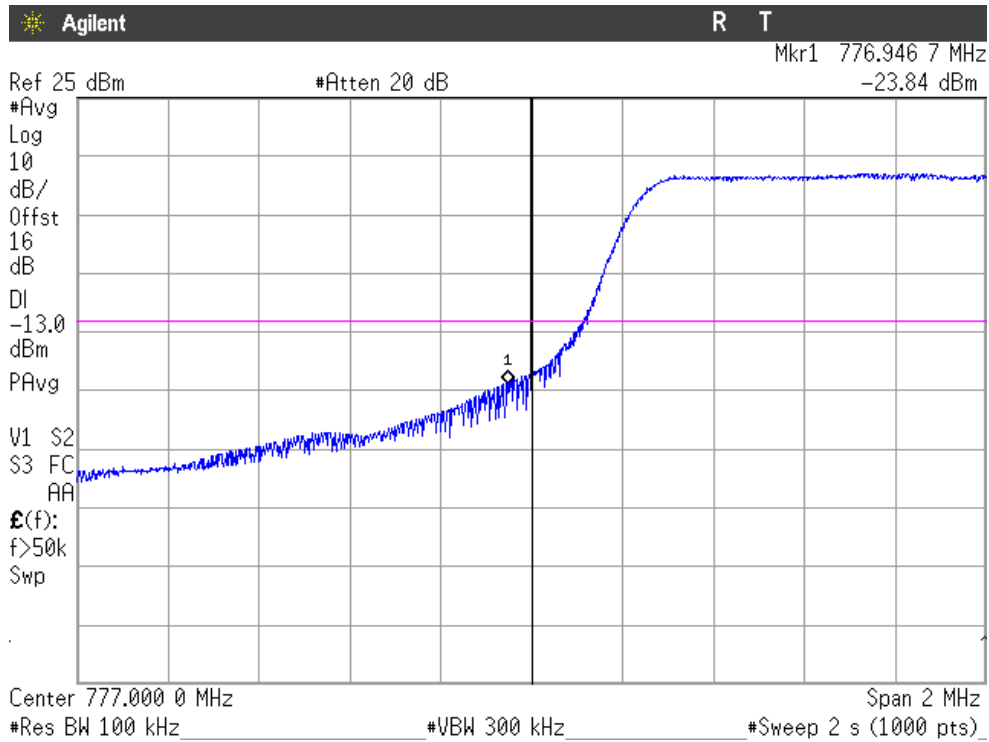

NOTE: The equipment transmits at the maximum output power

CHANNEL HIGHEST. Narrow band = 4.

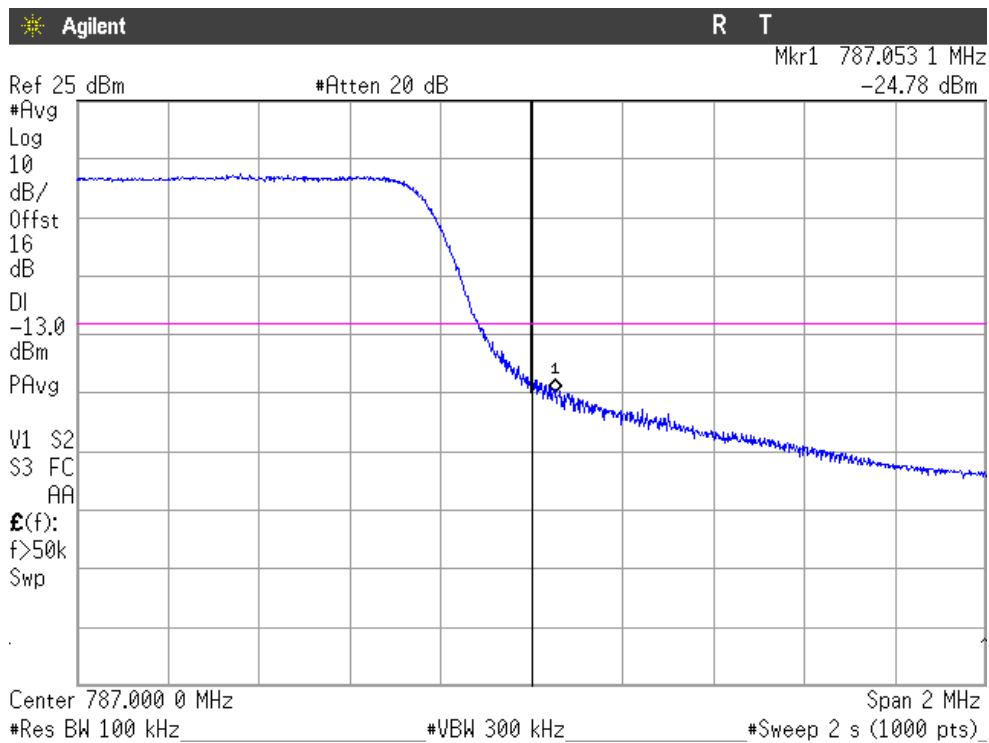

NOTE: The equipment transmits at the maximum output power

Verdict: PASS

Narrow band = 1. RB = 1. Offset = 0. BW = 10 MHz (Band XIII)

LOW FREQUENCY SECTION

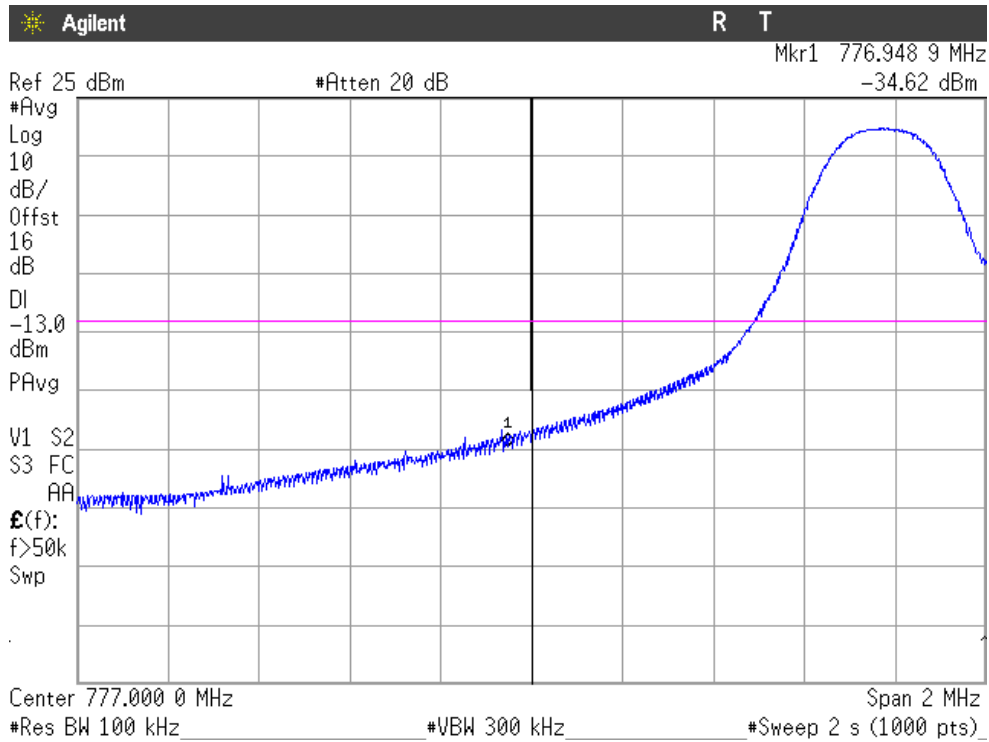

NOTE: The equipment transmits at the maximum output power

Narrow band = 8. RB = 1. Offset = Max. BW = 10 MHz (Band XIII)

HIGH FREQUENCY SECTION

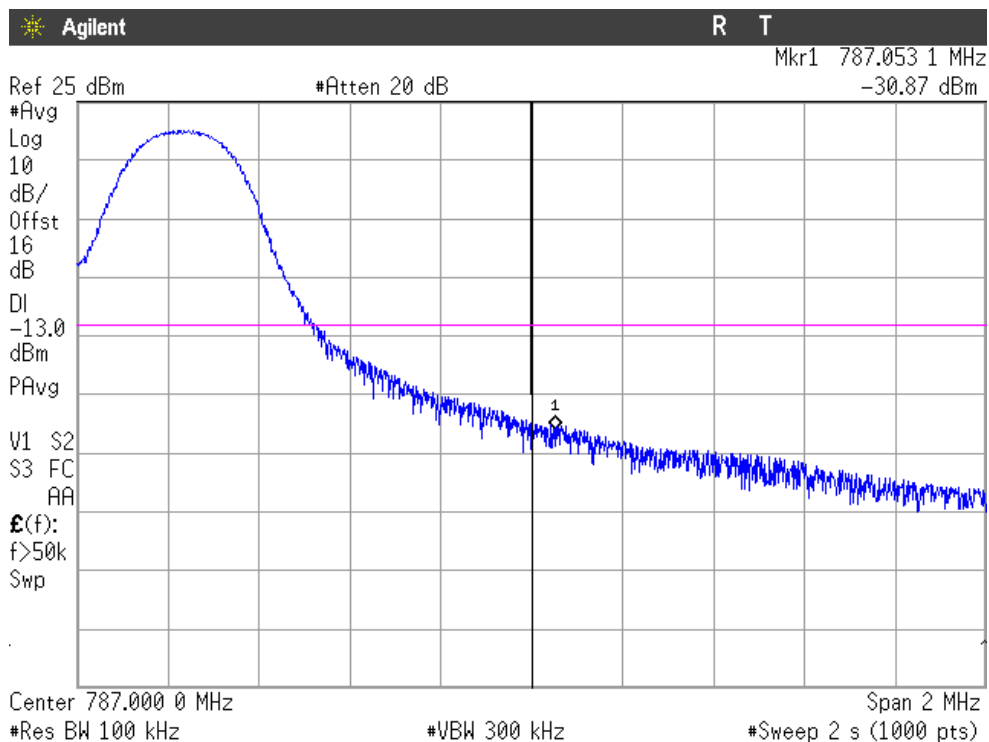

NOTE: The equipment transmits at the maximum output power

Narrow band = 1. RB = All. Offset = 0. BW = 10 MHz (Band XIII)

LOW FREQUENCY SECTION

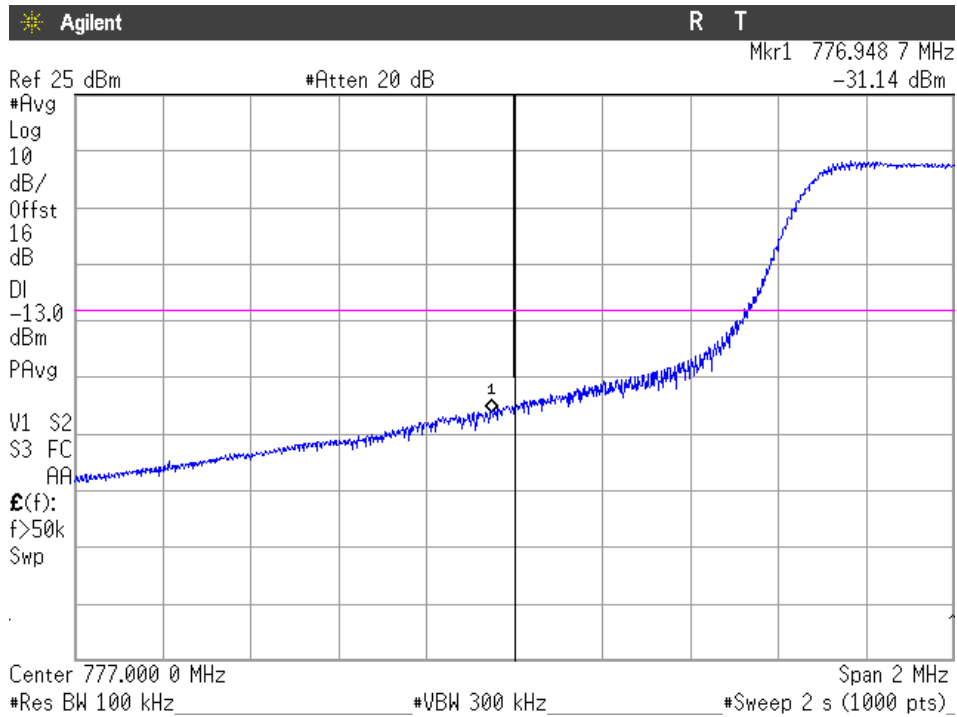

NOTE: The equipment transmits at the maximum output power

Narrow band = 8. RB = All. Offset = 0. BW = 10 MHz (Band XIII)

HIGH FREQUENCY SECTION

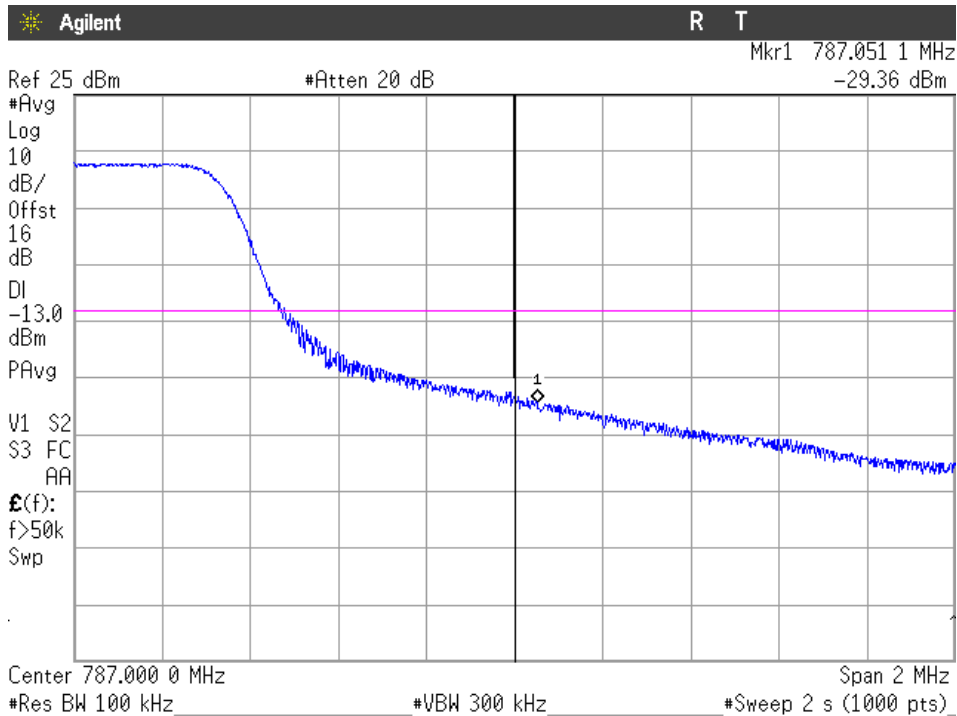

NOTE: The equipment transmits at the maximum output power

Verdict: PASS



## Radiated emissions

### SPECIFICATION

LTE BAND IV. FCC §27.53 (h). RSS-139 Clause 6.6.

According to specification, the power of emissions shall be attenuated below the transmitter power (P) by a factor of at least  $43 + 10 \log (P)$  dB. P in watts.

LTE BAND XIII.

FCC §27.53 (c) & (f).

On any frequency outside the 776-788 MHz band, the power of any emission shall be attenuated outside the band below the transmitter power (P) by at least  $43 + 10 \log (P)$  dB.

On all frequencies between 763-775 MHz and 793-805 MHz, by a factor not less than  $65 + 10 \log (P)$  dB in a 6.25 kHz band segment, for mobile and portable stations.

For operations in the 746-758 MHz, 775-788 MHz, and 805-806 MHz bands, emissions in the band 1559-1610 MHz shall be limited to  $-70$  dBW ( $-40$  dBm)/MHz equivalent isotropically radiated power (EIRP) for wideband signals, and  $-80$  dBW ( $-50$  dBm) EIRP for discrete emissions of less than 700 Hz bandwidth.

RSS-130 Clause 4.6.

The power of any unwanted emissions in any 100 kHz bandwidth on any frequency outside the frequency range(s) within which the equipment is designed to operate shall be attenuated below the transmitter power, P (dBW), by at least  $43 + 10 \log_{10} p$  (watts), dB.

The power of any unwanted emissions in any 6.25 kHz bandwidth for all frequencies between 763-775 MHz and 793-806 MHz shall be attenuated below the transmitter power, P (dBW), by at least  $65 + 10 \log_{10} p$ (watts), dB, for mobile and portable equipment.

The e.i.r.p. in the band 1559-1610 MHz shall not exceed  $-70$  dBW ( $-40$  dBm) /MHz for wideband signal and  $-80$  dBW ( $-50$  dBm) for discrete emission with bandwidth less than 700 Hz.

At  $P_o$  transmitting power, the specified minimum attenuation becomes  $43+10 \log (P_o)$ , and the level in dBm relative  $P_o$  becomes:

$$P_o \text{ (dBm)} - [43 + 10 \log (P_o \text{ in mwatts}) - 30] = -13 \text{ dBm.}$$

At  $P_o$  transmitting power, the specified minimum attenuation becomes  $65+10 \log (P_o)$ , and the level in dBm relative  $P_o$  becomes:

$$P_o \text{ (dBm)} - [65 + 10 \log (P_o \text{ in mwatts}) - 30] = -35 \text{ dBm.}$$

### METHOD

The measurement was performed with the EUT inside an anechoic chamber. The spectrum was scanned from 30 MHz to at least the 10th harmonic of the highest frequency generated within the equipment.

The EUT was placed on a non-conductive stand at a 3 meter distance from the measuring antenna for measurements below 1 GHz and at 1 m distance for measurements above 1 GHz.

Detected emissions were maximized at each frequency by rotating the EUT and adjusting the measuring antenna height and polarization. The maximum meter reading was recorded.

Each detected emission at less than 20 dB respect to the limit is substituted by the Substitution method in accordance with the ANSI/TIA-603-E: 2016.

## TEST SETUP

Radiated measurements below 1 GHz.

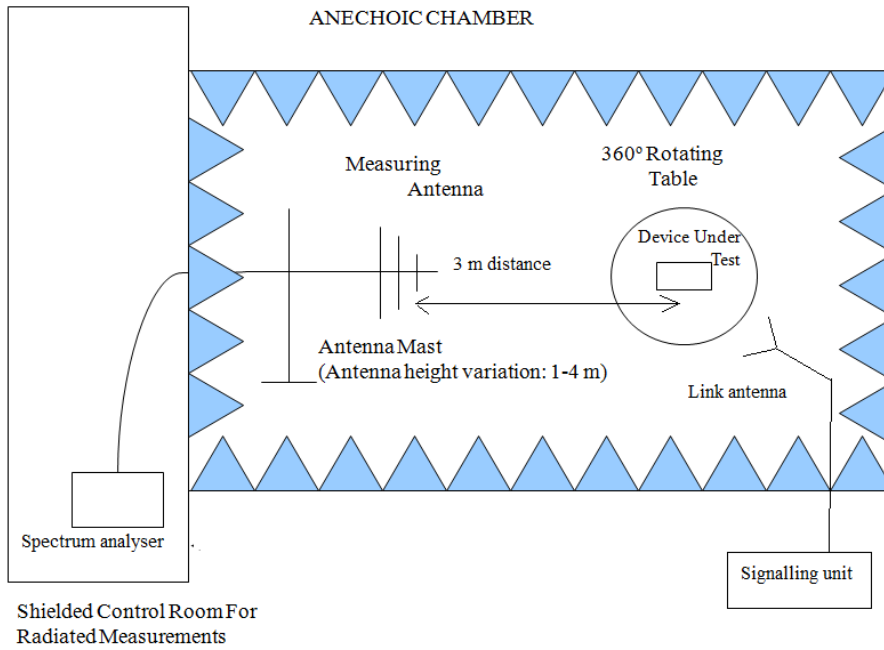

Radiated measurements above 1 GHz.

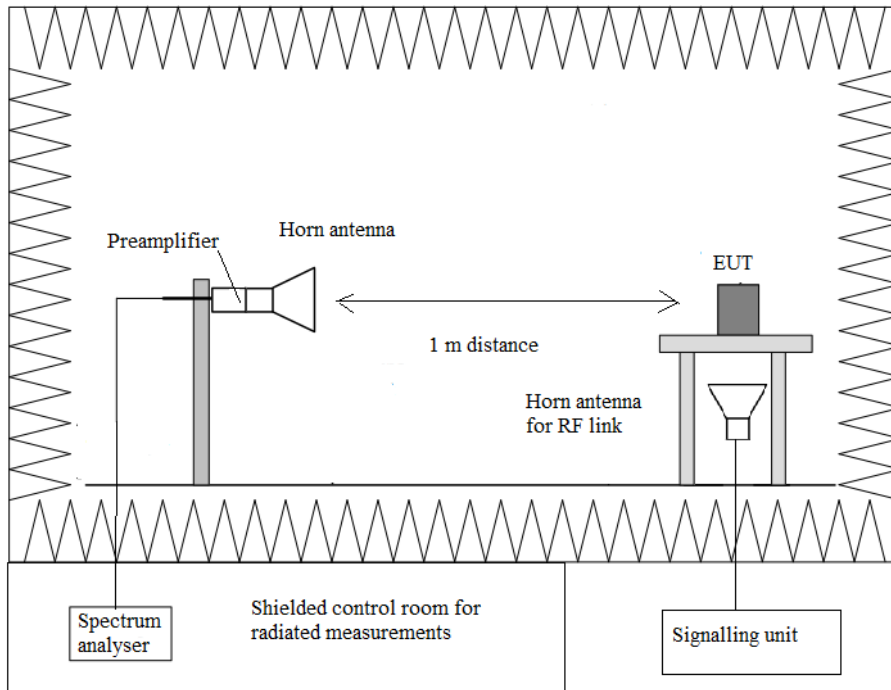

## RESULTS

LTE QPSK AND 16QAM MODULATION. Band IV. BW = 1.4 MHz. 3 MHz. 5 MHz. 10 MHz. 15 MHz and 20 MHz.

A preliminary scan determined the QPSK 5 MHz bandwidth, Narrow band =1, RB = 1, as the worst case.

The following tables and plots show the results for this configuration.

### 1. CHANNEL: LOWEST

#### **Frequency range 30 MHz-1000 MHz.**

No radiated spurious signals were detected at less than 20 dB respect to the limit.

#### **Frequency range 1 GHz-18 GHz.**

No radiated spurious signals were detected at less than 20 dB respect to the limit.

### 2. CHANNEL: MIDDLE

#### **Frequency range 30 MHz-1000 MHz.**

No radiated spurious signals were detected at less than 20 dB respect to the limit.

#### **Frequency range 1 GHz-18 GHz.**

No radiated spurious signals were detected at less than 20 dB respect to the limit.

### 3. CHANNEL: HIGHEST

#### **Frequency range 30 MHz-1000 MHz.**

No radiated spurious signals were detected at less than 20 dB respect to the limit.

#### **Frequency range 1 GHz-18 GHz.**

No radiated spurious signals were detected at less than 20 dB respect to the limit.

LTE QPSK AND 16QAM MODULATION. Band XIII. BW = 5 MHz and 10 MHz.

A preliminary scan determined the QPSK 5 MHz bandwidth, Narrow band =1, RB = 1, as the worst case.

The following tables and plots show the results for this configuration.

1. CHANNEL: LOWEST

**Frequency range 30 MHz-1000 MHz.**

No radiated spurious signals were detected at less than 20 dB respect to the limit.

**Frequency range 1 GHz-8 GHz.**

No radiated spurious signals were detected at less than 20 dB respect to the limit.

**Frequency range 1559 MHz-1610 MHz.**

Substitution method data

Frequency (MHz)	Instrument reading (dBm)	Polarization	(1) Generator output (dBm)	(2) Cable loss (dB)	(3) Substitution antenna gain Gi (respect to isotropic radiator) (dB)	E.I.R.P. (dBm) = (1) – (2) + (3)
1567.8732	-37.82	H	-57.03	0.79	8.35	-49.47

No discrete signals were detected. Only wideband signals were detected.

2. CHANNEL: MIDDLE

**Frequency range 30 MHz-1000 MHz.**

No radiated spurious signals were detected.

**Frequency range 1 GHz-8 GHz.**

No radiated spurious signals were detected at less than 20 dB respect to the limit.

**Frequency range 1559 MHz-1610 MHz.**

Substitution method data

Frequency (MHz)	Instrument reading (dBm)	Polarization	(1) Generator output (dBm)	(2) Cable loss (dB)	(3) Substitution antenna gain Gi (respect to isotropic radiator) (dB)	E.I.R.P. (dBm) = (1) – (2) + (3)
1572.6842	-38.34	H	-58.12	0.80	8.93	-49.99

No discrete signals were detected. Only wideband signals were detected.

3. CHANNEL: HIGHEST

**Frequency range 30 MHz-1000 MHz.**

No radiated spurious signals were detected.

**Frequency range 1 GHz-8 GHz.**

No radiated spurious signals were detected at less than 20 dB respect to the limit.

**Frequency range 1559 MHz-1610 MHz. RBW = 1 MHz**

Substitution method data

Frequency (MHz)	Instrument reading (dBm)	Polarization	(1) Generator output (dBm)	(2) Cable loss (dB)	(3) Substitution antenna gain Gi (respect to isotropic radiator) (dB)	E.I.R.P. (dBm) = (1) – (2) + (3)
1561.3724	-39.54	H	-58.75	0.79	8.32	-51.22
1577.8896	-38.49	H	-58.37	0.87	9.10	-50.14

No discrete signals were detected. Only wideband signals were detected.

Verdict: PASS

FREQUENCY RANGE 30 MHz-1000 MHz.

**LTE Band IV**

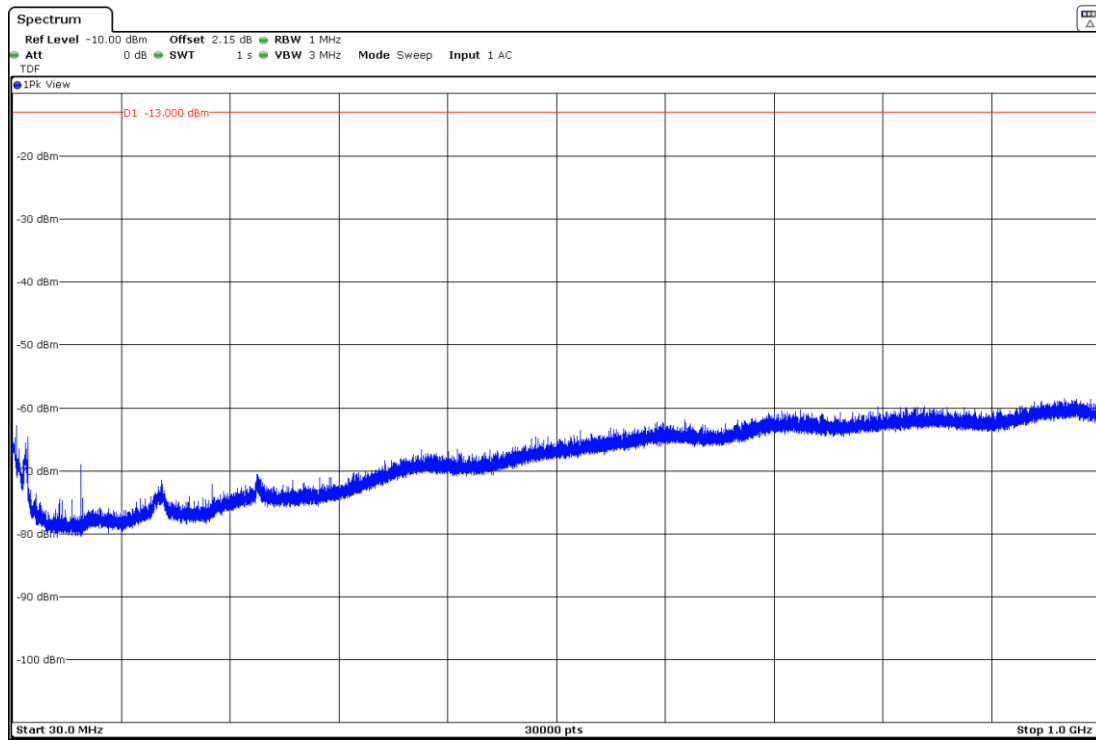

(This plot is valid for all three channels)

**LTE Band XIII**

CHANNEL: LOWEST

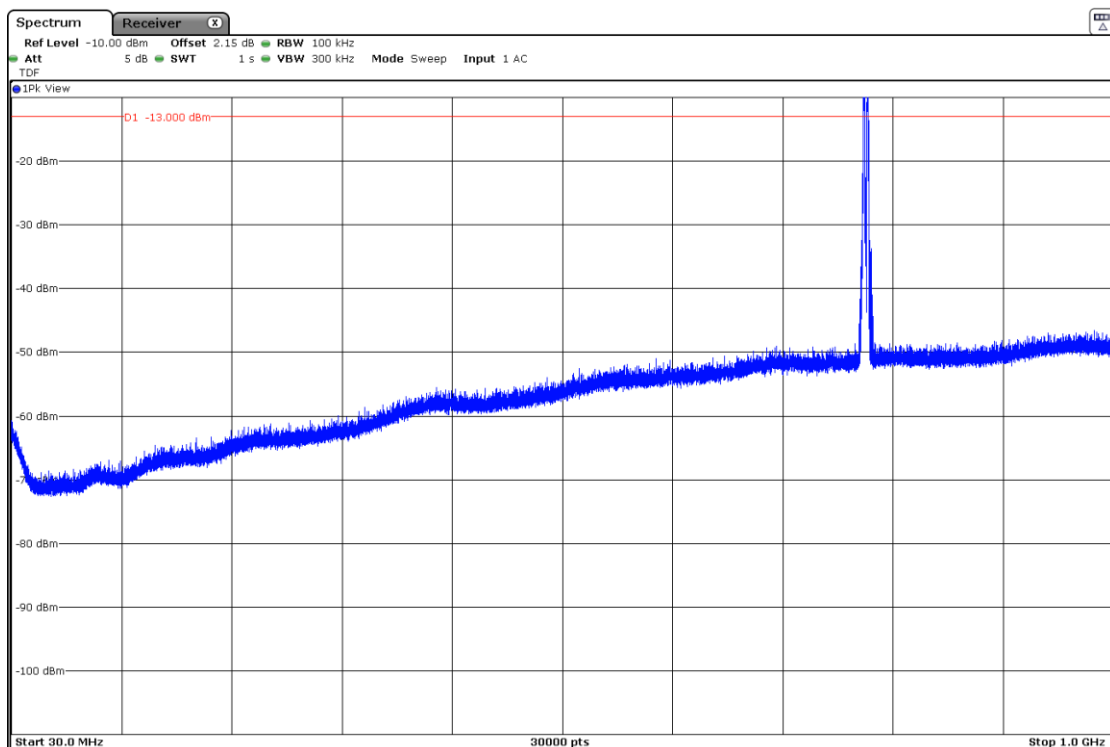

Note: The peak above the limit is the carrier frequency.

CHANNEL: MIDDLE

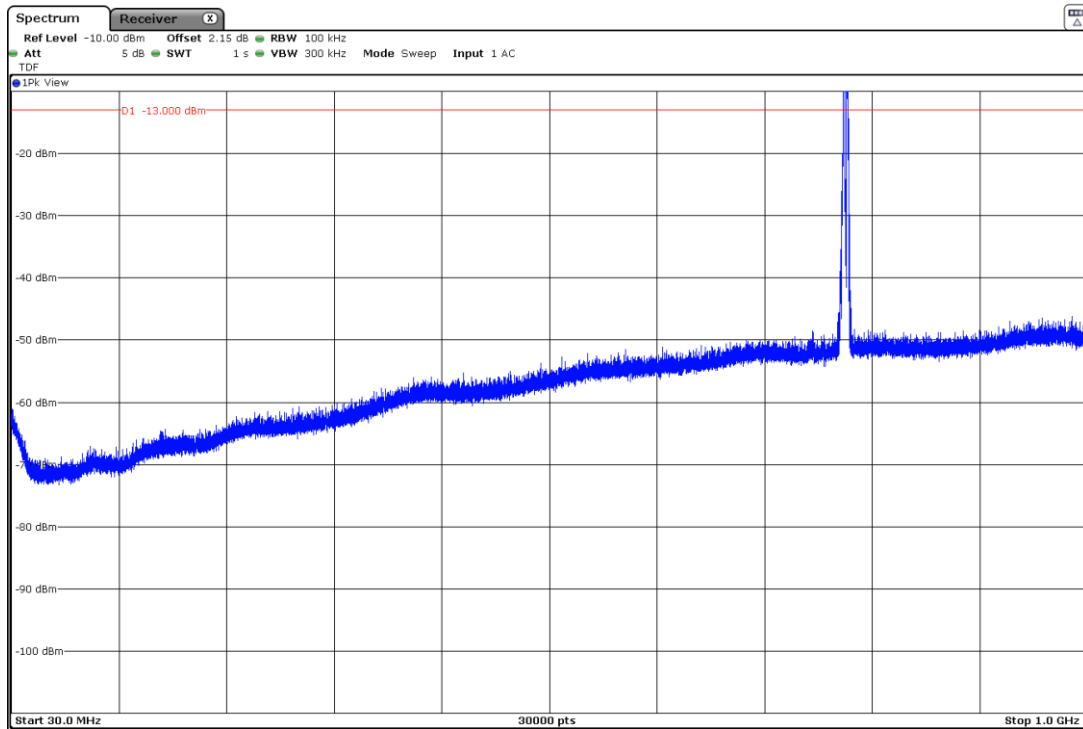

Note: The peak above the limit is the carrier frequency.

CHANNEL: HIGHEST

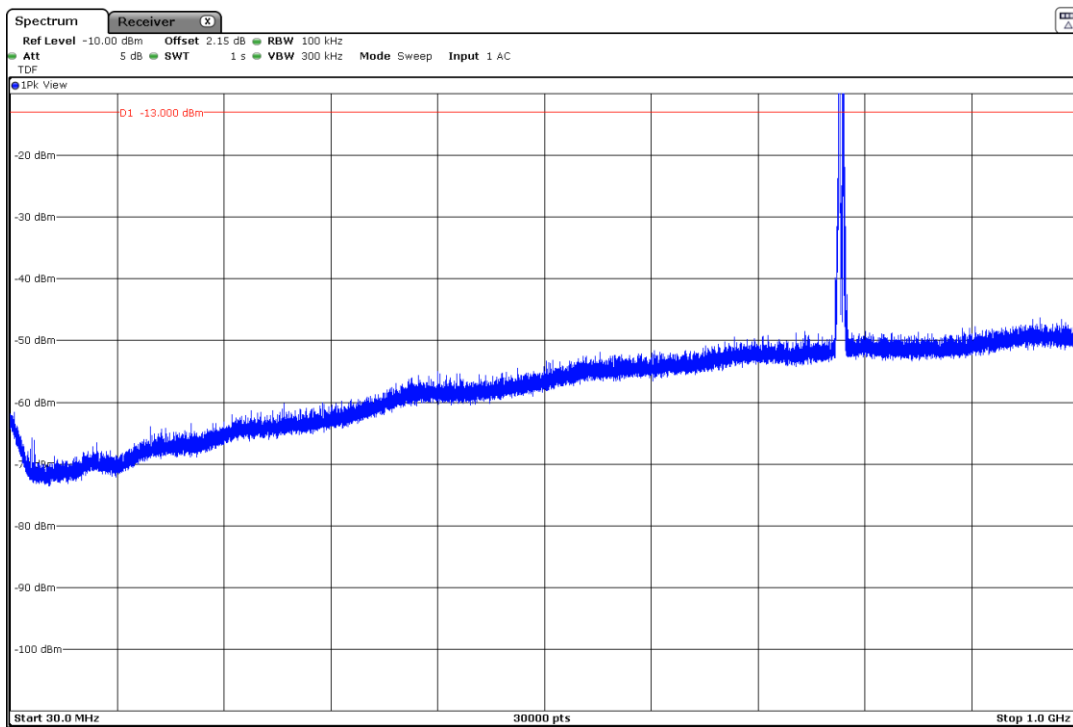

Note: The peak above the limit is the carrier frequency.

## LTE Band IV. Frequency range 1 GHz to 3 GHz

CHANNEL: LOWEST

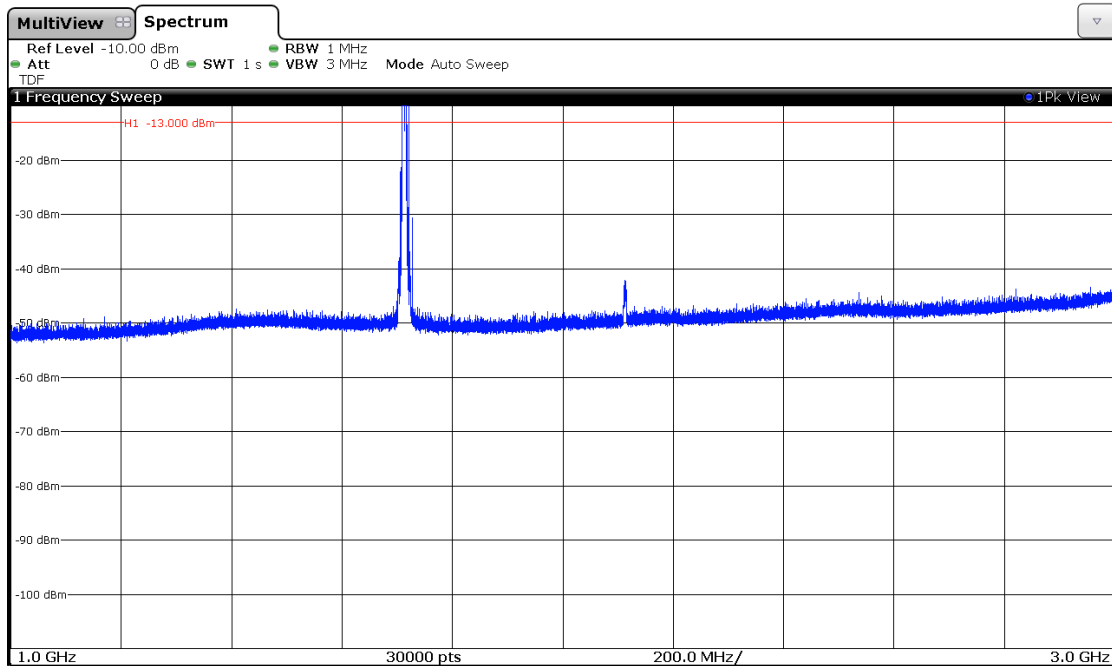

Note: The peak above the limit is the carrier frequency.

CHANNEL: MIDDLE

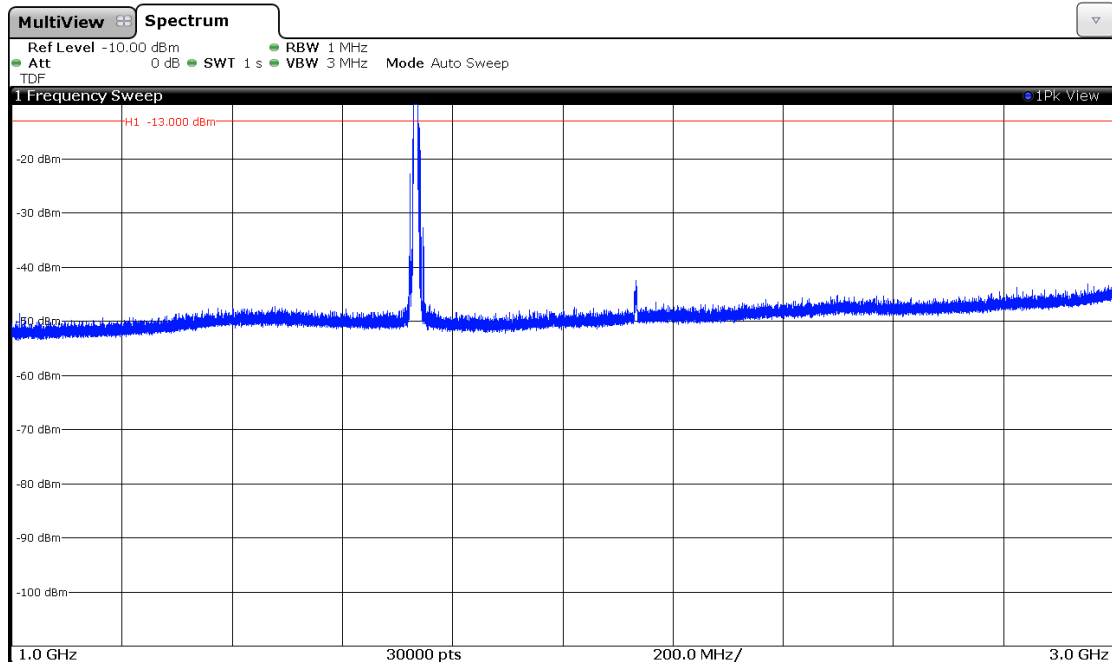

Note: The peak above the limit is the carrier frequency.



CHANNEL: HIGHEST

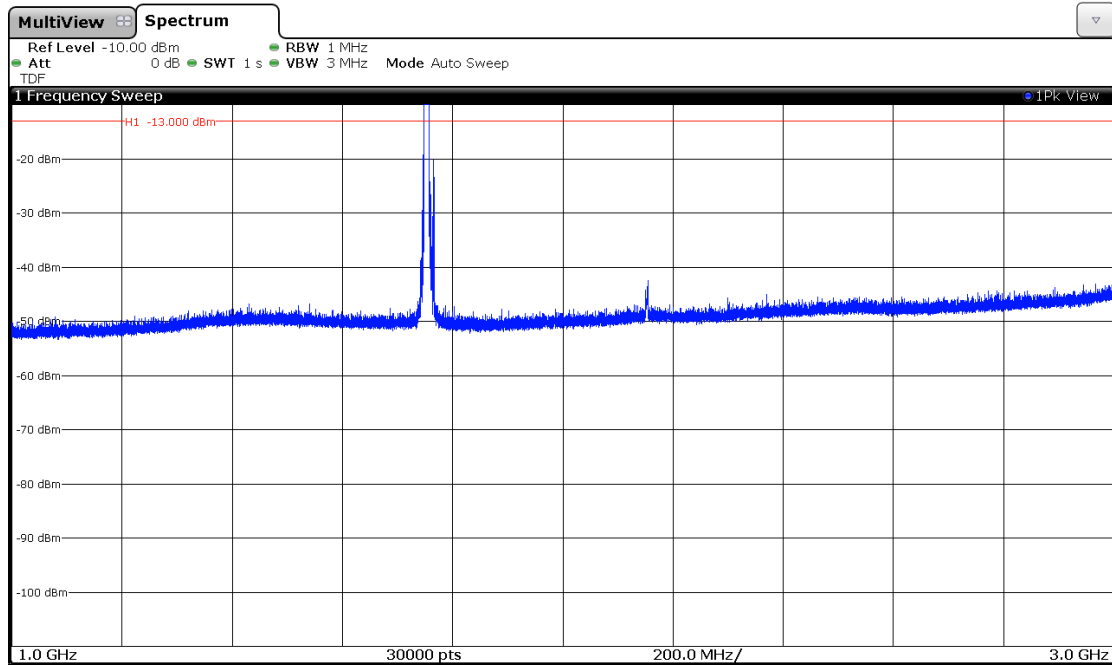

Note: The peak above the limit is the carrier frequency.

LTE Band XIII. Frequency range 1 GHz to 8 GHz.

CHANNEL: LOWEST

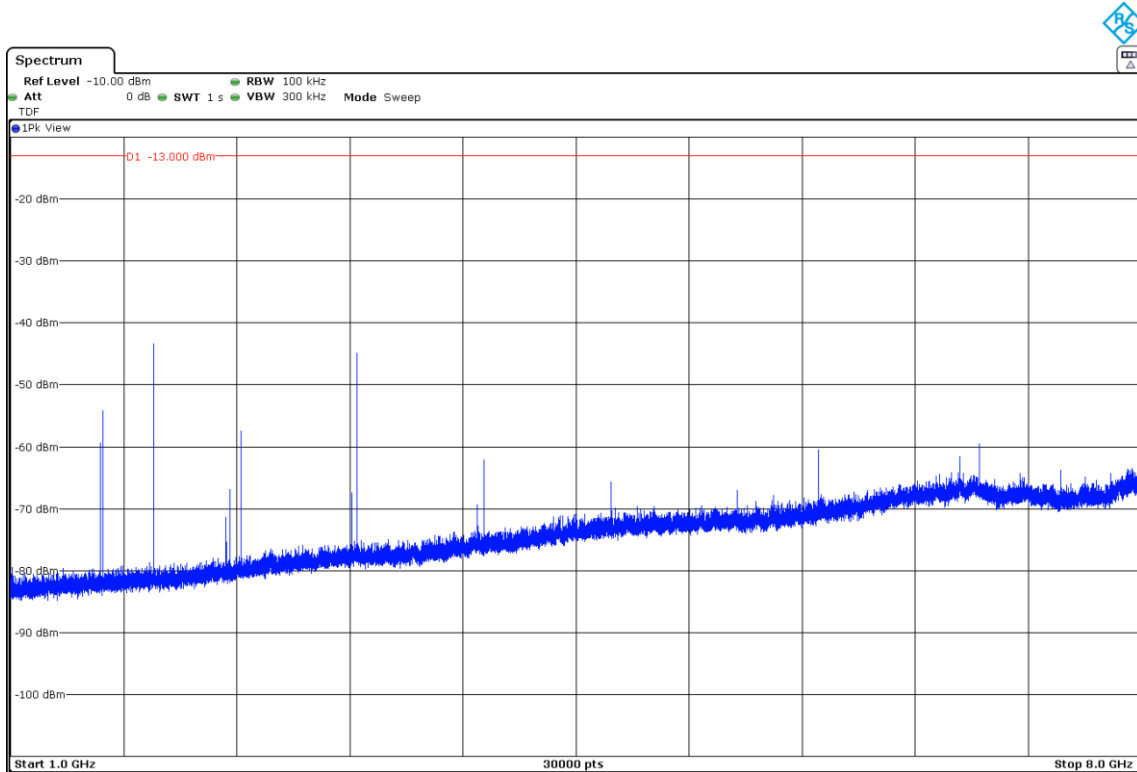

CHANNEL: MIDDLE

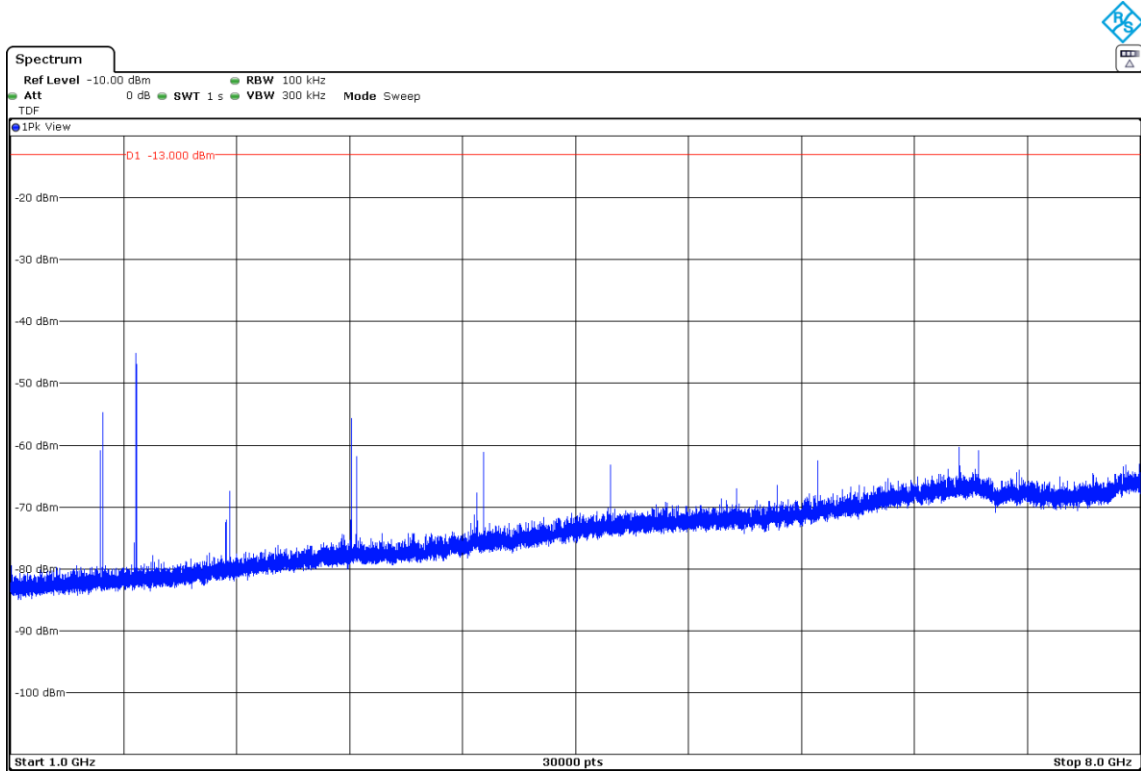

CHANNEL: HIGHEST

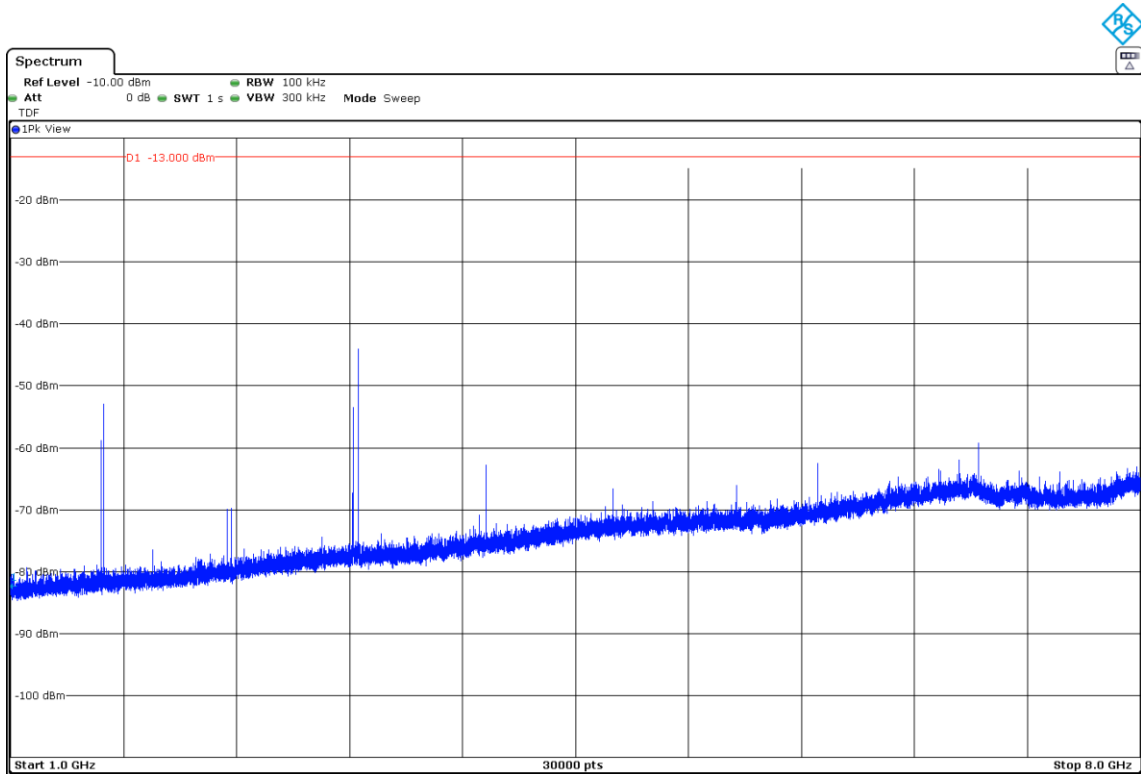

## LTE Band IV. Frequency range 3 GHz to 18 GHz

CHANNEL: LOWEST

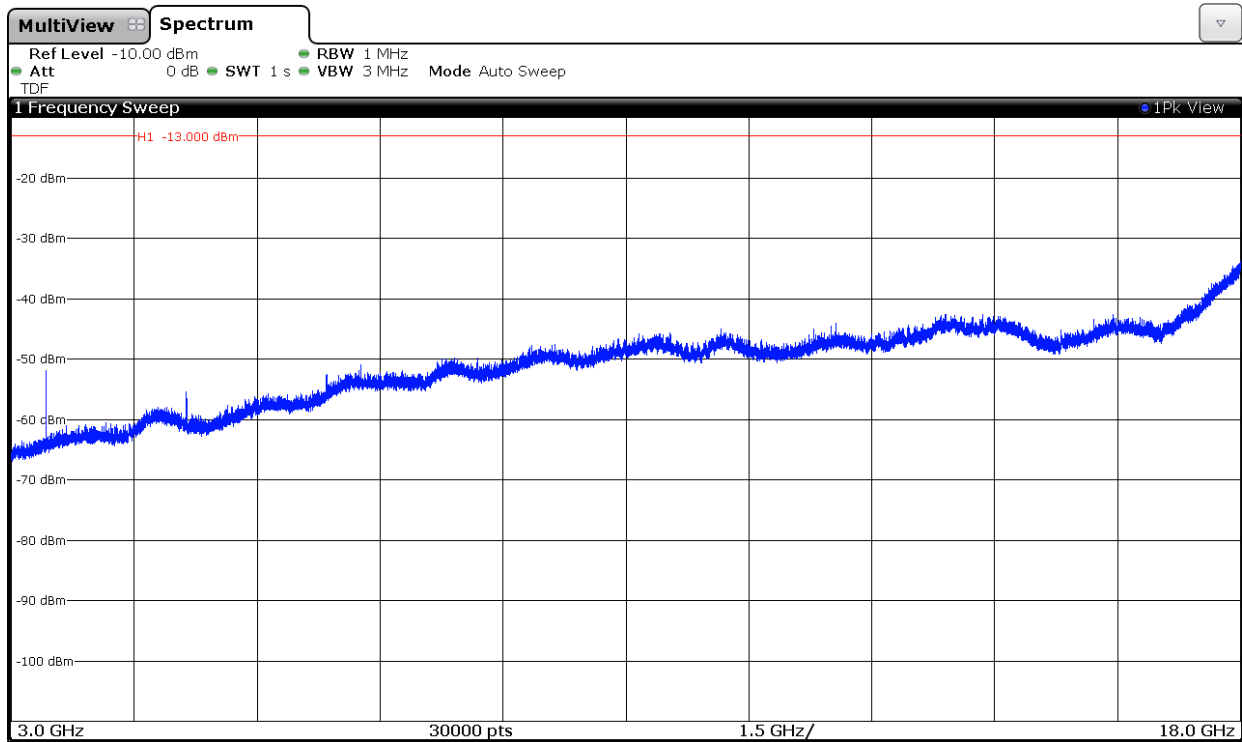

CHANNEL: MIDDLE

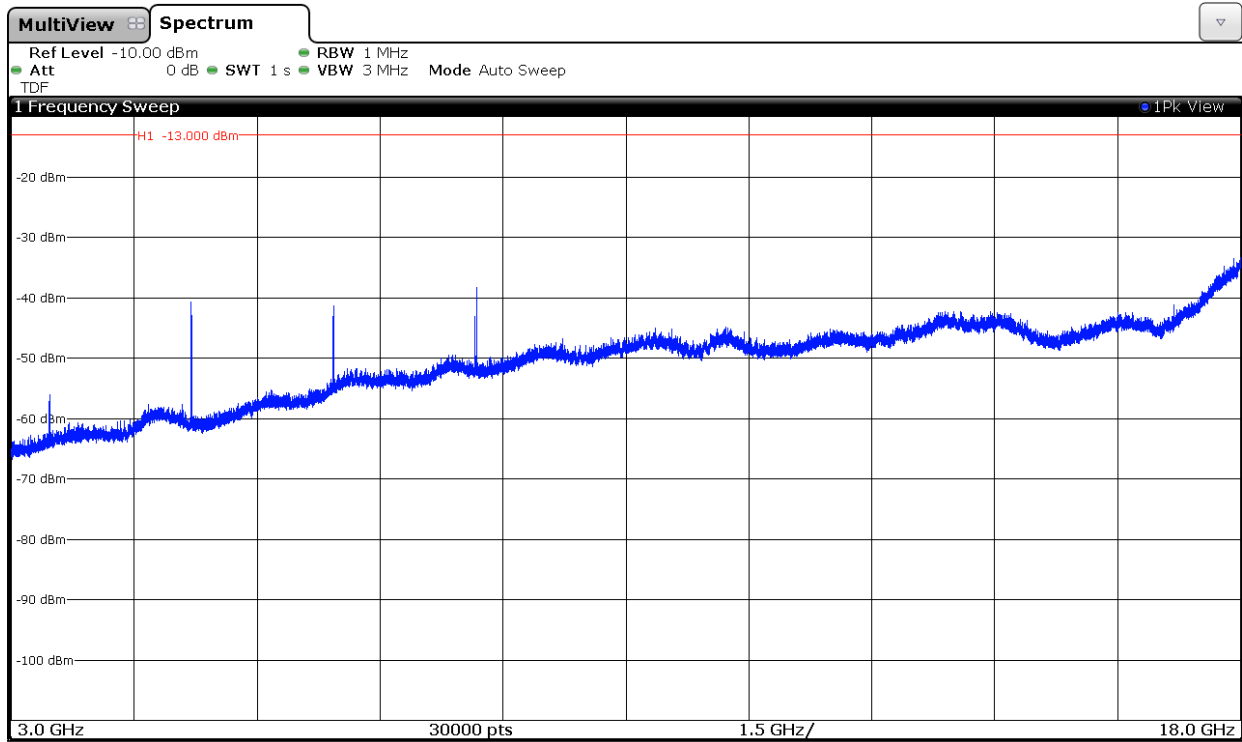

CHANNEL: HIGHEST

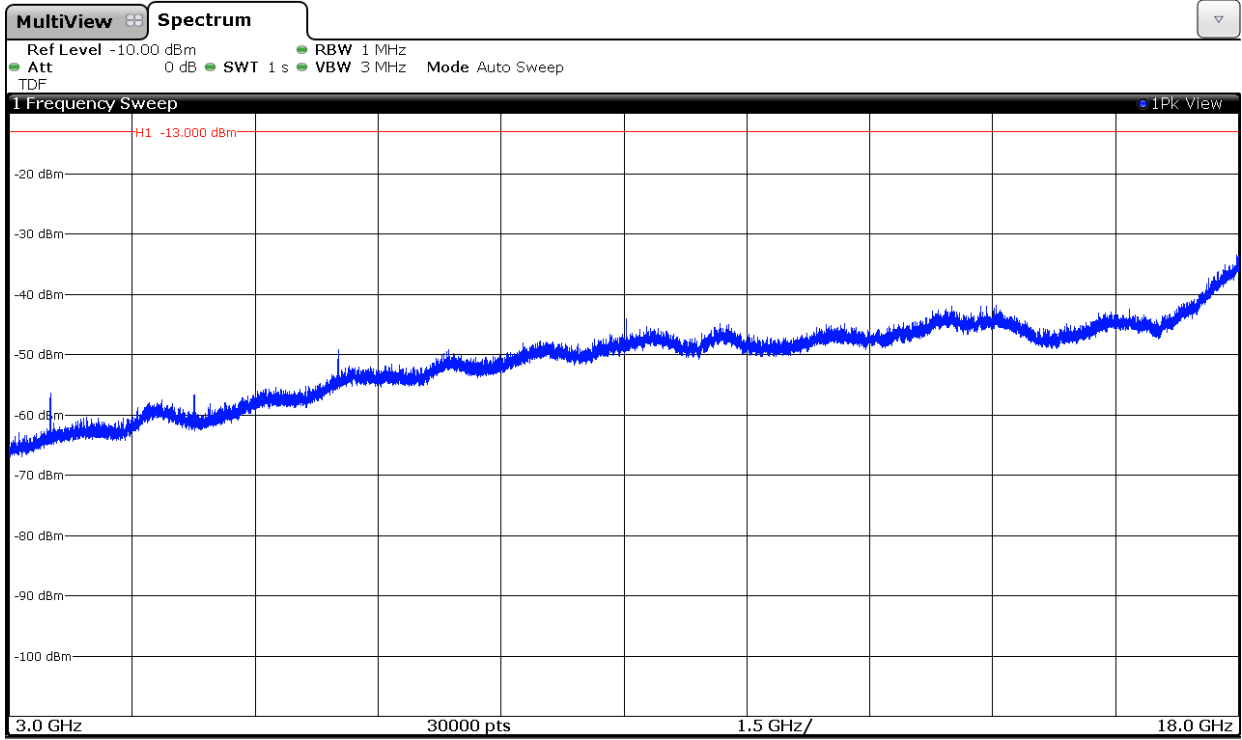

LTE Band XIII. Frequency range 1559 MHz to 1610 MHz.

CHANNEL: LOWEST

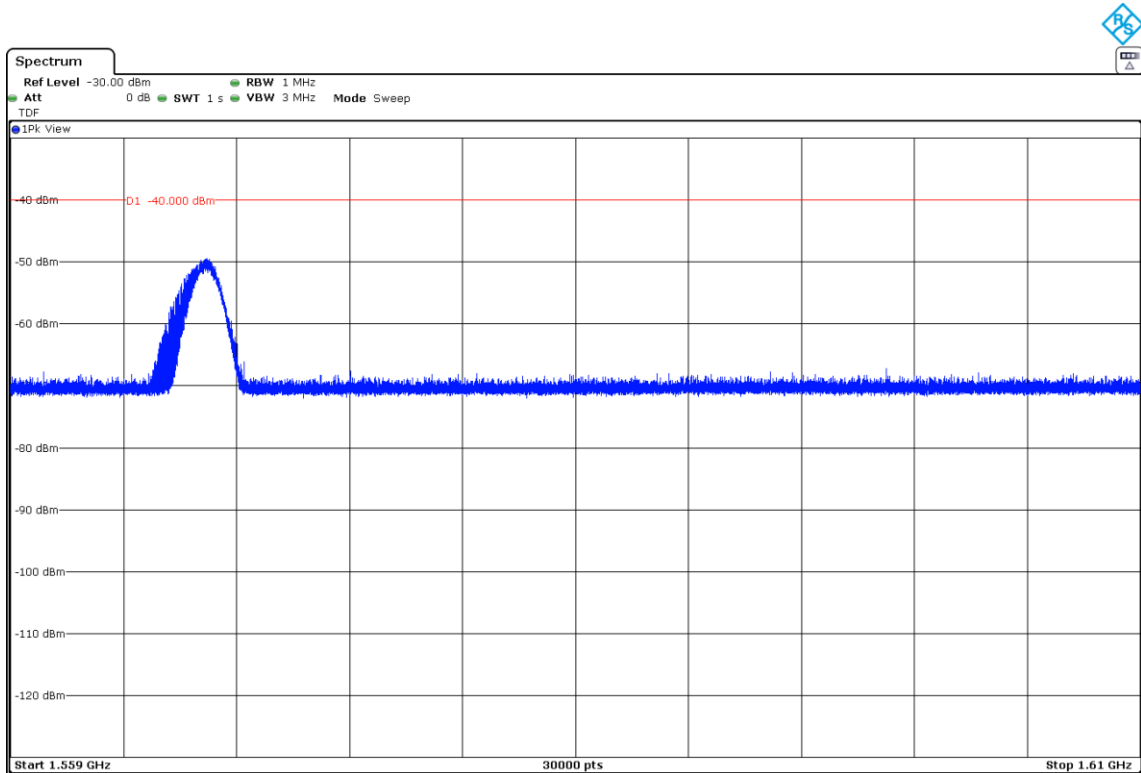

CHANNEL: MIDDLE

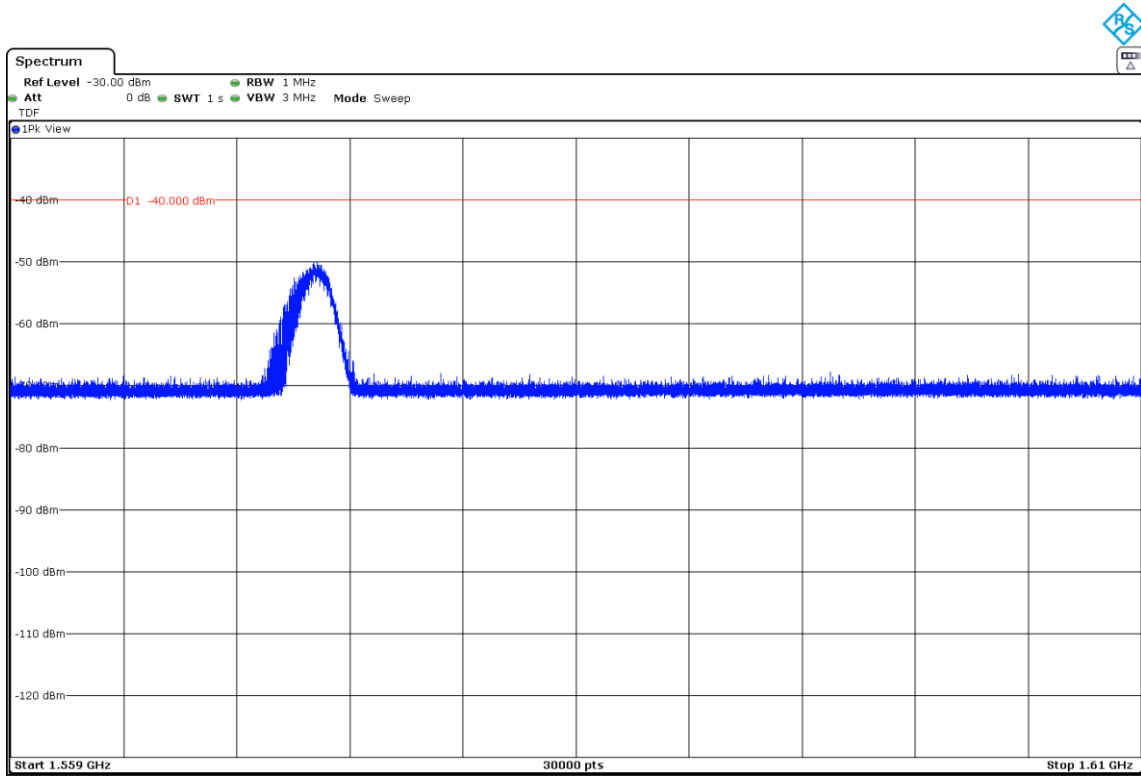

CHANNEL: HIGHEST

