

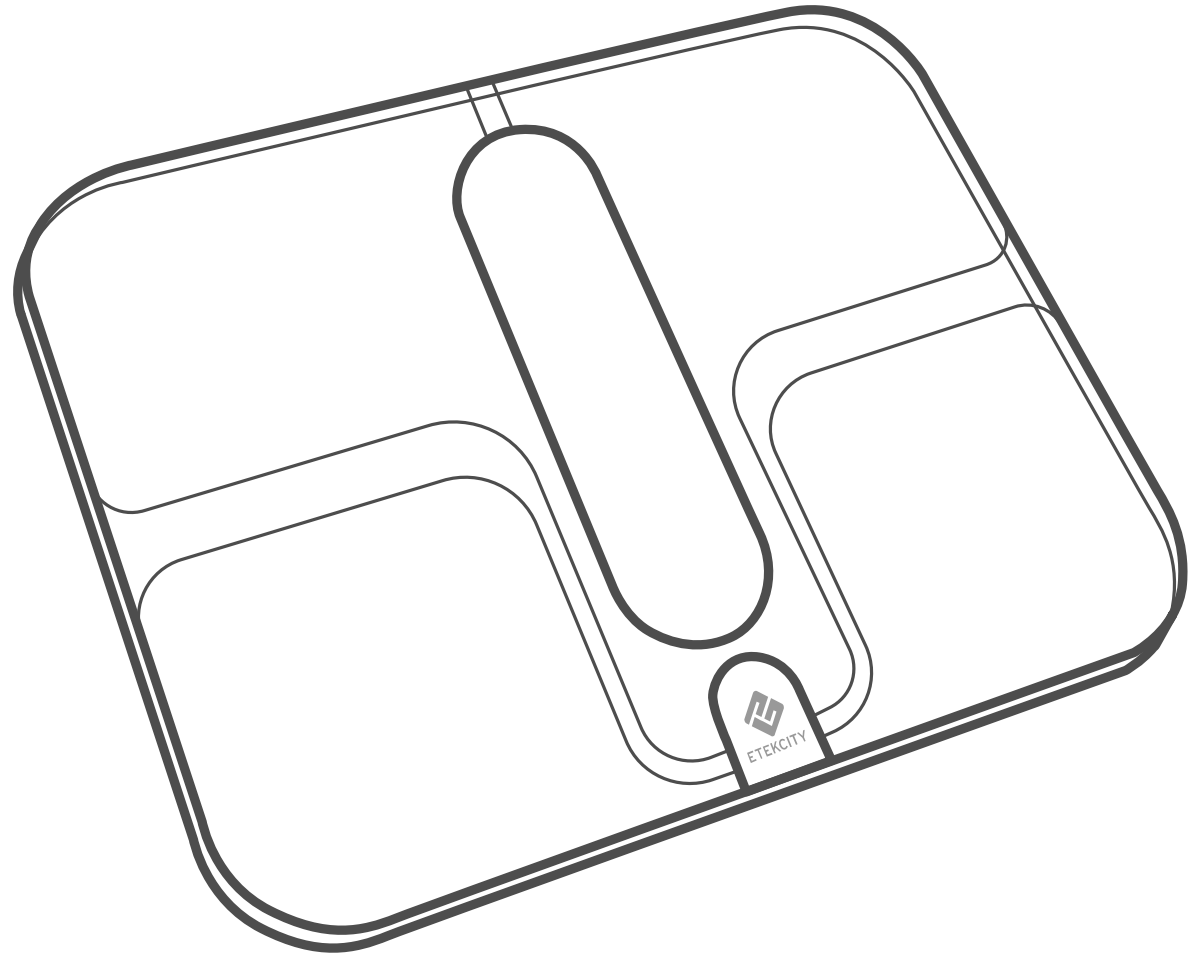

Smart Fitness Scale

Model: ESF00+



Thank you for purchasing the
ESFOO+ Smart Fitness Scale
by Etekcitey.

If you have any questions or concerns, please reach out to our helpful Customer Support Team at support@etekcity.com. We hope you enjoy your new scale!

BECOME AN ETEKCITIZEN

Get exclusive deals, giveaways, and product registration. Better products for better living.
Find us at etekcity.com

Table of Contents

Package Contents	3
Specifications	3
Safety Information	4
Function Diagram	5
Digital Display	6
Vesync App Setup	7
Using the Smart Scale	8
• Weighing with the VeSync App	9
• Connecting the Scale to WiFi	13
• Using the App	15
Maintenance	25
Troubleshooting	28
Warranty Information	32
Customer Support	33

Package Contents

- 1 x Smart Fitness Scale
- 1 x USB Charging Cable
- 1 x Measuring Tape
- 1 x Quick Start Guide

Specifications

Weight Capacity	400 lb / 28 st / 180 kg
Graduation	0.1 lb / 0.05 kg
Weight Units	lb / st / kg
Platform	ITO-coated glass
Dimensions	14.8 x 11.8 x 1.0 in / 375 x 300 x 24 mm
Battery Type	1000mAh Li-ion battery
Charging Time	3 hours
Input	DC 5V, 500mA
Auto-Off	30 seconds

Safety Information

Please read and follow all instructions and safety guidelines in this manual.

Medical

- This scale should not be used to diagnose or treat any medical condition.
- Scale data should not be used as a substitute for medical advice from a healthcare professional.
- This scale uses a harmless electrical current to measure body fat. Consult a healthcare professional before using the smart scale if you use medical electronic equipment such as a pacemaker.

General Use

- Check the scale before using. **Do not** use the scale if it is damaged in any way.
- The glass platform is slippery when wet. **Always** make sure the platform and your feet are dry before stepping on for measurement.
- Place the scale on a hard, flat surface to avoid tipping.

- To weigh safely and accurately, stand with your feet shoulder-width apart while on the scale. **Do not** stand on the edge of the scale or jump on the scale.
- Avoid standing on the scale for a long period of time, or when not weighing yourself.
- **Do not** overload the scale. Maximum weight capacity is 400 lb / 180 kg.
- Keep the scale in a cool area with low humidity. Keep the scale away from heat sources, such as ovens or heaters. Avoid temperature fluctuations. Store the scale in a horizontal position, not vertical.
- **Do not** use while charging. Remove the power cord before using.
- Handle with care. Not for commercial use. Household use **only**.

**SAVE THESE
INSTRUCTIONS**

Function Diagram

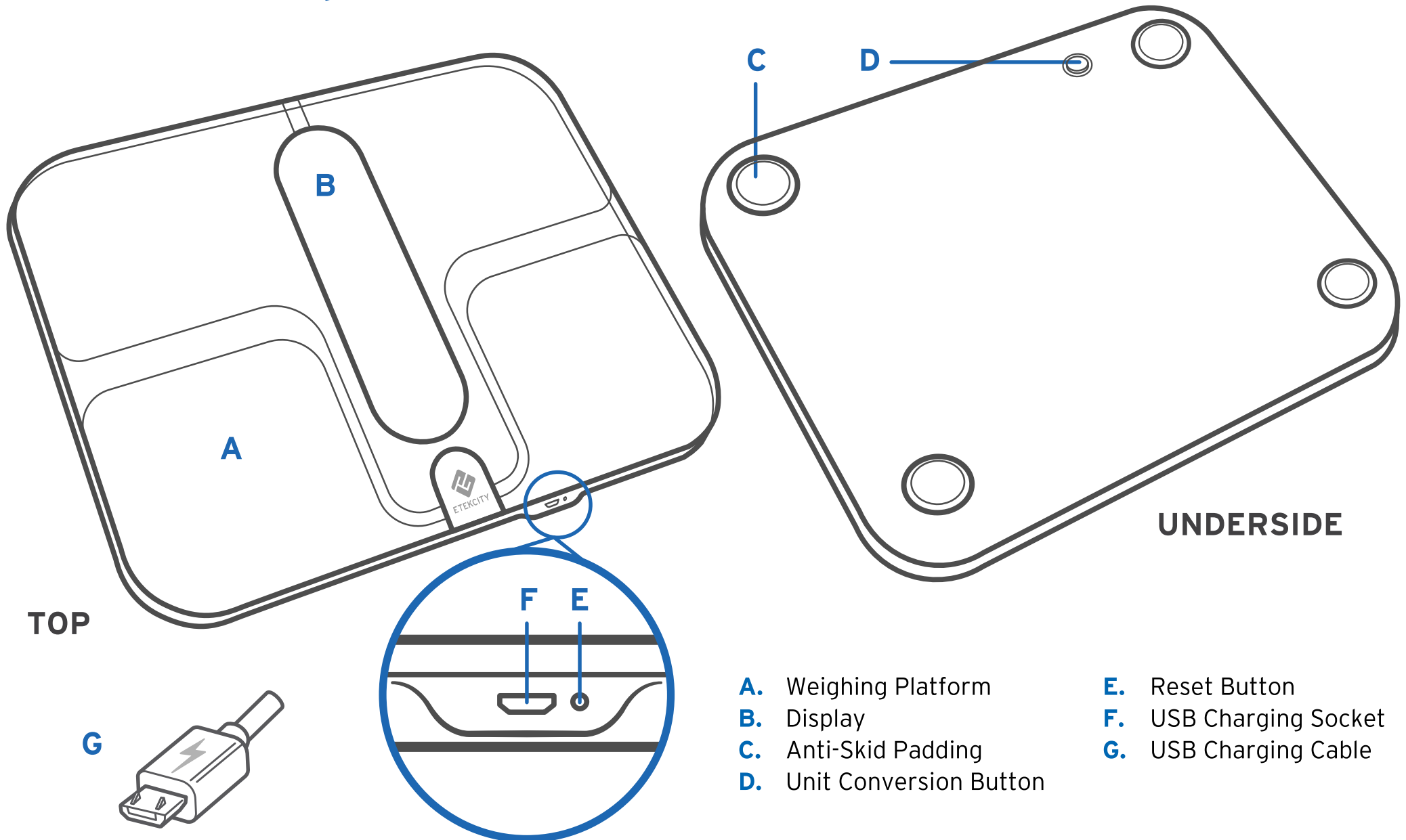

Digital Display

- A. WiFi Icon
- B. Bluetooth® Icon
- C. Battery Life Indicator
- D. Weight Units
- E. Weight Measurement
- F. Fat/Muscle/Water/Bone/BMR Measurement
- G. BMI Measurement
- H. BMI Tooltips

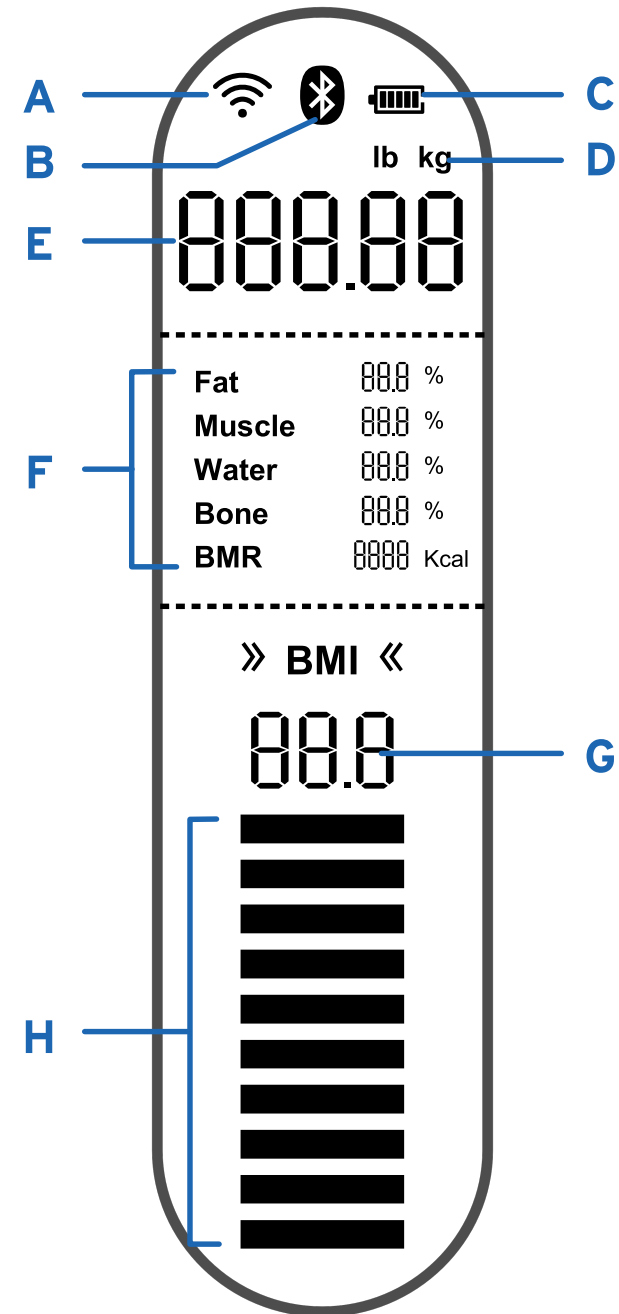

VeSync App Setup

Note: Due to app updates and improvements, the contents of this manual may change without notice. The VeSync app user interface may appear slightly different.

1. To download the VeSync app, scan the QR code, or search “VeSync” in the Apple App Store® or Google Play™ Store.



Note:

- This scale uses the VeSync app, not the VeSyncFit app.
- For Android users, you may need to select **Allow** to use VeSync.

2. Open the VeSync app. If you already have an account, tap **Log In**. To create a new account, tap **Sign Up**.



Using the Smart Scale

Note:

- To switch between pounds (lb), stone (st), and kilograms (kg), press the unit conversion button on the underside of the scale.
- If you are pregnant, scale measurements will not be accurate.

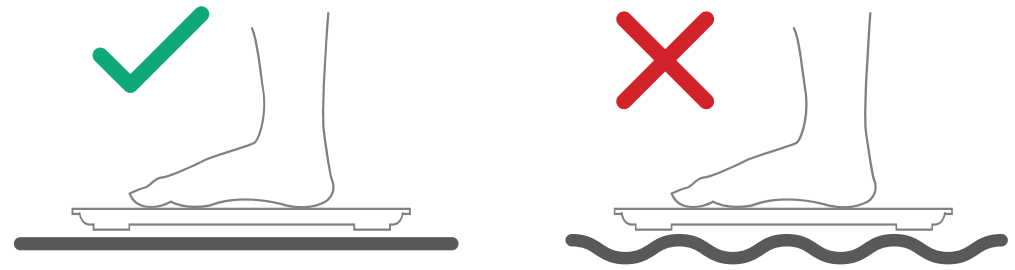

Figure 1.1

Weighing without the VeSync App

1. Place the scale on a hard, flat surface. [Figure 1.1]
2. Step onto the scale. The scale will automatically turn on and start measuring your weight.
3. Continue standing on the scale until the digits on the screen flash 3 times, showing your final measurement. [Figure 1.2]

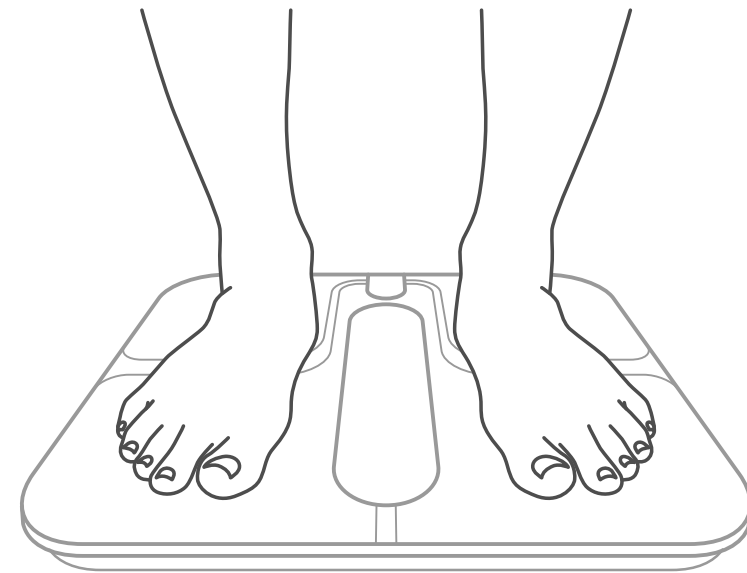
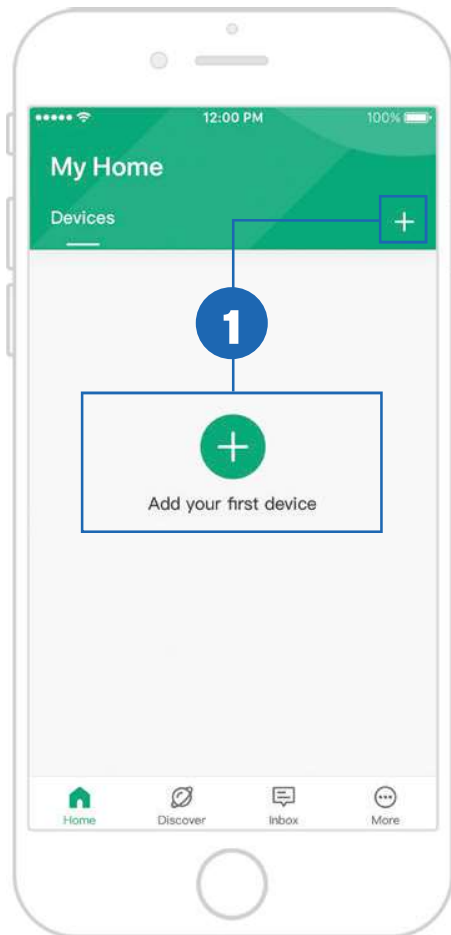

Figure 1.2

Weighing with the VeSync App

Pairing the Scale with VeSync

1. Tap .



2. Tap **Scales**.

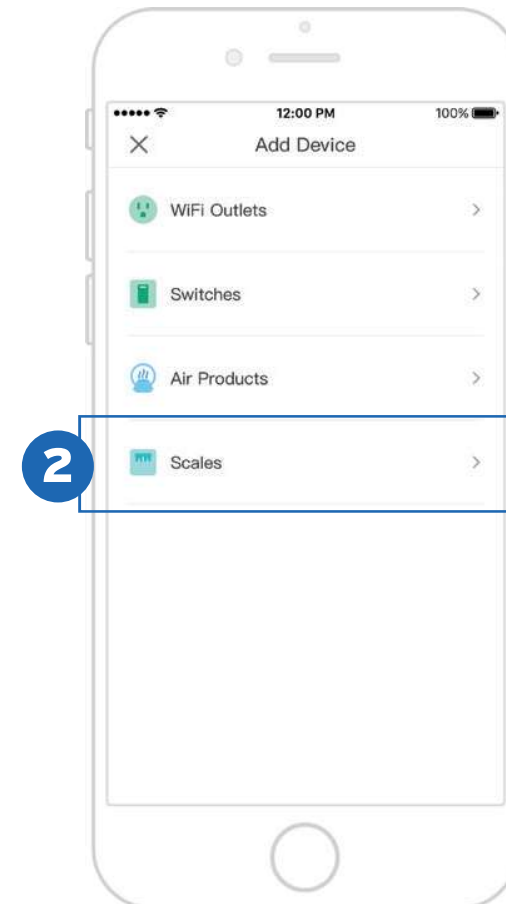

3. Select **Etekcity Fitness Scale** (ESF00+).

Note: Make sure your phone's Bluetooth® is turned on in your phone settings.

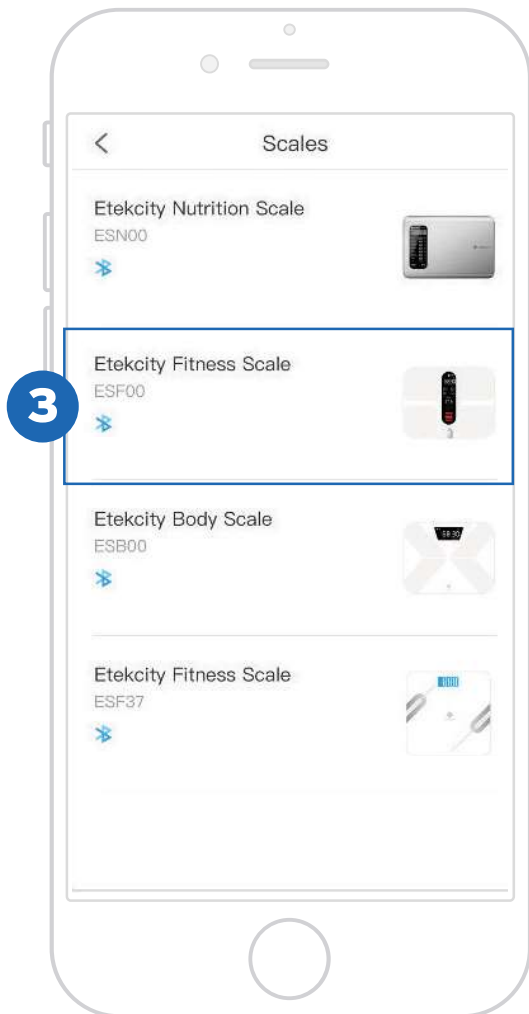

4. Stand on the scale and tap **Connect**.

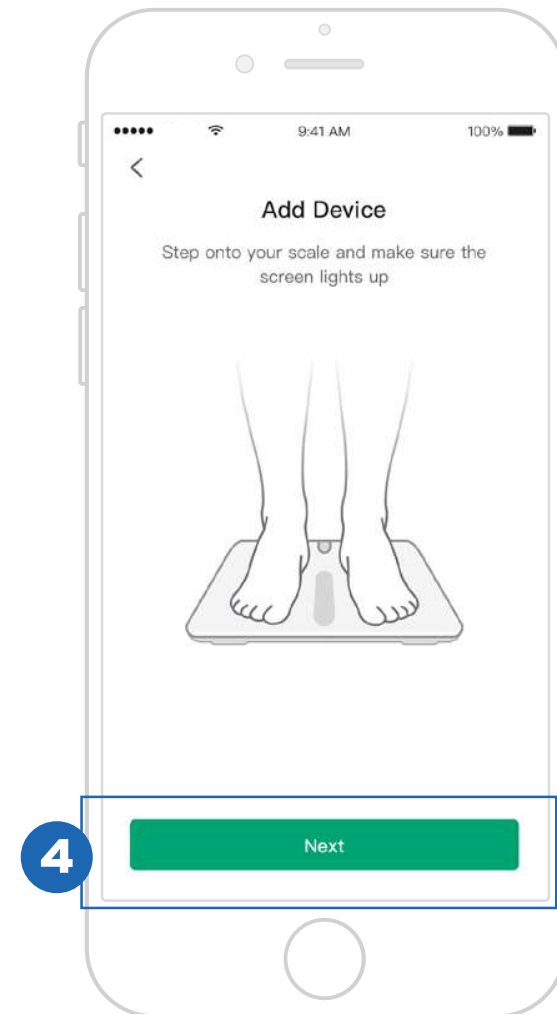

5. The app will take a moment to scan for devices. Tap **Etekcity Fitness Scale** to connect.

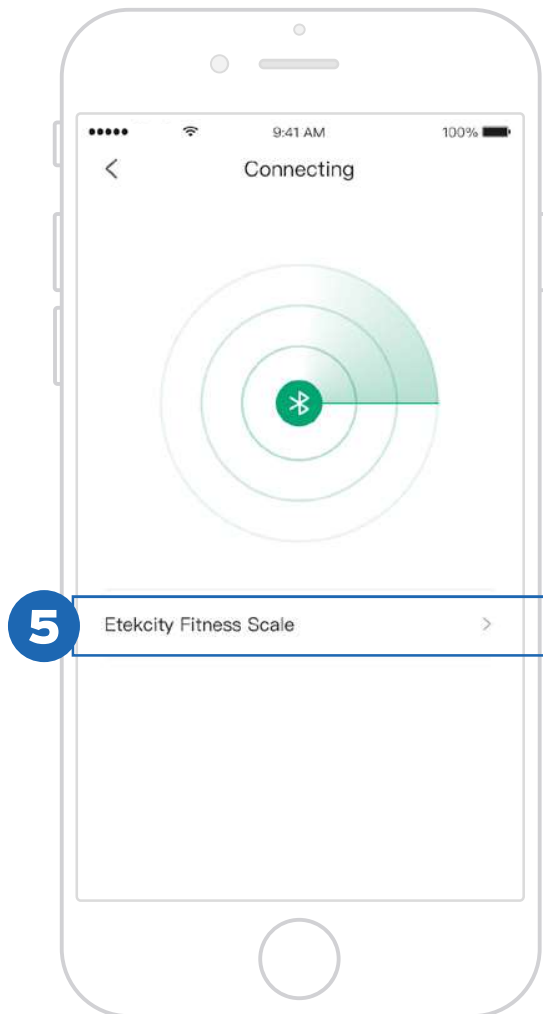

6. If the connection succeeded, go to step 9. If the connection failed, tap **Why couldn't I connect to my device?** at the bottom of the screen.

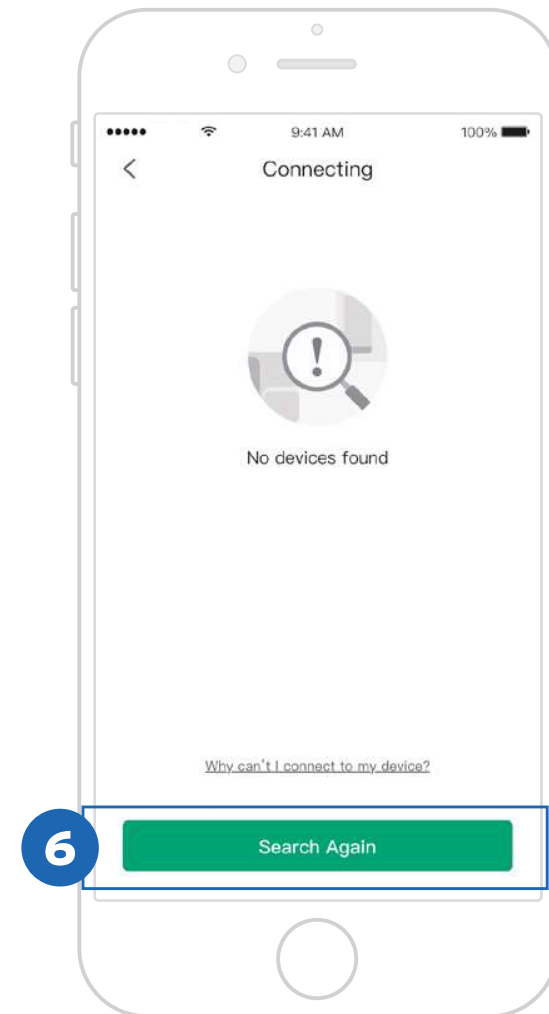

7. After following the “Troubleshooting” steps, tap < to return to the previous screen.

8. Then, tap **Search Again**.

9. Give your smart scale a unique name, or simply use the default name.

Note: You can change the name and picture at any time in “Device Settings”.

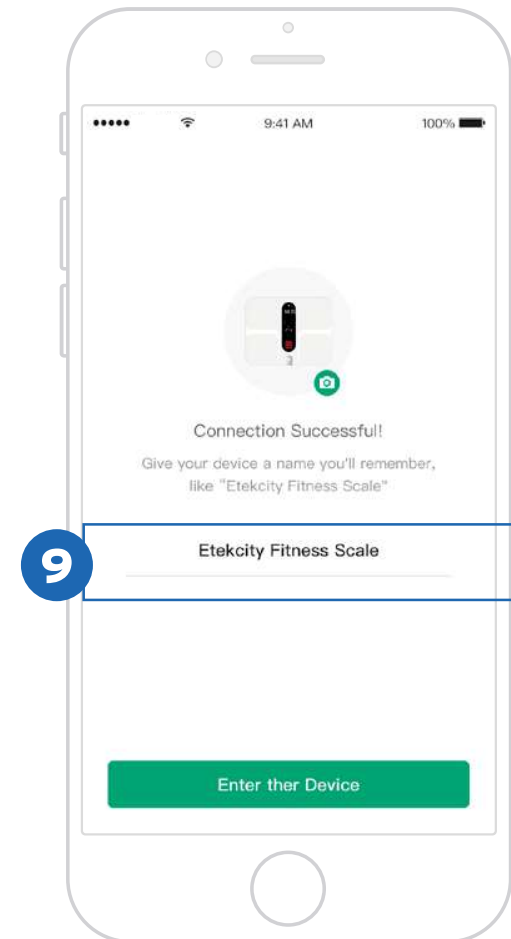
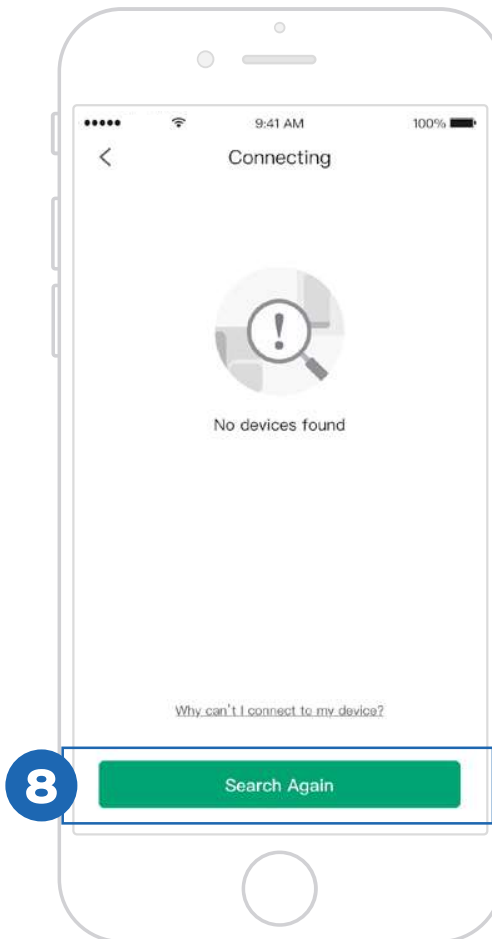
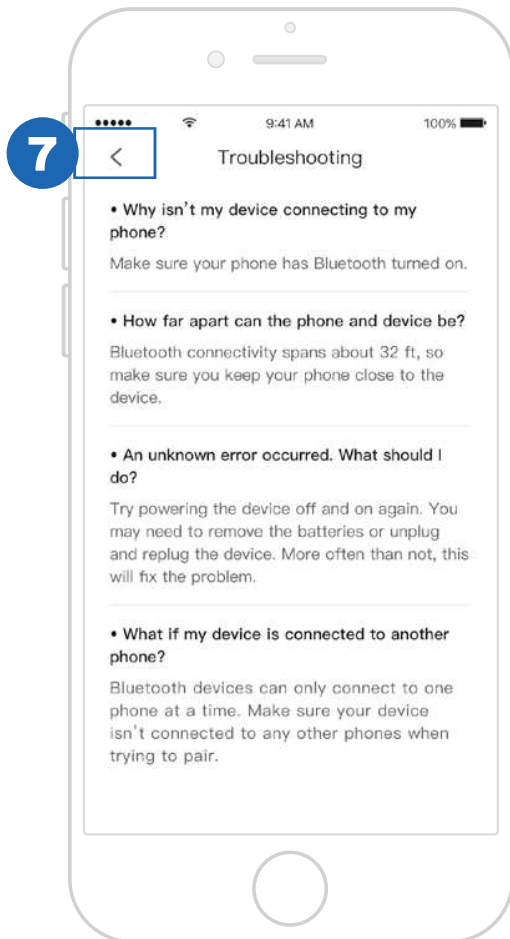

Connecting the Scale to WiFi

Optionally connect your scale to WiFi after setup. Connecting your scale to WiFi will allow you to view your data from anywhere, even when you're not at home or within Bluetooth range of your scale.

1. Connect your phone to a secure 2.4GHz WiFi network.

Note:

- *If the app fails to find your network, tap **Why can't I find my WiFi network?** to see possible reasons.*
- *If your SSID is set to hidden mode, tap **Manual WiFi Setup**, select your encryption method, and enter your SSID and password.*

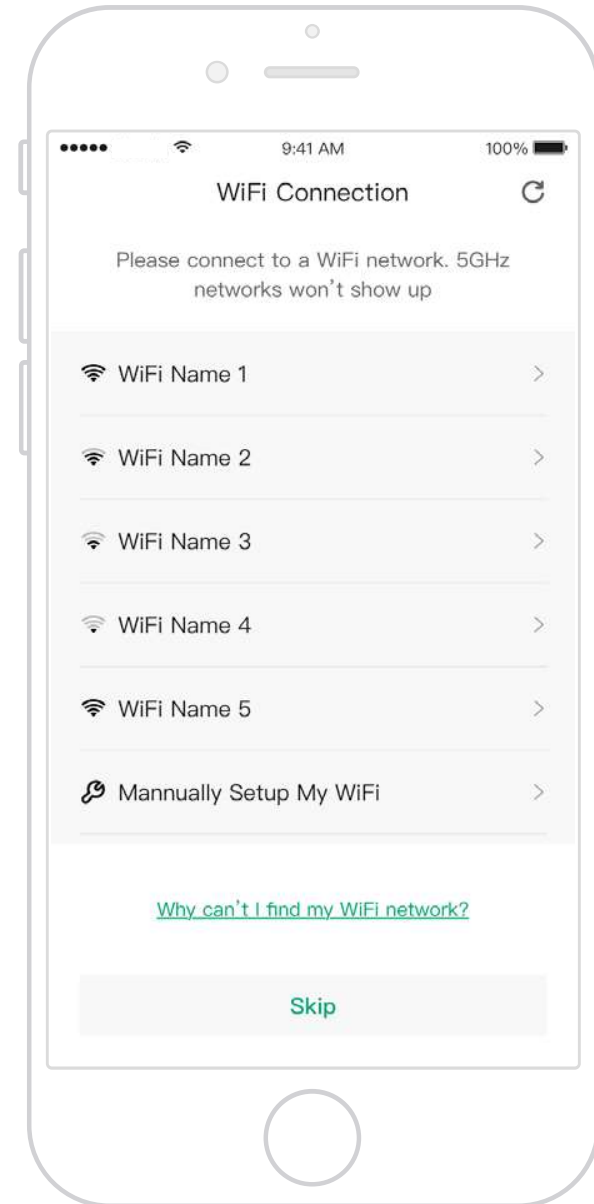

2. Enter your WiFi information and tap **Connect**.

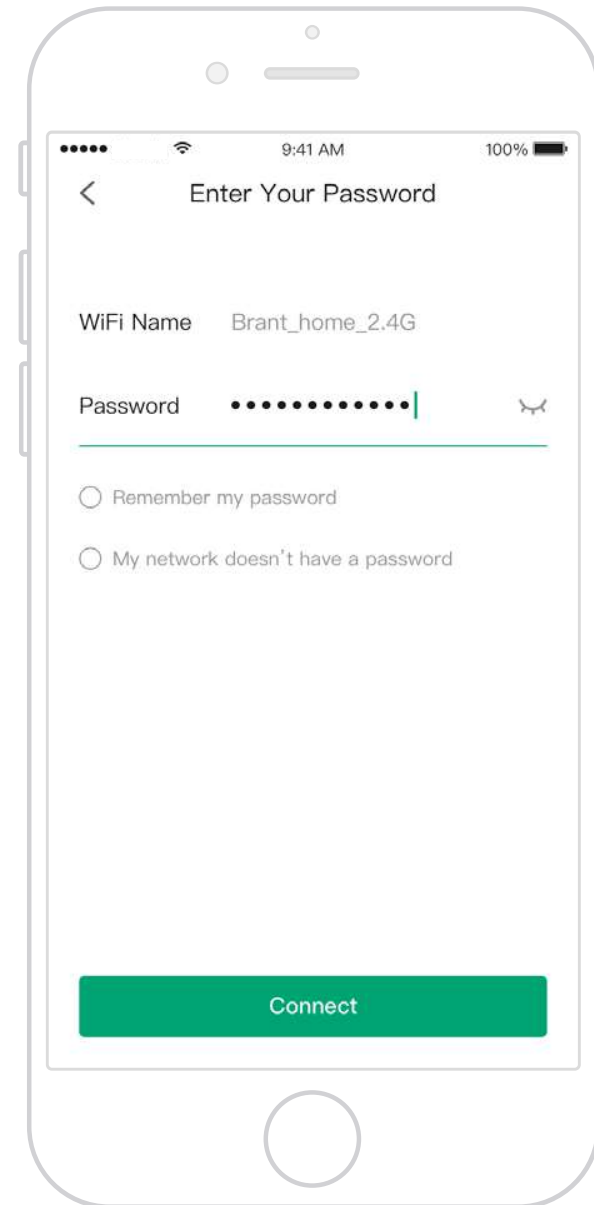

Using the App

Creating a User

If you are a new user, you will need to enter physical information before weighing yourself for the first time so the scale can calculate your body metrics.

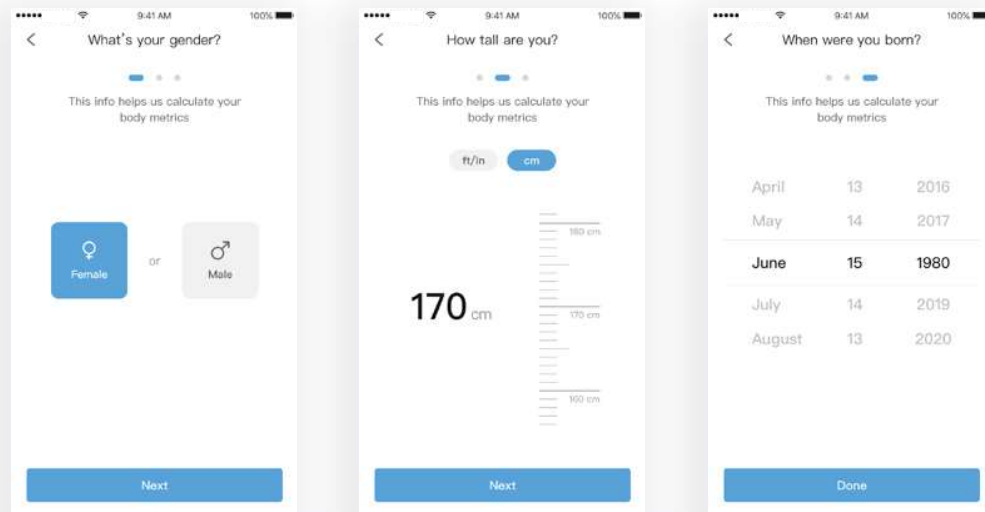

Note:

- *Entering inaccurate information will make the scale's measurements less accurate.*
- *If you don't identify with the available gender options, or are unsure, pick the choice that you think best physically matches you. This choice is used for physical measurements, such as body fat percentages.*

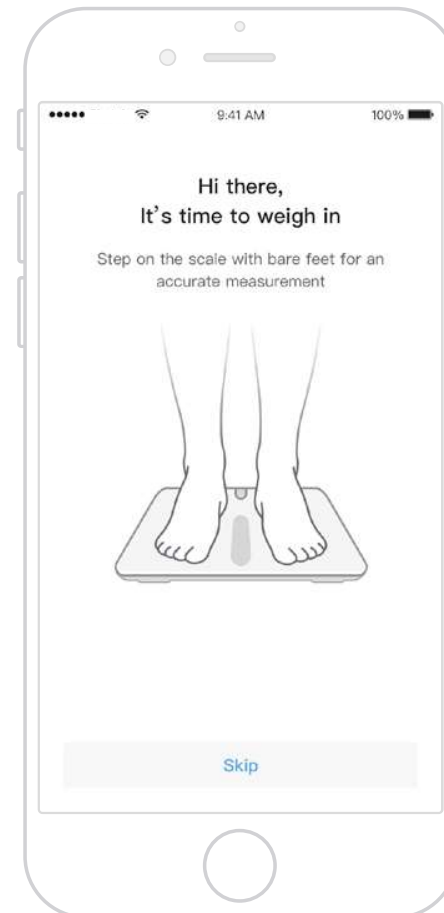

Weight Measurement

1. On the “My Home” screen, tap on the name of your smart scale.

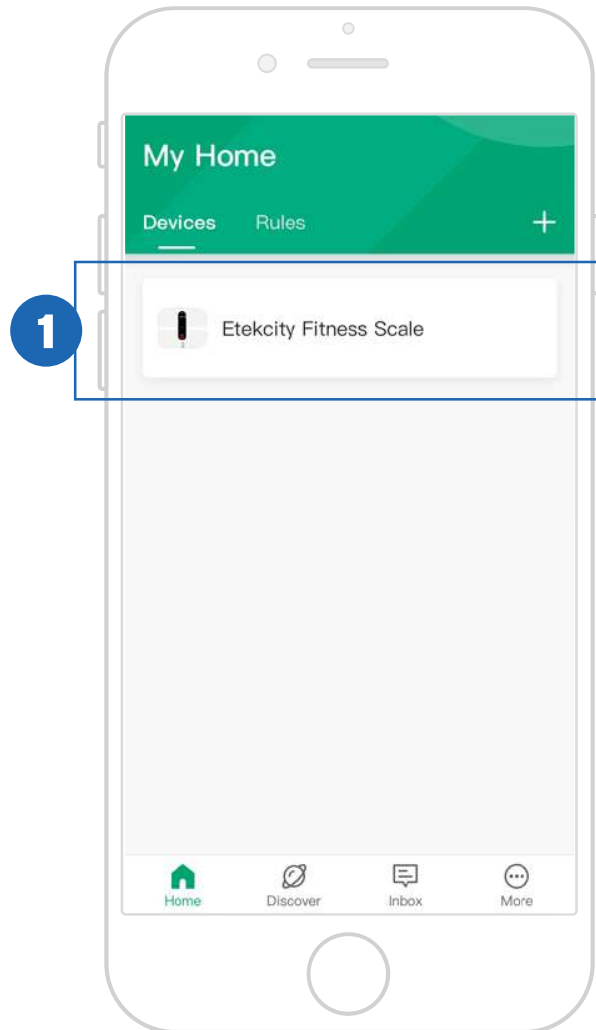

2. Step on the scale with bare feet. Continue standing on the scale for 5-10 seconds. Your measurements will appear in the VeSync app.

Note: *If you see a series of zeroes on the scale display, the scale is measuring your body fat and sending measurements to the VeSync app.*

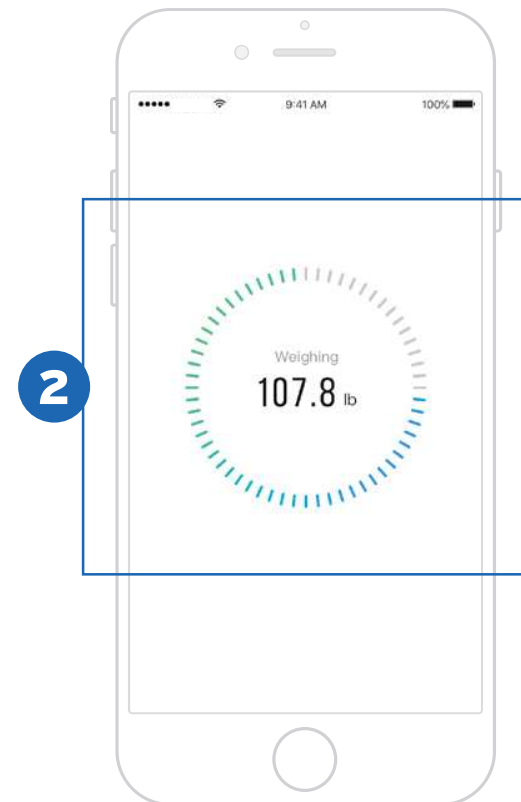

3. For further details, see:

- A. More Measurements (page 18)
- B. Data Graphs (page 19)
- C. Device Settings (page 21)

Note: *If you're wearing shoes or socks, the scale cannot measure health metrics such as body fat. Step on the scale with bare feet.*

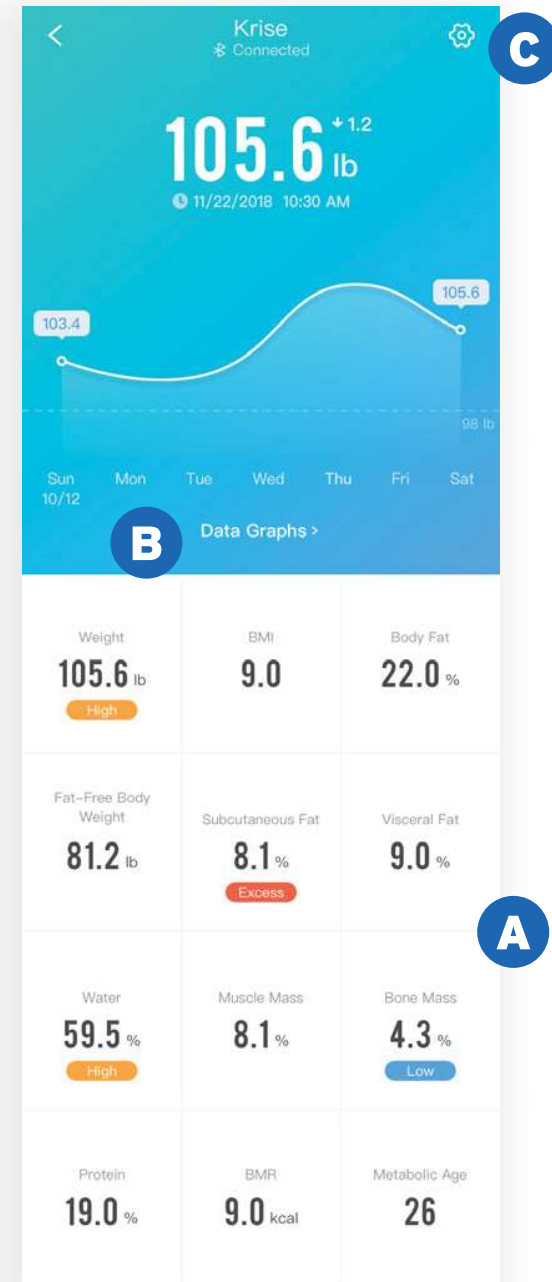

More Measurements

Scroll down for a comprehensive analysis of the 12 health metrics that the scale tracks. Tap on any of the health metrics for more information.

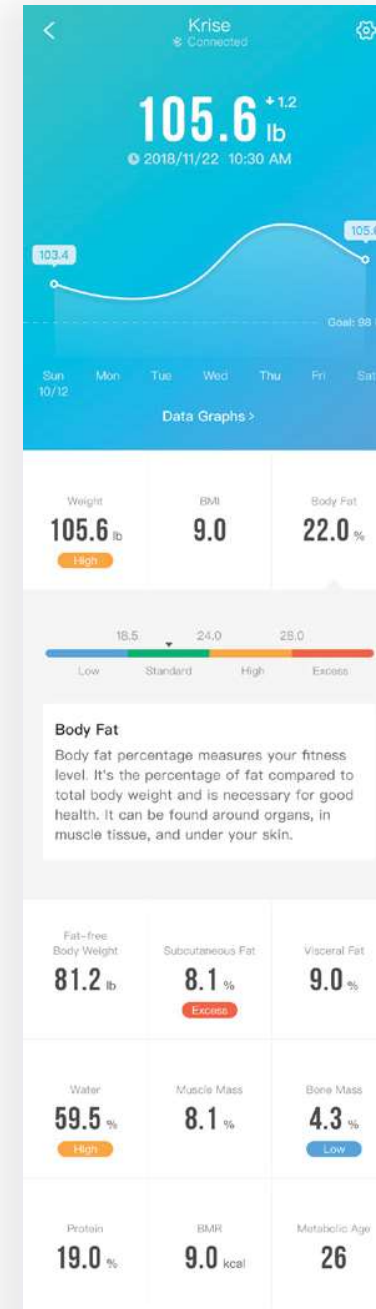

Data Graphs

1. Tap **Data Graphs**.

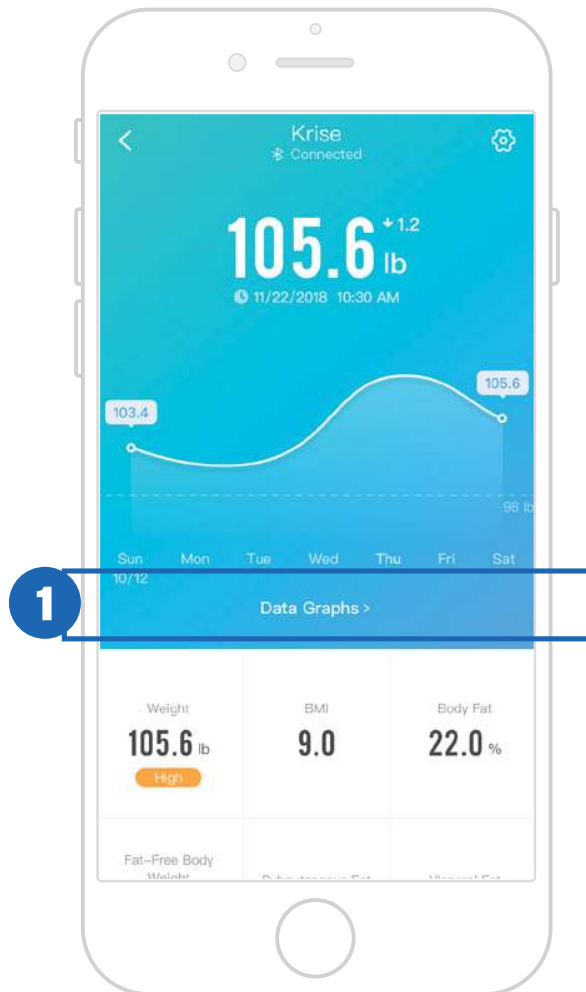

2. You can view daily, weekly, or monthly progress. Tap  to view your weighing history.

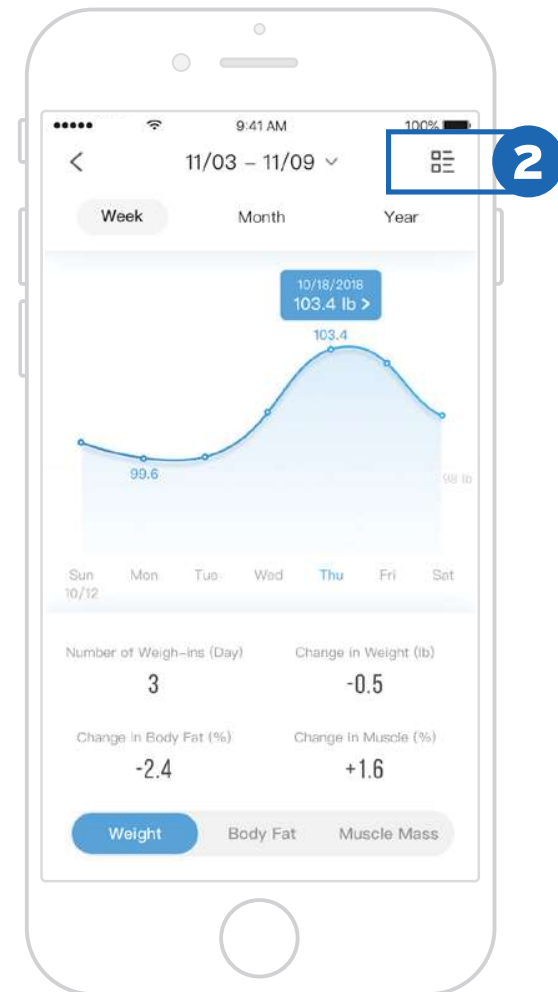

3. Tap on any entry to see more information.

Note: To delete, swipe left on an entry.

4. View the 12 health metrics that the scale tracks. Tap on any of the health metrics for more information.

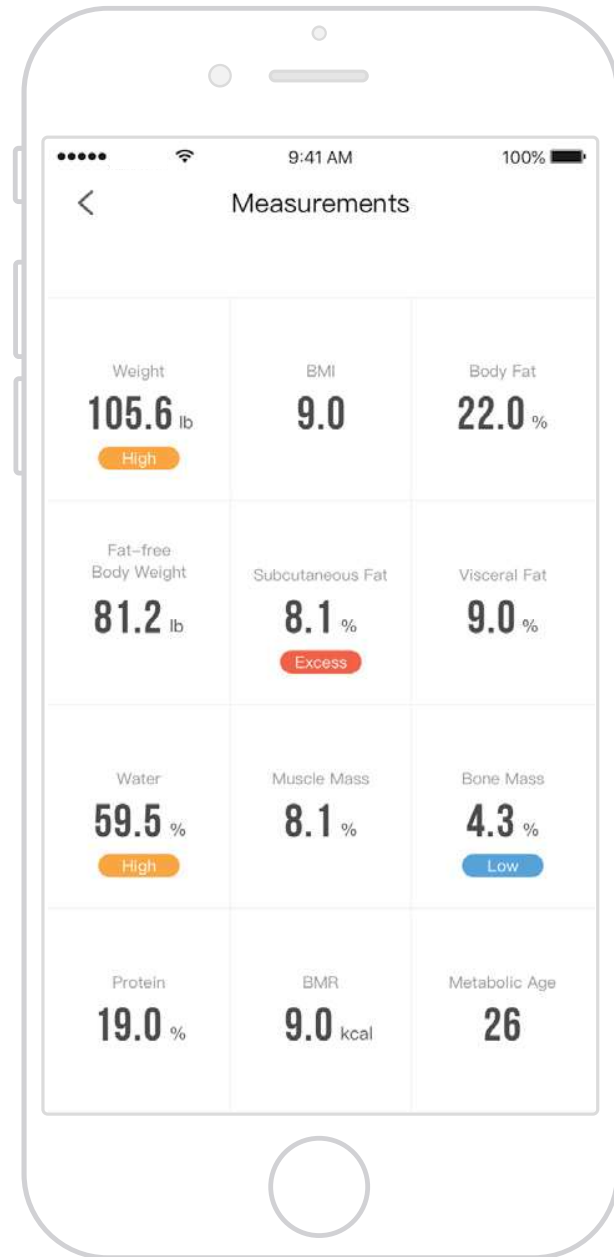

Device Settings

Tap  in the upper right corner to see Device Settings.

- Tap on any setting to change it.
- Tapping on your user icon will allow you to edit your information.
- If you skipped setting up your WiFi connection, tap **WiFi Connection** to set it up at any time.
- When you change the weight unit in the app, the smart scale will change to match.

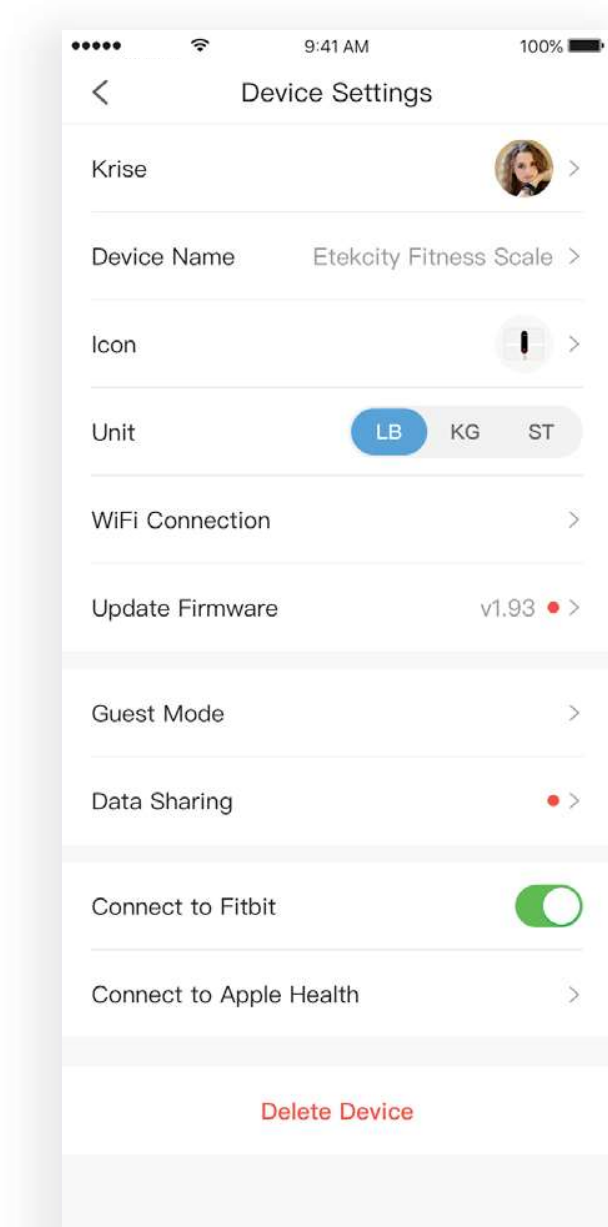

Guest Mode

Choose physical settings for a guest using the smart scale.

Note: *Guest Mode measurement data will not be saved.*

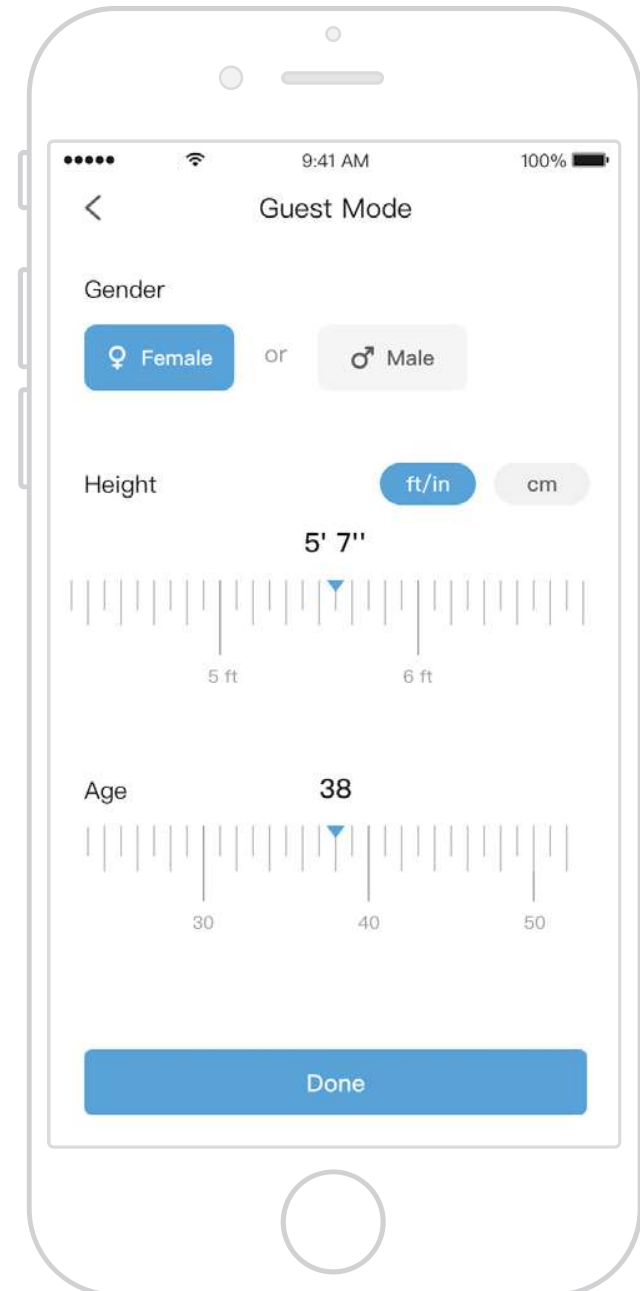

Data Sharing

You can share your measurement data with your friends.

Note: *Guest Mode measurement data will not be saved.*

1. Tap **Add Friends**.
2. Enter your friend's email address to send a request.

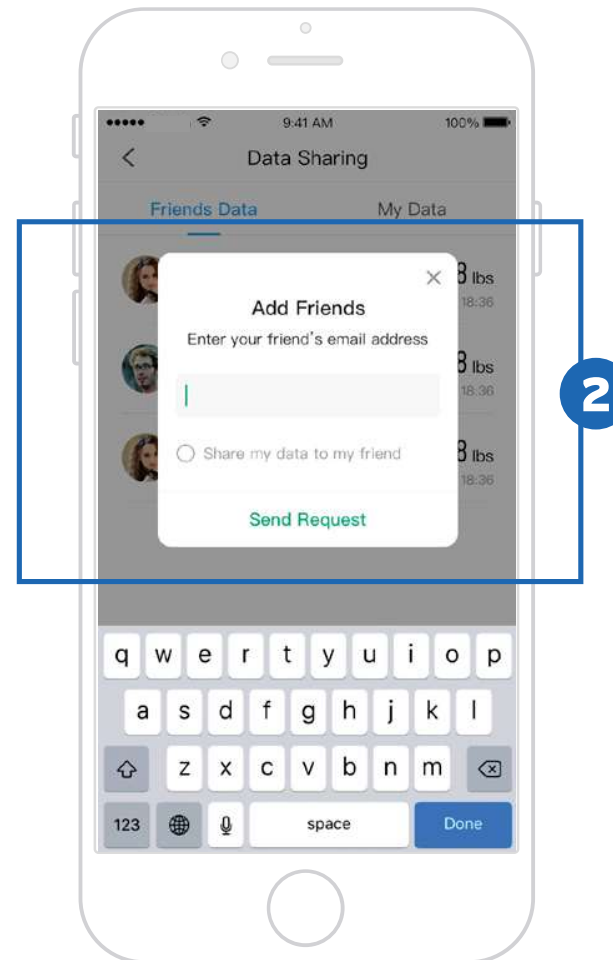
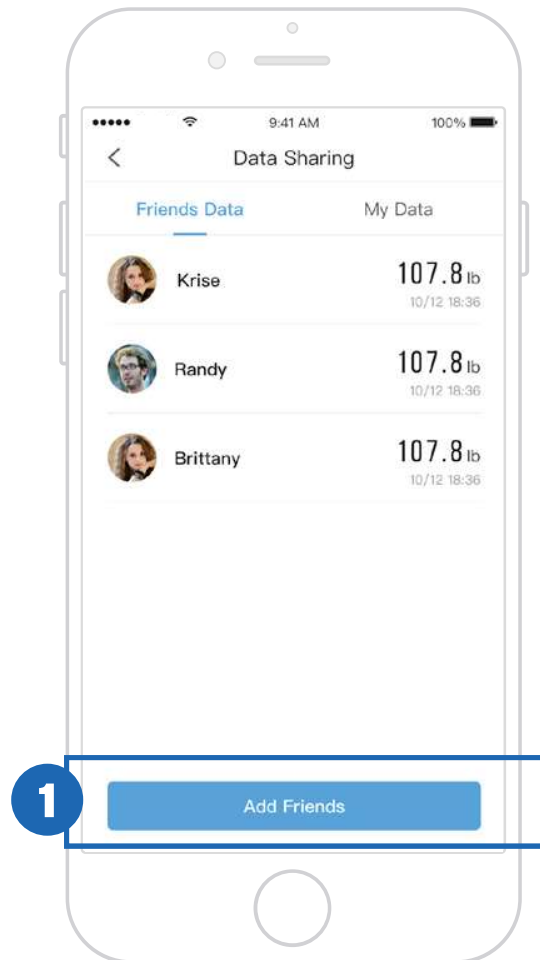

3. Tap your friend's name to see their measurement data.
4. Tap **My Data** to see who you're sharing your information with.

5. If someone sends you a friend request on VeSync, it will appear in your VeSync inbox.
6. Tap on the message to view the friend request and respond.

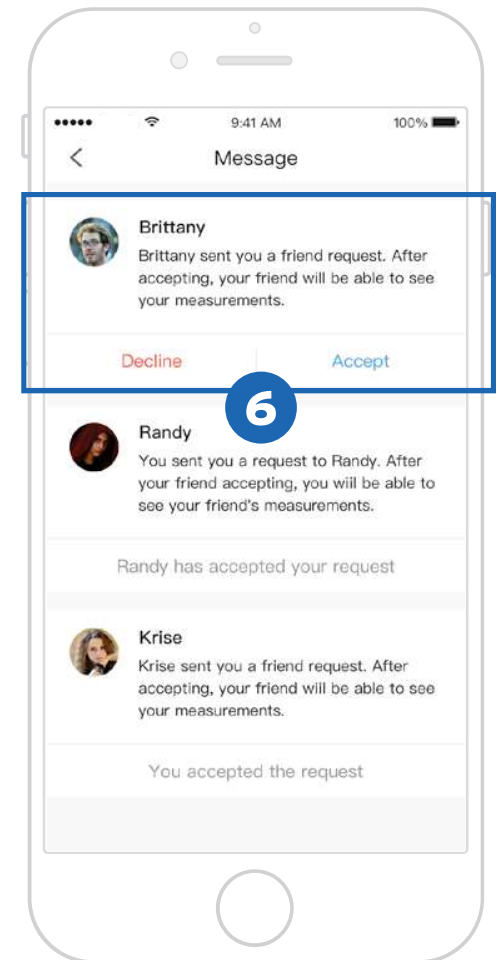
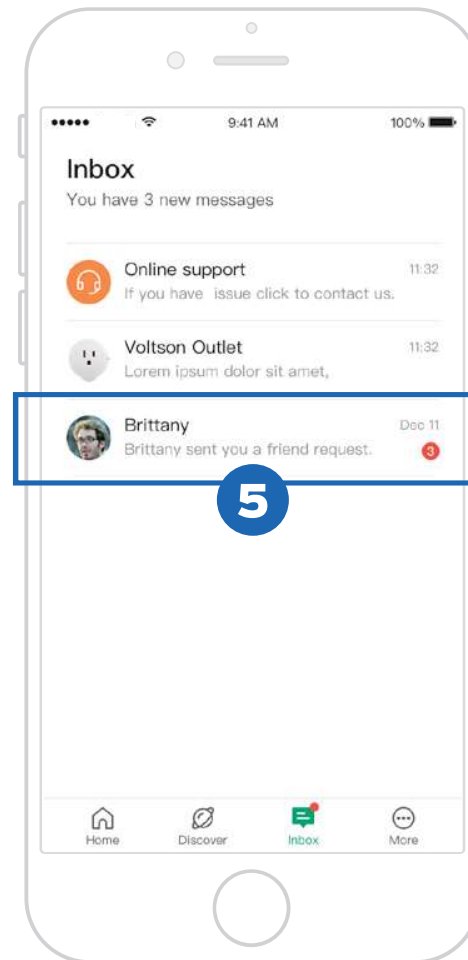
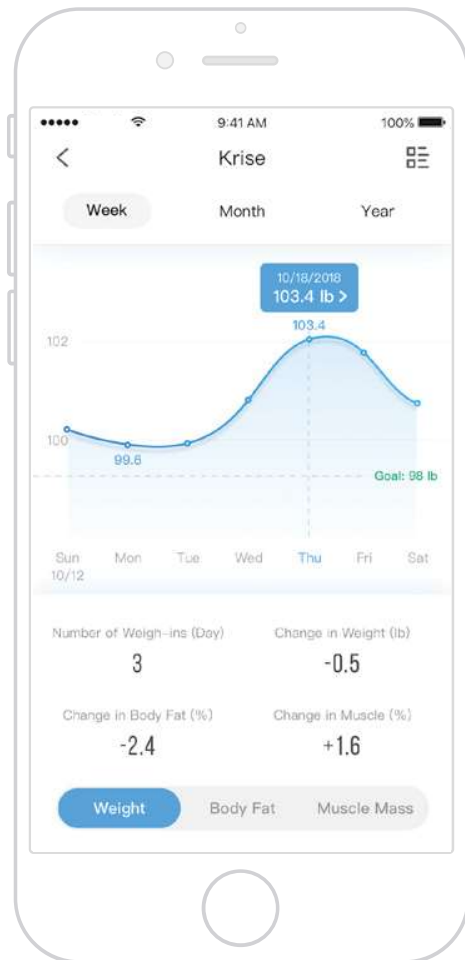
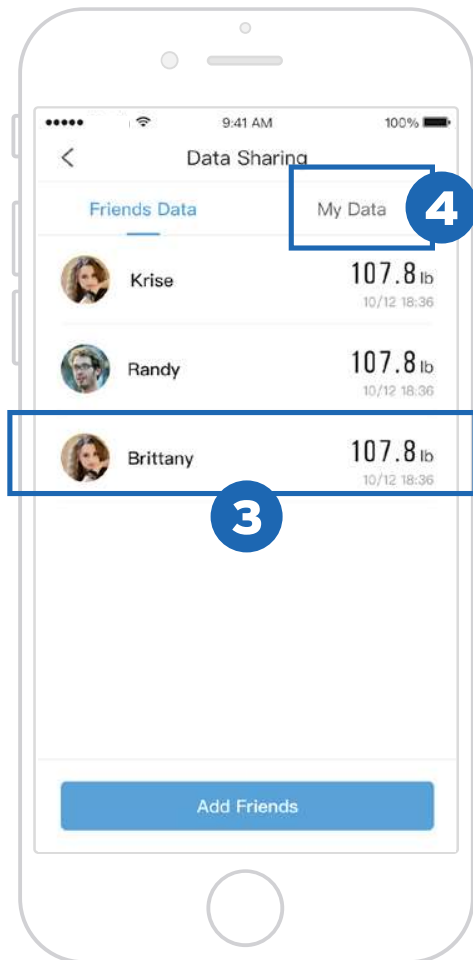

Maintenance

Recalibrating the Scale

If the scale has been moved or flipped upside down, it must be recalibrated to ensure accurate results.

1. Place the scale on a hard, flat surface.
2. Step on the scale with one foot until digits appear on the display. [Figure 3.1] Then, step off.
3. The scale will show “ [” while calibrating, then “ 000 ” when complete. [Figure 3.2]

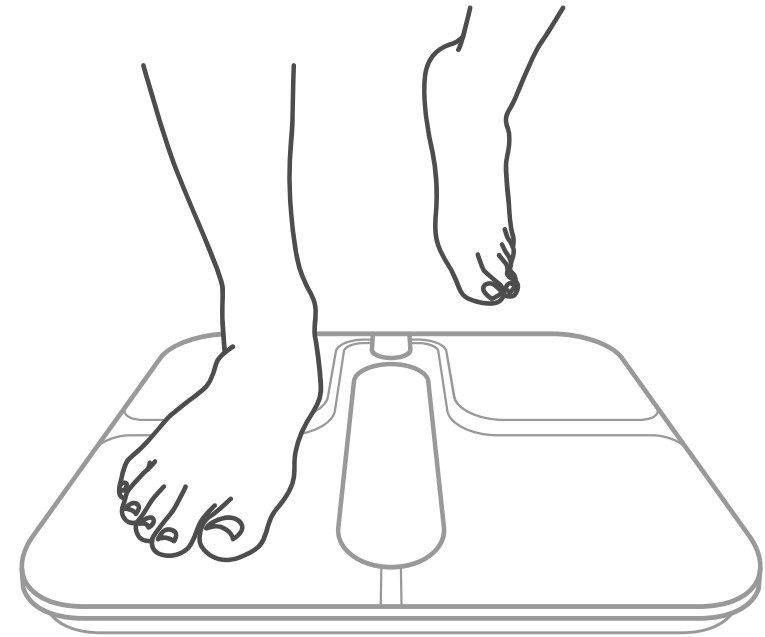

Figure 3.1

Cleaning the Scale

- Use a slightly damp cloth to clean the surface of the scale, followed by a soft, dry cloth to wipe away any remaining moisture.
- **Do not** use chemical or abrasive cleaning agents to clean the scale.

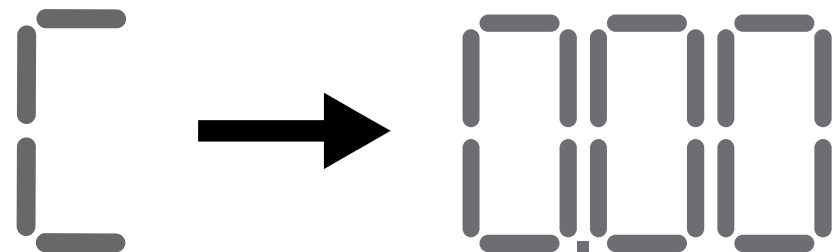



Figure 3.2

Charging the Battery

The display will show “” when the battery needs to be charged.

1. Insert the USB charging cable into the USB charging socket. [\[Figure 4.1\]](#)

2. Plug the USB charging cable into a DC 5V adapter and plug into an outlet. You can also plug the cable into a powered USB outlet. [\[Figure 4.1\]](#)

3. The bars in the battery symbol () will continuously fill as the scale charges. When charged, the symbol will be filled.

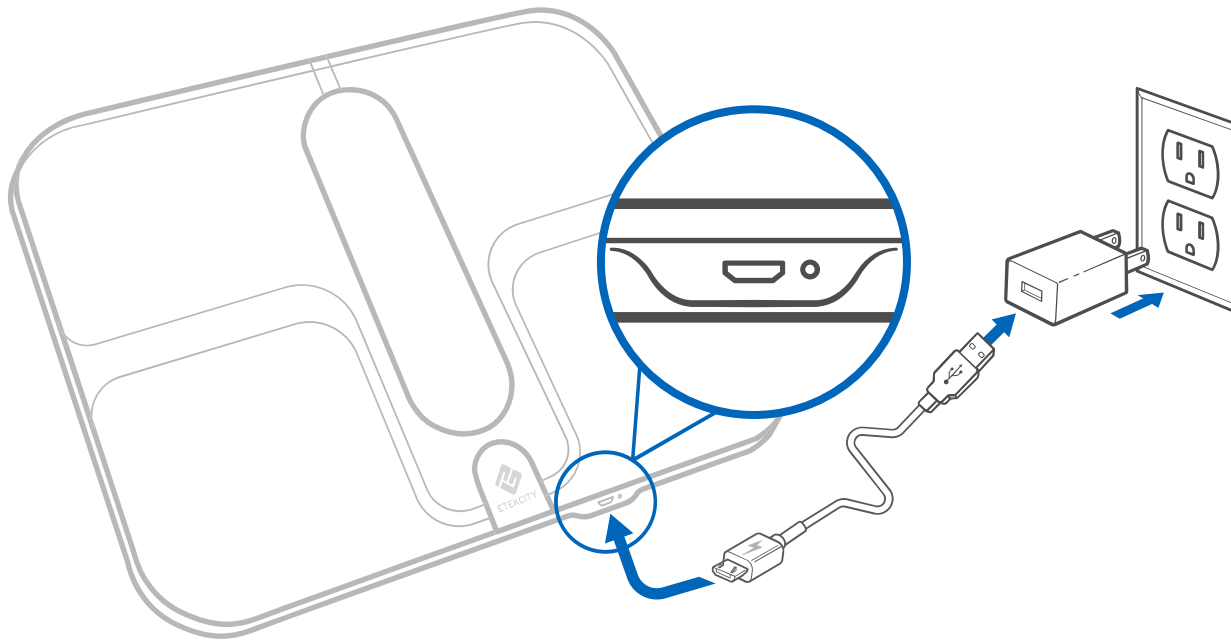





Figure 4.1

Display Messages

 lb kg 888.88 Bluetooth Connection	lb kg 888.88 No Connection
--	----------------------------------

 lb kg 888.88 WiFi Connection	WiFi Icon Flashes  lb kg 888.88 WiFi Connection in Progress
---	--

Lo Change Battery	Err Overload	[Calibrating
----------------------	-----------------	------------------

Troubleshooting

1. The scale doesn't turn on.

- The scale may need to be charged. Plug it in and charge for 3 hours.

2. Nothing happens when I press the unit button.

- The scale may need to be reset. Use a safety pin or paper clip to press the "Reset" button on the underside of the scale.

3. Information flashes on the screen and then disappears.

- The battery is low and may need to be charged.

4. The scale doesn't connect with the VeSync app.

- Make sure your phone's operating system is running on iOS 8.0+ or Android 4.3+.
- Close and relaunch the VeSync app. Make sure you're using the latest version.
- Turn on Bluetooth on your phone (for Android users, make sure your Location is turned on as well).
- Make sure your scale and phone are within 30 ft / 10 m of each other.
- Make sure the scale is not currently connected to any other phone or app.
- Try turning off any VPN apps.
- The scale may need to be reset. Use a safety pin or paper clip to press the "Reset" button on the underside of the scale.

5. My scale will only measure my weight, or only my weight and BMI.

- Set up your smart scale in the VeSync app. Your BMI, Fat, Muscle, Water, Bone, and BMR measurements will show on the display, and more results will show on the app.
- Make sure Bluetooth is turned on.
- If you're wearing shoes or socks, the scale cannot measure health metrics such as body fat. Step on the scale with bare feet. [Figure 5.1]

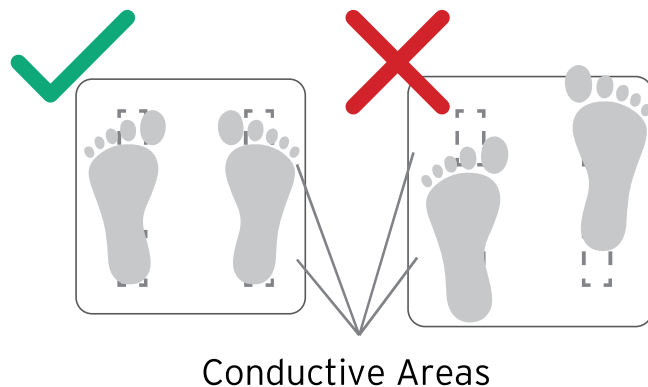

Figure 5.1

Note: Resetting the scale will fix many issues.

- A. To clear user data from the scale, press and hold the unit button on the underside of the scale for 10 seconds.
- B. To hard reset the scale, use a safety pin or paper clip to press the "Reset" button on the underside of the scale.

If you still need help, please contact **Customer Support** (see page 33).

FCC Statement to the User

This device complies with Part 15 of the FCC Rules. Operation is subject to the following two conditions:

1. This device may not cause harmful interference, and
2. This device must accept any interference received, including interference that may cause undesired operation.

Any changes or modifications not expressly approved by the party responsible for compliance could void the user's authority to operate this equipment.

This equipment has been tested and found to comply with the limits for a Class B digital device, pursuant to Part 15 of the FCC Rules. These limits are designed to provide reasonable protection against harmful interference in a residential installation. This equipment generates, uses and can radiate radio frequency energy and, if not installed and used in accordance with the instructions, may cause harmful interference to radio communications. However, there is no guarantee that interference will not occur in a particular installation. If this equipment does cause harmful interference to radio or television reception, which can be determined by turning the equipment off and on, the user is encouraged to try to correct the interference by one of the following measures:

- Reorient or relocate the receiving antenna.
- Connect the equipment into an outlet on a circuit different from that to which the receiver is connected.
- Increase the separation between the equipment and receiver.
- Consult the dealer or an experienced radio/TV technician for help.

FCC Radiation Exposure Statement

This equipment complies with FCC radiation exposure limits set forth for an uncontrolled environment. End users must follow the specific operating instructions for satisfying RF exposure compliance. To maintain compliance with FCC RF exposure compliance requirements, please follow operation instructions as documented in this manual. This transmitter must not be co-located or operating in conjunction with any other antenna or transmitter. This equipment should be installed and operated with a minimum distance of 20cm between the radiator and your body. The availability of some specific channels and/or operational frequency bands are country dependent and are firmware programmed at the factory to match the intended destination. The firmware setting is not accessible by the end user.

Warranty Information

Product Name	Smart Fitness Scale
Model Number	ESF00+
Default Warranty Period	1 year
<i>For your own reference, we strongly recommend that you record your order ID and date of purchase.</i>	
Order ID	
Date of Purchase	

Terms & Policy

Etekcitey Corporation warrants all products to be of the highest quality in material, craftsmanship, and service, effective from the date of purchase to the end of the warranty period.

Etekcitey Corporation will replace any product found to be defective due to manufacturer flaws based on eligibility. Refunds are available within the first 30 days of purchase. Refunds are only available to the original purchaser of the product. This warranty extends only to personal use and does not extend to any product that has been used for commercial, rental, or any other use in which the product is not intended for. There are no warranties other than the warranties expressly set forth with each product.

This warranty is non-transferrable. Etekcitey Corporation is not responsible in any way for any damages, losses, or inconveniences caused by equipment failure or by user negligence, abuse, or use noncompliant with the user manual or any additional safety or use warnings included in the product packaging and manual.

This warranty does not apply to the following:

- Damage due to abuse, accident, alteration, misuse, tampering, or vandalism.
- Improper or inadequate maintenance.
- Damage in return transit.
- Unsupervised use by children under 18 years of age.

Etekcitey Corporation and its subsidiaries assume no liability for damage caused by the use of the product other than for its intended use or as instructed in the user manual. Some states do not allow this exclusion or limitation of incidental or consequential losses so the foregoing disclaimer may not apply to you. This warranty gives you specific legal rights and you may also have other rights which may vary from state to state.

ALL EXPRESSED AND IMPLIED WARRANTIES, INCLUDING THE WARRANTY OF MERCHANTABILITY, ARE LIMITED TO THE PERIOD OF THE LIMITED WARRANTY.

Additional 1-Year Warranty

You can extend your 1-year warranty by an additional year. Log onto www.etekcity.com/warranty to register your new product for the extended warranty.

Please fill out all required fields and include your order ID, place of purchase, and purchase date, if applicable.

Defective Products & Returns

If you discover your product is defective within the specified warranty period, please contact Customer Support via support@etekcity.com with a copy of your invoice and order ID. DO NOT dispose of your product before contacting us. Once our Customer Support Team has approved your request, please return the product with a copy of the invoice and order ID.

Customer Support

If you encounter any issues or have any questions about your new product, please contact our helpful Customer Support Team. Your satisfaction is our goal!

Customer Support

Etekcite Corporation

1202 N. Miller St., Suite A
Anaheim, CA 92806

Email: support@etekcity.com

Toll-Free: (855) 686-3835

Support Hours

Monday–Friday

9:00 am–5:00 pm PST/PDT

**Please have your invoice and order ID ready before contacting Customer Support.*



Connect with us @Etekcitiy



JD0419AL-M1_0419ESF00+