



FCC 47 CFR PART 15 SUBPART C
CERTIFICATION TEST REPORT

For

Solar Powered Trailer and Assert Tracker

MODEL NUMBER: TT601-LM0Q-GL

FCC ID: 2AP3P2018TT600

REPORT NUMBER: 4788458567-1

ISSUE DATE: June 14, 2018

Prepared for

Flex Industrial, Ltd.

Level 3, Alexander House, 35 Cybercity, Ebene, Mauritius

Prepared by

UL Verification Services (Guangzhou) Co., Ltd, Song Shan Lake Branch

Room 101, Building 10, Innovation Technology Park,

Song Shan Lake Hi tech Development Zone, Dongguan, 523808, China

Tel: +86 769 33817100

Fax: +86 769 33244054

Website: www.ul.com

Revision History

The results reported herein have been performed in accordance with the laboratory's terms of accreditation. This report shall not be reproduced except in full without the written approval of the Laboratory. The results in this report apply to the test sample(s) mentioned above at the time of the testing period only and are not to be used to indicate applicability to other similar products. This report does not imply that the product(s) has met the criteria for certification.



Rev.	Issue Date	Revisions	Revised By
--	06/14/2018	Initial Issue	



Summary of Test Results			
Clause	Test Items	FCC Rules	Test Results
1	6dB Bandwidth and 99% Bandwidth	FCC 15.247 (a) (2)	PASS
2	Peak Conducted Output Power	FCC 15.247 (b) (3)	PASS
3	Power Spectral Density	FCC 15.247 (e)	PASS
4	Conducted Bandedge and Spurious Emission	FCC 15.247 (d)	PASS
5	Radiated Bandedge and Spurious Emission	FCC 15.247 (d) FCC 15.209 FCC 15.205	PASS
6	Conducted Emission Test For AC Power Port	FCC 15.207	N/A
7	Antenna Requirement	FCC 15.203	PASS



TABLE OF CONTENTS

1. ATTESTATION OF TEST RESULTS	6
2. TEST METHODOLOGY	8
3. FACILITIES AND ACCREDITATION	8
4. CALIBRATION AND UNCERTAINTY	9
4.1. <i>MEASURING INSTRUMENT CALIBRATION</i>	<i>9</i>
4.2. <i>MEASUREMENT UNCERTAINTY.....</i>	<i>9</i>
5. EQUIPMENT UNDER TEST	10
5.1. <i>DESCRIPTION OF EUT</i>	<i>10</i>
5.2. <i>MAXIMUM OUTPUT POWER.....</i>	<i>10</i>
5.3. <i>CHANNEL LIST.....</i>	<i>11</i>
5.4. <i>TEST CHANNEL CONFIGURATION.....</i>	<i>11</i>
5.5. <i>THE WORSE CASE POWER SETTING PARAMETER.....</i>	<i>11</i>
5.6. <i>DESCRIPTION OF AVAILABLE ANTENNAS</i>	<i>11</i>
5.7. <i>TEST ENVIRONMENT</i>	<i>12</i>
5.8. <i>DESCRIPTION OF TEST SETUP.....</i>	<i>13</i>
5.9. <i>MEASURING INSTRUMENT AND SOFTWARE USED.....</i>	<i>14</i>
6. MEASUREMENT METHODS	15
7. ANTENNA PORT TEST RESULTS	16
7.1. <i>ON TIME AND DUTY CYCLE.....</i>	<i>16</i>
7.2. <i>99% & 6 dB DTS BANDWIDTH</i>	<i>17</i>
7.3. <i>PEAK CONDUCTED OUTPUT POWER.....</i>	<i>22</i>
7.4. <i>POWER SPECTRAL DENSITY</i>	<i>23</i>
7.5. <i>CONDUCTED BANDEDGE AND SPURIOUS EMISSIONS.....</i>	<i>26</i>
8. RADIATED TEST RESULTS.....	30
8.1. <i>RESTRICTED BANDEDGE.....</i>	<i>35</i>
8.2. <i>SPURIOUS EMISSIONS (1~18GHz).....</i>	<i>43</i>
8.3. <i>SPURIOUS EMISSIONS 18G ~ 26GHz.....</i>	<i>55</i>
8.4. <i>SPURIOUS EMISSIONS 30M ~ 1 GHz</i>	<i>57</i>
8.5. <i>SPURIOUS EMISSIONS BELOW 30M.....</i>	<i>59</i>
9. AC POWER LINE CONDUCTED EMISSIONS.....	63



10. ANTENNA REQUIREMENTS65



1. ATTESTATION OF TEST RESULTS

Applicant Information

Company Name: Flex Industrial, Ltd.
 Address: Level 3, Alexander House, 35 Cybercity, Ebene, Mauritius

Manufacturer Information

Company Name: Flex Industrial, Ltd.
 Address: Level 3, Alexander House, 35 Cybercity, Ebene, Mauritius

Factory Information

Company Name: Flextronics Technology (Nanjing) Co., Ltd
 Address: No.99 Zhuang Pai Rd.,Jiangning Development Zone, Nanjing, Jiangsu, China · 211100

EUT Description

EUT Name: Solar Powered Trailer and Assert Tracker
 Model: TT601-LM0Q-GL
 Series Model: TT600-LM0Q-GL/TT603-LM0Q-GL
 Model Different: Please refer to page 10 description of EUT
 Brand Name: /
 Sample Status: Normal
 Sample Received Date: June 04, 2018
 Date of Tested: June 05, 2018 ~ June 11, 2018

APPLICABLE STANDARDS	
STANDARD	TEST RESULTS
FCC Part 15 Subpart C	PASS



Tested By:

Denny Huang
Engineer Project Associate

Checked By:

Shawn Wen
Laboratory Leader

Approved By:

Stephen Guo
Laboratory Manager



2. TEST METHODOLOGY

The tests documented in this report were performed in accordance with KDB414788 D01 Radiated Test Site v01, ANSI C63.10-2013, 558074 D01 DTS Meas Guidance v04, FCC CFR 47 Part 2, FCC CFR 47 Part 15.

3. FACILITIES AND ACCREDITATION

Accreditation Certificate	<p>A2LA (Certificate No.: 4102.01) UL Verification Services (Guangzhou) Co., Ltd. Song Shan Lake Branch. has been assessed and proved to be in compliance with A2LA.</p> <p>IAS (Lab Code: TL-702) UL Verification Services (Guangzhou) Co., Ltd. Song Shan Lake Branch. has demonstrated compliance with ISO/IEC Standard 17025:2005, General requirements for the competence of testing and calibration laboratories</p> <p>FCC (FCC Designation No.: CN1187) UL Verification Services (Guangzhou) Co., Ltd. Song Shan Lake Branch. Has been recognized to perform compliance testing on equipment subject to the Commission's Declaration of Conformity (DoC) and Certification rules</p> <p>IC(Company No.: 21320) UL Verification Services (Guangzhou) Co., Ltd. Song Shan Lake Branch. has been registered and fully described in a report filed with Industry Canada. The Company Number is 21320.</p> <p>VCCI (Registration No.: G-20019, R-20004, C-20012 and T-20011) UL Verification Services (Guangzhou) Co., Ltd. Song Shan Lake Branch. has been assessed and proved to be in compliance with VCCI, the Membership No. is 3793. Facility Name: Chamber D, the VCCI registration No. is G-20019 and R-20004 Shielding Room B , the VCCI registration No. is C-20012 and T-20011</p>
---------------------------	---

Note:

1. All tests measurement facilities use to collect the measurement data are located at Building 10, Innovation Technology Park, Song Shan Lake Hi tech Development Zone, Dongguan, 523808, China
2. The test anechoic chamber in UL Verification Services (Guangzhou) Co., Ltd. Song Shan Lake Branch had been calibrated and compared to the open field sites and the test anechoic chamber is shown to be equivalent to or worst case from the open field site.
3. For below 30MHz, lab had performed measurements at test anechoic chamber and comparing to measurements obtained on an open field site. And these measurements below 30MHz had been correlated to measurements performed on an OATS.



4. CALIBRATION AND UNCERTAINTY

4.1. MEASURING INSTRUMENT CALIBRATION

The measuring equipment utilized to perform the tests documented in this report has been calibrated in accordance with the manufacturer's recommendations, and is traceable to recognize national standards.

4.2. MEASUREMENT UNCERTAINTY

Where relevant, the following measurement uncertainty levels have been estimated for tests performed on the apparatus:

Test Item	Uncertainty
Uncertainty for Conduction emission test	2.90dB
Uncertainty for Radiation Emission test(include Fundamental emission) (9KHz-30MHz)	2.2dB
Uncertainty for Radiation Emission test(include Fundamental emission) (30MHz-1GHz)	4.52dB
Uncertainty for Radiation Emission test (1GHz to 26GHz)(include Fundamental emission)	5.04dB(1-6GHz)
	5.30dB (6GHz-18Gz)
	5.23dB (18GHz-26Gz)
Note: This uncertainty represents an expanded uncertainty expressed at approximately the 95% confidence level using a coverage factor of k=2.	



5. EQUIPMENT UNDER TEST

5.1. DESCRIPTION OF EUT

Equipment	Solar Powered Trailer and Assret Tracker		
Model Name	TT601-LM0Q-GL		
Series Model	TT600-LM0Q-GL/TT603-LM0Q-GL		
Model Difference	TT600-LM0Q-GL: without connector, with Bluetooth, no ultracap TT601-LM0Q-GL: with connector, with Bluetooth, no ultracap TT603-LM0Q-GL: with connector(different pins with TT601-LM0Q-GL), with Bluetooth, no ultracap		
Product Description (Bluetooth)	Operation Frequency	2402 MHz ~ 2480 MHz	
	Modulation Type	Data Rate	
	GFSK	1Mbps	
Rated Input	DC 12V, 100mA		
Battery	DC 3.6V, 9000mAh, 32.4Wh		
Bluetooth Version	BT V4.1		

Note: The EUT was used in vehicle environment and can get the rated input from it.

5.2. MAXIMUM OUTPUT POWER

Mode	Frequency (MHz)	Channel Number	Max Output Power (dBm)
BLE	2402-2480	0-39[40]	6.867



5.3. CHANNEL LIST

Channel	Frequency (MHz)	Channel	Frequency (MHz)	Channel	Frequency (MHz)	Channel	Frequency (MHz)
0	2402	11	2424	22	2446	33	2468
1	2404	12	2426	23	2448	34	2470
2	2406	13	2428	24	2450	35	2472
3	2408	14	2430	25	2452	36	2474
4	2410	15	2432	26	2454	37	2476
5	2412	16	2434	27	2456	38	2478
6	2414	17	2436	28	2458	39	2480
7	2416	18	2438	29	2460		
8	2418	19	2440	30	2462		
9	2420	20	2442	31	2464		
10	2422	21	2444	32	2468		

5.4. TEST CHANNEL CONFIGURATION

Test Mode	Test Channel	Frequency
GFSK	CH 00, CH 19, CH 39	2402MHz, 2440MHz, 2480MHz

5.5. THE WORSE CASE POWER SETTING PARAMETER

The Worst Case Power Setting Parameter under 2400 ~ 2483.5MHz Band				
Test Software		BlueNRG GUI		
Modulation Type	Transmit Antenna Number	Test Channel		
		CH 00	CH 19	CH 39
GFSK	1	7	7	7

5.6. DESCRIPTION OF AVAILABLE ANTENNAS

Ant.	Frequency (MHz)	Antenna Type	Antenna Gain (dBi)
1	2402-2480	FPCB	2.8

Test Mode	Transmit and Receive Mode	Description
GFSK	<input checked="" type="checkbox"/> 1TX, 1RX	Chain 1 can be used as transmitting/receiving antenna.



5.7. TEST ENVIRONMENT

Environment Parameter	Selected Values During Tests	
Relative Humidity	55 ~ 65%	
Atmospheric Pressure:	1025Pa	
Temperature	TN	23 ~ 28°C
Voltage :	VL	N/A
	VN	DC 3.6V
	VH	N/A

Note: VL= Lower Extreme Test Voltage
VN= Nominal Voltage
VH= Upper Extreme Test Voltage
TN= Normal Temperature

5.8. DESCRIPTION OF TEST SETUP

SUPPORT EQUIPMENT

Item	Equipment	Brand Name	Model Name	P/N
1	Laptop	ThinkPad	T460S	SL10K24796 JS
2	Serial to USB Cable	/	/	/

I/O CABLES

Cable No	Port	Connector Type	Cable Type	Cable Length(m)	Remarks
1	/	/	/	/	/

ACCESSORY

Item	Accessory	Brand Name	Model Name	Description
1	/	/	/	/

TEST SETUP

The EUT can work in an engineer mode with software through a Laptop before the test.

SETUP DIAGRAM FOR TESTS

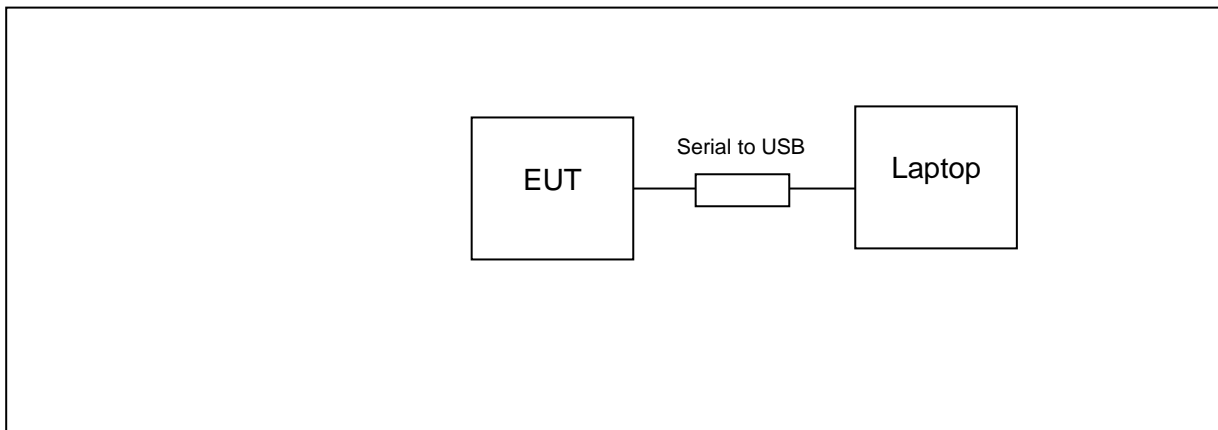

**5.9. MEASURING INSTRUMENT AND SOFTWARE USED**

Conducted Emissions						
Instrument						
Used	Equipment	Manufacturer	Model No.	Serial No.	Last Cal.	Next Cal.
<input checked="" type="checkbox"/>	EMI Test Receiver	R&S	ESR3	101961	Dec.12,2017	Dec.11,2018
<input checked="" type="checkbox"/>	Two-Line V-Network	R&S	ENV216	101983	Dec.12,2017	Dec.11,2018
<input checked="" type="checkbox"/>	Artificial Mains Networks	Schwarzbeck	NSLK 8126	8126465	Dec.12,2017	Dec.11,2018
Software						
Used	Description	Manufacturer	Name	Version		
<input checked="" type="checkbox"/>	Test Software for Conducted disturbance	Farad	EZ-EMC	Ver. UL-3A1		
Radiated Emissions						
Instrument						
Used	Equipment	Manufacturer	Model No.	Serial No.	Last Cal.	Next Cal.
<input checked="" type="checkbox"/>	MXE EMI Receiver	KESIGHT	N9038A	MY56400036	Dec.12,2017	Dec.11,2018
<input checked="" type="checkbox"/>	Hybrid Log Periodic Antenna	TDK	HLP-3003C	130960	Jan.09, 2016	Jan.09, 2019
<input checked="" type="checkbox"/>	Preamplifier	HP	8447D	2944A09099	Dec.12,2017	Dec.11,2018
<input checked="" type="checkbox"/>	EMI Measurement Receiver	R&S	ESR26	101377	Dec.12,2017	Dec.11,2018
<input checked="" type="checkbox"/>	Horn Antenna	TDK	HRN-0118	130939	Jan. 09, 2016	Jan. 09, 2019
<input checked="" type="checkbox"/>	High Gain Horn Antenna	Schwarzbeck	BBHA-9170	691	Jan.06, 2016	Jan.06, 2019
<input checked="" type="checkbox"/>	Preamplifier	TDK	PA-02-0118	TRS-305-00066	Dec.12,2017	Dec.11,2018
<input checked="" type="checkbox"/>	Preamplifier	TDK	PA-02-2	TRS-307-00003	Dec.12,2017	Dec.11,2018
<input checked="" type="checkbox"/>	Loop antenna	Schwarzbeck	1519B	00008	Mar. 26, 2016	Mar. 25, 2019
Software						
Used	Description	Manufacturer	Name	Version		
<input checked="" type="checkbox"/>	Test Software for Radiated disturbance	Farad	EZ-EMC	Ver. UL-3A1		
Other instruments						
Used	Equipment	Manufacturer	Model No.	Serial No.	Last Cal.	Next Cal.
<input checked="" type="checkbox"/>	Spectrum Analyzer	Keysight	N9030A	MY55410512	Dec.12,2017	Dec.11,2018
<input checked="" type="checkbox"/>	Power Meter	Keysight	N1911A	MY55416024	Dec.12,2017	Dec.11,2018
<input checked="" type="checkbox"/>	Power Sensor	Keysight	N1921A	MY51100041	Dec.12,2017	Dec.11,2018



6. MEASUREMENT METHODS

No.	Test Item	KDB Name	Section
1	6 dB Bandwidth	KDB 558074 D01 DTS Meas Guidance v04	8.0
2	Peak Output Power	KDB 558074 D01 DTS Meas Guidance v04	9.1.2
3	Power Spectral Density	KDB 558074 D01 DTS Meas Guidance v04	10.2
4	Out-of-band emissions in non-restricted bands	KDB 558074 D01 DTS Meas Guidance v04	11.0
5	Out-of-band emissions in restricted bands	KDB 558074 D01 DTS Meas Guidance v04	12.1
6	Band-edge	KDB 558074 D01 DTS Meas Guidance v04	13.3.2
7	Conducted Emission Test For AC Power Port	ANSI C63.10-2013	6.2

7. ANTENNA PORT TEST RESULTS

7.1. ON TIME AND DUTY CYCLE

LIMITS

None; for reporting purposes only

PROCEDURE

KDB 558074 Zero-Span Spectrum Analyzer Method

TEST SETUP

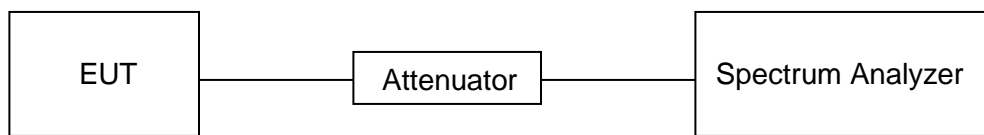

RESULTS

Mode	On Time (msec)	Period (msec)	Duty Cycle x (Linear)	Duty Cycle (%)	Duty Cycle Correction Factor (db)	1/T Minimum VBW (KHz)
BLE	0.3927	0.6219	0.631	63	2.00	3

Note: Duty Cycle Correction Factor= $10\log(1/x)$.
 Where: x is Duty Cycle(Linear)
 Where: T is On Time (transmit duration)

ON TIME AND DUTY CYCLE MID CH

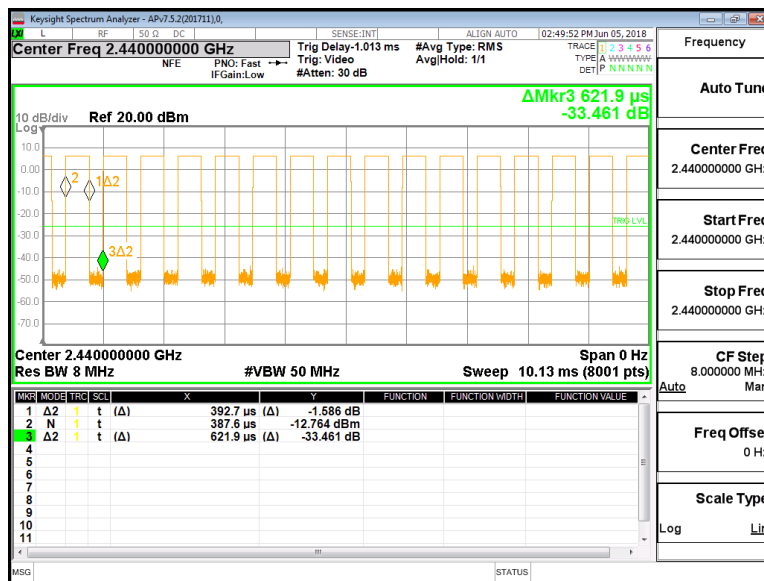

7.2. 99% & 6 dB DTS BANDWIDTH

LIMITS

FCC Part15 (15.247) Subpart C			
Section	Test Item	Limit	Frequency Range (MHz)
FCC 15.247(a)(2)	6 dB Bandwidth	$\geq 500\text{KHz}$	2400-2483.5
RSS-Gen Clause 6.6	99% Bandwidth	For reporting purposes only.	2400-2483.5

TEST PROCEDURE

Connect the UUT to the spectrum analyser and use the following settings:

Center Frequency	The center frequency of the channel under test
Detector	Peak
RBW	For 6dB Bandwidth :100K For 99% Bandwidth :1% to 5% of the occupied bandwidth
VBW	For 6dB Bandwidth : $\geq 3 \times \text{RBW}$ For 99% Bandwidth : approximately $3 \times \text{RBW}$
Trace	Max hold
Sweep	Auto couple

Allow the trace to stabilize and measure the maximum width of the emission that is constrained by the frequencies associated with the two outermost amplitude points (upper and lower frequencies) that are attenuated by 6 dB and 99% relative to the maximum level measured in the fundamental emission.

TEST SETUP

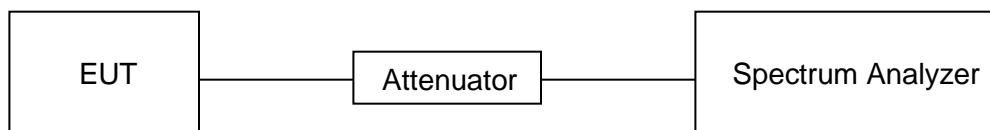



RESULTS

Channel	Frequency (MHz)	6dB bandwidth (MHz)	99% Bandwidth (MHz)	Limit (kHz)	Result
Low	2402	0.666	1.0274	500	Pass
Middle	2440	0.680	1.0274	500	Pass
High	2480	0.654	1.0270	500	Pass

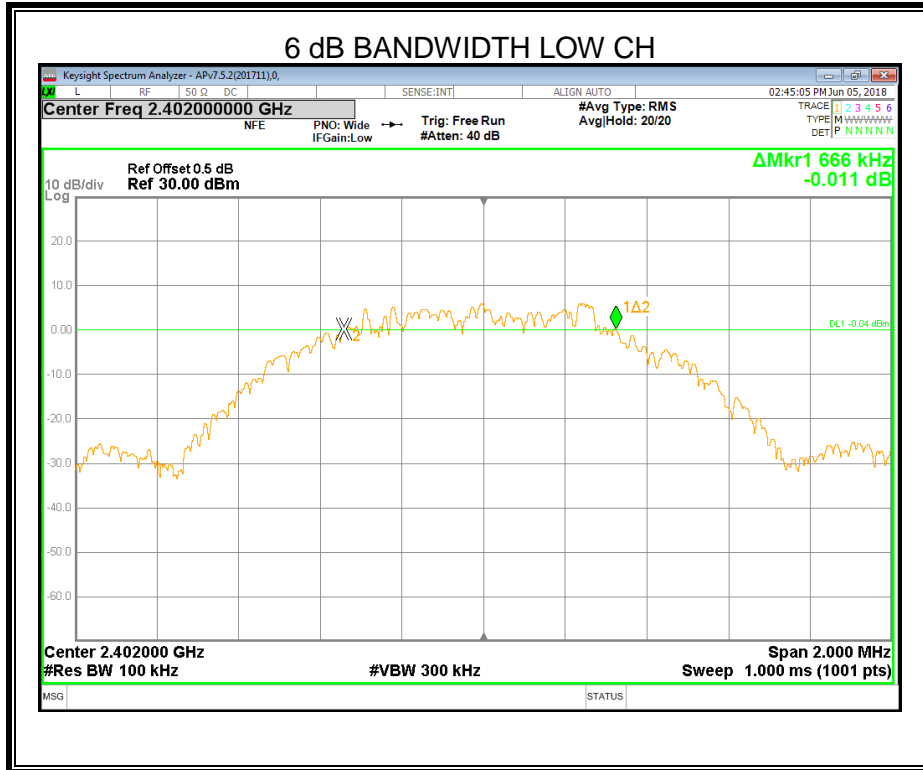

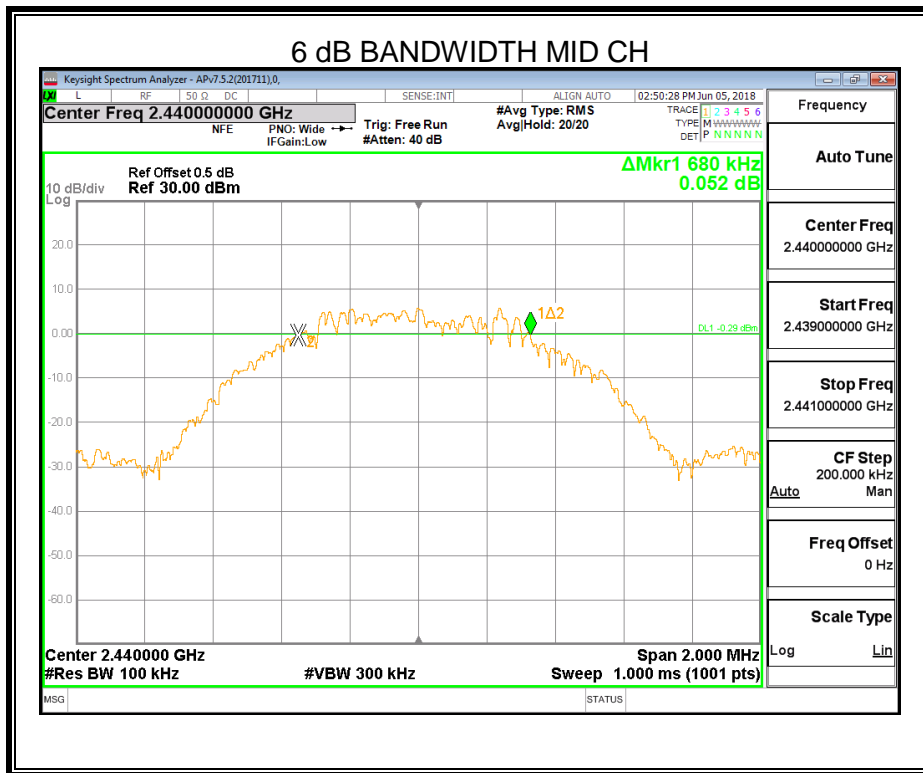
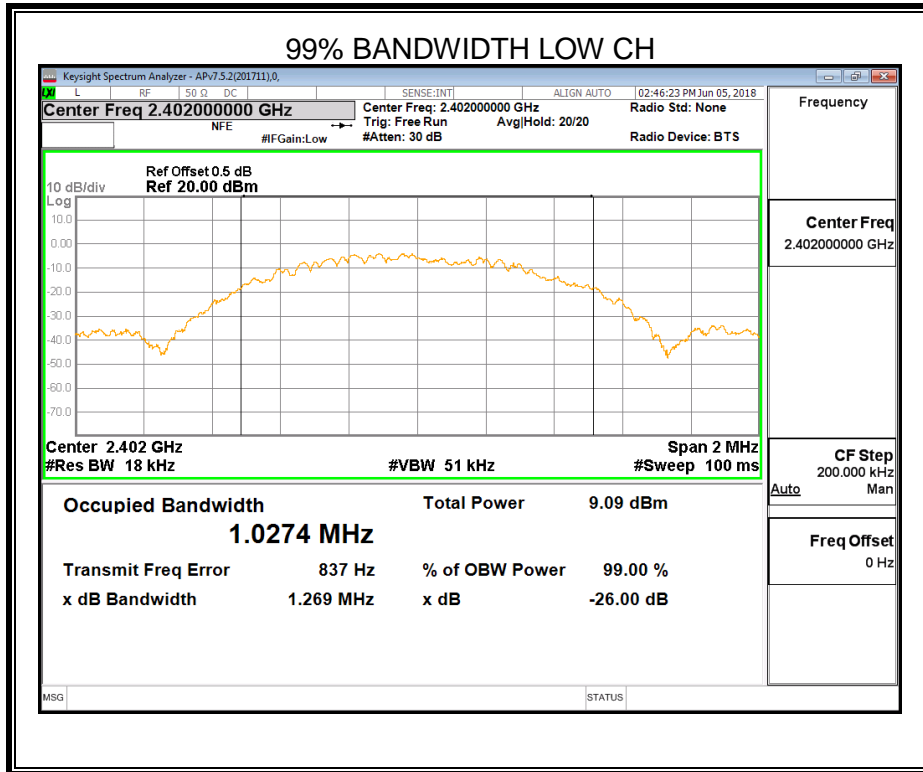

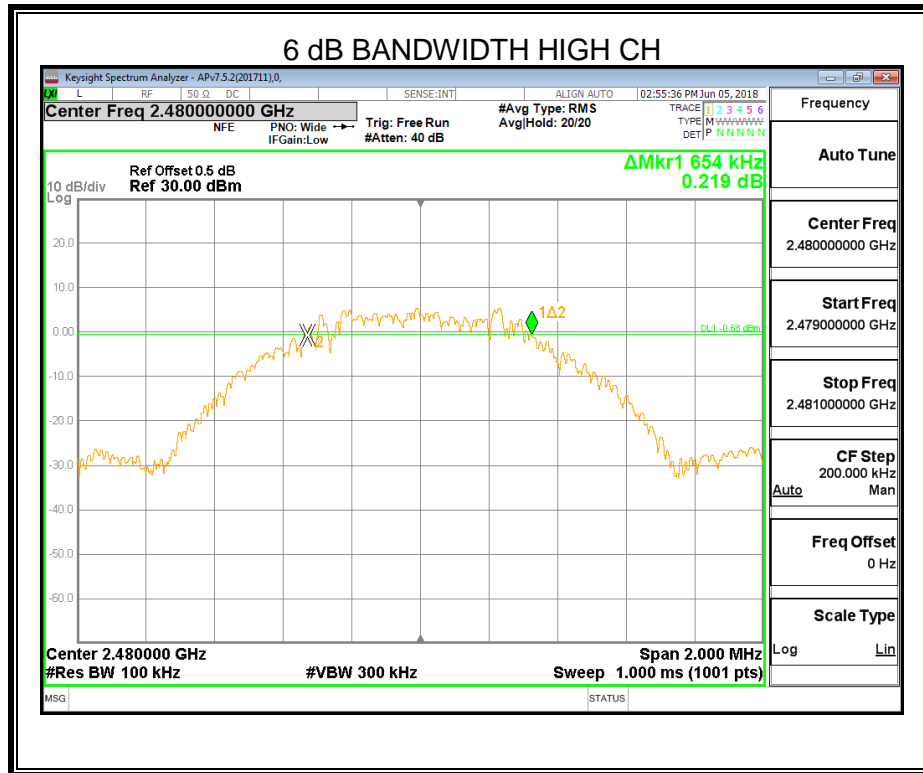
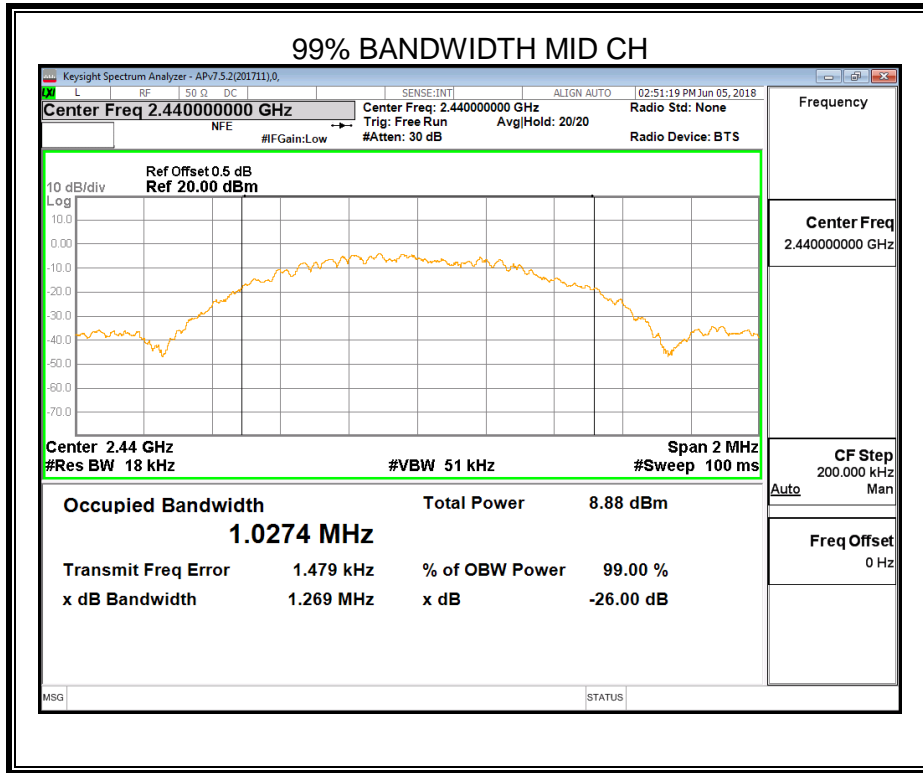

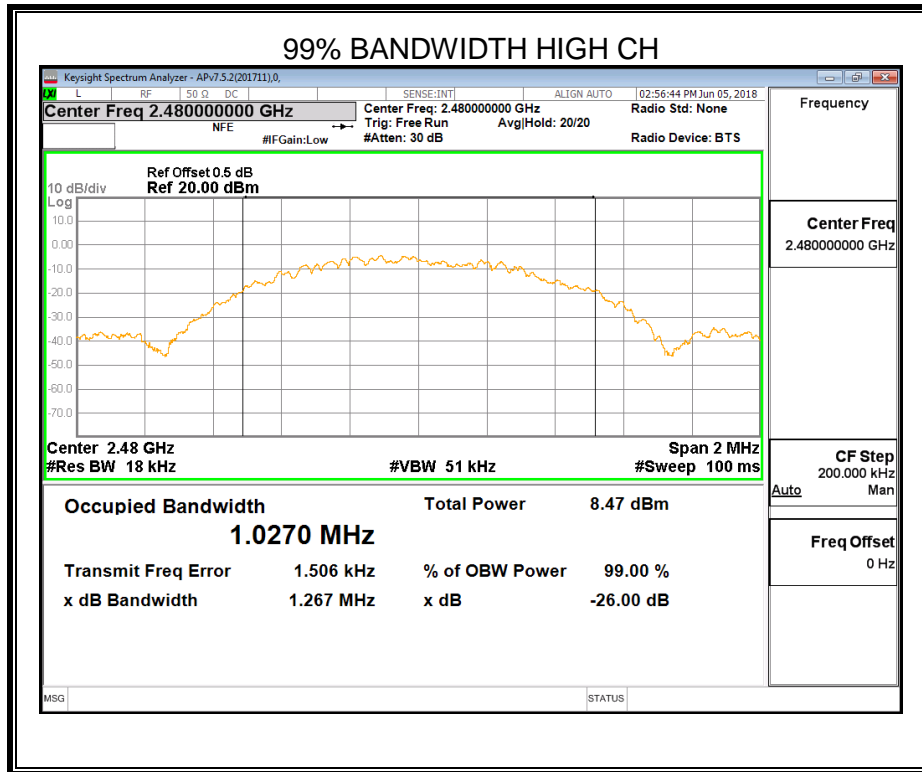



7.3. PEAK CONDUCTED OUTPUT POWER

LIMITS

FCC Part15 (15.247) Subpart C			
Section	Test Item	Limit	Frequency Range (MHz)
FCC 15.247(b)(3)	Peak Output Power	1 watt or 30dBm	2400-2483.5

TEST PROCEDURE

Place the EUT on the table and set it in the transmitting mode.

Remove the antenna from the EUT and then connect a low loss RF cable from the antenna port to the Power sensor.

Measure peak power each channel.

TEST SETUP

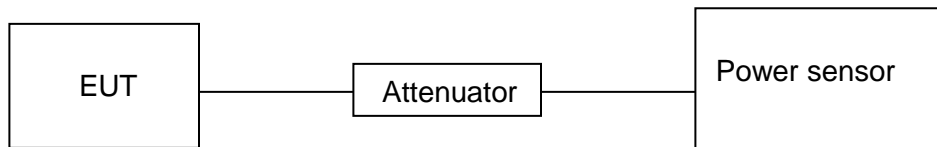

RESULTS

Test Channel	Frequency	Maximum Conducted Output Power(PK)	LIMIT
	(MHz)	(dBm)	dBm
Low	2402	6.867	30
Middle	2440	6.567	30
High	2480	6.179	30

7.4. POWER SPECTRAL DENSITY

LIMITS

FCC Part15 (15.247) Subpart C			
Section	Test Item	Limit	Frequency Range (MHz)
FCC §15.247 (e)	Power Spectral Density	8 dBm in any 3 kHz band	2400-2483.5

TEST PROCEDURE

Connect the UUT to the spectrum analyser and use the following settings:

Center Frequency	The center frequency of the channel under test
Detector	Peak
RBW	$3 \text{ kHz} \leq \text{RBW} \leq 100 \text{ kHz}$
VBW	$\geq 3 \times \text{RBW}$
Span	1.5 x DTS bandwidth
Trace	Max hold
Sweep time	Auto couple.

Allow trace to fully stabilize and use the peak marker function to determine the maximum amplitude level within the RBW.

If measured value exceeds limit, reduce RBW (no less than 3 kHz) and repeat.

TEST SETUP

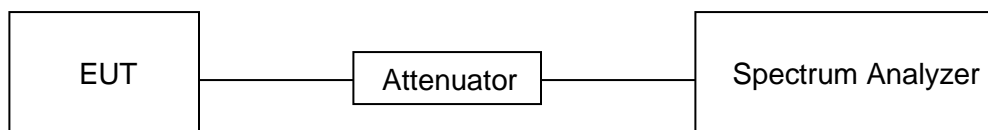



RESULTS

Frequency	Power Spectral Density (dBm/3kHz)	Limit (dBm/3kHz)	Result
2402 MHz	-8.831	8	PASS
2440 MHz	-9.127	8	PASS
2480 MHz	-9.392	8	PASS

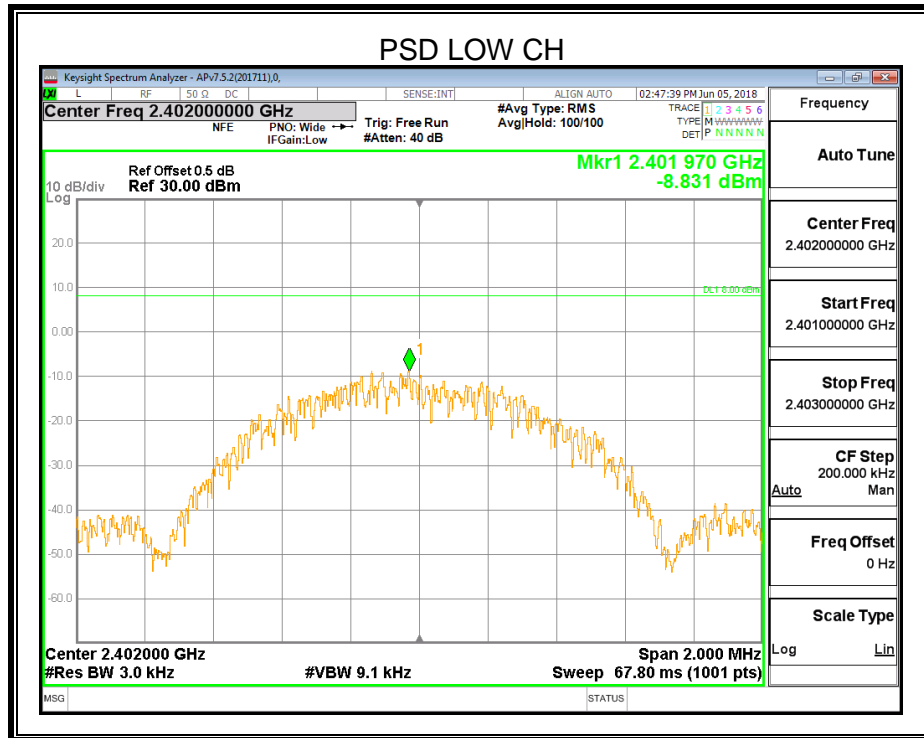

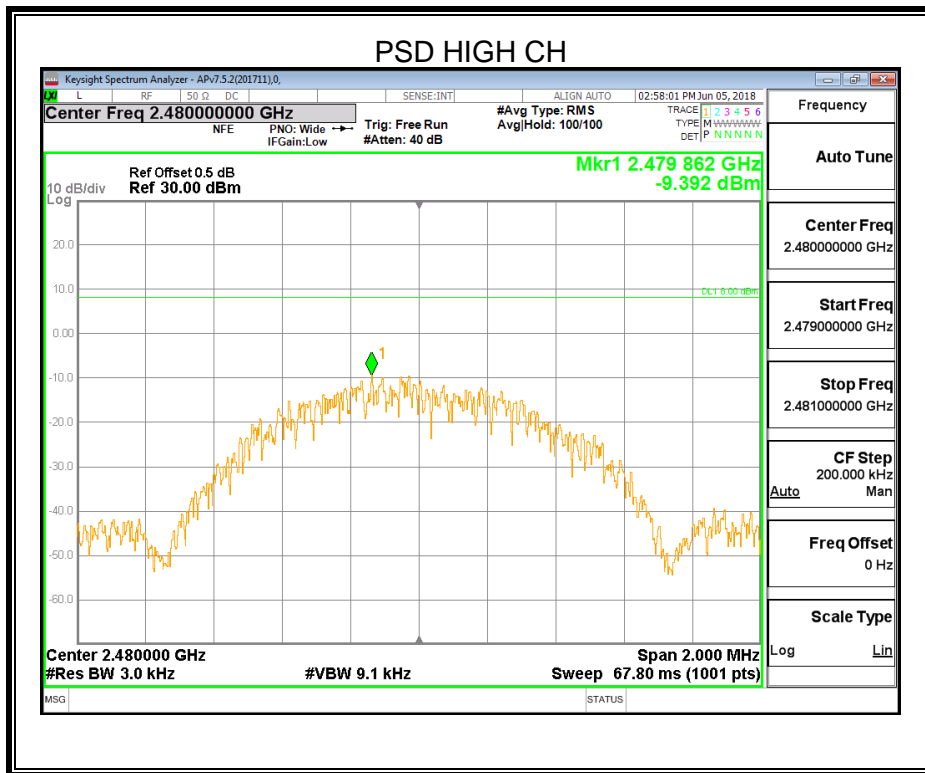
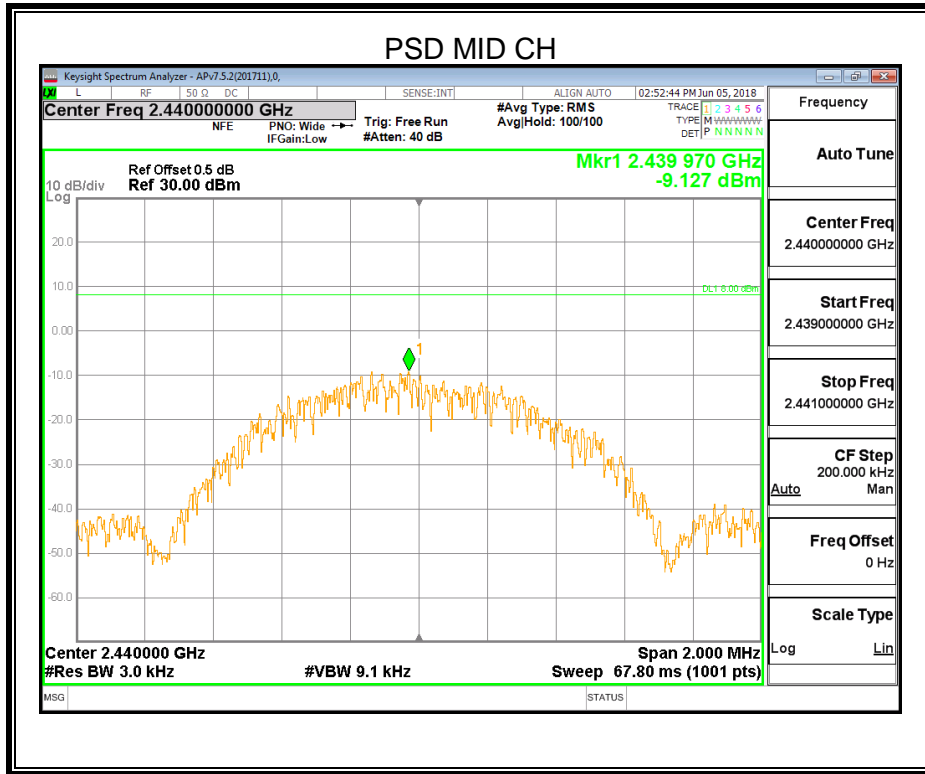

7.5. CONDUCTED BANDEGE AND SPURIOUS EMISSIONS

LIMITS

FCC Part15 (15.247) Subpart C		
Section	Test Item	Limit
FCC §15.247 (d)	Conducted Bandedge and Spurious Emissions	at least 20 dB below that in the 100 kHz bandwidth within the band that contains the highest level of the desired power

TEST PROCEDURE

Connect the UUT to the spectrum analyser and use the following settings:

Center Frequency	The centre frequency of the channel under test
Detector	Peak
RBW	100K
VBW	$\geq 3 \times \text{RBW}$
Span	1.5 x DTS bandwidth
Trace	Max hold
Sweep time	Auto couple.

Use the peak marker function to determine the maximum PSD level.

Span	Set the center frequency and span to encompass frequency range to be measured
Detector	Peak
RBW	100K
VBW	$\geq 3 \times \text{RBW}$
measurement points	$\geq \text{span}/\text{RBW}$
Trace	Max hold
Sweep time	Auto couple.

Use the peak marker function to determine the maximum amplitude level.

TEST SETUP

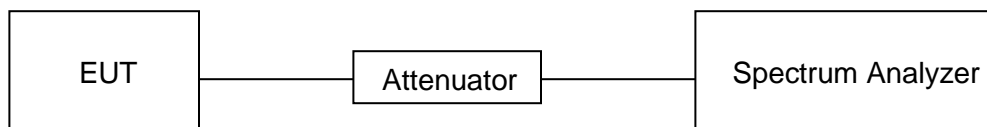

RESULTS

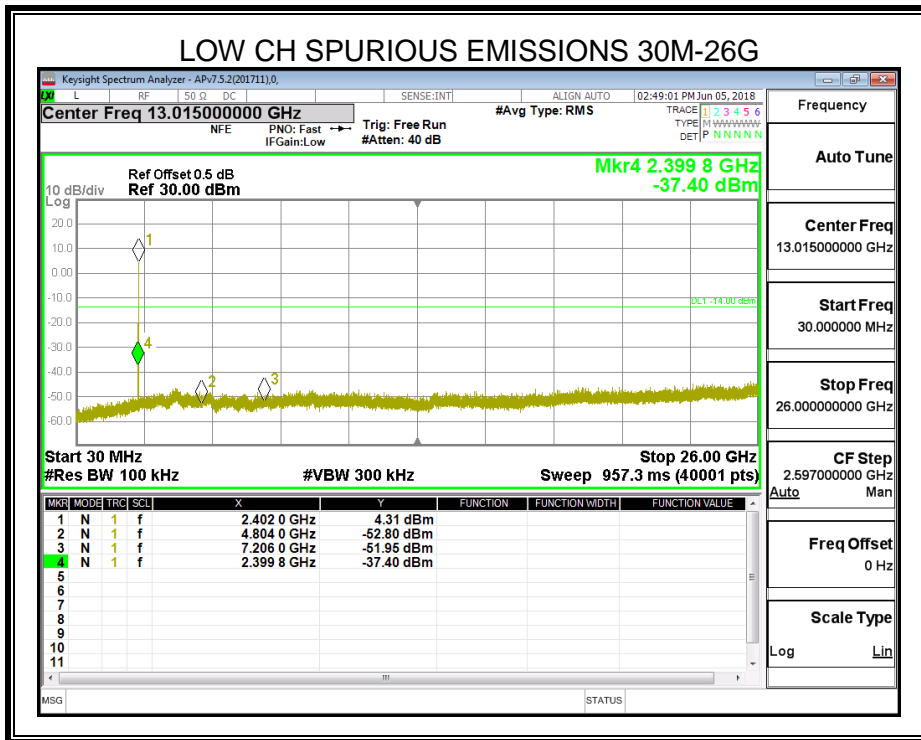
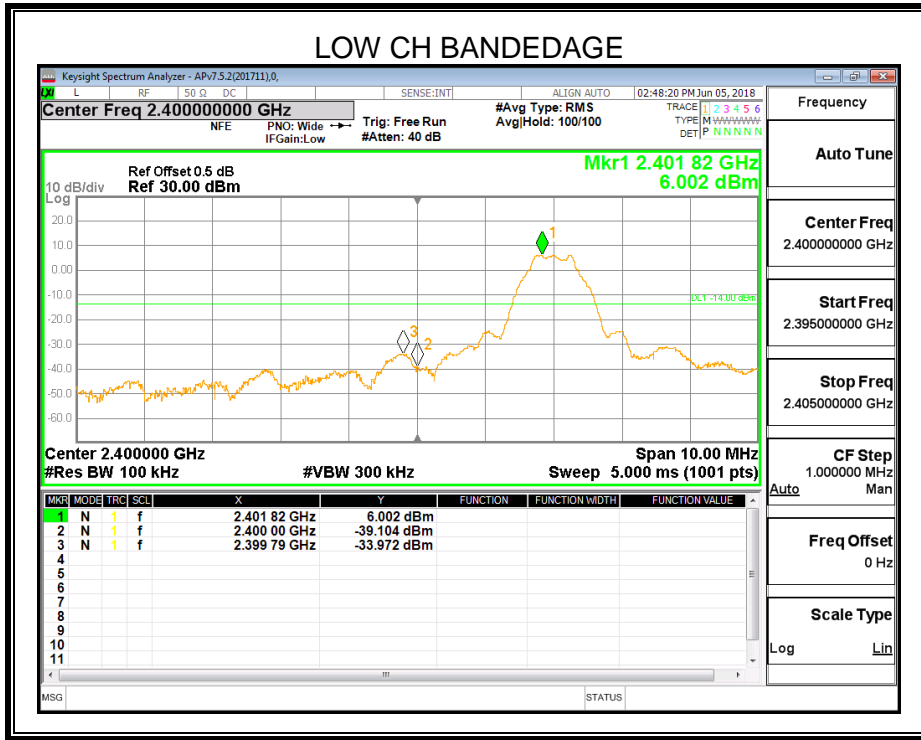

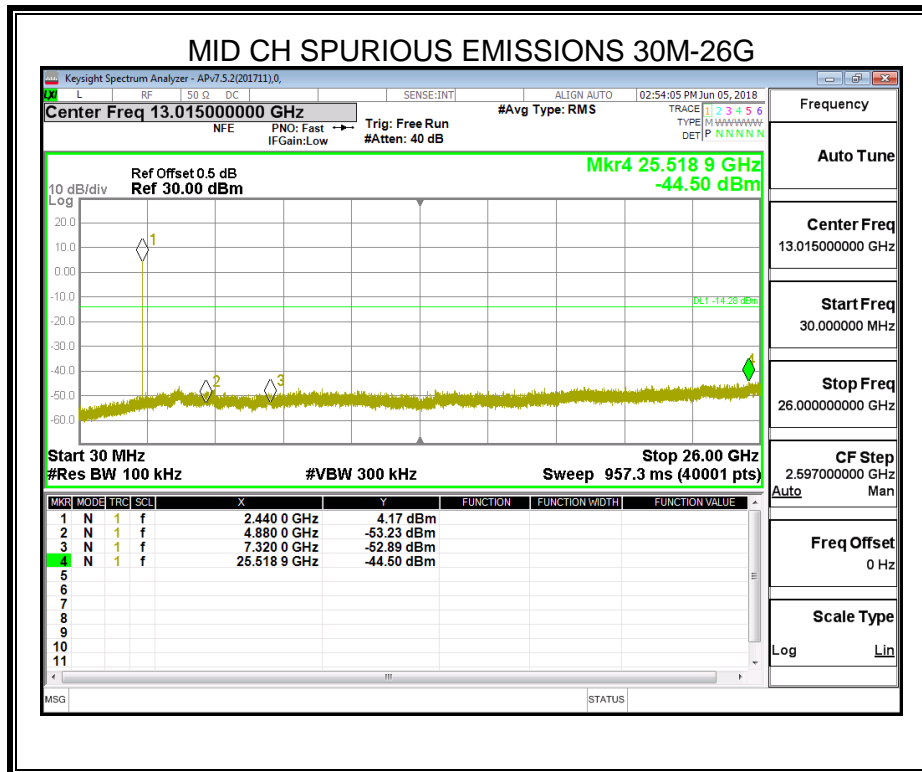
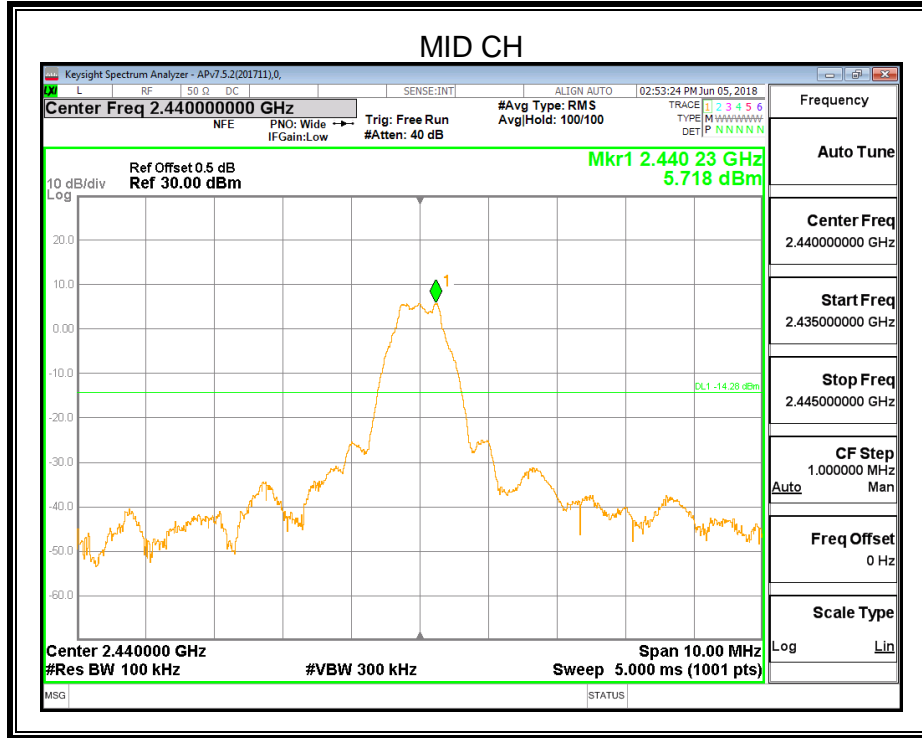

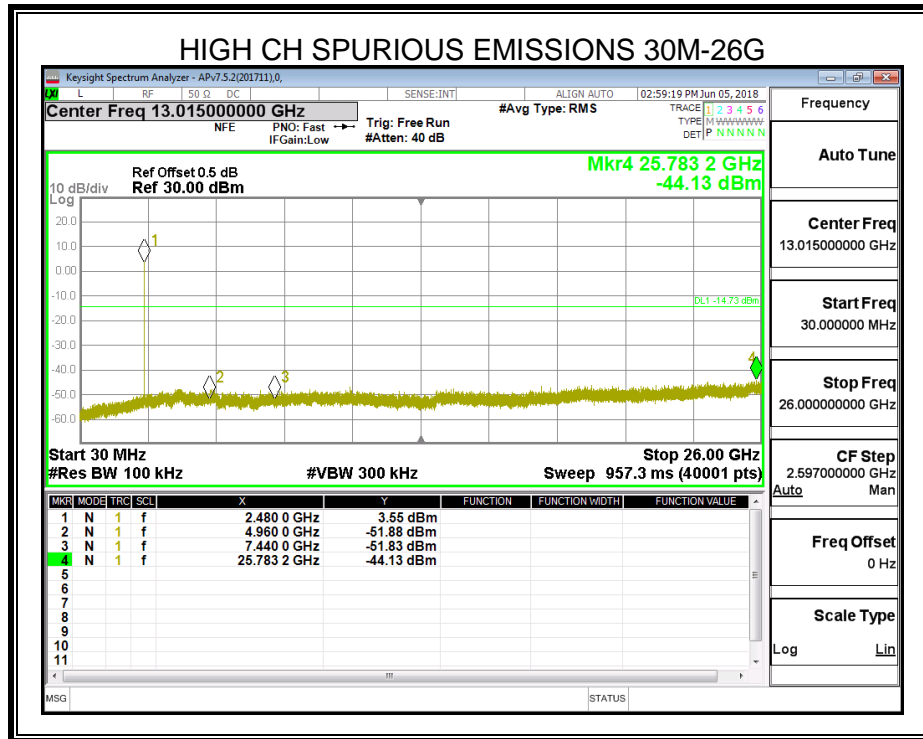
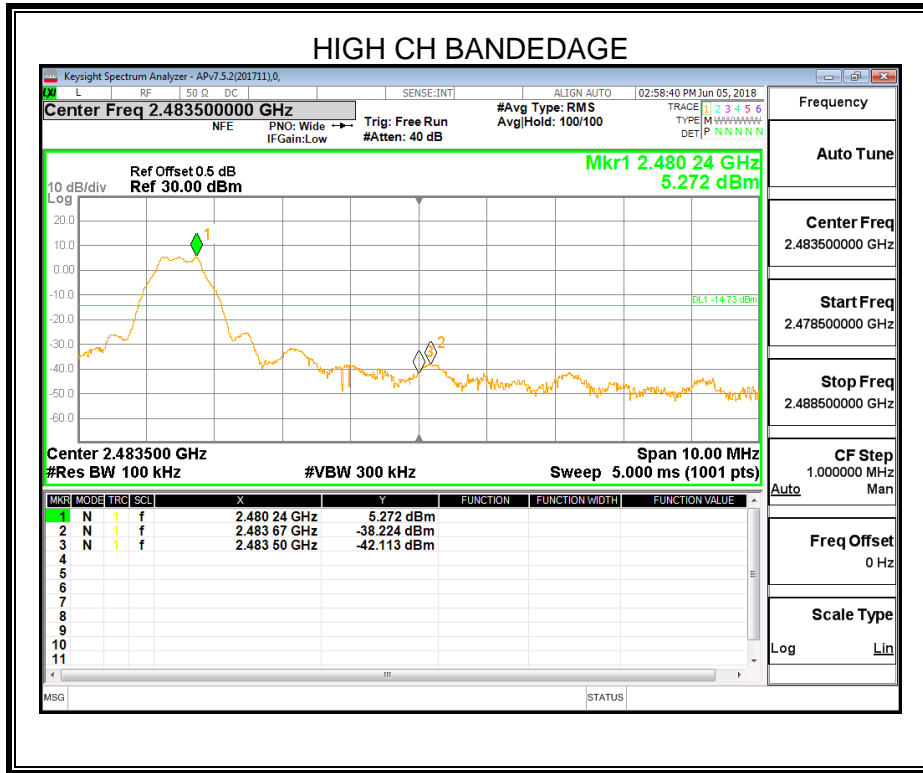



8. RADIATED TEST RESULTS

LIMITS

Please refer to FCC §15.205 and §15.209

Please refer to RSS-GEN Clause 8.9 (Transmitter)

Radiation Disturbance Test Limit for FCC (Class B)(9KHz-1GHz)

Frequency (MHz)	Field Strength (microvolts/meter)	Measurement Distance (meters)
0.009~0.490	2400/F(KHz)	300
0.490~1.705	24000/F(KHz)	30
1.705~30.0	30	30
30~88	100	3
88~216	150	3
216~960	200	3
960~1000	500	3

Note: 1) At frequencies at or above 30 MHz, measurements may be performed at a distance other than what is specified provided: measurements are not made in the near field except where it can be shown that near field measurements are appropriate due to the characteristics of the device; and it can be demonstrated that the signal levels needed to be measured at the distance employed can be detected by the measurement equipment. Measurements shall not be performed at a distance greater than 30 meters unless it can be further demonstrated that measurements at a distance of 30 meters or less are impractical. When performing measurements at a distance other than that specified, the results shall be extrapolated to the specified distance using an extrapolation factor of 20 dB/decade (inverse linear-distance for field strength measurements; inverse-linear-distance-squared for power density measurements).

(2) At frequencies below 30 MHz, measurements may be performed at a distance closer than that specified in the regulations; however, an attempt should be made to avoid making measurements in the near field. Pending the development of an appropriate measurement procedure for measurements performed below 30 MHz, when performing measurements at a closer distance than specified, the results shall be extrapolated to the specified distance by either making measurements at a minimum of two distances on at least one radial to determine the proper extrapolation factor or by using the square of an inverse linear distance extrapolation factor (40 dB/decade). This paragraph (f) shall not apply to Access BPL devices operating below 30 MHz.



Radiation Disturbance Test Limit for FCC (Above 1G)

Frequency (MHz)	dB(uV/m) (at 3 meters)	
	Peak	Average
Above 1000	74	54

Restricted bands of operation

MHz	MHz	MHz	GHz
0.090-0.110	16.42-16.423	399.9-410	4.5-5.15
¹ 0.495-0.505	16.69475-16.69525	608-614	5.35-5.46
2.1735-2.1905	16.80425-16.80475	960-1240	7.25-7.75
4.125-4.128	25.5-25.67	1300-1427	8.025-8.5
4.17725-4.17775	37.5-38.25	1435-1626.5	9.0-9.2
4.20725-4.20775	73-74.6	1645.5-1646.5	9.3-9.5
6.215-6.218	74.8-75.2	1660-1710	10.6-12.7
6.26775-6.26825	108-121.94	1718.8-1722.2	13.25-13.4
6.31175-6.31225	123-138	2200-2300	14.47-14.5
8.291-8.294	149.9-150.05	2310-2390	15.35-16.2
8.362-8.366	156.52475-156.52525	2483.5-2500	17.7-21.4
8.37625-8.38675	156.7-156.9	2690-2900	22.01-23.12
8.41425-8.41475	162.0125-167.17	3260-3267	23.6-24.0
12.29-12.293	167.72-173.2	3332-3339	31.2-31.8
12.51975-12.52025	240-285	3345.8-3358	36.43-36.5
12.57675-12.57725	322-335.4	3600-4400	(²)
13.36-13.41			

Note: ¹Until February 1, 1999, this restricted band shall be 0.490-0.510 MHz.

²Above 38.6c

TEST SETUP AND PROCEDURE

Below 30MHz

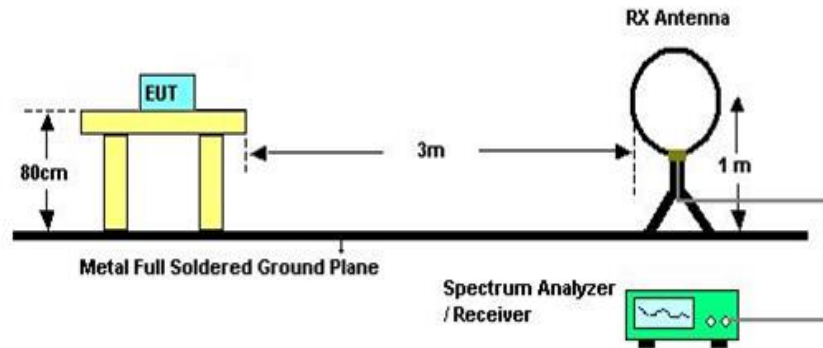

The setting of the spectrum analyzer

RBW	200Hz (From 9kHz to 0.15MHz)/ 9KHz (From 0.15MHz to 30MHz)
VBW	200Hz (From 9kHz to 0.15MHz)/ 9KHz (From 0.15MHz to 30MHz)
Sweep	Auto
Trace	Max hold

1. The testing follows the guidelines in ANSI C63.10-2013 and 414788 D01 Radiated Test Site v01.
2. The EUT was arranged to its worst case and then turntable (from 0 degree to 360 degrees) to find the maximum reading. A pre-amp and a high pass filter are used for the test in order to get better signal level. Both horizontal and vertical polarizations of the antenna are set to make the measurement.
3. The EUT was placed on a turntable with 80cm meter above ground.
4. The EUT was set 3 meters from the interference receiving antenna, which was mounted on the top of a variable height antenna tower.
5. The radiated emission limits are based on measurements employing a CISPR quasi-peak detector except for the frequency bands 9-90 kHz, 110-490 kHz and above 1000 MHz. Radiated emission limits in these three bands are based on measurements employing an average detector.
6. For measurement below 1GHz, the initial step in collecting conducted emission data is a spectrum analyzer peak detector mode pre-scanning the measurement frequency range. Significant peaks are then marked and then Quasi Peak detector mode re-measured. If the emission level of the EUT measured by the peak detector is 3 dB lower than the applicable limit, the peak emission level will be reported. Otherwise, the emission measurement will be repeated using the quasi-peak detector and reported.
7. Although these tests were performed other than open area test site, adequate comparison measurements were confirmed against 30m open are test site. Therefore sufficient tests were made to demonstrate that the alternative site produces results that correlate with the ones of tests made in an open field based on KDB 414788.

Below 1G and above 30MHz

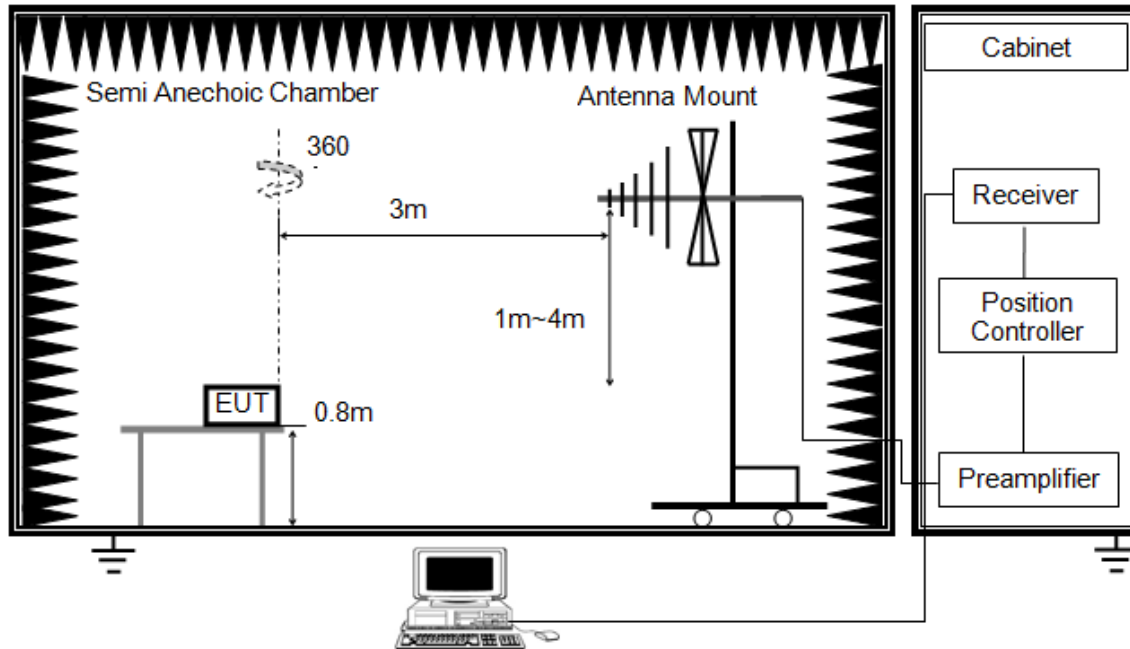

The setting of the spectrum analyzer

RBW	120K
VBW	300K
Sweep	Auto
Detector	Peak/QP
Trace	Max hold

1. The testing follows the guidelines in ANSI C63.10-2013.
2. The EUT was arranged to its worst case and then tune the antenna tower (from 1 m to 4 m) and turntable (from 0 degree to 360 degrees) to find the maximum reading. A pre-amp and a high pass filter are used for the test in order to get better signal level. Both horizontal and vertical polarizations of the antenna are set to make the measurement.
3. The EUT was placed on a turntable with 0.8m above ground.
4. The EUT was set 3 meters from the interference receiving antenna, which was mounted on the top of a variable height antenna tower.
5. For measurement below 1GHz, the initial step in collecting conducted emission data is a spectrum analyzer peak detector mode pre-scanning the measurement frequency range. Significant peaks are then marked and then Quasi Peak detector mode re-measured. If the emission level of the EUT measured by the peak detector is 3 dB lower than the applicable limit, the peak emission level will be reported. Otherwise, the emission measurement will be repeated using the quasi-peak detector and reported.

Above 1G

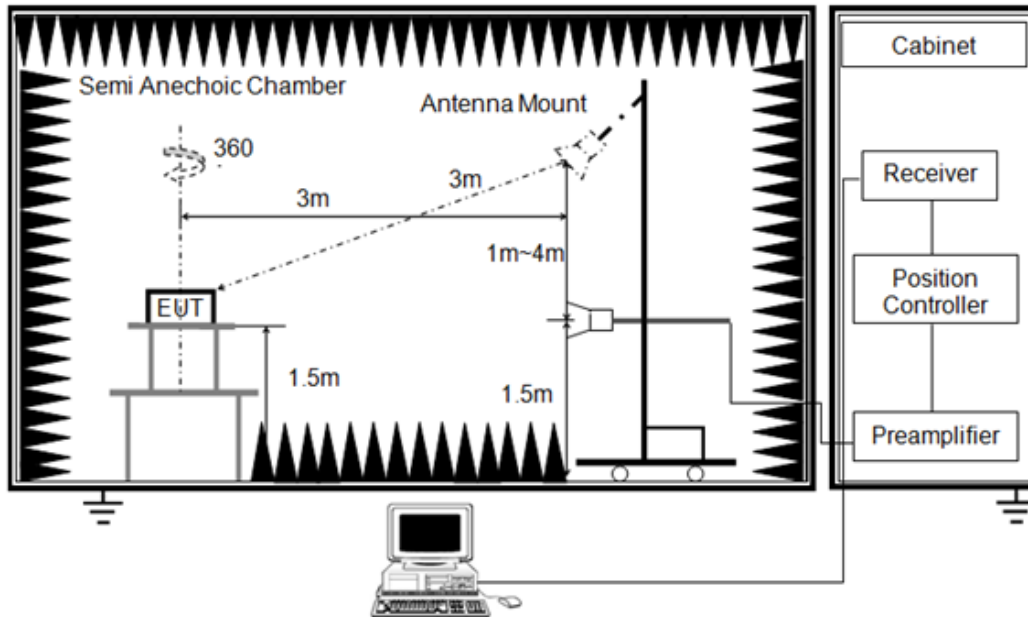

The setting of the spectrum analyzer

RBW	1M
VBW	PEAK: 3M AVG: see note 6
Sweep	Auto
Detector	Peak
Trace	Max hold

1. The testing follows the guidelines in ANSI C63.10-2013.
2. The EUT was arranged to its worst case and then tune the antenna tower (from 1 m to 4 m) and turntable (from 0 degree to 360 degrees) to find the maximum reading. A pre-amp and a high pass filter are used for the test in order to get better signal level. Both horizontal and vertical polarizations of the antenna are set to make the measurement.
3. The EUT was placed on a turntable with 80cm above ground.
4. The EUT was set 3 meters from the interference receiving antenna, which was mounted on the top of a variable height antenna tower.
5. For measurement above 1GHz, the emission measurement will be measured by the peak detector. This peak level, once corrected, must comply with the limit specified in Section 15.209.
6. For average power measurement, set the Detector to RMS, the detector and averaging type may be set for linear voltage averaging, while maintaining all of the other instrument settings, if the duty cycle of the EUT is less than 98%, the Duty Cycle Correction Factor shall be added to the measured emission levels. For the Duty Cycle and Correction Factor please refer to clause 7.1.ON TIME AND DUTY CYCLE.

Note: For all radiated measurements, lab had tested for stand-alone mode and all the external accessories attached to the EUT mode, only the worst data was recorded in the report.



8.1. RESTRICTED BANDEDGE

PEAK

RESTRICTED BANDEDGE (LOW CHANNEL, HORIZONTAL)

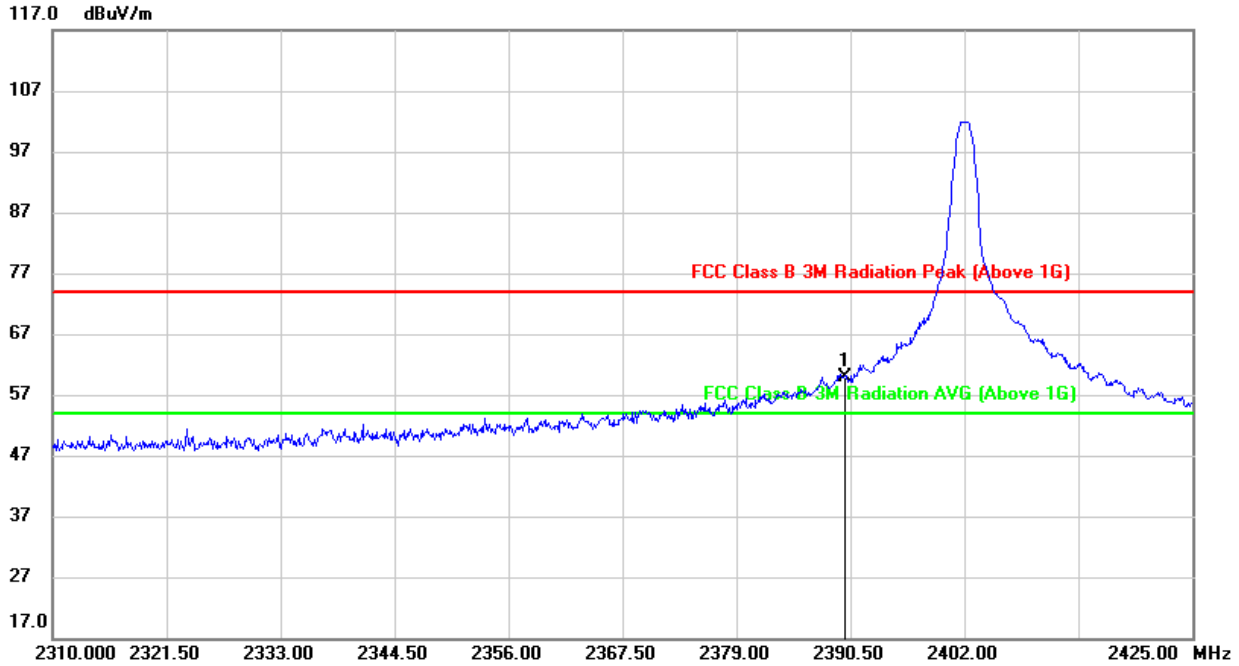

No.	Frequency (MHz)	Reading (dBuV)	Correct (dB/m)	Result (dBuV/m)	Limit (dBuV/m)	Margin (dB)	Remark
1	2390.000	26.84	33.14	59.98	74.00	-14.02	peak

- Note: 1. Measurement = Reading Level + Correct Factor.
 2. Only the worst case emission recorded in the report, if Peak Result complies with AV limit, AV Result is deemed to comply with AV limit.
 3. Peak: Peak detector.



RESTRICTED BANDEDGE (LOW CHANNEL, VERTICAL)

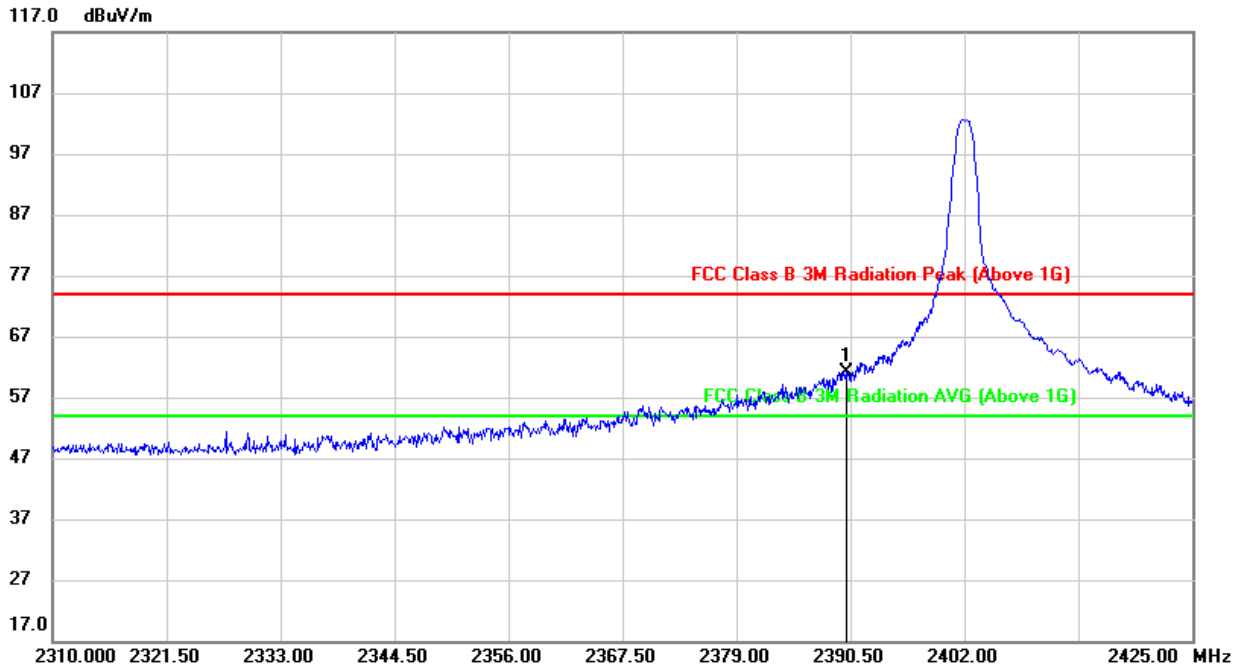

No.	Frequency (MHz)	Reading (dBuV)	Correct (dB/m)	Result (dBuV/m)	Limit (dBuV/m)	Margin (dB)	Remark
1	2390.000	27.99	33.24	61.23	74.00	-12.77	peak

- Note: 1. Measurement = Reading Level + Correct Factor.
 2. Only the worst case emission recorded in the report, if Peak Result complies with AV limit, AV Result is deemed to comply with AV limit.
 3. Peak: Peak detector.



AVERAGE

RESTRICTED BANDEDGE (LOW CHANNEL, HORIZONTAL)

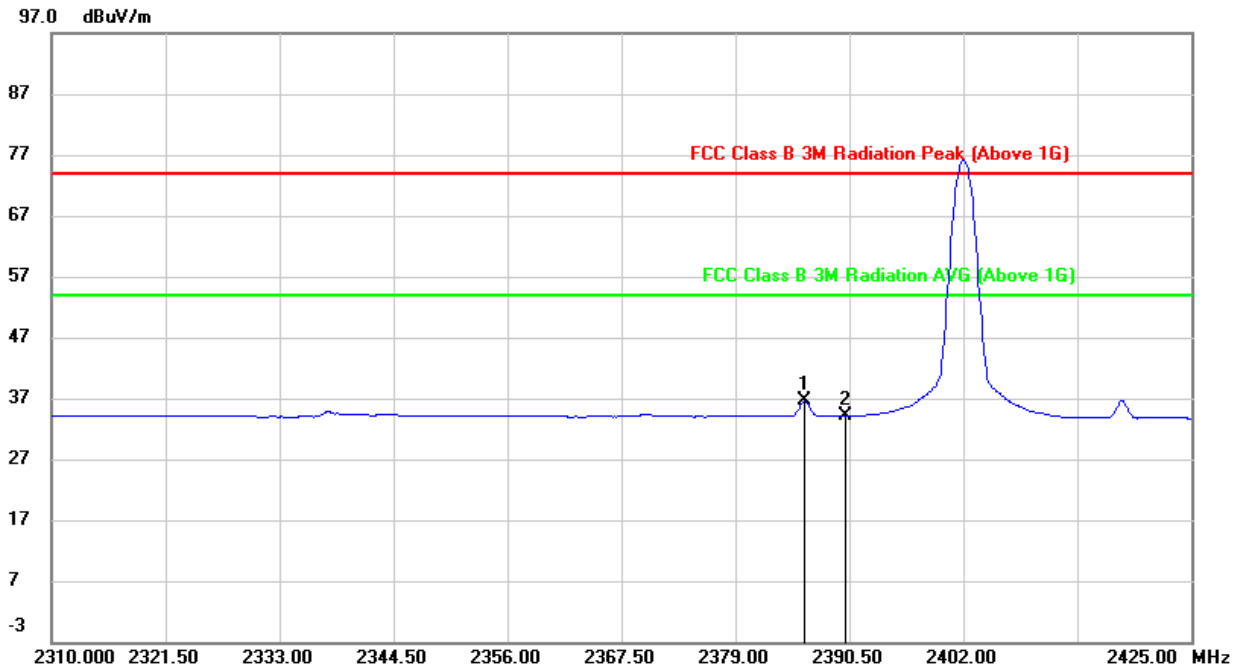

No.	Frequency (MHz)	Reading (dBuV)	Correct (dB/m)	Result (dBuV/m)	Limit (dBuV/m)	Margin (dB)	Remark
1	2386.015	3.36	35.24	38.60	54.00	-15.40	AVG
2	2390.000	1.00	35.14	36.14	54.00	-17.86	AVG

- Note: 1. Measurement = Reading Level + Correct Factor.
 2. AVG: RMS detector, the detector and averaging type may be set for linear voltage averaging.
 3. DCCF: Duty Cycle Correction Factor (Please refer to clause 7.1.ON TIME AND DUTY CYCLE)
 4. The DCCF already added in Correct Factor.



RESTRICTED BANDEDGE (LOW CHANNEL, VERTICAL)

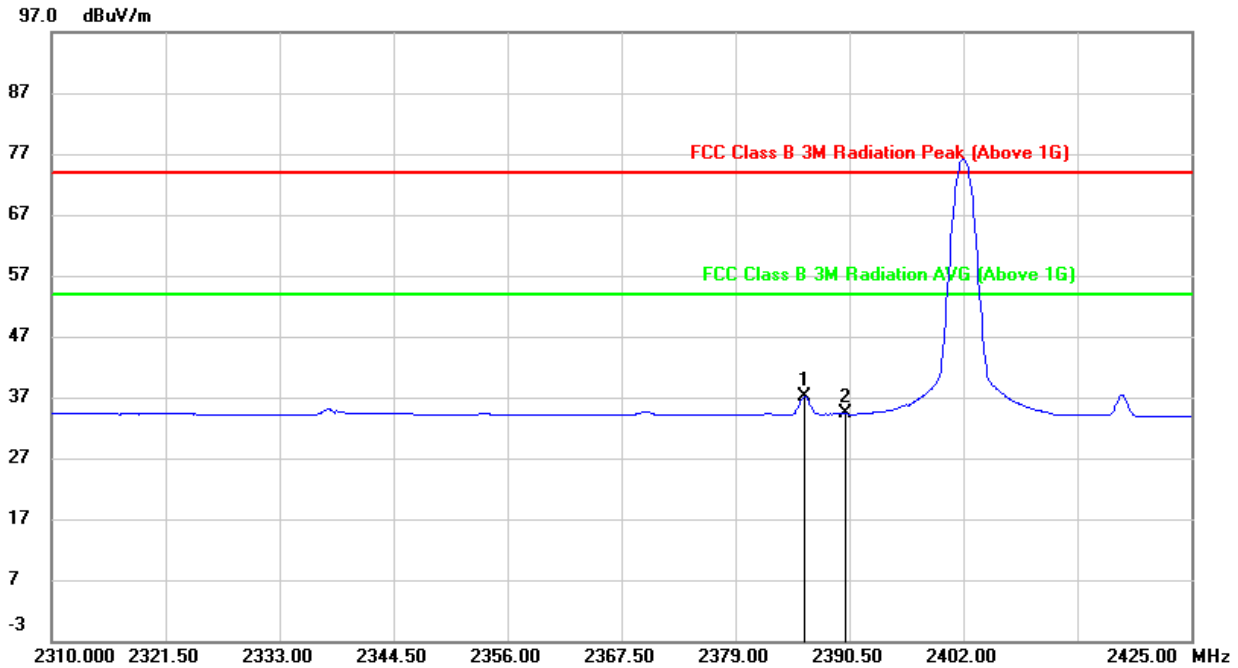

No.	Frequency (MHz)	Reading (dBuV)	Correct (dB/m)	Result (dBuV/m)	Limit (dBuV/m)	Margin (dB)	Remark
1	2386.015	3.89	35.24	39.13	54.00	-14.87	AVG
2	2390.000	1.05	35.14	36.19	54.00	-17.81	AVG

- Note: 1. Measurement = Reading Level + Correct Factor.
 2. AVG: RMS detector, the detector and averaging type may be set for linear voltage averaging.
 3. DCCF: Duty Cycle Correction Factor (Please refer to clause 7.1.ON TIME AND DUTY CYCLE)
 4. The DCCF already added in Correct Factor.



PEAK

RESTRICTED BANDEDGE (HIGH CHANNEL, HORIZONTAL)

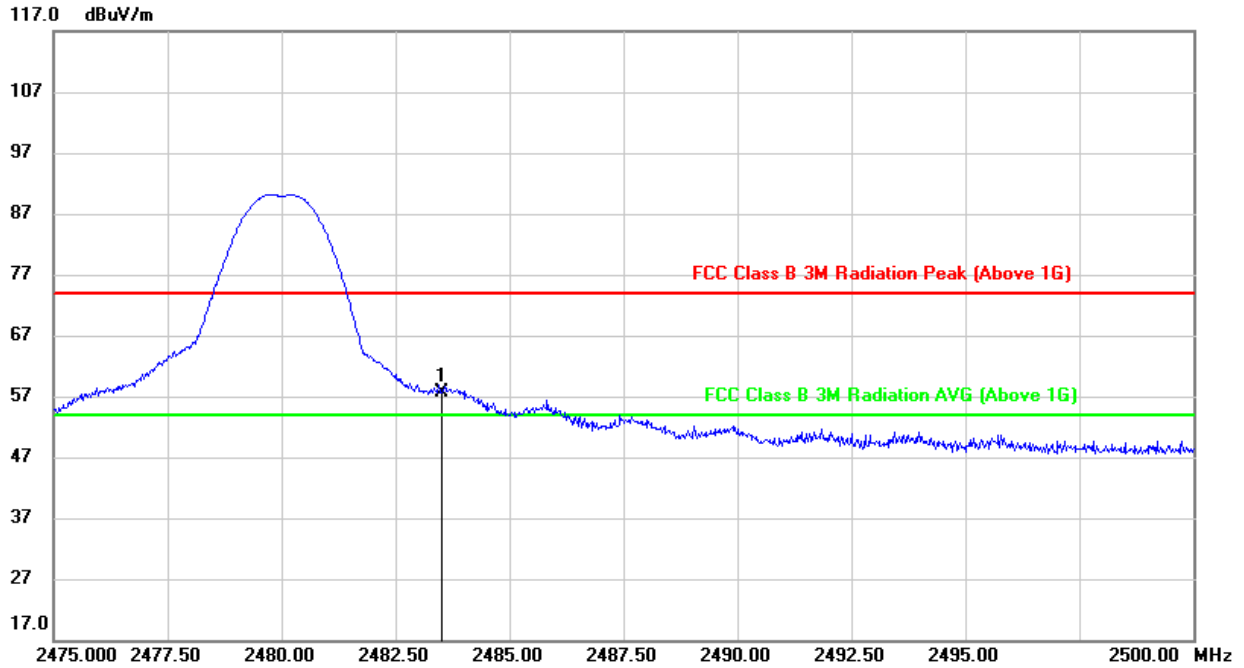

No.	Frequency (MHz)	Reading (dBuV)	Correct (dB/m)	Result (dBuV/m)	Limit (dBuV/m)	Margin (dB)	Remark
1	2483.500	24.88	32.78	57.66	74.00	-16.34	peak

- Note: 1. Measurement = Reading Level + Correct Factor.
 2. Only the worst case emission recorded in the report, if Peak Result complies with AV limit, AV Result is deemed to comply with AV limit.
 3. Peak: Peak detector.



RESTRICTED BANDEDGE (HIGH CHANNEL, VERTICAL)

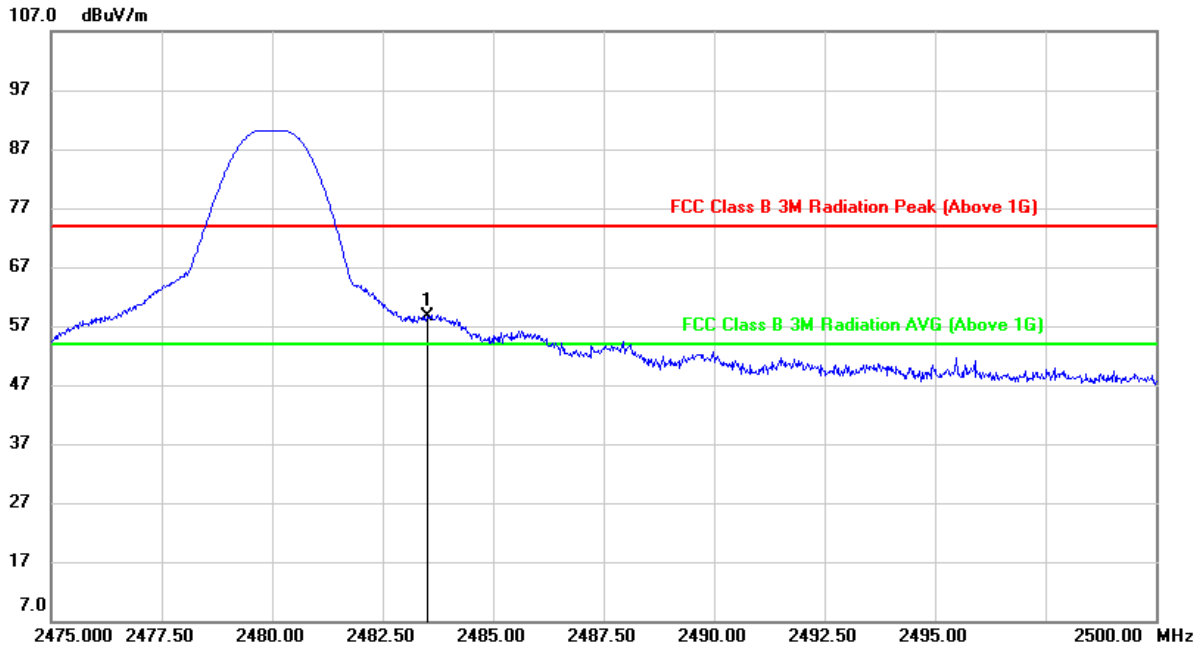

No.	Frequency (MHz)	Reading (dBuV)	Correct (dB/m)	Result (dBuV/m)	Limit (dBuV/m)	Margin (dB)	Remark
1	2483.500	25.71	32.88	58.59	74.00	-15.41	peak

- Note: 1. Measurement = Reading Level + Correct Factor.
 2. Only the worst case emission recorded in the report, if Peak Result complies with AV limit, AV Result is deemed to comply with AV limit.
 3. Peak: Peak detector.



AVERAGE

RESTRICTED BANDEDGE (HIGH CHANNEL, HORIZONTAL)

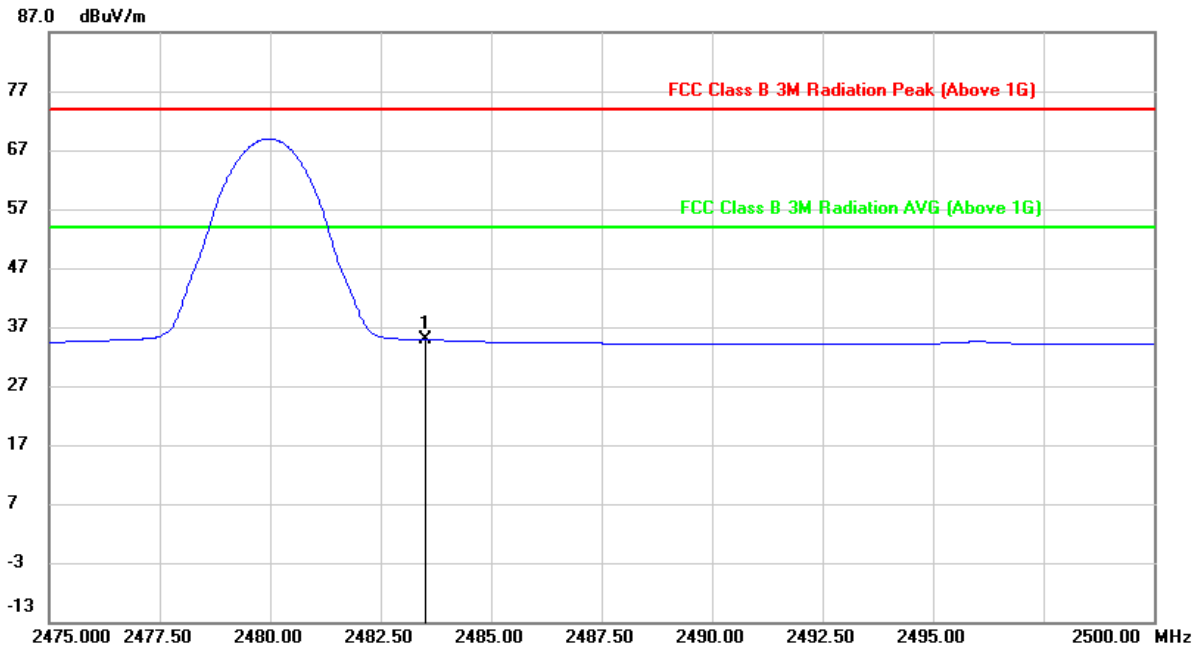

No.	Frequency (MHz)	Reading (dBuV)	Correct (dB/m)	Result (dBuV/m)	Limit (dBuV/m)	Margin (dB)	Remark
1	2483.500	2.03	35.24	37.27	54.00	-16.73	AVG

- Note:
1. Measurement = Reading Level + Correct Factor.
 2. AVG: RMS detector, the detector and averaging type may be set for linear voltage averaging.
 3. DCCF: Duty Cycle Correction Factor (Please refer to clause 7.1.ON TIME AND DUTY CYCLE)
 4. The DCCF already added in Correct Factor.



RESTRICTED BANDEDGE (HIGH CHANNEL, VERTICAL)

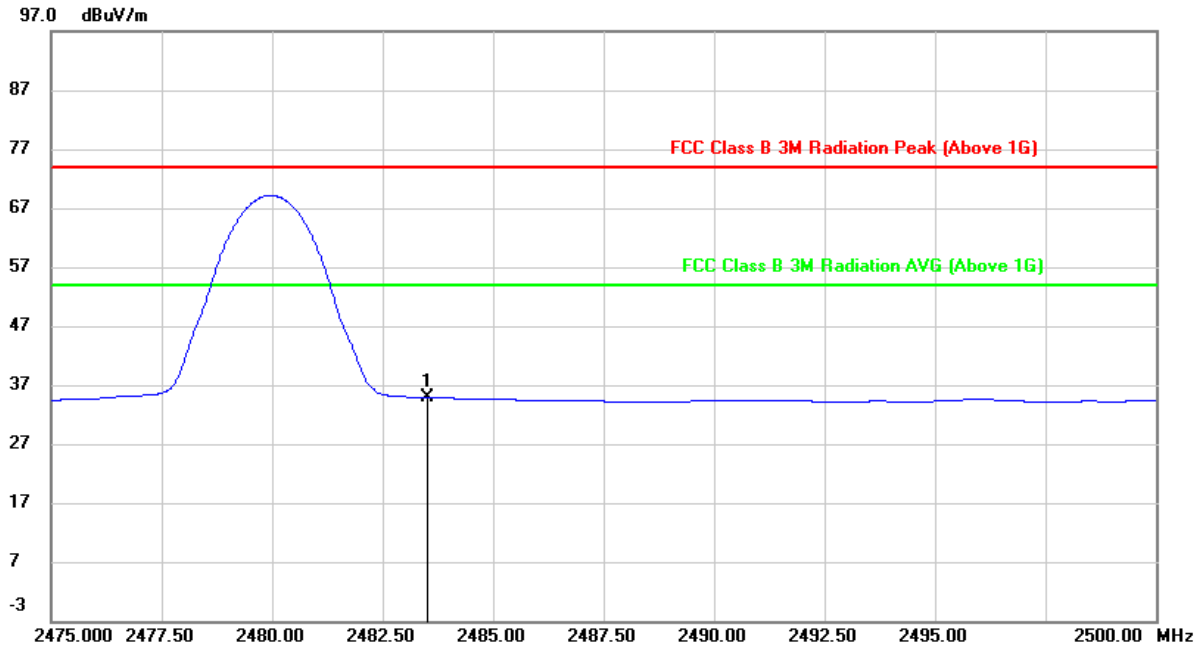

No.	Frequency (MHz)	Reading (dBuV)	Correct (dB/m)	Result (dBuV/m)	Limit (dBuV/m)	Margin (dB)	Remark
1	2483.500	2.04	35.24	37.28	54.00	-16.72	AVG

- Note: 1. Measurement = Reading Level + Correct Factor.
 2. AVG: RMS detector, the detector and averaging type may be set for linear voltage averaging.
 3. DCCF: Duty Cycle Correction Factor (Please refer to clause 7.1.ON TIME AND DUTY CYCLE)
 4. The DCCF already added in Correct Factor.



8.2. SPURIOUS EMISSIONS (1~18GHz)

HARMONICS AND SPURIOUS EMISSIONS (LOW CHANNEL, HORIZONTAL)

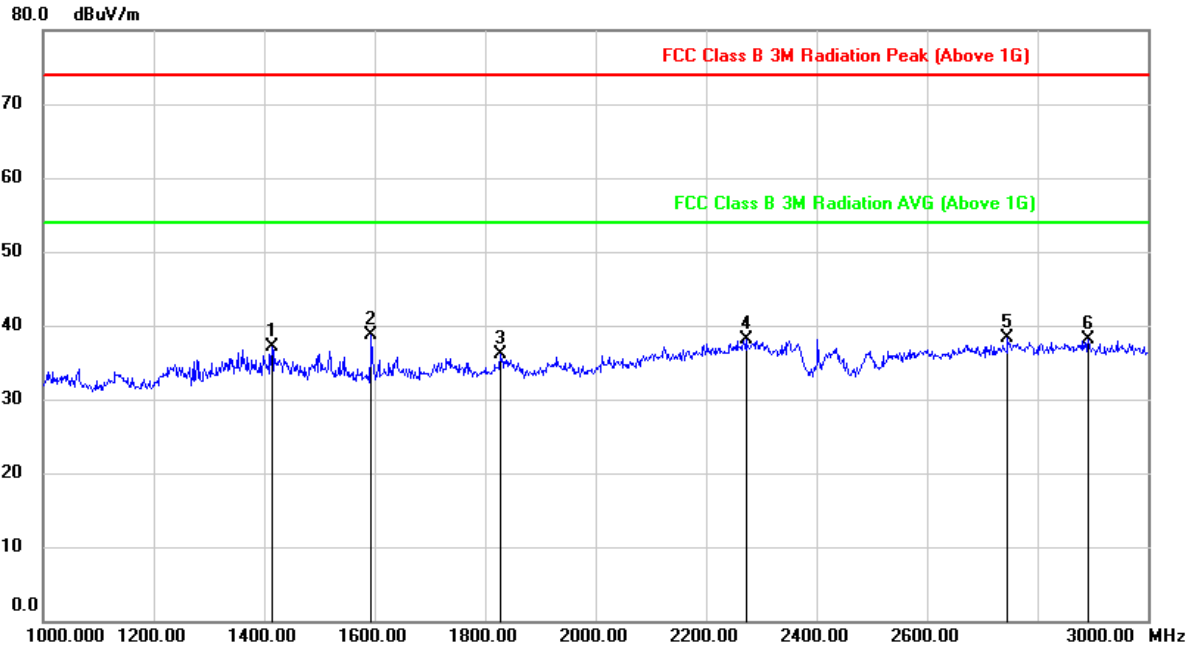

No.	Frequency (MHz)	Reading (dBuV)	Correct (dB/m)	Result (dBuV/m)	Limit (dBuV/m)	Margin (dB)	Remark
1	1414.000	49.13	-12.11	37.02	74.00	-36.98	peak
2	1594.000	50.82	-12.09	38.73	74.00	-35.27	peak
3	1828.000	47.12	-10.99	36.13	74.00	-37.87	peak
4	2272.000	45.67	-7.50	38.17	74.00	-35.83	peak
5	2746.000	45.55	-7.26	38.29	74.00	-35.71	peak
6	2892.000	44.57	-6.55	38.02	74.00	-35.98	peak

Note: 1. Measurement = Reading Level + Correct Factor.
 2. If Peak Result complies with AV limit, AV Result is deemed to comply with AV limit.
 3. Peak: Peak detector.

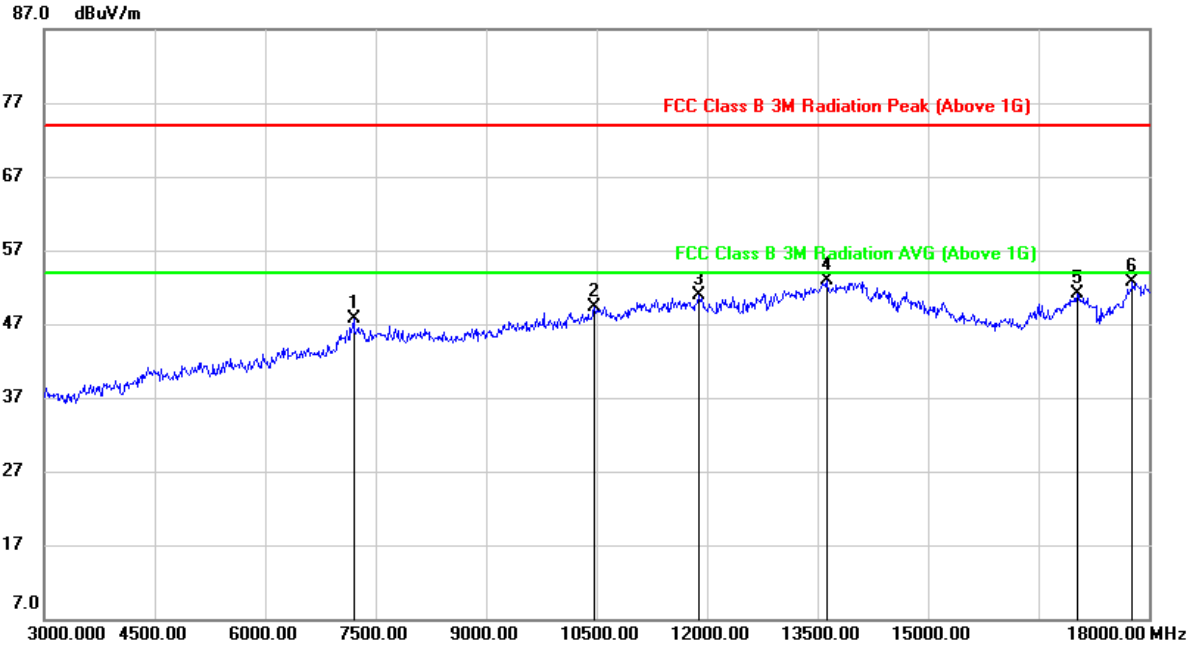

No.	Frequency (MHz)	Reading (dBuV)	Correct (dB/m)	Result (dBuV/m)	Limit (dBuV/m)	Margin (dB)	Remark
1	7200.000	40.04	7.75	47.79	74.00	-26.21	peak
2	10470.000	35.70	13.53	49.23	74.00	-24.77	peak
3	11895.000	33.84	17.04	50.88	74.00	-23.12	peak
4	13620.000	32.42	20.51	52.93	74.00	-21.07	peak
5	17025.000	29.16	22.03	51.19	74.00	-22.81	peak
6	17775.000	26.53	26.17	52.70	74.00	-21.30	peak

Note: 1. Measurement = Reading Level + Correct Factor.
 2. If Peak Result complies with AV limit, AV Result is deemed to comply with AV limit.
 3. Peak: Peak detector.



HARMONICS AND SPURIOUS EMISSIONS (LOW CHANNEL, VERTICAL)

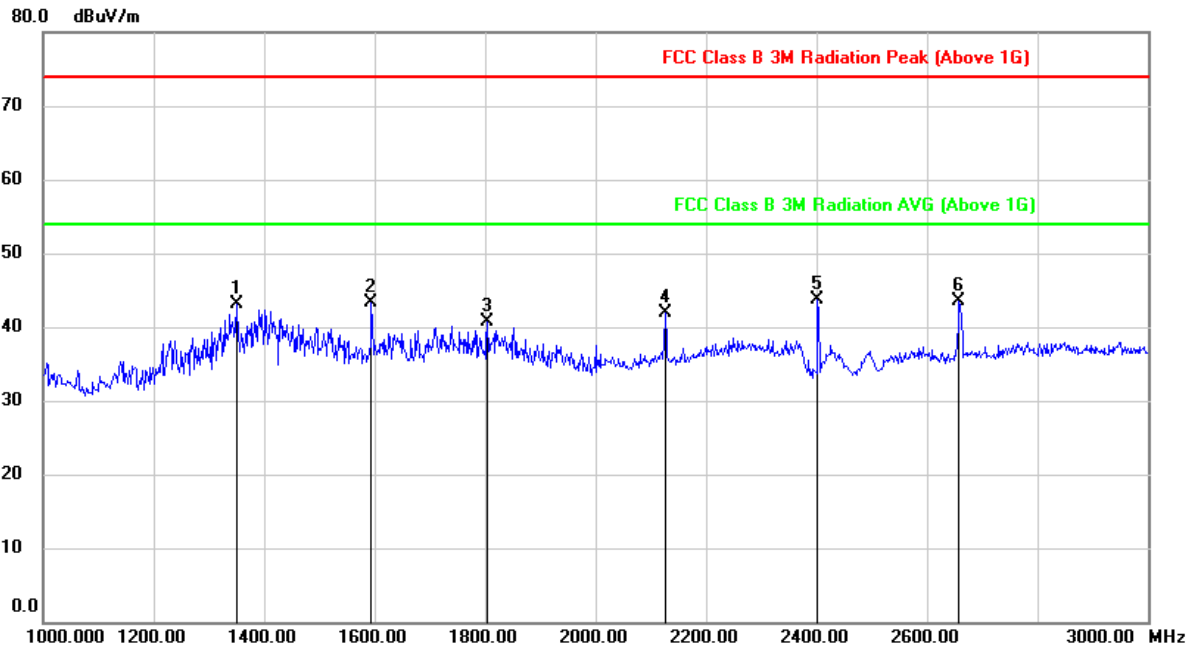

No.	Frequency (MHz)	Reading (dBuV)	Correct (dB/m)	Result (dBuV/m)	Limit (dBuV/m)	Margin (dB)	Remark
1	1350.000	55.40	-12.37	43.03	74.00	-30.97	peak
2	1594.000	55.37	-12.08	43.29	74.00	-30.71	peak
3	1804.000	51.79	-11.11	40.68	74.00	-33.32	peak
4	2126.000	51.17	-9.34	41.83	74.00	-32.17	peak
5	2402.000	51.78	-8.01	43.77	74.00	-30.23	peak
6	2658.000	51.33	-7.90	43.43	74.00	-30.57	peak

- Note: 1. Measurement = Reading Level + Correct Factor.
 2. If Peak Result complies with AV limit, AV Result is deemed to comply with AV limit.
 3. Peak: Peak detector.

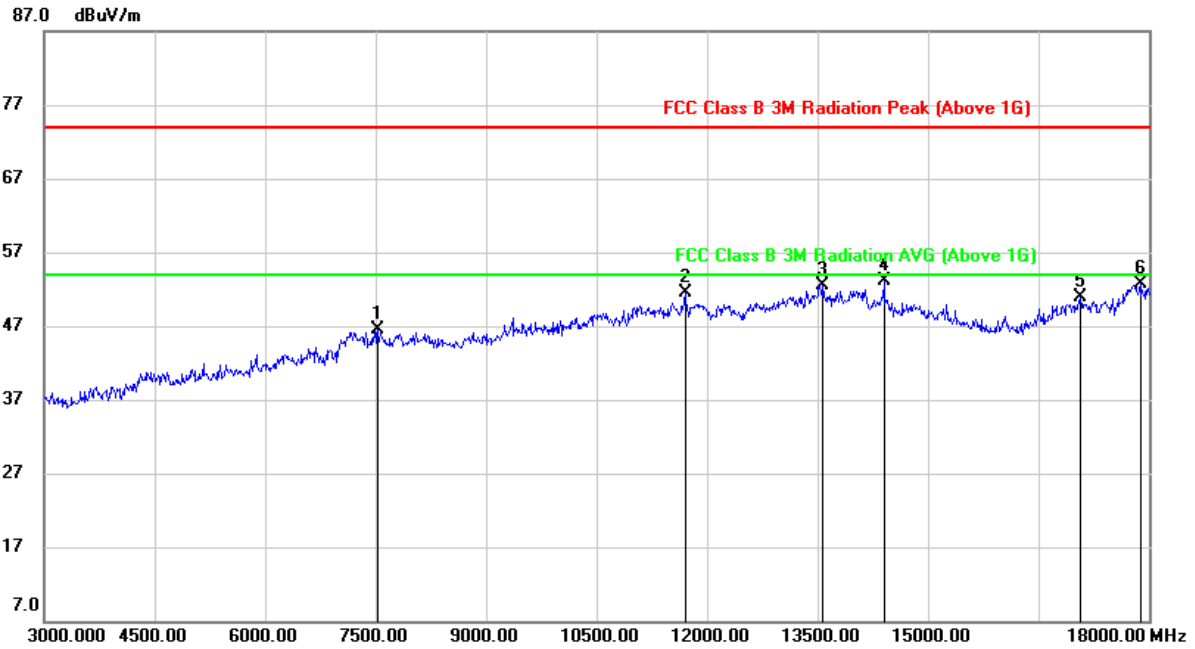

No.	Frequency (MHz)	Reading (dBuV)	Correct (dB/m)	Result (dBuV/m)	Limit (dBuV/m)	Margin (dB)	Remark
1	7530.000	38.13	8.30	46.43	74.00	-27.57	peak
2	11700.000	34.79	16.67	51.46	74.00	-22.54	peak
3	13575.000	31.96	20.63	52.59	74.00	-21.41	peak
4	14400.000	32.80	20.40	53.20	74.00	-20.80	peak
5	17070.000	28.26	22.73	50.99	74.00	-23.01	peak
6	17880.000	26.29	26.34	52.63	74.00	-21.37	peak

Note: 1. Measurement = Reading Level + Correct Factor.
 2. If Peak Result complies with AV limit, AV Result is deemed to comply with AV limit.
 3. Peak: Peak detector.



HARMONICS AND SPURIOUS EMISSIONS (MID CHANNEL, HORIZONTAL)

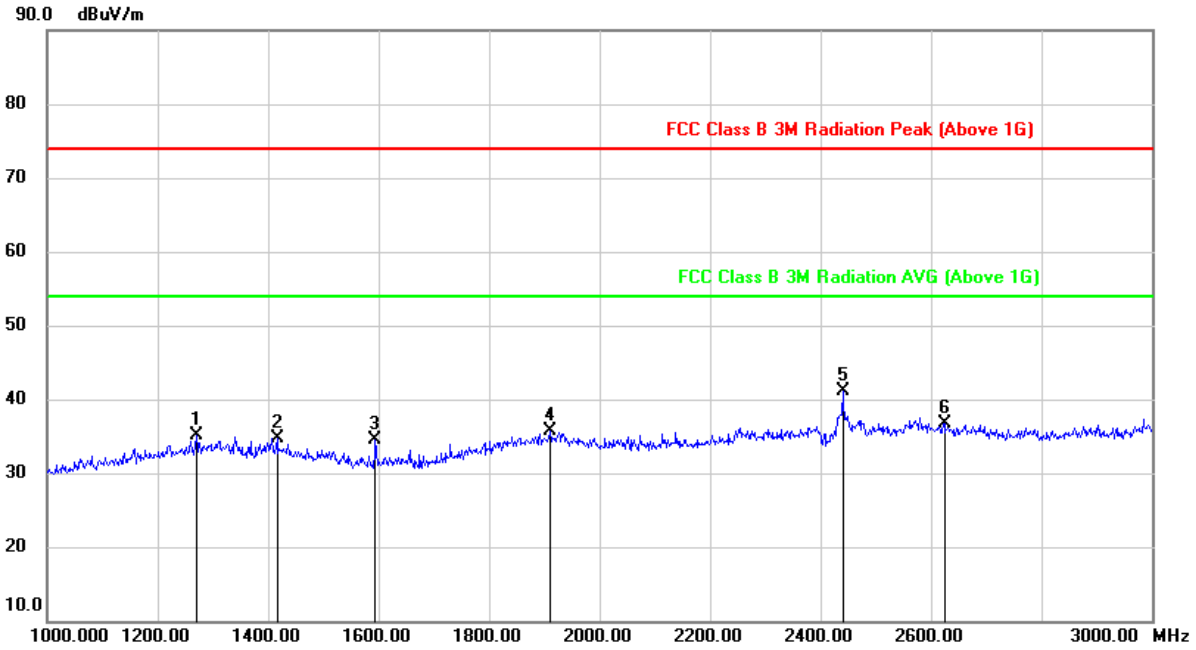

No.	Frequency (MHz)	Reading (dBuV)	Correct (dB/m)	Result (dBuV/m)	Limit (dBuV/m)	Margin (dB)	Remark
1	1270.000	47.79	-12.66	35.13	74.00	-38.87	peak
2	1416.000	46.78	-12.13	34.65	74.00	-39.35	peak
3	1594.000	46.57	-12.09	34.48	74.00	-39.52	peak
4	1910.000	46.38	-10.73	35.65	74.00	-38.35	peak
5	2440.000	49.39	-8.30	41.09	74.00	-32.91	peak
6	2624.000	44.64	-7.99	36.65	74.00	-37.35	peak

- Note: 1. Measurement = Reading Level + Correct Factor.
 2. If Peak Result complies with AV limit, AV Result is deemed to comply with AV limit.
 3. Peak: Peak detector.

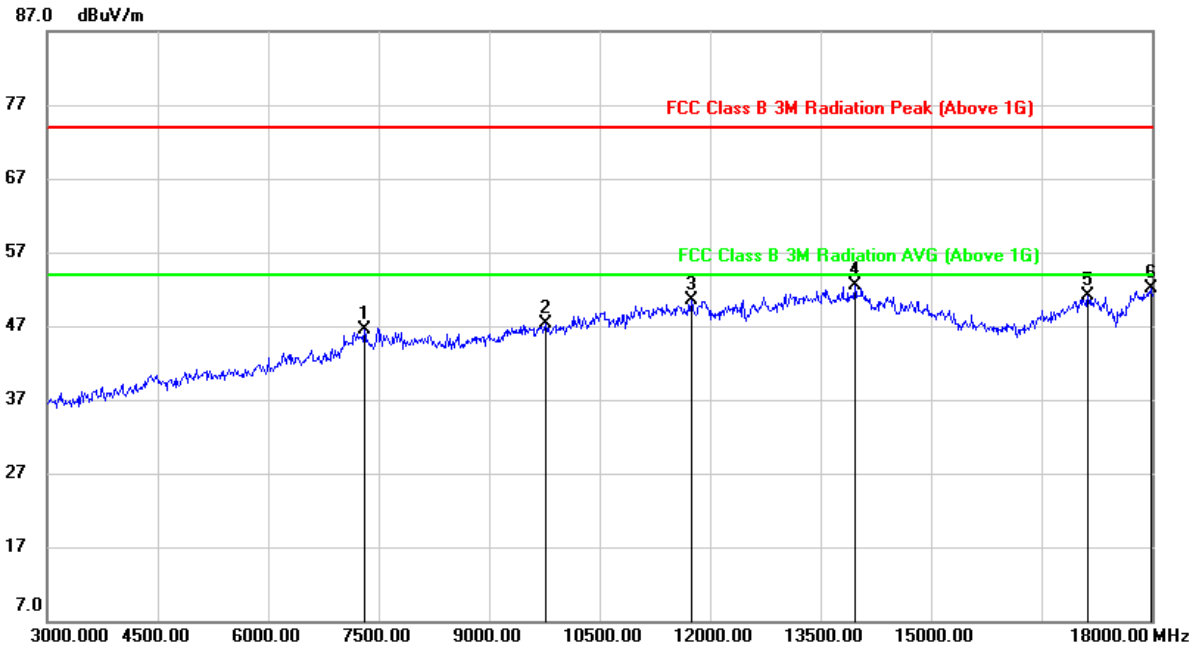

No.	Frequency (MHz)	Reading (dBuV)	Correct (dB/m)	Result (dBuV/m)	Limit (dBuV/m)	Margin (dB)	Remark
1	7305.000	38.65	7.80	46.45	74.00	-27.55	peak
2	9765.000	35.62	11.61	47.23	74.00	-26.77	peak
3	11745.000	34.06	16.49	50.55	74.00	-23.45	peak
4	13965.000	31.80	20.66	52.46	74.00	-21.54	peak
5	17130.000	28.68	22.50	51.18	74.00	-22.82	peak
6	17985.000	24.99	27.05	52.04	74.00	-21.96	peak

Note: 1. Measurement = Reading Level + Correct Factor.
 2. If Peak Result complies with AV limit, AV Result is deemed to comply with AV limit.
 3. Peak: Peak detector.



HARMONICS AND SPURIOUS EMISSIONS (MID CHANNEL, VERTICAL)

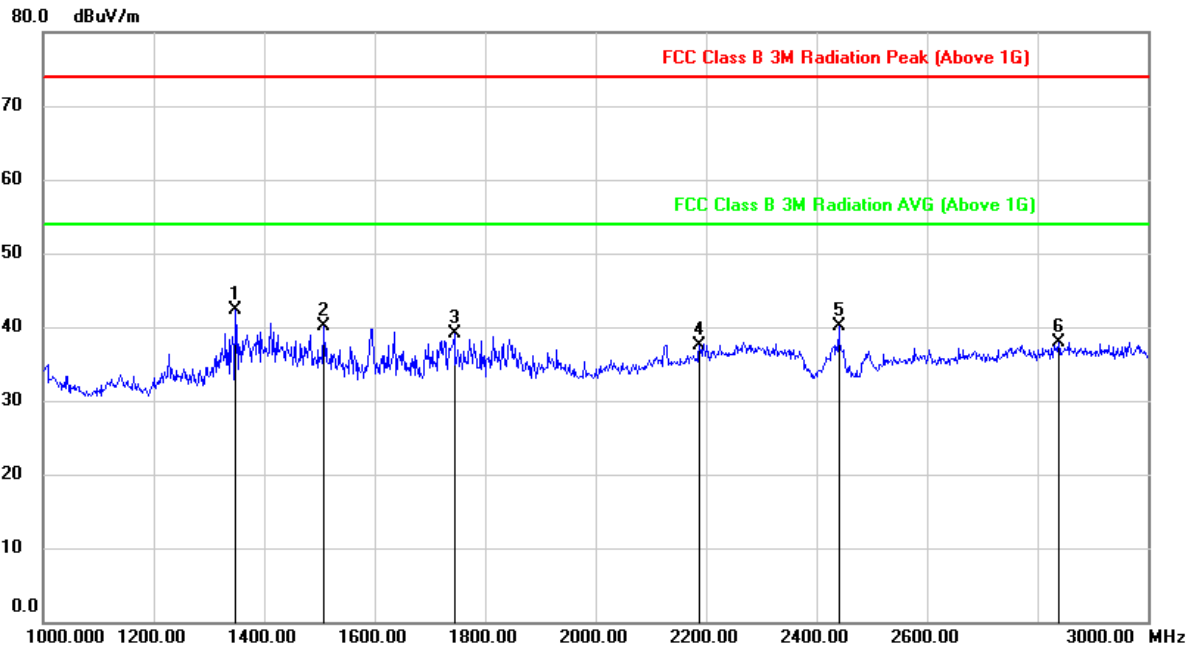

No.	Frequency (MHz)	Reading (dBuV)	Correct (dB/m)	Result (dBuV/m)	Limit (dBuV/m)	Margin (dB)	Remark
1	1348.000	54.61	-12.38	42.23	74.00	-31.77	peak
2	1508.000	52.46	-12.28	40.18	74.00	-33.82	peak
3	1744.000	50.50	-11.30	39.20	74.00	-34.80	peak
4	2188.000	46.05	-8.47	37.58	74.00	-36.42	peak
5	2440.000	48.31	-8.20	40.11	74.00	-33.89	peak
6	2838.000	44.71	-6.75	37.96	74.00	-36.04	peak

Note: 1. Measurement = Reading Level + Correct Factor.
 2. If Peak Result complies with AV limit, AV Result is deemed to comply with AV limit.
 3. Peak: Peak detector.

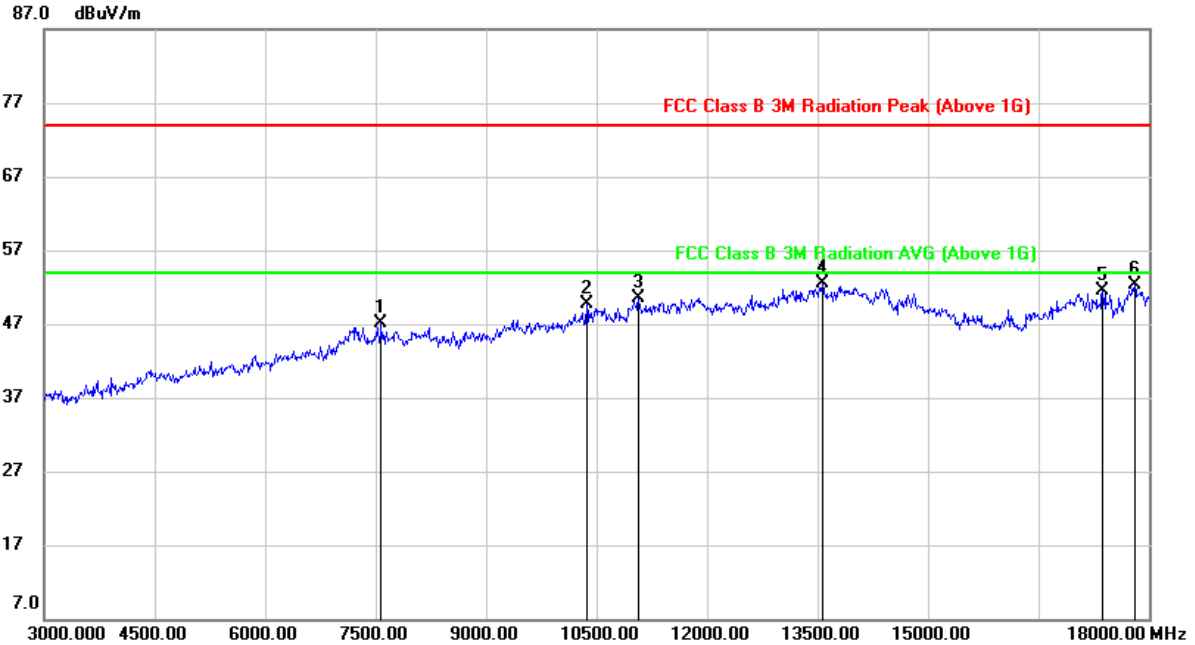

No.	Frequency (MHz)	Reading (dBuV)	Correct (dB/m)	Result (dBuV/m)	Limit (dBuV/m)	Margin (dB)	Remark
1	7575.000	38.96	8.17	47.13	74.00	-26.87	peak
2	10365.000	36.84	12.94	49.78	74.00	-24.22	peak
3	11070.000	35.69	14.91	50.60	74.00	-23.40	peak
4	13560.000	31.77	20.81	52.58	74.00	-21.42	peak
5	17370.000	28.12	23.35	51.47	74.00	-22.53	peak
6	17805.000	25.59	26.80	52.39	74.00	-21.61	peak

Note: 1. Measurement = Reading Level + Correct Factor.
 2. If Peak Result complies with AV limit, AV Result is deemed to comply with AV limit.
 3. Peak: Peak detector.



HARMONICS AND SPURIOUS EMISSIONS (HIGH CHANNEL, HORIZONTAL)

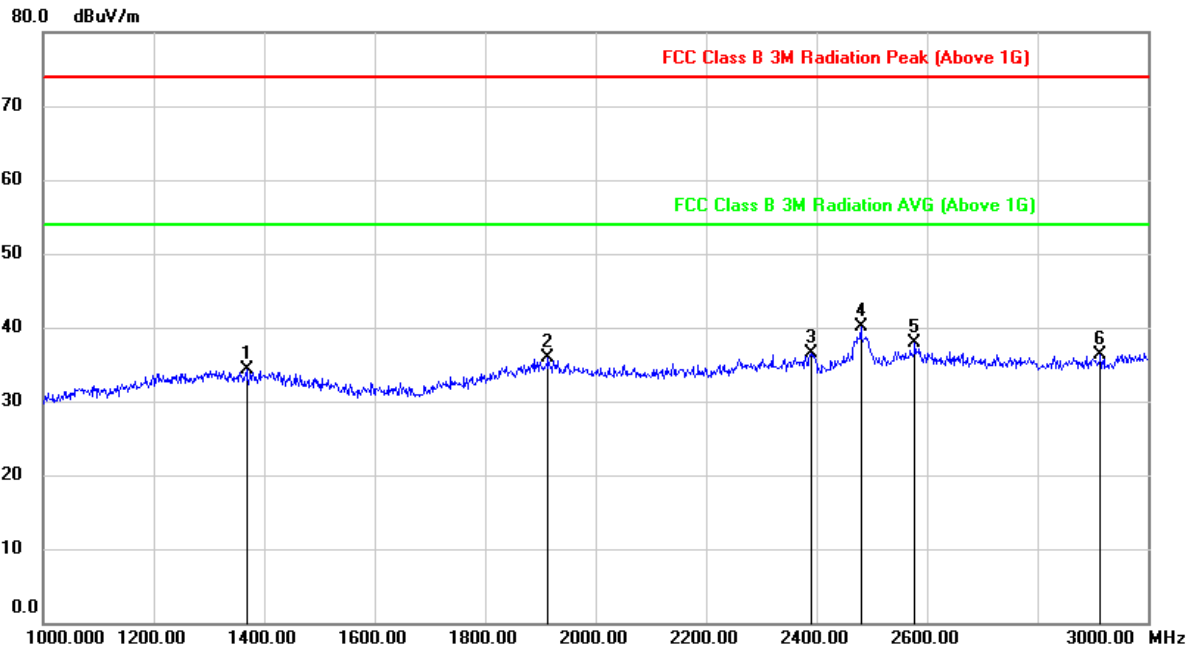

No.	Frequency (MHz)	Reading (dBuV)	Correct (dB/m)	Result (dBuV/m)	Limit (dBuV/m)	Margin (dB)	Remark
1	1368.000	46.60	-12.27	34.33	74.00	-39.67	peak
2	1914.000	46.71	-10.72	35.99	74.00	-38.01	peak
3	2390.000	44.51	-8.03	36.48	74.00	-37.52	peak
4	2480.000	48.43	-8.38	40.05	74.00	-33.95	peak
5	2578.000	46.16	-8.22	37.94	74.00	-36.06	peak
6	2914.000	42.90	-6.54	36.36	74.00	-37.64	peak

Note: 1. Measurement = Reading Level + Correct Factor.
 2. If Peak Result complies with AV limit, AV Result is deemed to comply with AV limit.
 3. Peak: Peak detector.

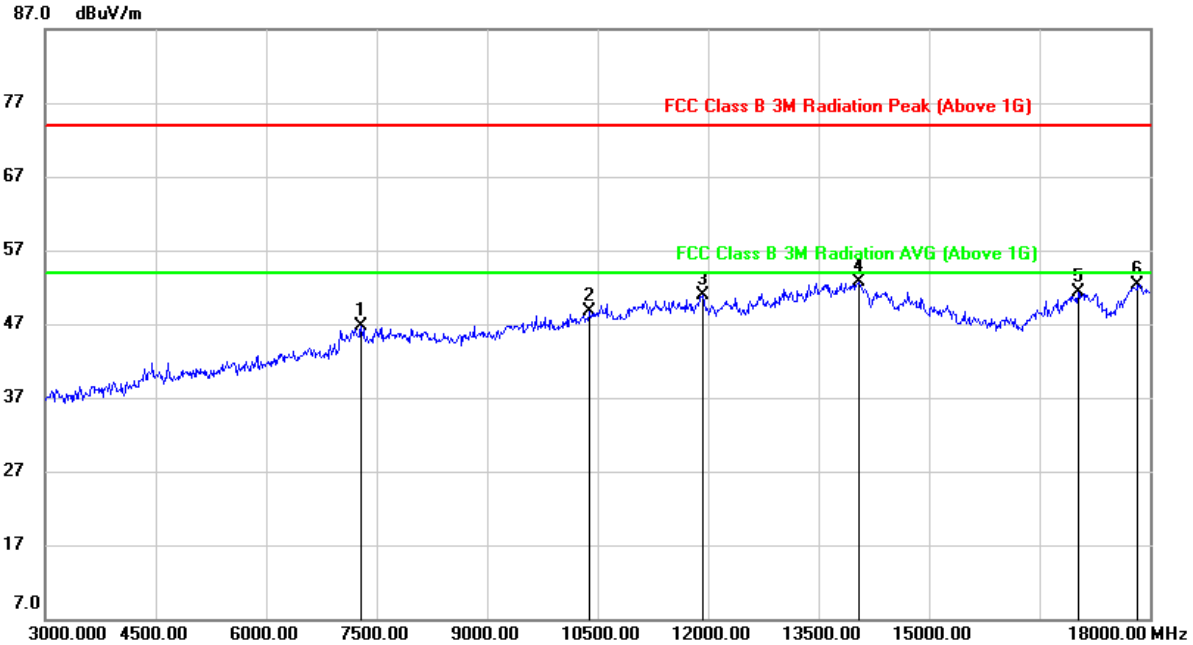

No.	Frequency (MHz)	Reading (dBuV)	Correct (dB/m)	Result (dBuV/m)	Limit (dBuV/m)	Margin (dB)	Remark
1	7290.000	38.89	7.86	46.75	74.00	-27.25	peak
2	10395.000	35.60	13.06	48.66	74.00	-25.34	peak
3	11925.000	34.07	16.74	50.81	74.00	-23.19	peak
4	14040.000	32.12	20.64	52.76	74.00	-21.24	peak
5	17025.000	29.33	22.03	51.36	74.00	-22.64	peak
6	17835.000	25.84	26.49	52.33	74.00	-21.67	peak

Note: 1. Measurement = Reading Level + Correct Factor.
 2. If Peak Result complies with AV limit, AV Result is deemed to comply with AV limit.
 3. Peak: Peak detector.



HARMONICS AND SPURIOUS EMISSIONS (HIGH CHANNEL, VERTICAL)

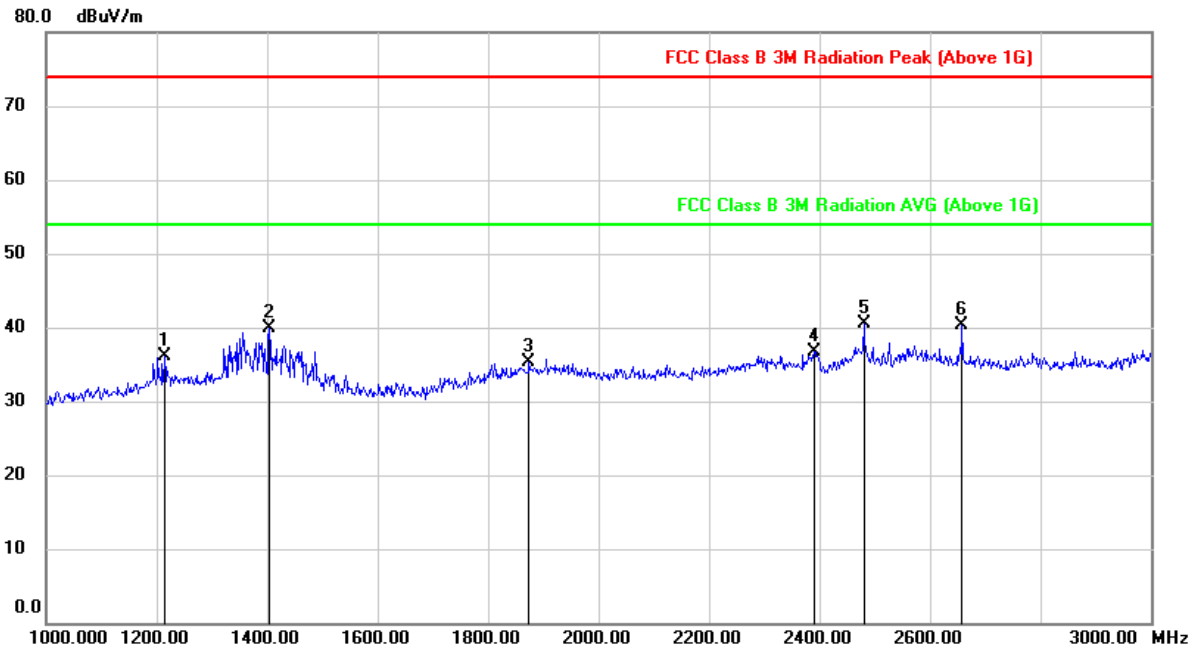

No.	Frequency (MHz)	Reading (dBuV)	Correct (dB/m)	Result (dBuV/m)	Limit (dBuV/m)	Margin (dB)	Remark
1	1214.000	49.12	-13.05	36.07	74.00	-37.93	peak
2	1404.000	52.26	-12.44	39.82	74.00	-34.18	peak
3	1874.000	46.19	-10.87	35.32	74.00	-38.68	peak
4	2390.000	44.67	-7.93	36.74	74.00	-37.26	peak
5	2480.000	48.88	-8.28	40.60	74.00	-33.40	peak
6	2658.000	48.18	-7.90	40.28	74.00	-33.72	peak

- Note: 1. Measurement = Reading Level + Correct Factor.
 2. If Peak Result complies with AV limit, AV Result is deemed to comply with AV limit.
 3. Peak: Peak detector.

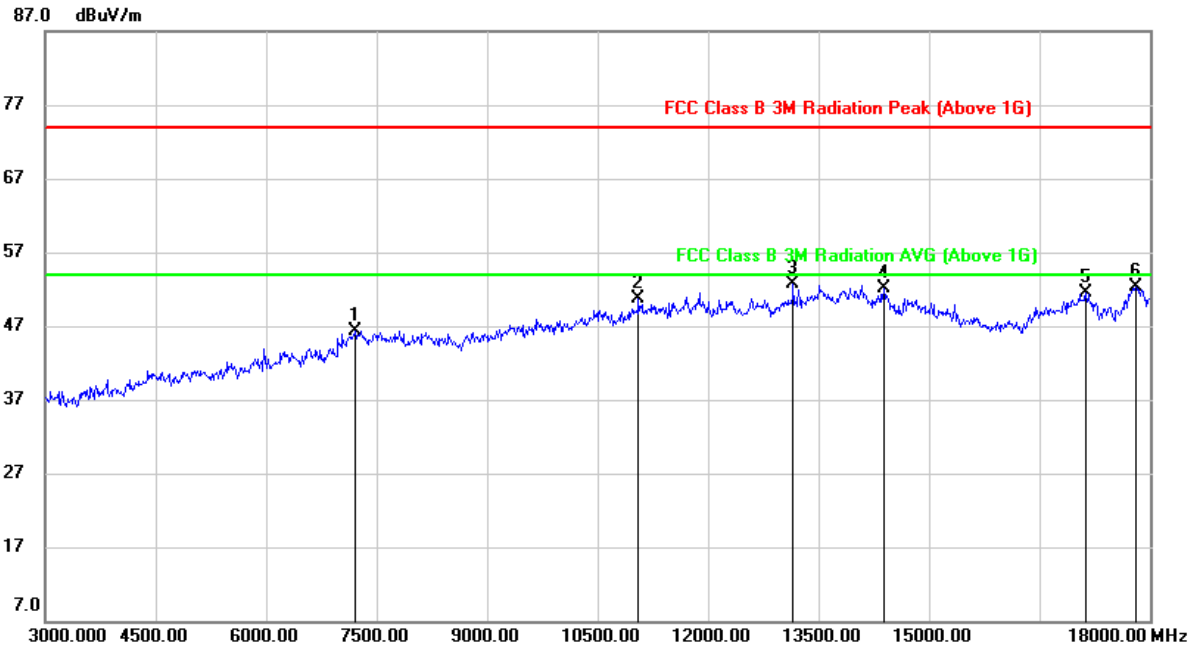

No.	Frequency (MHz)	Reading (dBuV)	Correct (dB/m)	Result (dBuV/m)	Limit (dBuV/m)	Margin (dB)	Remark
1	7215.000	38.52	7.82	46.34	74.00	-27.66	peak
2	11055.000	35.84	14.87	50.71	74.00	-23.29	peak
3	13155.000	33.83	18.83	52.66	74.00	-21.34	peak
4	14385.000	31.77	20.37	52.14	74.00	-21.86	peak
5	17130.000	28.68	22.86	51.54	74.00	-22.46	peak
6	17805.000	25.48	26.80	52.28	74.00	-21.72	peak

- Note: 1. Measurement = Reading Level + Correct Factor.
 2. If Peak Result complies with AV limit, AV Result is deemed to comply with AV limit.
 3. Peak: Peak detector.



8.3. SPURIOUS EMISSIONS 18G ~ 26GHz

SPURIOUS EMISSIONS (MID CHANNEL, WORST-CASE CONFIGURATION, HORIZONTAL)

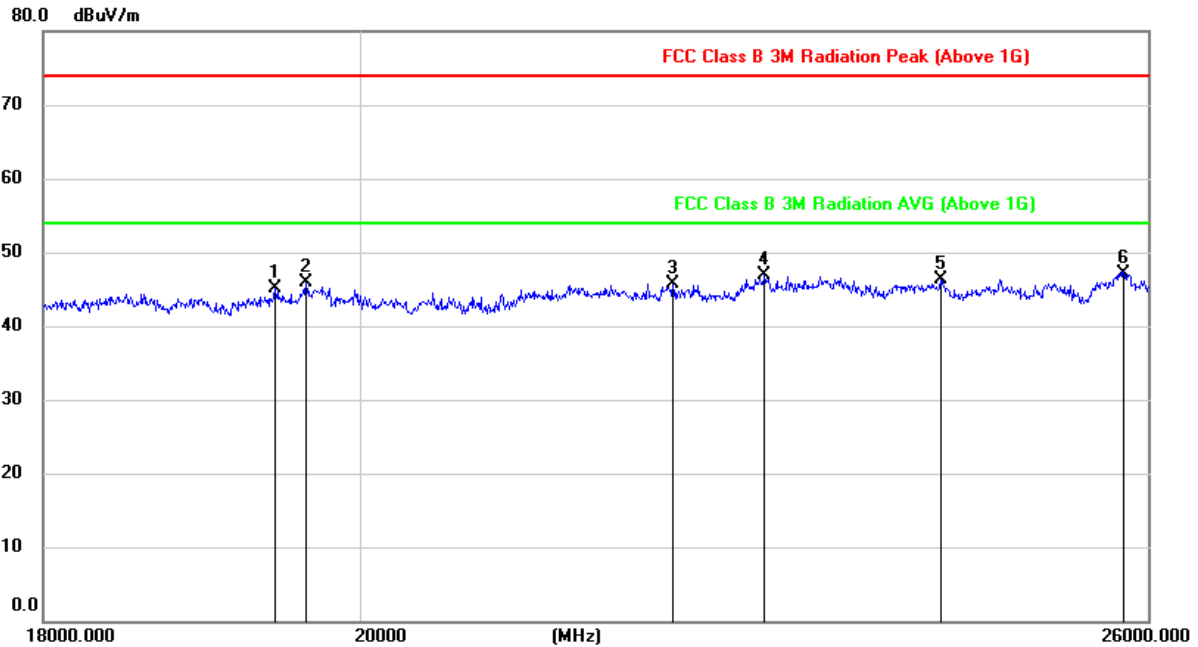

No.	Frequency (MHz)	Reading (dBuV)	Correct (dB/m)	Result (dBuV/m)	Limit (dBuV/m)	Margin (dB)	Remark
1	19445.078	50.59	-5.56	45.03	74.00	-28.97	peak
2	19646.324	51.36	-5.38	45.98	74.00	-28.02	peak
3	22197.394	49.99	-4.27	45.72	74.00	-28.28	peak
4	22885.329	50.42	-3.55	46.87	74.00	-27.13	peak
5	24263.284	49.11	-2.81	46.30	74.00	-27.70	peak
6	25781.028	47.74	-0.66	47.08	74.00	-26.92	peak

Note: 1. Measurement = Reading Level + Correct Factor.

2. If Peak Result complies with AV limit, AV Result is deemed to comply with AV limit.



SPURIOUS EMISSIONS (MID CHANNEL, WORST-CASE CONFIGURATION, VERTICAL)

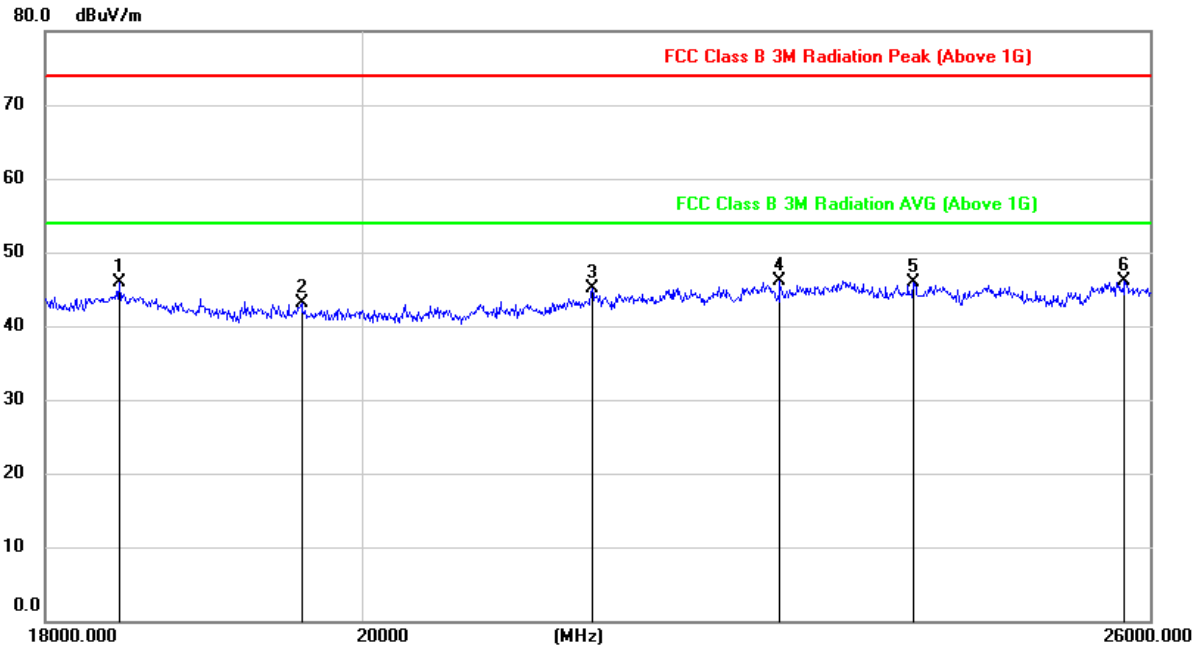

No.	Frequency (MHz)	Reading (dBuV)	Correct (dB/m)	Result (dBuV/m)	Limit (dBuV/m)	Margin (dB)	Remark
1	18448.984	51.27	-5.32	45.95	74.00	-28.05	peak
2	19603.025	48.57	-5.43	43.14	74.00	-30.86	peak
3	21593.569	49.65	-4.55	45.10	74.00	-28.90	peak
4	22986.538	49.62	-3.45	46.17	74.00	-27.83	peak
5	24032.412	48.62	-2.75	45.87	74.00	-28.13	peak
6	25781.028	46.85	-0.66	46.19	74.00	-27.81	peak

Note: 1. Measurement = Reading Level + Correct Factor.

2. If Peak Result complies with AV limit, AV Result is deemed to comply with AV limit.



8.4. SPURIOUS EMISSIONS 30M ~ 1 GHz

SPURIOUS EMISSIONS (MID CHANNEL, WORST-CASE CONFIGURATION, HORIZONTAL)

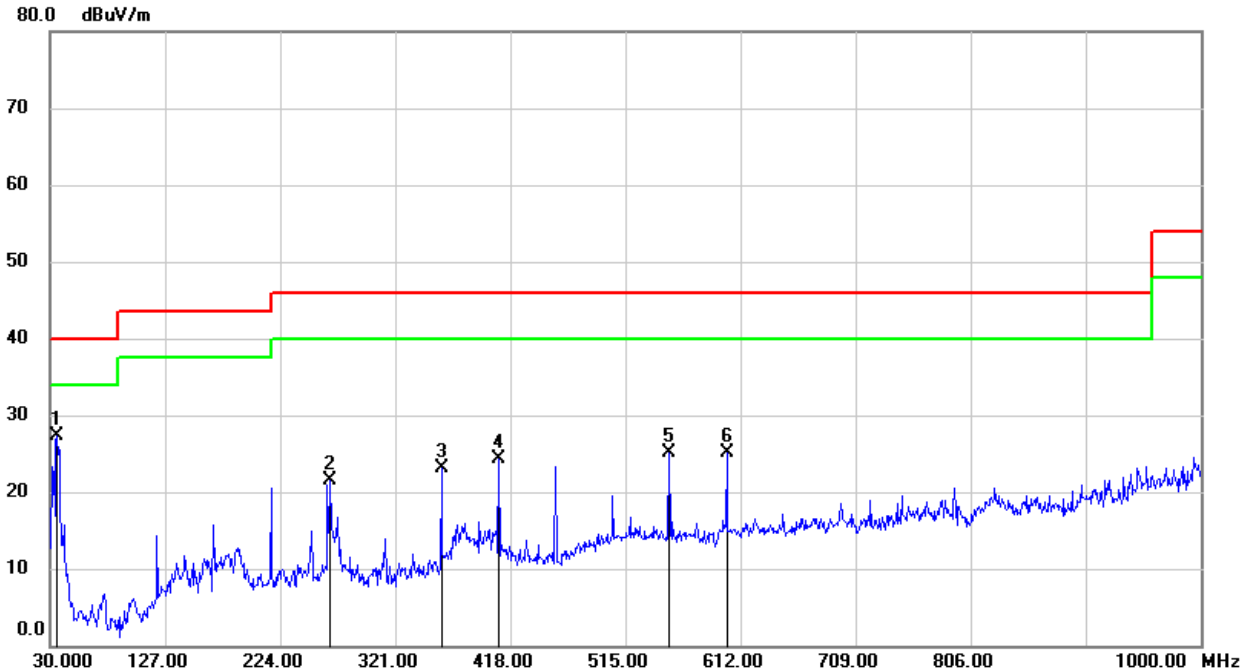

No.	Frequency (MHz)	Reading (dBuV)	Correct (dB/m)	Result (dBuV/m)	Limit (dBuV/m)	Margin (dB)	Remark
1	35.8200	45.59	-18.38	27.21	40.00	-12.79	peak
2	265.7100	38.25	-16.73	21.52	46.00	-24.48	peak
3	359.8000	37.54	-14.41	23.13	46.00	-22.87	peak
4	408.3000	37.54	-13.22	24.32	46.00	-21.68	peak
5	551.8600	35.46	-10.36	25.10	46.00	-20.90	peak
6	600.3600	34.02	-8.95	25.07	46.00	-20.93	peak

- Note: 1. Result Level = Read Level + Correct Factor.
 2. If Peak Result complies with QP limit, QP Result is deemed to comply with QP limit.
 3. Test setup: RBW: 120 kHz, VBW: 300 kHz, Sweep time: auto.



SPURIOUS EMISSIONS (MID CHANNEL, WORST-CASE CONFIGURATION, VERTICAL)

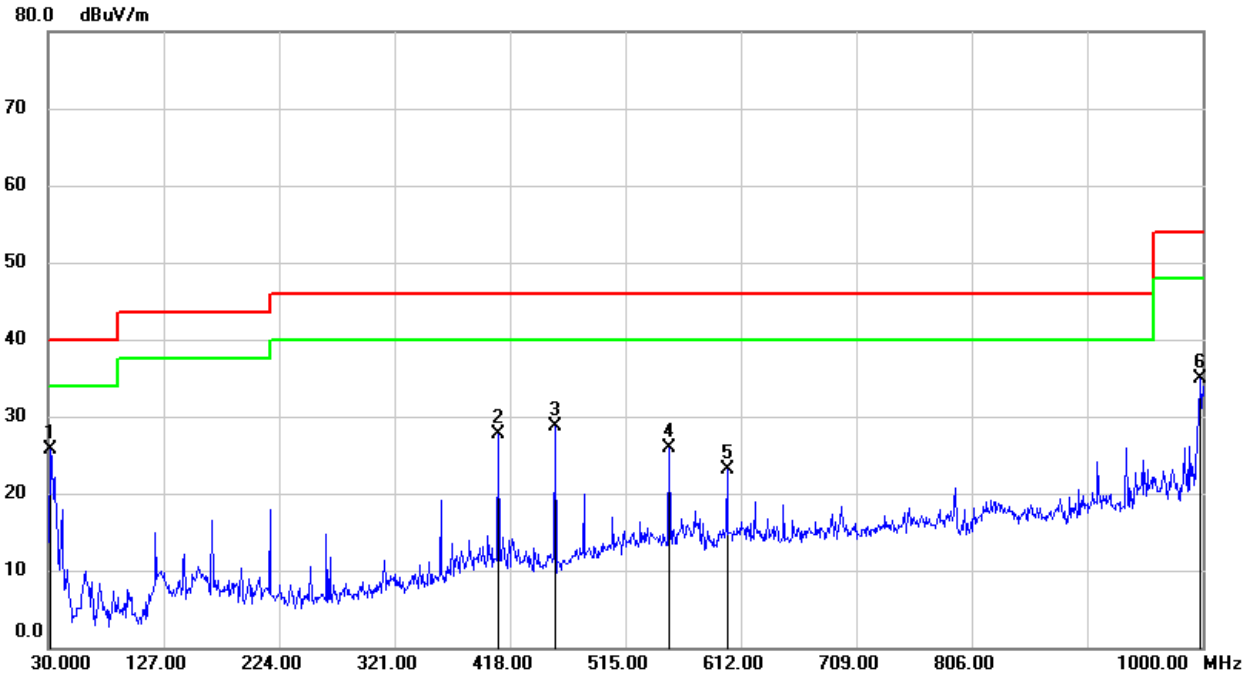

No.	Frequency (MHz)	Reading (dBuV)	Correct (dB/m)	Result (dBuV/m)	Limit (dBuV/m)	Margin (dB)	Remark
1	31.9400	43.82	-18.13	25.69	40.00	-14.31	peak
2	408.3000	40.89	-13.22	27.67	46.00	-18.33	peak
3	455.8300	41.69	-13.01	28.68	46.00	-17.32	peak
4	551.8600	36.18	-10.36	25.82	46.00	-20.18	peak
5	600.3600	32.11	-8.95	23.16	46.00	-22.84	peak
6	998.0600	38.73	-3.92	34.81	54.00	-19.19	peak

- Note: 1. Result Level = Read Level + Correct Factor.
 2. If Peak Result complies with QP limit, QP Result is deemed to comply with QP limit.
 3. Test setup: RBW: 120 kHz, VBW: 300 kHz, Sweep time: auto



8.5. SPURIOUS EMISSIONS BELOW 30M

SPURIOUS EMISSIONS (MID CHANNEL, WORST-CASE CONFIGURATION, VERTICAL)

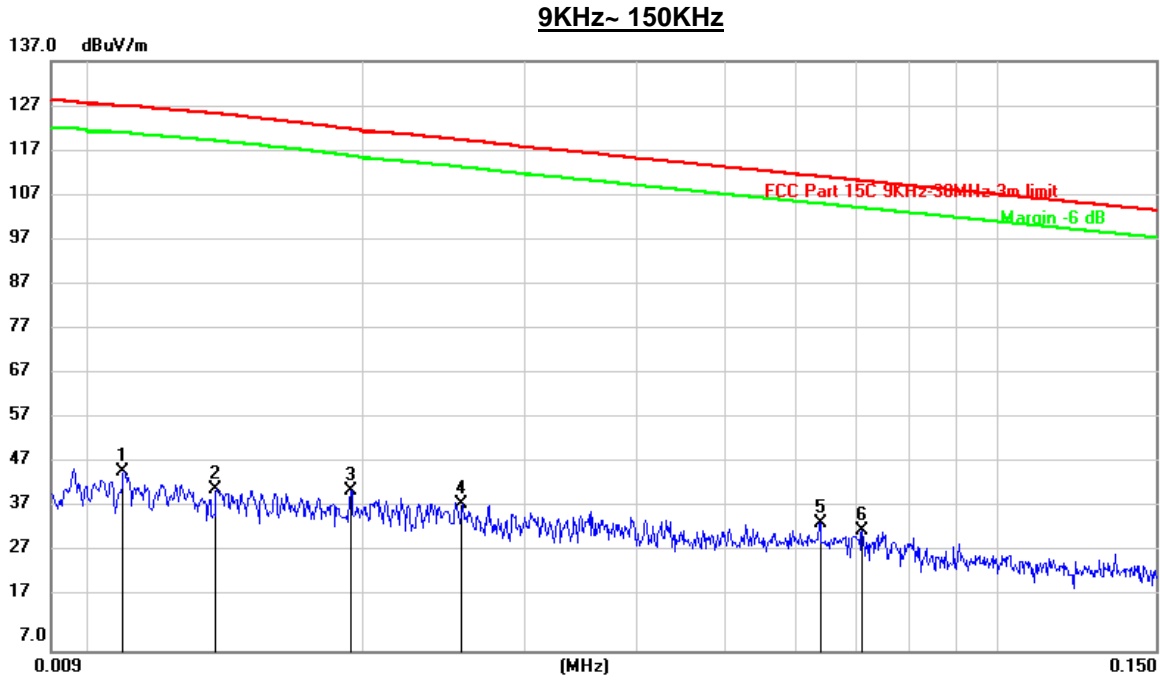

No.	Frequency (MHz)	Reading (dBuV)	Correct (dB/m)	Result (dBuV/m)	Limit (dBuV/m)	Margin (dB)	Remark
1	0.0108	26.24	20.22	46.46	127.12	-80.66	peak
2	0.0137	22.26	20.25	42.51	125.37	-82.86	peak
3	0.0193	21.96	20.30	42.26	122.00	-79.74	peak
4	0.0256	19.10	20.31	39.41	119.61	-80.20	peak
5	0.0637	14.88	20.31	35.19	111.54	-76.35	peak
6	0.0709	13.21	20.31	33.52	110.60	-77.08	peak

Note: 1. Measurement = Reading Level + Correct Factor.
 2. If Peak Result complies with AV and QP limit, AV and QP Result are deemed to comply with AV limit.



150KHz ~ 30M

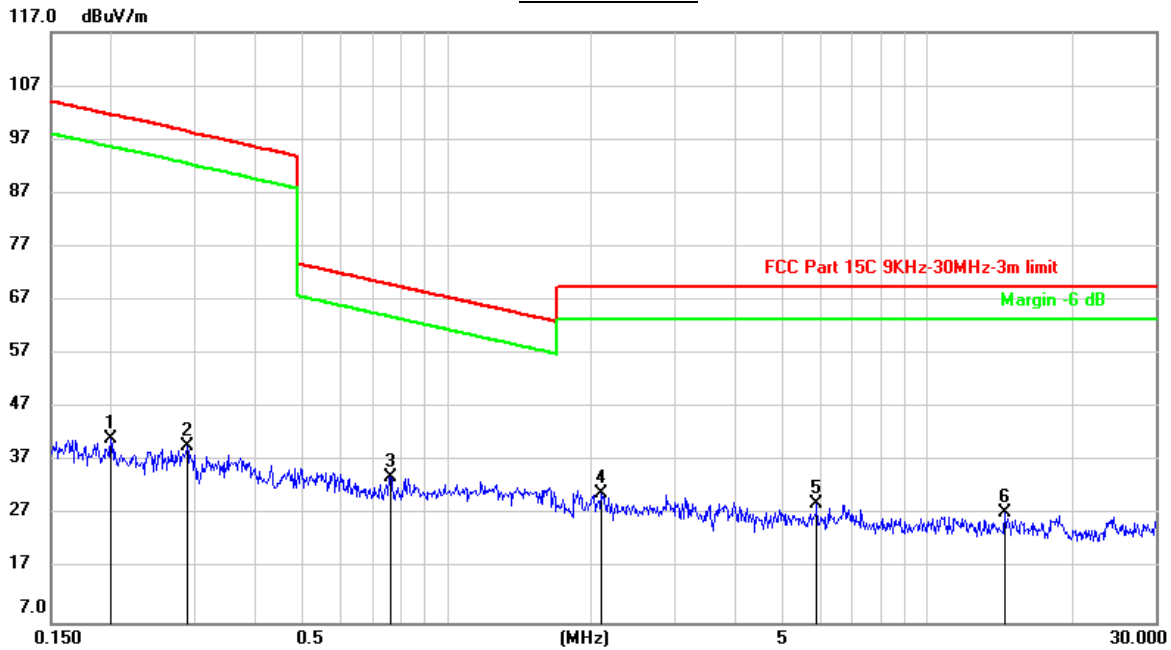

No.	Frequency (MHz)	Reading (dBuV)	Correct (dB/m)	Result (dBuV/m)	Limit (dBuV/m)	Margin (dB)	Remark
1	0.1995	20.85	20.37	41.22	101.60	-60.38	peak
2	0.2878	19.66	20.31	39.97	98.49	-58.52	peak
3	0.7630	13.66	20.36	34.02	69.97	-35.95	peak
4	2.0989	10.24	20.75	30.99	69.54	-38.55	peak
5	5.8978	8.18	20.87	29.05	69.54	-40.49	peak
6	14.5168	6.50	20.94	27.44	69.54	-42.10	peak

Note: 1. Measurement = Reading Level + Correct Factor.

2. If Peak Result complies with AV and QP limit, AV and QP Result are deemed to comply with AV limit.



SPURIOUS EMISSIONS (MID CHANNEL, WORST-CASE CONFIGURATION, HORIZONTAL)

9KHz~ 150KHz

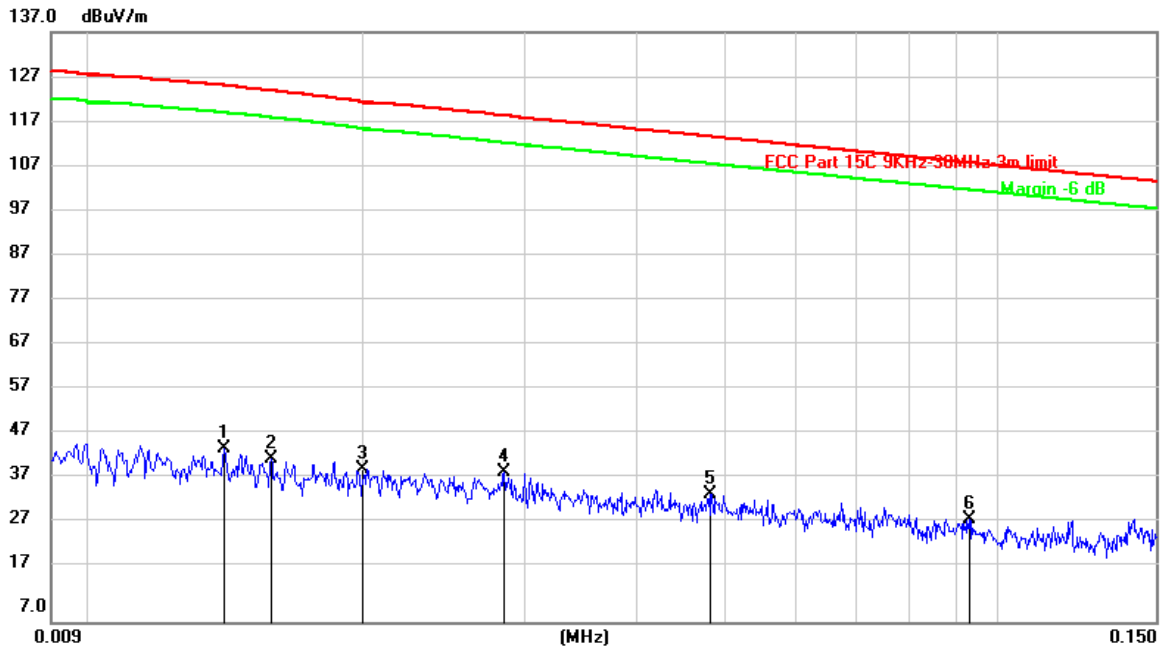

No.	Frequency (MHz)	Reading (dBuV)	Correct (dB/m)	Result (dBuV/m)	Limit (dBuV/m)	Margin (dB)	Remark
1	0.0140	24.97	20.25	45.22	125.19	-79.97	peak
2	0.0158	22.56	20.27	42.83	124.11	-81.28	peak
3	0.0200	20.30	20.31	40.61	121.58	-80.97	peak
4	0.0285	19.56	20.31	39.87	118.59	-78.72	peak
5	0.0483	14.90	20.31	35.21	113.95	-78.74	peak
6	0.0932	9.23	20.25	29.48	108.23	-78.75	peak

Note: 1. Measurement = Reading Level + Correct Factor.

2. If Peak Result complies with AV and QP limit, AV and QP Result are deemed to comply with AV limit.



150KHz ~ 30M

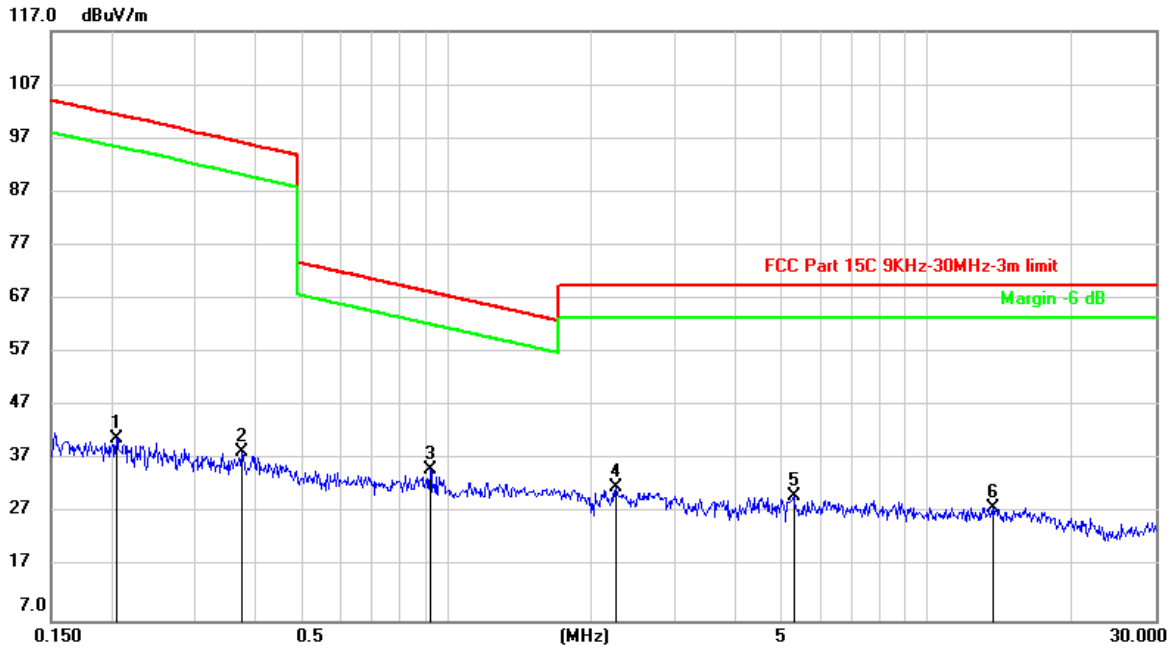

No.	Frequency (MHz)	Reading (dBuV)	Correct (dB/m)	Result (dBuV/m)	Limit (dBuV/m)	Margin (dB)	Remark
1	0.2048	20.70	20.36	41.06	101.41	-60.35	peak
2	0.3729	18.11	20.28	38.39	96.24	-57.85	peak
3	0.9233	14.82	20.37	35.19	68.31	-33.12	peak
4	2.2486	11.05	20.77	31.82	69.54	-37.72	peak
5	5.2770	9.41	20.84	30.25	69.54	-39.29	peak
6	13.6951	7.18	20.96	28.14	69.54	-41.40	peak

Note: 1. Measurement = Reading Level + Correct Factor.

2. If Peak Result complies with AV and QP limit, AV and QP Result are deemed to comply with AV limit.

9. AC POWER LINE CONDUCTED EMISSIONS

LIMITS

Please refer to FCC §15.207 (a)

FREQUENCY (MHz)	Class A (dBuV)		Class B (dBuV)	
	Quasi-peak	Average	Quasi-peak	Average
0.15 -0.5	79.00	66.00	66 - 56 *	56 - 46 *
0.50 -5.0	73.00	60.00	56.00	46.00
5.0 -30.0	73.00	60.00	60.00	50.00

TEST SETUP AND PROCEDURE

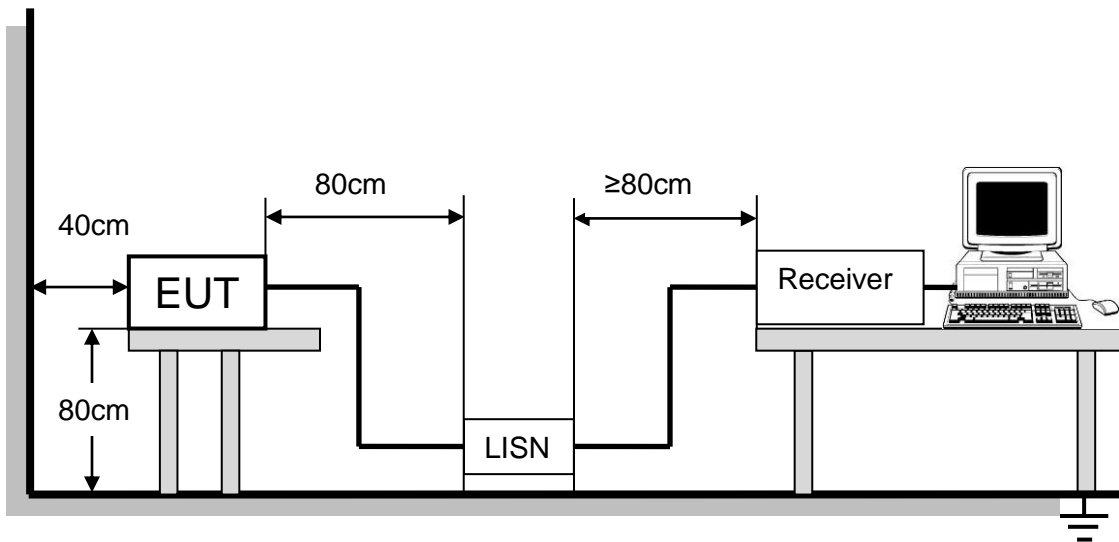

The EUT is put on a table of non-conducting material that is 0.8m high. The vertical conducting wall of shielding is located 40cm to the rear of the EUT. The power line of the EUT is connected to the AC mains through an Artificial Mains Network (A.M.N.). An EMI Measurement Receiver (R&S Test Receiver ESR3) is used to test the emissions from both sides of AC line. According to the requirements in Section 6.2 of ANSI C63.10-2013, Conducted emissions from the EUT measured in the frequency range between 0.15 MHz and 30MHz using CISPR Quasi-Peak and average detector mode. The bandwidth of EMI test receiver is set at 9kHz.

The arrangement of the equipment is installed to meet the standards and operating in a manner, which tends to maximize its emission characteristics in a normal application.



TEST RESULTS

Note Applicable.

Note: The EUT was used in vehicle environment.



10. ANTENNA REQUIREMENTS

Applicable requirements

Please refer to FCC §15.203

An intentional radiator shall be designed to ensure that no antenna other than that furnished by the responsible party shall be used with the device. The use of a permanently attached antenna or of an antenna that uses a unique coupling to the intentional radiator shall be considered sufficient to comply with the provisions of this section. The manufacturer may design the unit so that a broken antenna can be replaced by the user, but the use of a standard antenna jack or electrical connector is prohibited.

Please refer to FCC §15.247(b)(4)

The conducted output power limit specified in paragraph (b) of this section is based on the use of antennas with directional gains that do not exceed 6 dBi. Except as shown in paragraph (c) of this section, if transmitting antennas of directional gain greater than 6 dBi are used, the conducted output power from the intentional radiator shall be reduced below the stated values in paragraphs (b)(1), (b)(2), and (b)(3) of this section, as appropriate, by the amount in dB that the directional gain of the antenna exceeds 6 dBi.

Antenna Connector

EUT has a FPCB antenna without antenna connector.

Antenna Gain

The antenna gain of EUT is less than 6 dBi.

END OF REPORT