



**SGS-CSTC Standards Technical Services Co., Ltd.
Shenzhen Branch**

No. 1 Workshop, M-10, Middle section, Science & Technology Park,
Shenzhen, Guangdong, China 518057

Telephone: +86 (0) 755 2601 2053
Fax: +86 (0) 755 2671 0594
Email: ee.shenzhen@sgs.com

Report No.: SZEM180500461703
Page: 1 of 41

TEST REPORT

Application No.: SZEM1805004617CR
Applicant: NEXT SUCCESS INC.
Address of Applicant: PO BOX 3202, CHAMPLAIN, New York 12919, United States
Manufacturer: Mercedes-Benz Accessories GmbH
Address of Manufacturer: HPC Z 402, Am Wallgraben 125, 70565 Stuttgart, Germany
Equipment Under Test (EUT):
EUT Name: Classic 300SL Computermice
Model No.: B66041625, B66041488 ♣
 ♣ Please refer to section 2 of this report which indicates which model was actually tested and which were electrically identical.
FCC ID: 2AP36-660479
Standard(s) : 47 CFR Part 15, Subpart C 15.249
Date of Receipt: 2018-05-31
Date of Test: 2018-06-07 to 2018-06-13
Date of Issue: 2018-06-16

Test Result:	Pass*
---------------------	--------------

* In the configuration tested, the EUT complied with the standards specified above.





Keny Xu
EMC Laboratory Manager

The manufacturer should ensure that all products in series production are in conformity with the product sample detailed in this report. If the product in this report is used in any configuration other than that detailed in the report, the manufacturer must ensure the new system complies with all relevant standards. Any mention of SGS International Electrical Approvals or testing done by SGS International Electrical Approvals in connection with, distribution or use of the product described in this report must be approved by SGS International Electrical Approvals in writing.

This document is issued by the Company subject to its General Conditions of Service printed overleaf, available on request or accessible at <http://www.sgs.com/en/Terms-and-Conditions.aspx> and, for electronic format documents, subject to Terms and Conditions for Electronic Documents at <http://www.sgs.com/en/Terms-and-Conditions/Terms-e-Document.aspx>. Attention is drawn to the limitation of liability, indemnification and jurisdiction issues defined therein. Any holder of this document is advised that information contained hereon reflects the Company's findings at the time of its intervention only and within the limits of Client's instructions, if any. The Company's sole responsibility is to its Client and this document does not exonerate parties to a transaction from exercising all their rights and obligations under the transaction documents. This document cannot be reproduced except in full, without prior written approval of the Company. Any unauthorized alteration, forgery or falsification of the content or appearance of this document is unlawful and offenders may be prosecuted to the fullest extent of the law. Unless otherwise stated the results shown in this test report refer only to the sample(s) tested and such sample(s) are retained for 30 days only.



<i>Revision Record</i>				
<i>Version</i>	<i>Chapter</i>	<i>Date</i>	<i>Modifier</i>	<i>Remark</i>
01		2018-06-16		Original

Authorized for issue by:				
				
		<hr/>		
		Vincent Chen /Project Engineer		
				
		<hr/>		
		Eric Fu /Reviewer		

2 Test Summary

Radio Spectrum Technical Requirement				
Item	Standard	Method	Requirement	Result
Antenna Requirement	47 CFR Part 15, Subpart C 15.249	N/A	47 CFR Part 15, Subpart C 15.203	Pass

Radio Spectrum Matter Part				
Item	Standard	Method	Requirement	Result
20dB Bandwidth	47 CFR Part 15, Subpart C 15.249	ANSI C63.10 (2013) Section 6.9	47 CFR Part 15, Subpart C 15.215	Pass
Field Strength of the Fundamental Signal (15.249(a))	47 CFR Part 15, Subpart C 15.249	ANSI C63.10 (2013) Section 6.5&6.6	47 CFR Part 15, Subpart C 15.249(a)	Pass
Restricted Band Around Fundamental Frequency	47 CFR Part 15, Subpart C 15.249	ANSI C63.10 (2013) Section 6.4&6.5&6.6	47 CFR Part 15, Subpart C 15.205 & 15.249(d) & 15.209	Pass
Radiated Emissions	47 CFR Part 15, Subpart C 15.249	ANSI C63.10 (2013) Section 6.4&6.5&6.6	47 CFR Part 15, Subpart C 15.209 & 15.249 (a),(d)	Pass

Remark:

Model No.: B66041625, B66041488

Only the B66041488 was tested, since the electrical circuit design, layout, components used, internal wiring and functions were identical for the above models, with only difference on colour.



3 Contents

	Page
1 COVER PAGE	1
2 TEST SUMMARY	3
3 CONTENTS	4
4 GENERAL INFORMATION	5
4.1 DETAILS OF E.U.T.....	5
4.2 DESCRIPTION OF SUPPORT UNITS.....	5
4.3 MEASUREMENT UNCERTAINTY	5
4.4 TEST LOCATION	6
4.5 TEST FACILITY	6
4.6 DEVIATION FROM STANDARDS	6
4.7 ABNORMALITIES FROM STANDARD CONDITIONS	6
5 EQUIPMENT LIST	7
6 RADIO SPECTRUM TECHNICAL REQUIREMENT	10
6.1 ANTENNA REQUIREMENT.....	10
6.1.1 <i>Test Requirement:</i>	10
6.1.2 <i>Conclusion</i>	10
7 RADIO SPECTRUM MATTER TEST RESULTS	11
7.1 20dB BANDWIDTH.....	11
7.1.1 <i>E.U.T. Operation</i>	11
7.1.2 <i>Test Setup Diagram</i>	11
7.1.3 <i>Measurement Procedure and Data</i>	11
7.2 DUTY CYCLE.....	15
7.3 FIELD STRENGTH OF THE FUNDAMENTAL SIGNAL (15.249(A)).....	17
7.3.1 <i>E.U.T. Operation</i>	18
7.3.2 <i>Test Setup Diagram</i>	18
7.3.3 <i>Measurement Procedure and Data</i>	18
7.4 RESTRICTED BAND AROUND FUNDAMENTAL FREQUENCY	25
7.4.1 <i>E.U.T. Operation</i>	26
7.4.2 <i>Test Setup Diagram</i>	26
7.4.3 <i>Measurement Procedure and Data</i>	26
7.5 RADIATED EMISSIONS	31
7.5.1 <i>E.U.T. Operation</i>	32
7.5.2 <i>Test Setup Diagram</i>	32
7.5.3 <i>Measurement Procedure and Data</i>	32-41

4 General Information

4.1 Details of E.U.T.

Power supply:	DC 1.5V**"AA" for mouse
Antenna Gain	-0.68dBi
Antenna Type	PCB Antenna
Channel Spacing	2MHz
Modulation Type	FSK
Number of Channels	34
Operation Frequency	2408-2474MHz

4.2 Description of Support Units

Description	Manufacturer	Model No.	Serial No.
Laptop	Lenovo	T430u	REF. No.SEA1800

4.3 Measurement Uncertainty

No.	Item	Measurement Uncertainty
1	Radio Frequency	$\pm 7.25 \times 10^{-8}$
2	Duty cycle	$\pm 0.37\%$
3	Occupied Bandwidth	$\pm 3\%$
4	RF conducted power	$\pm 0.75\text{dB}$
5	RF power density	$\pm 2.84\text{dB}$
6	Conducted Spurious emissions	$\pm 0.75\text{dB}$
7	RF Radiated power	$\pm 4.5\text{dB}$ (below 1GHz)
		$\pm 4.8\text{dB}$ (above 1GHz)
8	Radiated Spurious emission test	$\pm 4.5\text{dB}$ (Below 1GHz)
		$\pm 4.8\text{dB}$ (Above 1GHz)
9	Temperature test	$\pm 1^\circ\text{C}$
10	Humidity test	$\pm 3\%$
11	Supply voltages	$\pm 1.5\%$
12	Time	$\pm 3\%$



4.4 Test Location

All tests were performed at:

SGS-CSTC Standards Technical Services Co., Ltd., Shenzhen Branch

No. 1 Workshop, M-10, Middle Section, Science & Technology Park, Shenzhen, Guangdong, China.
518057.

Tel: +86 755 2601 2053 Fax: +86 755 2671 0594

No tests were sub-contracted.

4.5 Test Facility

The test facility is recognized, certified, or accredited by the following organizations:

- **CNAS (No. CNAS L2929)**

CNAS has accredited SGS-CSTC Standards Technical Services Co., Ltd. Shenzhen Branch EMC Lab to ISO/IEC 17025:2005 General Requirements for the Competence of Testing and Calibration Laboratories (CNAS-CL01 Accreditation Criteria for the Competence of Testing and Calibration Laboratories) for the competence in the field of testing.

- **A2LA (Certificate No. 3816.01)**

SGS-CSTC Standards Technical Services Co., Ltd., Shenzhen EMC Laboratory is accredited by the American Association for Laboratory Accreditation(A2LA). Certificate No. 3816.01.

- **VCCI**

The 3m Fully-anechoic chamber for above 1GHz, 10m Semi-anechoic chamber for below 1GHz, Shielded Room for Mains Port Conducted Interference Measurement and Telecommunication Port Conducted Interference Measurement of SGS-CSTC Standards Technical Services Co., Ltd. have been registered in accordance with the Regulations for Voluntary Control Measures with Registration No.: G-20026, R-14188, C-12383 and T-11153 respectively.

- **FCC –Designation Number: CN1178**

SGS-CSTC Standards Technical Services Co., Ltd., Shenzhen EMC Laboratory has been recognized as an accredited testing laboratory.

Designation Number: CN1178. Test Firm Registration Number: 406779.

- **Industry Canada (IC)**

Two 3m Semi-anechoic chambers and the 10m Semi-anechoic chamber of SGS-CSTC Standards Technical Services Co., Ltd. Shenzhen Branch EMC Lab have been registered by Certification and Engineering Bureau of Industry Canada for radio equipment testing with Registration No.: 4620C-1, 4620C-2, 4620C-3.

4.6 Deviation from Standards

None

4.7 Abnormalities from Standard Conditions

None

5 Equipment List

20dB Bandwidth					
Equipment	Manufacturer	Model No	Inventory No	Cal Date	Cal Due Date
DC Power Supply	ZhaoXin	RXN-305D	SEM011-02	2017-09-27	2018-09-26
Spectrum Analyzer	Rohde & Schwarz	FSU43	SEM004-08	2018-04-02	2019-04-01
Measurement Software	JS Tonscend	JS1120-2 BT/WIFI V2.	N/A	N/A	N/A
Coaxial Cable	SGS	N/A	SEM031-01	2017-07-13	2018-07-12
Attenuator	Weinschel Associates	WA41	SEM021-09	N/A	N/A
Signal Generator	KEYSIGHT	N5173B	SEM006-05	2017-09-27	2018-09-26
Power Meter	Rohde & Schwarz	NRVS	SEM014-02	2017-09-27	2018-09-26

Field Strength of the Fundamental Signal (15.249(a))					
Equipment	Manufacturer	Model No	Inventory No	Cal Date	Cal Due Date
3m Semi-Anechoic Chamber	AUDIX	N/A	SEM001-02	2018-03-13	2021-03-12
Measurement Software	AUDIX	e3 V8.2014-6-27	N/A	N/A	N/A
Coaxial Cable	SGS	N/A	SEM026-01	2017-07-13	2018-07-12
Spectrum Analyzer	Rohde & Schwarz	FSU43	SEM004-08	2018-04-02	2019-04-01
BiConiLog Antenna (26-3000MHz)	ETS-Lindgren	3142C	SEM003-01	2017-06-27	2020-06-26
Horn Antenna (1-18GHz)	Rohde & Schwarz	HF907	SEM003-07	2018-04-13	2021-04-12
Horn Antenna(15GHz-40GHz)	Schwarzbeck	BBHA 9170	SEM003-15	2017-10-17	2020-10-16
Pre-amplifier (0.1-1300MHz)	HP	8447D	SEM005-02	2017-09-27	2018-09-26
Low Noise Amplifier(100MHz-18GHz)	Black Diamond Series	BDLNA-0118-352810	SEM005-05	2017-09-27	2018-09-27
Pre-amplifier(18-26GHz)	Rohde & Schwarz	CH14-H052	SEM005-17	2018-04-02	2019-04-01
Pre-amplifier(26GHz-40GHz)	Compliance Directions Systems Inc.	PAP-2640-50	SEM005-08	2018-04-02	2019-04-01
DC Power Supply	Zhao Xin	RXN-305D	SEM011-02	2017-09-27	2018-09-26
Active Loop Antenna	ETS-Lindgren	6502	SEM003-08	2017-08-22	2020-08-21
Band filter	N/A	N/A	SEM023-01	N/A	N/A



Restricted Band Around Fundamental Frequency					
Equipment	Manufacturer	Model No	Inventory No	Cal Date	Cal Due Date
3m Semi-Anechoic Chamber	AUDIX	N/A	SEM001-02	2018-03-13	2021-03-12
Measurement Software	AUDIX	e3 V8.2014-6-27	N/A	N/A	N/A
Coaxial Cable	SGS	N/A	SEM026-01	2017-07-13	2018-07-12
Spectrum Analyzer	Rohde & Schwarz	FSU43	SEM004-08	2018-04-02	2019-04-01
BiConiLog Antenna (26-3000MHz)	ETS-Lindgren	3142C	SEM003-01	2017-06-27	2020-06-26
Horn Antenna (1-18GHz)	Rohde & Schwarz	HF907	SEM003-07	2018-04-13	2021-04-12
Horn Antenna(15GHz-40GHz)	Schwarzbeck	BBHA 9170	SEM003-15	2017-10-17	2020-10-16
Pre-amplifier (0.1-1300MHz)	HP	8447D	SEM005-02	2017-09-27	2018-09-26
Low Noise Amplifier(100MHz-18GHz)	Black Diamond Series	BDLNA-0118-352810	SEM005-05	2017-09-27	2018-09-27
Pre-amplifier(18-26GHz)	Rohde & Schwarz	CH14-H052	SEM005-17	2018-04-02	2019-04-01
Pre-amplifier(26GHz-40GHz)	Compliance Directions Systems Inc.	PAP-2640-50	SEM005-08	2018-04-02	2019-04-01
DC Power Supply	Zhao Xin	RXN-305D	SEM011-02	2017-09-27	2018-09-26
Active Loop Antenna	ETS-Lindgren	6502	SEM003-08	2017-08-22	2020-08-21
Band filter	N/A	N/A	SEM023-01	N/A	N/A



Radiated Emissions					
Equipment	Manufacturer	Model No	Inventory No	Cal Date	Cal Due Date
3m Semi-Anechoic Chamber	AUDIX	N/A	SEM001-02	2018-03-13	2021-03-12
Measurement Software	AUDIX	e3 V8.2014-6-27	N/A	N/A	N/A
Coaxial Cable	SGS	N/A	SEM026-01	2017-07-13	2018-07-12
Spectrum Analyzer	Rohde & Schwarz	FSU43	SEM004-08	2018-04-02	2019-04-01
BiConiLog Antenna (26-3000MHz)	ETS-Lindgren	3142C	SEM003-01	2017-06-27	2020-06-26
Horn Antenna (1-18GHz)	Rohde & Schwarz	HF907	SEM003-07	2018-04-13	2021-04-12
Horn Antenna(15GHz-40GHz)	Schwarzbeck	BBHA 9170	SEM003-15	2017-10-17	2020-10-16
Pre-amplifier (0.1-1300MHz)	HP	8447D	SEM005-02	2017-09-27	2018-09-26
Low Noise Amplifier(100MHz-18GHz)	Black Diamond Series	BDLNA-0118-352810	SEM005-05	2017-09-27	2018-09-27
Pre-amplifier(18-26GHz)	Rohde & Schwarz	CH14-H052	SEM005-17	2018-04-02	2019-04-01
Pre-amplifier(26GHz-40GHz)	Compliance Directions Systems Inc.	PAP-2640-50	SEM005-08	2018-04-02	2019-04-01
DC Power Supply	Zhao Xin	RXN-305D	SEM011-02	2017-09-27	2018-09-26
Active Loop Antenna	ETS-Lindgren	6502	SEM003-08	2017-08-22	2020-08-21
Band filter	N/A	N/A	SEM023-01	N/A	N/A

General used equipment					
Equipment	Manufacturer	Model No	Inventory No	Cal Date	Cal Due Date
Humidity/ Temperature Indicator	Shanghai Meteorological Industry Factory	ZJ1-2B	SEM002-03	2017-09-29	2018-09-28
Humidity/ Temperature Indicator	Shanghai Meteorological Industry Factory	ZJ1-2B	SEM002-04	2017-09-29	2018-09-28
Humidity/ Temperature Indicator	Mingle	N/A	SEM002-08	2017-09-29	2018-09-28
Barometer	Changchun Meteorological Industry Factory	DYM3	SEM002-01	2018-04-08	2019-04-07

6 Radio Spectrum Technical Requirement

6.1 Antenna Requirement

6.1.1 Test Requirement:

47 CFR Part 15, Subpart C 15.203

Limit:

15.203 requirement:

An intentional radiator shall be designed to ensure that no antenna other than that furnished by the responsible party shall be used with the device. The use of a permanently attached antenna or of an antenna that uses a unique coupling to the intentional radiator, the manufacturer may design the unit so that a broken antenna can be replaced by the user, but the use of a standard antenna jack or electrical connector is prohibited.

6.1.2 Conclusion

Standard Requirement:

An intentional radiator shall be designed to ensure that no antenna other than that furnished by the responsible party shall be used with the device. The use of a permanently attached antenna or of an antenna that uses a unique coupling to the intentional radiator, the manufacturer may design the unit so that a broken antenna can be replaced by the user, but the use of a standard antenna jack or electrical connector is prohibited.

EUT Antenna:

The antenna is integrated on the main PCB and no consideration of replacement. The best case gain of the antenna is -0.61dBi.

7 Radio Spectrum Matter Test Results

7.1 20dB Bandwidth

Test Requirement 47 CFR Part 15, Subpart C 15.215
Test Method: ANSI C63.10 (2013) Section 6.9
Limit: N/A

7.1.1 E.U.T. Operation

Operating Environment:

Temperature: 22.9 °C Humidity: 50.8 % RH Atmospheric Pressure: 1010 mbar

Test mode a:TX mode_Keep the EUT in transmitting with modulation mode.

7.1.2 Test Setup Diagram

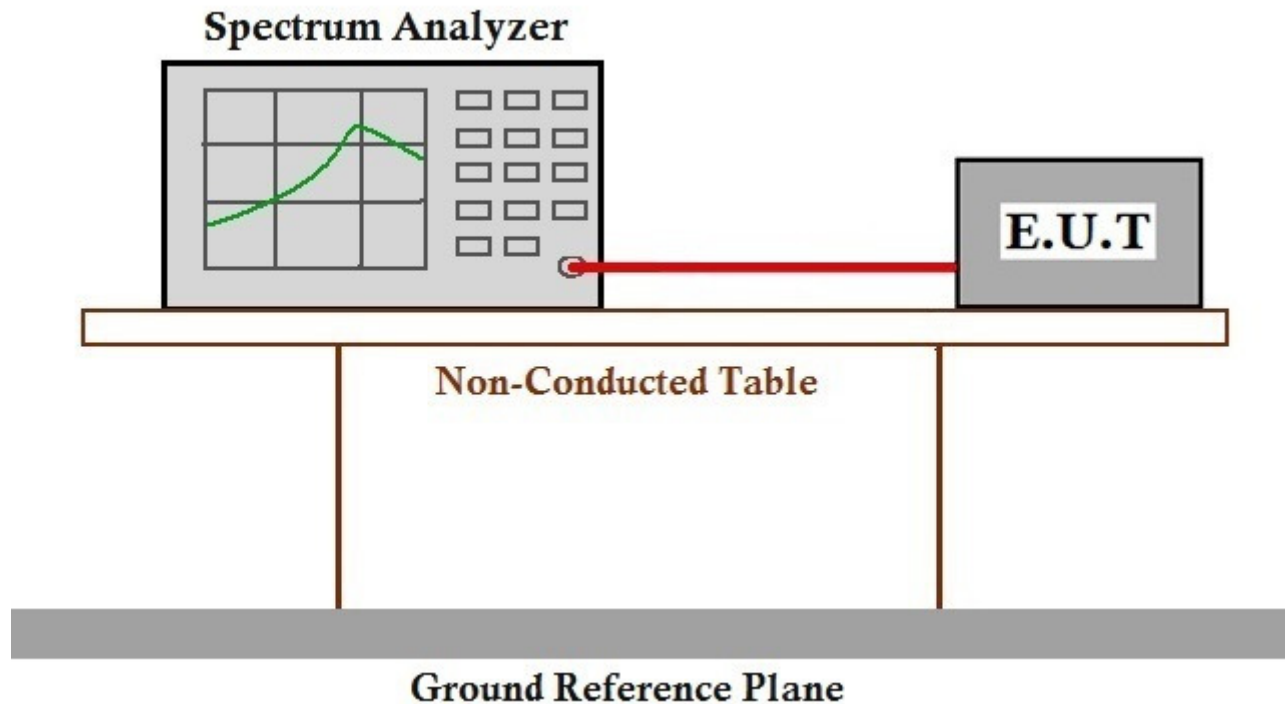

7.1.3 Measurement Procedure and Data



Mouse:
2408MHz



1 PK
VIEW

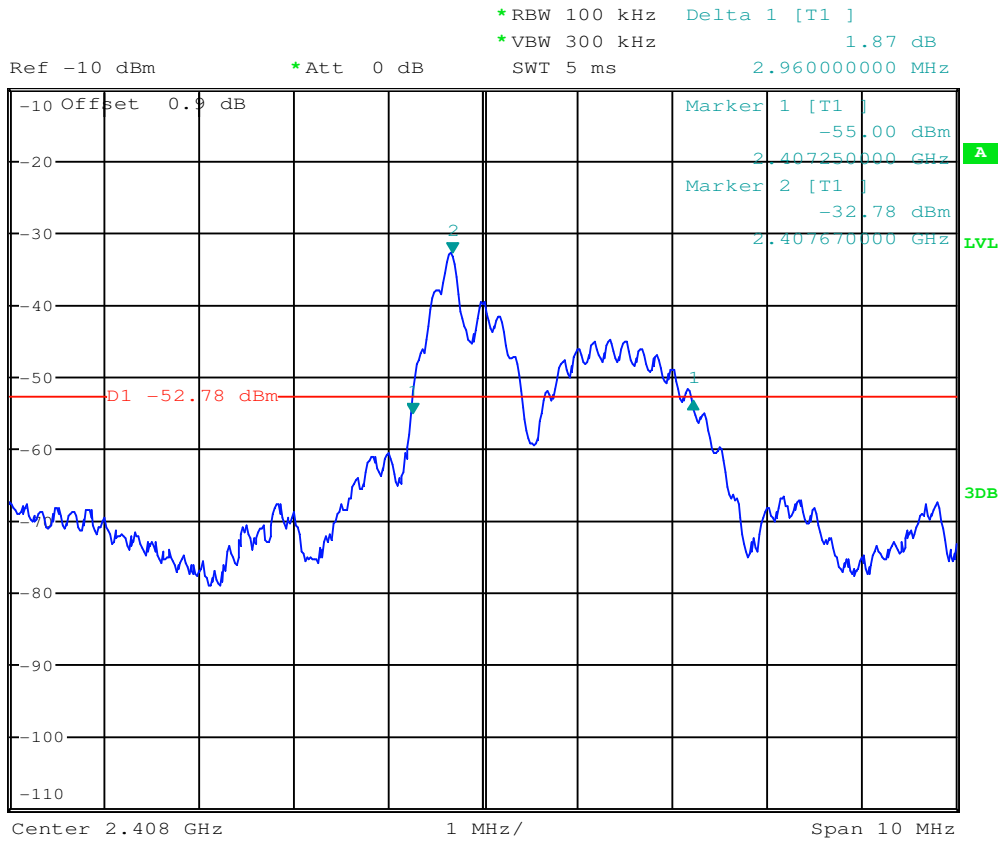



2440Mhz

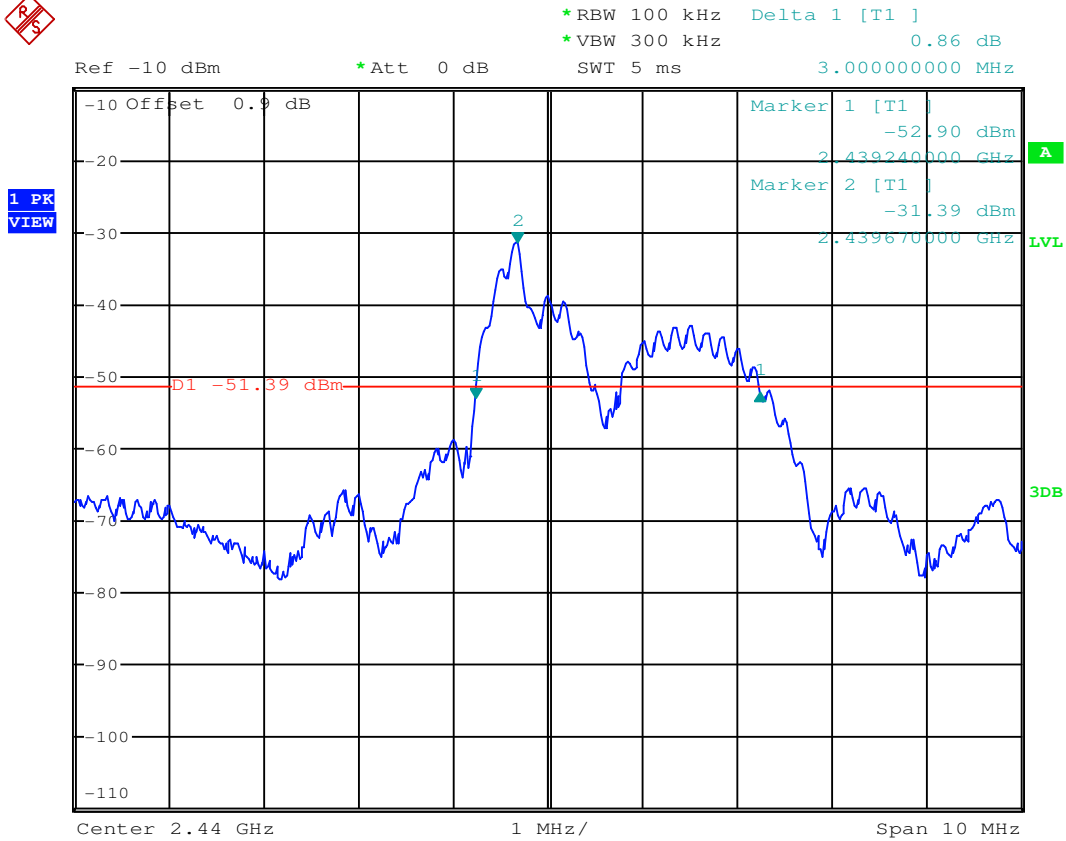



2474MHz

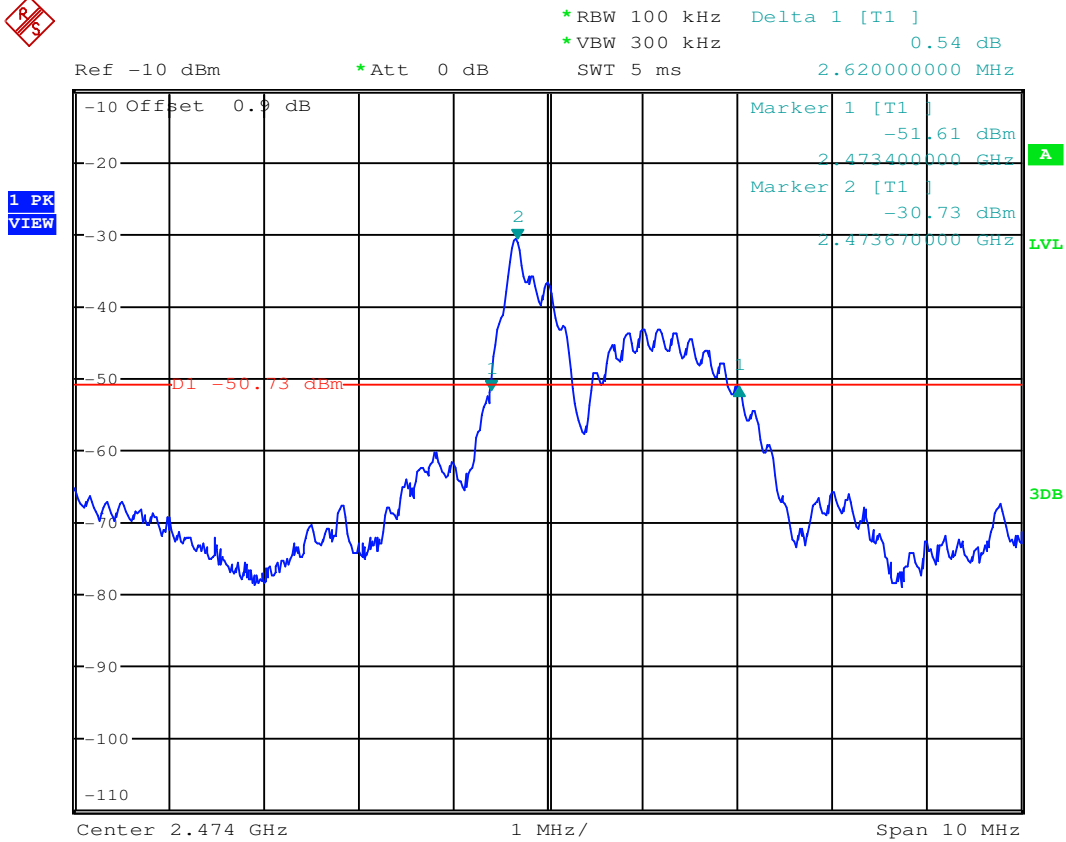

7.2 Duty Cycle

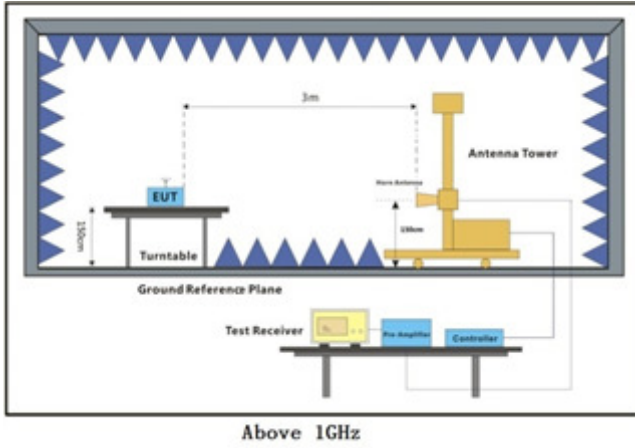
Test Requirement:	47 CFR Part 15C Section 15.35 (c)
Test Method:	ANSI C63.10:2013
Test Setup:	
Limit:	N/A
Test Mode:	Transmitting mode
Instruments Used:	Refer to section 5 for details
Test Results:	<p>The average correction factor is computed by analyzing the on time in 100ms over one complete pulse train. Analysis of the remote transmitter on time in one complete pulse train, therefore the average value of fundamental frequency is: Average = Peak value + 20*log (Duty cycle), where the duty factor is calculated from following formula:</p> $20 \cdot \log (\text{Duty cycle}) = 20 \cdot \log (15.83/100.0) = 20 \cdot \log (0.1583) = -16.01$ <p>Please refer to below plots for more details.</p>

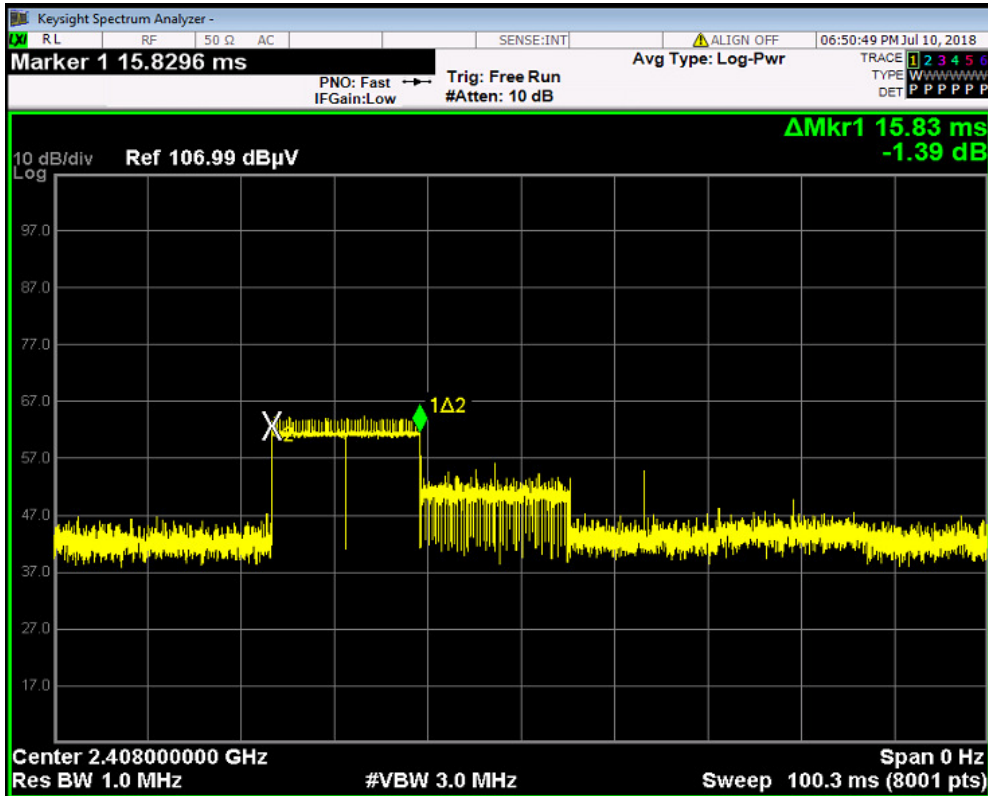



7.3 Field Strength of the Fundamental Signal (15.249(a))

Test Requirement 47 CFR Part 15, Subpart C 15.249(a)

Test Method: ANSI C63.10 (2013) Section 6.5&6.6

Measurement Distance: 3m

Limit:

Frequency	Limit (dBuV/m @3m)	Remark
2400MHz-2483.5MHz	94.0	Average Value
	114.0	Peak Value

7.3.1 E.U.T. Operation

Operating Environment:

Temperature: 23.8 °C Humidity: 53 % RH Atmospheric Pressure: 1010 mbar

Test mode a:TX mode_Keep the EUT in transmitting with modulation mode.

7.3.2 Test Setup Diagram

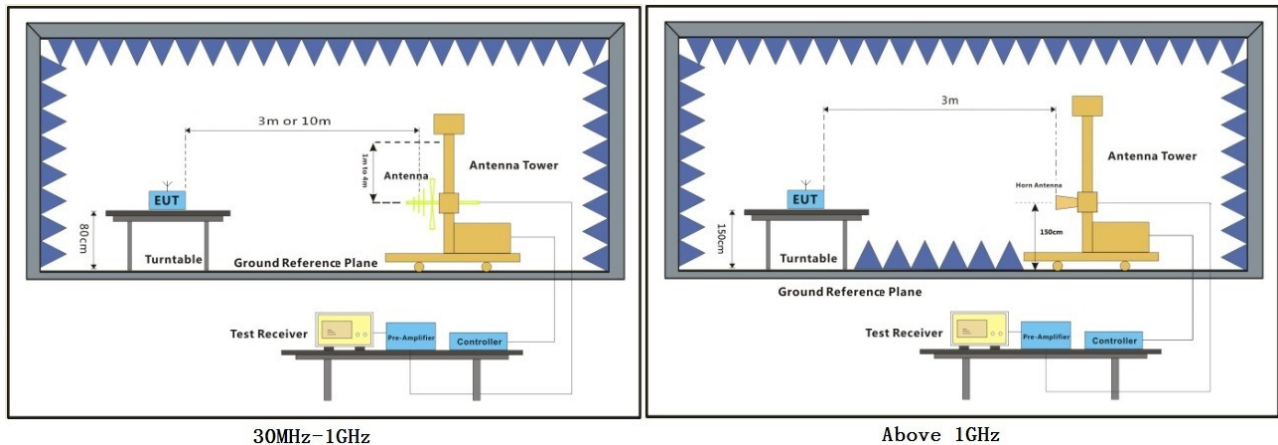

7.3.3 Measurement Procedure and Data

- a. For below 1GHz, the EUT was placed on the top of a rotating table 0.8 meters above the ground at a 3 or 10 meter semi-anechoic chamber. The table was rotated 360 degrees to determine the position of the highest radiation.
 - b. For above 1GHz, the EUT was placed on the top of a rotating table 1.5 meters above the ground at a 3 meter fully-anechoic chamber. The table was rotated 360 degrees to determine the position of the highest radiation.
 - c. The EUT was set 3 or 10 meters away from the interference-receiving antenna, which was mounted on the top of a variable-height antenna tower.
 - d. The antenna height is varied from one meter to four meters above the ground to determine the maximum value of the field strength. Both horizontal and vertical polarizations of the antenna are set to make the measurement.
 - e. For each suspected emission, the EUT was arranged to its worst case and then the antenna was tuned to heights from 1 meter to 4 meters (for the test frequency of below 30MHz, the antenna was tuned to heights 1 meter) and the rotatable table was turned from 0 degrees to 360 degrees to find the maximum reading.
 - f. The test-receiver system was set to Peak Detect Function and Specified Bandwidth with Maximum Hold Mode.
 - g. If the emission level of the EUT in peak mode was 10dB lower than the limit specified, then testing could be stopped and the peak values of the EUT would be reported. Otherwise the emissions that did not have 10dB margin would be re-tested one by one using peak, quasi-peak or average method as specified and then reported in a data sheet.
 - h. Test the EUT in the lowest channel, the middle channel, the Highest channel.
 - i. The radiation measurements are performed in X, Y, Z axis positioning for Transmitting mode, and found the X axis positioning which it is the worst case.
 - j. Repeat above procedures until all frequencies measured was complete.
- Remark: Level= Read Level+ Cable Loss+ Antenna Factor- Preamp Factor



Mouse:

Mode:a; Polarization:Horizontal; Modulation:FSK; ; Channel:Low

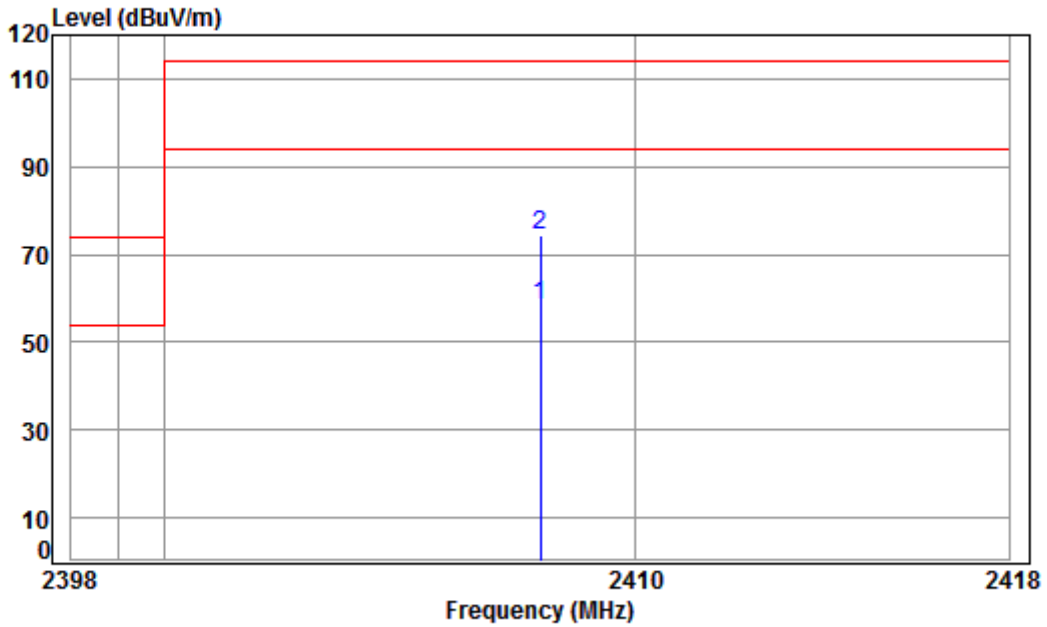

Condition: 3m HORIZONTAL
Job No : 04617CR
Mode : 2408 Field Strength
Note : 2.4G Mouse

	Cable	Ant	Preamp	Read	Limit	Over		
Freq	Loss	Factor	Factor	Level	Level	Line	Limit	Remark
MHz	dB	dB/m	dB	dBuV	dBuV/m	dBuV/m	dB	
1 pp 2408.000	5.50	28.55	37.65	62.15	58.55	94.00	-35.45	Average
2 pk 2408.000	5.50	28.55	37.65	78.16	74.56	114.00	-39.44	peak



Mode:a; Polarization:Vertical; Modulation:FSK; ; Channel:Low

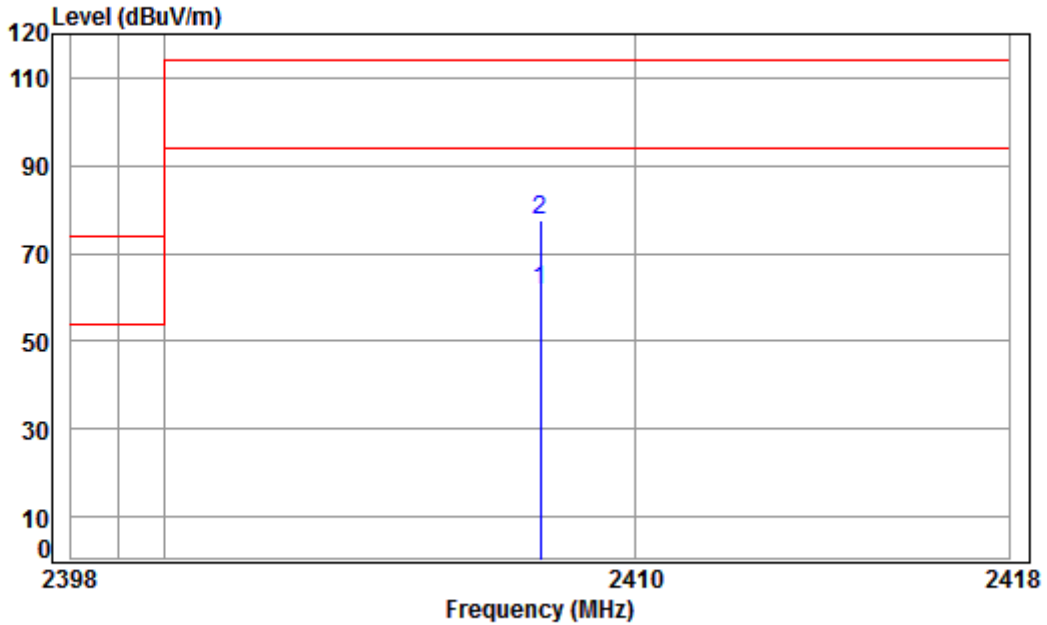

Condition: 3m VERTICAL
Job No : 04617CR
Mode : 2408 Field Strength
Note : 2.4G Mouse

	Freq	Cable Loss	Ant Factor	Preamp Factor	Read Level	Limit Level	Over Limit	Remark
	MHz	dB	dB/m	dB	dBuV	dBuV/m	dB	
1 pp	2408.000	5.50	28.55	37.65	65.34	94.00	-32.26	Average
2 pk	2408.000	5.50	28.55	37.65	81.35	114.00	-36.25	peak



Mode:a; Polarization:Horizontal; Modulation:FSK; ; Channel:middle

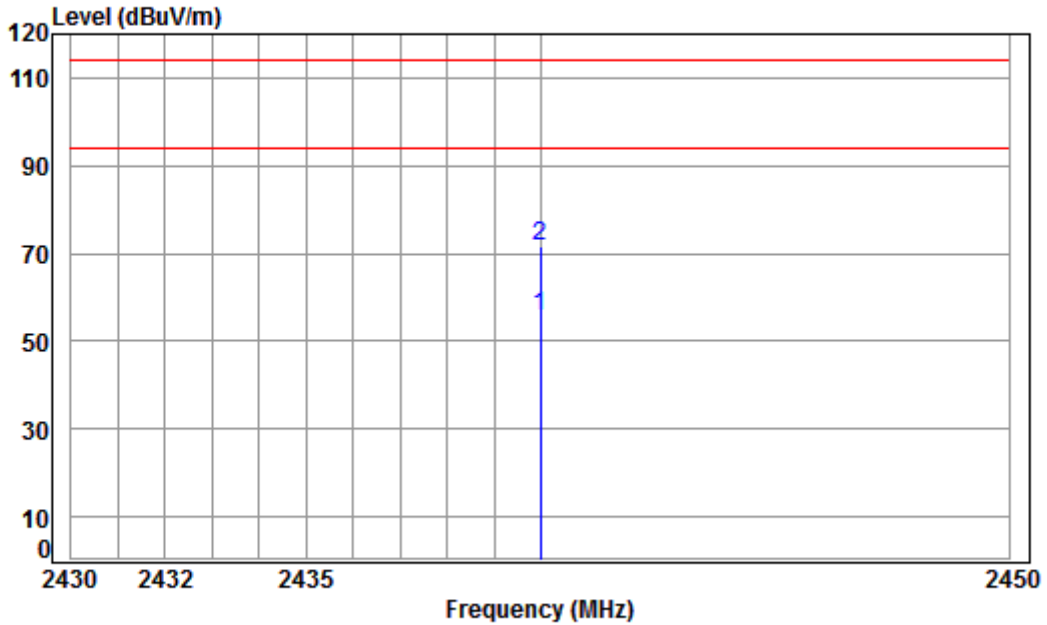

Condition: 3m HORIZONTAL
Job No : 04617CR
Mode : 2440 Field Strength
Note : 2.4G Mouse

	Freq	Cable Loss	Ant Factor	Preamp Factor	Read Level	Limit	Over	Remark
	MHz	dB	dB/m	dB	dBuV	dBuV/m	dB	
1 pp	2440.000	5.54	28.60	37.65	59.29	94.00	-38.22	Average
2 pk	2440.000	5.54	28.60	37.65	75.30	114.00	-42.21	Peak



Mode:a; Polarization:Vertical; Modulation:FSK; ; Channel:middle

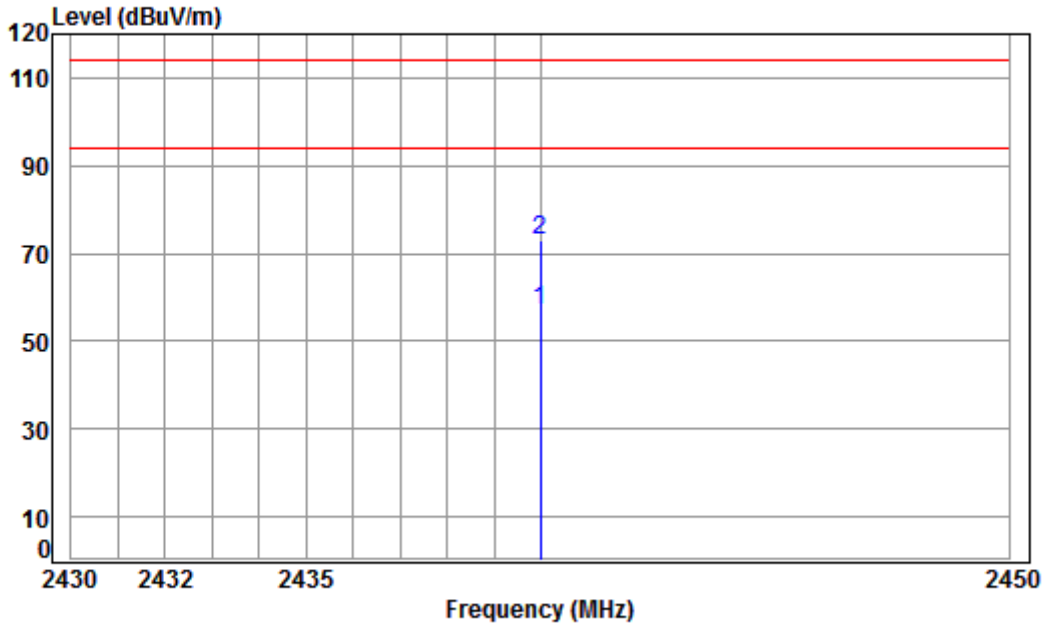

Condition: 3m VERTICAL
Job No : 04617CR
Mode : 2440 Field Strength
Note : 2.4G Mouse

	Freq	Cable Loss	Ant Factor	Preamp Factor	Read Level	Limit	Over	Remark
	MHz	dB	dB/m	dB	dBuV	dBuV/m	dB	
1 pp	2440.000	5.54	28.60	37.65	60.43	94.00	-37.08	Average
2 pk	2440.000	5.54	28.60	37.65	76.43	114.00	-41.08	Peak



Mode:a; Polarization:Horizontal; Modulation:FSK; ; Channel:High

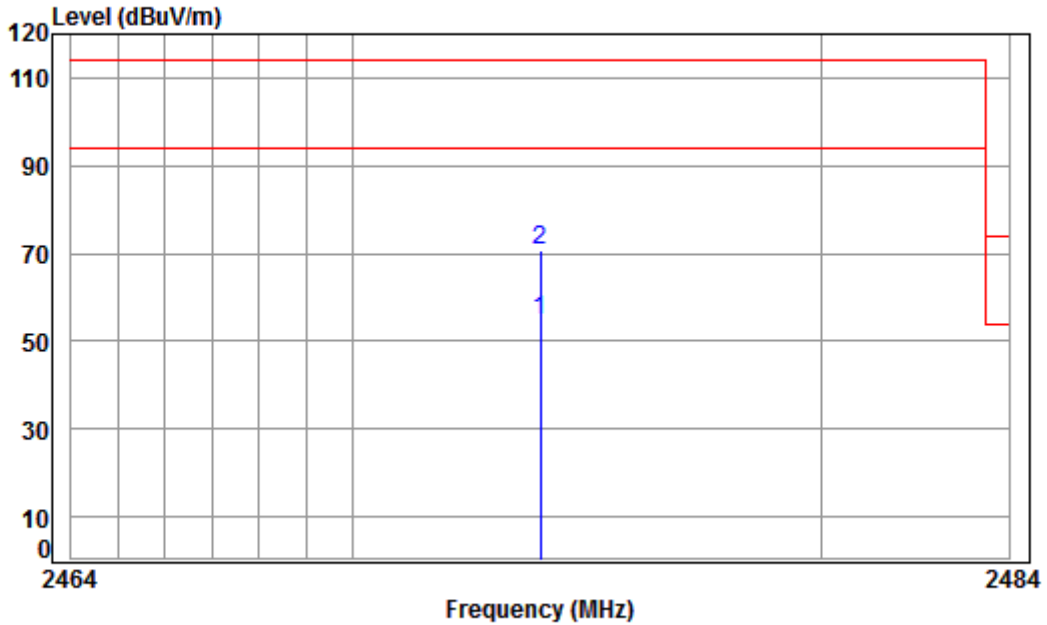

Condition: 3m HORIZONTAL
Job No : 04617CR
Mode : 2474 Field Strength
Note : 2.4G Mouse

	Freq	Cable Loss	Ant Factor	Preamp Factor	Read Level	Limit Level	Over Limit	Remark
	MHz	dB	dB/m	dB	dBuV	dBuV/m	dBuV/m	dB
1 pp	2474.000	5.59	28.66	37.65	58.23	54.83	94.00	-39.17 Average
2 pk	2474.000	5.59	28.66	37.65	74.24	70.84	114.00	-43.16 peak



Mode:a; Polarization:Vertical; Modulation:FSK; ; Channel:High

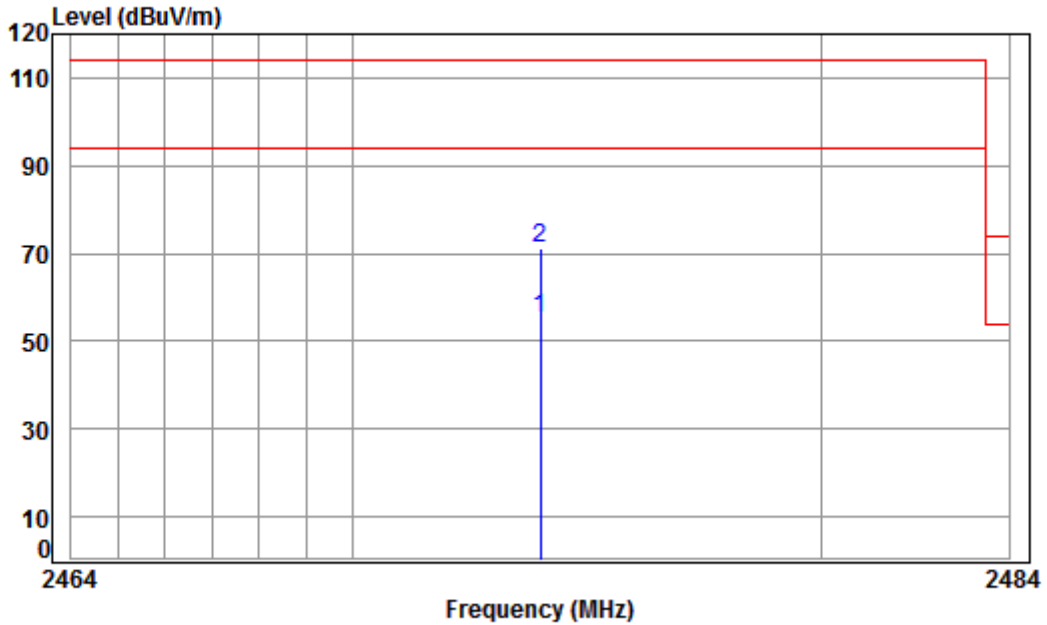

Condition: 3m VERTICAL
Job No : 04617CR
Mode : 2474 Field Strength
Note : 2.4G Mouse

	Freq	Cable Loss	Ant Factor	Preamp Factor	Read Level	Limit Level	Over Limit	Remark
	MHz	dB	dB/m	dB	dBuV	dBuV/m	dB	
1 pp	2474.000	5.59	28.66	37.65	58.57	94.00	-38.83	Average
2 pk	2474.000	5.59	28.66	37.65	74.58	114.00	-42.82	peak



7.4 Restricted Band Around Fundamental Frequency

Test Requirement 47 CFR Part 15, Subpart C 15.205 & 15.249(d) & 15.209

Test Method: ANSI C63.10 (2013) Section 6.4&6.5&6.6

Measurement Distance: 3m

Limit:

Frequency	Limit (dBuV/m @3m)	Remark
30MHz-88MHz	40.0	Quasi-peak Value
88MHz-216MHz	43.5	Quasi-peak Value
216MHz-960MHz	46.0	Quasi-peak Value
960MHz-1GHz	54.0	Quasi-peak Value
Above 1GHz	54.0	Average Value
Above 1GHz	74.0	Peak Value

Emission radiated outside of the specified frequency bands, except for harmonics, shall be attenuated by at least 50 dB below the level of the fundamental or to the general radiated emission limits in Section 15.209, whichever is the lesser attenuation.

7.4.1 E.U.T. Operation

Operating Environment:

Temperature: 23 °C Humidity: 55 % RH Atmospheric Pressure: 1010 mbar

Test mode a:TX mode_Keep the EUT in transmitting with modulation mode.

7.4.2 Test Setup Diagram

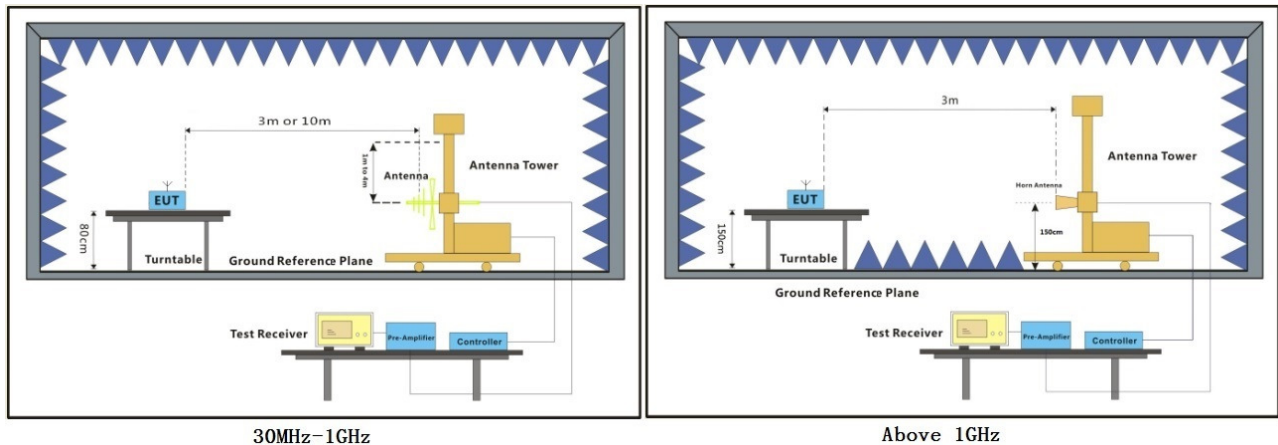

7.4.3 Measurement Procedure and Data

- a. For below 1GHz, the EUT was placed on the top of a rotating table 0.8 meters above the ground at a 3 or 10 meter semi-anechoic chamber. The table was rotated 360 degrees to determine the position of the highest radiation.
 - b. For above 1GHz, the EUT was placed on the top of a rotating table 1.5 meters above the ground at a 3 meter fully-anechoic chamber. The table was rotated 360 degrees to determine the position of the highest radiation.
 - c. The EUT was set 3 or 10 meters away from the interference-receiving antenna, which was mounted on the top of a variable-height antenna tower.
 - d. The antenna height is varied from one meter to four meters above the ground to determine the maximum value of the field strength. Both horizontal and vertical polarizations of the antenna are set to make the measurement.
 - e. For each suspected emission, the EUT was arranged to its worst case and then the antenna was tuned to heights from 1 meter to 4 meters (for the test frequency of below 30MHz, the antenna was tuned to heights 1 meter) and the rotatable table was turned from 0 degrees to 360 degrees to find the maximum reading.
 - f. The test-receiver system was set to Peak Detect Function and Specified Bandwidth with Maximum Hold Mode.
 - g. If the emission level of the EUT in peak mode was 10dB lower than the limit specified, then testing could be stopped and the peak values of the EUT would be reported. Otherwise the emissions that did not have 10dB margin would be re-tested one by one using peak, quasi-peak or average method as specified and then reported in a data sheet.
 - h. Test the EUT in the lowest channel, the middle channel, the Highest channel.
 - i. The radiation measurements are performed in X, Y, Z axis positioning for Transmitting mode, and found the X axis positioning which it is the worst case.
 - j. Repeat above procedures until all frequencies measured was complete.
- Remark: Level= Read Level+ Cable Loss+ Antenna Factor- Preamp Factor



Mouse:

Mode:a; Polarization:Horizontal; Modulation:FSK; ; Channel:Low

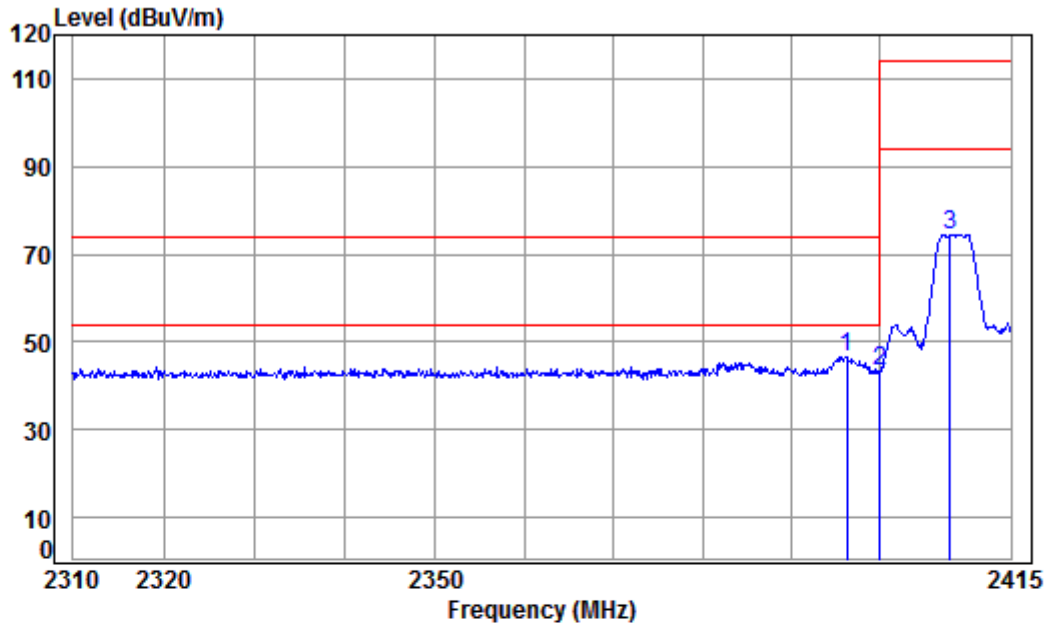

Condition: 3m HORIZONTAL
Job No : 04617CR
Mode : 2408 Band edge
Note : 2.4G Mouse

		Cable	Ant	Preamp	Read	Limit	Over	
	Freq	Loss	Factor	Factor	Level	Level	Line	Limit
	MHz	dB	dB/m	dB	dBuV	dBuV/m	dBuV/m	dB
1	pp 2396.286	5.48	28.53	37.66	50.20	46.55	74.00	-27.45
2	2400.000	5.49	28.54	37.66	46.91	43.28	114.00	-70.72
3	2408.000	5.50	28.55	37.65	78.16	74.56	114.00	-39.44



Mode:a; Polarization:Vertical; Modulation:FSK; ; Channel:Low

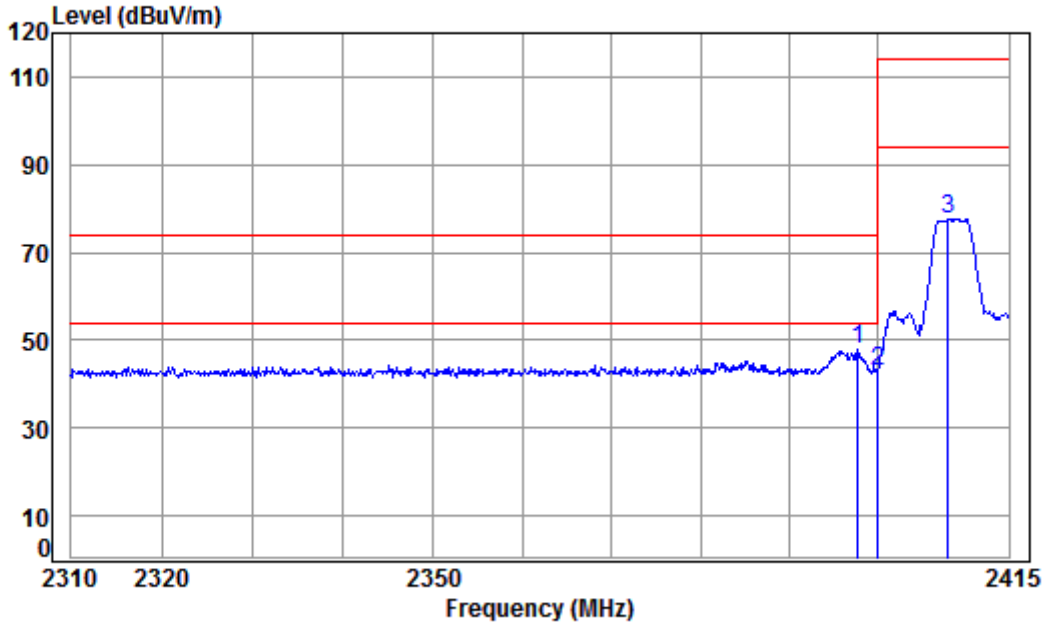

Condition: 3m VERTICAL
Job No : 04617CR
Mode : 2408 Band edge
Note : 2.4G Mouse

	Freq	Cable Loss	Ant Factor	Preamp Factor	Read Level	Level	Limit Line	Over Limit	Remark
	MHz	dB	dB/m	dB	dBuV	dBuV/m	dBuV/m	dB	
1 pp	2397.778	5.49	28.53	37.66	51.44	47.80	74.00	-26.20	peak
2	2400.000	5.49	28.54	37.66	46.54	42.91	74.00	-31.09	peak
3	2408.000	5.50	28.55	37.65	81.35	77.75	114.00	-36.25	peak



Mode:a; Polarization:Horizontal; Modulation:FSK; ; Channel:High

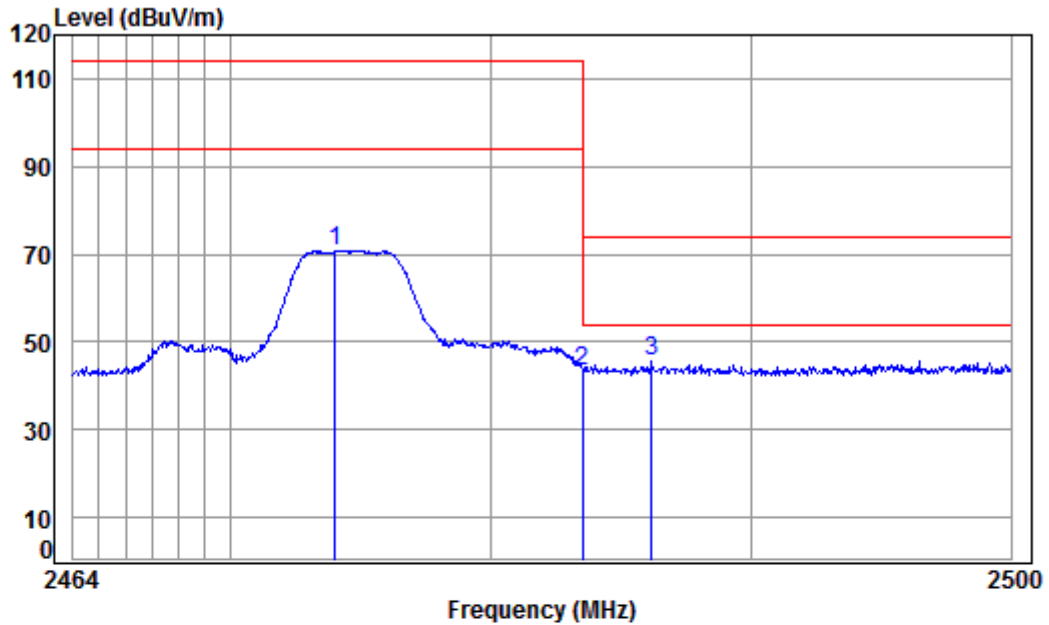

Condition: 3m HORIZONTAL
Job No : 04617CR
Mode : 2474 Band edge
Note : 2.4G Mouse

	Freq	Cable Loss	Ant Factor	Preamp Factor	Read Level	Limit Level	Over Line	Remark
	MHz	dB	dB/m	dB	dBuV	dBuV/m	dBuV/m	dB
1	2474.000	5.59	28.66	37.65	74.24	70.84	114.00	-43.16 peak
2	2483.500	5.60	28.67	37.65	46.92	43.54	74.00	-30.46 peak
3 pp	2486.150	5.60	28.68	37.65	49.15	45.78	74.00	-28.22 peak



Mode:a; Polarization:Vertical; Modulation:FSK; ; Channel:High

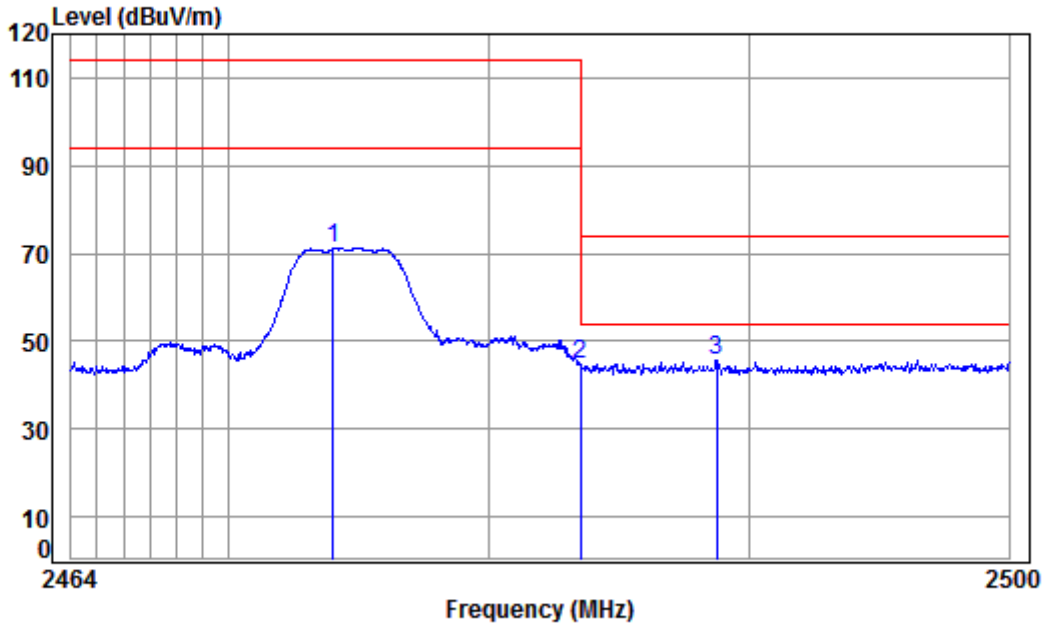

Condition: 3m VERTICAL

Job No : 04617CR

Mode : 2474 Band edge

Note : 2.4G Mouse

	Freq	Cable Loss	Ant Factor	Preamp Factor	Read Level	Level	Limit Line	Over Limit	Remark
	MHz	dB	dB/m	dB	dBuV	dBuV/m	dBuV/m	dB	
1	2474.000	5.59	28.66	37.65	74.58	71.18	114.00	-42.82	peak
2	2483.500	5.60	28.67	37.65	47.98	44.60	74.00	-29.40	peak
3 pp	2488.712	5.61	28.68	37.65	49.15	45.79	74.00	-28.21	peak



7.5 Radiated Emissions

Test Requirement 47 CFR Part 15, Subpart C 15.209 & 15.249 (a),(d)

Test Method: ANSI C63.10 (2013) Section 6.4&6.5&6.6

Measurement Distance: 3m

Limit:

Frequency(MHz)	Field strength (microvolts/meter)	Limit (dBuV/m)	Detector	Measurement Distance (meters)
0.009-0.490	2400/F(kHz)	-	-	300
0.490-1.705	24000/F(kHz)	-	-	30
1.705-30	30	-	-	30
30-88	100	40.0	QP	3
88-216	150	43.5	QP	3
216-960	200	46.0	QP	3
960-1000	500	54.0	QP	3
Above 1000	500	54.0	AV	3

7.5.1 E.U.T. Operation

Operating Environment:

Temperature: 23.8 °C Humidity: 55 % RH Atmospheric Pressure: 1010 mbar

Test mode a:TX mode_Keep the EUT in transmitting with modulation mode.

7.5.2 Test Setup Diagram

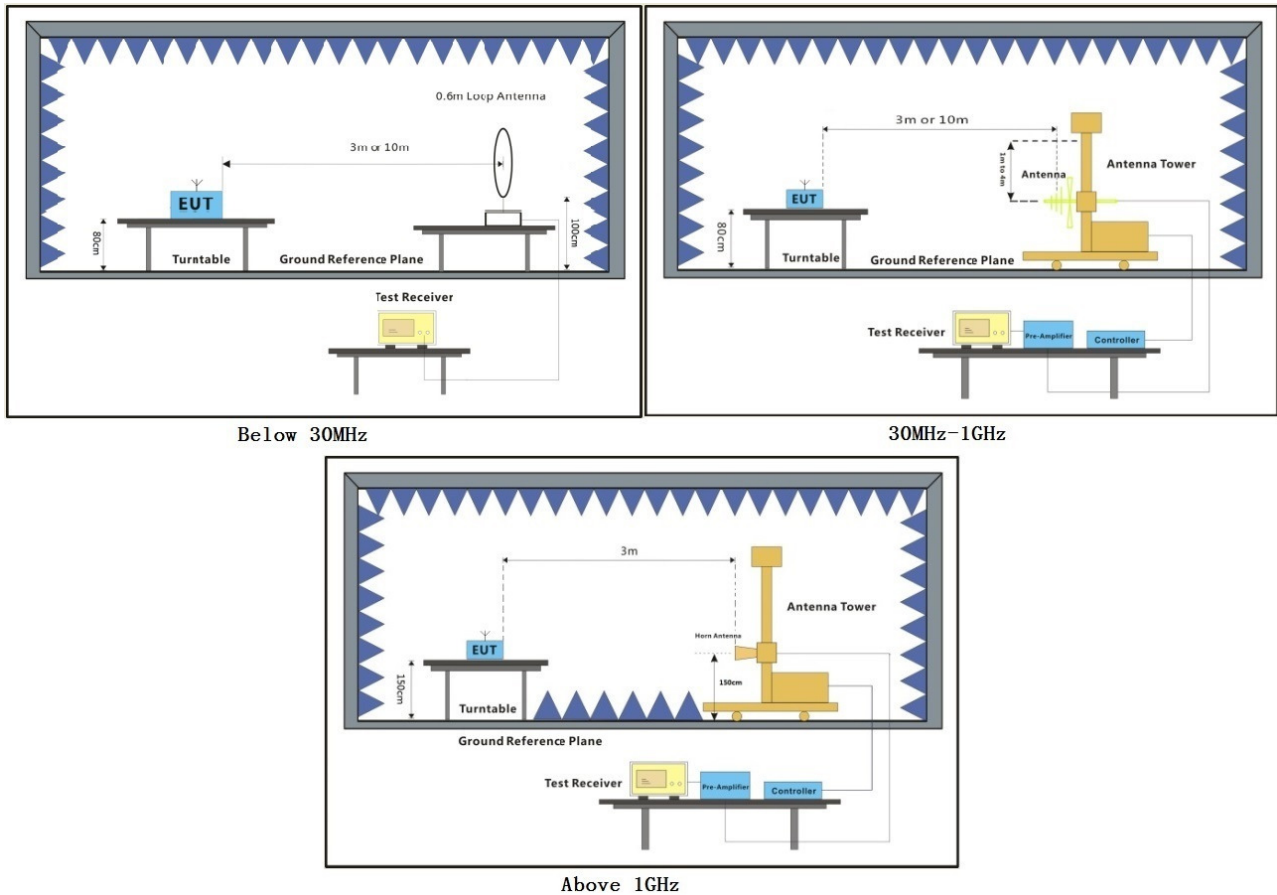

7.5.3 Measurement Procedure and Data

For testing performed with the loop antenna, the center of the loop was positioned 1 m above the ground and positioned with its plane vertical at the specified distance from the EUT. During testing the loop was rotated about its vertical axis for maximum response at each azimuth and also investigated with the loop positioned in the horizontal plane. Only the worst position of vertical was shown in the report.

30MHz~1GHz

QP value:

Mode:a; Polarization:Horizontal;

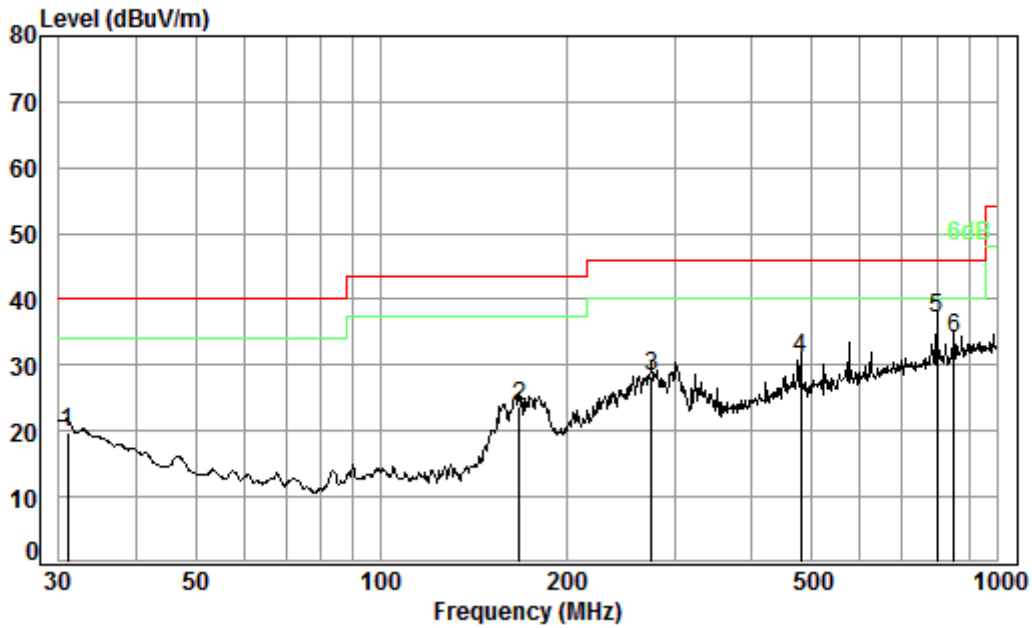

Condition: 3m HORIZONTAL

Job No. : 04617CR

Test mode: a

	Freq	Cable Loss	Ant Factor	Preamp Factor	Read Level	Limit Level	Limit Line	Over Limit
	MHz	dB	dB/m	dB	dBuV	dBuV/m	dBuV/m	dB
1	30.96	0.60	21.95	27.35	24.61	19.81	40.00	-20.19
2	167.82	1.35	15.66	26.82	33.62	23.81	43.50	-19.69
3	275.16	1.79	18.87	26.46	34.12	28.32	46.00	-17.68
4	480.53	2.53	24.21	27.60	31.78	30.92	46.00	-15.08
5	798.98	3.20	28.49	27.30	32.59	36.98	46.00	-9.02
6	851.04	3.41	29.18	27.02	28.57	34.14	46.00	-11.86



Mode:a; Polarization:Vertical

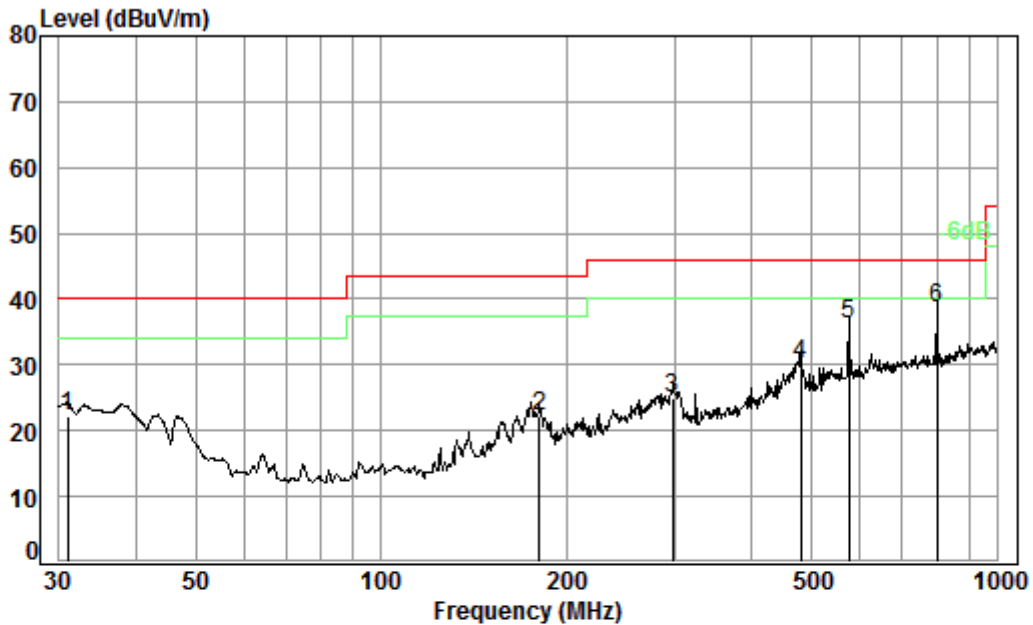

Condition: 3m VERTICAL

Job No. : 04617CR

Test mode: a

	Freq	Cable Loss	Ant Factor	Preamp Factor	Read Level	Level	Limit Line	Over Limit
	MHz	dB	dB/m	dB	dBuV	dBuV/m	dBuV/m	dB
1	30.96	0.60	21.95	27.35	27.09	22.29	40.00	-17.71
2	180.65	1.37	15.92	26.77	31.60	22.12	43.50	-21.38
3	297.22	1.89	19.49	26.41	30.08	25.05	46.00	-20.95
4	480.53	2.53	24.21	27.60	31.07	30.21	46.00	-15.79
5	574.63	2.68	26.13	27.58	35.07	36.30	46.00	-9.70
6 pp	798.98	3.20	28.49	27.30	34.24	38.63	46.00	-7.37



Above 1GHz

Mode:a; Polarization:Horizontal; Modulation:FSK; ; Channel:Low

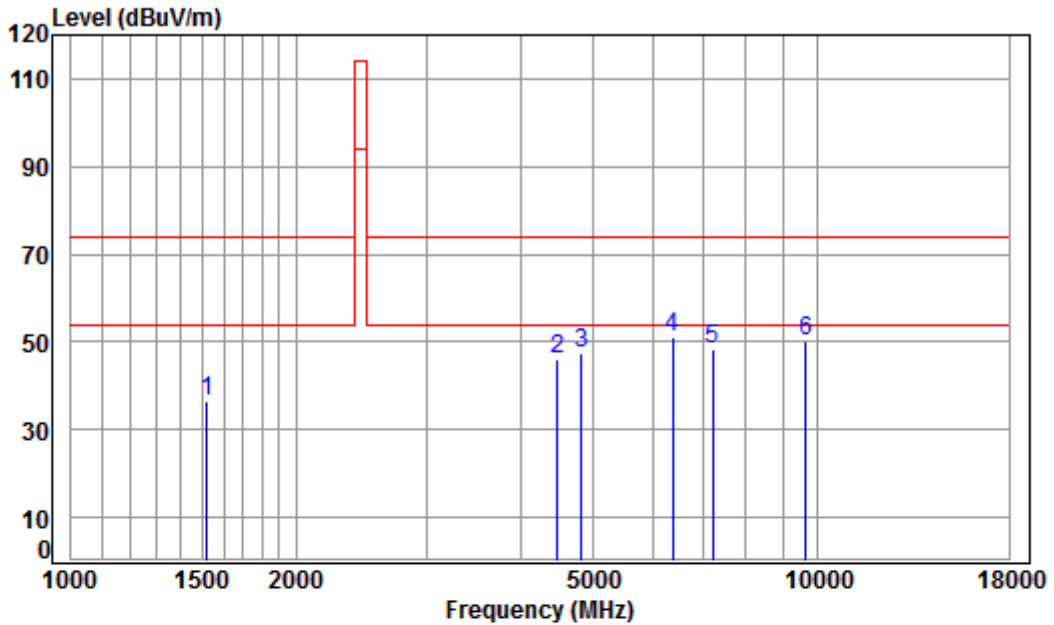

Condition: 3m HORIZONTAL
Job No : 04617CR
Mode : 2408 TX RSE
Note : 2.4G Mouse

	Freq	Cable Loss	Ant Factor	Preamp Factor	Read Level	Level	Limit Line	Over Limit	Remark
	MHz	dB	dB/m	dB	dBuV	dBuV/m	dBuV/m	dB	
1	1520.598	5.45	25.89	41.42	46.65	36.57	74.00	-37.43	peak
2	4482.150	7.54	33.57	42.41	47.50	46.20	74.00	-27.80	peak
3	4816.000	7.90	33.99	42.47	48.02	47.44	74.00	-26.56	peak
4 pp	6377.195	11.31	35.48	41.31	45.65	51.13	74.00	-22.87	peak
5	7224.000	10.07	36.08	40.70	42.99	48.44	74.00	-25.56	peak
6	9632.000	10.76	37.68	37.70	39.41	50.15	74.00	-23.85	peak



Mode:a; Polarization:Vertical; Modulation:FSK; ; Channel:Low

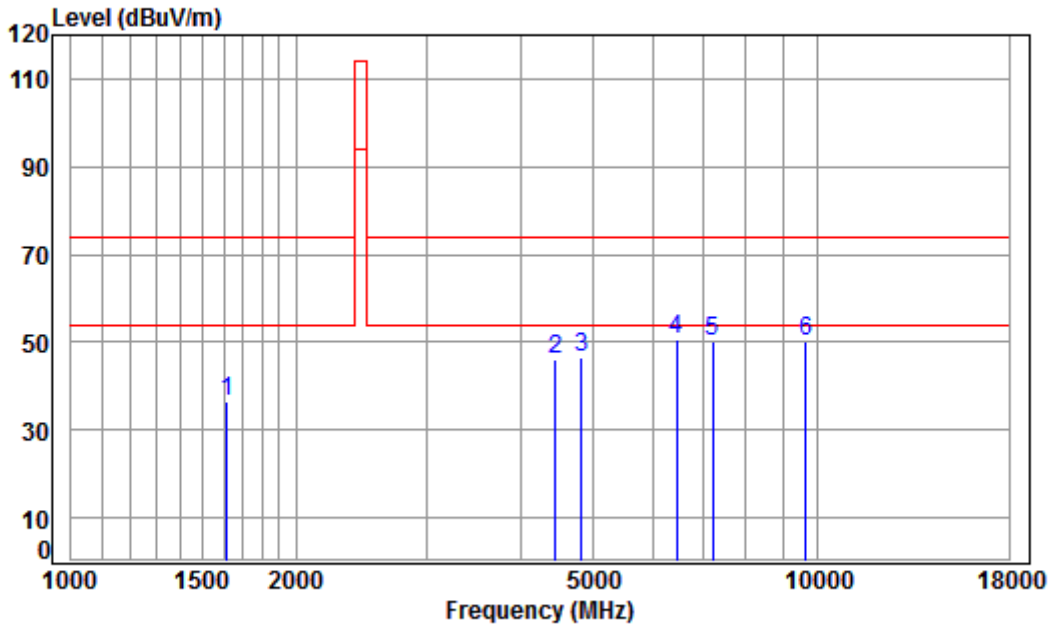

Condition: 3m VERTICAL
Job No : 04617CR
Mode : 2408 TX RSE
Note : 2.4G Mouse

	Freq	Cable Loss	Ant Factor	Preamp Factor	Read Level	Level	Limit Line	Over Limit	Remark
	MHz	dB	dB/m	dB	dBuV	dBuV/m	dBuV/m	dB	
1	1615.754	5.33	26.32	41.48	46.37	36.54	74.00	-37.46	peak
2	4456.315	7.51	33.53	42.41	47.63	46.26	74.00	-27.74	peak
3	4816.000	7.90	33.99	42.47	47.02	46.44	74.00	-27.56	peak
4 pp	6470.026	11.48	35.57	41.24	44.89	50.70	74.00	-23.30	peak
5	7224.000	10.07	36.08	40.70	44.53	49.98	74.00	-24.02	peak
6	9632.000	10.76	37.68	37.70	39.34	50.08	74.00	-23.92	peak



Mode:a; Polarization:Horizontal; Modulation:FSK; ; Channel:middle

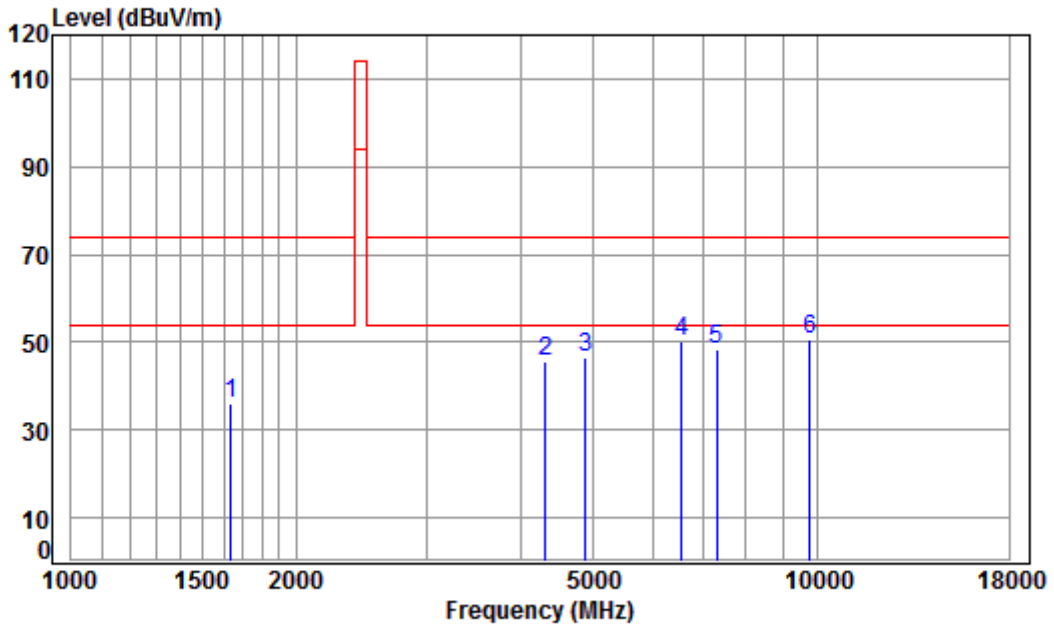

Condition: 3m HORIZONTAL

Job No : 04617CR

Mode : 2440 TX RSE

Note : 2.4G Mouse

	Freq	Cable Loss	Ant Factor	Preamp Factor	Read Level	Level	Limit Line	Over Limit	Remark
	MHz	dB	dB/m	dB	dBuV	dBuV/m	dBuV/m	dB	
1	1639.274	5.30	26.42	41.49	45.70	35.93	74.00	-38.07	peak
2	4316.859	7.36	33.28	42.38	47.42	45.68	74.00	-28.32	peak
3	4880.000	7.97	34.06	42.48	47.03	46.58	74.00	-27.42	peak
4	6564.209	11.35	35.64	41.17	44.39	50.21	74.00	-23.79	peak
5	7320.000	10.05	36.16	40.63	42.67	48.25	74.00	-25.75	peak
6	pp 9760.000	10.82	37.76	37.53	39.45	50.50	74.00	-23.50	peak



Mode:a; Polarization:Vertical; Modulation:FSK; ; Channel:middle

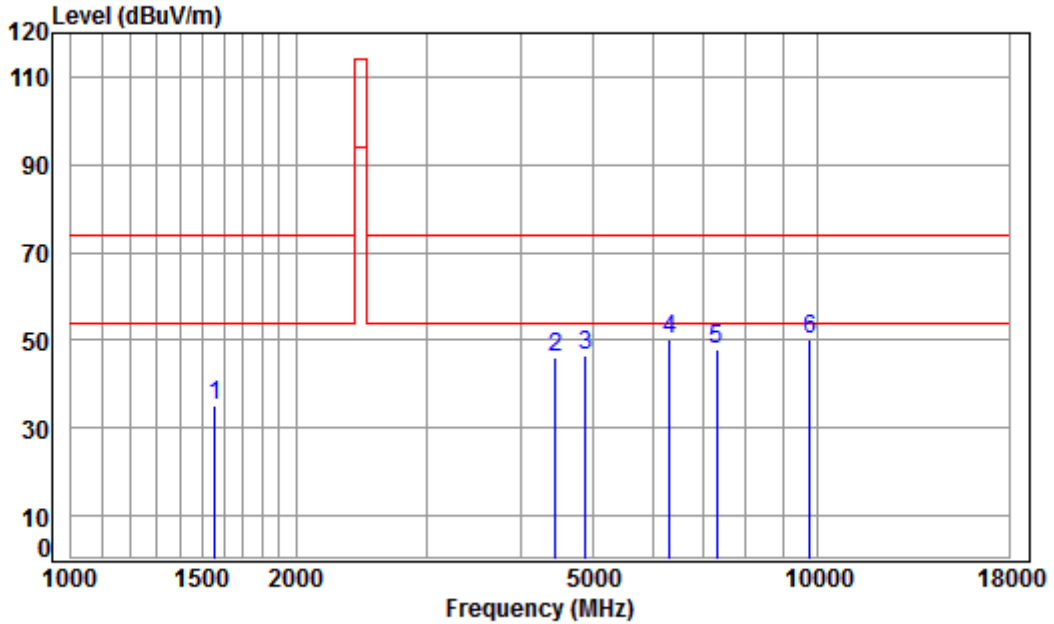

Condition: 3m VERTICAL
 Job No : 04617CR
 Mode : 2440 TX RSE
 Note : 2.4G Mouse

	Freq	Cable Loss	Ant Factor	Preamp Factor	Read Level	Level	Limit Line	Over Limit	Remark
	MHz	dB	dB/m	dB	dBuV	dBuV/m	dBuV/m	dB	
1	1560.673	5.40	26.08	41.45	45.12	35.15	74.00	-38.85	peak
2	4456.315	7.51	33.53	42.41	47.64	46.27	74.00	-27.73	peak
3	4880.000	7.97	34.06	42.48	47.10	46.65	74.00	-27.35	peak
4	pp 6322.136	11.20	35.43	41.35	44.90	50.18	74.00	-23.82	peak
5	7320.000	10.05	36.16	40.63	42.56	48.14	74.00	-25.86	peak
6	9760.000	10.82	37.76	37.53	38.94	49.99	74.00	-24.01	peak



Mode:a; Polarization:Horizontal; Modulation:FSK; ; Channel:High

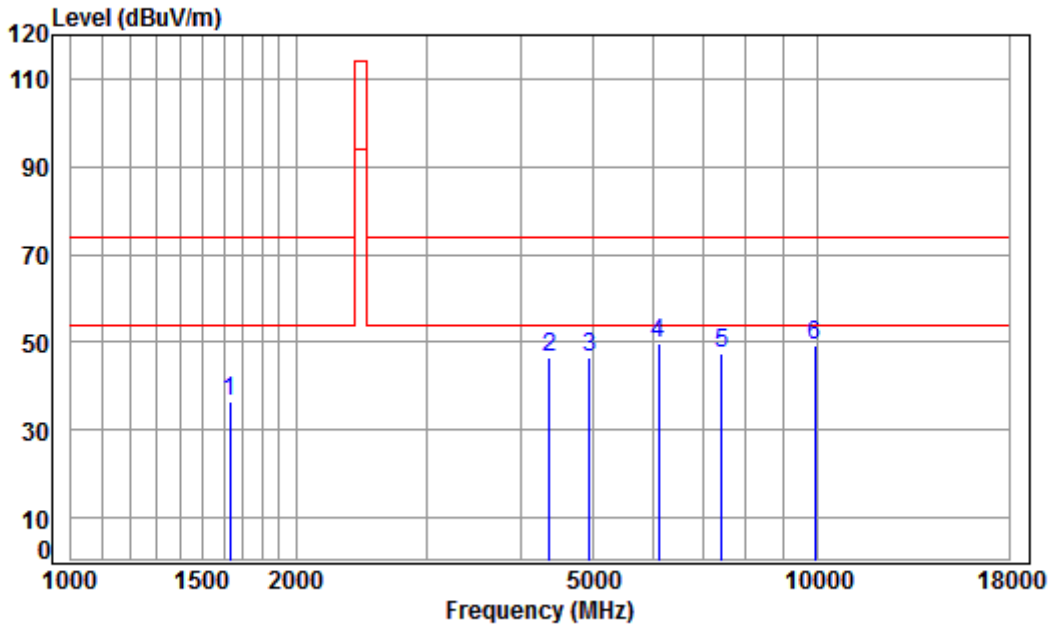

Condition: 3m HORIZONTAL

Job No : 04617CR

Mode : 2474 TX RSE

Note : 2.4G Mouse

	Freq	Cable Loss	Ant Factor	Preamp Factor	Read Level	Limit Level	Over Line	Over Limit	Remark
	MHz	dB	dB/m	dB	dBuV	dBuV/m	dBuV/m	dB	
1	1634.543	5.31	26.40	41.49	46.49	36.71	74.00	-37.29	peak
2	4367.058	7.41	33.37	42.39	48.16	46.55	74.00	-27.45	peak
3	4948.000	8.04	34.14	42.49	46.64	46.33	74.00	-27.67	peak
4	pp 6106.616	10.78	35.21	41.52	45.47	49.94	74.00	-24.06	peak
5	7422.000	10.02	36.24	40.57	41.60	47.29	74.00	-26.71	peak
6	9896.000	10.89	37.84	37.34	37.91	49.30	74.00	-24.70	peak



Mode:a; Polarization:Vertical; Modulation:FSK; ; Channel:High

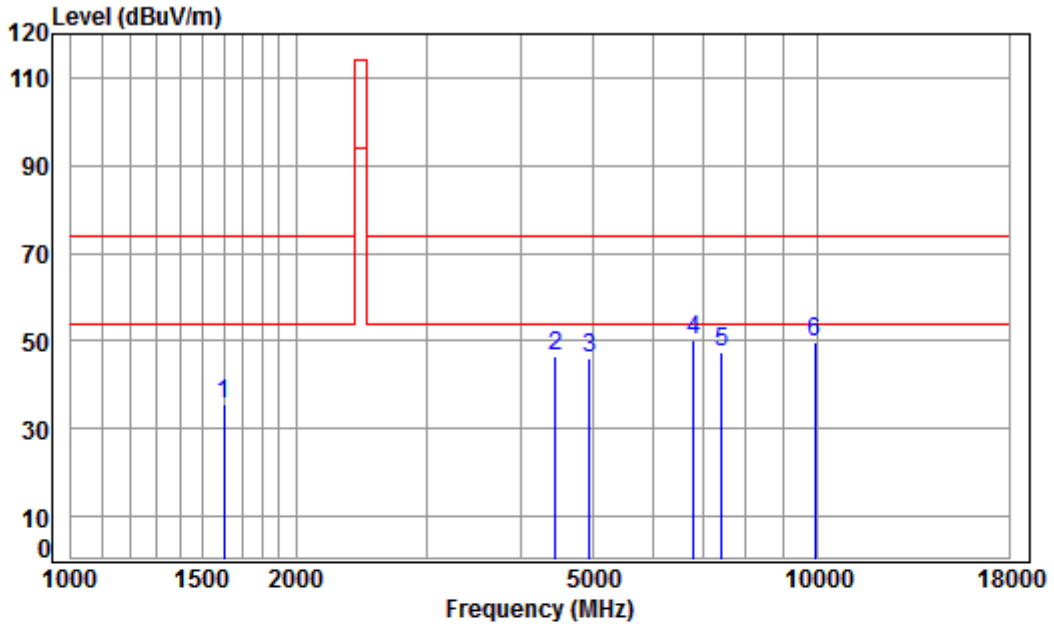

Condition: 3m VERTICAL
Job No : 04617CR
Mode : 2474 TX RSE
Note : 2.4G Mouse

	Freq	Cable Loss	Ant Factor	Preamp Factor	Read Level	Level	Limit Line	Over Limit	Remark
	MHz	dB	dB/m	dB	dBuV	dBuV/m	dBuV/m	dB	
1	1601.804	5.35	26.26	41.47	45.47	35.61	74.00	-38.39	peak
2	4456.315	7.51	33.53	42.41	47.68	46.31	74.00	-27.69	peak
3	4948.000	8.04	34.14	42.49	46.40	46.09	74.00	-27.91	peak
4 pp	6815.551	10.64	35.79	40.98	44.83	50.28	74.00	-23.72	peak
5	7422.000	10.02	36.24	40.57	41.83	47.52	74.00	-26.48	peak
6	9896.000	10.89	37.84	37.34	38.52	49.91	74.00	-24.09	peak



Remark:

1) The field strength is calculated by adding the Antenna Factor, Cable Factor & Preamplifier. The basic equation with a sample calculation is as follows:

Final Test Level = Receiver Reading + Antenna Factor + Cable Factor – Preamplifier Factor

2) Scan from 9kHz to 25GHz, the disturbance above 18GHz and below 30MHz was very low, and the above harmonics were the highest point could be found when testing, so only the above harmonics had been displayed. The amplitude of spurious emissions from the radiator which are attenuated more than 20dB below the limit need not be reported.

3) As shown in this section, for frequencies above 1GHz, the field strength limits are based on average limits. However, the peak field strength of any emission shall not exceed the maximum permitted average limits specified above by more than 20 dB under any condition of modulation. So, only the peak measurements were shown in the report.

- End of the Report -