



FCC TEST REPORT
FCC ID: 2AP2N-MAGQOO-AS

On Behalf of

Shenzhen Esorun Technology Co., LTD

Magnetic Wireless Charger

Model No.: MagQoo AS

Prepared for : Shenzhen Esorun Technology Co., LTD
Address : Room 226, Building A, B, C, Zone B, Yuanfen Industrial Zone, Taoyuan
Community, Dalang Street, Longhua District, Shenzhen

Prepared By : Shenzhen Alpha Product Testing Co., Ltd.
Address : Building i, No.2, Lixin Road, Fuyong Street, Bao'an District,
518103, Shenzhen, Guangdong, China

Report Number : A2212151-C01-R07
Date of Receipt : December 20, 2022
Date of Test : December 20, 2022-January 3, 2023
Date of Report : January 4, 2023
Version Number : V0

TABLE OF CONTENTS

| Description | Page |
|--|-------------|
| 1. Test Result Summary | 5 |
| 2. General Information | 6 |
| 2.1. DESCRIPTION OF DEVICE (EUT)..... | 6 |
| 2.2. ACCESSORIES OF DEVICE (EUT)..... | 7 |
| 2.3. TESTED SUPPORTING SYSTEM DETAILS | 7 |
| 2.4. BLOCK DIAGRAM OF CONNECTION BETWEEN EUT AND SIMULATORS | 7 |
| 2.5. DESCRIPTION OF TEST MODES..... | 7 |
| 2.6. TEST CONDITIONS | 7 |
| 2.7. TEST FACILITY | 8 |
| 2.8. MEASUREMENT UNCERTAINTY | 8 |
| 2.9. TEST EQUIPMENT LIST..... | 9 |
| 3. Test Results and Measurement Data | 10 |
| 3.1. CONDUCTED EMISSION | 10 |
| 3.2. RADIATED SPURIOUS EMISSION MEASUREMENT | 14 |
| 3.3. TEST SPECIFICATION | 23 |
| 4. Photos of test setup | 25 |
| 5. Photographs of EUT | 27 |

TEST REPORT DECLARATION

Applicant : Shenzhen Esorun Technology Co., LTD
 Address : Room 226, Building A, B, C, Zone B, Yuanfen Industrial Zone, Taoyuan
 Community, Dalang Street, Longhua District, Shenzhen
 Manufacturer : Shenzhen Esorun Technology Co., LTD
 Address : Room 226, Building A, B, C, Zone B, Yuanfen Industrial Zone, Taoyuan
 Community, Dalang Street, Longhua District, Shenzhen
 EUT Description : Magnetic Wireless Charger
 (A) Model No. : MagQoo AS
 (B) Trademark : ESORUN

Measurement Standard Used:

FCC CFR Title 47 Part 15 Subpart C Section 15.209

The device described above is tested by Shenzhen Alpha Product Testing Co., Ltd. to determine the maximum emission levels emanating from the device and the severe levels of the device can endure and its performance criterion. The test results are contained in this test report and Shenzhen Alpha Product Testing Co., Ltd. is assumed full responsibility for the accuracy and completeness of test. Also, this report shows that the EUT is technically compliant with the FCC CFR Title 47 Part 15 Subpart C Section 15.209 requirements.

This report applies to above tested sample only. This report shall not be reproduced in parts without written approval of Shenzhen Alpha Product Testing Co., Ltd.

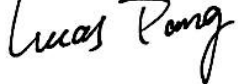
Tested by (name + signature).....: Lucas Pang
 Project Engineer 

Approved by (name + signature).....: Jack Xu
 Project Manager 

Date of issue.....: January 4, 2023

Revision History

| Revision | Issue Date | Revisions | Revised By |
|----------|-----------------|------------------------|------------|
| V0 | January 4, 2023 | Initial released Issue | Lucas Pang |

1. Test Result Summary

| Requirement | CFR 47 Section | Result |
|----------------------------------|----------------|--------|
| Antenna requirement | §15.203 | PASS |
| AC Power Line Conducted Emission | §15.207 | PASS |
| Spurious Emission | §15.209(a)(f) | PASS |
| Occupied Bandwidth | §15.215 (c) | PASS |

Note:

1. *PASS: Test item meets the requirement.*
2. *Fail: Test item does not meet the requirement.*
3. *N/A: Test case does not apply to the test object.*
4. *The test result judgment is decided by the limit of test standard.*
5. Decision rules for the conclusion of this test report: decision by actual test data without considering measurement uncertainty.

2. General Information

2.1. Description of Device (EUT)

| | | |
|----------------------|---|---|
| EUT Name | : | Magnetic Wireless Charger |
| Model No. | : | MagQoo AS |
| DIFF. | : | N/A |
| Trademark | : | ESORUN |
| Power supply | : | Input: 5V \Rightarrow 2A, 9V \Rightarrow 2.22A Wireless Output: 5W, 7.5W, 10W, 15W |
| Radio Technology | : | Wireless power transmission systems |
| Operation frequency | : | 115-205KHz |
| Modulation | : | MSK |
| Antenna Type | : | Coil Antenna, Maximum Gain is 0dBi(This value is supplied by applicant). |
| Connector cable loss | : | 0.5dB (This value is supplied by applicant). |
| Software version | : | V1.0 |
| Hardware version | : | V1.0 |

2.2. Accessories of Device (EUT)

| | | |
|--------------|---|---|
| Accessories | : | / |
| Manufacturer | : | / |
| Model | : | / |
| Input | : | / |
| Output | : | / |

2.3. Tested Supporting System Details

| No. | Description | Manufacturer | Model | Serial Number | Certification or SDoC |
|-----|-------------|--------------|----------|---------------|-----------------------|
| 1 | Adapter | BlitzForce | BZ-PC001 | N/A | N/A |
| 2 | Load | N/A | N/A | N/A | N/A |

2.4. Block Diagram of connection between EUT and simulators

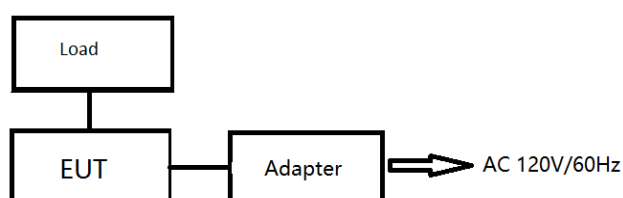

2.5. Description of Test Modes

| Channel | Frequency (KHz) |
|---------|-----------------|
| 1 | 138 |

2.6. Test Conditions

| Items | Required | Actual |
|--------------------|-----------|--------|
| Temperature range: | 15-35°C | 24°C |
| Humidity range: | 25-75% | 56% |
| Pressure range: | 86-106kPa | 98kPa |

2.7. Test Facility

Shenzhen Alpha Product Testing Co., Ltd

Building i, No.2, Lixin Road, Fuyong Street, Bao'an District, 518103, Shenzhen, Guangdong, China

June 21, 2018 File on Federal Communication Commission

Registration Number: 293961

July 15, 2019 Certificated by IC

Registration Number: CN0085

2.8. Measurement Uncertainty

(95% confidence levels, k=2)

| Item | Uncertainty |
|--|---------------------------|
| Uncertainty for Power point Conducted Emissions Test | 1.63dB |
| Uncertainty for Radiation Emission test in 3m chamber (below 30MHz) | 3.5dB |
| Uncertainty for Radiation Emission test in 3m chamber (30MHz to 1GHz) | 3.74dB(Polarize: V) |
| | 3.76dB(Polarize: H) |
| Uncertainty for Radiation Emission test in 3m chamber (1GHz to 25GHz) | 3.77dB(Polarize: V) |
| | 3.80dB(Polarize: H) |
| Uncertainty for radio frequency | 5.06×10^{-8} GHz |
| Uncertainty for conducted RF Power | 0.40dB |
| Uncertainty for temperature | 0.2°C |
| Uncertainty for humidity | 1% |
| Uncertainty for DC and low frequency voltages | 0.06% |

2.9. Test Equipment List

| Equipment | Manufacture | Model No. | Firmware version | Serial No. | Last cal. | Cal Interval |
|-----------------------------|---------------|----------------------|------------------|----------------------------|------------|--------------|
| 9*6*6 anechoic chamber | CHENYU | 9*6*6 | / | N/A | 2022.05.17 | 3Year |
| Spectrum analyzer | ROHDE&SCHWARZ | FSV40-N | 2.3 | 102137 | 2022.08.22 | 1Year |
| Spectrum analyzer | Agilent | N9020A | A.14.16 | MY499100060 | 2022.08.22 | 1Year |
| Receiver | ROHDE&SCHWARZ | ESR | 2.28 SP1 | 1316.3003K03-10 2082-Wa | 2022.08.22 | 1Year |
| Receiver | R&S | ESCI | 4.42 SP1 | 101165 | 2022.08.22 | 1Year |
| Bilog Antenna | Schwarzbeck | VULB 9168 | / | VULB 9168#627 | 2021.08.30 | 2Year |
| Horn Antenna | SCHWARZBECK | BBHA 9120 D | / | 2106 | 2021.08.30 | 2Year |
| Active Loop Antenna | SCHWARZBECK | FMZB 1519B | / | 00059 | 2021.08.30 | 2Year |
| RF Cable | Resenberger | Cable 1 | / | RE1 | 2022.08.22 | 1Year |
| RF Cable | Resenberger | Cable 2 | / | RE2 | 2022.08.22 | 1Year |
| RF Cable | Resenberger | Cable 3 | / | CE1 | 2022.08.22 | 1Year |
| Pre-amplifier | HP | HP8347A | / | 2834A00455 | 2022.08.22 | 1Year |
| Pre-amplifier | Agilent | 8449B | / | 3008A02664 | 2022.08.22 | 1Year |
| L.I.S.N.#1 | Schwarzbeck | NSLK8126 | / | 8126-466 | 2022.08.22 | 1Year |
| L.I.S.N.#2 | ROHDE&SCHWARZ | ENV216 | / | 101043 | 2022.08.23 | 1 Year |
| Horn Antenna | SCHWARZBECK | BBHA9170 | / | 00946 | 2021.08.30 | 2 Year |
| Preamplifier | SKET | LNPA_1840 -50 | / | SK2018101801 | 2022.08.22 | 1 Year |
| Power Meter | Agilent | E9300A | / | MY41496628 | 2022.08.22 | 1 Year |
| Power Sensor | DARE | RPR3006W | / | 15100041SNO91 | 2022.08.22 | 1 Year |
| Temp. & Humid. Chamber | Weihuang | WHTH-1000 -40-880 | / | 100631 | 2022.08.22 | 1 Year |
| Switching Mode Power Supply | JUNKE | JK12010S | / | 20140927-6 | 2022.08.22 | 1 Year |
| Adjustable attenuator | MWRFTest | N/A | / | N/A | N/A | N/A |
| 10dB Attenuator | Mini-Circuits | DC-6G | / | N/A | N/A | N/A |

| Software Information | | | |
|----------------------|---------------|--------------|-----------|
| Test Item | Software Name | Manufacturer | Version |
| RE | EZ-EMC | farad | Alpha-3A1 |
| CE | EZ-EMC | farad | Alpha-3A1 |
| RF-CE | MTS 8310 | MWRFTest | 2.0.0.0 |

3. Test Results and Measurement Data

3.1. Conducted Emission

3.1.1. Test Specification

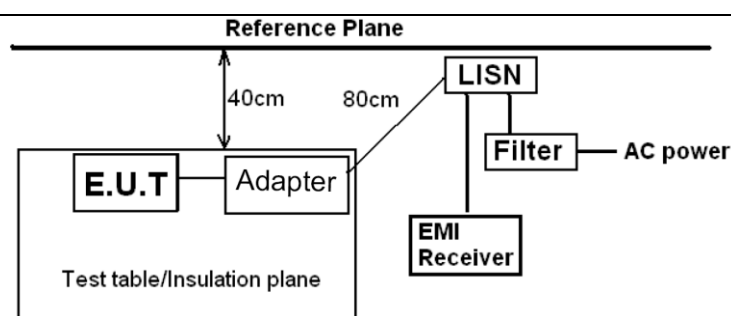
| Test Requirement: | FCC Part15 C Section 15.207 | | | | | | | | | | | | | | |
|--------------------------|---|-----------------------|--------------|--|------------|---------|----------|-----------|-----------|-------|----|----|------|----|----|
| Test Method: | ANSI C63.10:2013 | | | | | | | | | | | | | | |
| Frequency Range: | 150 kHz to 30 MHz | | | | | | | | | | | | | | |
| Receiver setup: | RBW=9 kHz, VBW=30 kHz, Sweep time=auto | | | | | | | | | | | | | | |
| Limits: | <table border="1"> <thead> <tr> <th rowspan="2">Frequency range (MHz)</th> <th colspan="2">Limit (dBuV)</th> </tr> <tr> <th>Quasi-peak</th> <th>Average</th> </tr> </thead> <tbody> <tr> <td>0.15-0.5</td> <td>66 to 56*</td> <td>56 to 46*</td> </tr> <tr> <td>0.5-5</td> <td>56</td> <td>46</td> </tr> <tr> <td>5-30</td> <td>60</td> <td>50</td> </tr> </tbody> </table> | Frequency range (MHz) | Limit (dBuV) | | Quasi-peak | Average | 0.15-0.5 | 66 to 56* | 56 to 46* | 0.5-5 | 56 | 46 | 5-30 | 60 | 50 |
| Frequency range (MHz) | Limit (dBuV) | | | | | | | | | | | | | | |
| | Quasi-peak | Average | | | | | | | | | | | | | |
| 0.15-0.5 | 66 to 56* | 56 to 46* | | | | | | | | | | | | | |
| 0.5-5 | 56 | 46 | | | | | | | | | | | | | |
| 5-30 | 60 | 50 | | | | | | | | | | | | | |
| Test Setup: |  <p><i>Remark:</i> E.U.T: Equipment Under Test LISN: Line Impedance Stabilization Network Test table height=0.8m</p> | | | | | | | | | | | | | | |
| Test Mode: | Transmitting Mode | | | | | | | | | | | | | | |
| Test Procedure: | <ol style="list-style-type: none"> 1. The E.U.T is connected to an adapter through a line impedance stabilization network (L.I.S.N.). This provides a 50ohm/50uH coupling impedance for the measuring equipment. 2. The peripheral devices are also connected to the main power through a LISN that provides a 50ohm/50uH coupling impedance with 50ohm termination. (Please refer to the block diagram of the test setup and photographs). 3. Both sides of A.C. line are checked for maximum conducted interference. In order to find the maximum emission, the relative positions of equipment and all of the interface cables must be changed according to ANSI C63.10: 2013 on conducted measurement. | | | | | | | | | | | | | | |
| Test Result: | PASS | | | | | | | | | | | | | | |

3.1.2. Test data

Please refer to following diagram for individual

| | |
|--------------|---|
| Test Mode | : 138kHz |
| Test Results | : PASS |
| Note: | <p>The test results are listed in next pages.</p> <p>All test modes has been tested, this report only reflected the worst mode.</p> <p>If the limits for the measurement with the average detector are met when using a receiver with a peak detector, the test unit shall be deemed to meet both limits and the measurement with the average detector and quasi-peak detector need not be carried out.</p> <p>If the limits for the measurement with the average detector are met when using a receiver with a quasi-peak detector, the test unit shall be deemed to meet both limits and the measurement with the average detector need not be carried out.</p> |

| | | | |
|------------------------|---------------------------|------------------|-----------|
| EUT Description | Magnetic Wireless Charger | Model No. | MagQoo AS |
| Temperature | 24°C | Humidity | 56% |
| Test Voltage | AC 120V/60Hz | | |
| Pol | Line | | |

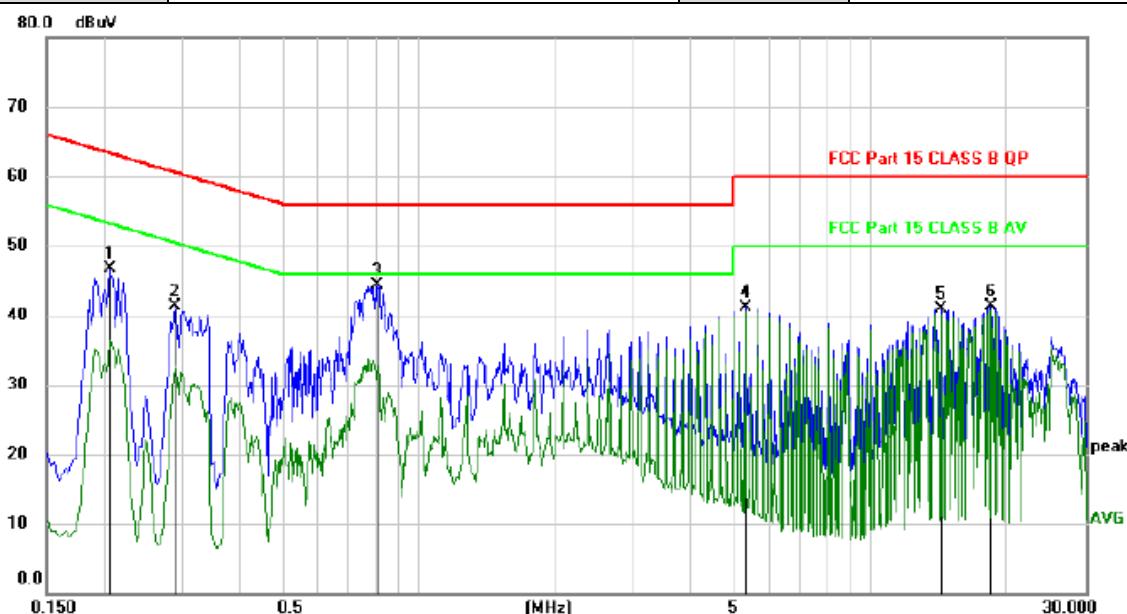

| No. Mk. | Freq. MHz | Reading Level dBuV | Correct Factor dB | Measurement dBuV | Limit dBuV | Margin dB | Detector | Comment |
|---------|-----------|--------------------|-------------------|------------------|------------|-----------|----------|---------|
| 1 | 0.2070 | 36.70 | 9.93 | 46.63 | 63.32 | -16.69 | peak | |
| 2 | 0.2880 | 31.31 | 9.93 | 41.24 | 60.58 | -19.34 | peak | |
| 3 * | 0.8130 | 34.31 | 9.94 | 44.25 | 56.00 | -11.75 | peak | |
| 4 | 5.2920 | 31.15 | 10.05 | 41.20 | 60.00 | -18.80 | peak | |
| 5 | 14.3520 | 30.69 | 10.31 | 41.00 | 60.00 | -19.00 | peak | |
| 6 | 18.4710 | 30.80 | 10.43 | 41.23 | 60.00 | -18.77 | peak | |

*:Maximum data x:Over limit !:over margin (Reference Only)
 Note: Measurement=Reading Level+Correc Factor. Factor=(LISN or ISN or PLC or Current Probe)Factor+Cable

| | |
|-----|---------|
| Pol | Neutral |
|-----|---------|

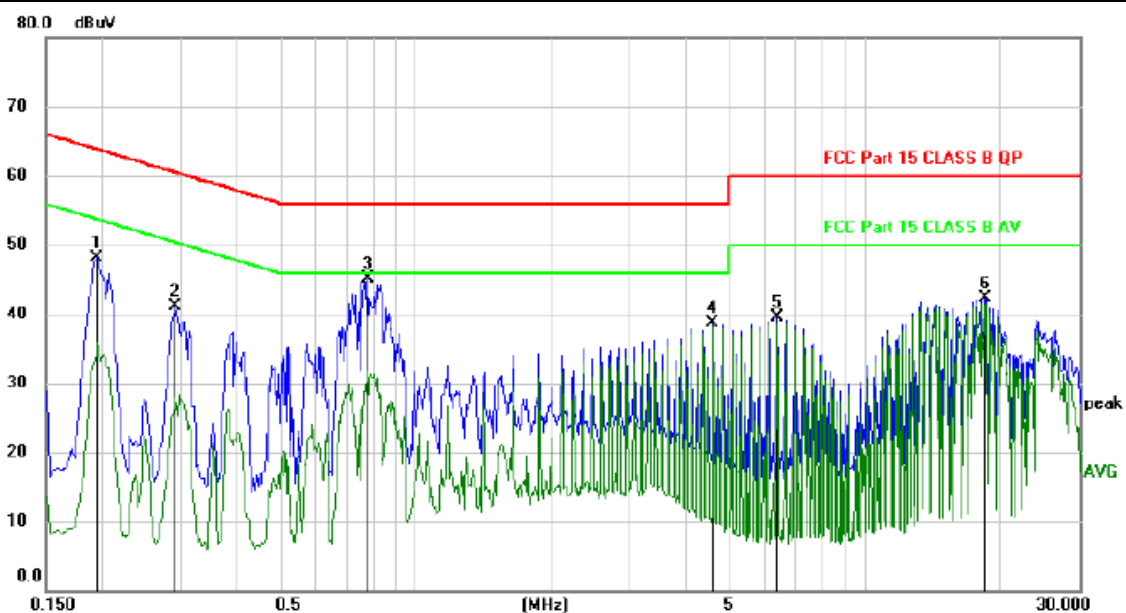

| No. | Mk. | Freq. MHz | Reading Level dBuV | Correct Factor dB | Measure- ment dBuV | Limit dBuV | Margin dB | Detector | Comment |
|-----|-----|--------------|--------------------------|-------------------------|--------------------------|---------------|--------------|----------|---------|
| 1 | | 0.1949 | 38.28 | 9.92 | 48.20 | 63.83 | -15.63 | peak | |
| 2 | | 0.2910 | 31.10 | 9.93 | 41.03 | 60.50 | -19.47 | peak | |
| 3 | * | 0.7830 | 35.08 | 9.94 | 45.02 | 56.00 | -10.98 | peak | |
| 4 | | 4.5930 | 28.62 | 10.01 | 38.63 | 56.00 | -17.37 | peak | |
| 5 | | 6.3810 | 29.32 | 10.10 | 39.42 | 60.00 | -20.58 | peak | |
| 6 | | 18.4890 | 31.86 | 10.43 | 42.29 | 60.00 | -17.71 | peak | |

*:Maximum data x:Over limit !:over margin (Reference Only)
 Note: Measurement=Reading Level+Correc Factor. Factor=(LISN or ISN or PLC or Current Probe)Factor+Cable

*:Maximum data x:Over limit !:over margin
 Note: Measurement=Reading Level+Correc Factor. Factor=(LISN or ISN or PLC or Current Probe)Factor+Cable

3.2. Radiated Spurious Emission Measurement

3.2.1. Test Specification

| | | | | | |
|------------------------------|------------------------------------|------------|-----------------------------------|-------------------------------|-------------------------------|
| Test Requirement: | FCC Part15 C Section 15.209 | | | | |
| Test Method: | ANSI C63.10: 2013 | | | | |
| Frequency Range: | 9 kHz to 25 GHz | | | | |
| Measurement Distance: | 3 m | | | | |
| Antenna Polarization: | Horizontal & Vertical | | | | |
| Operation mode: | Refer to item 4.1 | | | | |
| Receiver Setup: | Frequency | Detector | RBW | VBW | Remark |
| | 9kHz-150kHz | Quasi-peak | 200Hz | 1kHz | Quasi-peak Value |
| | 150kHz-30MHz | Quasi-peak | 9kHz | 30kHz | Quasi-peak Value |
| | 30MHz-1GHz | Quasi-peak | 100kHz | 300kHz | Quasi-peak Value |
| | Above 1GHz | Peak | 1MHz | 3MHz | Peak Value |
| | | Peak | 1MHz | 10Hz | Average Value |
| Limit: | Frequency | | Field Strength (microvolts/meter) | | Measurement Distance (meters) |
| | 0.009-0.490 | | 2400/F(KHz) | | 300 |
| | 0.490-1.705 | | 24000/F(KHz) | | 30 |
| | 1.705-30 | | 30 | | 30 |
| | 30-88 | | 100 | | 3 |
| | 88-216 | | 150 | | 3 |
| | 216-960 | | 200 | | 3 |
| | Above 960 | | 500 | | 3 |
| | Frequency | | Field Strength (microvolts/meter) | Measurement Distance (meters) | Detector |
| | Above 1GHz | | 500 | 3 | Average |
| | | 5000 | 3 | Peak | |
| Test setup: | For radiated emissions below 30MHz | | | | |
| | <p>30MHz to 1GHz</p> | | | | |

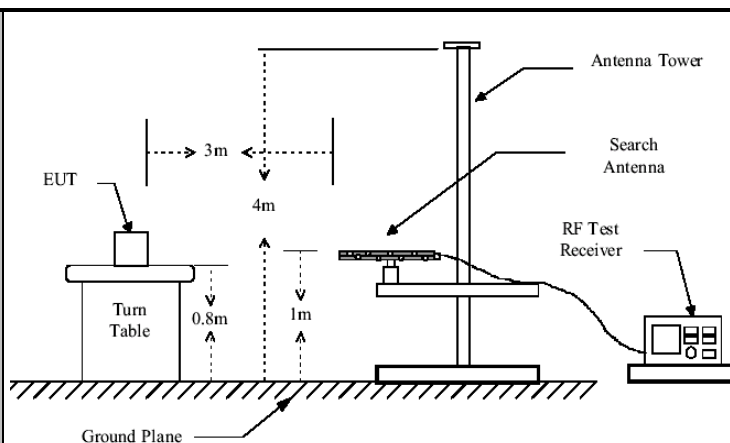

Above 1GHz

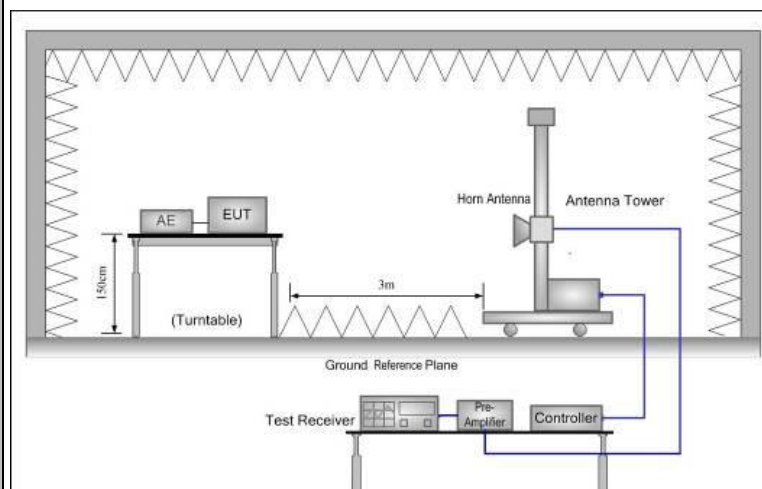
**Test Procedure:****1. For the radiated emission test below 1GHz:**

The EUT was placed on a turntable with 0.8 meter above ground. The EUT was set 3 meters from the interference receiving antenna, which was mounted on the top of a variable height antenna tower. The EUT was arranged to its worst case and then tune the antenna tower (from 1 m to 4 m) and turntable (from 0 degree to 360 degrees) to find the maximum reading. A pre-amp and a high PASS filter are used for the test in order to get better signal level.

For the radiated emission test above 1GHz:

Place the measurement antenna on a turntable with 1.5 meter above ground, which is away from each area of the EUT determined to be a source of emissions at the specified measurement distance, while keeping the measurement antenna aimed at the source of emissions at each frequency of significant emissions, with polarization oriented for maximum response. The measurement antenna may have to be higher or lower than the EUT, depending on the radiation pattern of the emission and staying aimed at the emission source for receiving the maximum signal. The final measurement antenna elevation shall be that which maximizes the emissions. The measurement antenna elevation for maximum emissions shall be restricted to a range of heights of from 1 m to 4 m above the ground or reference ground plane.

2. Corrected Reading: Antenna Factor + Cable Loss + Read Level - Preamp Factor = Level
3. For measurement below 1GHz, If the emission level of the EUT measured by the peak detector is 3 dB lower than the applicable limit, the peak emission level will be reported.

| | |
|----------------------|---|
| | <p>Otherwise, the emission measurement will be repeated using the quasi-peak detector and reported.</p> <p>4. Use the following spectrum analyzer settings:</p> <p>(1) Span shall wide enough to fully capture the emission being measured;</p> <p>(2) Set RBW=100 kHz for $f < 1$ GHz; $VBW \geq RBW$; Sweep = auto; Detector function = peak; Trace = max hold;</p> <p>(3) Set RBW = 1 MHz, $VBW = 3$ MHz for $f \geq 1$ GHz for peak measurement.</p> <p>For average measurement: $VBW = 10$ Hz, when duty cycle is no less than 98 percent. $VBW \geq 1/T$, when duty cycle is less than 98 percent where T is the minimum transmission duration over which the transmitter is on and is transmitting at its maximum power control level for the tested mode of operation.</p> |
| Test mode: | Refer to section 4.1 for details |
| Test results: | PASS |

3.2.2. Test Data

Please refer to following diagram for individual

| | |
|-----------------|---|
| Frequency Range | : 9KHz~30MHz |
| Test Mode | : 138kHz |
| Test Results | : PASS |
| Note: | <ol style="list-style-type: none">1. The test results are listed in next pages.2. This mode is worst case mode, so this report only reflected the worst mode.3. If the limits for the measurement with the average detector are met when using a receiver with a peak detector, the test unit shall be deemed to meet both limits and the measurement with the quasi-peak detector need not be carried out. |

For signal coil:

Polarity: X axis

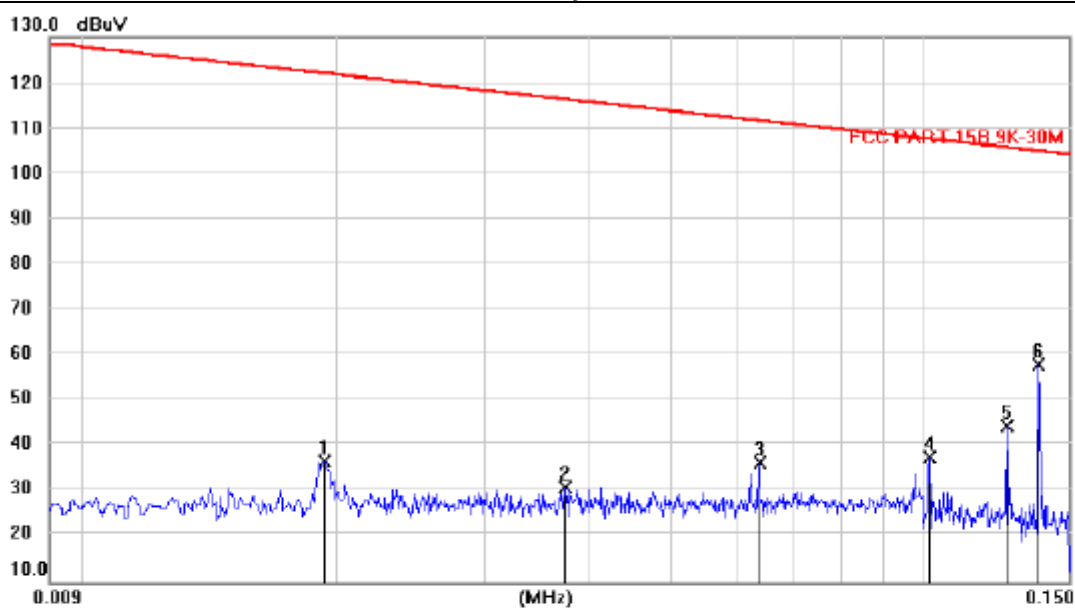

| No. | Mk. | Freq. MHz | Reading Level dBuV | Correct Factor dB | Measure- ment dBuV | Limit dBuV | Margin dB | Antenna Height cm | Table Degree | Comment |
|-----|-----|--------------|--------------------------|-------------------------|--------------------------|---------------|--------------|-------------------------|-----------------|---------|
| 1 | | 0.0192 | 15.39 | 21.27 | 36.66 | 122.0 | -85.39 | | | peak |
| 2 | | 0.0374 | 10.27 | 20.59 | 30.86 | 116.2 | -85.41 | | | peak |
| 3 | | 0.0638 | 16.15 | 20.11 | 36.26 | 111.6 | -75.39 | | | peak |
| 4 | | 0.1020 | 17.80 | 19.78 | 37.58 | 107.5 | -70.01 | | | peak |
| 5 | | 0.1265 | 24.58 | 19.87 | 44.45 | 105.7 | -61.27 | | | peak |
| 6 | * | 0.1381 | 37.75 | 20.02 | 57.77 | 104.9 | -47.19 | | | peak |

Note: 1. *:Maximum data; x:Over limit; !:over margin.

2.Measurement=Reading Level+Correct Factor; Correct Factor=Antenna Factor+Cable Loss.

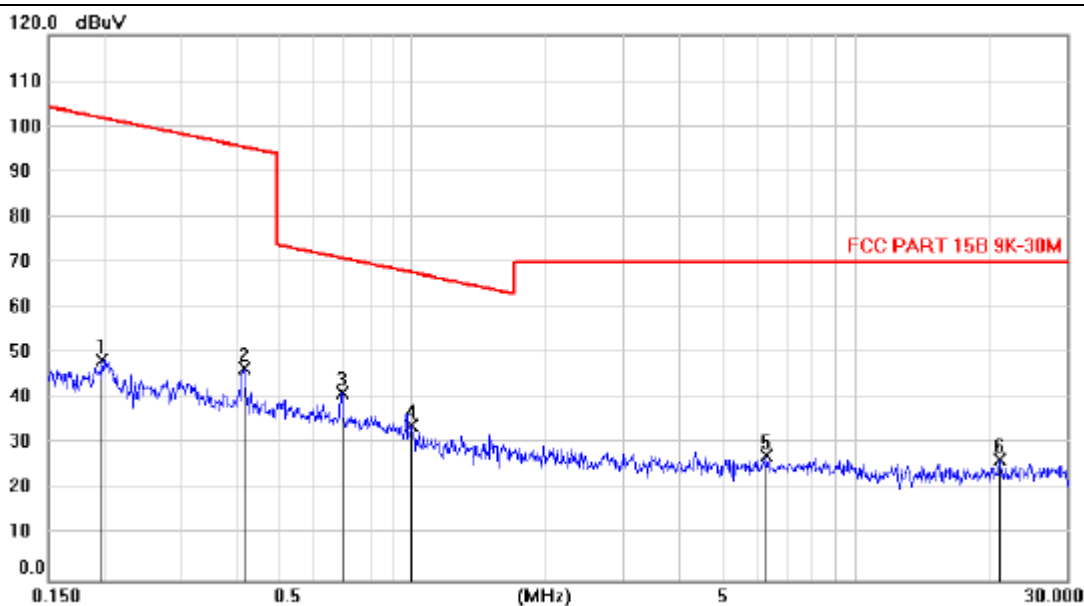

| No. | Mk. | Freq. MHz | Reading Level dBuV | Correct Factor dB | Measure- ment dBuV | Limit dBuV | Margin dB | Detector | Antenna Height cm | Table Degree | Comment |
|-----|-----|--------------|--------------------------|-------------------------|--------------------------|---------------|--------------|----------|-------------------------|-----------------|---------|
| 1 | | 0.1993 | 28.39 | 20.13 | 48.52 | 101.8 | -53.29 | peak | | | |
| 2 | | 0.4150 | 26.75 | 19.82 | 46.57 | 95.44 | -48.87 | peak | | | |
| 3 | * | 0.6916 | 21.55 | 19.81 | 41.36 | 70.96 | -29.60 | peak | | | |
| 4 | | 0.9990 | 14.13 | 20.00 | 34.13 | 67.72 | -33.59 | peak | | | |
| 5 | | 6.2941 | 5.25 | 22.31 | 27.56 | 70.00 | -42.44 | peak | | | |
| 6 | | 21.2258 | 7.03 | 19.53 | 26.56 | 70.00 | -43.44 | peak | | | |

Note: 1. *: Maximum data; x: Over limit; !: over margin.

2. Measurement=Reading Level+Correct Factor; Correct Factor=Antenna Factor+Cable Loss.

| | |
|-----------------|--|
| Frequency Range | : 30MHz~1000MHz |
| Test Mode | : TX: 138kHz |
| Test Results | : PASS |
| Note: | <ol style="list-style-type: none"> 1. The test results are listed in next pages. 2. All test modes has been tested, this report only reflected the worst mode. 3. If the limits for the measurement with the average detector are met when using a receiver with a peak detector, the test unit shall be deemed to meet both limits and the measurement with the quasi-peak detector need not be carried out. |

| | | | |
|-----------------|---|-------------|-----|
| Frequency Range | : Above 1GHz | | |
| EUT | : / | Test Date | : / |
| M/N | : / | Temperature | : / |
| Test Engineer | : / | Humidity | : / |
| Test Mode | : / | | |
| Test Results | : N/A | | |
| Note: | <ol style="list-style-type: none"> 1. The highest frequency of the internal sources of the EUT is less than 108 MHz, the measurement shall only be made up to 1 GHz. So the frequency rang above 1GHz radiation test not applicable. | | |

30MHz-1GHz

| | | | |
|------------------------|---------------------------|------------------|-----------|
| EUT Description | Magnetic Wireless Charger | Model No. | MagQoo AS |
| Temperature | 24°C | Humidity | 56% |
| Test Voltage | AC 120V/60Hz | | |
| Pol | Vertical | | |

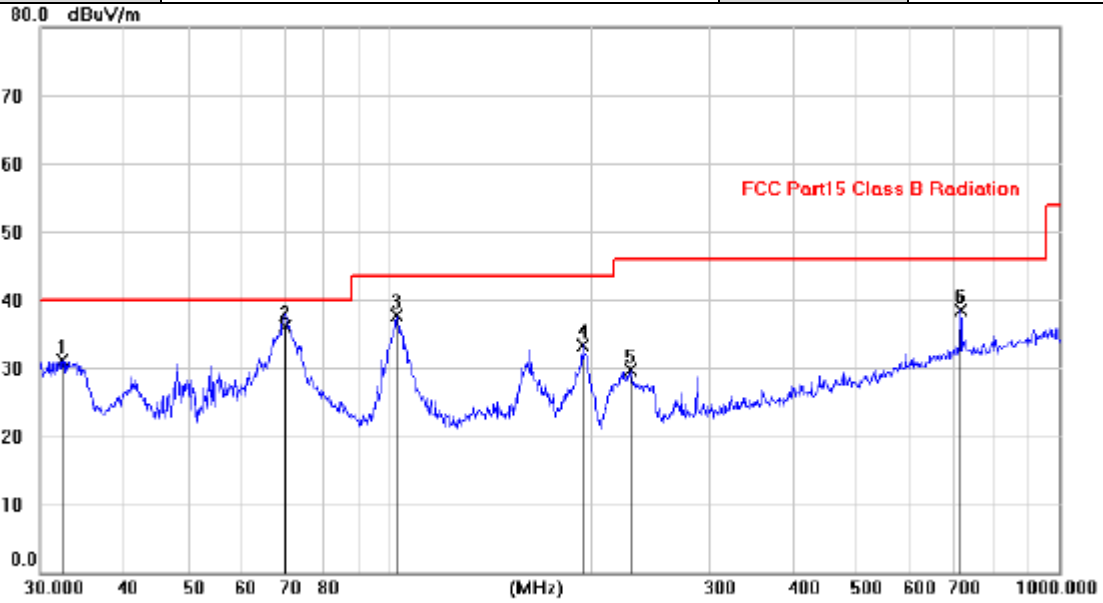

| No. | Mk. | Freq. MHz | Reading Level dBuV | Correct Factor dB | Measure- ment dBuV/m | Limit dBuV/m | Margin dB | Antenna Height cm | Table Degree | Comment |
|-----|-----|--------------|--------------------------|-------------------------|----------------------------|-----------------|--------------|-------------------------|-----------------|---------|
| 1 | | 32.4097 | 17.41 | 13.62 | 31.03 | 40.00 | -8.97 | | | peak |
| 2 | * | 69.9280 | 24.69 | 11.42 | 36.11 | 40.00 | -3.89 | 100 | 0 | |
| 3 | | 102.4434 | 26.58 | 11.09 | 37.67 | 43.50 | -5.83 | | | peak |
| 4 | | 194.3853 | 22.18 | 11.22 | 33.40 | 43.50 | -10.10 | | | peak |
| 5 | | 228.9449 | 17.42 | 12.25 | 29.67 | 46.00 | -16.33 | | | peak |
| 6 | | 713.0056 | 16.56 | 21.91 | 38.47 | 46.00 | -7.53 | | | peak |

Note:1. *:Maximum data; x:Over limit; !:over margin.

2.Measurement=Reading Level+Correct Factor; Correct Factor=Antenna Factor+Cable Loss.

| | |
|------------|------------|
| Pol | Horizontal |
|------------|------------|

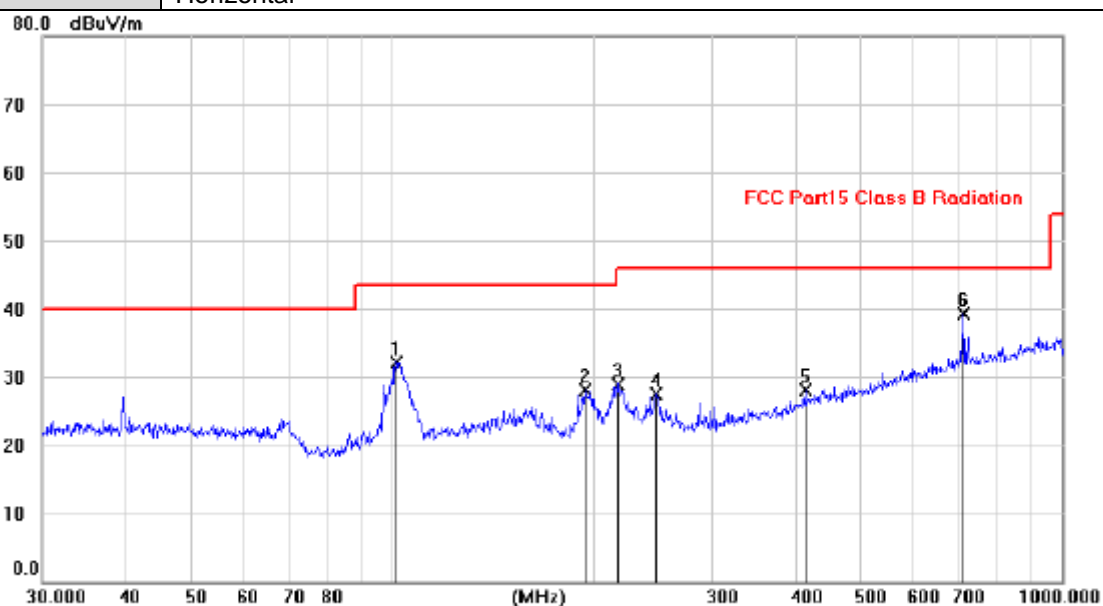

| No. | Mk. | Freq. MHz | Reading Level dBuV | Correct Factor dB | Measure- ment dBuV/m | Limit dBuV/m | Margin dB | Antenna Height cm | Table Degree | Comment |
|-----|-----|--------------|--------------------------|-------------------------|----------------------------|-----------------|--------------|-------------------------|-----------------|---------|
| 1 | | 101.6205 | 21.19 | 11.01 | 32.20 | 43.50 | -11.30 | peak | | |
| 2 | | 194.5898 | 16.93 | 11.21 | 28.14 | 43.50 | -15.36 | peak | | |
| 3 | | 217.5189 | 17.42 | 11.58 | 29.00 | 46.00 | -17.00 | peak | | |
| 4 | | 248.0006 | 14.70 | 12.73 | 27.43 | 46.00 | -18.57 | peak | | |
| 5 | | 414.3832 | 11.53 | 16.60 | 28.13 | 46.00 | -17.87 | peak | | |
| 6 | * | 713.6727 | 17.34 | 21.93 | 39.27 | 46.00 | -6.73 | peak | | |

Note: 1. *: Maximum data; x: Over limit; !: over margin.

2. Measurement = Reading Level + Correct Factor; Correct Factor = Antenna Factor + Cable Loss.

3.3. Test Specification

| | |
|--------------------------|--|
| Test Requirement: | FCC Part15 C Section 15.215(c) |
| Test Method: | ANSI C63.10: 2013 |
| Limit: | N/A |
| Test Procedure: | <ol style="list-style-type: none"> 1. According to the follow Test-setup, keep the relative position between the artificial antenna and the EUT. 2. Set to the maximum power setting and enable the EUT transmit continuously. 3. Use the following spectrum analyzer settings for 20dB Bandwidth measurement. Span = approximately 2 to 3 times the 20 dB bandwidth, centered on a hopping channel; RBW\geq1% of the 20 dB bandwidth; VBW\geqRBW; Sweep = auto; Detector function = peak; Trace = max hold. 4. Measure and record the results in the test report. |
| Test setup: |  <p>The diagram illustrates the test setup. On the left is a Spectrum Analyzer, represented by a green rectangle with a blue screen and two red dots. A black cable connects the Spectrum Analyzer to a yellow rectangle on the right, which is labeled 'EUT'. A small white square is positioned between the two devices, representing a connector or adapter. Below the Spectrum Analyzer is the text 'Spectrum Analyzer' and below the EUT is the text 'EUT'.</p> |
| Test Mode: | Refer to section 4.1 for details |
| Test results: | PASS |

3.3.1. Test data

For Watch:

| Frequency(kHz) | 20dB Occupy Bandwidth (kHz) | Limit (kHz) | Conclusion |
|----------------|-----------------------------|-------------|------------|
| 138 | 0.268 | --- | Pass |

Test plots as follows:

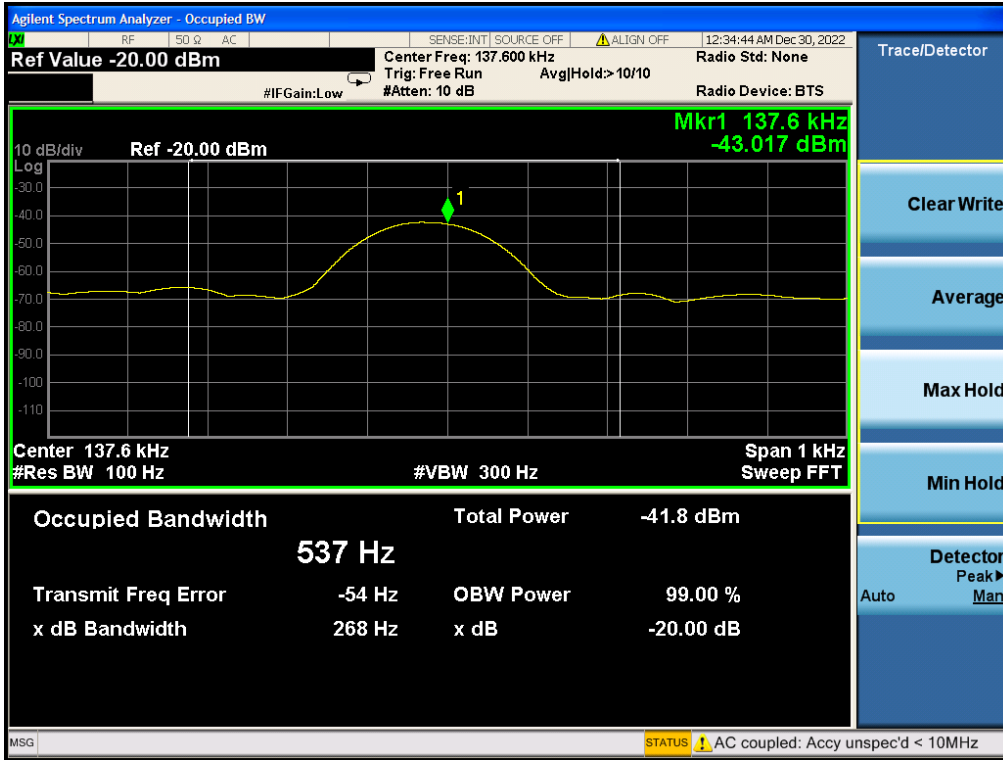

4. Photos of test setup

Radiated Emission

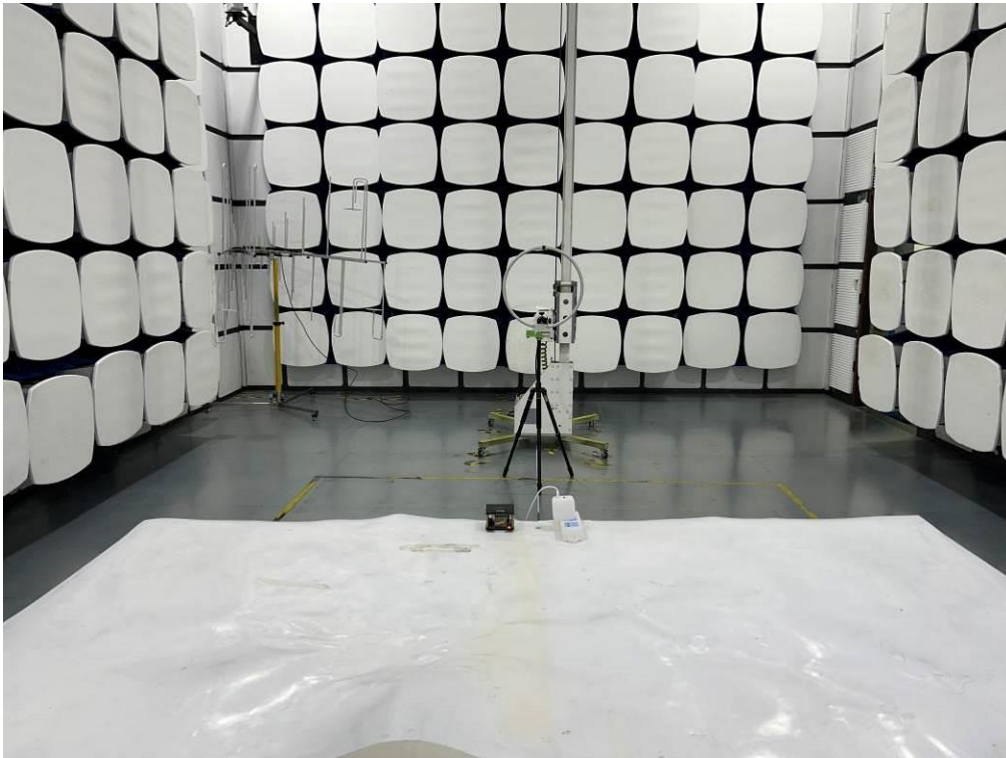

Conducted Emission

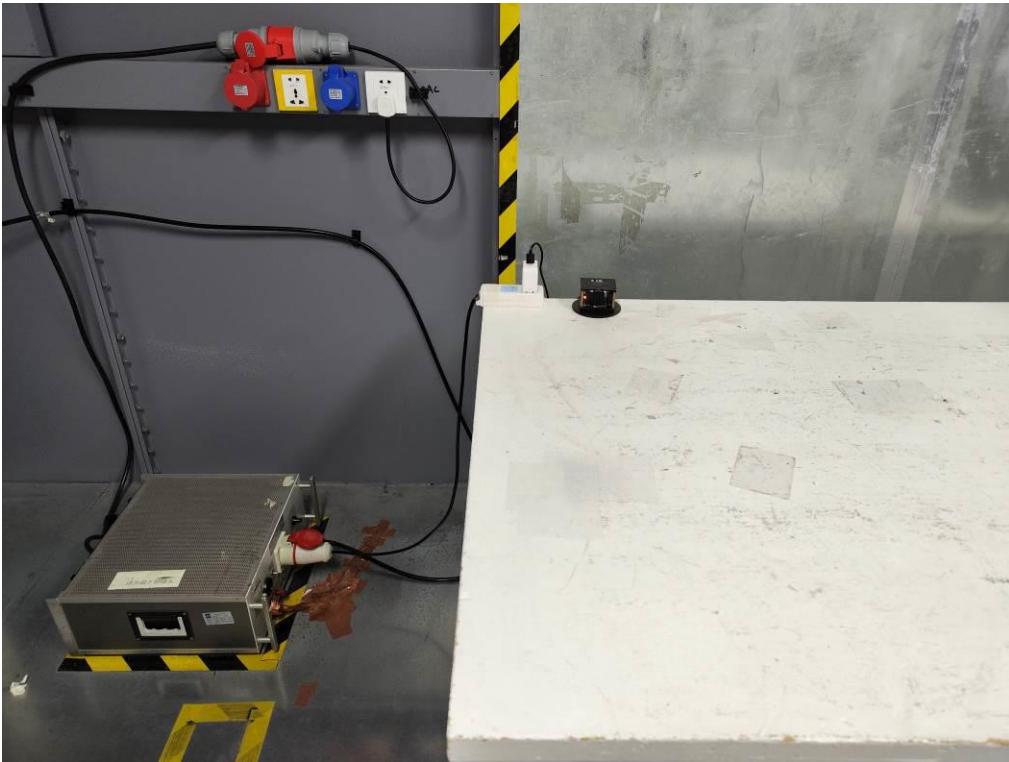

5. Photographs of EUT

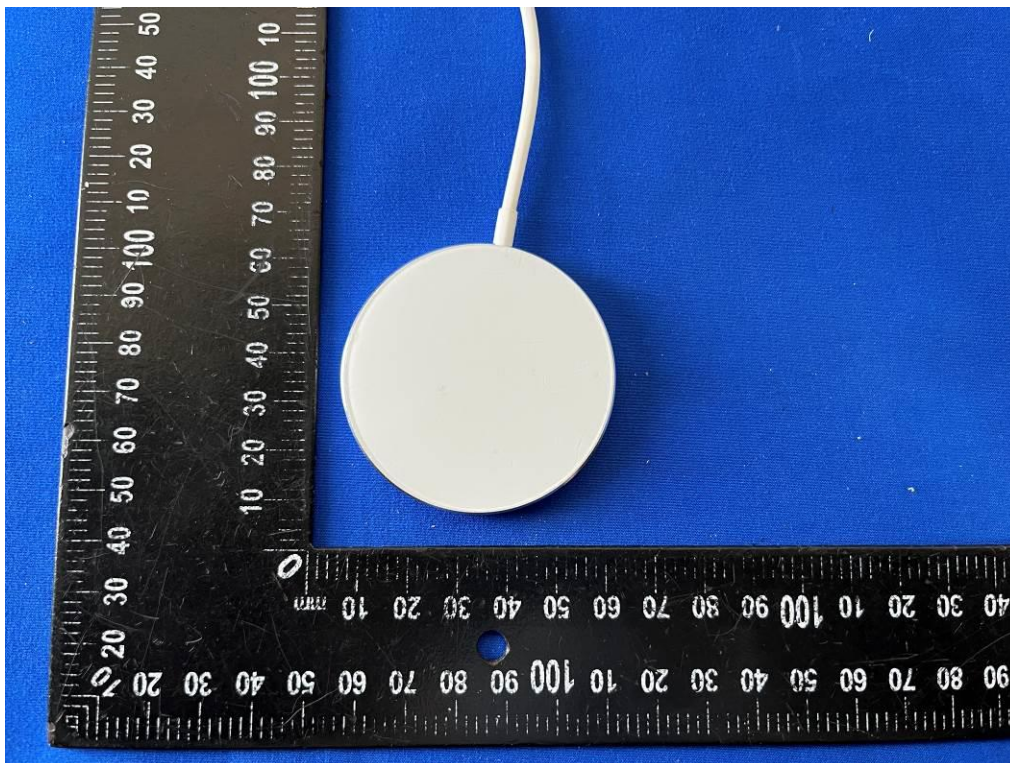

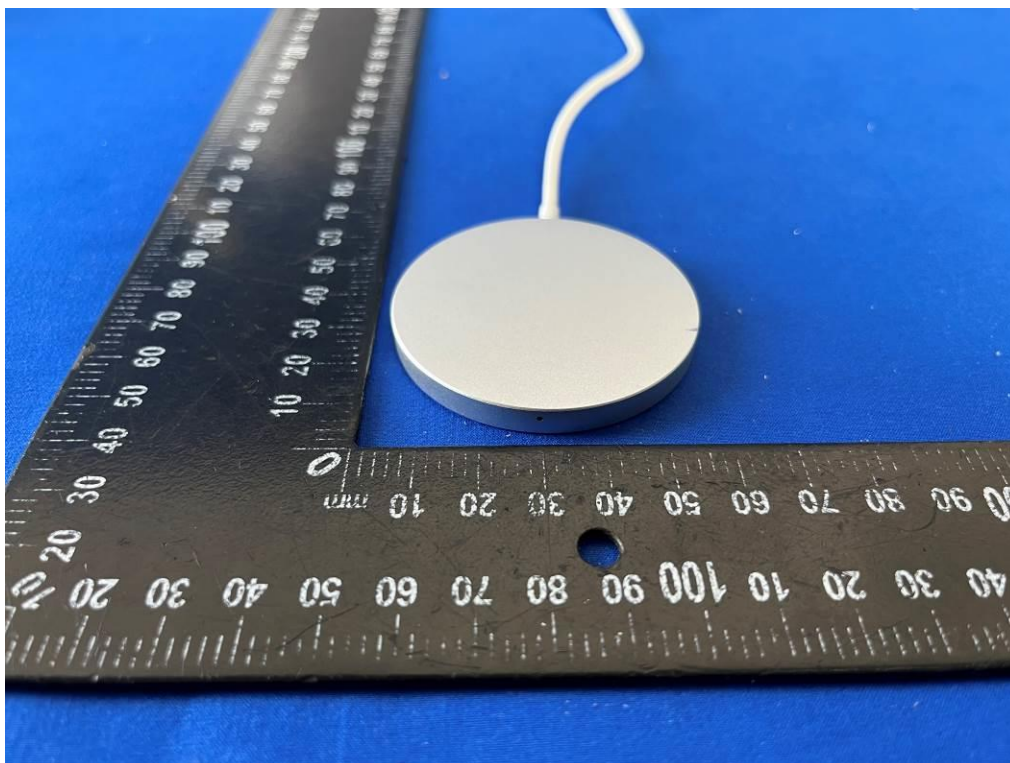
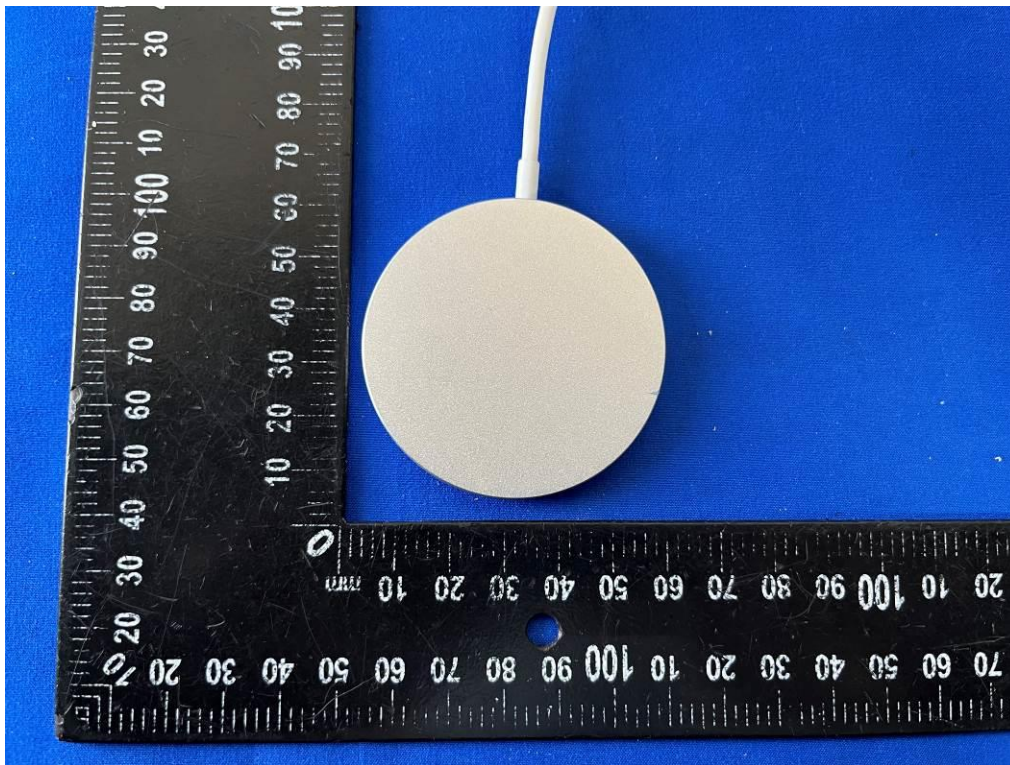

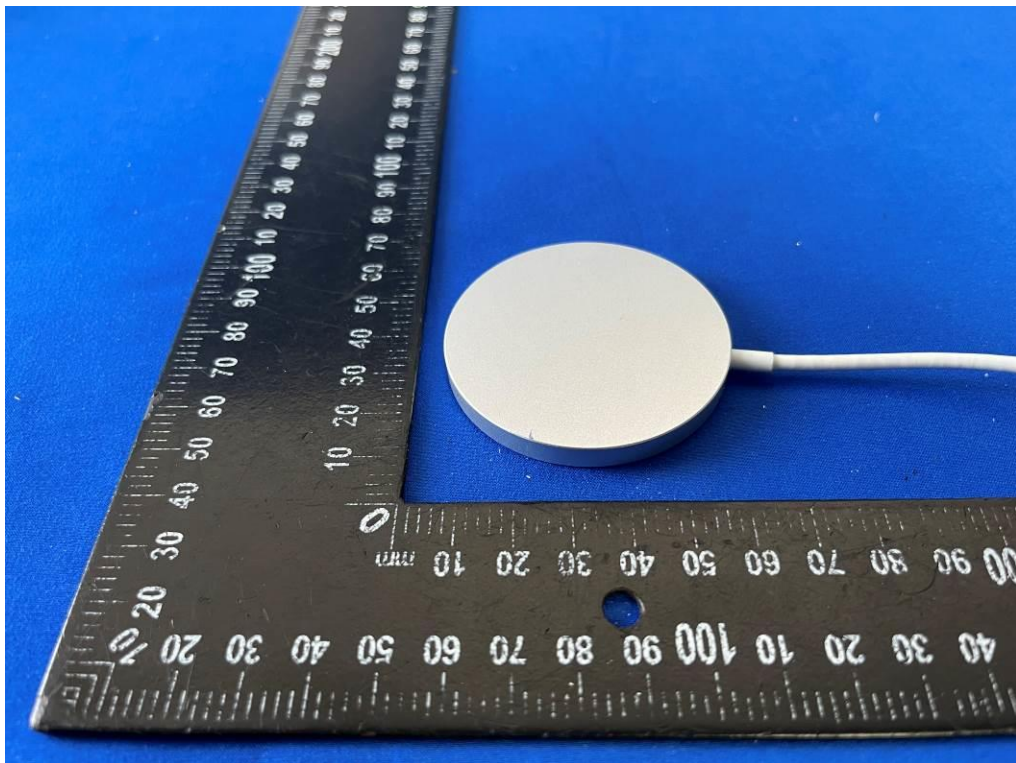
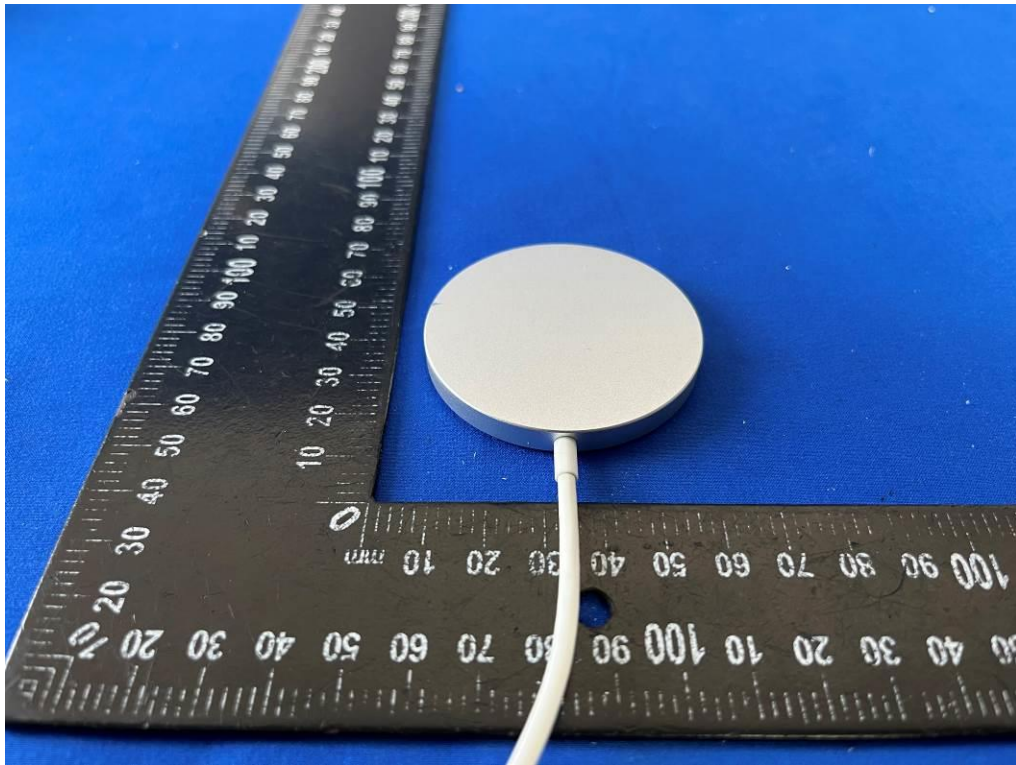

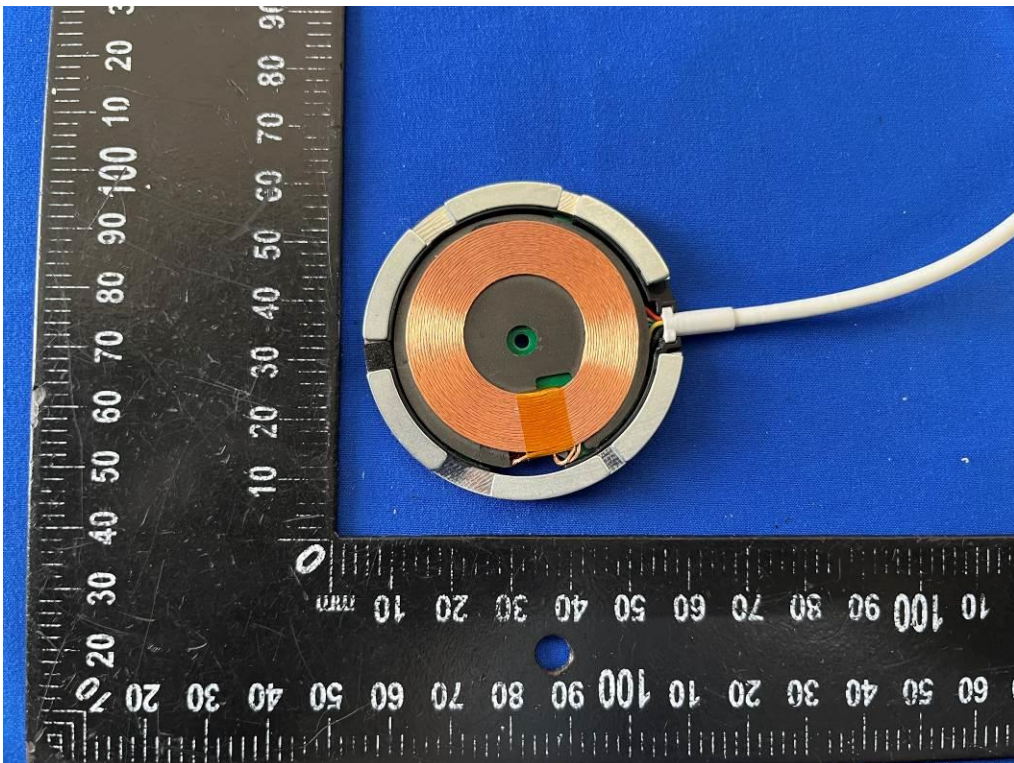
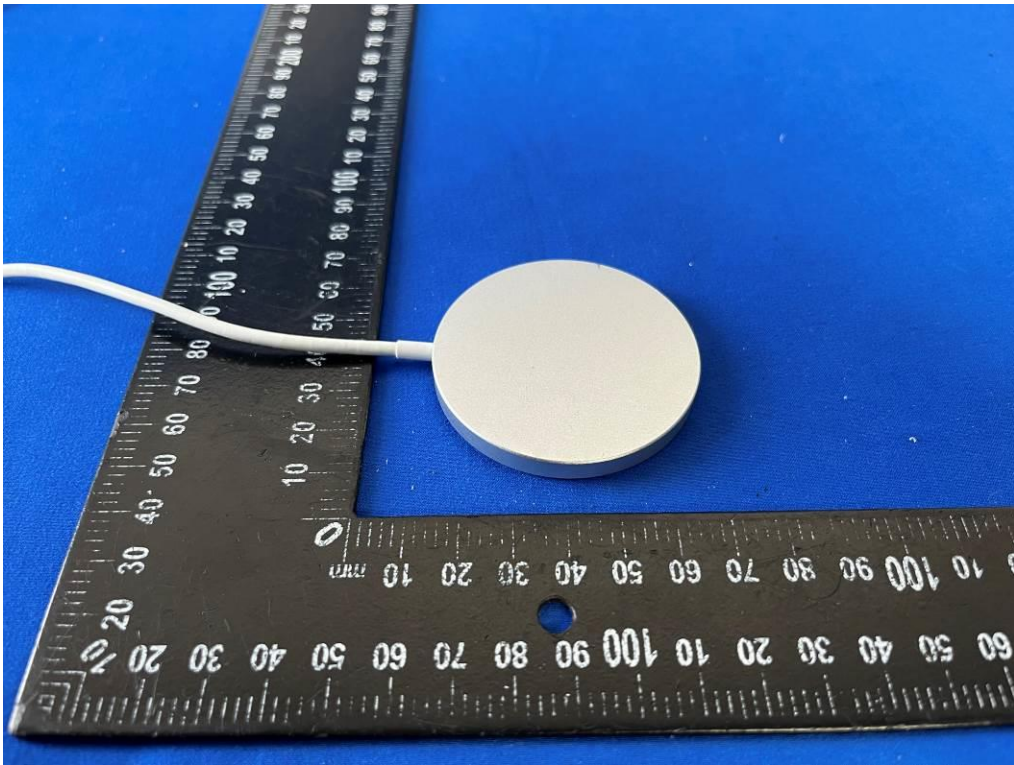

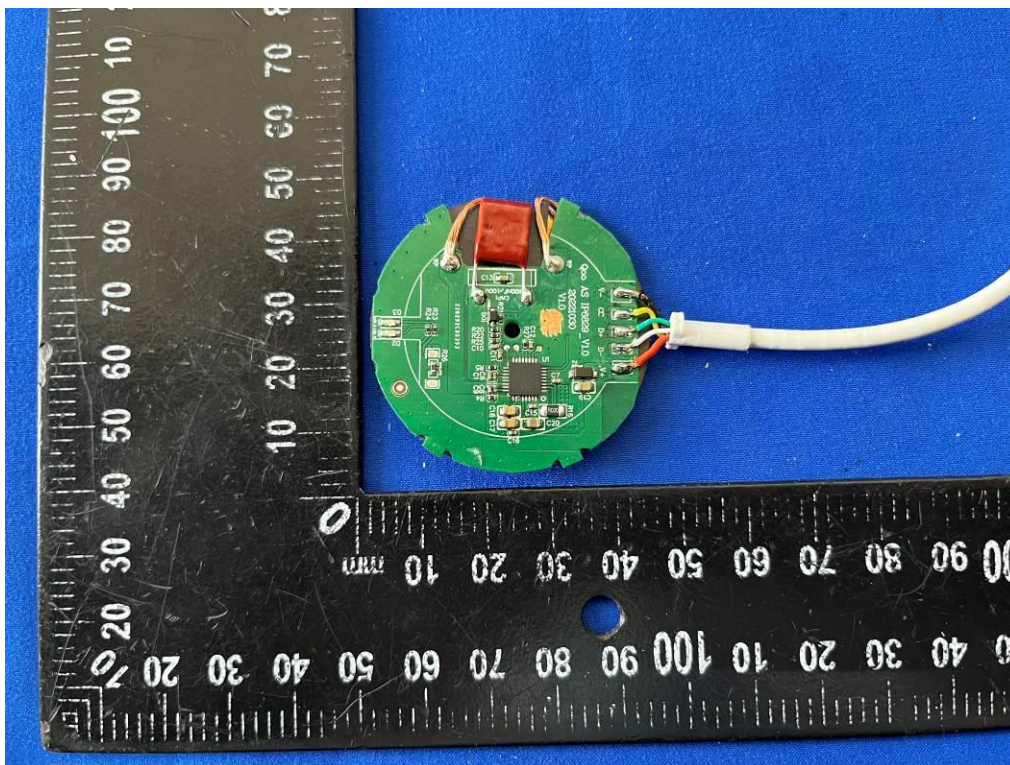
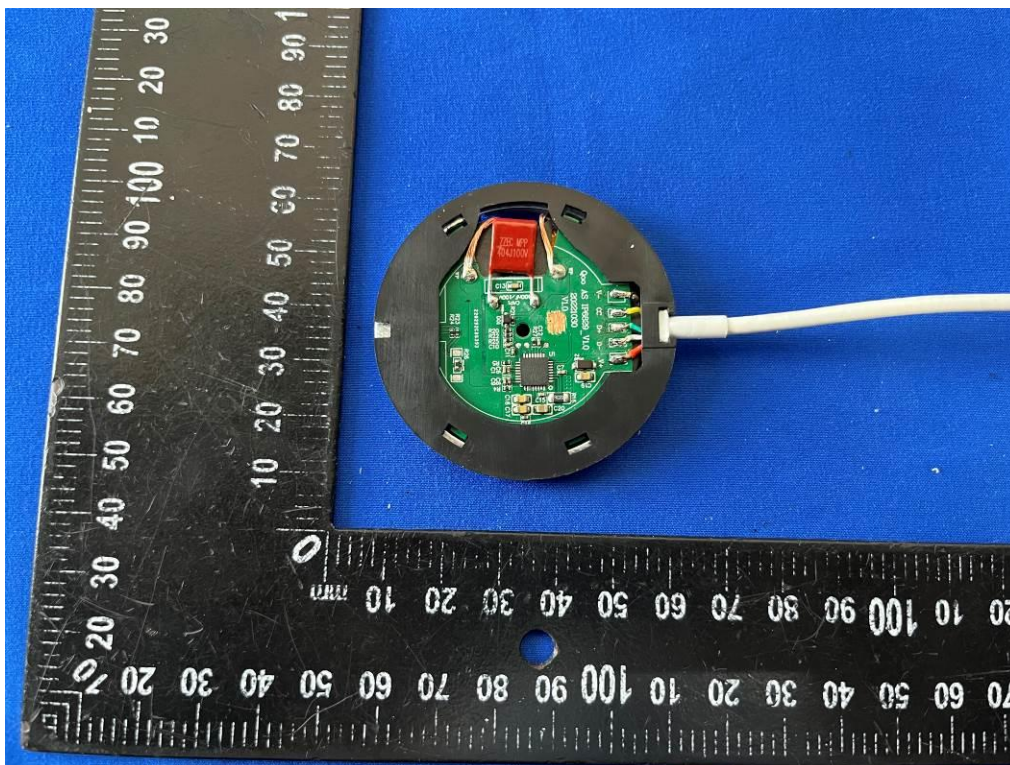

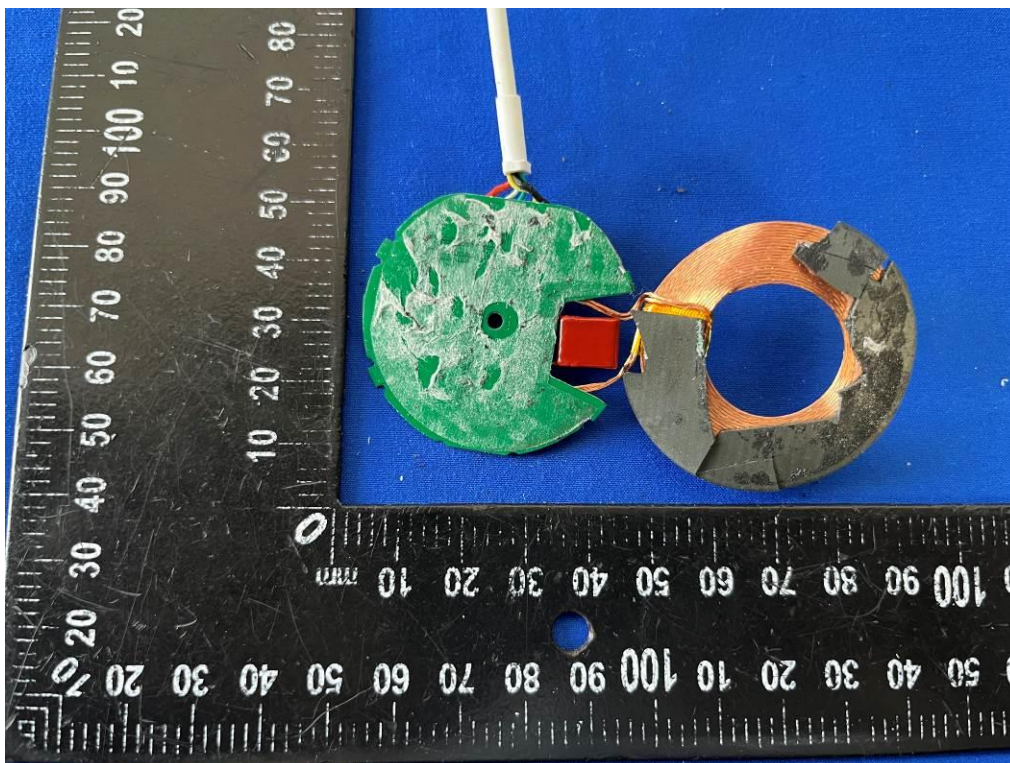
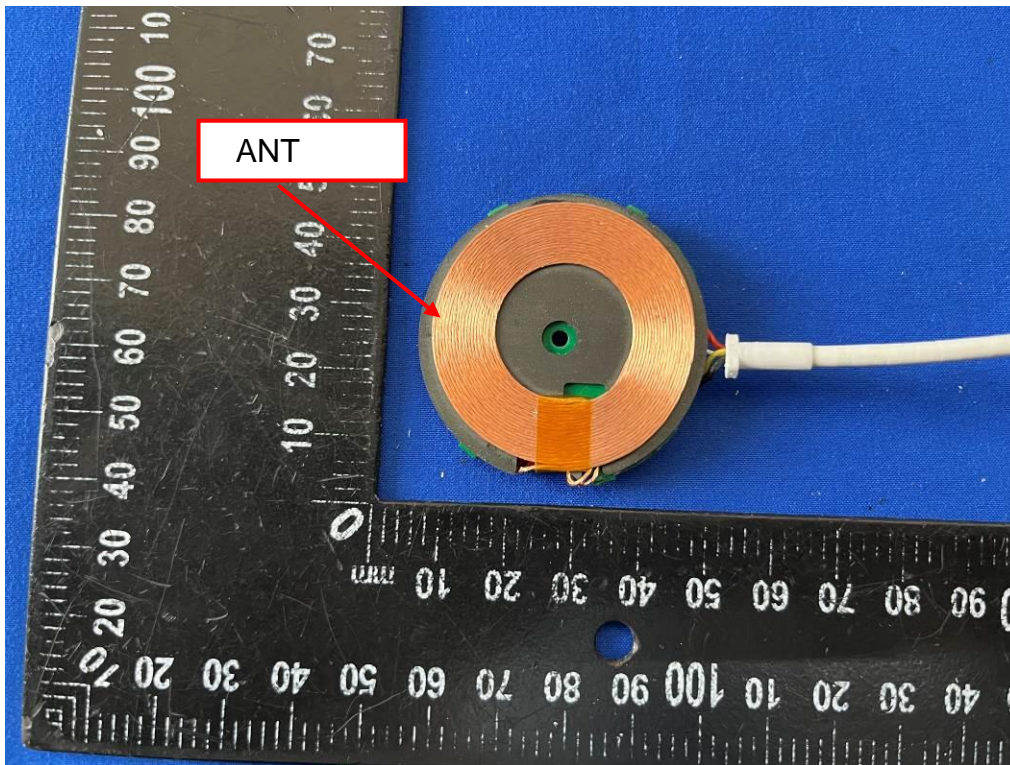

-----END OF REPORT-----