



**FCC TEST REPORT**  
**FCC ID: 2AP2N-MAGHOLDC02**

On Behalf of

**Shenzhen Esorun Technology Co., LTD**  
**Magnet Wireless Charging Car Mount**  
**Model No.: Maghold C02**

Prepared for : Shenzhen Esorun Technology Co., LTD  
Address : Room 226, Building A, B, C, Zone B, Yuanfen Industrial Zone, Taoyuan  
Community, Dalang Street, Longhua District, Shenzhen

Prepared By : Shenzhen Alpha Product Testing Co., Ltd.  
Address : Building i, No.2, Lixin Road, Fuyong Street, Bao'an District,  
518103, Shenzhen, Guangdong, China

Report Number : A2205162-C01-R06  
Date of Receipt : May 26, 2022  
Date of Test : May 27, 2022-June 9, 2022  
Date of Report : June 9, 2022  
Version Number : V0

---

## TABLE OF CONTENTS

1.	Test Result Summary .....	5
2.	General Information .....	6
2.1.	DESCRIPTION OF DEVICE (EUT).....	6
2.2.	ACCESSORIES OF DEVICE (EUT).....	7
2.3.	TESTED SUPPORTING SYSTEM DETAILS .....	7
2.4.	BLOCK DIAGRAM OF CONNECTION BETWEEN EUT AND SIMULATORS .....	7
2.5.	DESCRIPTION OF TEST MODES.....	7
2.6.	TEST CONDITIONS .....	7
2.7.	TEST FACILITY .....	8
2.8.	MEASUREMENT UNCERTAINTY .....	8
2.9.	TEST EQUIPMENT LIST.....	9
3.	Test Results and Measurement Data .....	10
3.1.	CONDUCTED EMISSION .....	10
3.2.	RADIATED SPURIOUS EMISSION MEASUREMENT .....	13
3.3.	TEST SPECIFICATION .....	20
4.	Photos of test setup .....	22
5.	Photographs of EUT .....	24

### TEST REPORT DECLARATION

Applicant : Shenzhen Esorun Technology Co., LTD  
 Address : Room 226, Building A, B, C, Zone B, Yuanfen Industrial Zone, Taoyuan Community, Dalang Street, Longhua District, Shenzhen  
 Manufacturer : Shenzhen Esorun Technology Co., LTD  
 Address : Room 226, Building A, B, C, Zone B, Yuanfen Industrial Zone, Taoyuan Community, Dalang Street, Longhua District, Shenzhen  
 EUT Description : Magnet Wireless Charging Car Mount  
 (A) Model No. : Maghold C02  
 (B) Trademark : ESORUN

Measurement Standard Used:

**FCC CFR Title 47 Part 15 Subpart C Section 15.209**

The device described above is tested by Shenzhen Alpha Product Testing Co., Ltd. to determine the maximum emission levels emanating from the device and the severe levels of the device can endure and its performance criterion. The test results are contained in this test report and Shenzhen Alpha Product Testing Co., Ltd. is assumed full responsibility for the accuracy and completeness of test. Also, this report shows that the EUT is technically compliant with the FCC CFR Title 47 Part 15 Subpart C Section 15.209 requirements.

This report applies to above tested sample only. This report shall not be reproduced in parts without written approval of Shenzhen Alpha Product Testing Co., Ltd.

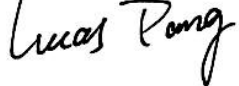
Tested by (name + signature).....: Lucas Pang  
 Project Engineer 

Approved by (name + signature).....: Simple Guan  
 Project Manager 

Date of issue..... : June 9, 2022

**Revision History**

Revision	Issue Date	Revisions	Revised By
V0	June 9, 2022	Initial released Issue	Lucas Pang

## 1. Test Result Summary

Requirement	CFR 47 Section	Result
Antenna requirement	§15.203	PASS
AC Power Line Conducted Emission	§15.207	PASS
Spurious Emission	§15.209(a)(f)	PASS
Occupied Bandwidth	§15.215 (c)	PASS

**Note:**

1. *PASS: Test item meets the requirement.*
2. *Fail: Test item does not meet the requirement.*
3. *N/A: Test case does not apply to the test object.*
4. *The test result judgment is decided by the limit of test standard.*
5. Decision rules for the conclusion of this test report: decision by actual test data without considering measurement uncertainty.

## 2. General Information

### 2.1. Description of Device (EUT)

EUT Name : Magnet Wireless Charging Car Mount

Model No. : Maghold C02

DIFF. : N/A

Trademark : ESORUN

Power supply : Input : 5V=2A, 9V=2A, 12V=2A  
Wireless output : 5W, 7.5W, 10W, 15W

Operation frequency : 115~205KHz

Modulation : MSK

Antenna Type : Coil Antenna, Maximum Gain is 0dBi(This value is supplied by applicant).

Connector cable loss : 0.5dB (This value is supplied by applicant).

Software version : V1.0

Hardware version : V1.0

## 2.2. Accessories of Device (EUT)

Accessories	:	/
Manufacturer	:	/
Model	:	/
Ratings	:	/

## 2.3. Tested Supporting System Details

No.	Description	Manufacturer	Model	Serial Number	Certification or SDOC
1	Adapter	Huoniu	HNFCQC3024UU	--	--
2	Load	--	--	--	--

## 2.4. Block Diagram of connection between EUT and simulators

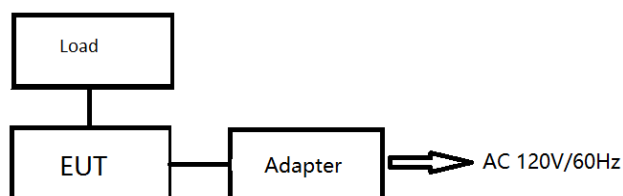

## 2.5. Description of Test Modes

Channel	Frequency (KHz)
1	120

## 2.6. Test Conditions

Items	Required	Actual
Temperature range:	15-35°C	24°C
Humidity range:	25-75%	56%
Pressure range:	86-106kPa	98kPa

## 2.7. Test Facility

Shenzhen Alpha Product Testing Co., Ltd

Building i, No.2, Lixin Road, Fuyong Street, Bao'an District, 518103, Shenzhen, Guangdong, China

June 21, 2018 File on Federal Communication Commission

Registration Number: 293961

July 15, 2019 Certificated by IC

Registration Number: CN0085

## 2.8. Measurement Uncertainty

(95% confidence levels, k=2)

Item	Uncertainty
Uncertainty for Power point Conducted Emissions Test	1.63dB
Uncertainty for Radiation Emission test in 3m chamber (below 30MHz)	3.5dB
Uncertainty for Radiation Emission test in 3m chamber (30MHz to 1GHz)	3.74dB(Polarize: V)
	3.76dB(Polarize: H)
Uncertainty for Radiation Emission test in 3m chamber (1GHz to 25GHz)	3.77dB(Polarize: V)
	3.80dB(Polarize: H)
Uncertainty for radio frequency	$5.06 \times 10^{-8}$ GHz
Uncertainty for conducted RF Power	0.40dB
Uncertainty for temperature	0.2°C
Uncertainty for humidity	1%
Uncertainty for DC and low frequency voltages	0.06%



## 2.9. Test Equipment List

Equipment	Manufacture	Model No.	Firmware version	Serial No.	Last cal.	Cal Interval
9*6*6 anechoic chamber	CHENYU	9*6*6	N/A	N/A	2020.09.02	3Year
Spectrum analyzer	ROHDE&SCHWARZ	FSV40-N	2.3	102137	2021.08.25	1Year
Spectrum analyzer	Agilent	N9020A	A.14.16	MY499100060	2021.08.25	1Year
Receiver	ROHDE&SCHWARZ	ESR	2.28 SP1	1316.3003K03-10 2082-Wa	2021.08.25	1Year
Receiver	R&S	ESCI	4.42 SP1	101165	2021.08.25	1Year
Bilog Antenna	Schwarzbeck	VULB 9168	N/A	VULB 9168#627	2021.08.30	2Year
Horn Antenna	SCHWARZBECK	BBHA 9120 D	N/A	2106	2021.08.30	2Year
Active Loop Antenna	SCHWARZBECK	FMZB 1519B	N/A	00059	2021.08.30	2Year
RF Cable	Resenberger	Cable 1	N/A	RE1	2021.08.25	1Year
RF Cable	Resenberger	Cable 2	N/A	RE2	2021.08.25	1Year
RF Cable	Resenberger	Cable 3	N/A	CE1	2021.08.25	1Year
Pre-amplifier	HP	HP8347A	N/A	2834A00455	2021.08.25	1Year
Pre-amplifier	Agilent	8449B	N/A	3008A02664	2021.08.25	1Year
L.I.S.N.#1	Schwarzbeck	NSLK8126	N/A	8126-466	2021.08.25	1Year
L.I.S.N.#2	ROHDE&SCHWARZ	ENV216	N/A	101043	2021.08.25	1 Year
Horn Antenna	SCHWARZBECK	BBHA9170	N/A	00946	2021.08.30	2 Year
Preamplifier	SKET	LNPA_1840 -50	N/A	SK2018101801	2021.08.25	1 Year
Power Meter	Agilent	E9300A	N/A	MY41496628	2021.08.25	1 Year
Power Sensor	DARE	RPR3006W	N/A	15100041SNO91	2021.08.25	1 Year
Temp. & Humid. Chamber	Weihuang	WHTH-1000 -40-880	N/A	100631	2022.04.22	1 Year
Switching Mode Power Supply	JUNKE	JK12010S	N/A	20140927-6	2021.08.25	1 Year
Adjustable attenuator	MWRFTest	N/A	N/A	N/A	N/A	N/A
10dB Attenuator	Mini-Circuits	DC-6G	N/A	N/A	N/A	N/A

## Software Information

Test Item	Software Name	Manufacturer	Version
RE	EZ-EMC	farad	Alpha-3A1
CE	EZ-EMC	farad	Alpha-3A1
RF-CE	MTS 8310	MWRFTest	2.0.0.0

### 3. Test Results and Measurement Data

#### 3.1. Conducted Emission

##### 3.1.1. Test Specification

<b>Test Requirement:</b>	FCC Part15 C Section 15.207														
<b>Test Method:</b>	ANSI C63.10:2013														
<b>Frequency Range:</b>	150 kHz to 30 MHz														
<b>Receiver setup:</b>	RBW=9 kHz, VBW=30 kHz, Sweep time=auto														
<b>Limits:</b>	<table border="1"> <thead> <tr> <th rowspan="2">Frequency range (MHz)</th> <th colspan="2">Limit (dBuV)</th> </tr> <tr> <th>Quasi-peak</th> <th>Average</th> </tr> </thead> <tbody> <tr> <td>0.15-0.5</td> <td>66 to 56*</td> <td>56 to 46*</td> </tr> <tr> <td>0.5-5</td> <td>56</td> <td>46</td> </tr> <tr> <td>5-30</td> <td>60</td> <td>50</td> </tr> </tbody> </table>	Frequency range (MHz)	Limit (dBuV)		Quasi-peak	Average	0.15-0.5	66 to 56*	56 to 46*	0.5-5	56	46	5-30	60	50
Frequency range (MHz)	Limit (dBuV)														
	Quasi-peak	Average													
0.15-0.5	66 to 56*	56 to 46*													
0.5-5	56	46													
5-30	60	50													
<b>Test Setup:</b>	<p><i>Remark:</i>  E.U.T: Equipment Under Test  LISN: Line Impedance Stabilization Network  Test table height=0.8m</p>														
<b>Test Mode:</b>	Transmitting Mode														
<b>Test Procedure:</b>	<ol style="list-style-type: none"> <li>1. The E.U.T is connected to an adapter through a line impedance stabilization network (L.I.S.N.). This provides a 50ohm/50uH coupling impedance for the measuring equipment.</li> <li>2. The peripheral devices are also connected to the main power through a LISN that provides a 50ohm/50uH coupling impedance with 50ohm termination. (Please refer to the block diagram of the test setup and photographs).</li> <li>3. Both sides of A.C. line are checked for maximum conducted interference. In order to find the maximum emission, the relative positions of equipment and all of the interface cables must be changed according to ANSI C63.10: 2013 on conducted measurement.</li> </ol>														
<b>Test Result:</b>	PASS														

## 3.1.2. Test data

**Please refer to following diagram for individual**

Test Mode	: Full Load(15W)
Test Results	: <b>PASS</b>
Note:	<p>The test results are listed in next pages.</p> <p>All test modes has been tested, this report only reflected the worst mode.</p> <p>If the limits for the measurement with the average detector are met when using a receiver with a peak detector, the test unit shall be deemed to meet both limits and the measurement with the average detector and quasi-peak detector need not be carried out.</p> <p>If the limits for the measurement with the average detector are met when using a receiver with a quasi-peak detector, the test unit shall be deemed to meet both limits and the measurement with the average detector need not be carried out.</p>

<b>EUT Description</b>	Magnet Wireless Charging Car Mount	<b>Model No.</b>	Maghold C02
<b>Temperature</b>	24°C	<b>Humidity</b>	56%
<b>Pol</b>	Line	<b>Test mode</b>	Full Load(15W)
<b>Test Voltage</b>	AC 120V/60Hz		

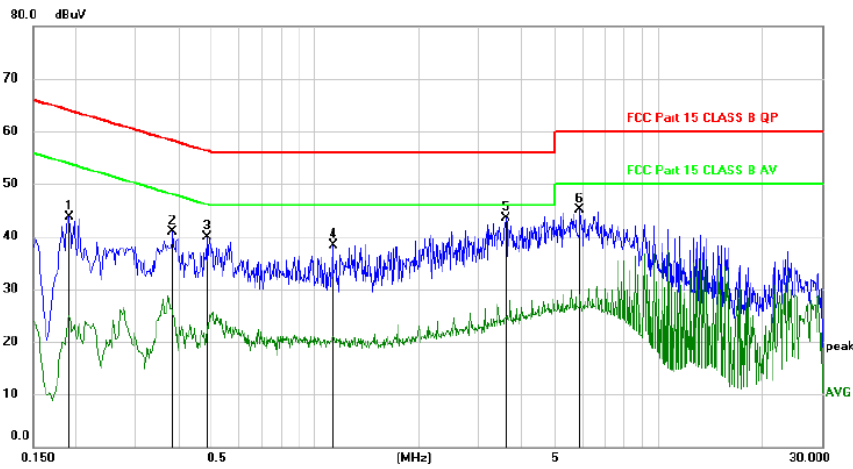

No.	Mk.	Freq. MHz	Reading Level dBuV	Correct Factor dB	Measure- ment dBuV	Limit dBuV	Margin dB	Detector	Comment
1		0.1920	33.77	9.92	43.69	63.95	-20.26	peak	
2		0.3840	30.94	9.94	40.88	58.19	-17.31	peak	
3		0.4830	29.88	9.96	39.84	56.29	-16.45	peak	
4		1.1250	28.37	9.90	38.27	56.00	-17.73	peak	
5	*	3.5850	33.45	9.96	43.41	56.00	-12.59	peak	
6		5.9190	34.94	10.08	45.02	60.00	-14.98	peak	

<b>Pol</b>	Neutral
------------	---------

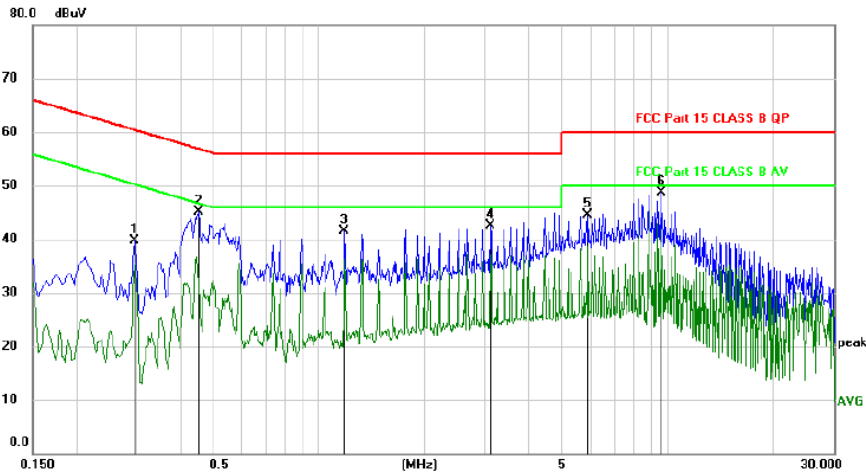

No.	Mk.	Freq. MHz	Reading Level dBuV	Correct Factor dB	Measure- ment dBuV	Limit dBuV	Margin dB	Detector	Comment
1		0.2940	29.83	9.93	39.76	60.41	-20.65	peak	
2		0.4500	35.25	9.95	45.20	56.88	-11.68	peak	
3		1.1820	31.53	9.89	41.42	56.00	-14.58	peak	
4		3.1020	32.45	9.96	42.41	56.00	-13.59	peak	
5		5.9130	34.39	10.08	44.47	60.00	-15.53	peak	
6	*	9.5670	38.54	10.20	48.74	60.00	-11.26	peak	

\*:Maximum data x:Over limit !:over margin

Note: Measurement=Reading Level+Correc Factor. Factor=(LISN or ISN or PLC or Current Probe)Factor+Cable

## 3.2. Radiated Spurious Emission Measurement

### 3.2.1. Test Specification

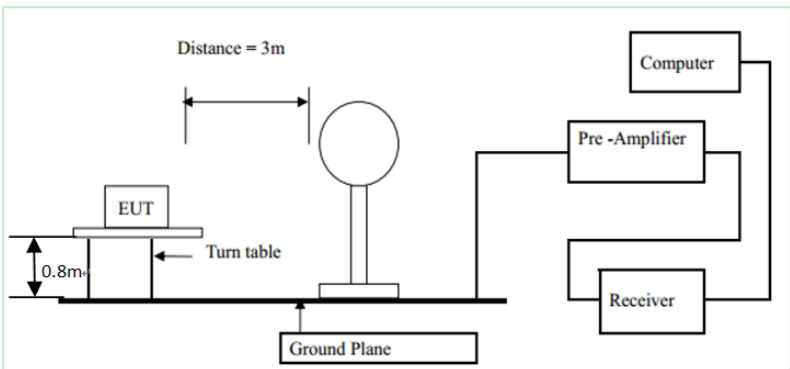
<b>Test Requirement:</b>	FCC Part15 C Section 15.209				
<b>Test Method:</b>	ANSI C63.10: 2013				
<b>Frequency Range:</b>	9 kHz to 25 GHz				
<b>Measurement Distance:</b>	3 m				
<b>Antenna Polarization:</b>	Horizontal & Vertical				
<b>Operation mode:</b>	Refer to item 4.1				
<b>Receiver Setup:</b>	Frequency	Detector	RBW	VBW	Remark
	9kHz-150kHz	Quasi-peak	200Hz	1kHz	Quasi-peak Value
	150kHz-30MHz	Quasi-peak	9kHz	30kHz	Quasi-peak Value
	30MHz-1GHz	Quasi-peak	100kHz	300kHz	Quasi-peak Value
	Above 1GHz	Peak	1MHz	3MHz	Peak Value
		Peak	1MHz	10Hz	Average Value
<b>Limit:</b>	Frequency		Field Strength (microvolts/meter)		Measurement Distance (meters)
	0.009-0.490		2400/F(KHz)		300
	0.490-1.705		24000/F(KHz)		30
	1.705-30		30		30
	30-88		100		3
	88-216		150		3
	216-960		200		3
	Above 960		500		3
	Frequency		Field Strength (microvolts/meter)	Measurement Distance (meters)	Detector
	Above 1GHz		500	3	Average
		5000	3	Peak	
<b>Test setup:</b>	For radiated emissions below 30MHz				
	 <p>Distance = 3m</p> <p>0.8m</p> <p>EUT</p> <p>Turn table</p> <p>Ground Plane</p> <p>Computer</p> <p>Pre-Amplifier</p> <p>Receiver</p>				
	30MHz to 1GHz				

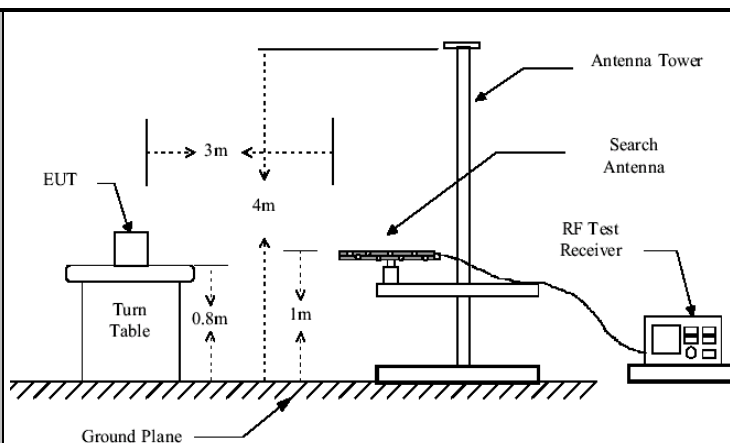

Above 1GHz

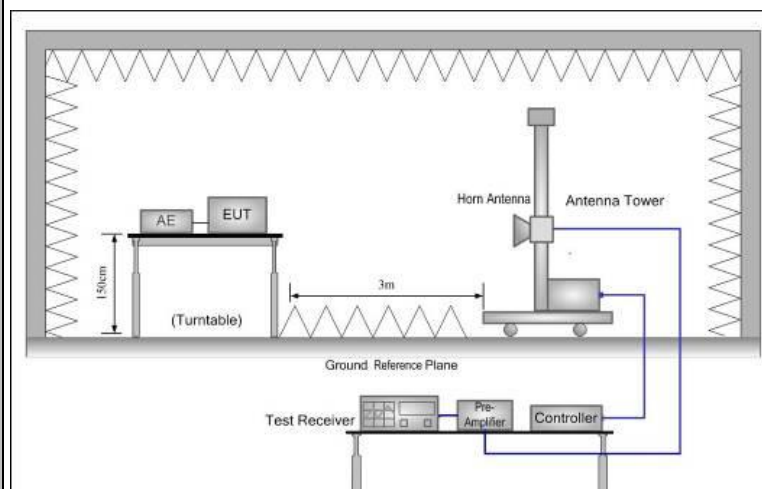
**Test Procedure:****1. For the radiated emission test below 1GHz:**

The EUT was placed on a turntable with 0.8 meter above ground. The EUT was set 3 meters from the interference receiving antenna, which was mounted on the top of a variable height antenna tower. The EUT was arranged to its worst case and then tune the antenna tower (from 1 m to 4 m) and turntable (from 0 degree to 360 degrees) to find the maximum reading. A pre-amp and a high PASS filter are used for the test in order to get better signal level.

**For the radiated emission test above 1GHz:**

Place the measurement antenna on a turntable with 1.5 meter above ground, which is away from each area of the EUT determined to be a source of emissions at the specified measurement distance, while keeping the measurement antenna aimed at the source of emissions at each frequency of significant emissions, with polarization oriented for maximum response. The measurement antenna may have to be higher or lower than the EUT, depending on the radiation pattern of the emission and staying aimed at the emission source for receiving the maximum signal. The final measurement antenna elevation shall be that which maximizes the emissions. The measurement antenna elevation for maximum emissions shall be restricted to a range of heights of from 1 m to 4 m above the ground or reference ground plane.

2. Corrected Reading:  $\text{Antenna Factor} + \text{Cable Loss} + \text{Read Level} - \text{Preamp Factor} = \text{Level}$
3. For measurement below 1GHz, If the emission level of the EUT measured by the peak detector is 3 dB lower than the applicable limit, the peak emission level will be reported.

	<p>Otherwise, the emission measurement will be repeated using the quasi-peak detector and reported.</p> <p>4. Use the following spectrum analyzer settings:</p> <ul style="list-style-type: none"><li>(1) Span shall wide enough to fully capture the emission being measured;</li><li>(2) Set RBW=100 kHz for <math>f &lt; 1</math> GHz; <math>VBW \geq RBW</math>; Sweep = auto; Detector function = peak; Trace = max hold;</li><li>(3) Set RBW = 1 MHz, <math>VBW = 3</math> MHz for <math>f \geq 1</math> GHz for peak measurement.</li></ul> <p>For average measurement: <math>VBW = 10</math> Hz, when duty cycle is no less than 98 percent. <math>VBW \geq 1/T</math>, when duty cycle is less than 98 percent where T is the minimum transmission duration over which the transmitter is on and is transmitting at its maximum power control level for the tested mode of operation.</p>
<b>Test mode:</b>	Refer to section 4.1 for details
<b>Test results:</b>	PASS

## 3.2.2. Test Data

**Please refer to following diagram for individual**

Frequency Range	: 9KHz~30MHz
Test Mode	: TX: 120kHz, Full Load (15W)
Test Results	: <b>PASS</b>
Note:	<ol style="list-style-type: none"><li>1. The test results are listed in next pages.</li><li>2. This mode is worst case mode, so this report only reflected the worst mode.</li><li>3. If the limits for the measurement with the average detector are met when using a receiver with a peak detector, the test unit shall be deemed to meet both limits and the measurement with the quasi-peak detector need not be carried out.</li></ol>



Polarity: X axis

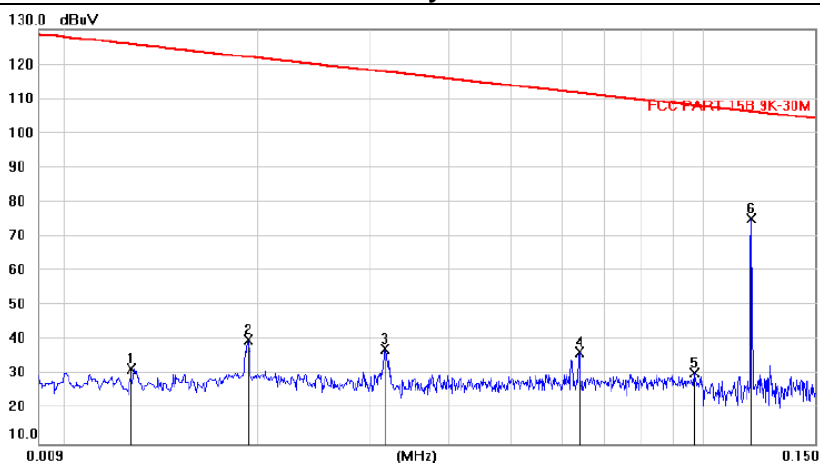

No.	Mk.	Freq. MHz	Reading Level dBuV	Correct Factor dB	Measure- ment dBuV	Limit dBuV	Margin dB	Antenna Height cm	Table Degree	Comment
1		0.0126	10.33	21.43	31.76	125.6	-93.93			peak
2		0.0192	18.93	21.27	40.20	122.0	-81.85			peak
3		0.0316	16.53	20.90	37.43	117.7	-80.30			peak
4		0.0638	16.31	20.11	36.42	111.6	-75.23			peak
5		0.0970	10.82	19.83	30.65	108.0	-77.37			peak
6	*	0.1192	55.45	19.79	75.24	106.2	-31.00			peak

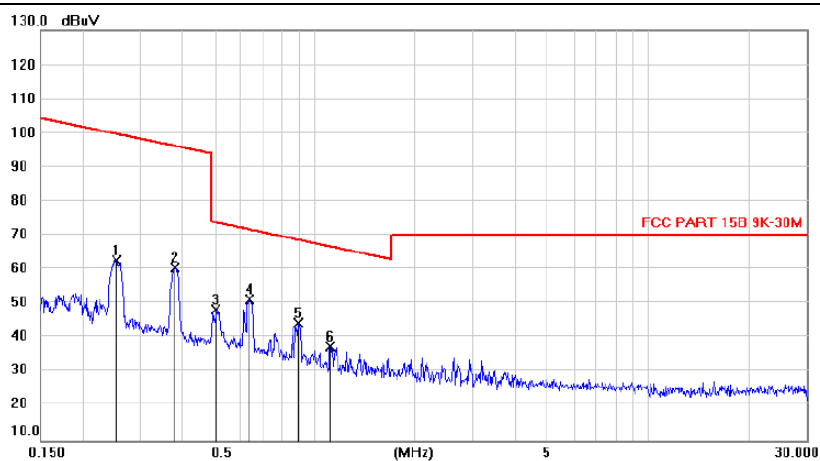

No.	Mk.	Freq. MHz	Reading Level dBuV	Correct Factor dB	Measure- ment dBuV	Limit dBuV	Margin dB	Antenna Height cm	Table Degree	Comment
1		0.2542	42.67	20.05	62.72	99.68	-36.96			peak
2		0.3802	40.78	19.87	60.65	96.20	-35.55			peak
3		0.5053	28.42	19.70	48.12	73.73	-25.61			peak
4	*	0.6377	31.52	19.78	51.30	71.68	-20.38			peak
5		0.8980	24.42	19.94	44.36	68.66	-24.30			peak
6		1.1159	17.51	20.03	37.54	66.74	-29.20			peak

\*:Maximum data x:Over limit !:over margin

Note: Measurement=Reading Level+Correc Factor. Factor=(LISN or ISN or PLC or Current Probe)Factor+Cable

Frequency Range	: 30MHz~1000MHz
Test Mode	: Full Load(15W)\
Test Results	: <b>PASS</b>
Note:	<ol style="list-style-type: none"> <li>1. The test results are listed in next pages.</li> <li>2. All test modes has been tested, this report only reflected the worst mode.</li> <li>3. If the limits for the measurement with the average detector are met when using a receiver with a peak detector, the test unit shall be deemed to meet both limits and the measurement with the quasi-peak detector need not be carried out.</li> </ol>

Frequency Range	: Above 1GHz		
EUT	: /	Test Date	: /
M/N	: /	Temperature	: /
Test Engineer	: /	Humidity	: /
Test Mode	: /		
Test Results	: N/A		
Note:	<ol style="list-style-type: none"> <li>1. The highest frequency of the internal sources of the EUT is less than 108 MHz, the measurement shall only be made up to 1 GHz. So the frequency rang above 1GHz radiation test not applicable.</li> </ol>		

30MHz-1GHz

<b>EUT Description</b>	Magnet Wireless Charging Car Mount	<b>Model No.</b>	Maghold C02
<b>Temperature</b>	24°C	<b>Humidity</b>	56%
<b>Pol</b>	Vertical	<b>Test mode</b>	Full Load(15W)
<b>Test Voltage</b>	AC 120V/60Hz		

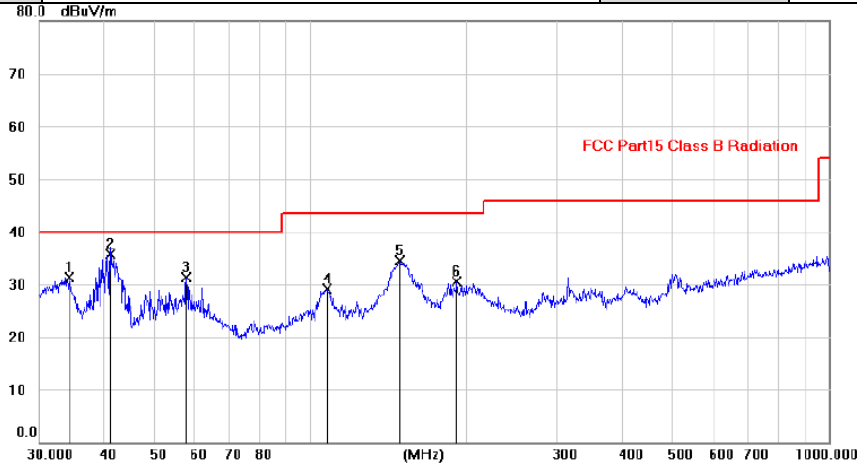

No.	Mk.	Freq.	Reading Level	Correct Factor	Measurement	Limit	Margin	Antenna Height	Table Degree	
		MHz	dBuV	dB	dBuV/m	dBuV/m	dB	cm	degree	Comment
1		34.3442	17.55	13.71	31.26	40.00	-8.74			peak
2	*	41.2621	21.35	14.34	35.69	40.00	-4.31			QP
3		57.6007	17.90	13.41	31.31	40.00	-8.69			peak
4		107.5603	17.45	11.59	29.04	43.50	-14.46			peak
5		149.2588	19.44	15.00	34.44	43.50	-9.06			peak
6		192.3511	19.19	11.34	30.53	43.50	-12.97			peak

<b>Pol</b>	Horizontal
------------	------------

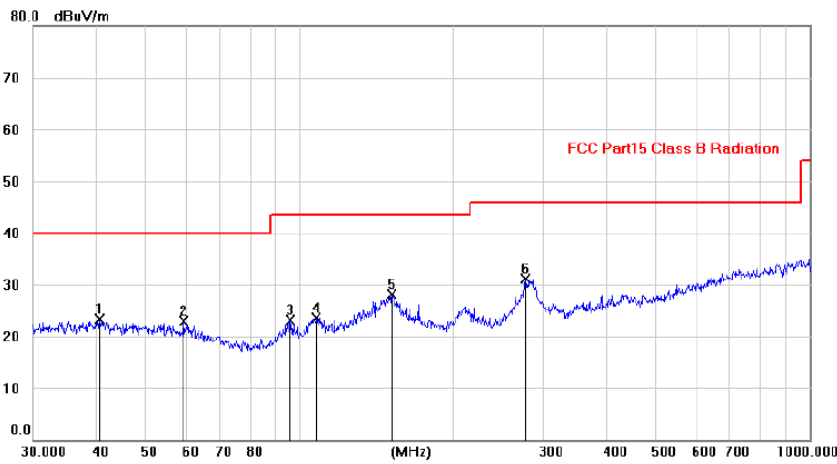

No.	Mk.	Freq.	Reading Level	Correct Factor	Measurement	Limit	Margin	Antenna Height	Table Degree	
		MHz	dBuV	dB	dBuV/m	dBuV/m	dB	cm	degree	Comment
1		40.6446	8.89	14.39	23.28	40.00	-16.72			peak
2		59.3850	9.58	13.25	22.83	40.00	-17.17			peak
3		95.9302	12.66	10.53	23.19	43.50	-20.31			peak
4		108.0518	11.93	11.64	23.57	43.50	-19.93			peak
5		151.5972	13.07	15.06	28.13	43.50	-15.37			peak
6	*	277.8719	17.57	13.51	31.08	46.00	-14.92			peak

\*:Maximum data x:Over limit !:over margin

Note: Measurement=Reading Level+Correc Factor. Factor=(LISN or ISN or PLC or Current Probe)Factor+Cable

## 3.3. Test Specification

<b>Test Requirement:</b>	FCC Part15 C Section 15.215(c)
<b>Test Method:</b>	ANSI C63.10: 2013
<b>Limit:</b>	N/A
<b>Test Procedure:</b>	<ol style="list-style-type: none"> <li>1. According to the follow Test-setup, keep the relative position between the artificial antenna and the EUT.</li> <li>2. Set to the maximum power setting and enable the EUT transmit continuously.</li> <li>3. Use the following spectrum analyzer settings for 20dB Bandwidth measurement. Span = approximately 2 to 3 times the 20 dB bandwidth, centered on a hopping channel; RBW<math>\geq</math>1% of the 20 dB bandwidth; VBW<math>\geq</math>RBW; Sweep = auto; Detector function = peak; Trace = max hold.</li> <li>4. Measure and record the results in the test report.</li> </ol>
<b>Test setup:</b>	 <p>The diagram illustrates the test setup. On the left is a Spectrum Analyzer, represented by a green rectangle with a blue screen and two red dots. A black cable connects the Spectrum Analyzer to a yellow rectangle on the right, which is labeled 'EUT'. A small white square is positioned in the middle of the cable, representing a connector or adapter.</p>
<b>Test Mode:</b>	Refer to section 4.1 for details
<b>Test results:</b>	PASS

3.3.1. Test data

Frequency(kHz)	20dB Occupy Bandwidth (kHz)	Limit (kHz)	Conclusion
120	0.239	---	Pass

Test plots as follows:

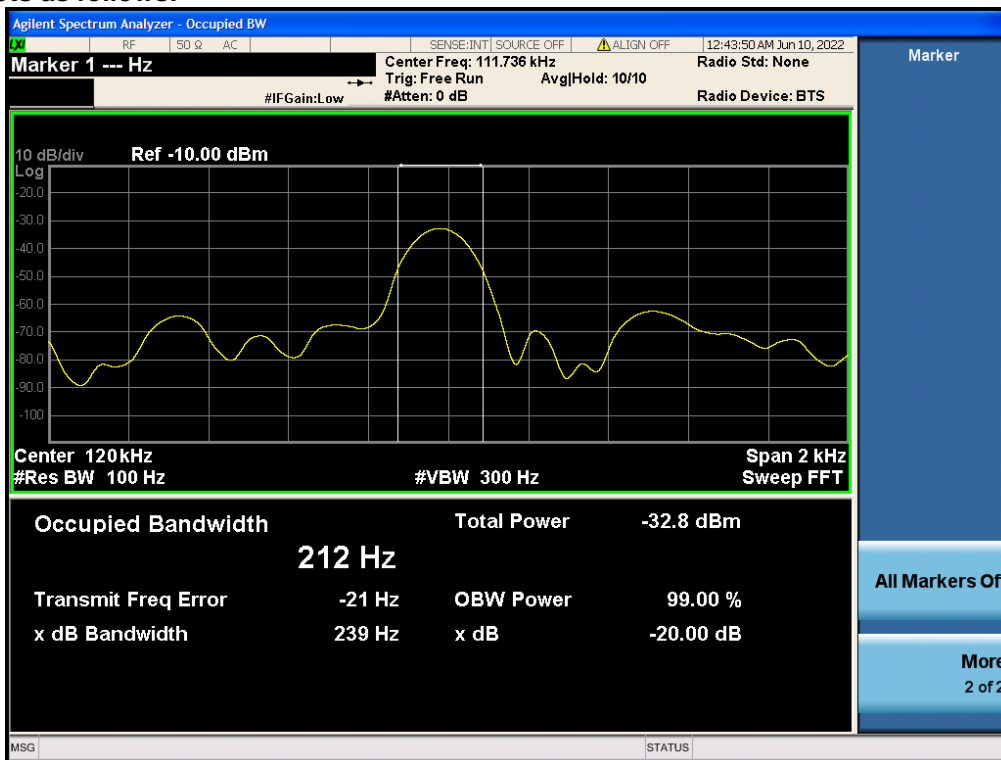

#### 4. Photos of test setup

Radiated Emission

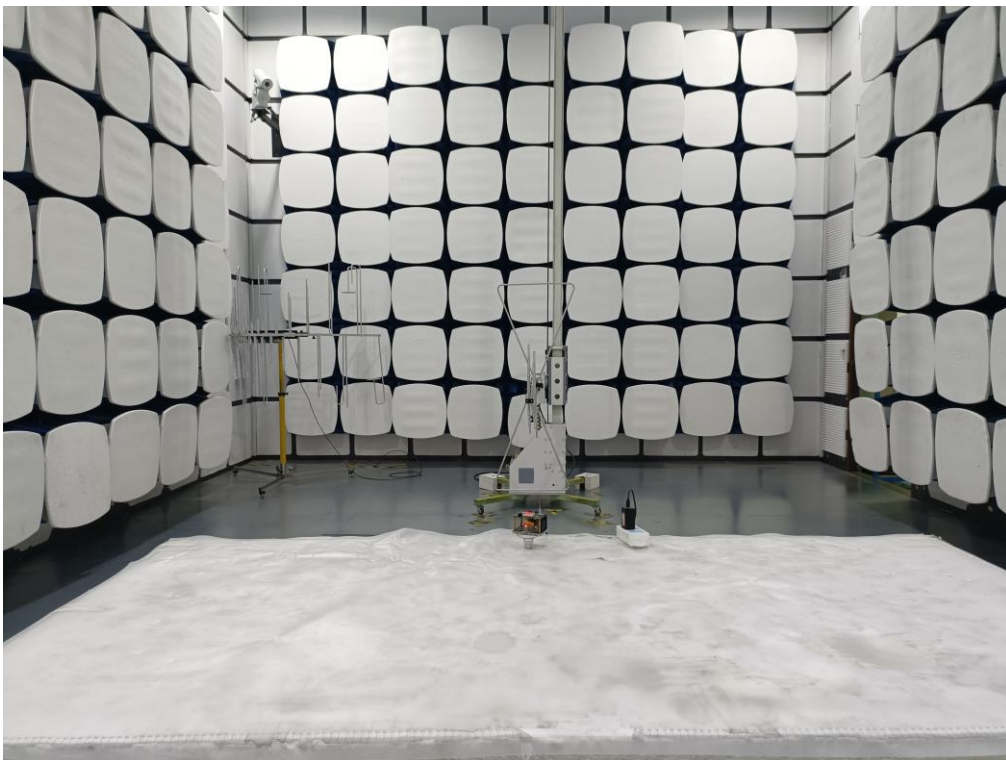
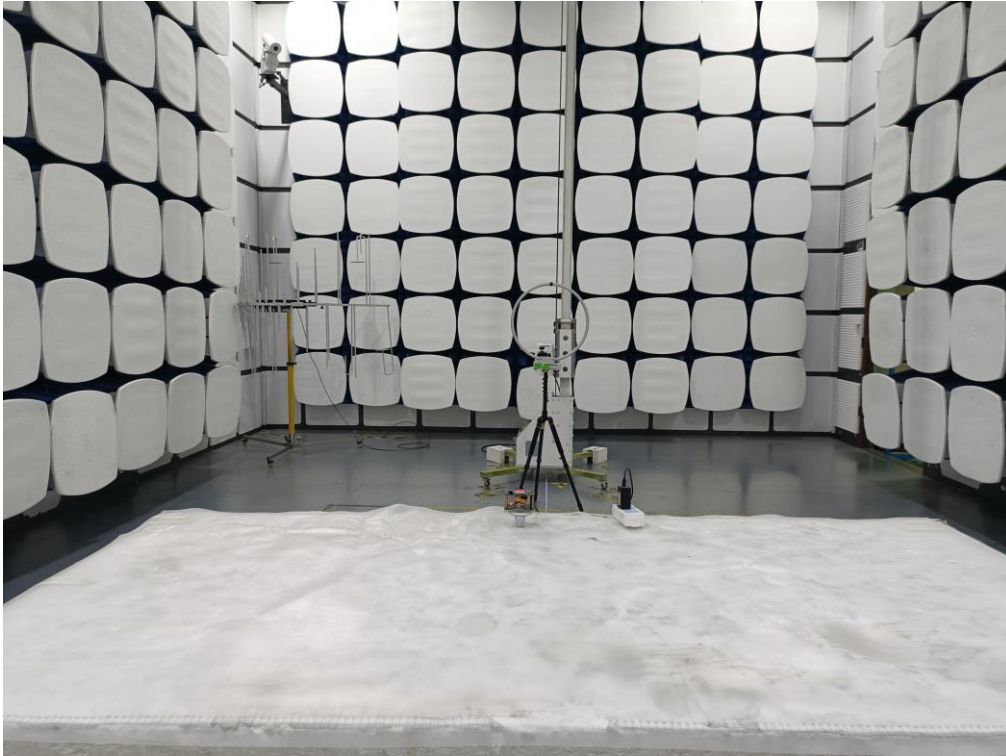

Conducted Emission



### 5. Photographs of EUT







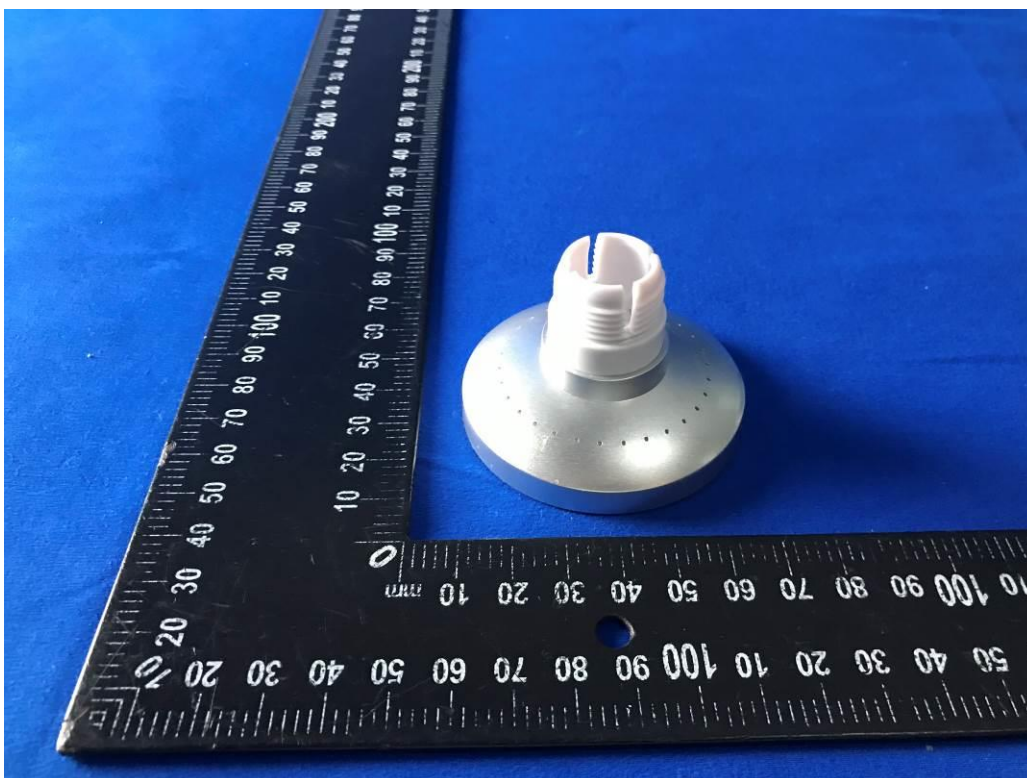
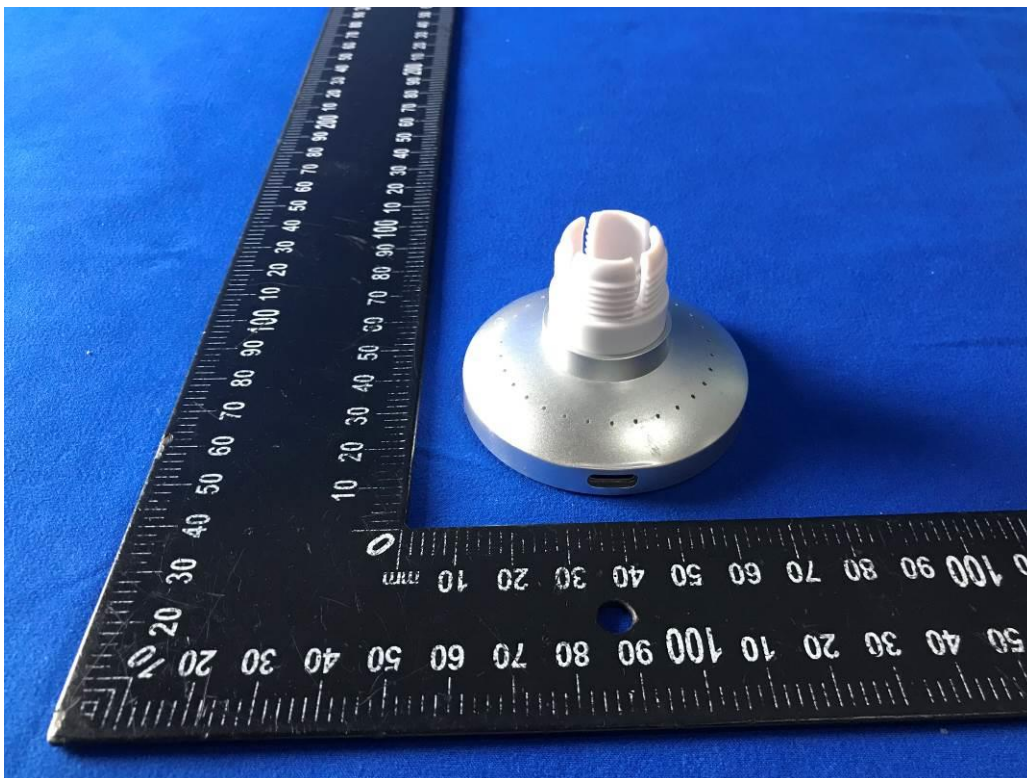

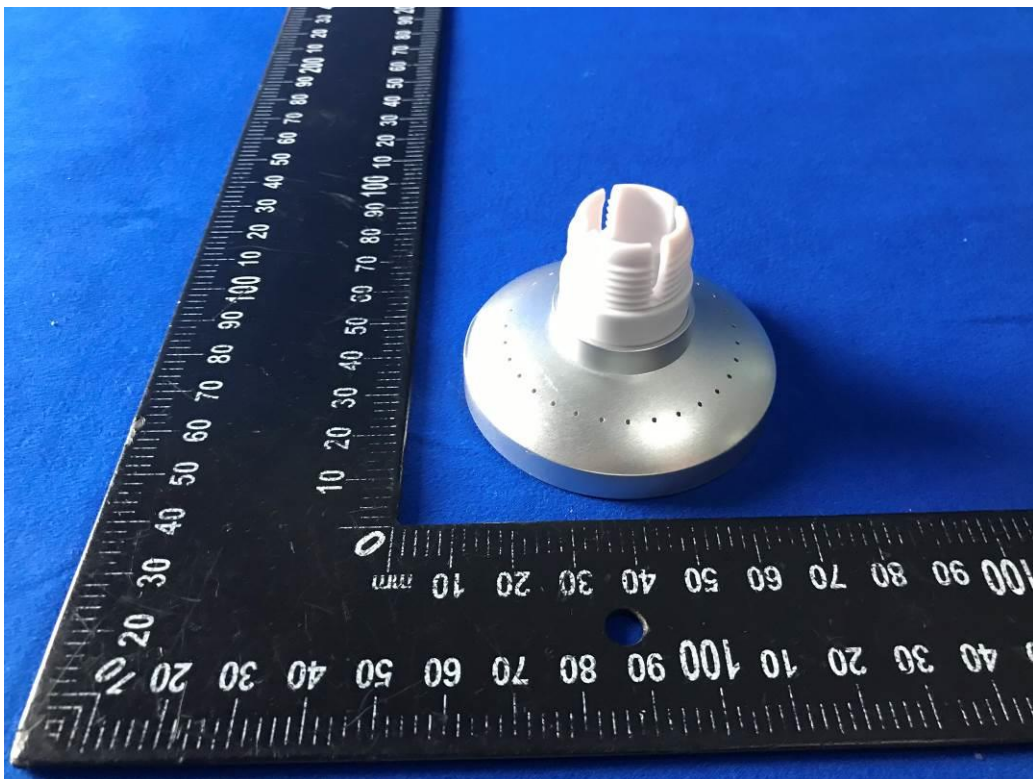
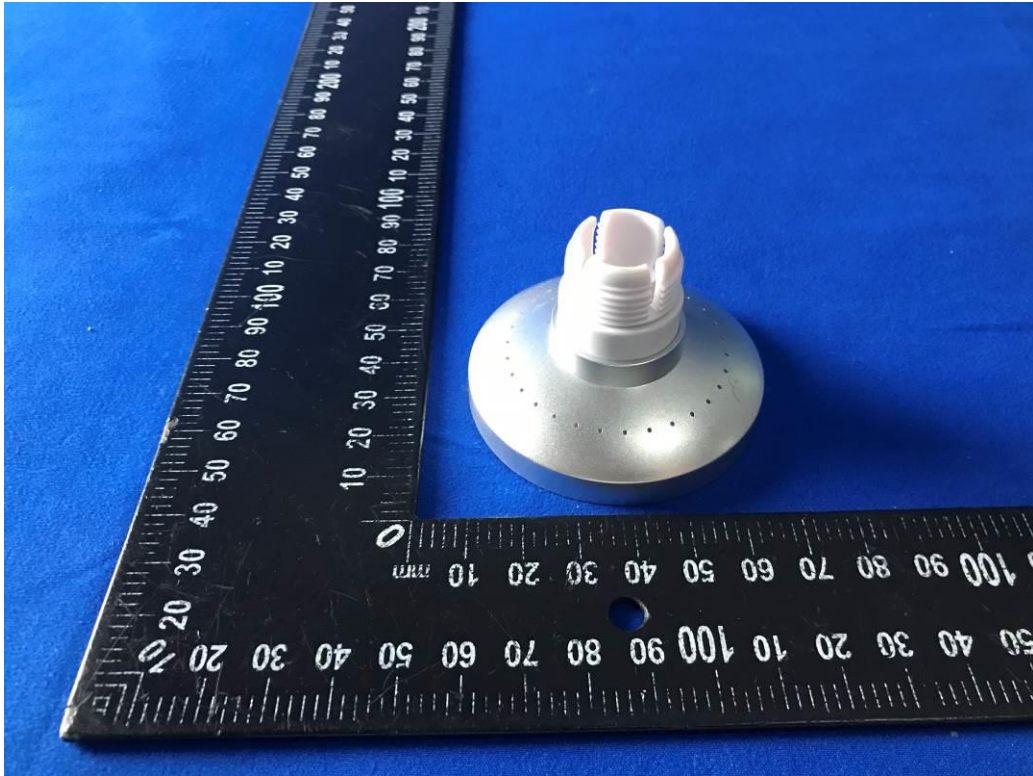

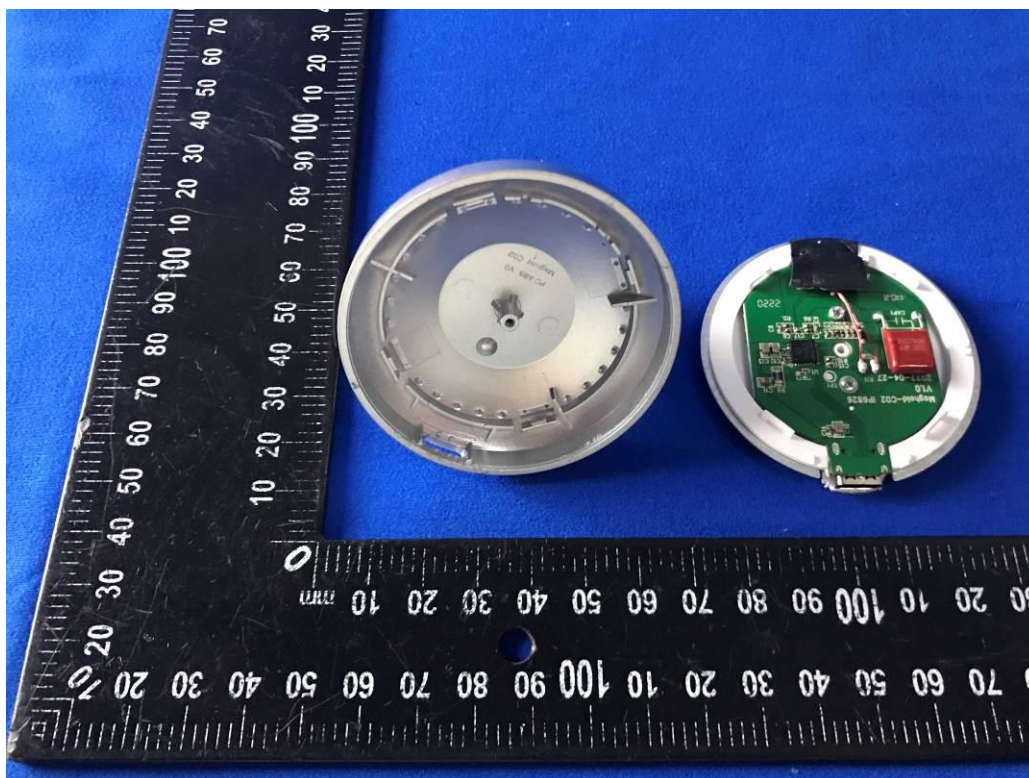
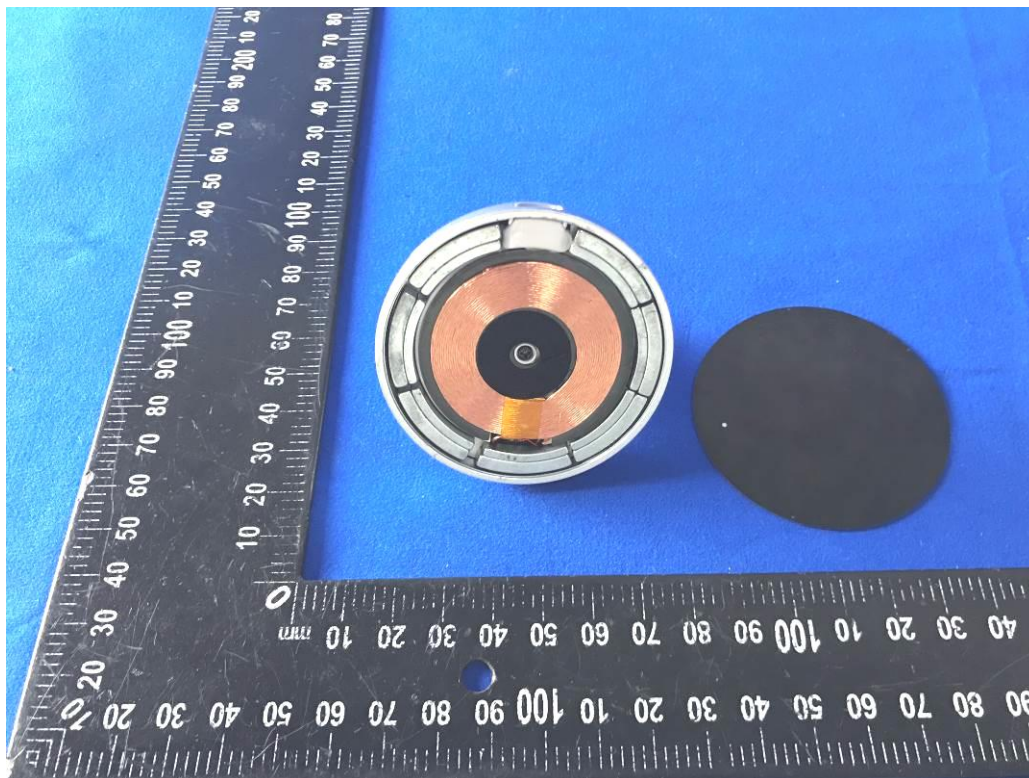

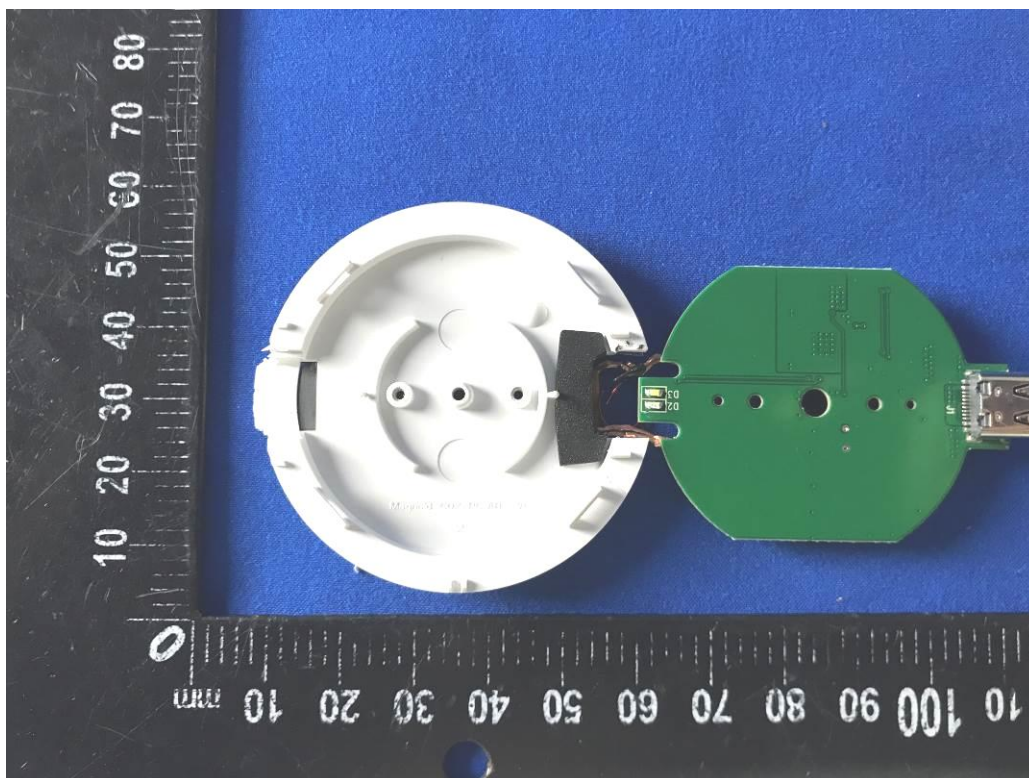
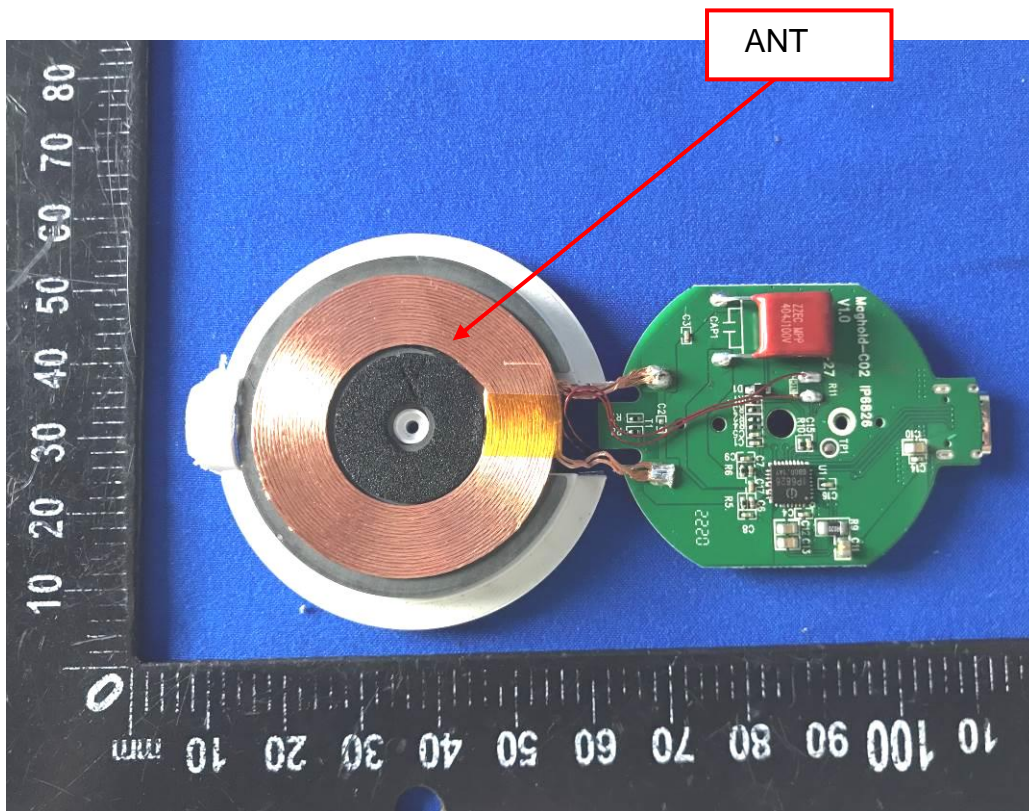

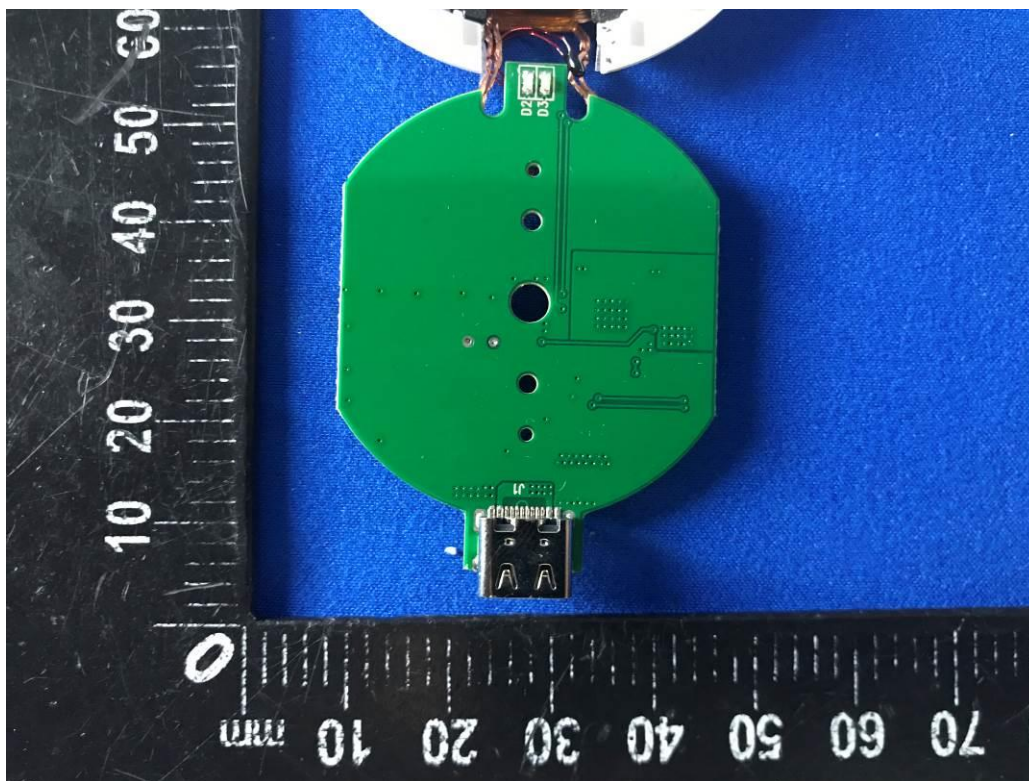
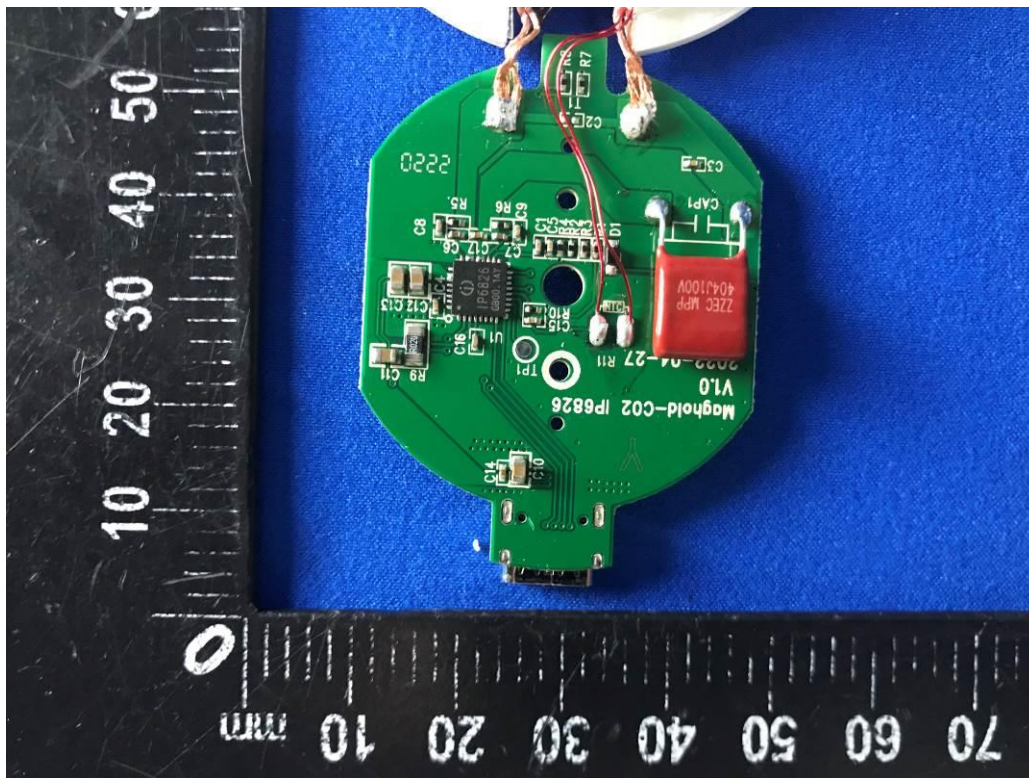

-----END OF REPORT-----