

多功能数码摄像机

Digital Video Camera

使用说明书◎
user manual

使用前请仔细阅读本操作手册
Please read the manual carefully before use

Content

1. About The Camera.....	1
1.1 System Requirement.....	1
1.2 Camera Display.....	1
1.3 Button Function Description.....	2
2. Start to Use.....	2
3. Use The Camera.....	7
4. Appendix.....	21
4.1 Technical Specification.....	21
4.2 Common Problems And Solutions.....	21

1. About The Camera

1.1 System Requirement







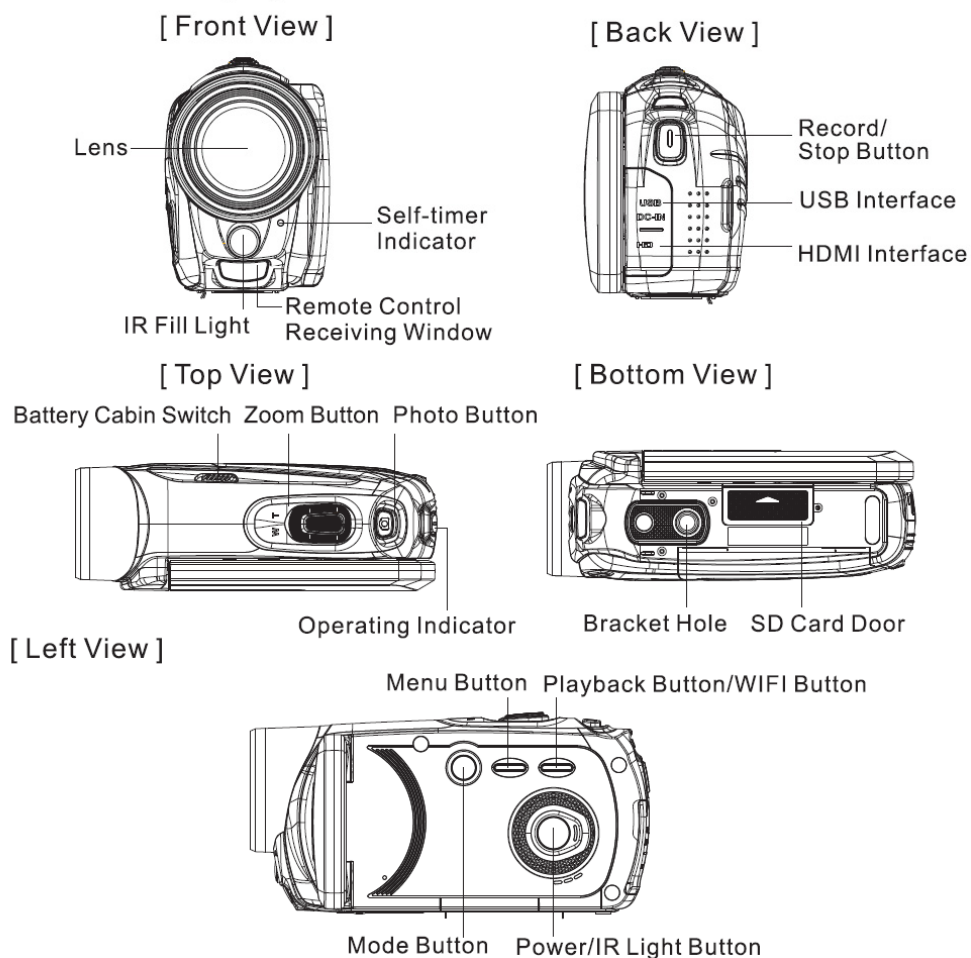



When the camera is contacted with the computer, at least the following requirement should be satisfied :

- Intel® Pentium 2.0 GHZ or higher
- Microsoft Windows XP or higher operating system
- 2GB RAM
- 40GB above available disk memory
- Standard USB interface
- CD - ROM Driver
- 1GB Graphics or higher
- 1024*768 pixel or higher Resolution

1.2 Camera Display



1.3 Button Function Description

Icon	Button Name	Function Description
	Power Button	Long press the button to turn on/off the power, Short press the button to turn on/off the IR Light.
	Mode Button	Switch between Video/Photo/Setup Mode,  Stands for Photo Mode;  Stands for Video Mode; "Setup" Stands for Setup Mode.
	Menu Button	Call out the menu in different modes
	Playback Button	In Photo/Video Mode, press this button to enter the Playback Mode.  Stands for Playback Mode. Long press the button to open the WIFI, short press to close the WIFI.
	Photo/OK Button	In Photo mode, press the button to shot photos; In the Menu, press the button to confirm the function select; In Video Mode, press the Button to pause/recording the video.
	Record/Stop Button	In Video mode, press the button to record or stop video
	Zoom Button	In Photo/Video mode, press the button to zoom in/ zoom out the photos or videos; In other mode, press the button to page leftwards/rightwards.

2. Start To Use

2.1 Insert The Memory Card

This camera can insert the memory card to store more photos, videos or other documents. When the battery power is low or the battery is exchanged, the media documents in the memory card would not be lost.

Please insert the memory card according to the following steps:

1. Flip and open the SD card door.
2. As shown, confirm the memory card is inserted with the sides of metal contact down, and push in it until to hear a click, which means the card is correctly inserted.
3. Push the SD card door inwards and tightly clamp until to hear a click.

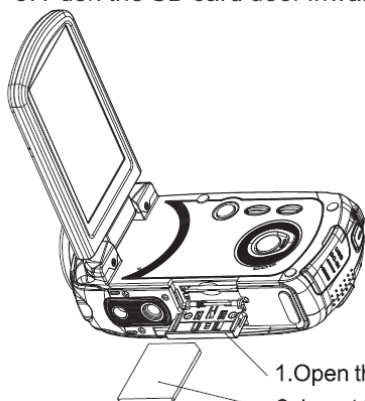

1. Open the SD card door (Pull upwards and then flip outwards).
2. Insert the memory card along this direction as the diagram shown.

Attention!

Please format the memory card before using the camera.

Do not take out or insert the memory card when recording, otherwise, it would damage the card or cause the data loss!

Some memory card may cause the camera crash or irregular work, please insert the standard memory card and check the compatibility of the card.

Attention!

Please install the battery correctly, otherwise it would lead to the camera can't be turned on or damage the machine, also may cause accident!
Do not use non-standard charger!
The power of adapter for the camera is:
AC 100V-240V / 50-60HZ!

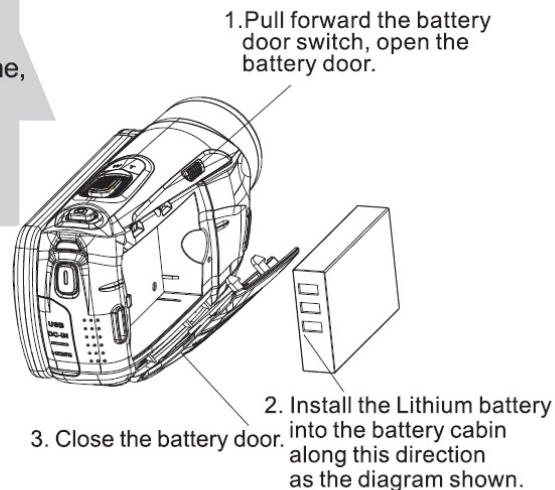

2.2 Install The Battery

Install the matched Lithium battery in the battery cabin according to direction in picture.

1. Install the battery into the battery cabin along this direction as the diagram shown.
2. Push the battery inwards until to hear a click.

2.3 Charge The Battery.

Install the battery in the machine properly, connect the camera with the charger via the standard USB cable. Also can connect the camera with the computer for charging.

2.4 Turn On / Off The Camera

Long press the 【Power Button】 to turn on the camera, in power-on state, long press the 【Power Button】 , the camera will be turned off. This camera support the functions of turning on/off the machine automatically when turning on/off the screen. Even in the shutdown state, when open the display panel, the camera will be turned on automatically; when close the display panel, the camera will be turned off automatically. If the power is exhausted, “ low power ” will be shown on the screen and automatically shut down in seconds.

2.5 Switch The Mode

Press the **【Mode Button】** to switch between Video Mode, Photo Mode and Setup Mode. The corresponding mode will be shown on the top left corner of the screen. Also, users can click the icon on the top left of the screen to switch between modes.

2.6 Introduce The Use Of The Remote-Controller

The remote-controller is the optional accessories.

In addition to use the button operation, this camera also can use the remote control operation via the matching remote-controller.

The operation functions of the button on the remote-controller is as follows:

1. **【Photo Button】** : Shoot photos in Photo Mode.
2. **【Record / Stop Button】** : Record/Stop videos in Video Mode.
3. **【IR Light Button】** : Turn on/off the IR light .
4. **【Page Up Button】** : Page rightwards the document in different Mode.
5. **【Page Down Button】** : Page leftwards the document in different Mode.
6. **【Confirm Button】** : Confirm function.
7. **【Mode Button】** : Switch between Video/Photo/Setup Mode.
8. **【Delete Button】** : Delete the files in Playback Mode.
9. **【Zoom In Button】** : Zoom in function in Photo/Video Mode. Page downwards function in the menu.
10. **【Zoom Out Button】** : Zoom Out function in Photo/Video Mode. Page upwards function in the menu.
11. **【Playback Button】** : Enter Playback Mode.

Note: When using the remote-controller, please aim it at the remote control receiving window of the camera!

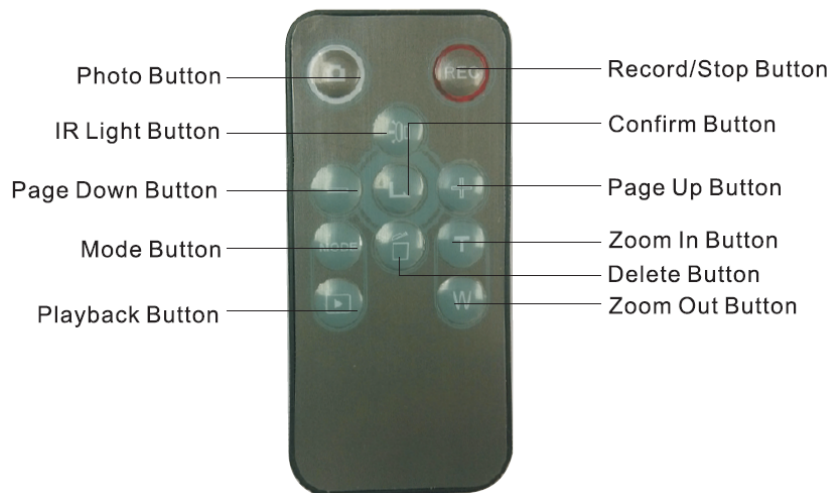

2.7 Connect To The Computer

As shown, the camera can be connected to the computer to transmit the document, watch and edit the videos or photos.

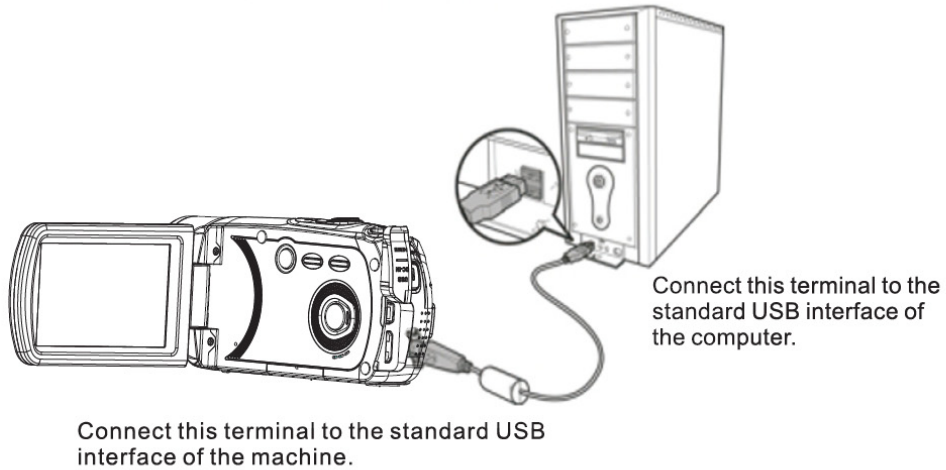

2.8 Connect To The Standard Television

As shown, the camera can be connected to a TV to display videos or photos.

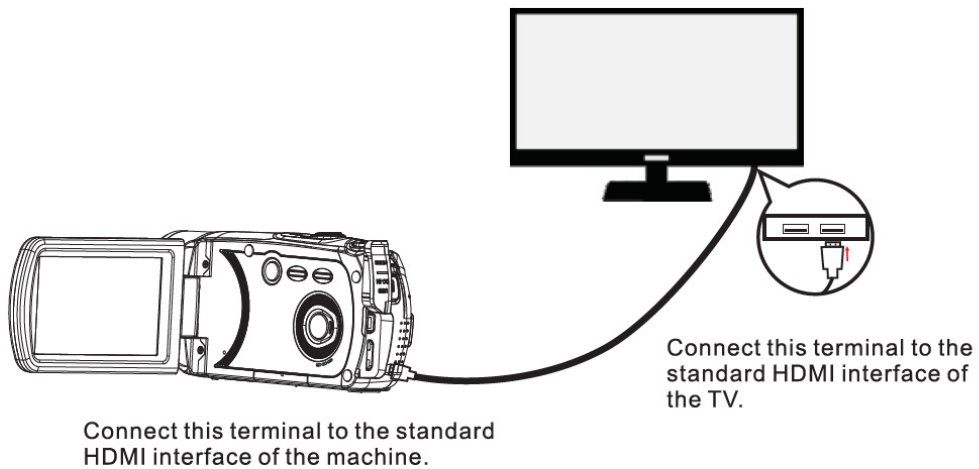

The chapter assists you to be familiar with the camera.

2.9 Video Mode

In Video Mode, video clips can be shot and stored into the memory card. The meaning of icon in Video Mode is shown as the following form and diagram:

1 Video mode indicator	6 Recording time indicator	11 WIFI indicator
2 Video quality indicator	7 Memory card indicator	
3 Exposure indicator	8 Battery indicator	
4 Video size indicator	9 Menu setup indicator	
5 Frame rate indicator	10 IR light indicator	



2.10 Photo Mode

In Photo Mode, pictures can be taken and stored into the internal memory or memory card. Press the **【 Mode Button 】** to switch into Photo Mode. The meaning of icon in Photo Mode is shown as the following form and diagram:

1 Photo mode indicator	5 Photo size indicator	9 Battery indicator
2 White balance indicator	6 Photo quality indicator	10 Menu setup indicator
3 Metering mode indicator	7 Remaining number indicator	11 IR light indicator
4 Exposure indicator	8 Memory card indicator	12 WIFI indicator



2.11 Use The Zoom Function

This camera has digital zoom function, so as to achieve zoom when shooting. Slid rightwards the 【Zoom Button】 to close the distance with the object (Zoom in the object). Slid leftwards the 【Zoom Button】 to distance the object (Zoom out the object).

2.12 Use IR Night Vision Mode

This camera built-in IR night vision mode, it can record videos or take photos make in a dark environment.

In Photo/Video Mode, gently press the 【Power Button】 to turn on the IR Fill Light, and the icon will be shown on the left of the screen. This camera enter in the night vision mode. At this time, the frame is the black and white display. The videos or photos are also black and white. gently press the 【Power Button】 again to return the normal mode.

Attention!

IR night vision mode can be open/close in Photo/Video Mode, in the Video Mode, the IR light can't be turned on/off. If want to use it, please turn on/off the light in advance. In IR night vision mode, just the black and white photos or videos can be shot, the colorful files can't . Zoom function can be worked in Photo/Video Mode, the operating way is the same.

3 Use The Camera

The chapter assists you to understand how to use the all kinds of advanced functions of the camera.

3.1 Photo Shooting

The chapter introduce how to use the camera to shoot photos. Turn on the camera, press the 【Mode Button】 to switch into the Photo Mode. Also, users can click the icon on the top left corner of the screen to enter the mode select frames, then click the “ Camera ” icon to enter the Photo Mode.

1. According to the image displayed on the screen to choose and adjust the shooting target.
2. Hold the camera and press the 【Photo Button】 to shoot photos.
3. The number of the photos can be shot in each resolution ratio will be shown on the top right corner of the screen.
4. “ No Card ” will be shown on the screen if there is no SD card in the camera, “ Storage Card Full ” will be shown on the screen when the SD card is full. This moment ,please insert another SD card to continue shooting.
5. The number of the shooting photos is decided to the volume of the memory card and the chosen resolution ratio, the higher the resolution, the more the occupied memory. Before shooting photos, users can set the relative parameters in the Photo Mode. The detail introduce is as follows:

3.1.1 Photo Size Set

This function can set the photo resolution, the higher the resolution, the greater the quality of the photo, and the larger the size of the photo.

1. In Photo Mode, press the **【Menu Button】** to call out the menu, press the **【W/T Button】** to choose the “ Photo Size ” option.
2. Press the **【Photo Button】** to enter sub-menu.
3. Press the **【W/T Button】** to choose the required photo size option. 2M/3M/5M/7M/8M/10M/12M/16M/20M/22M. Press the **【Photo Button】** to save and back to the photo size menu.
4. This camera supports touch, touch and click the “ Menu ” icon on the bottom left corner of the screen to enter the menu. Click the “ Photo Size ” icon to enter the sub-menu, click the upwards or downwards icon to page to view. Then, click the required mode icon to save.

3.1.2 Photo Quality Set

This function can set the photo quality, the higher the resolution, the clearer the photos.

1. In Photo Mode, press the **【Menu Button】** to call out the menu, press the **【W/T Button】** to choose the “ Photo Quality ” option.
2. Press the **【Photo Button】** to enter sub-menu.
3. Press the **【W/T Button】** to select the required quality option, Normal/Fine/Super Fine. Press the **【Photo Button】** to save and back to the photo quality menu.
4. This camera supports touch, touch and click the “ Menu ” icon on the bottom left corner of the screen to enter the menu. Click the “ Photo Quality ” icon to enter the sub-menu, click the required quality icon to save.

3.1.3 Metering Mode Set

This function can adjust the required light pattern according to the different scene of the shot photos.

1. In Photo Mode, press the **【Menu Button】** to call out the menu, press the **【W/T Button】** to choose the “ Metering Mode ” option.
2. Press the **【Photo Button】** to enter sub-menu.
3. Press the **【W/T Button】** to select the required metering mode option, Spot Metering / Multipoint Metering / Central Metering. Press the **【Photo Button】** to save and back to the metering mode menu.
4. This camera supports touch, touch and click the “ Menu ” icon on the bottom left corner of the screen to enter the menu. Click the “ Metering Mode ” icon to enter the sub-menu, click the required mode icon to save.

3.1.4 White Balance Set

This function can adjust the color deviation of the shot photo according to the different liquid source conditions.

1. In Photo Mode, press the **【Menu Button】** to call out the menu, press the **【W/T Button】** to choose the “White Balance” option.
2. Press the **【Photo Button】** to enter sub-menu.
3. Press the **【W/T Button】** to select the required white balance option, Auto/Daylight/Cloudy/ Tungsten/Fluorescent(H)/Fluorescent(L). Press the **【Photo Button】** to save and back to the white balance menu.
4. This camera supports touch, touch and click the “Menu” icon on the bottom left corner of the screen to enter the menu. Click the “White Balance” icon to enter the sub-menu, click the upwards or downwards icon to page to view. Then, click the required white balance icon to save.

3.1.5 ISO Set

Adjust the photo sensitivity by this function, and automatic mode is recommended.

1. In Photo Mode, press the **【Menu Button】** to call out the menu, press the **【W/T Button】** to choose the ISO option.
2. Press the **【Photo Button】** to enter sub-menu.
3. Press the **【W/T Button】** to select the required ISO value, Auto/50/100/200/400. Press the **【Photo Button】** to save and back to the ISO menu.
4. This camera supports touch, touch and click the “Menu” icon on the bottom left corner of the screen to enter the menu. Click the “ISO” icon to enter the sub-menu, click the upwards or downwards icon to page to view. Then, click the required ISO icon to save.

3.1.6 Exposure Set

This setting permits the users to adjust the photos brightness according to the environment brightness. In low brightness condition, adjusting the function is invalid.

1. In Photo Mode, press the **【Menu Button】** to call out the menu, press the **【W/T Button】** to choose the “Exposure” option.
2. Press the **【Photo Button】** to enter sub-menu.
3. Press the **【W/T Button】** to select the required EV value: EV value(From +2EV to -2EV). Press the **【Photo Button】** to save and back to the exposure menu.
4. This camera supports touch, touch and click the “Menu” icon on the bottom left corner of the screen to enter the menu. Click the “Exposure” icon to enter the sub-menu, click the upwards or downwards icon to page to view. Then, click the required exposure icon to save.

3.1.7 Photo Mode Set

This function can set optimal mode according to users requirement.

1. In Photo Mode, press the **【Menu Button】** to call out the menu, press the **【W/T Button】** to choose the “ Photo Mode ” option.
2. Press the **【Photo Button】** to enter sub-menu.
3. Press the **【W/T Button】** to choose the required mode option, Off/Self-timer 2S/ Self-timer 10S /Two Continuous Shot. Press the **【Photo Button】** to save and back to the photo mode menu.
4. This camera supports touch, touch and click the “ Menu ” icon on the bottom left corner of the screen to enter the menu. Click the “ Photo Mode ” icon to enter the sub-menu, click the upwards or downwards icon to page to view. Then, click the required mode icon to save.

3.1.8 Continuous Capture Set

This function can set the number of the continuous photos, to more perfectly capture the wonderful moment.

1. In Photo Mode, press the **【Menu Button】** to call out the menu, press the **【W/T Button】** to choose the “ Continuous Capture ” option.
2. Press the **【Photo Button】** to enter sub-menu.
3. Press the **【W/T Button】** to choose the required continuous capture mode option, Off/3/5 /10. Press the **【Photo Button】** to save and back to the continuous capture menu.
4. This camera supports touch, touch and click the “ Menu ” icon on the bottom left corner of the screen to enter the menu. Click the “ Continuous Capture ” icon to enter the sub-menu, click the upwards or downwards icon to page to view. Then, click the required continuous capture mode icon to save.

3.1.9 Sharpness Set

This function permits users adjust the sharpness of the photo so that the edge is clearer and softer.

1. In Photo Mode, press the **【Menu Button】** to call out the menu, press the **【W/T Button】** to choose the “ Sharpness ” option.
2. Press the **【Photo Button】** to enter sub-menu.
3. Press the **【W/T Button】** to select the required sharpness option, Super Fine/ Fine/Normal. Press the **【Photo Button】** to save and back to the sharpness menu.
4. This camera supports touch, touch and click the “ Menu ” icon on the bottom left corner of the screen to enter the menu. Click the “ Sharpness ” icon to enter the sub-menu, click the required sharpness icon to save.

3.1.10 Effect Set

This function permits users set the required photo effects.

1. In Photo Mode, press the **【Menu Button】** to call out the menu, press the **【W/T Button】** to choose the “Effect” option.
2. Press the **【Photo Button】** to enter sub-menu.
3. Press the **【W/T Button】** to select the required effect option, Normal/B & W/ Retro/Negative/ Red/Green/Blue. Press the **【Photo Button】** to save and back to the effect menu.
4. This camera supports touch, touch and click the “Menu” icon on the bottom left corner of the screen to enter the menu. Click the “Effect” icon to enter the sub-menu, click the required effect icon to save.

3.1.11 Adjust The Date Stamp

This function can open the date and time of the camera.

1. In Photo Mode, press the **【Menu Button】** to call out the menu, press the **【W/T Button】** to choose the “Date Stamp” option.
2. Press the **【Photo Button】** to enter sub-menu.
3. Press the **【W/T Button】** to select the required mode option, Off/Date/Date And Time. Press the **【Photo Button】** to save and back to the date stamp menu.
4. This camera supports touch, touch and click the “Menu” icon on the bottom left corner of the screen to enter the menu. Click the “Date Stamp” icon to enter the sub-menu, click the required mode icon to save.

3.2 Video Recording

The chapter introduce how to use the camera to record the video clips. Press the **【Mode Button】** to switch into Video Mode, and the  icon will be shown on the top left corner of the screen. Also, users can click the icon on the top left corner of the screen to enter the mode select frames, then click the video icon to enter the Video Mode.

1. According to the image displayed on the screen to choose and adjust the shooting target. Hold the camera and press the **【Record/Stop Button】** to start recording.
2. When recording the videos, there will be a red time flows icon shown on the top of the screen, this moment, press the **【Record/Stop Button】** to pause/continue recording, press the **【Record/Stop Button】** again to stop recording.
3. The recorded files will be saved in the memory card automatically.

Before recording videos, users can set the relative parameters in the Video Mode. The detail introduce of the Video Mode settings options function menu is as the follows:

3.2.1 Video Size Set

This camera have preset a variety of video size, users can choose the optional video size to record videos.

1. In Video Mode, press the **【Menu Button】** to call out the menu, press the **【W/T Button】** to choose the “ Video Size ” option.
2. Press the **【Photo Button】** to enter sub-menu.

Press the **【W/T Button】** to choose the required video size option. 1080P (30fps) / 720P (60fps) / 720P (30fps) / 640*480 (30fps). Press the **【Photo Button】** to save and back to the video size menu.

3. This camera supports touch, touch and click the “ Menu ” icon on the bottom left corner of the screen to enter the menu. Click the “ Video Size ” icon to enter the sub-menu, click the upwards or downwards icon to page to view. Then, click the required mode icon to save.

3.2.2 Video Quality Set

This camera can choose different video quality, the greater the quality, the clearer the videos.

1. In Video Mode, press the **【Menu Button】** to call out the menu, press the **【W/T Button】** to choose the “ Video Quality ” option.
2. Press the **【Photo Button】** to enter sub-menu.
3. Press the **【W/T Button】** to select the required quality option, Super Fine/Fine/Normal. Press the **【Photo Button】** to save and back to the video quality menu.
4. This camera supports touch, touch and click the “ Menu ” icon on the bottom left corner of the screen to enter the menu. Click the “ Video Quality ” icon to enter the sub-menu, click the required quality icon to save.

3.2.3 White Balance Set

This function can adjust the color deviation of the recorded videos according to the different liquid source conditions.

1. In Video Mode, press the **【Menu Button】** to call out the menu, press the **【W/T Button】** to choose the “White Balance” option.
2. Press the **【Photo Button】** to enter sub-menu.
3. Press the **【W/T Button】** to select the required white balance option, Auto/Daylight/Cloudy/Tungsten/Fluorescent(H)/Fluorescent(L). Press the **【Photo Button】** to save and back to the white balance menu.
4. This camera supports touch, touch and click the “Menu” icon on the bottom left corner of the screen to enter the menu. Click the “White Balance” icon to enter the sub-menu, click the upwards or downwards icon to page to view. Then, click the required white balance icon to save.

3.2.4 Exposure Set

This setting permits the users to adjust the videos brightness according to the environment brightness.

1. In Video Mode, press the **【Menu Button】** to call out the menu, press the **【W/T Button】** to choose the “Exposure” option.
2. Press the **【Photo Button】** to enter sub-menu.
3. Press the **【W/T Button】** to select the required EV value: EV value(From +2EV to -2EV). Press the **【Photo Button】** to save and back to the exposure menu.
4. This camera supports touch, touch and click the “Menu” icon on the bottom left corner of the screen to enter the menu. Click the “Exposure” icon to enter the sub-menu, click the upwards or downwards icon to page to view. Then, click the required exposure icon to save.

3.2.5 Metering Mode Set

This function can adjust the required mode according to the different scene of the recorded videos.

1. In Video Mode, press the **【Menu Button】** to call out the menu, press the **【W/T Button】** to choose the “Metering Mode” option.
2. Press the **【Photo Button】** to enter sub-menu.
3. Press the **【W/T Button】** to select the required metering mode option, Central Metering/ Multipoint Metering/Spot Metering. Press the **【Photo Button】** to save and back to the metering mode menu.

4. This camera supports touch, touch and click the “ Menu ” icon on the bottom left corner of the screen to enter the menu. Click the “ Metering Mode ” icon to enter the sub-menu, click the required mode icon to save.

3.2.6 Effect Set

This function permits users set the required video effects.

1. In Video Mode, press the 【 Menu Button 】 to call out the menu, press the 【 W/T Button 】 to choose the “ Effect ” option.
2. Press the 【 Photo Button 】 to enter sub-menu.
3. Press the 【 W/T Button 】 to select the required effect option, Normal/B & W/Retro/Negative/ Red/Green/Blue. Press the 【 Photo Button 】 to save and back to the effect menu.
4. This camera supports touch, touch and click the “ Menu ” icon on the bottom left corner of the screen to enter the menu. Click the “ Effect ” icon to enter the sub-menu, click the required effect icon to save.

3.3 The Operation Of The Setup Menu

In the setup menu, users can set the basic settings, such as Language, Date and time, Auto power-off, Format operation and so on.

Turn on the camera, press the 【 Mode Button 】 to switch into the “ Setup Mode ”. This camera supports touch, users can also click the icon on the top left corner of the screen to enter the mode select frames, then click the setup icon to enter the menu.

3.3.1 Sounds

This function can set the every operation prompt tone of the camera.

1. In Setup Mode, press the 【 W/T Button 】 to choose the “ Sounds ” option, press 【 Photo Button 】 to enter the sub-menu.
2. Press the 【 W/T Button 】 to select the required sounds option; Press the 【 Record Button 】 to switch to the required adjusting option. Press the 【 Photo Button 】 to save and back to the sounds menu.
3. This camera supports touch, touch and click the icon on the top left corner of the screen to enter the mode select frames. Choose the “ Setup Mode ”, click the “ Sounds ” icon to enter the sub-menu. Then, click the required sounds option icon and select the required option leftwards/ rightwards.

3.3.2 Frequency

This function can avoid the image flashing when shooting in the lighting condition. Please refer to the local power standard.

1. In Setup Mode, press the **【W/T Button】** to choose the “ Frequency ” option, press

【Photo Button】 to enter the sub-menu.

2. Press the **【W/T Button】** to select the required frequency option: 50Hz/60Hz. Press

the **【Photo Button】** to save and back to the frequency menu.

3. This camera supports touch, touch and click the icon on the top left corner of the screen to enter the mode select frames. Choose the “ Setup Mode ”, click the “ Frequency ” icon to enter the sub-menu. Then, click the required frequency icon to save.

3.3.3 Auto Power-off

This function permits automatically powering off the camera to save the power supply if users don't use it in a certain time.

1. In Setup Mode, press the **【W/T Button】** to choose the “ Auto-Power-off ” option, press **【Photo Button】** to enter the sub-menu.

2. Press the **【W/T Button】** to select the required auto power-off time option: Off/1 Min./3 Min./ 5 Min.. Press the **【Photo Button】** to save and back to the auto power-off menu.

3. This camera supports touch, touch and click the icon on the top left corner of the screen to enter the mode select frames. Choose the “ Setup Mode ”, click the “ Auto Power-off ” icon to enter the sub-menu. Then, click the required auto power-off time icon to save.

3.3.4 Date And Time

Users can set the date and time for the camera by this function.

1. In Setup Mode, press the **【W/T Button】** to choose the Set Date option, press **【Photo Button】** to enter the sub-menu.

2. Press the **【W/T Button】** to adjust the required option upwards/downwards, press the **【Record Button】** to switch to the required adjusting option. press the **【Photo Button】** to save and back to the date and time set menu.

3. This camera supports touch, touch and click the icon on the top left corner of the screen to enter the mode select frames. Choose the “ Setup Mode ”, click the “ Date And Time ” icon to enter the sub-menu. Then, click the “ upwards/downwards/leftwards/rightwards ” icon to select the required option.

3.3.5 Language

This camera support multiple language, users can choose your language.

1. In Setup Mode, press the **【W/T Button】** to choose the “ Language ” option, press **【Photo Button】** to enter the sub-menu.
2. Press the **【W/T Button】** to select the required language. Press the **【Photo Button】** to save and back to the language menu.
3. This camera supports touch, touch and click the icon on the top left corner of the screen to enter the mode select frames. Choose the “ Setup Mode ”, click the “ Language ” icon to enter the sub-menu. Then, click the required language icon to save.

3.3.6 TV Output

This function can set a compatible TV output mode when the camera is connected with the TV .

1. In Setup Mode, press the **【W/T Button】** to choose the “ TV Output ” option, press **【Photo Button】** to enter the sub-menu.
2. Press the **【W/T Button】** to select the compatible TV output option: NTSC / PAL. Press the **【Photo Button】** to save and back to the Setup Mode.
3. This camera supports touch, touch and click the icon on the top left corner of the screen to enter the mode select frames. Choose the “ Setup Mode ”, click the “page upwards/page downwards” icon, click the “ TV Output ” icon to enter the sub-menu. Then, click the required TV output icon to save.

3.3.7 Format

This camera can format the camera and the memory card, delete all documents.

Because the deleted data can not be recovered, please use the function prudently.

1. In Setup Mode, press the **【W/T Button】** to choose the “ Format ” option, press **【Photo Button】** to enter the sub-menu.
2. Press the **【W/T Button】** to select whether to execute the format operation: Yes / No. Press the **【Photo Button】** to execute the operation, confirm whether to execute the format operation again: Yes / No, press the **【Photo Button】** again to execute and back to the format setup mode.
3. This camera supports touch, touch and click the icon on the top left corner of the screen to enter the mode select frames. Choose the “ Setup Mode ”, click the “page upwards/page downwards” icon, click the “ Format ” icon to enter the sub-menu. Then, confirm whether execute the format operation, click the required format icon to save.

3.3.8 Restore The Default

If users make the camera cannot work because of wrong setup, can restore the camera to the factory setting by this function. This function will not delete the data in the machine and the memory card.

1. In Setup Mode, press the **【W/T Button】** to choose the “ Restore The Default ” option, press **【Photo Button】** to enter the sub-menu.
2. Press the **【W/T Button】** to select whether to restore the default: Yes / No. Press the **【Photo Button】** to execute the operation, confirm whether to execute the restore operation again: Yes / No, press the **【Photo Button】** again to execute and back to the Setup Mode.
3. The camera supports touch, touch and click the icon on the top left corner of the screen to enter the mode select frames. Choose the “ Setup Mode ”, click the “page upwards/page downwards” icon, click the “ Restore The Default ” icon to enter the sub-menu. Then, confirm whether to restore the default, click the confirmed option and then click confirmed option again to save.

3.4 Playback Files

The shot photos can be played back on the camera, and users can delete, protect, slide play the photos. As well as the recorded videos, it can be played back on the camera, and the video files can be locked and deleted.

In Playback Mode, the following operations of the photos is operable:

3.4.1.1 Lock The Files

This function can protect the photo files don't be deleted accidentally. When the photo is locked, users must release lock before deleting.

1. In Playback Mode, press the **【Menu Button】** to call out the menu, press the **【W/T Button】** to choose the “ Lock The Files ” option. Press the **【Photo Button】** to enter sub-menu.
2. Press the **【W/T Button】** to select the required operate option: Lock This/ Unlock This/Lock All/ Unlock All.
3. Press the **【Photo Button】** to confirm execution and back to the Playback Mode.
4. The camera supports touch. In Playback Mode, touch and click the “ Menu ” icon on the bottom left corner of the screen to enter the menu. Click the “ Lock The Files ” icon to enter the sub-menu. Click the required operation icon to save.

3.4.1.2 Delete The Files

This function can delete one photo or delete all photos one time.

1. In Playback Mode, press the **【Menu Button】** to call out the menu, press the **【W/T Button】** to choose the “Delete The Files” option. Press the **【Photo Button】** to enter sub-menu.
2. Press the **【W/T Button】** to select the required delete option: Delete This/ Delete All.
3. Press the **【Photo Button】** to confirm operation, confirm whether to delete the file again: Yes / No, press the **【Photo Button】** again to confirm execution and back to the Playback Mode.
4. The camera supports touch. In Playback Mode, touch and click the “Menu” icon on the bottom left corner of the screen to enter the menu. Click the “Delete The Files” icon to enter the sub-menu. Then, confirm whether to delete the file, click the required operate icon to save.

3.4.1.3 Slide Play

1. In Playback Mode, press the **【Menu Button】** to call out the menu, press the **【W/T Button】** to choose the “Slide Play” option. Press the **【Photo Button】** to enter the sub-menu.
2. Press the **【W/T Button】** to choose the required mode of playback: Start/ Spacing/Repeat (Spacing/Repeat) Mode. Press the **【Record Button】** to switch the sub-mode, press the **【Photo Button】** to save and back to slid play mode.
3. The camera supports touch. In Playback Mode, touch and click the “Menu” icon on the bottom left corner of the screen to enter the menu. Click the “Slide Play” icon to enter the sub-menu. Click the required option to the slid play mode (Spacing/Repeat Mode. Select the play sub-mode leftwards/rightwards). Click the “menu” icon on the bottom of the screen to quit.

3.4.2 Playback The Video And The Related Operation

The videos recorded can be played back, deleted and lock on the camera.

1. In Playback Mode, press the **【W/T Button】** to select the video file required to be played.
2. Press **【Photo Button】** to start playing the video, press the **【Photo Button】** again to pause the video.
3. Press **【W/T Button】** to fast forward/fast rewind the played video.
4. This camera support touch, in Playback Mode, select a video file:
 1. Click the “▶” icon, stands for play the video file.
 2. Click the “||” icon, stands for pause the video file.
 3. Click the “■” icon, stands for stop the video file.

3.4.2.1 Lock The Files

This function can protect the video files don't be deleted accidentally.

1. In Playback Mode, select a video file, press the **【Menu Button】** to call out the menu, press the **【W/T Button】** to choose the "Lock The Files" option. Press the **【Photo Button】** to enter sub-menu.
2. Press the **【W/T Button】** to select the required operate option, Lock This/Unlock This/Lock All/ Unlock All.
3. Press the **【Photo Button】** to confirm execution and back to the Playback Mode.
4. The camera supports touch. In Playback Mode, click the "Leftwards/Rightwards" icon to select a video file, then click the "Menu" icon on the bottom left corner of the screen to enter the menu. Click the "Lock The Files" icon to enter the sub-menu. Click the required operation icon to save.

3.4.2.2 Delete The Files

This function can delete one video or delete all videos one time.

1. In Playback Mode, select a video file, press the **【Menu Button】** to call out the menu, press the **【W/T Button】** to choose the "Delete The Files" option. Press the **【Photo Button】** to enter sub-menu.
2. Press the **【W/T Button】** to select the required delete option: Delete This/ Delete All.
3. Press the **【Photo Button】** to confirm operation, confirm whether to delete the file again: Yes / No, press the **【Photo Button】** again to confirm execution and back to the Playback Mode.
4. The camera supports touch. In Playback Mode, lick the "Leftwards/Rightwards" icon to select a video file, then click the "Menu" icon on the bottom left corner of the screen to enter the menu. Click the "Delete The Files" icon to enter the sub-menu. Then, confirm whether to delete the file again: Delete This/Delete All. Click the required operate icon to save.

Note: The video files can't be deleted when locked, if need to be deleted, please release the lock in advance.

3.5 WIFI Connection

This camera can be remote operated in WIFI Mode, the detail functions and the related applications after connecting WIFI is as follows:

1. Long press the 【Playback Button】 3s to open the WIFI function, this moment, “Waiting WIFI Connection ” will be shown on the screen. Short press 【Playback Button】 to close the WIFI function.
2. Android system mobile phone and tablet search the APP “ iSmart DV ” files in (Gogoisplay) application store to get install program and then install the APP.
3. IOS system mobile phone and tablet search the APP “ iSmart DV ” files in APP store to get install program and then install the APP.
4. Open the setup function of the mobile phone, click the “ WIFI ” to enter the sub-menu, search the WIFI name of the camera equipment “ FHDV_***** ”, click to connect with equipment , import the connection keywords “ 1234567890 ” , then click to confirm connection.
5. Open and enter the installed APP “ iSmart DV ” of the mobile phone to remote operate the camera.

Note: Because the brands or system of the equipment is different, there will be a little difference in operation ways. The roughly operation is the same, so do not affect the users use or operate the camera.

4.1 Technical Specification

Sensor	8.0 MP COM Sensor, Max. 22MP (Software Interpolation)
Sensitivity	Auto, ISO50, ISO100, ISO200, ISO400
Storage Media	Support Class 6 or higher SD /SDHC card, max. 32GB.
Lens	Fixed Lens, F / 3.2, f=7.5mm
Focus Range	Normal: 0.7M~infinity
Image	File Format: JPEG Resolution: 22M, 20M, 16M, 12M, 10M, 8M, 7M, 5M, 3M, 2M
Video	File Format: AVI Resolution: FHD 1080P/30fps, HD 720P/60fps, HD 720P/30fps VGA 640×480/60fps,
Metering Mode	Central Metering, Multipoint Metering, Spot Metering
Anti-shake	Auto
IR Night Vision	Support IR Night Vision, distance is more far than 3m
Remote Control	Support IR Remote Control, distance is more far than 6m
Screen	3.0TFT-LCD Screen with touch
WIFI	Support WIFI Connection, remote view and operate by the mobile phone
White Balance	Auto / Sunlight / Cloudy / Tungsten / Fluorescent(H) / Fluorescent(L)
Exposure Compensation	-2.0 EV~+2.0EV
Self Timer	Off, 2s, 10s, Two continuous Capture
TV Output	NTSC / PAL
PC Interface	USB 2.0
Auto Power Off	Off, 1 min, 3mins, 5mins
Dimension	119(L)×42(W)× 60(H) mm
Weight	Approx. 200±5 g

4.2 Common Problems And Solutions

Problems	Possible Causes	Solutions
Unable to boot	Not properly install the battery No power for the battery	Properly install the battery according to the manual Charge the battery
Suddenly shout down	Opened power saving function No power for the battery	Repeatedly open power supply Exchange the new battery
The photos or videos can not be saved	Interrupt power before saving	When the battery indicator become red, immediately exchange the new battery or charge the battery
Automatically turned off when shooting	No power for the battery	Exchange the new battery or charge the battery
Ambiguously focusing	Out of focus range	Shooting in focus range
Memory card can not be used	Protected memory card Error document format Damage memory card	Release memory card protection Format memory card Exchange the qualified memory card
All buttons has no effect	Short circuit in connection of the machine and the other device	Repeatedly check the connecting circuit, take out the battery and repeatedly open the machine

All photos in this manual are for reference only. Please look the actual product.
We reserved the finally explanation right. In case of all data and parameters are modified,
please look the actual. No further information about the changed.

本手册所载图片仅供参考,请以产品实际为准。
本公司保留最终解释权,所载数据与参数如有修改,以实际为准,恕不另行通知。

FP170727-DR-80

FCC STATEMENT :

This device complies with Part 15 of the FCC Rules. Operation is subject to the following two conditions:

- (1) This device may not cause harmful interference, and
- (2) This device must accept any interference received, including interference that may cause undesired operation.

Warning: Changes or modifications not expressly approved by the party responsible for compliance could void the user's authority to operate the equipment.

NOTE: This equipment has been tested and found to comply with the limits for a Class B digital device, pursuant to Part 15 of the FCC Rules. These limits are designed to provide reasonable protection against harmful interference in a residential installation. This equipment generates uses and can radiate radio frequency energy and, if not installed and used in accordance with the instructions, may cause harmful interference to radio communications. However, there is no guarantee that interference will not occur in a particular installation. If this equipment does cause harmful interference to radio or television reception, which can be determined by turning the equipment off and on, the user is encouraged to try to correct the interference by one or more of the following measures:

- Reorient or relocate the receiving antenna.
- Increase the separation between the equipment and receiver.
- Connect the equipment into an outlet on a circuit different from that to which the receiver is connected.
- Consult the dealer or an experienced radio/TV technician for help.

RF warning statement:

The device has been evaluated to meet general RF exposure requirement. The device can be used in portable exposure condition without restriction.