

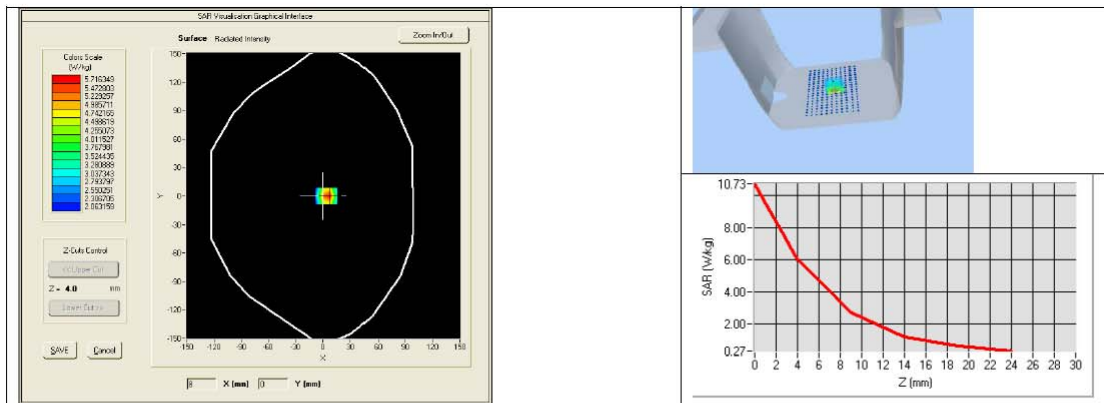

**SAR REFERENCE DIPOLE CALIBRATION REPORT**

Ref: ACR.109.8.18.SATU.A

1900	39.7		20.5	
1950	40.5		20.9	
2000	41.1		21.1	
2100	43.6		21.9	
2300	48.7		23.3	
2450	52.4		24	
2600	55.3	55.60 (5.56)	24.6	24.60 (2.46)
3000	63.8		25.7	
3500	67.1		25	
3700	67.4		24.2	



**7.3 BODY LIQUID MEASUREMENT**

Frequency MHz	Relative permittivity ( $\epsilon_r'$ )		Conductivity ( $\sigma$ ) S/m	
	required	measured	required	measured
150	61.9 ±5 %		0.80 ±5 %	
300	58.2 ±5 %		0.92 ±5 %	
450	56.7 ±5 %		0.94 ±5 %	
750	55.5 ±5 %		0.96 ±5 %	
835	55.2 ±5 %		0.97 ±5 %	
900	55.0 ±5 %		1.05 ±5 %	
915	55.0 ±5 %		1.06 ±5 %	
1450	54.0 ±5 %		1.30 ±5 %	
1610	53.8 ±5 %		1.40 ±5 %	
1800	53.3 ±5 %		1.52 ±5 %	
1900	53.3 ±5 %		1.52 ±5 %	
2000	53.3 ±5 %		1.52 ±5 %	
2100	53.2 ±5 %		1.62 ±5 %	



**SAR REFERENCE DIPOLE CALIBRATION REPORT**

Ref: ACR.109.8.18.SATU.A

2300	52.9 ±5 %		1.81 ±5 %	
2450	52.7 ±5 %		1.95 ±5 %	
2600	52.5 ±5 %	PASS	2.16 ±5 %	PASS
3000	52.0 ±5 %		2.73 ±5 %	
3500	51.3 ±5 %		3.31 ±5 %	
3700	51.0 ±5 %		3.55 ±5 %	
5200	49.0 ±10 %		5.30 ±10 %	
5300	48.9 ±10 %		5.42 ±10 %	
5400	48.7 ±10 %		5.53 ±10 %	
5500	48.6 ±10 %		5.65 ±10 %	
5600	48.5 ±10 %		5.77 ±10 %	
5800	48.2 ±10 %		6.00 ±10 %	

**7.4 SAR MEASUREMENT RESULT WITH BODY LIQUID**

Software	OPENSAR V4
Phantom	SN 20/09 SAM71
Probe	SN 18/11 EPG122
Liquid	Body Liquid Values: eps' : 52.5 sigma : 2.23
Distance between dipole center and liquid	10.0 mm
Area scan resolution	dx=8mm/dy=8mm
Zoon Scan Resolution	dx=5mm/dy=5mm/dz=5mm
Frequency	2600 MHz
Input power	20 dBm
Liquid Temperature	21 °C
Lab Temperature	21 °C
Lab Humidity	45 %

Frequency MHz	1 g SAR (W/kg/W)	10 g SAR (W/kg/W)
	measured	measured
2600	52.49 (5.25)	23.74 (2.37)

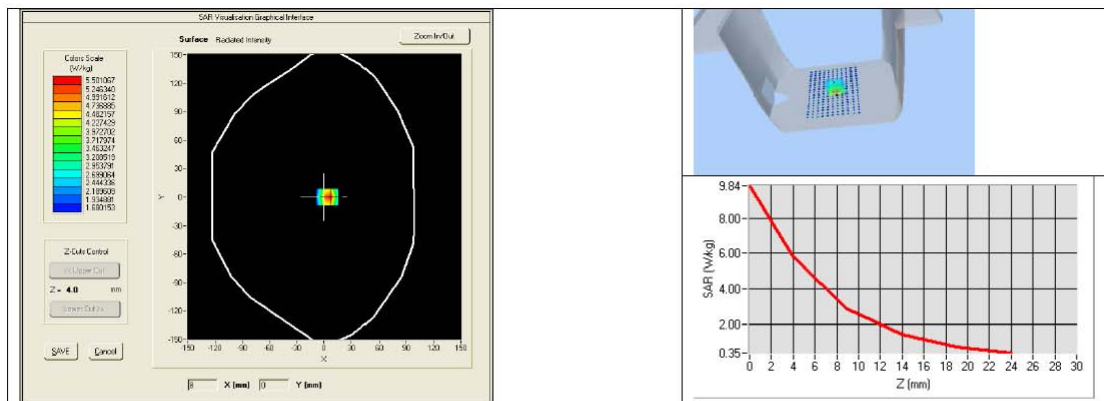



SAR REFERENCE DIPOLE CALIBRATION REPORT

Ref: ACR.109.8.18.SATU.A

8 LIST OF EQUIPMENT

Equipment Summary Sheet				
Equipment Description	Manufacturer / Model	Identification No.	Current Calibration Date	Next Calibration Date
SAM Phantom	MVG	SN-20/09-SAM71	Validated. No cal required.	Validated. No cal required.
COMOSAR Test Bench	Version 3	NA	Validated. No cal required.	Validated. No cal required.
Network Analyzer	Rhode & Schwarz ZVA	SN100132	02/2016	02/2019
Calipers	Carrera	CALIPER-01	01/2017	01/2020
Reference Probe	MVG	EPG122 SN 18/11	10/2017	10/2018
Multimeter	Keithley 2000	1188656	01/2017	01/2020
Signal Generator	Agilent E4438C	MY49070581	01/2017	01/2020
Amplifier	Aethercomm	SN 046	Characterized prior to test. No cal required.	Characterized prior to test. No cal required.
Power Meter	HP E4418A	US38261498	01/2017	01/2020
Power Sensor	HP ECP-E26A	US37181460	01/2017	01/2020
Directional Coupler	Narda 4216-20	01386	Characterized prior to test. No cal required.	Characterized prior to test. No cal required.
Temperature and Humidity Sensor	Control Company	150798832	11/2017	11/2020



## SAR Reference Waveguide Calibration Report

Ref: ACR.109.9.18.SATU.A

**SHENZHEN NTEK TESTING TECHNOLOGY  
CO., LTD.**

**BUILDING E, FENDA SCIENCE PARK, SANWEI  
COMMUNITY, XIXIANG STREET, BAO'AN  
DISTRICT, SHENZHEN GUANGDONG, CHINA MVG  
COMOSAR REFERENCE WAVEGUIDE**

**FREQUENCY: 5000-6000 MHZ**

**SERIAL NO.: SN 13/14 WGA 33**

**Calibrated at MVG US**

**2105 Barrett Park Dr. - Kennesaw, GA 30144**



**Calibration Date: 04/19/2018**

*Summary:*

This document presents the method and results from an accredited SAR reference waveguide calibration performed in MVG USA using the COMOSAR test bench. All calibration results are traceable to national metrology institutions.



SAR REFERENCE WAVEGUIDE CALIBRATION REPORT

Ref: ACR.109.9.18.SATU.A

	<i>Name</i>	<i>Function</i>	<i>Date</i>	<i>Signature</i>
<i>Prepared by :</i>	Jérôme LUC	Product Manager	4/19/2018	<i>JS</i>
<i>Checked by :</i>	Jérôme LUC	Product Manager	4/19/2018	<i>JS</i>
<i>Approved by :</i>	Kim RUTKOWSKI	Quality Manager	4/19/2018	<i>Kim Rutkowski</i>

	<i>Customer Name</i>
<i>Distribution :</i>	SHENZHEN NTEK TESTING TECHNOLOGY CO., LTD.

<i>Issue</i>	<i>Date</i>	<i>Modifications</i>
A	4/19/2018	Initial release



SAR REFERENCE WAVEGUIDE CALIBRATION REPORT

Ref: ACR.109.9.18.SATU.A

TABLE OF CONTENTS

1 Introduction..... 4

2 Device Under Test ..... 4

3 Product Description ..... 4

    3.1 General Information ..... 4

4 Measurement Method ..... 4

    4.1 Return Loss Requirements ..... 4

    4.2 Mechanical Requirements ..... 4

5 Measurement Uncertainty ..... 5

    5.1 Return Loss ..... 5

    5.2 Dimension Measurement ..... 5

    5.3 Validation Measurement ..... 5

6 Calibration Measurement Results ..... 5

    6.1 Return Loss ..... 5

    6.2 Mechanical Dimensions ..... 6

7 Validation measurement ..... 7

    7.1 Head Liquid Measurement ..... 7

    7.2 Measurement Result ..... 7

    7.3 Body Measurement Result ..... 10

8 List of Equipment ..... 13



**SAR REFERENCE WAVEGUIDE CALIBRATION REPORT**

Ref: ACR.109.9.18.SATU.A

**1 INTRODUCTION**

This document contains a summary of the requirements set forth by the IEEE 1528 and CEI/IEC 62209 standards for reference waveguides used for SAR measurement system validations and the measurements that were performed to verify that the product complies with the fore mentioned standards.

**2 DEVICE UNDER TEST**

Device Under Test	
Device Type	COMOSAR 5000-6000 MHz REFERENCE WAVEGUIDE
Manufacturer	MVG
Model	SWG5500
Serial Number	SN 13/14 WGA 33
Product Condition (new / used)	Used

A yearly calibration interval is recommended.

**3 PRODUCT DESCRIPTION**

**3.1 GENERAL INFORMATION**

MVG's COMOSAR Validation Waveguides are built in accordance to the IEEE 1528 and CEI/IEC 62209 standards.

**4 MEASUREMENT METHOD**

The IEEE 1528 and CEI/IEC 62209 standards provide requirements for reference waveguides used for system validation measurements. The following measurements were performed to verify that the product complies with the fore mentioned standards.

**4.1 RETURN LOSS REQUIREMENTS**

The waveguide used for SAR system validation measurements and checks must have a return loss of -8 dB or better. The return loss measurement shall be performed with matching layer placed in the open end of the waveguide, with the waveguide and matching layer in direct contact with the phantom shell as outlined in the fore mentioned standards.

**4.2 MECHANICAL REQUIREMENTS**

The IEEE 1528 and CEI/IEC 62209 standards specify the mechanical dimensions of the validation waveguide, the specified dimensions are as shown in Section 6.2. Figure 1 shows how the dimensions relate to the physical construction of the waveguide.



**SAR REFERENCE WAVEGUIDE CALIBRATION REPORT**

Ref: ACR.109.9.18.SATU.A

**5 MEASUREMENT UNCERTAINTY**

All uncertainties listed below represent an expanded uncertainty expressed at approximately the 95% confidence level using a coverage factor of k=2, traceable to the Internationally Accepted Guides to Measurement Uncertainty.

**5.1 RETURN LOSS**

The following uncertainties apply to the return loss measurement:

Frequency band	Expanded Uncertainty on Return Loss
400-6000MHz	0.1 dB

**5.2 DIMENSION MEASUREMENT**

The following uncertainties apply to the dimension measurements:

Length (mm)	Expanded Uncertainty on Length
3 - 300	0.05 mm

**5.3 VALIDATION MEASUREMENT**

The guidelines outlined in the IEEE 1528 and CEI/IEC 62209 standards were followed to generate the measurement uncertainty for validation measurements.

Scan Volume	Expanded Uncertainty
1 g	20.3 %
10 g	20.1 %

**6 CALIBRATION MEASUREMENT RESULTS**

**6.1 RETURN LOSS IN HEAD LIQUID**

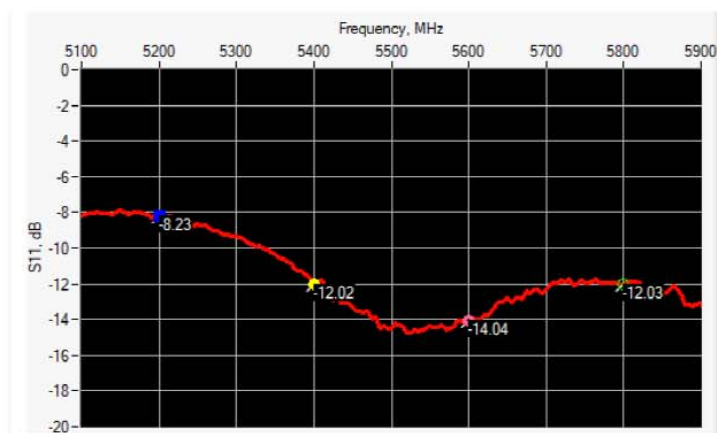





SAR REFERENCE WAVEGUIDE CALIBRATION REPORT

Ref: ACR.109.9.18.SATU.A

Frequency (MHz)	Return Loss (dB)	Requirement (dB)	Impedance
5200	-8.23	-8	26.31 Ω + 19.19 jΩ
5400	-12.02	-8	83.38 Ω - 2.98 jΩ
5600	-14.04	-8	33.47 Ω - 0.96 jΩ
5800	-12.03	-8	59.85 Ω + 26.64 jΩ

6.2 RETURN LOSS IN BODY LIQUID

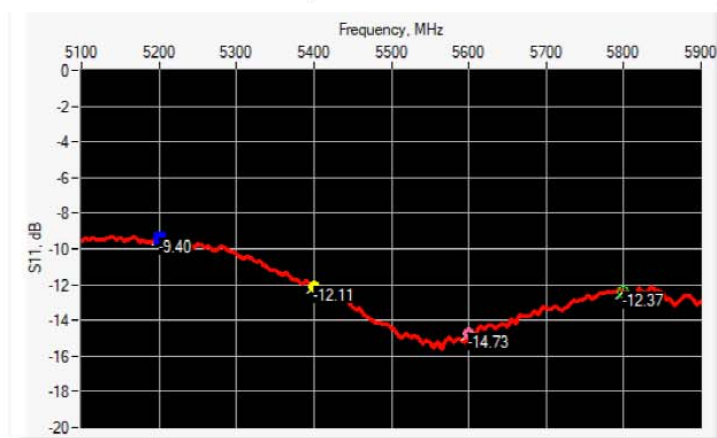

Frequency (MHz)	Return Loss (dB)	Requirement (dB)	Impedance
5200	-9.40	-8	97.78 Ω + 15.77 jΩ
5400	-12.11	-8	32.53 Ω - 11.03 jΩ
5600	-14.73	-8	67.48 Ω + 13.08 jΩ
5800	-12.37	-8	36.66 Ω - 16.68 jΩ

6.3 MECHANICAL DIMENSIONS

Frequency (MHz)	L (mm)		W (mm)		L <sub>f</sub> (mm)		W <sub>f</sub> (mm)		T (mm)	
	Required	Measured	Required	Measured	Required	Measured	Required	Measured	Required	Measured
5200	40.39 ± 0.13	PASS	20.19 ± 0.13	PASS	81.03 ± 0.13	PASS	61.98 ± 0.13	PASS	5.3*	PASS
5800	40.39 ± 0.13	PASS	20.19 ± 0.13	PASS	81.03 ± 0.13	PASS	61.98 ± 0.13	PASS	4.3*	PASS

\* The tolerance for the matching layer is included in the return loss measurement.



SAR REFERENCE WAVEGUIDE CALIBRATION REPORT

Ref: ACR.109.9.18.SATU.A

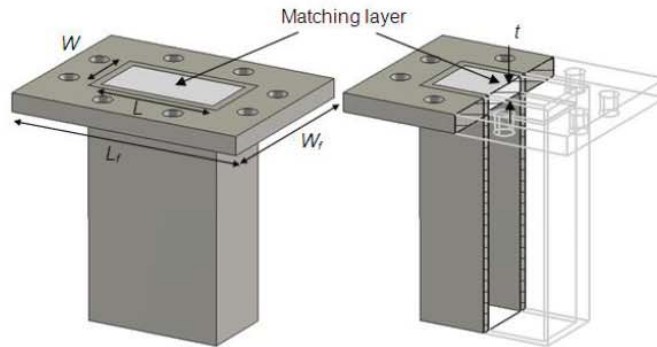

Figure 1: Validation Waveguide Dimensions

7 VALIDATION MEASUREMENT

The IEEE Std. 1528 and CEI/IEC 62209 standards state that the system validation measurements must be performed using a reference waveguide meeting the fore mentioned return loss and mechanical dimension requirements. The validation measurement must be performed with the matching layer placed in the open end of the waveguide, with the waveguide and matching layer in direct contact with the phantom shell.

7.1 HEAD LIQUID MEASUREMENT

Frequency MHz	Relative permittivity ( $\epsilon_r'$ )		Conductivity ( $\sigma$ ) S/m	
	required	measured	required	measured
5000	36.2 ±10 %		4.45 ±10 %	
5100	36.1 ±10 %		4.56 ±10 %	
5200	36.0 ±10 %	PASS	4.66 ±10 %	PASS
5300	35.9 ±10 %		4.76 ±10 %	
5400	35.8 ±10 %	PASS	4.86 ±10 %	PASS
5500	35.6 ±10 %		4.97 ±10 %	
5600	35.5 ±10 %	PASS	5.07 ±10 %	PASS
5700	35.4 ±10 %		5.17 ±10 %	
5800	35.3 ±10 %	PASS	5.27 ±10 %	PASS
5900	35.2 ±10 %		5.38 ±10 %	
6000	35.1 ±10 %		5.48 ±10 %	

7.2 SAR MEASUREMENT RESULT WITH HEAD LIQUID

At those frequencies, the target SAR value can not be generic. Hereunder is the target SAR value defined by MVG, within the uncertainty for the system validation. All SAR values are normalized to 1 W net power. In bracket, the measured SAR is given with the used input power.



**SAR REFERENCE WAVEGUIDE CALIBRATION REPORT**

Ref. ACR.109.9.18.SATU.A

Software	OPENSAR V4
Phantom	SN 20/09 SAM71
Probe	SN 18/11 EPG122
Liquid	Head Liquid Values 5200 MHz: eps' :35.64 sigma : 4.67 Head Liquid Values 5400 MHz: eps' :36.44 sigma : 4.87 Head Liquid Values 5600 MHz: eps' :36.66 sigma : 5.17 Head Liquid Values 5800 MHz: eps' :35.31 sigma : 5.31
Distance between dipole waveguide and liquid	0 mm
Area scan resolution	dx=8mm/dy=8mm
Zoon Scan Resolution	dx=4mm/dy=4m/dz=2mm
Frequency	5200 MHz 5400 MHz 5600 MHz 5800 MHz
Input power	20 dBm
Liquid Temperature	21 °C
Lab Temperature	21 °C
Lab Humidity	45 %

Frequency (MHz)	1 g SAR (W/kg)		10 g SAR (W/kg)	
	required	measured	required	measured
5200	159.00	160.94 (16.09)	56.90	55.97 (5.60)
5400	166.40	170.60 (17.06)	58.43	58.93 (5.89)
5600	173.80	175.02 (17.50)	59.97	59.90 (5.99)
5800	181.20	184.13 (18.41)	61.50	62.74 (6.27)

**SAR MEASUREMENT PLOTS @ 5200 MHz**

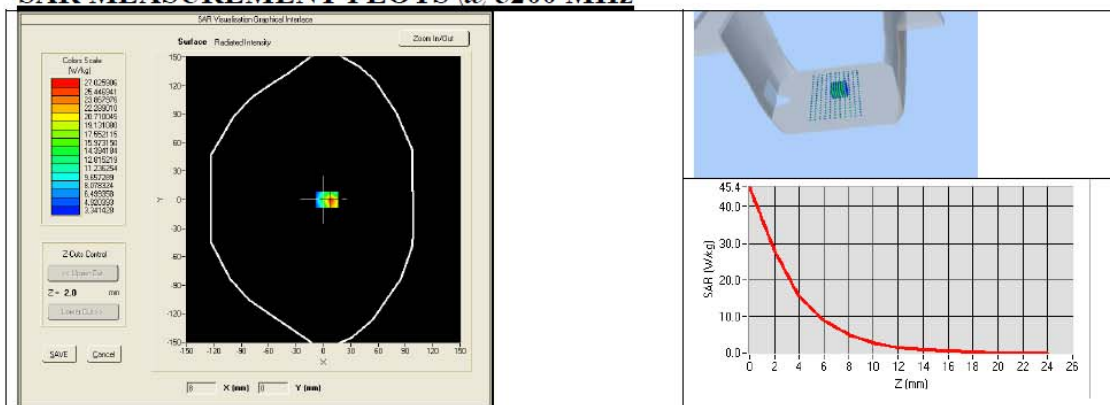



**SAR REFERENCE WAVEGUIDE CALIBRATION REPORT**

Ref. ACR.109.9.18.SATU.A

**SAR MEASUREMENT PLOTS @ 5400 MHz**

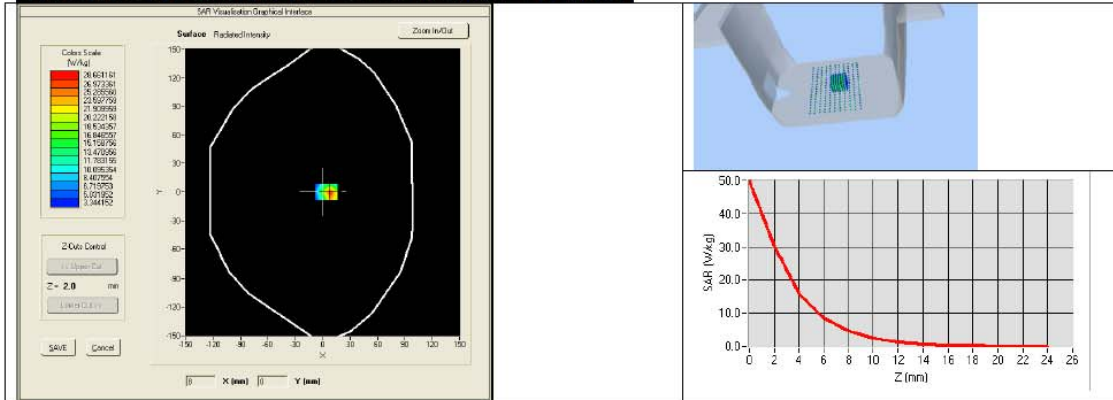

**SAR MEASUREMENT PLOTS @ 5600 MHz**

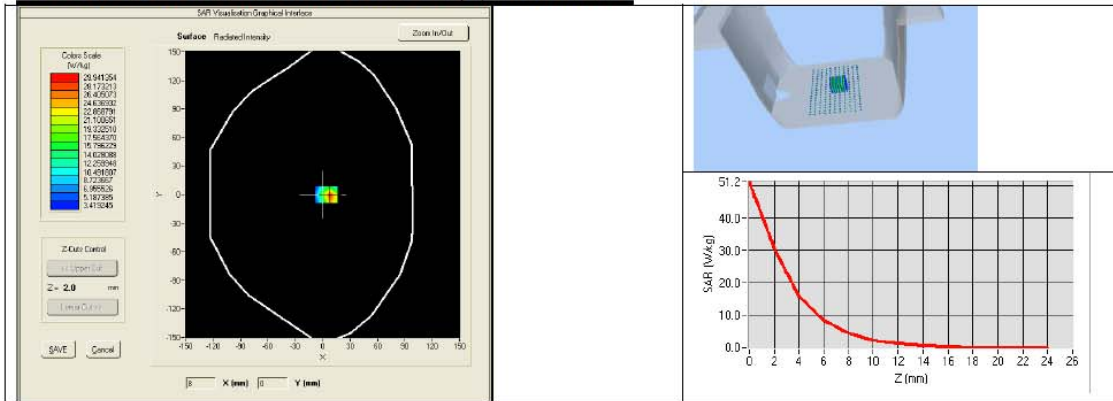

**SAR MEASUREMENT PLOTS @ 5800 MHz**

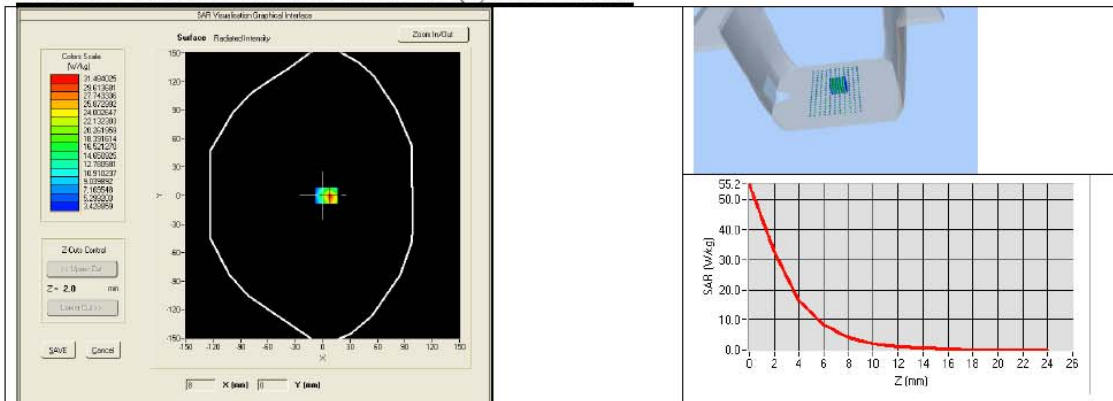



**SAR REFERENCE WAVEGUIDE CALIBRATION REPORT**

Ref: ACR.109.9.18.SATU.A

**7.3 BODY LIQUID MEASUREMENT**

Frequency MHz	Relative permittivity ( $\epsilon_r'$ )		Conductivity ( $\sigma$ ) S/m	
	required	measured	required	measured
5200	49.0 ±10 %	PASS	5.30 ±10 %	PASS
5300	48.9 ±10 %		5.42 ±10 %	
5400	48.7 ±10 %	PASS	5.53 ±10 %	PASS
5500	48.6 ±10 %		5.65 ±10 %	
5600	48.5 ±10 %	PASS	5.77 ±10 %	PASS
5800	48.2 ±10 %	PASS	6.00 ±10 %	PASS

**7.4 SAR MEASUREMENT RESULT WITH BODY LIQUID**

Software	OPENSAR V4
Phantom	SN 20/09 SAM71
Probe	SN 18/11 EPG122
Liquid	Body Liquid Values 5200 MHz: $\epsilon_r'$ :48.64 $\sigma$ : 5.51 Body Liquid Values 5400 MHz: $\epsilon_r'$ :46.52 $\sigma$ : 5.77 Body Liquid Values 5600 MHz: $\epsilon_r'$ :46.79 $\sigma$ : 5.77 Body Liquid Values 5800 MHz: $\epsilon_r'$ :47.04 $\sigma$ : 6.10
Distance between dipole waveguide and liquid	0 mm
Area scan resolution	dx=8mm/dy=8mm
Zoon Scan Resolution	dx=4mm/dy=4m/dz=2mm
Frequency	5200 MHz 5400 MHz 5600 MHz 5800 MHz
Input power	20 dBm
Liquid Temperature	21 °C
Lab Temperature	21 °C
Lab Humidity	45 %

Frequency (MHz)	1 g SAR (W/kg) measured	10 g SAR (W/kg) measured
5200	156.85 (15.68)	55.20 (5.52)
5400	163.97 (16.40)	57.26 (5.73)
5600	166.58 (16.66)	57.87 (5.79)
5800	169.30 (16.93)	58.49 (5.85)



**SAR REFERENCE WAVEGUIDE CALIBRATION REPORT**

Ref. ACR.109.9.18.SATU.A

**BODY SAR MEASUREMENT PLOTS @ 5200 MHz**

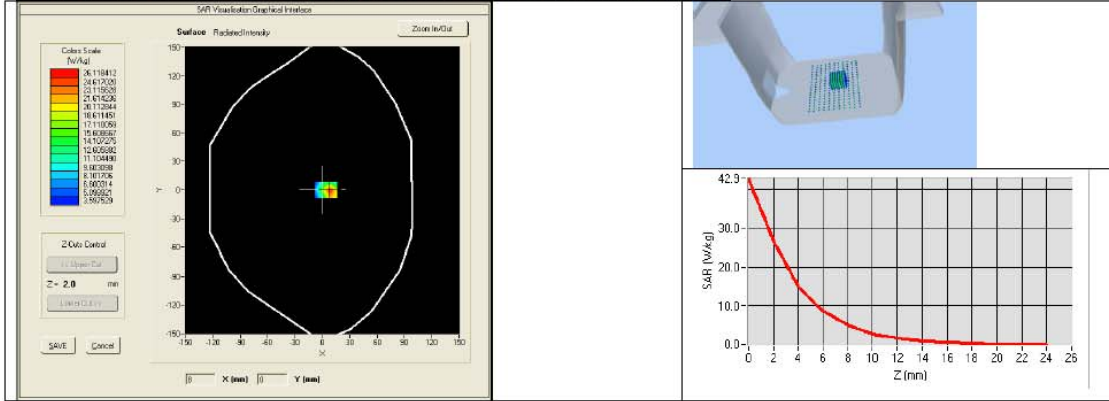

**BODY SAR MEASUREMENT PLOTS @ 5400 MHz**

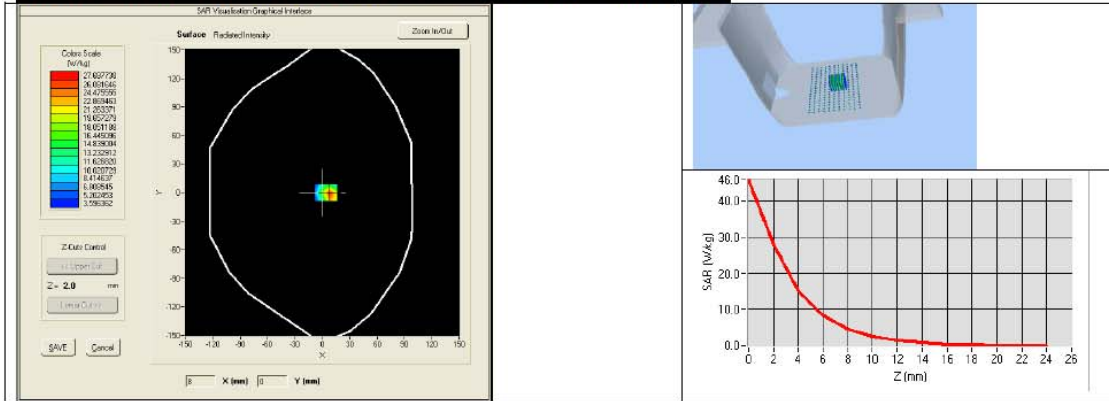

**BODY SAR MEASUREMENT PLOTS @ 5600 MHz**

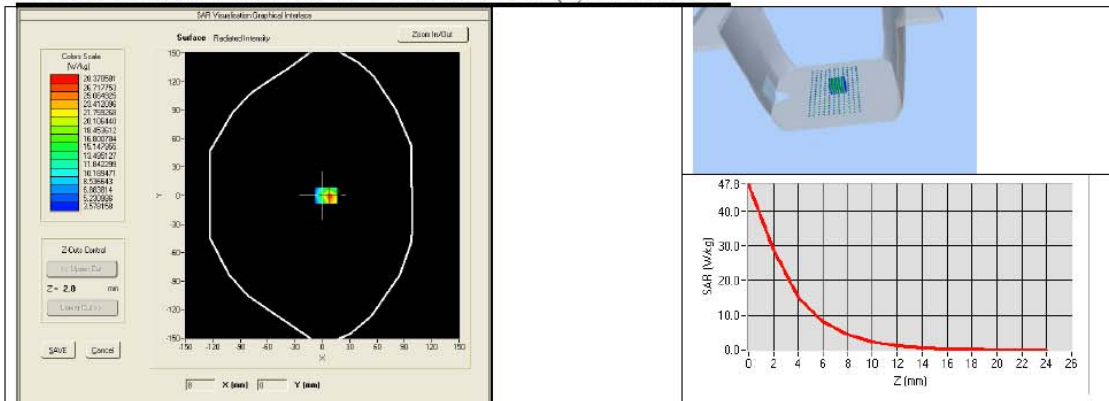



SAR REFERENCE WAVEGUIDE CALIBRATION REPORT

Ref. ACR.109.9.18.SATU.A

**BODY SAR MEASUREMENT PLOTS @ 5800 MHz**

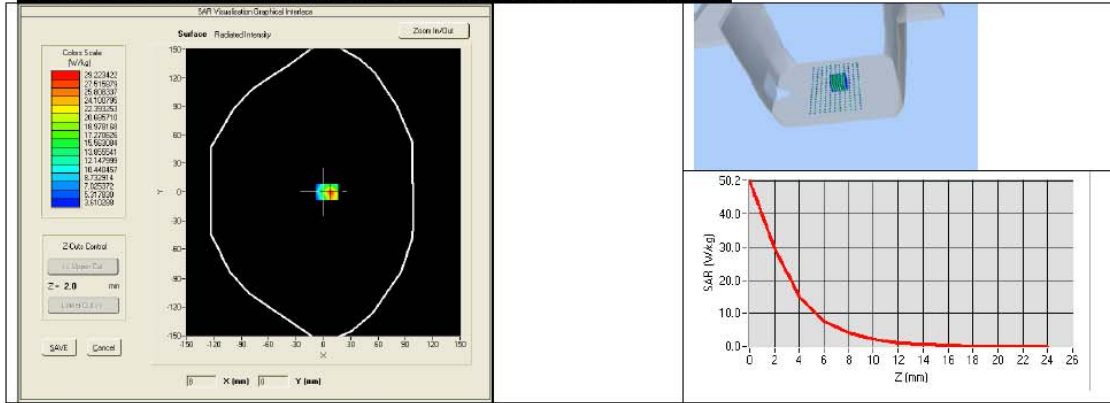



SAR REFERENCE WAVEGUIDE CALIBRATION REPORT

Ref. ACR.109.9.18.SATU.A

**8 LIST OF EQUIPMENT**

Equipment Summary Sheet				
Equipment Description	Manufacturer / Model	Identification No.	Current Calibration Date	Next Calibration Date
Flat Phantom	MVG	SN-20/09-SAM71	Validated. No cal required.	Validated. No cal required.
COMOSAR Test Bench	Version 3	NA	Validated. No cal required.	Validated. No cal required.
Network Analyzer	Rhode & Schwarz ZVA	SN100132	02/2016	02/2019
Calipers	Carrera	CALIPER-01	01/2017	01/2020
Reference Probe	MVG	EPG122 SN 18/11	10/2017	10/2018
Multimeter	Keithley 2000	1188656	01/2017	01/2020
Signal Generator	Agilent E4438C	MY49070581	01/2017	01/2020
Amplifier	Aethercomm	SN 046	Characterized prior to test. No cal required.	Characterized prior to test. No cal required.
Power Meter	HP E4418A	US38261498	01/2017	01/2020
Power Sensor	HP ECP-E26A	US37181460	01/2017	01/2020
Directional Coupler	Narda 4216-20	01386	Characterized prior to test. No cal required.	Characterized prior to test. No cal required.
Temperature and Humidity Sensor	Control Company	150798832	11/2017	11/2020



**<Justification of the extended calibration>**

If dipoles are verified in return loss (<-20dB, within 20% of prior calibration for below 3GHz, and <-8dB, within 20% of prior calibration for 5GHz to 6GHz), and in impedance (within 5 ohm of prior calibration), the annual calibration is not necessary and the calibration interval can be extended.

**<Head 750MHz>**

Return Loss (dB)	Delta (%)	Impedance	Delta(ohm)	Date of Measurement
-35.83	-	51.3	-	Apr. 19, 2018
-35.948	0.329	51.314	0.014	Apr. 18, 2019
-35.975	0.405	51.341	0.041	Apr. 17, 2020

The return loss is <-20dB, within 20% of prior calibration; the impedance is within 5 ohm of prior calibration. Therefore the verification result should support extended calibration.

Dipole Verification Data

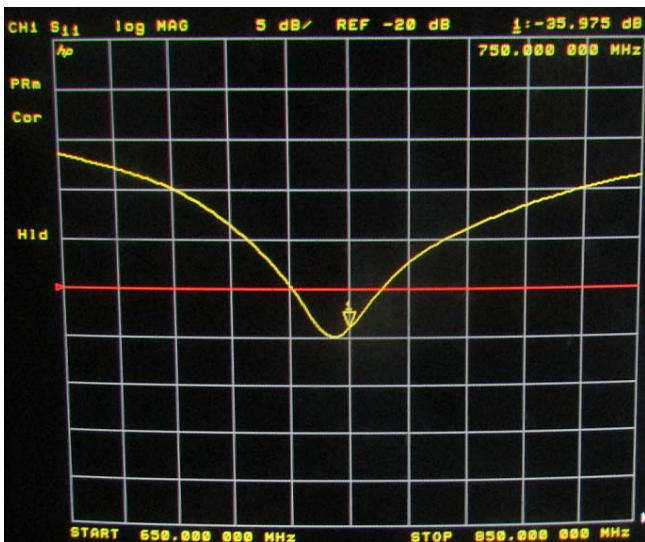
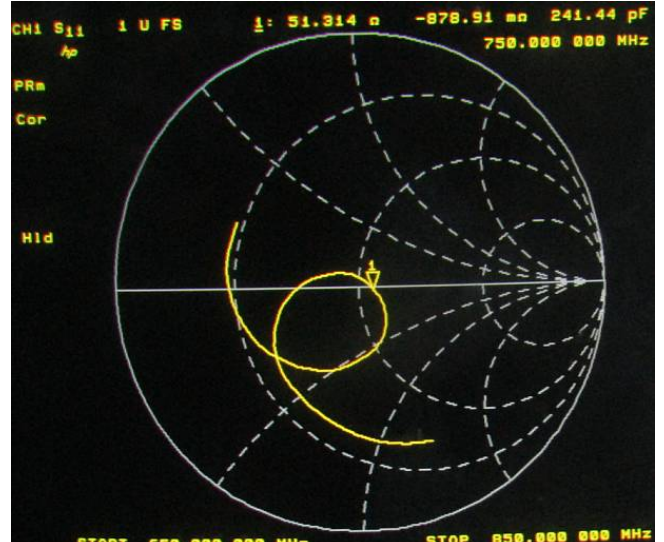
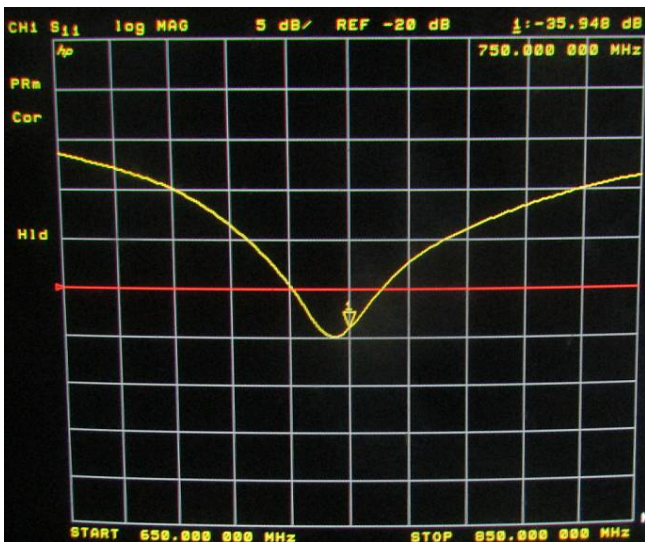

<Body 750MHz>

Return Loss (dB)	Delta (%)	Impedance	Delta(ohm)	Date of Measurement
-32.65	-	50.8	-	Apr. 19, 2018
-32.051	1.835	51.838	1.038	Apr. 18, 2019
-32.075	1.761	51.817	1.017	Apr. 17, 2020

The return loss is <-20dB, within 20% of prior calibration; the impedance is within 5 ohm of prior calibration. Therefore the verification result should support extended calibration.

Dipole Verification Data

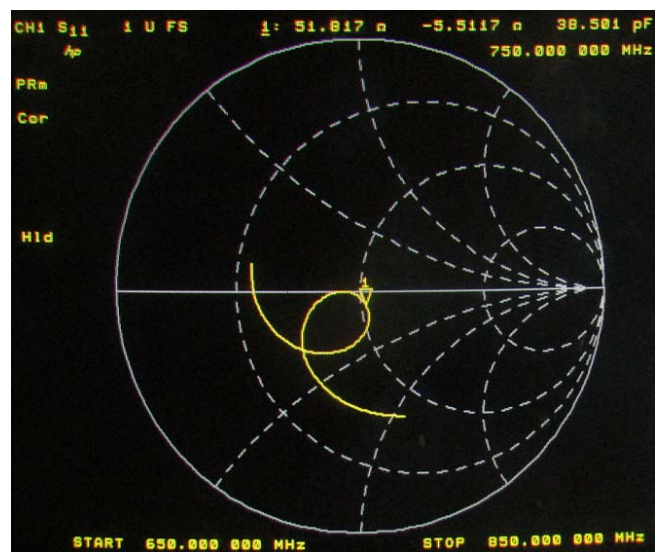
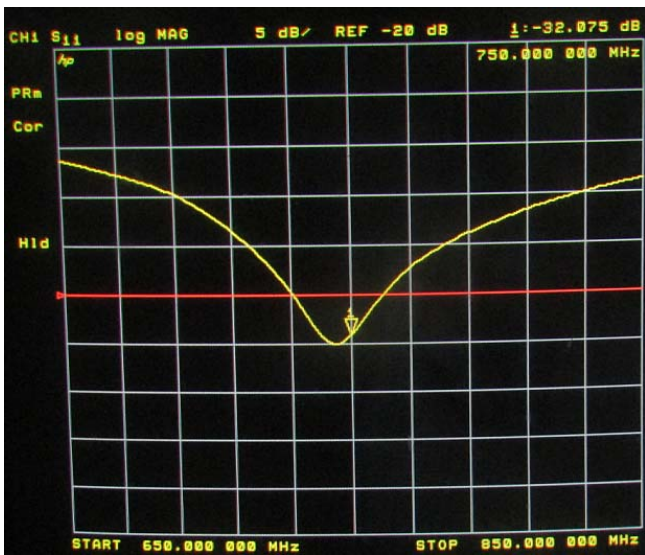
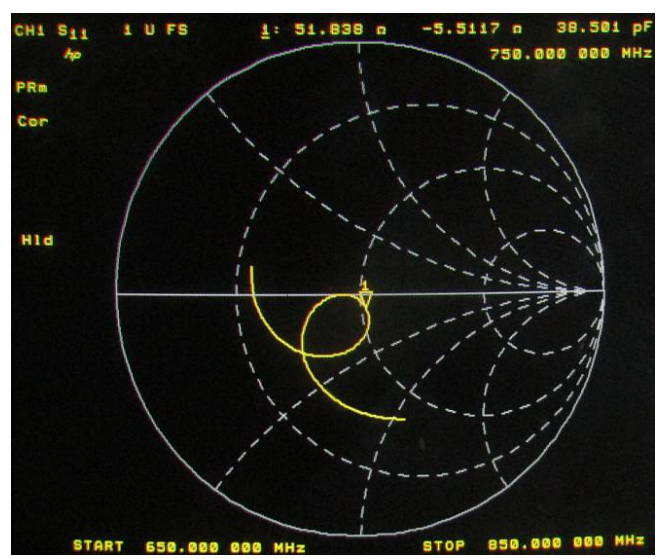
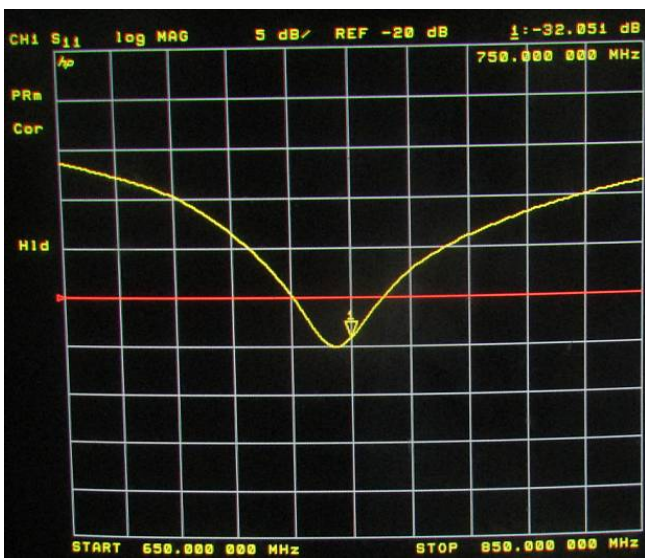

<Head 835MHz>

Return Loss (dB)	Delta (%)	Impedance	Delta(ohm)	Date of Measurement
-23.67	-	56.8	-	Apr. 19, 2018
-23.947	1.17	56.615	0.185	Apr. 18, 2019
-23.920	1.056	56.632	0.168	Apr. 17, 2020

The return loss is <-20dB, within 20% of prior calibration; the impedance is within 5 ohm of prior calibration. Therefore the verification result should support extended calibration.

Dipole Verification Data

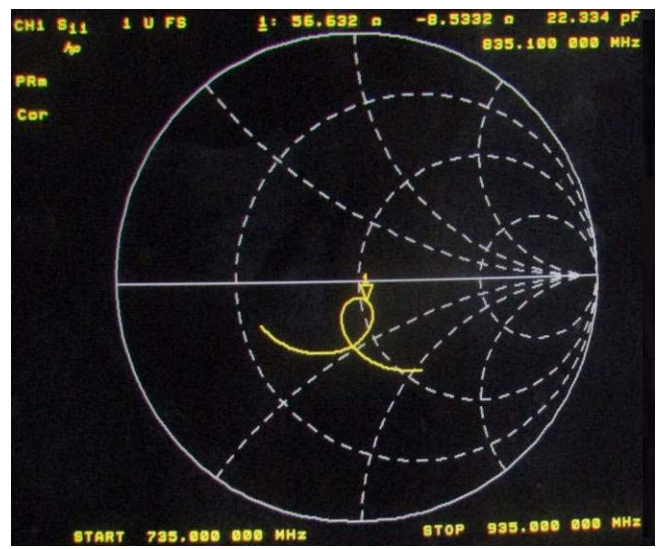
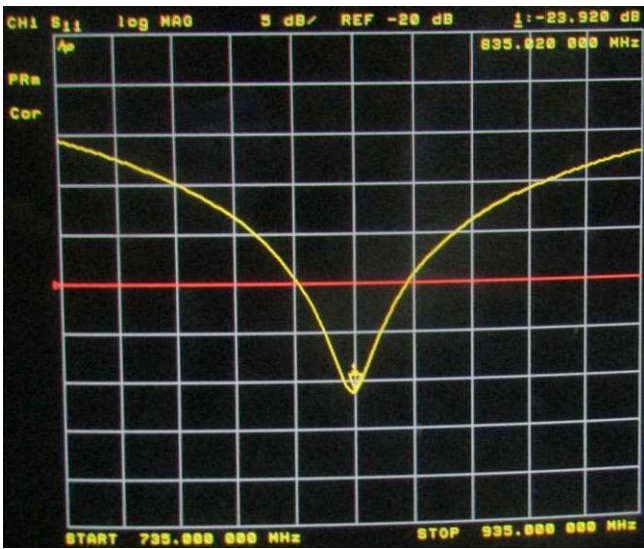
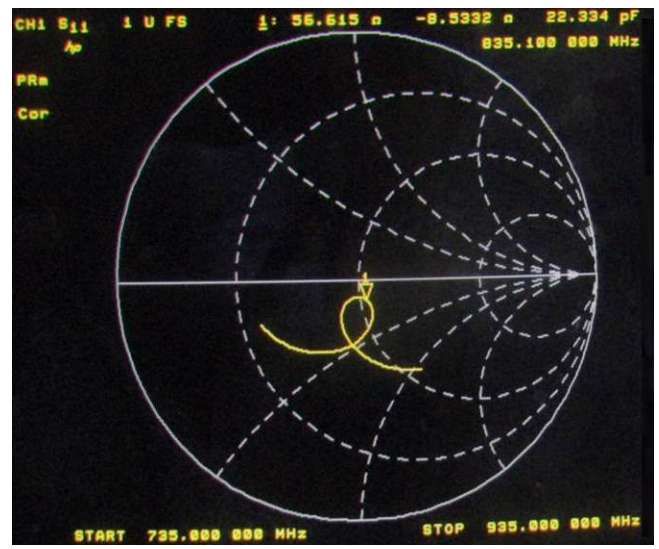
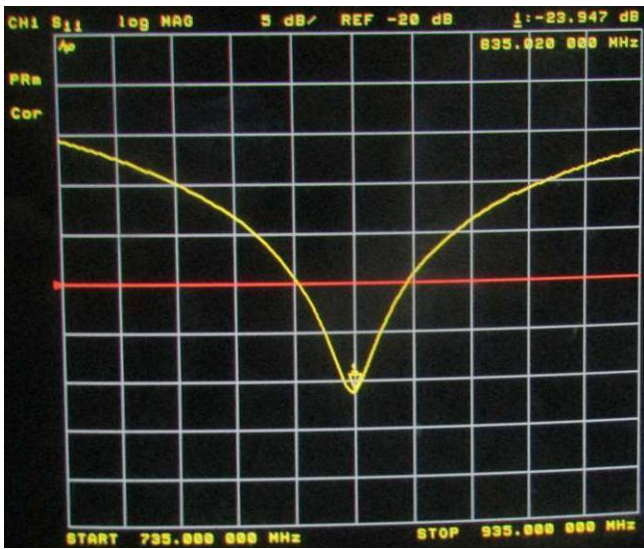

<Body 835MHz>

Return Loss (dB)	Delta (%)	Impedance	Delta(ohm)	Date of Measurement
-27.64	-	53.5	-	Apr. 19, 2018
-27.789	0.54	53.734	0.234	Apr. 18, 2019
-27.735	0.344	53.747	0.247	Apr. 17, 2020

The return loss is <-20dB, within 20% of prior calibration; the impedance is within 5 ohm of prior calibration. Therefore the verification result should support extended calibration.

Dipole Verification Data

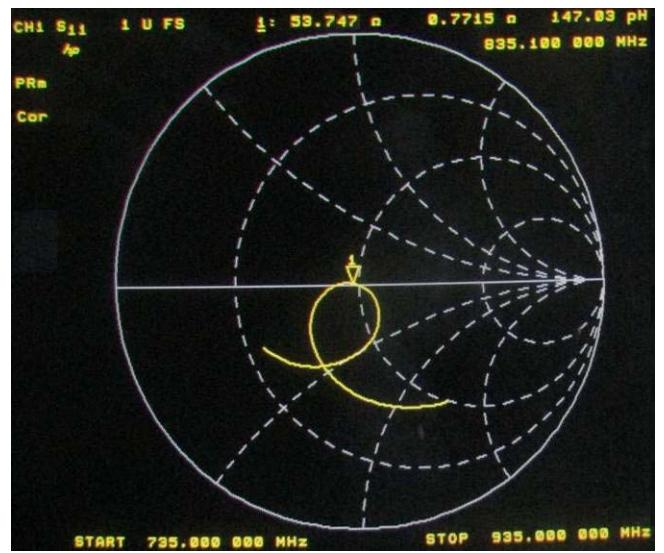
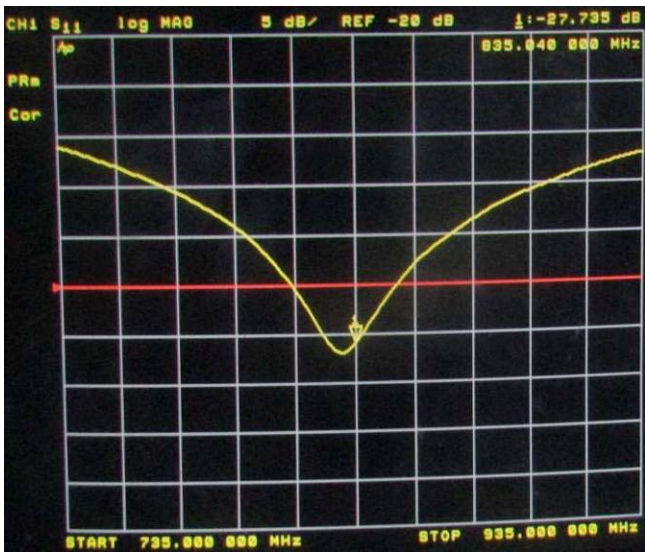
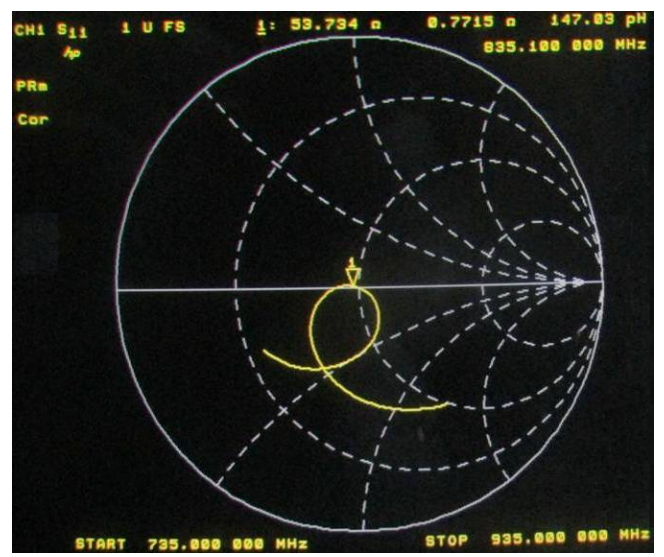
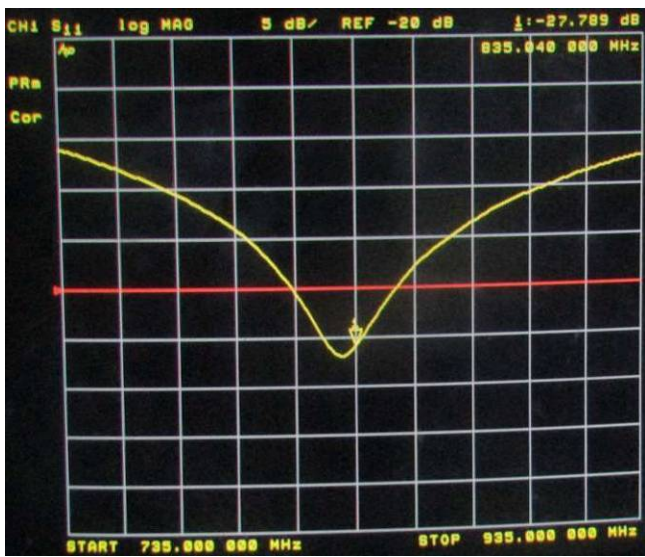

<Head 1800MHz>

Return Loss (dB)	Delta (%)	Impedance	Delta(ohm)	Date of Measurement
-26.62	-	47.3	-	Apr. 19, 2018
-25.8	3.080	45.156	2.144	Apr. 18, 2019
-25.880	2.780	45.246	2.054	Apr. 17, 2020

The return loss is <-20dB, within 20% of prior calibration; the impedance is within 5 ohm of prior calibration. Therefore the verification result should support extended calibration.

Dipole Verification Data

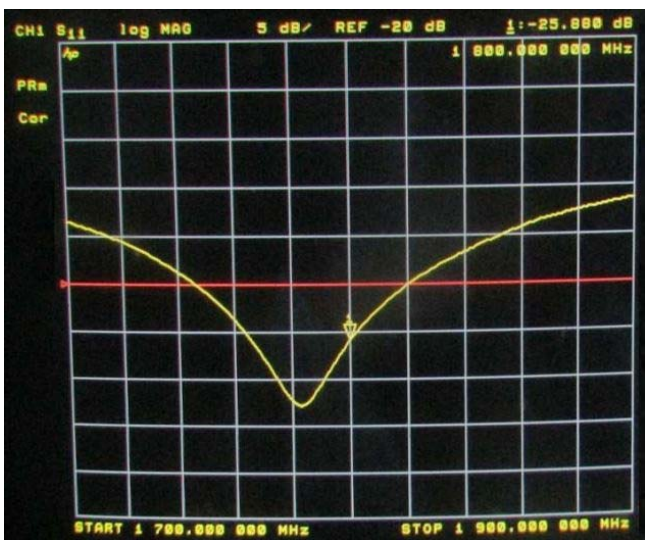
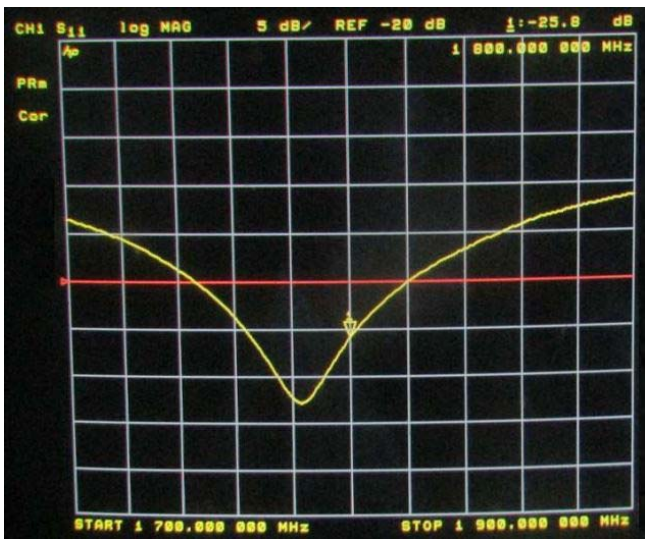

<Body 1800MHz>

Return Loss (dB)	Delta (%)	Impedance	Delta(ohm)	Date of Measurement
-27.86	-	46.2	-	Apr. 19, 2018
-27.017	3.026	44.51	1.69	Apr. 18, 2019
-27.027	2.990	44.32	1.88	Apr. 17, 2020

The return loss is <-20dB, within 20% of prior calibration; the impedance is within 5 ohm of prior calibration. Therefore the verification result should support extended calibration.

Dipole Verification Data

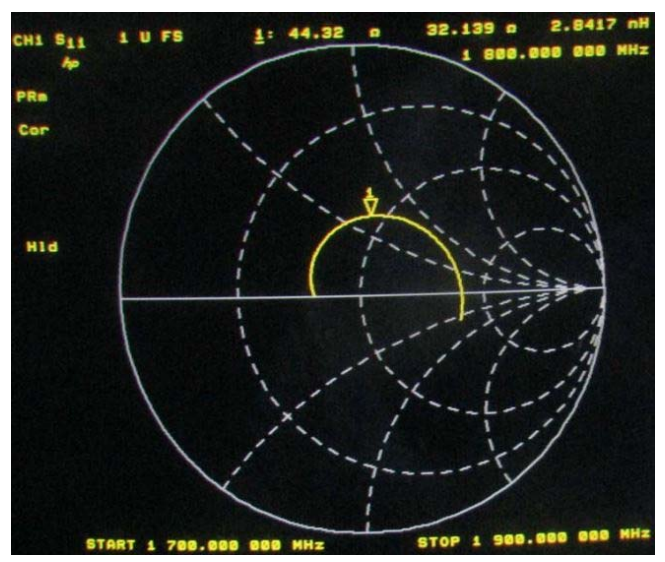
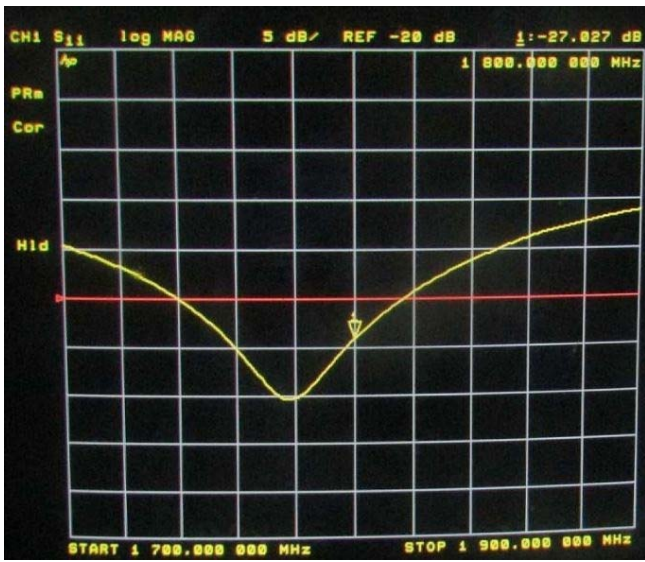
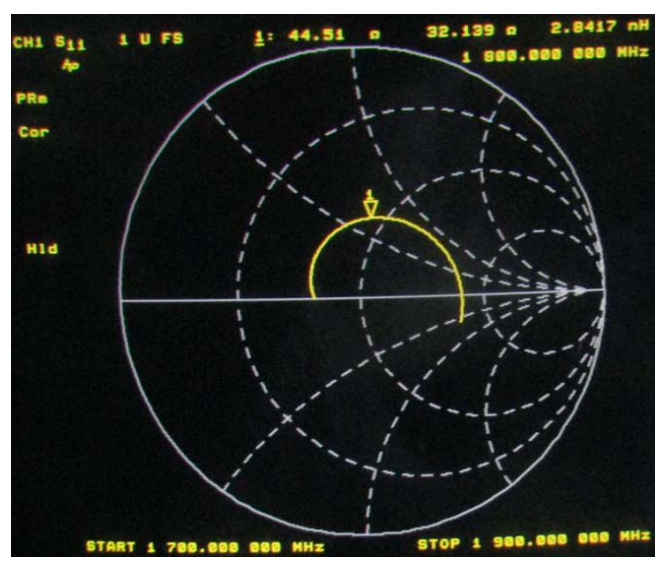
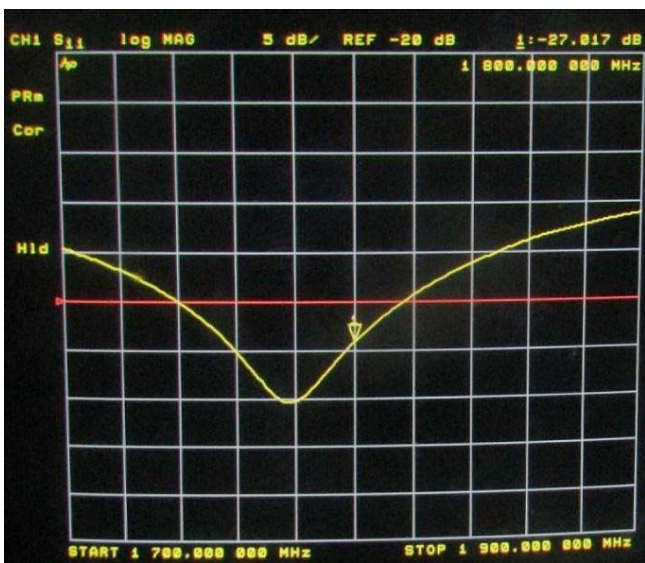

<Head 1900MHz>

Return Loss (dB)	Delta (%)	Impedance	Delta(ohm)	Date of Measurement
-25.15	-	52.6	-	Apr. 19, 2018
-23.144	7.976	53.604	1.004	Apr. 18, 2019
-23.923	4.879	53.344	0.744	Apr. 17, 2020

The return loss is <-20dB, within 20% of prior calibration; the impedance is within 5 ohm of prior calibration. Therefore the verification result should support extended calibration.

Dipole Verification Data

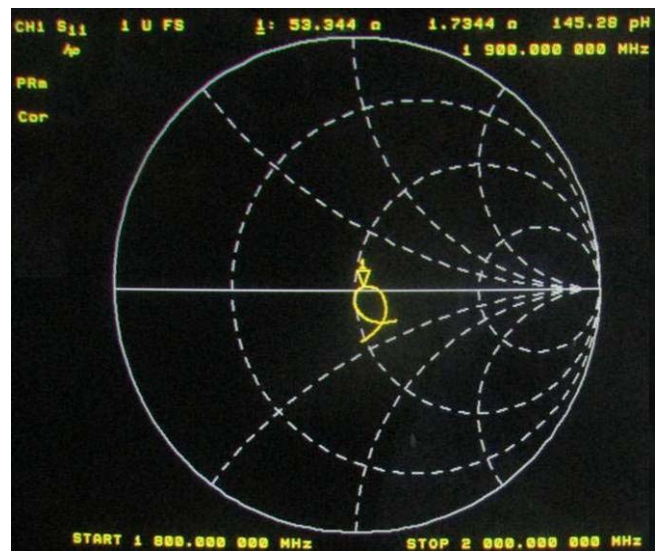
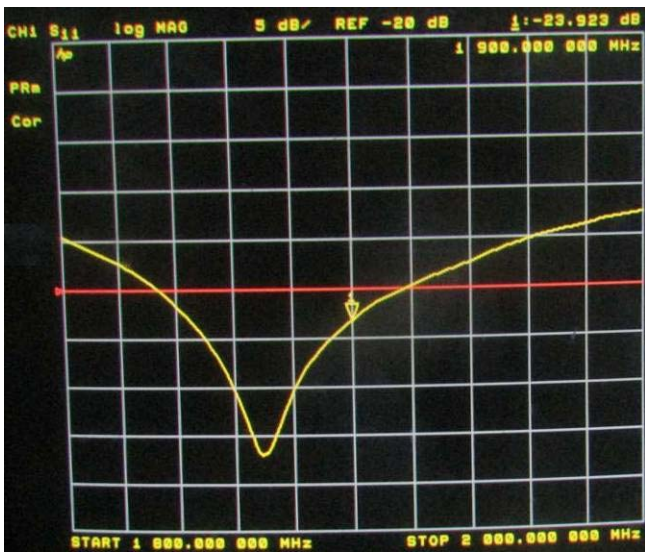
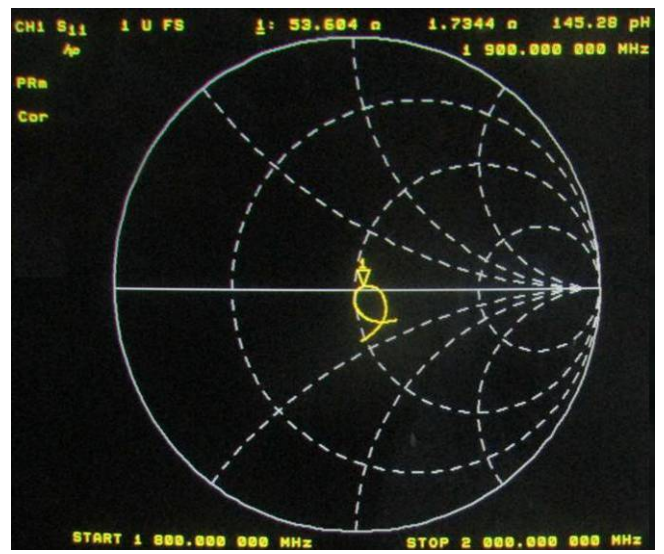
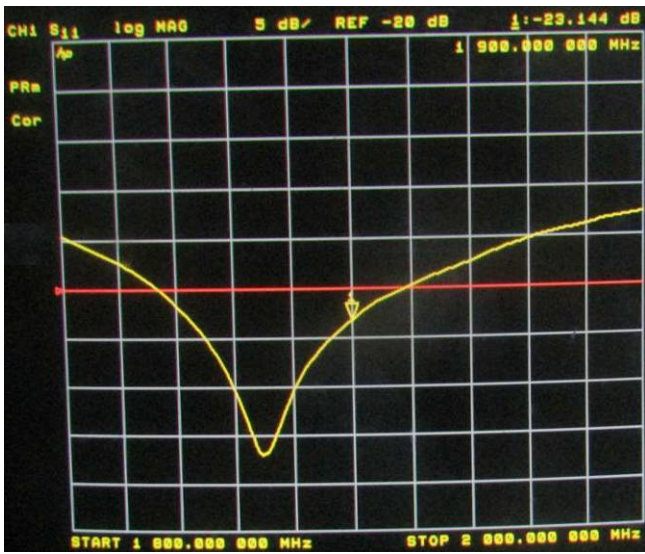

<Body 1900MHz>

Return Loss (dB)	Delta (%)	Impedance	Delta(ohm)	Date of Measurement
-22.99	-	47.6	-	Apr. 19, 2018
-22.679	1.353	49.311	1.711	Apr. 18, 2019
-22.690	1.305	49.385	1.785	Apr. 17, 2020

The return loss is <-20dB, within 20% of prior calibration; the impedance is within 5 ohm of prior calibration. Therefore the verification result should support extended calibration.

Dipole Verification Data

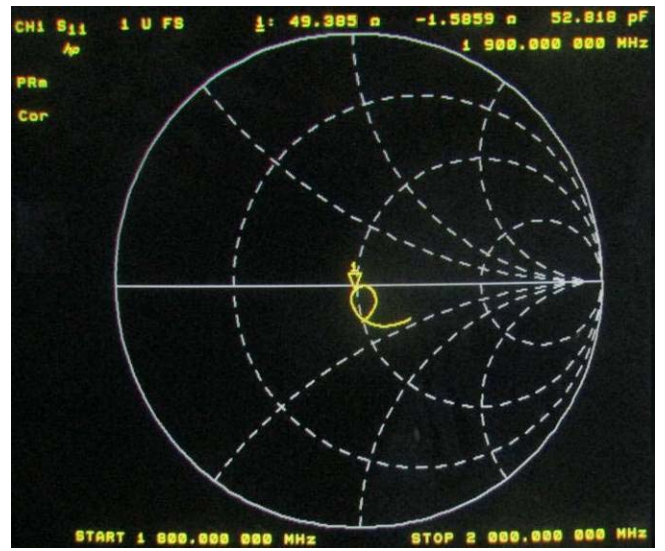
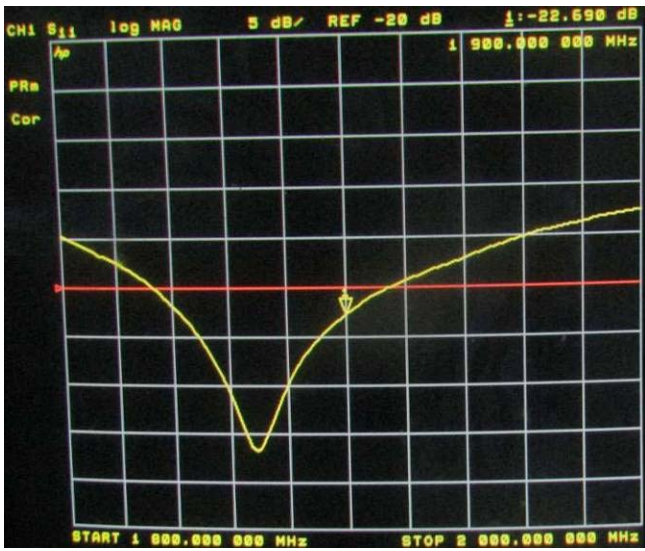
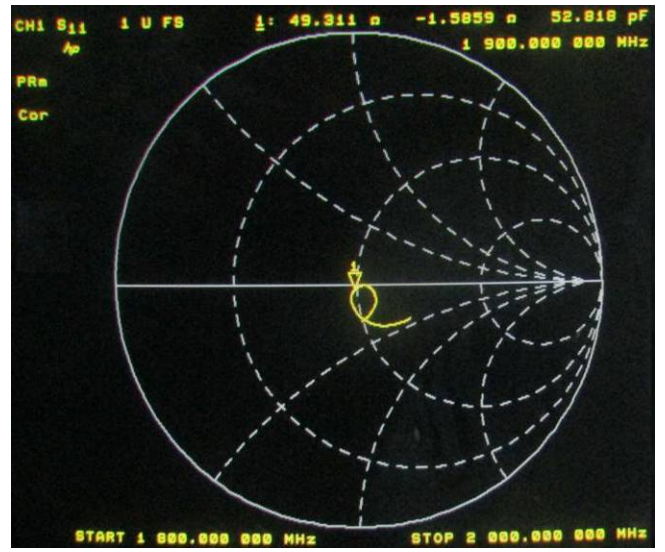
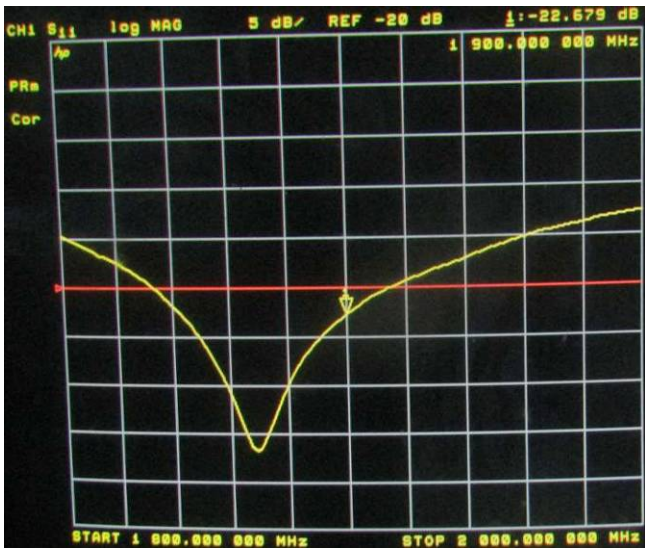



<Head 2450MHz>

Return Loss (dB)	Delta (%)	Impedance	Delta(ohm)	Date of Measurement
-28.15	-	53.9	-	Apr. 19, 2018
-26.296	6.586	54.99	1.09	Apr. 18, 2019
-26.456	6.018	54.65	0.75	Apr. 17, 2020

The return loss is <-20dB, within 20% of prior calibration; the impedance is within 5 ohm of prior calibration. Therefore the verification result should support extended calibration.

Dipole Verification Data

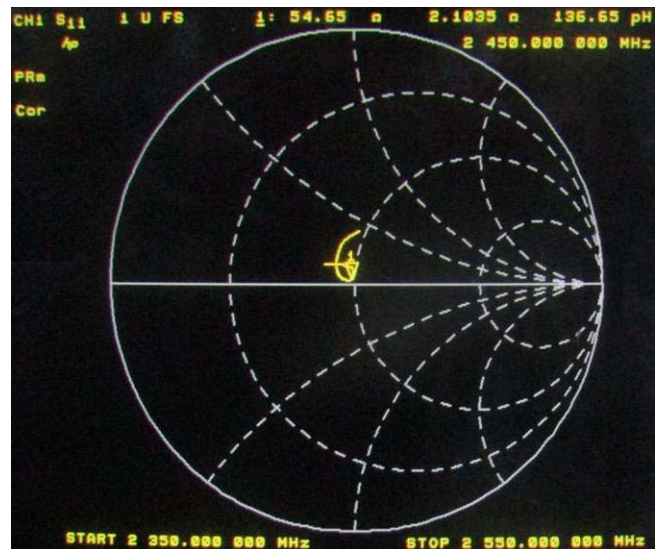
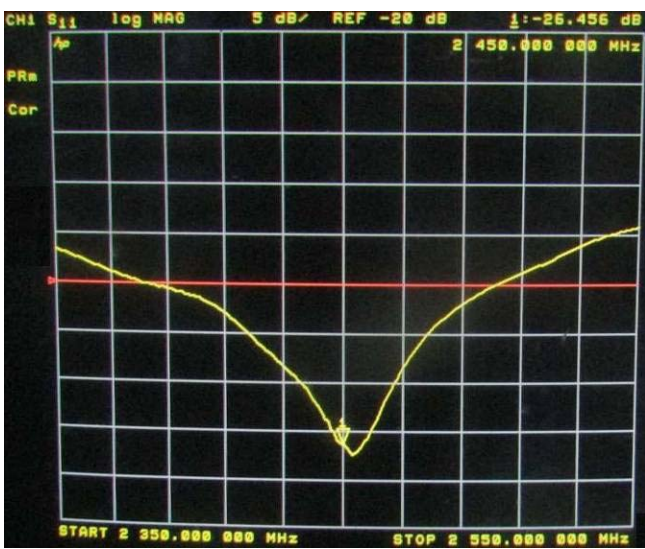
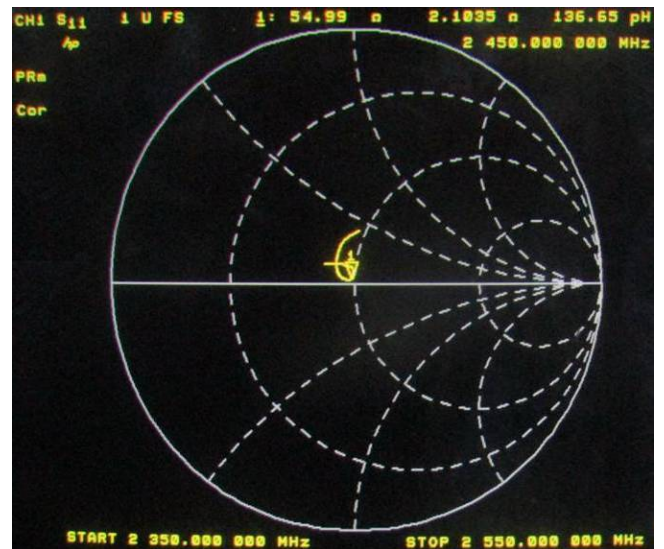
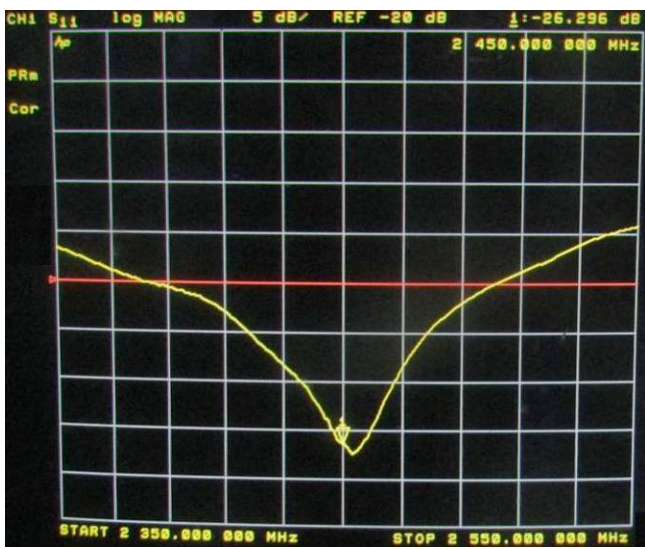

<Body 2450MHz>

Return Loss (dB)	Delta (%)	Impedance	Delta(ohm)	Date of Measurement
-22.99	-	57.6	-	Apr. 19, 2018
-20.498	10.840	56.16	1.44	Apr. 18, 2019
-20.445	11.07	56.26	8.66	Apr. 17, 2020

The return loss is <-20dB, within 20% of prior calibration; the impedance is within 5 ohm of prior calibration. Therefore the verification result should support extended calibration.

Dipole Verification Data

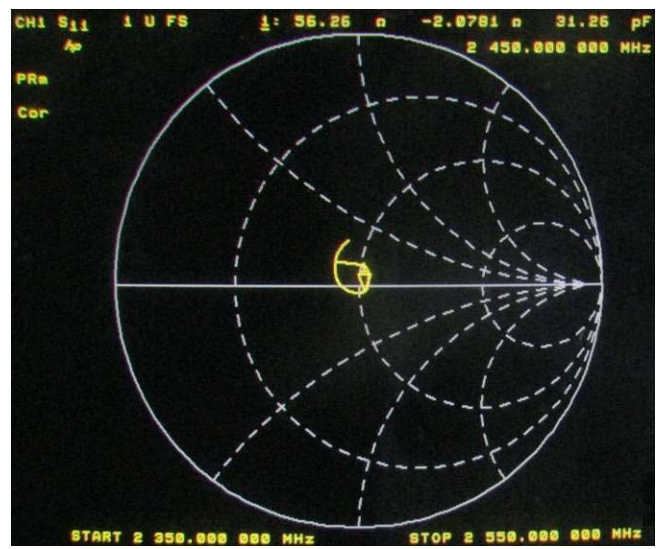
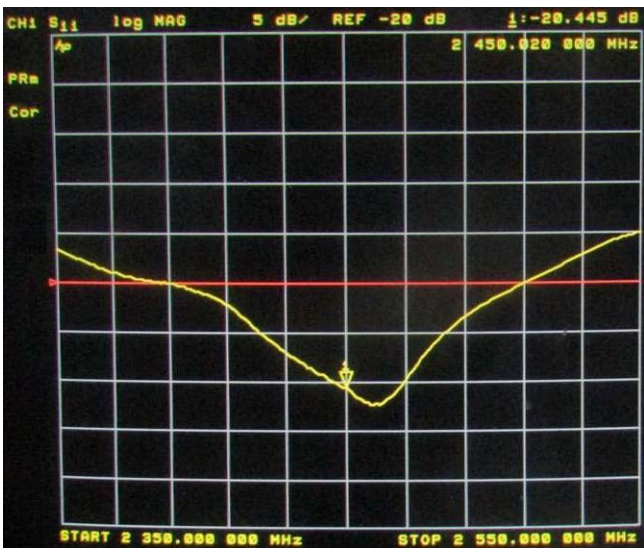
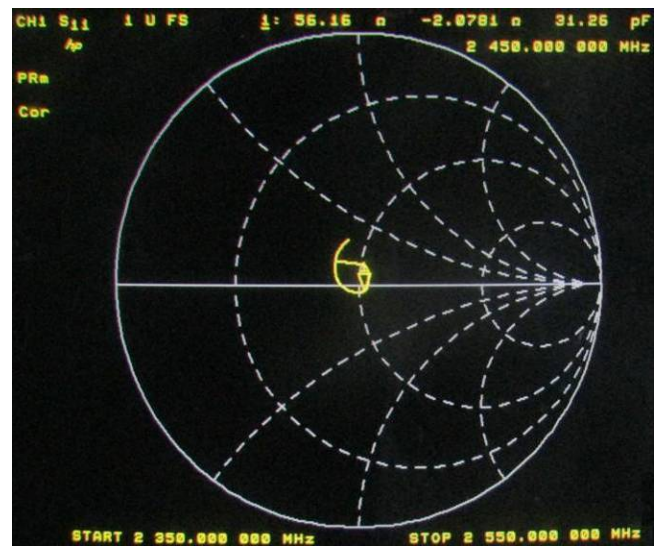
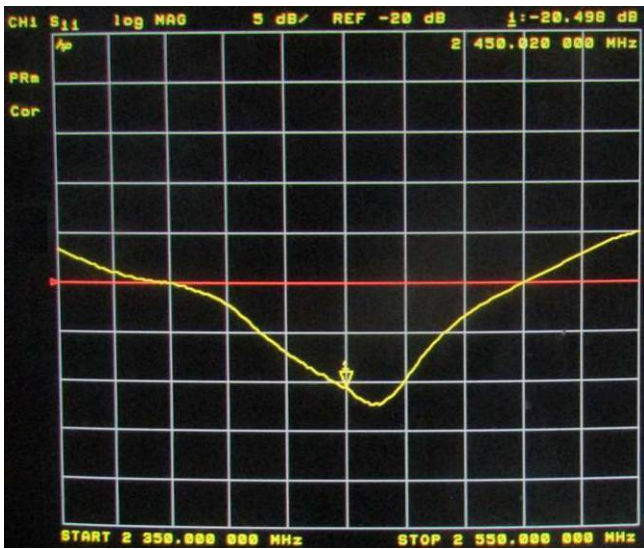

<Head 2600MHz>

Return Loss (dB)	Delta (%)	Impedance	Delta(ohm)	Date of Measurement
-20.85	-	54.9	-	Apr. 19, 2018
-21.627	3.727	54.412	0.488	Apr. 18, 2019
-21.660	3.885	54.470	0.43	Apr. 17, 2020

The return loss is <-20dB, within 20% of prior calibration; the impedance is within 5 ohm of prior calibration. Therefore the verification result should support extended calibration.

Dipole Verification Data

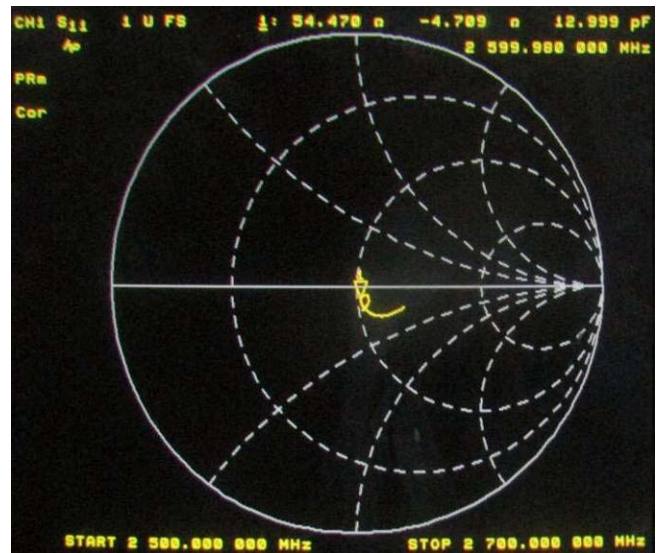
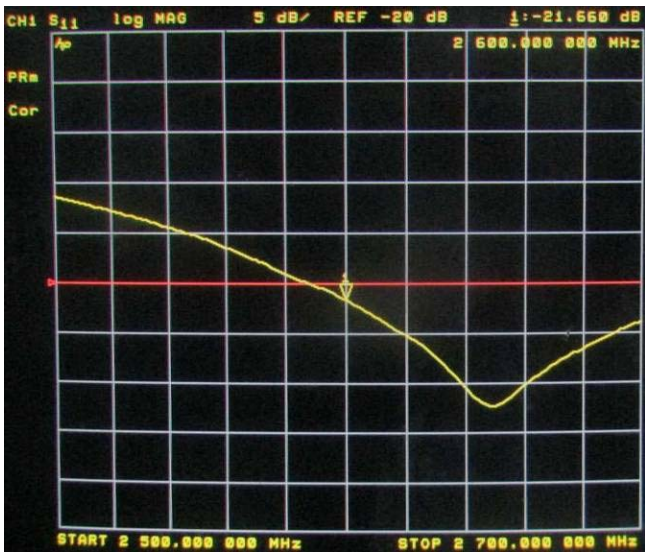
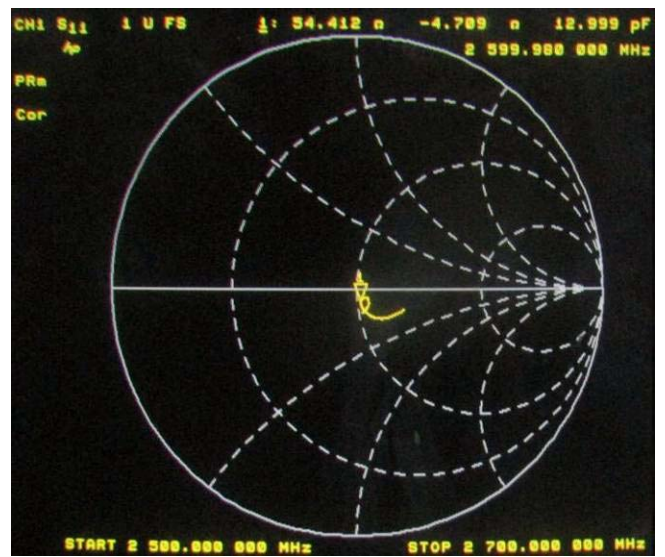
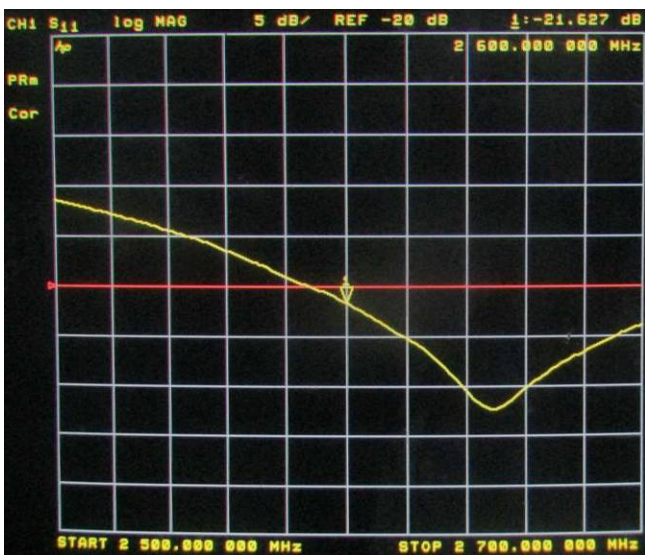

<Body 2600MHz>

Return Loss (dB)	Delta (%)	Impedance	Delta(ohm)	Date of Measurement
-23.23	-	50.6	-	Apr. 19, 2018
-22.966	1.136	49.629	0.971	Apr. 18, 2019
-22.959	1.1666	49.865	0.735	Apr. 17, 2020

The return loss is <-20dB, within 20% of prior calibration; the impedance is within 5 ohm of prior calibration. Therefore the verification result should support extended calibration.

Dipole Verification Data

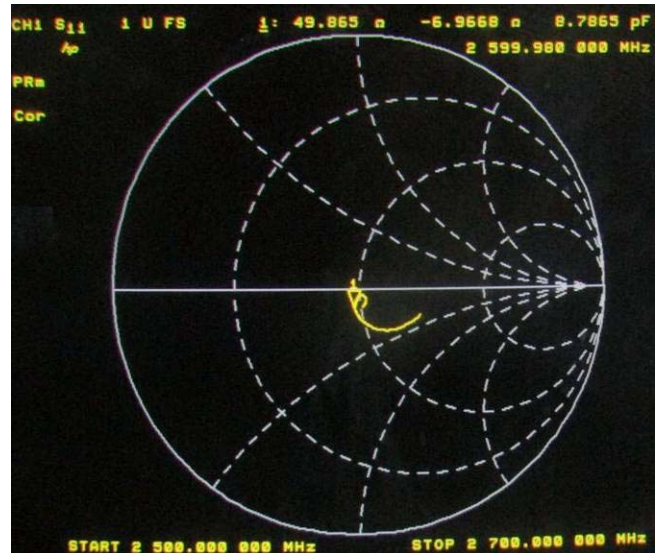
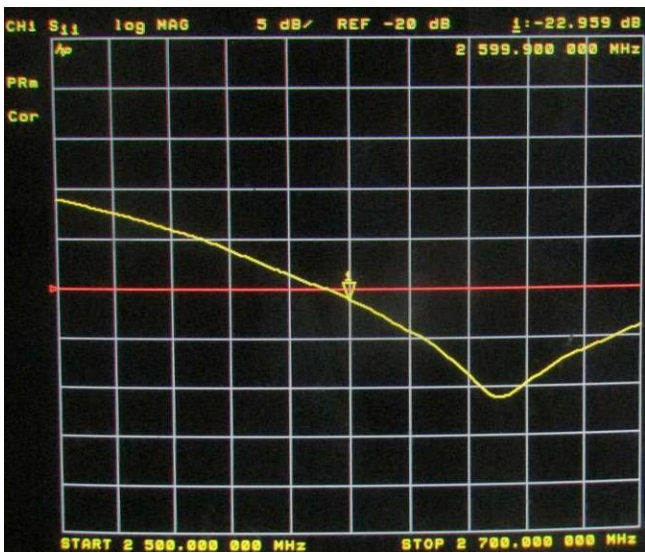
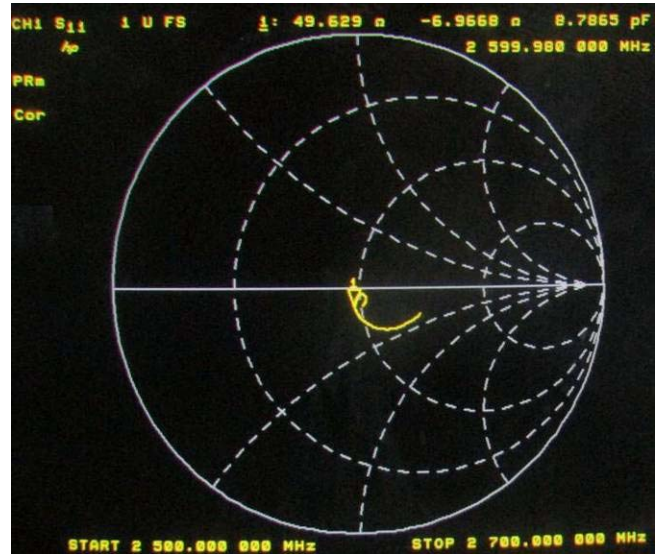
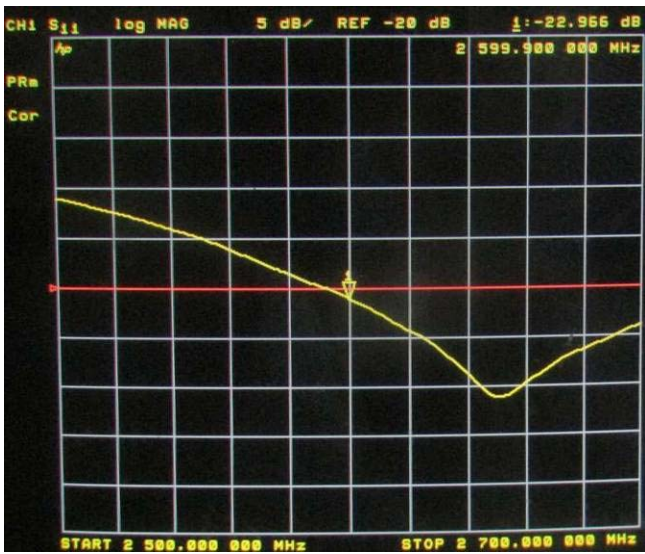

<Head 5200MHz>

Return Loss (dB)	Delta (%)	Impedance	Delta(ohm)	Date of Measurement
-8.23	-	26.31	-	Apr. 19, 2018
-8.317	1.057	26.673	0.363	Apr. 18, 2019
-8.200	0.365	26.412	0.102	Apr. 17, 2020

The return loss is <-8dB, within 20% of prior calibration; the impedance is within 5 ohm of prior calibration. Therefore the verification result should support extended calibration.

Dipole Verification Data

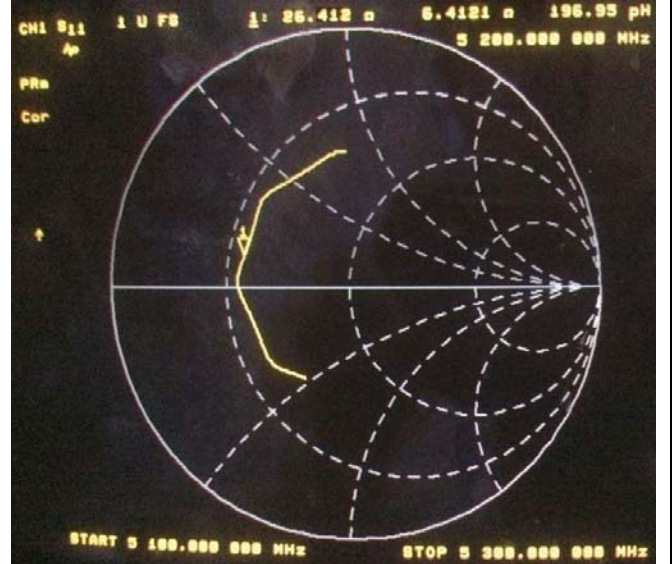
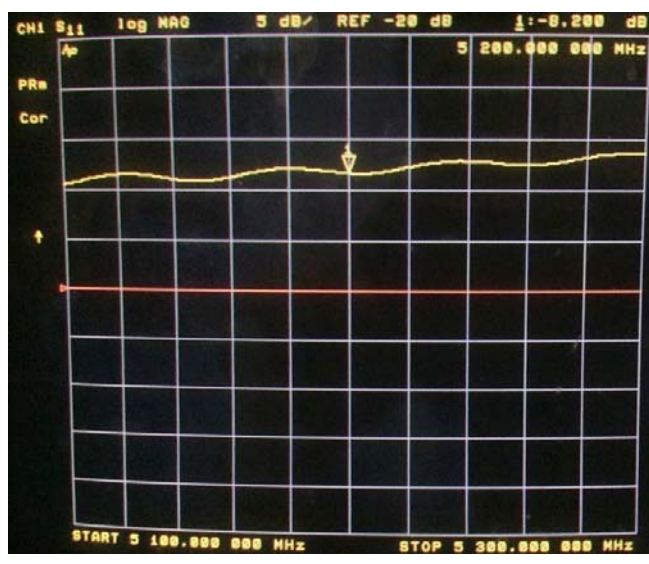
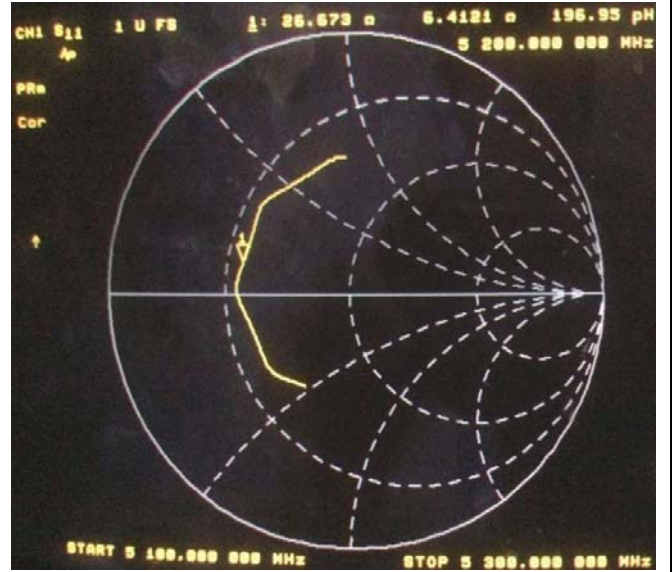
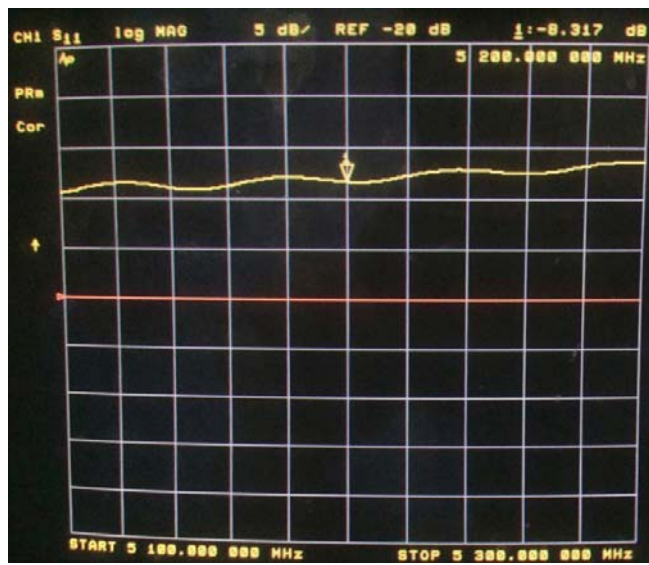

<Body 5200MHz>

Return Loss (dB)	Delta (%)	Impedance	Delta(ohm)	Date of Measurement
-9.40	-	97.78	-	Apr. 19, 2018
-9.090	3.298	98.293	0.513	Apr. 18, 2019
-9.022	4.021	98.688	0.908	Apr. 17, 2020

The return loss is <-8dB, within 20% of prior calibration; the impedance is within 5 ohm of prior calibration. Therefore the verification result should support extended calibration.

Dipole Verification Data

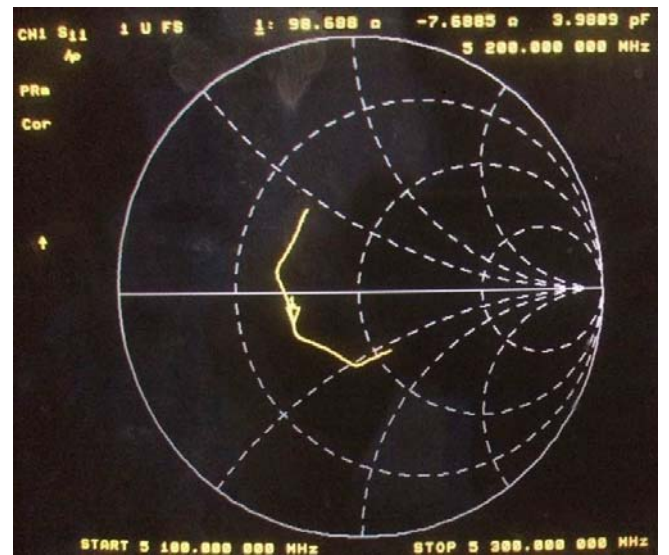
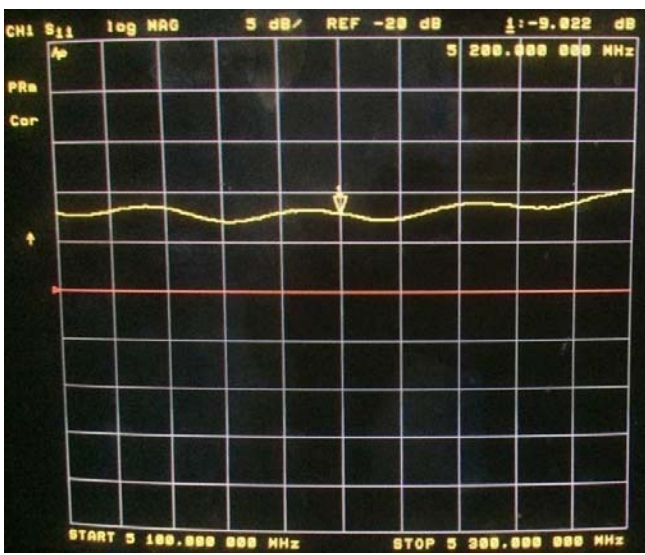
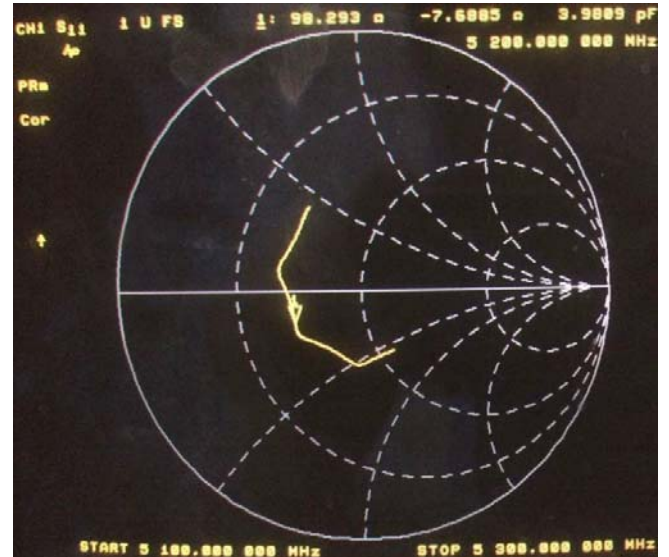
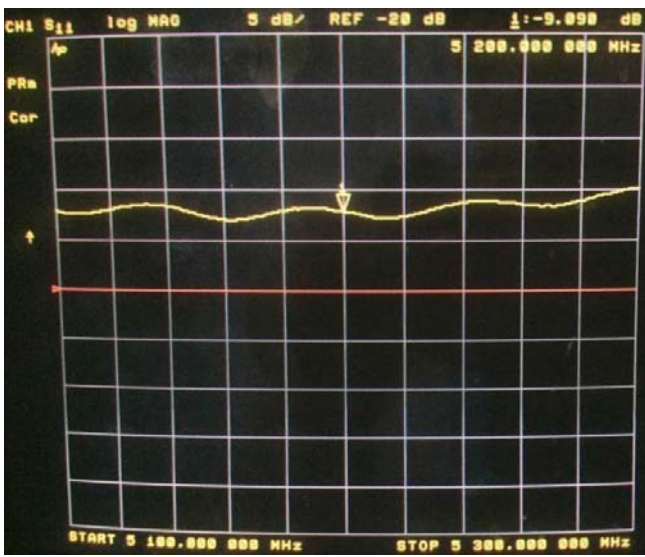

<Head 5800MHz>

Return Loss (dB)	Delta (%)	Impedance	Delta(ohm)	Date of Measurement
-12.03	-	59.85	-	Apr. 19, 2018
-12.638	5.054	55.318	4.532	Apr. 18, 2019
-12.808	6.467	55.209	4.641	Apr. 17, 2020

The return loss is <-8dB, within 20% of prior calibration; the impedance is within 5 ohm of prior calibration. Therefore the verification result should support extended calibration.

Dipole Verification Data

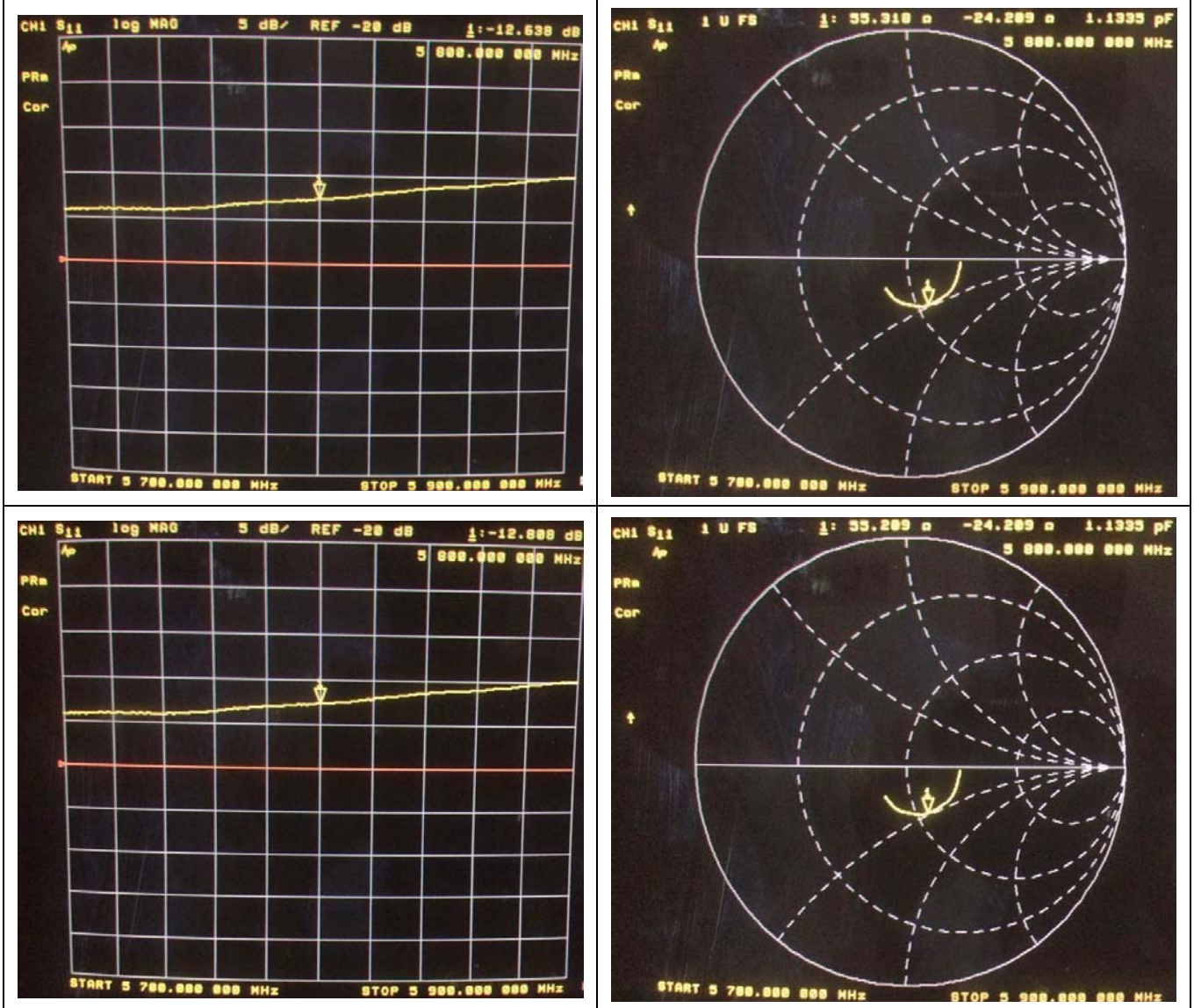

<Body 5800MHz>

Return Loss (dB)	Delta (%)	Impedance	Delta(ohm)	Date of Measurement
-12.37	-	36.66	-	Apr. 19, 2018
-12.103	2.158	38.023	1.363	Apr. 18, 2019
-12.203	1.350	38.143	1.483	Apr. 17, 2020

The return loss is <math>< -8\text{dB}</math>, within 20% of prior calibration; the impedance is within 5 ohm of prior calibration. Therefore the verification result should support extended calibration.

Dipole Verification Data

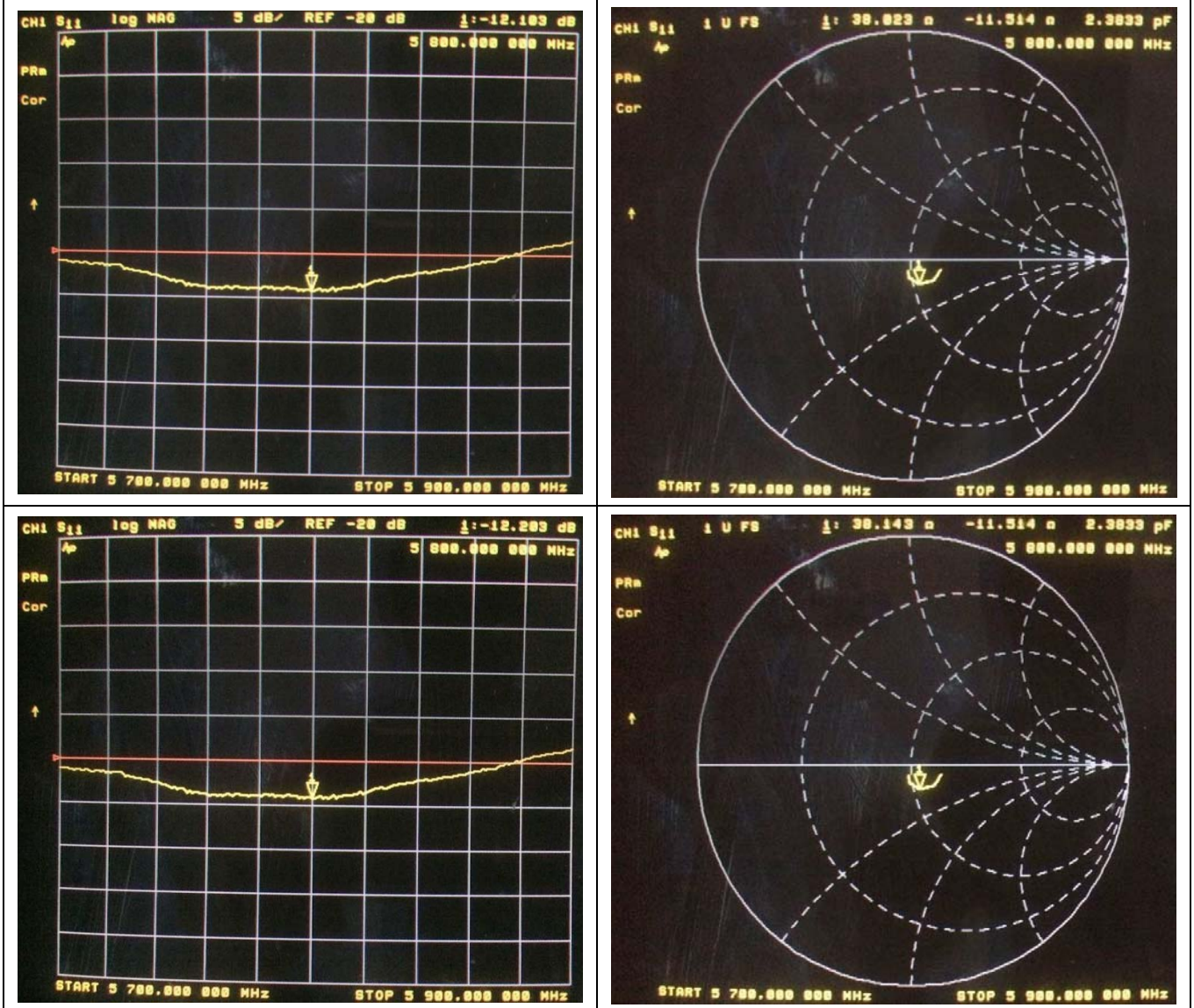

END