

FCC RADIO TEST REPORT

FCC ID: 2AOWK3081

Product : Mobile Phone

Trade Mark : ulefone

Model Name : GQ3081

Family Model : Power 6, Power 6S, Power 6X,
Power 6E, Power 6 Pro, Power 6 Plus

Report No. : S19040800205004

Prepared for

Shenzhen Gotron Electronic CO.,LTD.
518, 5F, R&D building, Tsinghua Hi-Tech park, Nanshan district,
Shenzhen 518057 P.R.China

Prepared by

Shenzhen NTEK Testing Technology Co., Ltd.
1/F, Building E, Fenda Science Park, Sanwei Community,
Xixiang Street Bao'an District, Shenzhen 518126 P.R. China
Tel.: +86-755-6115 6588
Fax.: +86-755-6115 6599
Website:<http://www.ntek.org.cn>

TEST RESULT CERTIFICATION

Applicant's name : Shenzhen Gotron Electronic CO.,LTD.
Address : 518, 5F, R&D building, Tsinghua Hi-Tech park, Nanshan district, Shenzhen 518057 P.R.China

Manufacturer's Name : Shenzhen Gotron Electronic CO.,LTD.
Address : 518, 5F, R&D building, Tsinghua Hi-Tech park, Nanshan district, Shenzhen 518057 P.R.China

Product description

Product name : Mobile Phone
Model and/or type reference : GQ3081
Family Model : Power 6, Power 6S, Power 6X, Power 6E, Power 6 Pro, Power 6 Plus

Standards : FCC Part15.407

Test procedure : ANSI C63.10-2013 and KDB 789033 D02 General UNII Test Procedures New Rules v02r01

This device described above has been tested by NTEK, and the test results show that the equipment under test (EUT) is in compliance with the FCC requirements/ the Industry Canada requirements.. And it is applicable only to the tested sample identified in the report.

This report shall not be reproduced except in full, without the written approval of NTEK, this document may be altered or revised by NTEK, personnel only, and shall be noted in the revision of the document.

Date of Test

Date (s) of performance of tests : Apr. 10, 2019 ~ May. 17, 2019

Date of Issue : Jun. 05, 2019

Test Result : Pass

Testing Engineer : [Signature: Cheng Jiawen]
(Cheng Jiawen)

Technical Manager : [Signature: Jason chen]
(Jason Chen)

Authorized Signatory : [Signature: Sam. chen]
(Sam Chen)

Table of Contents

	Page
1 . SUMMARY OF TEST RESULTS	6
1.1 FACILITIES AND ACCREDITATIONS	7
1.2 MEASUREMENT UNCERTAINTY	7
2 . GENERAL INFORMATION	8
2.1 GENERAL DESCRIPTION OF EUT	8
2.2 DESCRIPTION OF TEST MODES	10
2.3 BLOCK DIGRAM SHOWING THE CONFIGURATION OF SYSTEM TESTED	11
2.4 DESCRIPTION OF SUPPORT UNITS(CONDUCTED MODE)	12
2.5 EQUIPMENTS LIST FOR ALL TEST ITEMS	13
3 . EMC EMISSION TEST	15
3.1 CONDUCTED EMISSION MEASUREMENT	15
3.1.1 APPLICABLE STANDARD	15
3.1.2 CONFORMANCE LIMIT	15
3.1.3 TEST CONFIGURATION	15
3.1.4 TEST PROCEDURE	15
3.2 RADIATED EMISSION MEASUREMENT	20
3.2.1 APPLICABLE STANDARD	20
3.2.2 CONFORMANCE LIMIT	20
3.2.3 MEASURING INSTRUMENTS	20
3.2.4 TEST CONFIGURATION	21
3.2.5 TEST PROCEDURE	22
3.2.6 TEST RESULTS (9KHZ – 30 MHZ)	23
3.2.7 TEST RESULTS (30MHZ – 1GHZ)	24
3.2.8 TEST RESULTS (1GHZ-18GHZ)	28
3.2.9 TEST RESULTS (18GHZ-40GHZ)	30
4 . POWER SPECTRAL DENSITY TEST	34
4.1 APPLIED PROCEDURES / LIMIT	34
4.2 TEST PROCEDURE	35
4.3 DEVIATION FROM STANDARD	35
4.4 TEST SETUP	35
4.5 EUT OPERATION CONDITIONS	35
4.6 TEST RESULTS	36
5 . 26DB & 99% EMISSION BANDWIDTH	44
5.1 APPLIED PROCEDURES / LIMIT	44
5.2 TEST PROCEDURE	44
5.3 EUT OPERATION CONDITIONS	45
5.4 TEST RESULTS	46

Table of Contents

	Page
6 . MINIMUM 6 DB BANDWIDTH	54
6.1 APPLIED PROCEDURES / LIMIT	54
6.2 TEST PROCEDURE	54
6.3 DEVIATION FROM STANDARD	54
6.4 TEST SETUP	54
6.5 EUT OPERATION CONDITIONS	54
6.6 TEST RESULTS	55
7 . MAXIMUM CONDUCTED OUTPUT POWER	59
7.1 PPLIED PROCEDURES / LIMIT	59
7.2 TEST PROCEDURE	59
7.3 DEVIATION FROM STANDARD	61
7.4 TEST SETUP	61
7.5 EUT OPERATION CONDITIONS	61
7.6 TEST RESULTS	62
8 . OUT OF BAND EMISSIONS	64
8.1 APPLICABLE STANDARD	64
8.2 TEST PROCEDURE	64
8.3 DEVIATION FROM STANDARD	64
8.4 TEST SETUP	65
8.5 EUT OPERATION CONDITIONS	65
8.6 TEST RESULTS	65
9.SPURIOUS RF CONDUCTED EMISSIONS	71
9.1CONFORMANCE LIMIT	71
9.2MEASURING INSTRUMENTS	71
9.3TEST SETUP	71
9.4TEST PROCEDURE	71
9.5TEST RESULTS	71
10.FREQUENCY STABILITY MEASUREMENT	78
10.1 LIMIT	78
10.2 TEST PROCEDURES	78
10.3 TEST SETUP LAYOUT	78
10.4 EUT OPERATION DURING TEST	78
10.5 TEST RESULTS	79
11. ANTENNA REQUIREMENT	85
11.1 STANDARD REQUIREMENT	85
11.2 EUT ANTENNA	85

Revision History

Report No.	Version	Description	Issued Date
S19040800205004	Rev.01	Initial issue of report	Jun. 05, 2019

1. SUMMARY OF TEST RESULTS

Test procedures according to the technical standards:

FCC Part15 (15.407) , Subpart E			
Standard Section	Test Item	Judgment	Remark
15.207	AC Power Line Conducted Emissions	PASS	
15.209(a), 15.407 (b)(1) 15.407 (b)(4) 15.407 (b)(6)	Spurious Radiated Emissions	PASS	
15.407 (a)(1) 15.407 (a)(3) 15.1049	26 dB and 99% Emission Bandwidth	PASS	
15.407(e)	Minimum 6 dB bandwidth	PASS	
15.407 (a)(1) 15.407 (a)(3)	Maximum Conducted Output Power	PASS	
2.1051, 15.407(b)(1) 15.407(b)(4)	Band Edge	PASS	
15.407 (a)(1) 15.407 (a)(3)	Power Spectral Density	PASS	
2.1051, 15.407(b)	Spurious Emissions at Antenna Terminals	PASS	
15.203	Antenna Requirement	PASS	

NOTE:

(1) "N/A" denotes test is not applicable in this Test Report

1.1 FACILITIES AND ACCREDITATIONS

FACILITIES

All measurement facilities used to collect the measurement data are located at 1/F, Building E, Fenda Science Park, Sanwei Community, Xixiang Street, Bao'an District, Shenzhen 518126 P.R. China.

The sites are constructed in conformance with the requirements of ANSI C63.7, ANSI C63.10 and CISPR Publication 22.

LABORATORY ACCREDITATIONS AND LISTINGS

Site Description

CNAS-Lab. : The Laboratory has been assessed and proved to be in compliance with CNAS-CL01:2006 (identical to ISO/IEC 17025:2005)
The Certificate Registration Number is L5516.

IC-Registration The Certificate Registration Number is 9270A-1.

FCC- Accredited Test Firm Registration Number: 463705.
Designation Number: CN1184

A2LA-Lab. The Certificate Registration Number is 4298.01
This laboratory is accredited in accordance with the recognized International Standard ISO/IEC 17025:2005 General requirements for the competence of testing and calibration laboratories.
This accreditation demonstrates technical competence for a defined scope and the operation of a laboratory quality management system (refer to joint ISO-ILAC-IAF Communiqué dated 8 January 2009).

Name of Firm : Shenzhen NTEK Testing Technology Co., Ltd.

Site Location : 1/F, Building E, Fenda Science Park, Sanwei Community, Xixiang Street, Bao'an District, Shenzhen 518126 P.R. China.

1.2 MEASUREMENT UNCERTAINTY

The reported uncertainty of measurement $y \pm U$, where expanded uncertainty U is based on a standard uncertainty multiplied by a coverage factor of $k=2$, providing a level of confidence of approximately 95 %.

No.	Item	Uncertainty
1	Conducted Emission Test	$\pm 2.80\text{dB}$
2	RF power, conducted	$\pm 0.16\text{dB}$
3	Spurious emissions, conducted	$\pm 0.21\text{dB}$
4	All emissions, radiated(30MHz~1GHz)	$\pm 2.64\text{dB}$
5	All emissions, radiated(1GHz~6GHz)	$\pm 2.40\text{dB}$
6	All emissions, radiated(> 6GHz)	$\pm 2.52\text{dB}$
7	Temperature	$\pm 0.5\text{C}$
8	Humidity	$\pm 2\%$

2. GENERAL INFORMATION

2.1 GENERAL DESCRIPTION OF EUT

Equipment	Mobile Phone		
Trade Mark	ulefone		
Model Name	GQ3081		
Family Model	Power 6, Power 6S, Power 6X, Power 6E, Power 6 Pro, Power 6 Plus		
Model Difference	All models are the same circuit and RF module, except the model name.		
FCC ID	2AOWK3081		
Product Description	Mode Supported	<input checked="" type="checkbox"/> 802.11a <input checked="" type="checkbox"/> 802.11n(HT20) <input checked="" type="checkbox"/> 802.11n(HT40) <input checked="" type="checkbox"/> 802.11ac(HT20) <input checked="" type="checkbox"/> 802.11ac(HT40) <input checked="" type="checkbox"/> 802.11ac(HT80)	
	Data Rate	802.11a: 6,9,12,18,24,36,48,54Mbps; 802.11n(HT20/HT40):MCS0-MCS15; 802.11ac(VHT20): NSS1, MCS0-MCS8 802.11ac(VHT40/VHT80):NSS1, MCS0-MCS9	
	Modulation	OFDM with BPSK/QPSK/16QAM/64QAM	
	Operating Frequency Range	<input checked="" type="checkbox"/> 5180-5240MHz for 802.11a/n(HT20)/ac20; 5190-5230MHz for 802.11n(HT40)/ac40; 5210MHz for 802.11 ac80; <input checked="" type="checkbox"/> 5745-5825 MHz for 802.11a/n(HT20)/ac20; 5755-5795 MHz for 802.11a/n(HT40)/ac40; 5775MHz for 802.11 ac80;	
	Number of Channels	<input checked="" type="checkbox"/> 4 channels for 802.11a/n20/ac20 in the 5180-5240MHz band ; 2 channels for 802.11 n40/ac40 in the 5190-5230MHz band ; 1 channels for 802.11 ac80 in the 5210MHz band ; <input checked="" type="checkbox"/> 5 channels for 802.11a/n20/ac20 in the 5745-5825MHz band ; 2 channels for 802.11 n40/ac40 in the 5755-5795MHz band ; 1 channels for 802.11 ac80 in the 5775MHz band ;	
	Antenna Type	PIFA Antenna	
	Antenna Gain	1dBi	
	Based on the application, features, or specification exhibited in User's Manual, More details of EUT technical specification, please refer to the User's Manual.		
	Ratings	DC 3.85V/6350mAh from Battery or DC 5V from USB Port.	
	Adapter	Model:HJ-0503000K7-US Input: 100-240V~50/60Hz 0.6A Output: 5V---3000mA	
Connecting I/O Port(s)	Please refer to the User's Manual		
HW Version	HCT-M860MB-B1		
SW Version	Power_6_SF1_EEA_V01		

Note:

1. For a more detailed features description, please refer to the manufacturer's specifications or the User's Manual.
2. Frequency and Channel list for 802.11a/n(20MHz) band I (5180-5240MHz):

802.11a/n/ac(20MHz) Carrier Frequency Channel							
Channel	Frequency (MHz)	Channel	Frequency (MHz)	Channel	Frequency (MHz)	Channel	Frequency (MHz)
36	5180	44	5220	-	-	-	-
40	5200	48	5240	-	-	-	-

Frequency and Channel list for 802.11n(40MHz) band I (5190-5230MHz):

802.11n /ac(40MHz) Carrier Frequency Channel							
Channel	Frequency (MHz)	Channel	Frequency (MHz)	Channel	Frequency (MHz)	Channel	Frequency (MHz)
38	5190	-	-	-	-	-	-
46	5230	-	-	-	-	-	-

802.11ac (80MHz) Carrier Frequency Channel	
Channel	Frequency (MHz)
42	5210

Frequency and Channel list for 802.11a/n(20 MHz) band IV (5745-5825MHz):

802.11a/n/ac(20 MHz) Carrier Frequency Channel							
Channel	Frequency (MHz)	Channel	Frequency (MHz)	Channel	Frequency (MHz)	Channel	Frequency (MHz)
149	5745	153	5765	157	5785	161	5805
165	5825	-	-	-	-	-	-

Frequency and Channel list for 802.11n(40MHz) band IV (5755-5795MHz):

802.11n/ac 40MHz Carrier Frequency Channel					
Channel	Frequency (MHz)	Channel	Frequency (MHz)	Channel	Frequency (MHz)
151	5755	159	5795	-	-

802.11ac 80MHz Carrier Frequency Channel	
Channel	Frequency (MHz)
155	5775

2.2 DESCRIPTION OF TEST MODES

To investigate the maximum EMI emission characteristics generates from EUT, the test system was pre-scanning tested base on the consideration of following EUT operation mode or test configuration mode which possible have effect on EMI emission level. Each of these EUT operation mode(s) or test configuration mode(s) mentioned above was evaluated respectively.

Pretest Mode	Description
Mode 1	Normal Link Mode
Mode 2	802.11a / n/ ac 20 CH36/ CH40/ CH 48 802.11a /n/ ac 20 CH149/ CH157/ CH 165
Mode 3	802.11n/ ac40 CH38/ CH 46 802.11n/ ac40 CH 151 / CH 159
Mode 4	802.11 ac80 CH 42/CH 155

For Radiated Emission	
Final Test Mode	Description
Mode 1	Normal Link Mode
Mode 2	802.11a / n/ ac 20 CH36/ CH40/ CH 48 802.11a /n/ ac 20 CH149/ CH157/ CH 165
Mode 3	802.11n/ ac40 CH38/ CH 46 802.11n/ ac40 CH 151 / CH 159
Mode 4	802.11 ac80 CH 42/CH 155

Note:

- (1) The measurements are performed at the highest, middle, lowest available channels.
- (2) The measurements are performed at all Bit Rate of Transmitter, the worst data was reported

2.3 BLOCK DIGRAM SHOWING THE CONFIGURATION OF SYSTEM TESTED

For AC Conducted Emission Mode

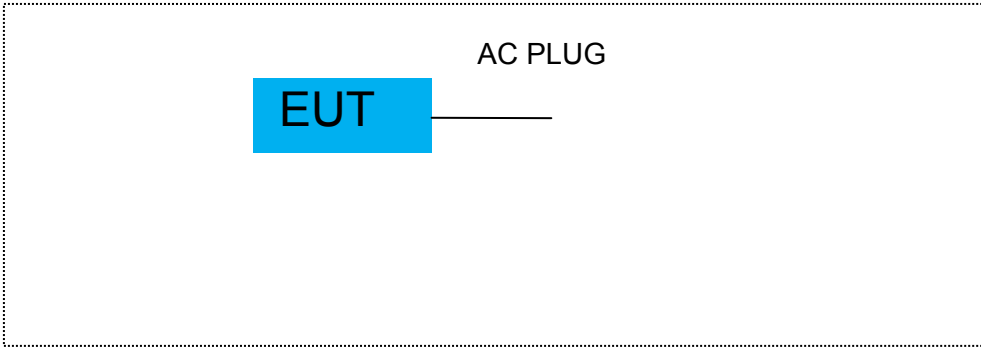

For Radiated Test Cases



For Conducted Test Cases

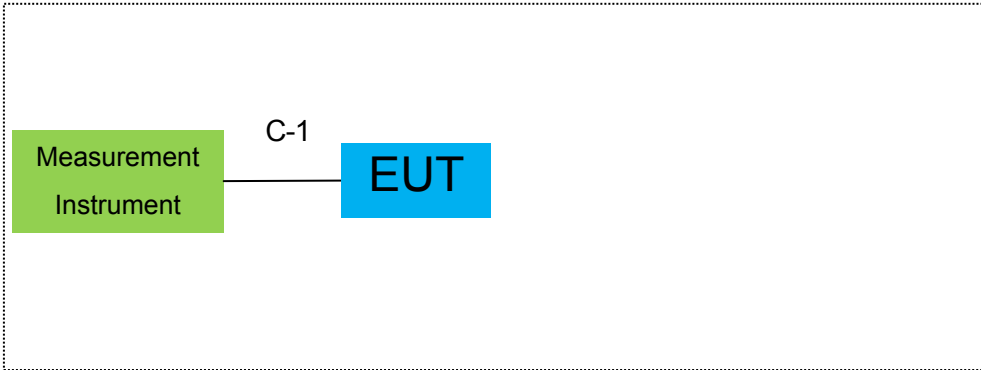

Note:1.The temporary antenna connector is soldered on the PCB board in order to perform conducted tests and this temporary antenna connector is listed in the equipment list.
2.EUT built-in battery-powered, the battery is fully-charged.

2.4 DESCRIPTION OF SUPPORT UNITS(CONDUCTED MODE)

The EUT has been tested as an independent unit together with other necessary accessories or support units. The following support units or accessories were used to form a representative test configuration during the tests.

Item	Equipment	Brand	Model/Type No.	Series No.	Note

Item	Cable Type	Shielded Type	Ferrite Core	Length	Note
C-1	RF Cable	YES	NO	0.1m	

Note:

- (1) The support equipment was authorized by Declaration of Confirmation.
- (2) For detachable type I/O cable should be specified the length in cm in 『Length』 column.

2.5 EQUIPMENTS LIST FOR ALL TEST ITEMS

Radiation& Conducted Test equipment

Item	Kind of Equipment	Manufacturer	Type No.	Serial No.	Last calibration	Calibrated until	Calibration period
1	Spectrum Analyzer	Agilent	E4407B	MY45108040	2018.05.19	2019.05.18	1 year
2	Spectrum Analyzer	Agilent	N9020A	MY49100060	2018.10.08	2019.10.07	1 year
3	Spectrum Analyzer	R&S	FSV40	101417	2018.10.08	2019.10.07	1 year
4	Test Receiver	R&S	ESPI7	101318	2018.05.19	2019.05.18	1 year
5	Bilog Antenna	TESEQ	CBL6111D	31216	2019.04.15	2020.04.14	1 year
6	50Ω Coaxial Switch	Anritsu	MP59B	6200983705	2018.05.19	2020.05.18	2 year
7	Horn Antenna	EM	EM-AH-10180	2011071402	2019.04.15	2020.04.14	1 year
8	Broadband Horn Antenna	SCHWARZBECK	BBHA 9170	803	2018.12.11	2019.12.10	1 year
9	Amplifier	EMC	EMC051835SE	980246	2018.08.05	2019.08.04	1 year
10	Active Loop Antenna	SCHWARZBECK	FMZB 1519B	055	2018.12.11	2019.12.10	1 year
11	Power Meter	DARE	RPR3006W	15100041SN084	2018.08.05	2019.08.04	1 year
12	Test Cable (9KHz-30MHz)	N/A	R-01	N/A	2017.04.21	2020.04.20	3 year
13	Test Cable (30MHz-1GHz)	N/A	R-02	N/A	2017.04.21	2020.04.20	3 year
14	High Test Cable(1G-40G Hz)	N/A	R-03	N/A	2017.04.21	2020.04.20	3 year
15	High Test Cable(1G-40G Hz)	N/A	R-04	N/A	2017.04.21	2020.04.20	3 year
16	Filter	TRILTHIC	2400MHz	29	2017.04.19	2020.04.18	3 year
17	temporary antenna connector (Note)	NTS	R001	N/A	N/A	N/A	N/A

Note:

We will use the temporary antenna connector (soldered on the PCB board) When conducted test
 And this temporary antenna connector is listed within the instrument list

AC Conduction Test equipment

Item	Kind of Equipment	Manufacturer	Type No.	Serial No.	Last calibration	Calibrated until	Calibration period
1	Test Receiver	R&S	ESCI	101160	2018.05.19	2019.05.18	1 year
2	LISN	R&S	ENV216	101313	2019.04.15	2020.04.14	1 year
3	LISN	SCHWARZBECK	NNLK 8129	8129245	2018.05.19	2019.05.18	1 year
4	50Ω Coaxial Switch	ANRITSU CORP	MP59B	6200983704	2018.05.19	2020.05.18	2 year
5	Test Cable (9KHz-30MHz)	N/A	C01	N/A	2017.04.21	2020.04.20	3 year
6	Test Cable (9KHz-30MHz)	N/A	C02	N/A	2017.04.21	2020.04.20	3 year
7	Test Cable (9KHz-30MHz)	N/A	C03	N/A	2017.04.21	2020.04.20	3 year

Note: Each piece of equipment is scheduled for calibration once a year except the Test Cable& Aux Equipment which is scheduled for calibration every 3 years.

3. EMC EMISSION TEST

3.1 CONDUCTED EMISSION MEASUREMENT

3.1.1 APPLICABLE STANDARD

According to FCC Part 15.207(a)

3.1.2 CONFORMANCE LIMIT

Frequency(MHz)	Conducted Emission Limit	
	Quasi-peak	Average
0.15-0.5	66-56*	56-46*
0.5-5.0	56	46
5.0-30.0	60	50

Note: 1. *Decreases with the logarithm of the frequency
 2. The lower limit shall apply at the transition frequencies
 3. The limit decreases in line with the logarithm of the frequency in the range of 0.15 to 0.50MHz.

3.1.3 TEST CONFIGURATION

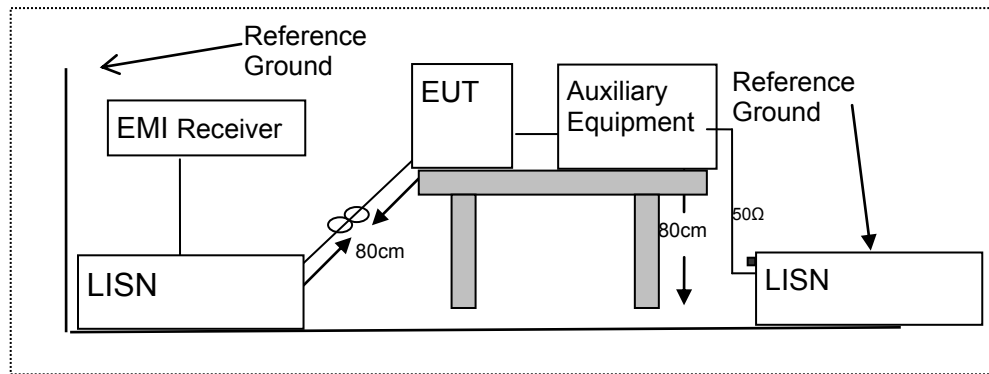

3.1.4 TEST PROCEDURE

According to the requirements in Section 13.1.4.1 of ANSI C63.10-2013 Conducted emissions the EUT measured in the frequency range between 0.15 MHz and 30 MHz using CISPR Quasi-Peak and average detector mode.

1. The EUT was placed 0.4 meter from the conducting wall of the shielding room.
2. The EUT was placed on a table which is 0.8m above ground plane.
3. Connect EUT to the power mains through a line impedance stabilization network (LISN). All other support equipments powered from additional LISN(s). The LISN provide 50 Ohm/ 50uH of coupling impedance for the measuring instrument.
4. Interconnecting cables that hang closer than 40 cm to the ground plane shall be folded back and forth in the center forming a bundle 30 to 40cm long.
5. I/O cables that are not connected to a peripheral shall be bundled in the center. The end of the cable may be terminated, if required, using the correct terminating impedance. The overall length shall not exceed 1 m.
6. LISN at least 80 cm from nearest part of EUT chassis.
7. The frequency range from 150KHz to 30MHz was searched.
8. Set the test-receiver system to Peak Detect Function and specified bandwidth(IF bandwidth=9KHz) with Maximum Hold Mode
9. For the actual test configuration, please refer to the related Item –EUT Test Photos.

EUT :	Mobile Phone	Model Name. :	GQ3081
Temperature :	26 °C	Relative Humidity :	56%
Pressure :	1010hPa	Phase :	L
Test Voltage :	DC 5V from Adapter AC 120V/60Hz	Test Mode :	Mode 1

Frequency (MHz)	Reading Level (dBμV)	Correct Factor (dB)	Measure-ment (dBμV)	Limits (dBμV)	Margin (dB)	Remark
0.1700	46.55	9.76	56.31	64.96	-8.65	QP
0.1700	20.05	9.76	29.81	54.96	-25.15	AVG
0.7140	36.12	9.74	45.86	56.00	-10.14	QP
0.7140	24.74	9.74	34.48	46.00	-11.52	AVG
13.6260	41.77	10.07	51.84	60.00	-8.16	QP
13.6260	26.45	10.07	36.52	50.00	-13.48	AVG

Remark:

1. All readings are Quasi-Peak and Average values.
2. Factor = Insertion Loss + Cable Loss.

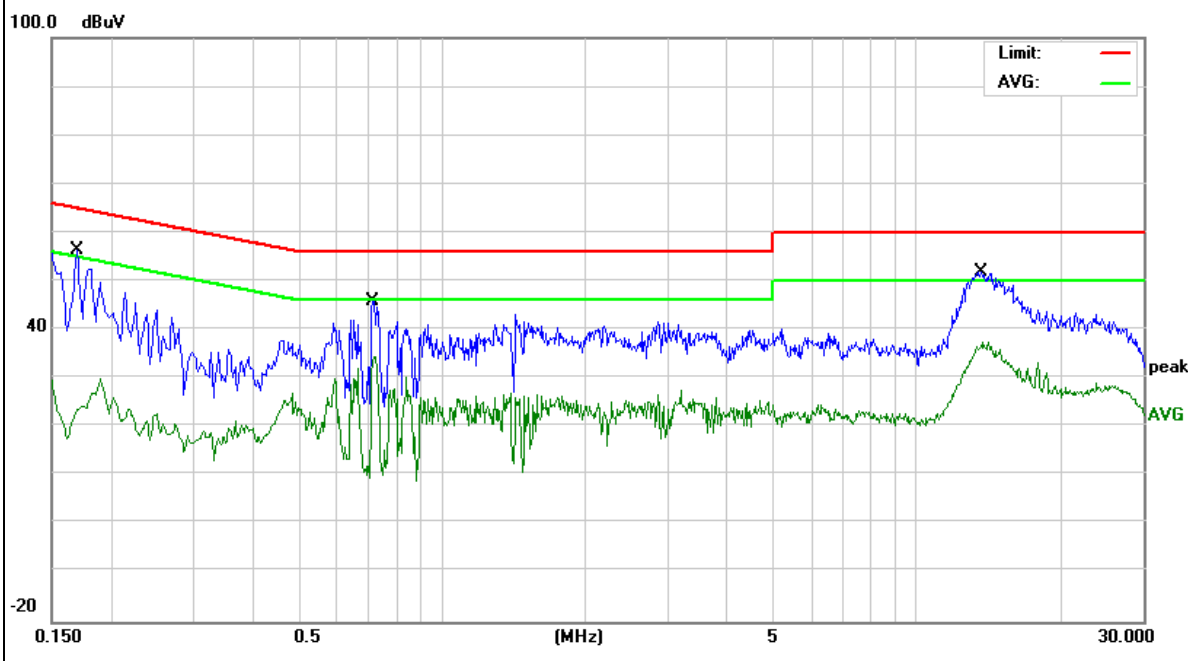

EUT :	Mobile Phone	Model Name. :	GQ3081
Temperature :	26 °C	Relative Humidity :	56%
Pressure :	1010hPa	Phase :	N
Test Voltage :	DC 5V from Adapter AC 120V/60Hz	Test Mode :	Mode 1

Frequency (MHz)	Reading Level (dBμV)	Correct Factor (dB)	Measurement (dBμV)	Limits (dBμV)	Margin (dB)	Remark
0.1620	47.44	9.73	57.17	65.36	-8.19	QP
0.1620	19.36	9.73	29.09	55.36	-26.27	AVG
0.7140	32.12	9.75	41.87	56.00	-14.13	QP
0.7140	24.19	9.75	33.94	46.00	-12.06	AVG
13.3220	39.31	10.07	49.38	60.00	-10.62	QP
13.3220	26.49	10.07	36.56	50.00	-13.44	AVG

Remark:

1. All readings are Quasi-Peak and Average values.
2. Factor = Insertion Loss + Cable Loss.

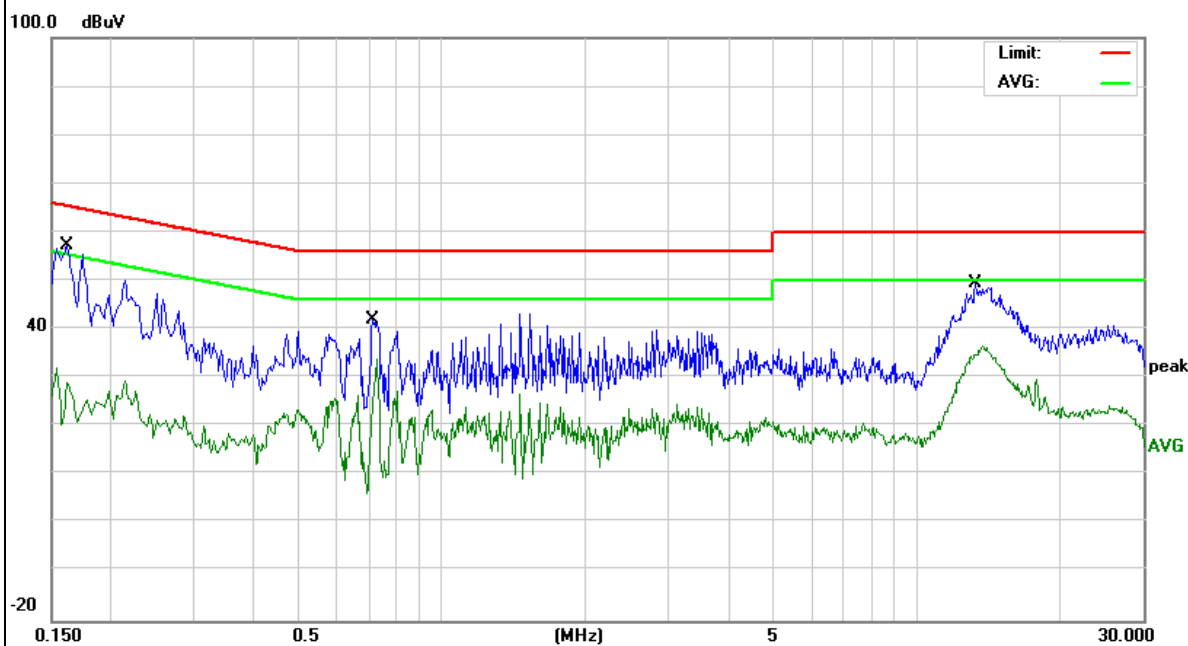

EUT :	Mobile Phone	Model Name. :	GQ3081
Temperature :	26 °C	Relative Humidity :	56%
Pressure :	1010hPa	Phase :	L
Test Voltage :	DC 5V from Adapter AC 240V/60Hz	Test Mode :	Mode 1

Frequency (MHz)	Reading Level (dBμV)	Correct Factor (dB)	Measurement (dBμV)	Limits (dBμV)	Margin (dB)	Remark
0.7220	39.19	9.74	48.93	56.00	-7.07	QP
0.7220	33.17	9.74	42.91	46.00	-3.09	AVG
1.4380	34.55	9.76	44.31	56.00	-11.69	QP
1.4380	27.89	9.76	37.65	46.00	-8.35	AVG
14.9460	45.13	10.10	55.23	60.00	-4.77	QP
14.9460	32.41	10.10	42.51	50.00	-7.49	AVG

Remark:

1. All readings are Quasi-Peak and Average values.
2. Factor = Insertion Loss + Cable Loss.

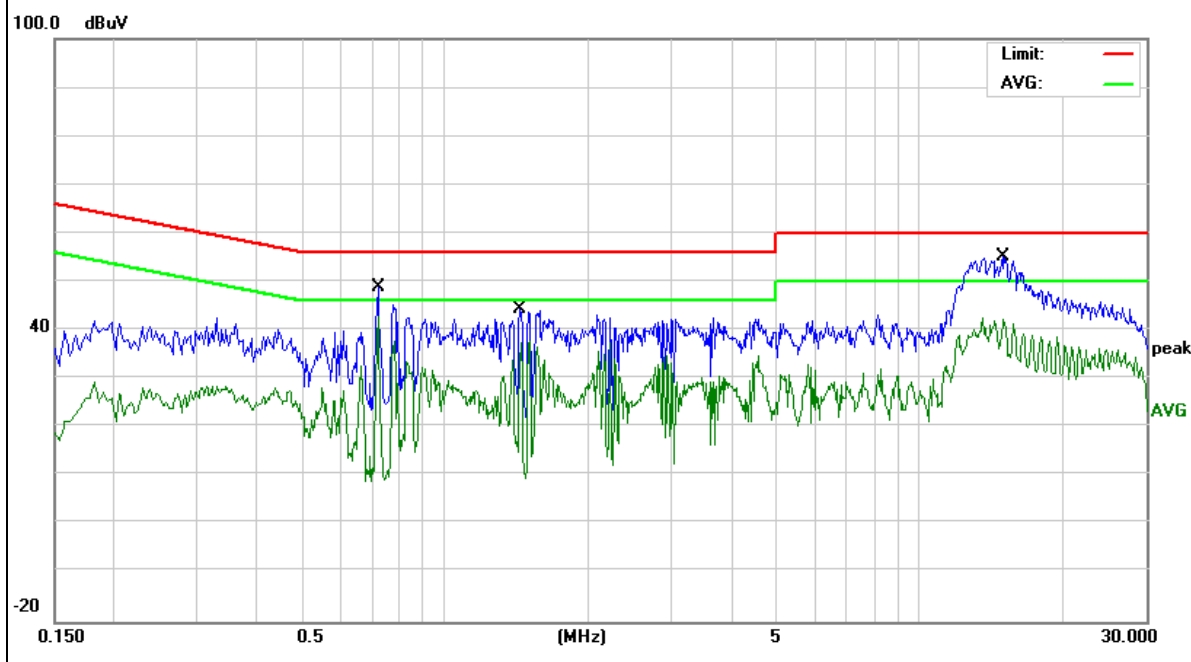

EUT :	Mobile Phone	Model Name. :	GQ3081
Temperature :	26 °C	Relative Humidity :	56%
Pressure :	1010hPa	Phase :	N
Test Voltage :	DC 5V from Adapter AC 240V/60Hz	Test Mode :	Mode 1

Frequency (MHz)	Reading Level (dBμV)	Correct Factor (dB)	Measurement (dBμV)	Limits (dBμV)	Margin (dB)	Remark
0.7780	34.88	9.75	44.63	56.00	-11.37	QP
0.7780	27.41	9.75	37.16	46.00	-8.84	AVG
1.3860	34.98	9.76	44.74	56.00	-11.26	QP
1.3860	21.60	9.76	31.36	46.00	-14.64	AVG
12.9540	45.50	10.07	55.57	60.00	-4.43	QP
12.9540	33.95	10.07	44.02	50.00	-5.98	AVG

Remark:

1. All readings are Quasi-Peak and Average values.
2. Factor = Insertion Loss + Cable Loss.

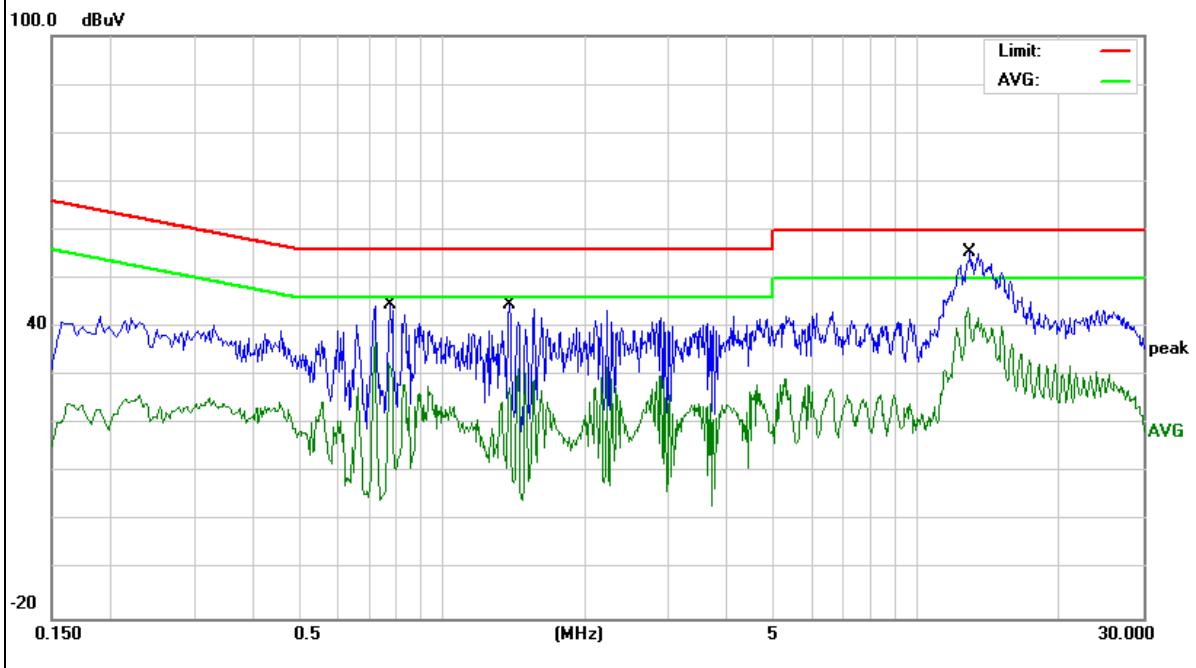

3.2 RADIATED EMISSION MEASUREMENT

3.2.1 APPLICABLE STANDARD

According to FCC Part 15.407(d) and 15.209

3.2.2 CONFORMANCE LIMIT

According to FCC Part 15.407(b)(7): radiated emissions which fall in the restricted bands, as defined in §15.205(a), must also comply with the radiated emission limits specified in §15.209(a) (see §15.205(c)).
According to FCC Part 15.205, Restricted bands

MHz	MHz	MHz	GHz
0.090-0.110	16.42-16.423	399.9-410	4.5-5.15
10.495-0.505	16.69475-16.69525	608-614	5.35-5.46
2.1735-2.1905	16.80425-16.80475	960-1240	7.25-7.75
4.125-4.128	25.5-25.67	1300-1427	8.025-8.5
4.17725-4.17775	37.5-38.25	1435-1626.5	9.0-9.2
4.20725-4.20775	73-74.6	1645.5-1646.5	9.3-9.5
6.215-6.218	74.8-75.2	1660-1710	10.6-12.7
6.26775-6.26825	123-138	2200-2300	14.47-14.5
8.291-8.294	149.9-150.05	2310-2390	15.35-16.2
8.362-8.366	156.52475-156.52525	2483.5-2500	17.7-21.4
8.37625-8.38675	156.7-156.9	2690-2900	22.01-23.12
8.41425-8.41475	162.0125-167.17	3260-3267	23.6-24.0
12.29-12.293	167.72-173.2	3332-3339	31.2-31.8
12.51975-12.52025	240-285	3345.8-3358	36.43-36.5
12.57675-12.57725	322-335.4	3600-4400	(2)
13.36-13.41			

20dBc in any 100 kHz bandwidth outside the operating frequency band. In case the emission fall within the restricted band specified on 15.205(a), then the 15.209(a) limit in the table below has to be followed.

Restricted Frequency(MHz)	Field Strength (µV/m)	Field Strength (dBµV/m)	Measurement Distance
0.009~0.490	2400/F(KHz)	20 log (uV/m)	300
0.490~1.705	24000/F(KHz)	20 log (uV/m)	30
1.705~30.0	30	29.5	30
30-88	100	40	3
88-216	150	43.5	3
216-960	200	46	3
Above 960	500	54	3

Limits of Radiated Emission Measurement(Above 1000MHz)

Frequency(MHz)	Class B (dBuV/m) (at 3M)	
	PEAK	AVERAGE
Above 1000	74	54

- Remark : 1. Emission level in dBuV/m=20 log (uV/m)
 2. Measurement was performed at an antenna to the closed point of EUT distance of meters.
 3. For Frequency 9kHz~30MHz:
 Distance extrapolation factor =40log(Specific distance/ test distance)(dB);
 Limit line=Specific limits(dBuV) + distance extrapolation factor.
 For Frequency above 30MHz:
 Distance extrapolation factor =20log(Specific distance/ test distance)(dB);
 Limit line=Specific limits(dBuV) + distance extrapolation factor.

3.2.3 MEASURING INSTRUMENTS

The Measuring equipment is listed in the section 6.3 of this test report.

3.2.4 TEST CONFIGURATION

(a) For radiated emissions below 30MHz

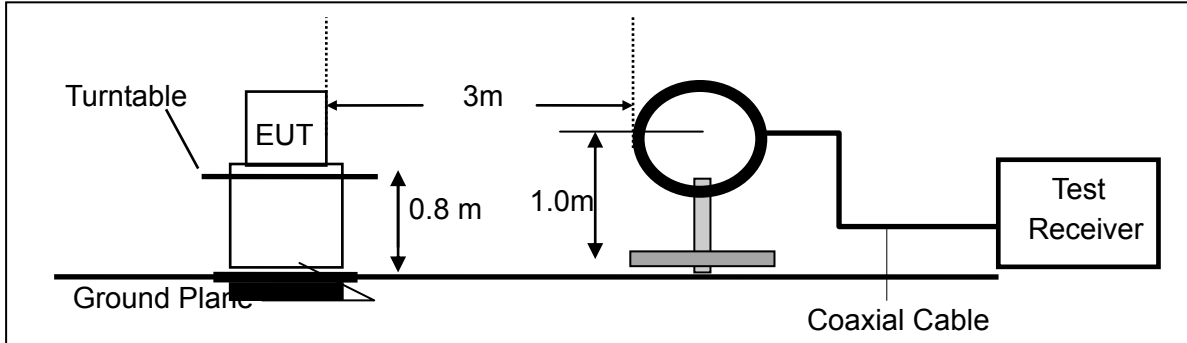

(b) For radiated emissions from 30MHz to 1000MHz

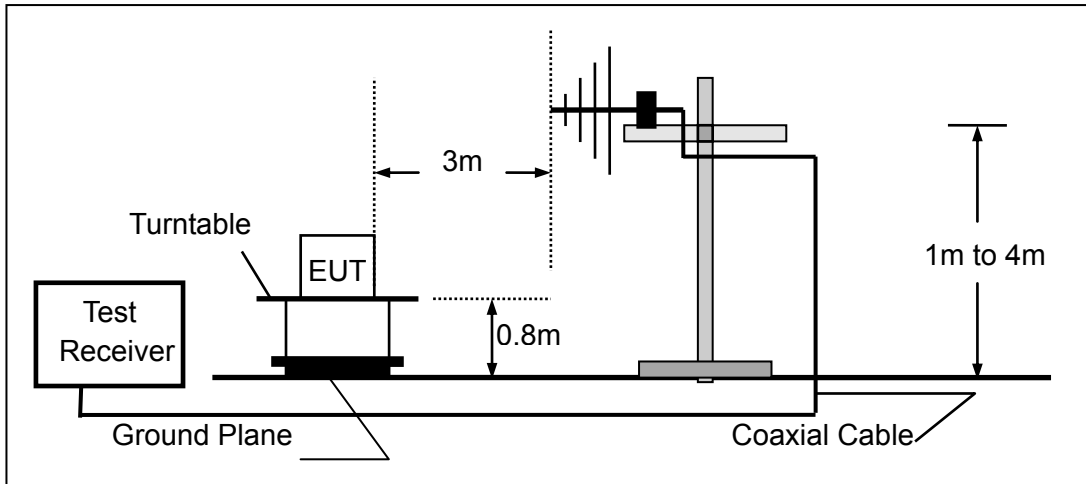

(c) For radiated emissions above 1000MHz

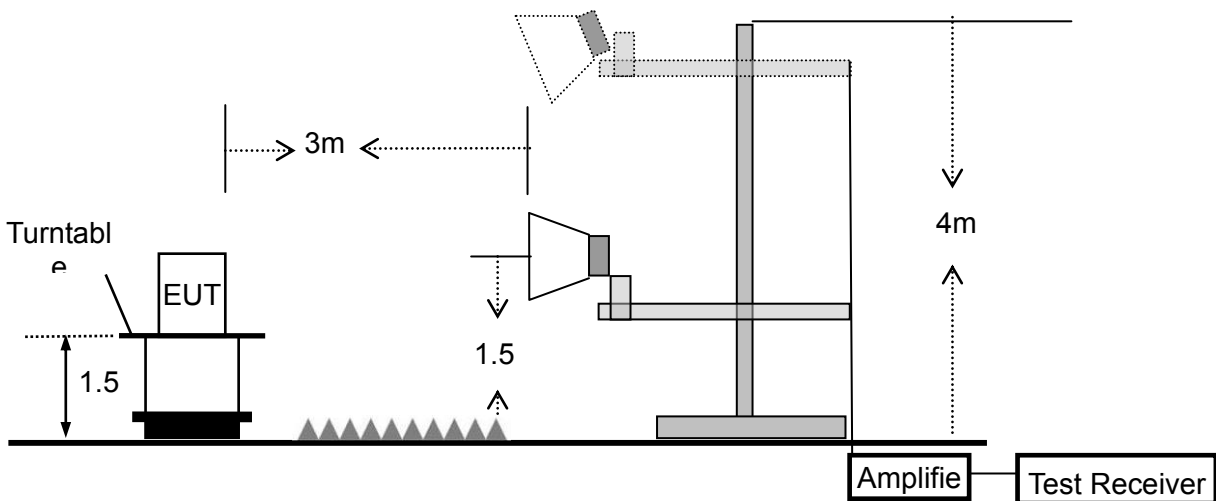

3.2.5 TEST PROCEDURE

The test site semi-anechoic chamber has met the requirement of NSA tolerance 4 dB according to the standards: ANSI C63.10-2013. The test distance is 3m. The setup is according to the requirements in Section 13.1.4.1 of ANSI C63.10-2013 and CAN/CSA-CEI/IEC CISPR 22.

This test is required for any spurious emission that falls in a Restricted Band, as defined in Section 15.205. It must be performed with the highest gain of each type of antenna proposed for use with the EUT.

Use the following spectrum analyzer settings:

Spectrum Parameter	Setting
Attenuation	Auto
Start Frequency	1000 MHz
Stop Frequency	10th carrier harmonic
RB / VB (emission in restricted band)	1 MHz / 1 MHz for Peak, 1 MHz / 10Hz for Average

Receiver Parameter	Setting
Attenuation	Auto
Start ~ Stop Frequency	9kHz~150kHz / RB 200Hz for QP
Start ~ Stop Frequency	150kHz~30MHz / RB 9kHz for QP
Start ~ Stop Frequency	30MHz~1000MHz / RB 120kHz for QP

- The measuring distance of at 3 m shall be used for measurements at frequency up to 1GHz. For frequencies above 1GHz, any suitable measuring distance may be used.
- The EUT was placed on the top of a rotating table 0.8 m for below 1GHz and 1.5m for above 1GHz the ground at a 3 meter. The table was rotated 360 degrees to determine the position of the highest radiation.
- The height of the equipment or of the substitution antenna shall be 0.8 m for below 1GHz and 1.5m for above 1GHz; the height of the test antenna shall vary between 1 m to 4 m. Both horizontal and vertical polarizations of the antenna are set to make the measurement.
- The initial step in collecting conducted emission data is a spectrum analyzer peak detector mode pre-scanning the measurement frequency range. Significant peaks are then marked and then Quasi Peak detector mode re-measured.
- If the Peak Mode measured value compliance with and lower than Quasi Peak Mode Limit, the EUT shall be deemed to meet QP Limits and then no additional QP Mode measurement performed.
- For the actual test configuration, please refer to the related Item –EUT Test Photos.

Note:

Both horizontal and vertical antenna polarities were tested and performed pretest to three orthogonal axis. The worst case emissions were reported

During the radiated emission test, the Spectrum Analyzer was set with the following configurations:

Frequency Band (MHz)	Function	Resolution bandwidth	Video Bandwidth
30 to 1000	QP	120 kHz	300 kHz
Above 1000	Peak	1 MHz	1 MHz
	Average	1 MHz	10 Hz

Note: for the frequency ranges below 30 MHz, a narrower RBW is used for these ranges but the measured value should add a RBW correction factor (RBWCF) where $RBWCF [dB] = 10 \cdot \lg(100 [kHz] / \text{narrower RBW [kHz]})$. , the narrower RBW is 1 kHz and RBWCF is 20 dB for the frequency 9 kHz to 150 kHz, and the narrower RBW is 10 kHz and RBWCF is 10 dB for the frequency 150 kHz to 30 MHz.

3.2.6 TEST RESULTS (9KHZ – 30 MHZ)

EUT:	Mobile Phone	Model Name. :	GQ3081
Temperature:	20 °C	Relative Humidity:	48%
Pressure:	1010 hPa	Test Voltage :	DC 3.85V
Test Mode :	TX	Polarization :	--

Freq. (MHz)	Reading (dBuV/m)	Limit (dBuV/m)	Margin (dB)	State P/F
--	--	--	--	N/A
--	--	--	--	N/A

NOTE:

The amplitude of spurious emissions which are attenuated by more than 20dB below the permissible value has no need to be reported.

3.2.7 TEST RESULTS (30MHZ – 1GHZ)

EUT :	Mobile Phone	Model Name. :	GQ3081
Temperature :	20 °C	Relative Humidity :	48%
Pressure :	1010 hPa	Test Voltage :	DC 3.85V
Test Mode :	TX(5.2G)- 802.11n20 (High CH)		

Polar (H/V)	Frequency	Meter Reading	Factor	Emission Level	Limits	Margin	Remark
	(MHz)	(dBuV)	(dB)	(dBuV/m)	(dBuV/m)	(dB)	
V	32.9791	17.29	17.66	34.95	40.00	-5.05	QP
V	49.1865	25.87	10.07	35.94	40.00	-4.06	QP
V	58.8185	25.64	6.64	32.28	40.00	-7.72	QP
V	173.2050	21.43	11.00	32.43	43.50	-11.07	QP
V	435.5898	12.57	20.18	32.75	46.00	-13.25	QP

Remark:

Absolute Level= ReadingLevel+ Factor, Margin= Absolute Level - Limit

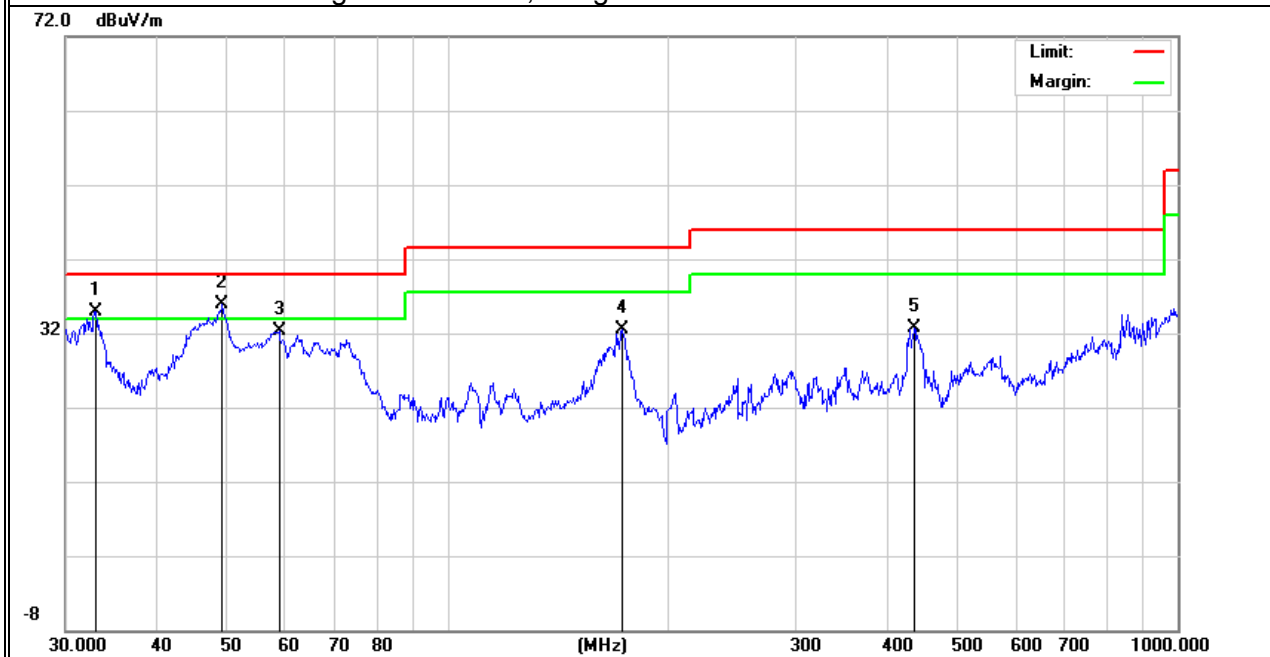

Polar (H/V)	Frequency	Meter Reading	Factor	Emission Level	Limits	Margin	Remark
	(MHz)	(dBuV)	(dB)	(dBuV/m)	(dBuV/m)	(dB)	
H	32.0667	5.99	18.16	24.15	40.00	-15.85	QP
H	48.1625	11.45	11.16	22.61	40.00	-17.39	QP
H	79.5207	14.68	8.62	23.30	40.00	-16.70	QP
H	157.5586	18.10	12.03	30.13	43.50	-13.37	QP
H	319.9370	19.18	16.51	35.69	46.00	-10.31	QP

Remark:

Absolute Level= ReadingLevel+ Factor, Margin= Absolute Level - Limit

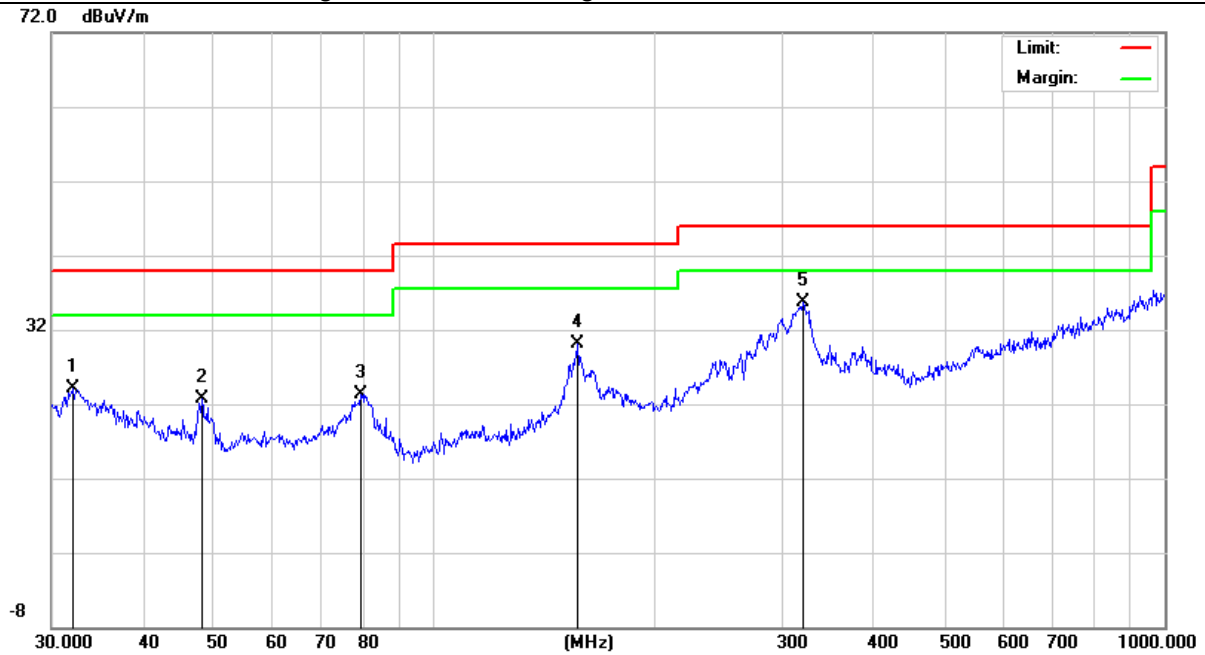

EUT :	Mobile Phone	Model Name. :	GQ3081
Temperature :	20 °C	Relative Humidity :	48%
Pressure :	1010 hPa	Test Voltage :	DC 3.85V
Test Mode :	TX(5.8G) - 802.11a (High CH)		

Polar (H/V)	Frequency	Meter Reading	Factor	Emission Level	Limits	Margin	Remark
	(MHz)	(dBuV)	(dB)	(dBuV/m)	(dBuV/m)	(dB)	
V	35.0048	16.25	16.72	32.97	40.00	-7.03	QP
V	52.9453	25.76	7.77	33.53	40.00	-6.47	QP
V	74.6568	25.72	7.84	33.56	40.00	-6.44	QP
V	195.8220	22.90	9.81	32.71	43.50	-10.79	QP
V	386.6338	13.54	18.87	32.41	46.00	-13.59	QP

Remark:

Absolute Level= ReadingLevel+ Factor, Margin= Absolute Level - Limit

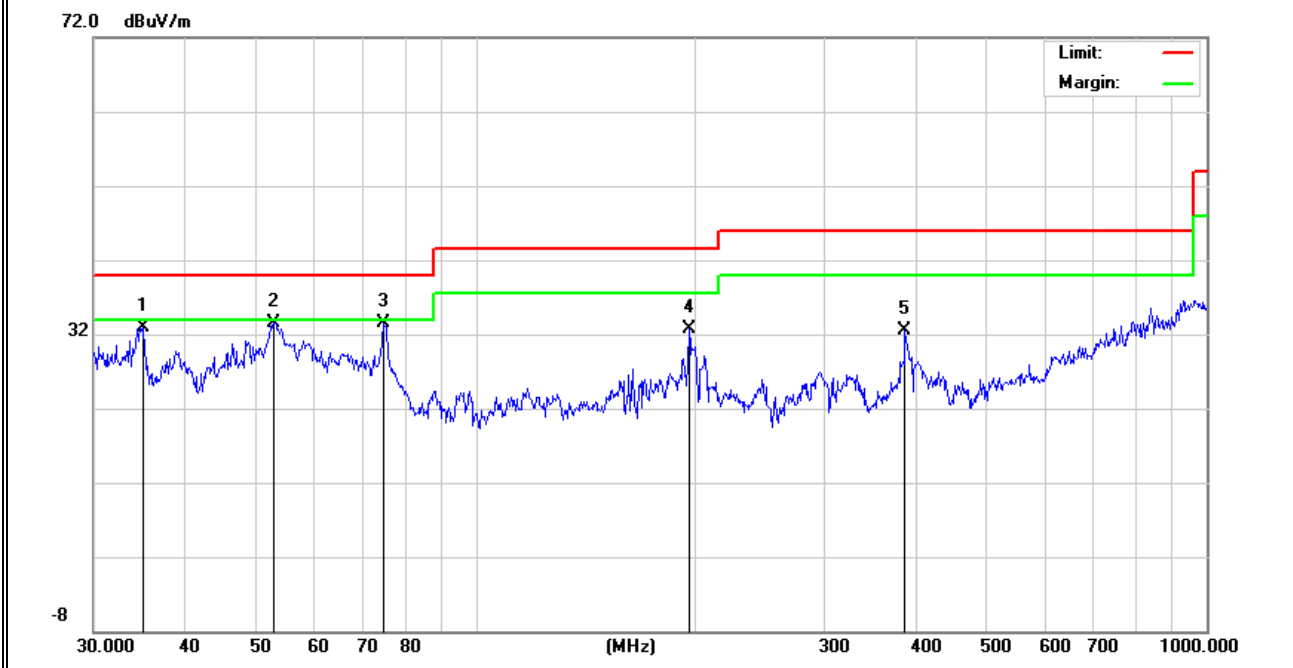

Polar (H/V)	Frequency	Meter Reading	Factor	Emission Level	Limits	Margin	Remark
	(MHz)	(dBuV)	(dB)	(dBuV/m)	(dBuV/m)	(dB)	
H	36.8952	9.53	15.84	25.37	40.00	-14.63	QP
H	52.9453	16.11	7.77	23.88	40.00	-16.12	QP
H	77.8653	13.12	8.26	21.38	40.00	-18.62	QP
H	157.5586	17.60	12.03	29.63	43.50	-13.87	QP
H	348.0274	21.33	17.58	38.91	46.00	-7.09	QP

Remark:

Absolute Level= ReadingLevel+ Factor, Margin= Absolute Level - Limit

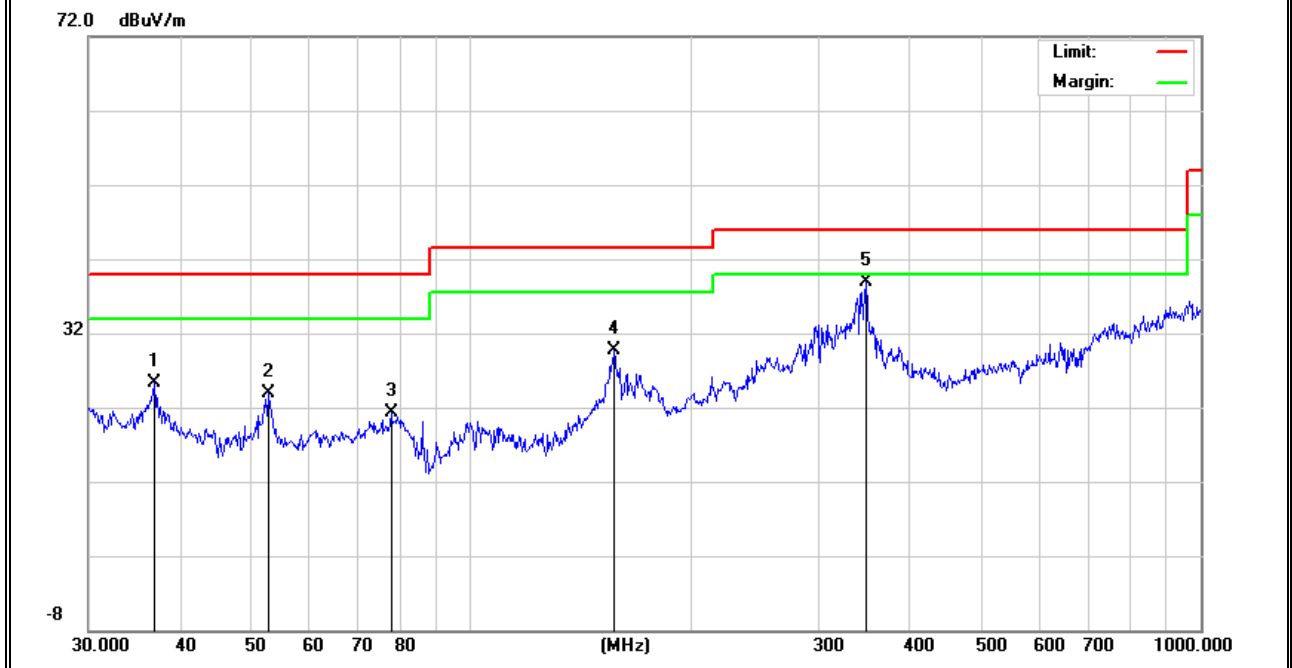

3.2.8 TEST RESULTS (1GHz-18GHz)

EUT :	Mobile Phone	Model Name. :	GQ3081
Temperature :	20 °C	Relative Humidity :	48%
Pressure :	1010 hPa	Test Voltage :	DC 3.85V
Test Mode :	TX(5.2G) - 802.11n20_5180~5240MHz		

Polar	Frequency	Meter Reading	Cable loss	Antenna Factor	Preamp Factor	Emission Level	Limits	Margin	Detector Type
(H/V)	(MHz)	(dBuV)	(dB)	dB/m	(dB)	(dBuV/m)	(dBuV/m)	(dB)	
Low Channel (5180 MHz)-Above 1G									
Vertical	3015.42	63.16	5.94	35.40	44.00	60.50	74.00	-13.50	Pk
Vertical	3015.42	47.45	5.94	35.40	44.00	44.79	54.00	-9.21	AV
Vertical	10360.00	63.05	8.46	39.75	44.50	66.76	74.00	-7.24	Pk
Vertical	10360.00	43.80	8.46	39.75	44.50	47.51	54.00	-6.49	AV
Vertical	15540.00	60.63	10.12	38.80	44.10	65.45	74.00	-8.55	Pk
Vertical	15540.00	40.55	10.12	38.80	42.70	46.77	54.00	-7.23	AV
Horizontal	2981.44	63.32	5.94	35.18	44.00	60.44	74.00	-13.56	Pk
Horizontal	2981.44	42.62	5.94	35.18	44.00	39.74	54.00	-14.26	AV
Horizontal	10360.00	59.24	8.46	38.71	44.50	61.91	74.00	-12.09	Pk
Horizontal	10360.00	41.14	8.46	38.71	44.50	43.81	54.00	-10.19	AV
Horizontal	15540.00	57.23	10.12	38.38	44.10	61.63	74.00	-12.37	Pk
Horizontal	15540.00	40.80	10.12	38.38	44.10	45.20	54.00	-8.80	AV
middle Channel (5200 MHz)-Above 1G									
Vertical	3561.07	63.61	6.48	36.35	44.05	62.39	74.00	-11.61	Pk
Vertical	3561.07	43.16	6.48	36.35	44.05	41.94	54.00	-12.06	AV
Vertical	10400.00	63.20	8.47	37.88	44.51	65.04	74.00	-8.96	Pk
Vertical	10400.00	43.61	8.47	37.88	44.51	45.45	54.00	-8.55	AV
Vertical	15600.00	58.32	10.12	38.80	44.10	63.14	74.00	-10.86	Pk
Vertical	15600.00	39.27	10.12	38.80	42.70	45.49	54.00	-8.51	AV
Horizontal	3362.97	63.02	6.48	36.37	44.05	61.82	74.00	-12.18	Pk
Horizontal	3362.97	44.91	6.48	36.37	44.05	43.71	54.00	-10.29	AV
Horizontal	10400.00	59.51	8.47	38.64	44.50	62.12	74.00	-11.88	Pk
Horizontal	10400.00	43.14	8.47	38.64	44.50	45.75	54.00	-8.25	AV
Horizontal	15600.00	59.52	10.12	38.38	44.10	63.92	74.00	-10.08	Pk
Horizontal	15600.00	43.08	10.12	38.38	44.10	47.48	54.00	-6.52	AV
High Channel (5240 MHz)-Above 1G									
Vertical	3926.13	61.65	7.10	37.24	43.50	62.49	74.00	-11.51	Pk
Vertical	3926.13	44.80	7.10	37.24	43.50	45.64	54.00	-8.36	AV
Vertical	10480.00	63.23	8.46	37.68	44.50	64.87	74.00	-9.13	Pk
Vertical	10480.00	41.50	8.46	37.68	44.50	43.14	54.00	-10.86	AV
Vertical	15720.00	59.23	10.12	38.80	44.10	64.05	74.00	-9.95	Pk
Vertical	15720.00	38.17	10.12	38.80	42.70	44.39	54.00	-9.61	AV
Horizontal	3884.53	63.87	7.10	37.24	43.50	64.71	74.00	-9.29	Pk
Horizontal	3884.53	42.67	7.10	37.24	43.50	43.51	54.00	-10.49	AV
Horizontal	10480.00	59.38	8.46	38.57	44.50	61.91	74.00	-12.09	Pk
Horizontal	10480.00	41.37	8.46	38.57	44.50	43.90	54.00	-10.10	AV
Horizontal	15720.00	61.52	10.12	38.38	44.10	65.92	74.00	-8.08	Pk
Horizontal	15720.00	40.59	10.12	38.38	44.10	44.99	54.00	-9.01	AV

Note:"802.11n20(5G)" mode is the worst mode. PK value is lower than the Average value limit, So average didn't record.

The amplitude of spurious emissions that are attenuated by more than 20dB below the permissible value has no need to be reported.

Emission level (dBuV/m) = 20 log Emission level (uV/m).

Corrected Reading: Antenna Factor + Cable Loss + Read Level - Preamp Factor = Level

EUT :	Mobile Phone	Model Name. :	GQ3081
Temperature :	20 °C	Relative Humidity :	48%
Pressure :	1010 hPa	Test Voltage :	DC 3.85V
Test Mode :	TX (5.8G) -- 802.11a_5745~5825MHz		

Polar	Frequency	Meter Reading	Cable loss	Antenna Factor	Preamp Factor	Emission Level	Limits	Margin	Detector Type
(H/V)	(MHz)	(dBuV)	(dB)	dB/m	(dB)	(dBuV/m)	(dBuV/m)	(dB)	
Low Channel (5745 MHz)-Above 1G									
Vertical	2806.34	64.76	5.94	35.40	44.00	62.10	74.00	-11.90	Pk
Vertical	2806.34	45.80	5.94	35.40	44.00	43.14	54.00	-10.86	AV
Vertical	11490.00	63.07	8.46	39.75	44.50	66.78	74.00	-7.22	Pk
Vertical	11490.00	43.73	8.46	39.75	44.50	47.44	54.00	-6.56	AV
Vertical	17235.00	59.17	10.12	38.80	44.10	63.99	74.00	-10.01	Pk
Vertical	17235.00	40.24	10.12	38.80	42.70	46.46	54.00	-7.54	AV
Horizontal	2911.17	65.03	5.94	35.18	44.00	62.15	74.00	-11.85	Pk
Horizontal	2911.17	46.73	5.94	35.18	44.00	43.85	54.00	-10.15	AV
Horizontal	11490.00	62.85	8.46	38.71	44.50	65.52	74.00	-8.48	Pk
Horizontal	11490.00	40.53	8.46	38.71	44.50	43.20	54.00	-10.80	AV
Horizontal	17235.00	60.43	10.12	38.38	44.10	64.83	74.00	-9.17	Pk
Horizontal	17235.00	42.84	10.12	38.38	44.10	47.24	54.00	-6.76	AV
middle Channel (5785 MHz)-Above 1G									
Vertical	3762.52	63.84	6.48	36.35	44.05	62.62	74.00	-11.38	Pk
Vertical	3762.52	42.81	6.48	36.35	44.05	41.59	54.00	-12.41	AV
Vertical	11570.00	63.58	8.47	37.88	44.51	65.42	74.00	-8.58	Pk
Vertical	11570.00	45.32	8.47	37.88	44.51	47.16	54.00	-6.84	AV
Vertical	17355.00	63.48	10.12	38.80	44.10	68.30	74.00	-5.70	Pk
Vertical	17355.00	42.87	10.12	38.80	42.70	49.09	54.00	-4.91	AV
Horizontal	3561.03	61.75	6.48	36.37	44.05	60.55	74.00	-13.45	Pk
Horizontal	3561.03	43.95	6.48	36.37	44.05	42.75	54.00	-11.25	AV
Horizontal	11570.00	60.60	8.47	38.64	44.50	63.21	74.00	-10.79	Pk
Horizontal	11570.00	43.55	8.47	38.64	44.50	46.16	54.00	-7.84	AV
Horizontal	17355.00	63.25	10.12	38.38	44.10	67.65	74.00	-6.35	Pk
Horizontal	17355.00	43.90	10.12	38.38	44.10	48.30	54.00	-5.70	AV
High Channel (5825 MHz)-Above 1G									
Vertical	3906.63	61.23	7.10	37.24	43.50	62.07	74.00	-11.93	Pk
Vertical	3906.63	43.02	7.10	37.24	43.50	43.86	54.00	-10.14	AV
Vertical	11650.00	61.02	8.46	37.68	44.50	62.66	74.00	-11.34	Pk
Vertical	11650.00	43.67	8.46	37.68	44.50	45.31	54.00	-8.69	AV
Vertical	17475.00	59.81	10.12	38.80	44.10	64.63	74.00	-9.37	Pk
Vertical	17475.00	40.12	10.12	38.80	42.70	46.34	54.00	-7.66	AV
Horizontal	3912.24	61.69	7.10	37.24	43.50	62.53	74.00	-11.47	Pk
Horizontal	3912.24	42.77	7.10	37.24	43.50	43.61	54.00	-10.39	AV
Horizontal	11650.00	63.00	8.46	38.57	44.50	65.53	74.00	-8.47	Pk
Horizontal	11650.00	43.51	8.46	38.57	44.50	46.04	54.00	-7.96	AV
Horizontal	17475.00	60.72	10.12	38.38	44.10	65.12	74.00	-8.88	Pk
Horizontal	17475.00	44.65	10.12	38.38	44.10	49.05	54.00	-4.95	AV

Note:"802.11a(5G)" mode is the worst mode. PK value is lower than the Average value limit, So average didn't record.

The amplitude of spurious emissions that are attenuated by more than 20dB below the permissible value has no need to be reported.

Emission level (dBuV/m) = 20 log Emission level (uV/m).

Corrected Reading: Antenna Factor + Cable Loss + Read Level - Preamp Factor = Level.

3.2.9 TEST RESULTS (18GHZ-40GHZ)

EUT :	Mobile Phone	Model Name. :	GQ3081
Temperature :	20 °C	Relative Humidity :	48%
Pressure :	1010 hPa	Test Voltage :	DC 3.85V
Test Mode :	TX (5.2G)-802.11n20 5180MHz~5240MHz; TX (5.8G)-802.11a 5745MHz~5825MHz		

All the modulation modes have been tested, and the worst result was report as below:
Low Channel (5180 MHz)-Above 1G

Horizontal

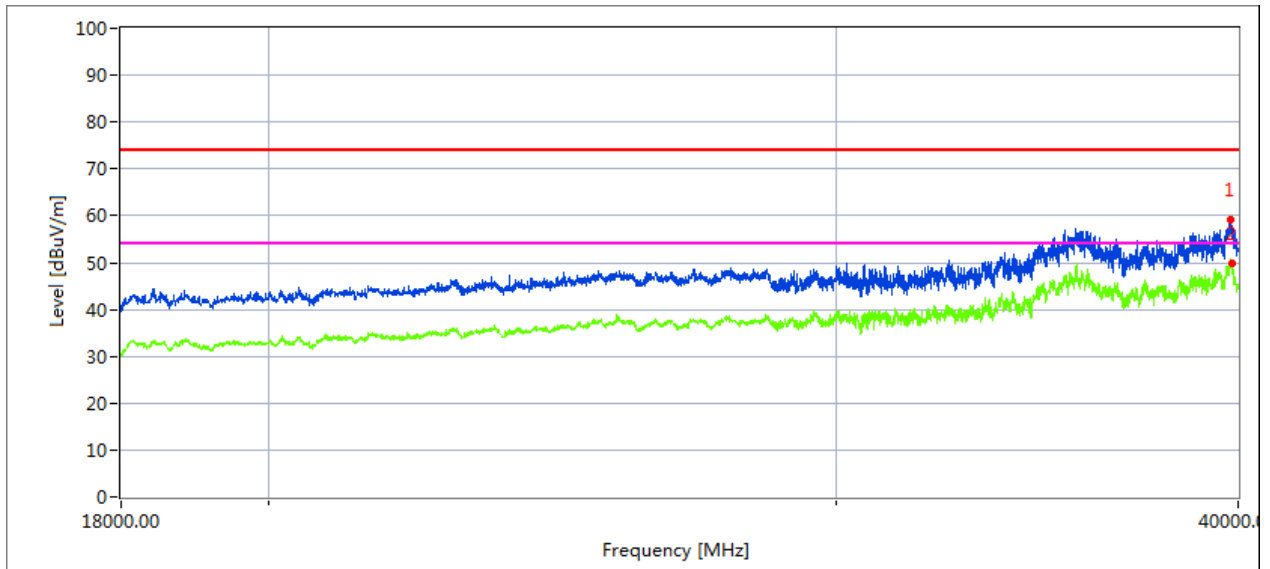

Measurement Result:

Frequency MHz	Pre-scan Level MaxPeak dBuV/m	Final Test Level MaxPeak dBuV/m	Limit MaxPeak dBuV/m	Margin dB
39782.573	58.7	56.2	74.0	17.8
39835.713	40.9	39.7	54.0	14.3

Vertical

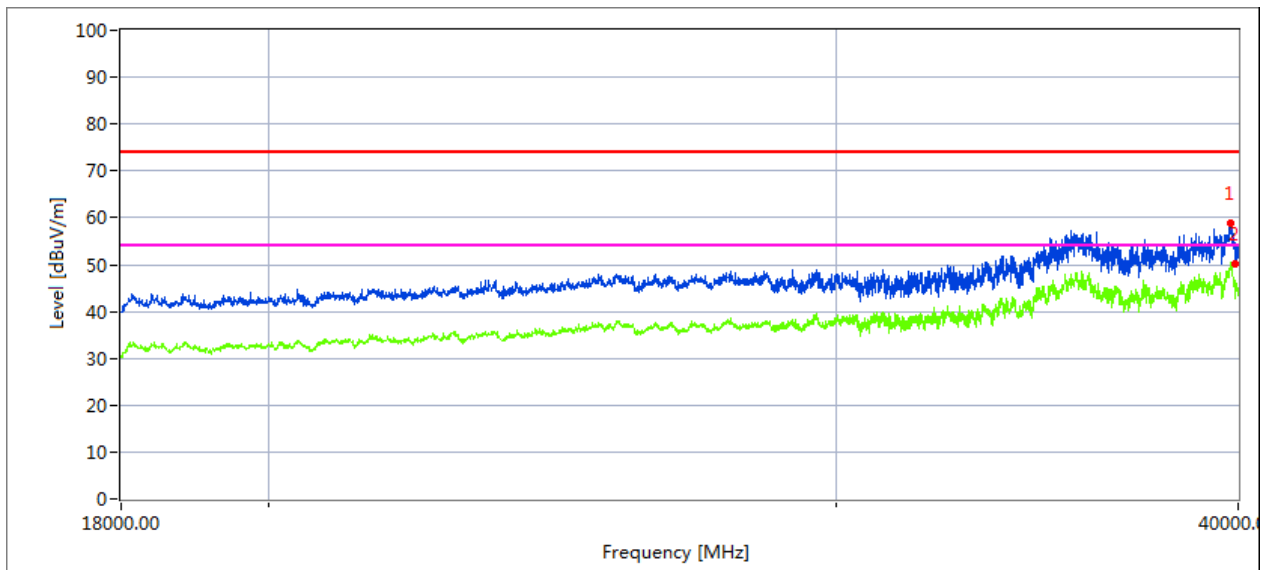

Measurement Result:

Frequency MHz	Pre-scan Level MaxPeak dBuV/m	Final Test Level MaxPeak dBuV/m	Limit MaxPeak dBuV/m	Margin dB
39798.577	59.1	55.8	74.0	18.2
39926.119	41.9	40.2	54.0	13.8

High Channel (5240 MHz)-Above 1G

Horizontal

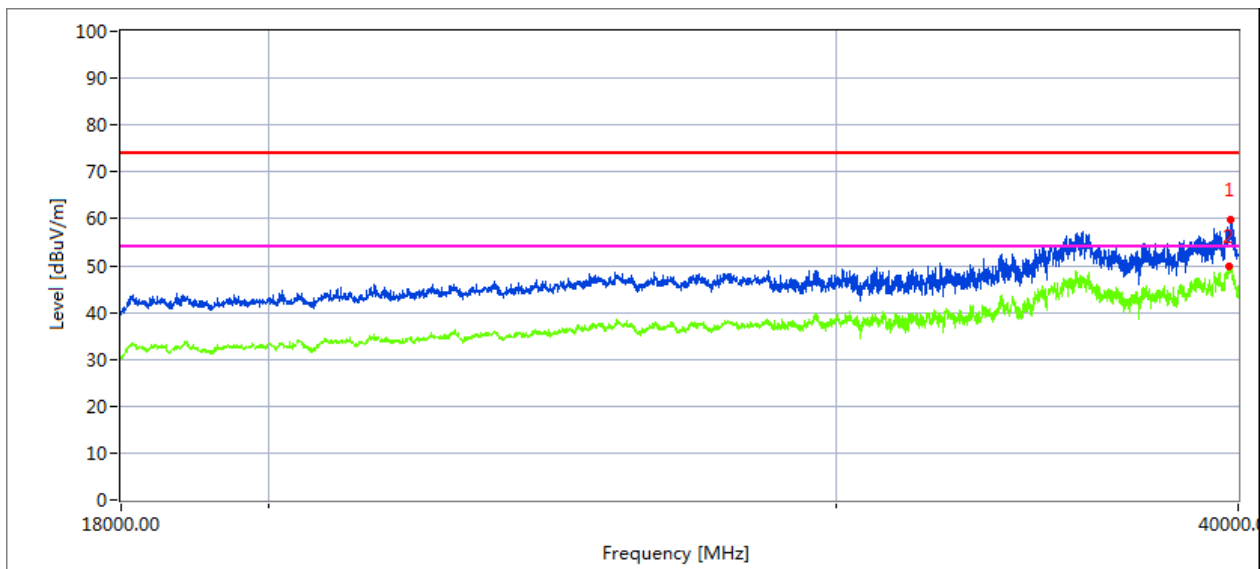

Measurement Result:

Frequency MHz	Pre-scan Level MaxPeak dBuV/m	Final Test Level MaxPeak dBuV/m	Limit MaxPeak dBuV/m	Margin dB
39799.137	60.0	52.1	74.0	21.9
39727.007	50.2	41.9	54.0	12.1

Vertical

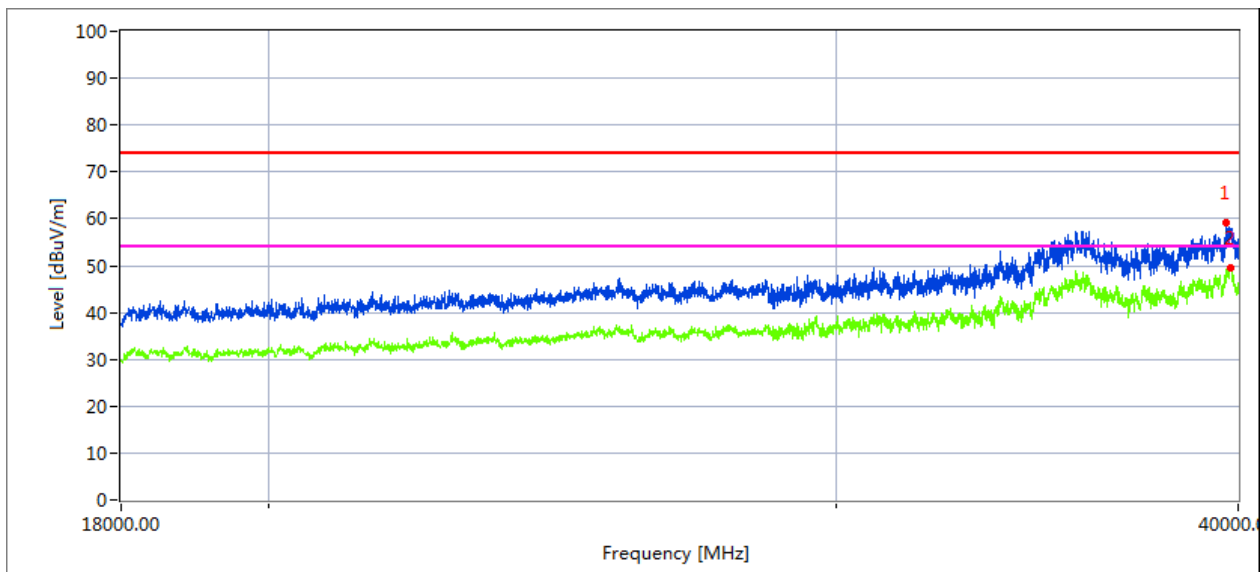

Measurement Result:

Frequency MHz	Pre-scan Level MaxPeak dBuV/m	Final Test Level MaxPeak dBuV/m	Limit MaxPeak dBuV/m	Margin dB
39672.008	58.8	53.2	74.0	20.8
39778.107	49.1	42.2	54.0	11.8

Low Channel (5745 MHz)-Above 1G

Horizontal

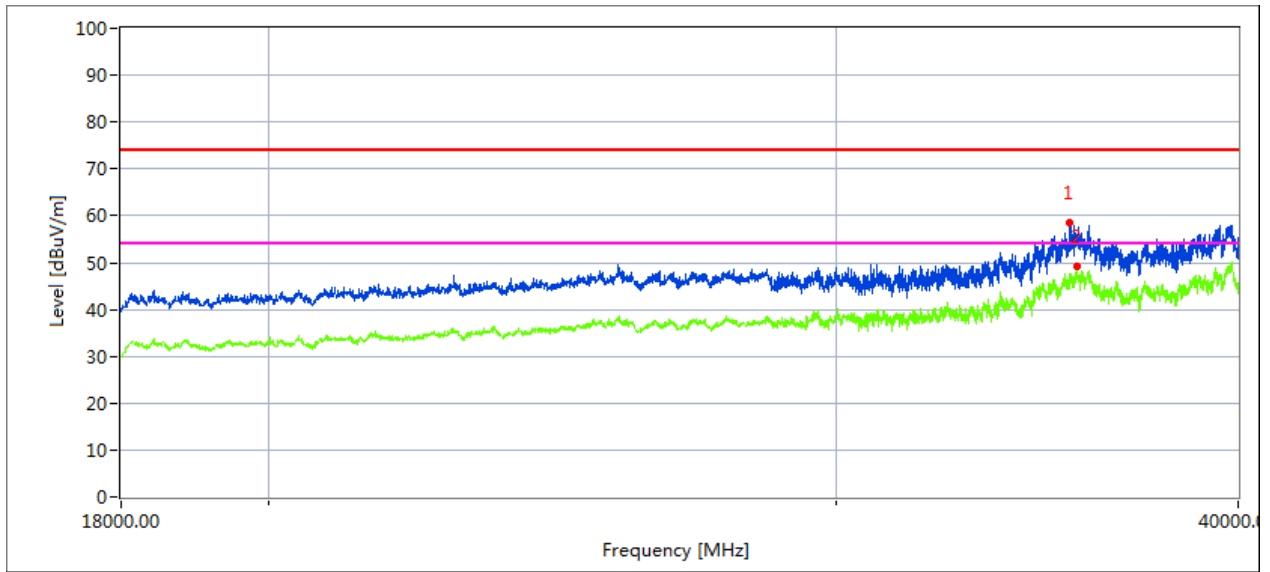

Measurement Result:

Frequency MHz	Pre-scan Level MaxPeak dBuV/m	Final Test Level MaxPeak dBuV/m	Limit MaxPeak dBuV/m	Margin dB
35459.112	59.1	47.0	74.0	27.0
35650.968	41.9	40.1	54.0	13.9

Vertical

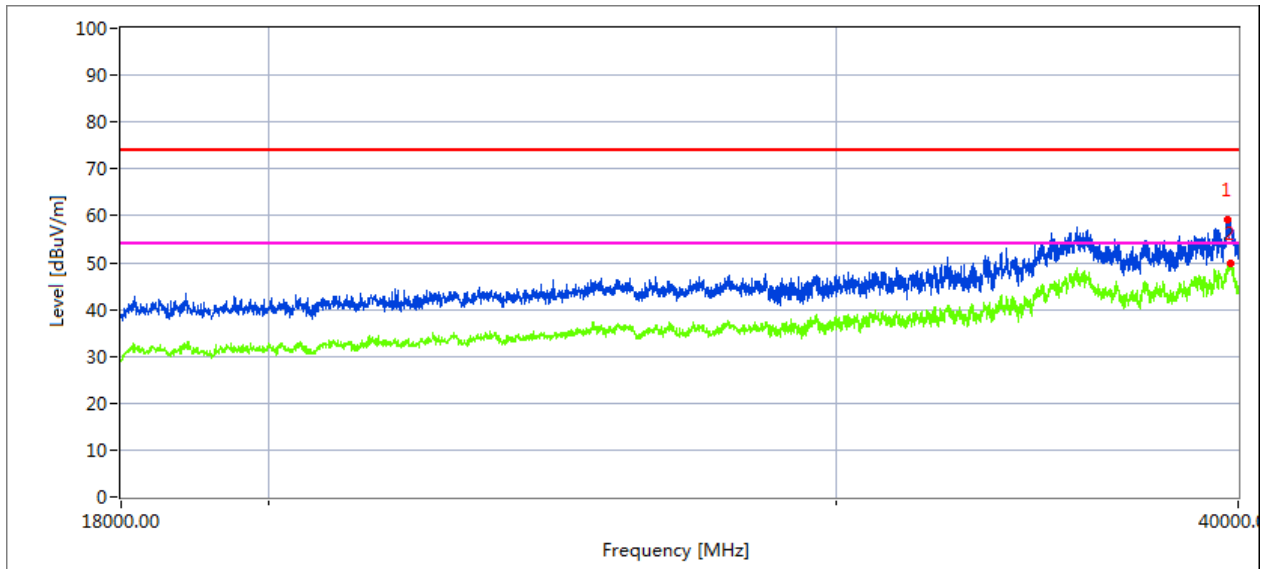

Measurement Result:

Frequency MHz	Pre-scan Level MaxPeak dBuV/m	Final Test Level MaxPeak dBuV/m	Limit MaxPeak dBuV/m	Margin dB
39716.014	58.8	57.1	74.0	16.9
39790.116	42.1	40.0	54.0	14.0

High Channel (5825 MHz)-Above 1G

Horizontal

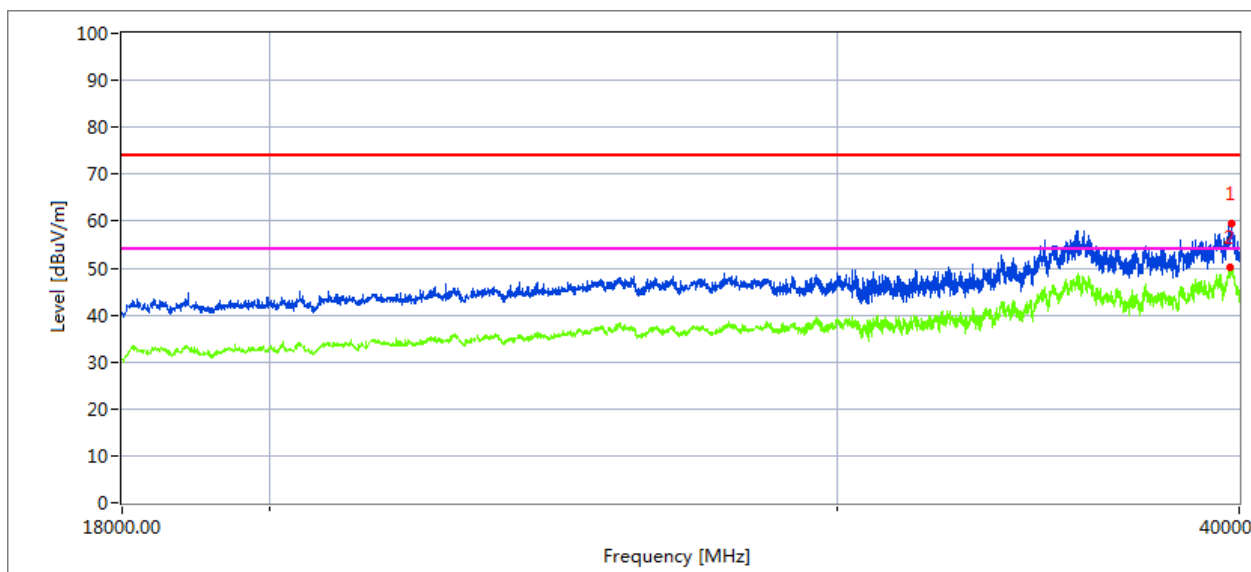

Measurement Result:

Frequency MHz	Pre-scan Level MaxPeak dBuV/m	Final Test Level MaxPeak dBuV/m	Limit MaxPeak dBuV/m	Margin dB
39764.973	58.9	31.8	74.0	42.2
39742.997	44.2	40.1	54.0	13.9

Vertical

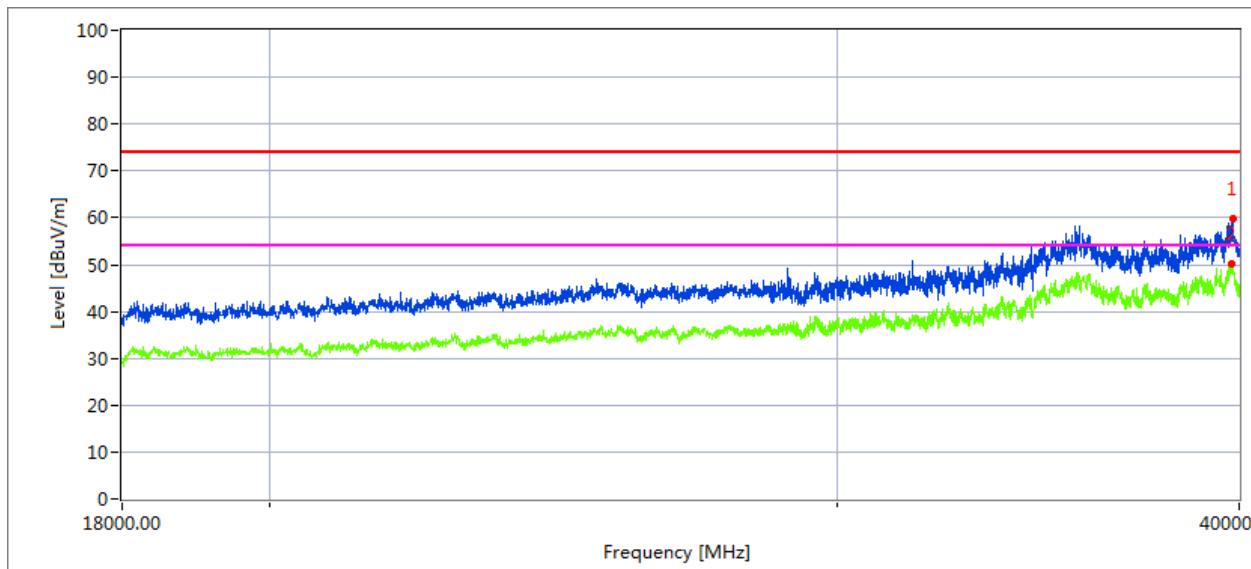

Measurement Result:

Frequency MHz	Pre-scan Level MaxPeak dBuV/m	Final Test Level MaxPeak dBuV/m	Limit MaxPeak dBuV/m	Margin dB
39815.145	60.0	46.9	74.0	27.1
39772.983	42.3	39.2	54.0	14.8

4. POWER SPECTRAL DENSITY TEST

4.1 APPLIED PROCEDURES / LIMIT

According to FCC §15.407(a)

For the band 5.15-5.25 GHz,

(i) For an outdoor access point operating in the band 5.15-5.25 GHz, the maximum power spectral density shall not exceed 17 dBm in any 1 megahertz band. If transmitting antennas of directional gain greater than 6 dBi are used, both the maximum conducted output power and the maximum power spectral density shall be reduced by the amount in dB that the directional gain of the antenna exceeds 6 dBi. The maximum e.i.r.p. at any elevation angle above 30 degrees as measured from the horizon must not exceed 125 mW (21 dBm).

(ii) For an indoor access point operating in the band 5.15-5.25 GHz, the maximum power spectral density shall not exceed 17 dBm in any 1 megahertz band. If transmitting antennas of directional gain greater than 6 dBi are used, both the maximum conducted output power and the maximum power spectral density shall be reduced by the amount in dB that the directional gain of the antenna exceeds 6 dBi.

(iii) For fixed point-to-point access points operating in the band 5.15-5.25 GHz, the maximum power spectral density shall not exceed 17 dBm in any 1 megahertz band. Fixed point-to-point U-NII devices may employ antennas with directional gain up to 23 dBi without any corresponding reduction in the maximum conducted output power or maximum power spectral density. For fixed point-to-point transmitters that employ a directional antenna gain greater than 23 dBi, a 1 dB reduction in maximum conducted output power and maximum power spectral density is required for each 1 dB of antenna gain in excess of 23 dBi. Fixed, point-to-point operations exclude the use of point-to-multipoint systems, omnidirectional applications, and multiple collocated transmitters transmitting the same information. The operator of the U-NII device, or if the equipment is professionally installed, the installer, is responsible for ensuring that systems employing high gain directional antennas are used exclusively for fixed, point-to-point operations.

(iv) For client devices in the 5.15-5.25 GHz band, the maximum power spectral density shall not exceed 11 dBm in any 1 megahertz band. If transmitting antennas of directional gain greater than 6 dBi are used, both the maximum conducted output power and the maximum power spectral density shall be reduced by the amount in dB that the directional gain of the antenna exceeds 6 dBi.

For the 5.25-5.35 GHz and 5.47-5.725 GHz bands, the maximum conducted output power over the frequency bands of operation shall not exceed the lesser of 250 mW or $11 \text{ dBm} + 10 \log B$, where B is the 26 dB emission bandwidth in megahertz. In addition, the maximum power spectral density shall not exceed 11 dBm in any 1 megahertz band. If transmitting antennas of directional gain greater than 6 dBi are used, both the maximum conducted output power and the maximum power spectral density shall be reduced by the amount in dB that the directional gain of the antenna exceeds 6 dBi.

For the band 5.725-5.85 GHz

(3) For the band 5.725-5.85 GHz, the maximum power spectral density shall not exceed 30 dBm in any 500-kHz band. If transmitting antennas of directional gain greater than 6 dBi are used, both the maximum conducted output power and the maximum power spectral density shall be reduced by the amount in dB that the directional gain of the antenna exceeds 6 dBi.

,

4.2 TEST PROCEDURE

For devices operating in the bands 5.15-5.25 GHz, 5.25-5.35 GHz, and 5.47-5.725 GHz, the above procedures make use of 1 MHz RBW to satisfy directly the 1 MHz reference bandwidth specified in § 15.407(a)(5). For devices operating in the band 5.725-5.85 GHz, the rules specify a measurement bandwidth of 500 kHz. Many spectrum analyzers do not have 500 kHz RBW, thus a narrower RBW may need to be used. The rules permit the use of a RBWs less than 1 MHz, or 500 kHz, “provided that the measured power is integrated over the full reference bandwidth” to show the total power over the specified measurement bandwidth (i.e., 1 MHz, or 500 kHz). If measurements are performed using a reduced resolution bandwidth (< 1 MHz, or < 500 kHz) and integrated over 1 MHz, or 500 KHz bandwidth, the following adjustments to the procedures apply:

- a) Set $RBW \geq 1/T$, where T is defined in section II.B.I.a).
- b) Set $VBW \geq 3 RBW$.
- c) If measurement bandwidth of Maximum PSD is specified in 500 kHz, add $10\log(500\text{kHz}/RBW)$ to the measured result, whereas $RBW (< 500 \text{ KHz})$ is the reduced resolution bandwidth of the spectrum analyzer set during measurement.
- d) If measurement bandwidth of Maximum PSD is specified in 1 MHz, add $10\log(1\text{MHz}/RBW)$ to the measured result, whereas $RBW (< 1 \text{ MHz})$ is the reduced resolution bandwidth of spectrum analyzer set during measurement.
- e) Care must be taken to ensure that the measurements are performed during a period of continuous transmission or are corrected upward for duty cycle.

Note: As a practical matter, it is recommended to use reduced RBW of 100 KHz for the sections 5.c) and 5.d) above, since $RBW=100 \text{ KHz}$ is available on nearly all spectrum analyzers.

4.3 DEVIATION FROM STANDARD

No deviation.

4.4 TEST SETUP



4.5 EUT OPERATION CONDITIONS

The EUT tested system was configured as the statements of 2.1 Unless otherwise a special operating condition is specified in the follows during the testing.

4.6 TEST RESULTS

EUT :	Mobile Phone	Model Name. :	GQ3081
Temperature :	25 °C	Relative Humidity :	56%
Pressure :	1015 hPa	Test Voltage :	DC 3.85V
Test Mode :	TX Frequency Band 1 (5150-5250MHz)		

Mode	Frequency	Measured Power Density (dBm)	Limit (dBm/MHz)	Result
802.11 a	5180 MHz	5.00	11	PASS
	5200 MHz	4.63	11	PASS
	5240 MHz	3.72	11	PASS
802.11 n20	5180 MHz	4.59	11	PASS
	5200 MHz	4.16	11	PASS
	5240 MHz	3.72	11	PASS
802.11 n40	5190 MHz	1.53	11	PASS
	5230 MHz	2.07	11	PASS
802.11 ac20	5180 MHz	5.05	11	PASS
	5200 MHz	4.78	11	PASS
	5240 MHz	4.07	11	PASS
802.11 ac40	5190 MHz	1.75	11	PASS
	5230 MHz	1.62	11	PASS
802.11 ac80	5210 MHz	-2.28	11	PASS

(802.11a) PSD plot on channel 36

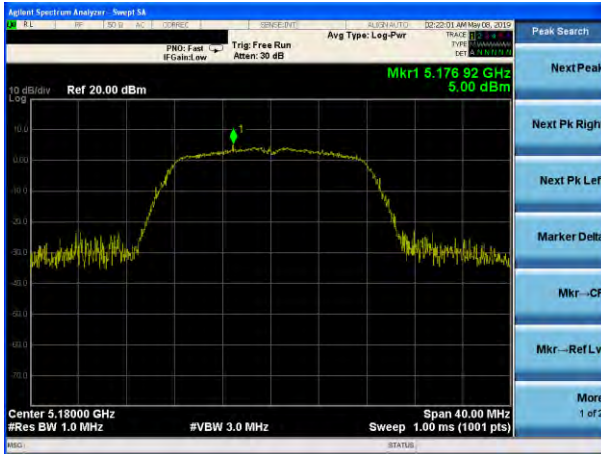

(802.11n20) PSD plot on channel 36

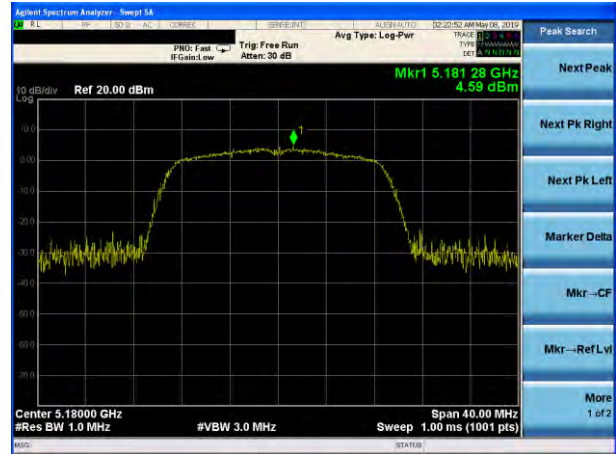

(802.11a) PSD plot on channel 40

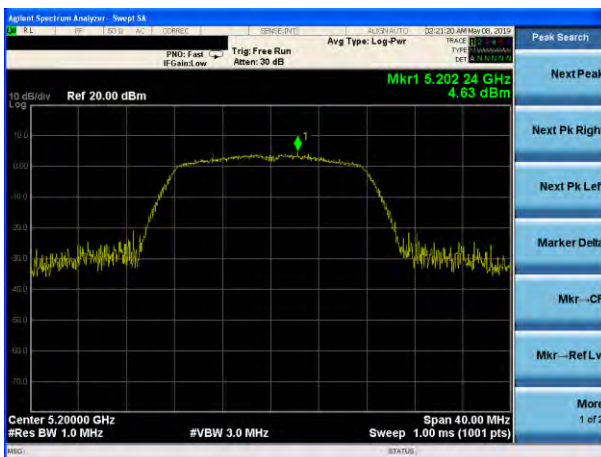

(802.11n20) PSD plot on channel 40

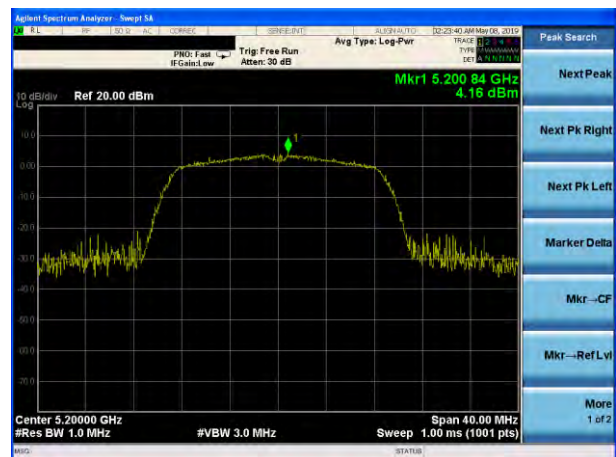

(802.11a) PSD plot on channel 48

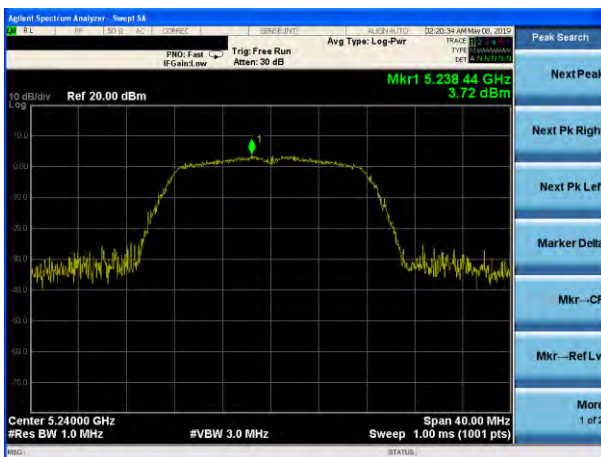

(802.11n20) PSD plot on channel 48

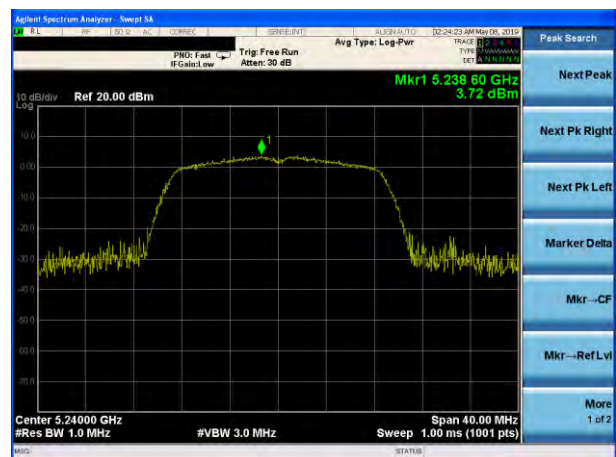

(802.11n40) PSD plot on channel 38

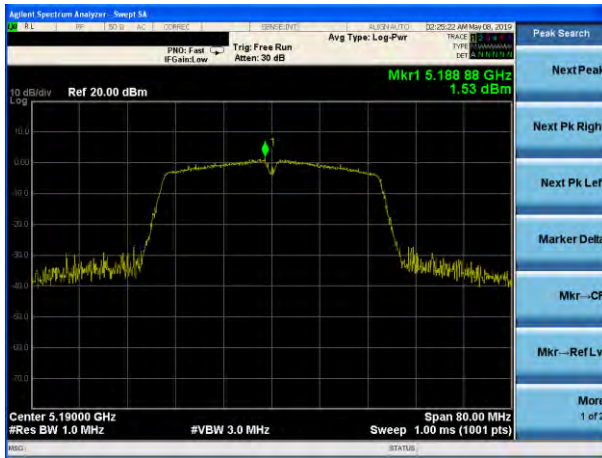

(802.11ac20) PSD plot on channel 36

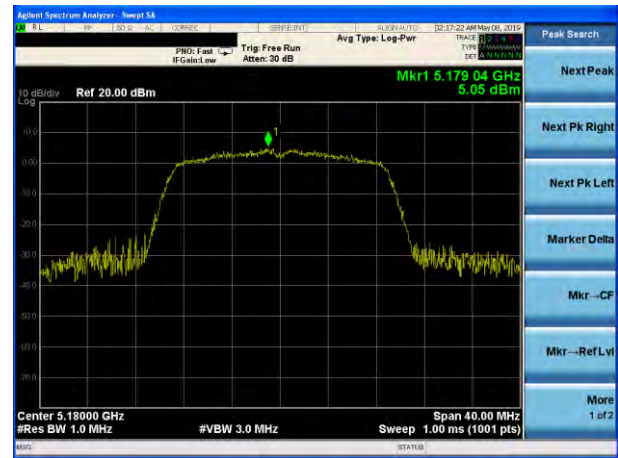

(802.11n40) PSD plot on channel 46

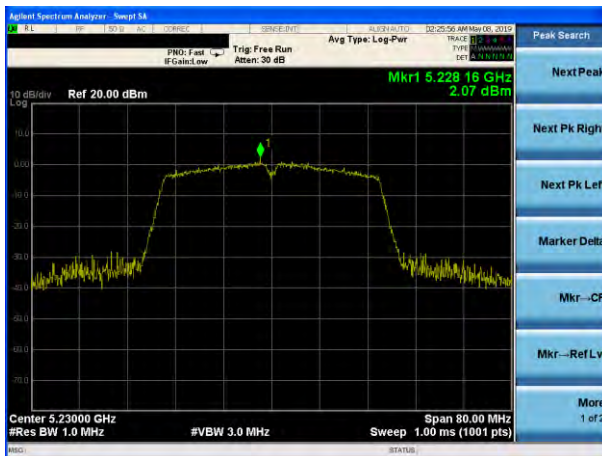

(802.11ac20) PSD plot on channel 40

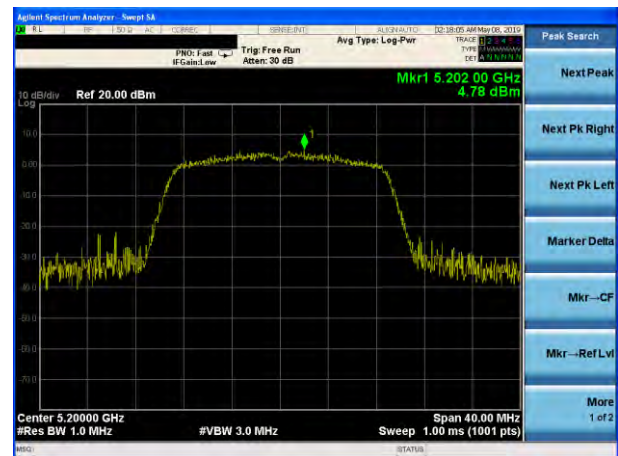

(802.11ac20) PSD plot on channel 48

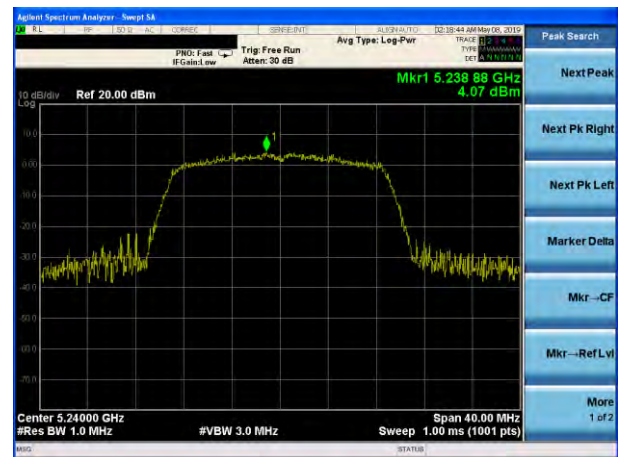

(802.11ac40) PSD plot on channel 38

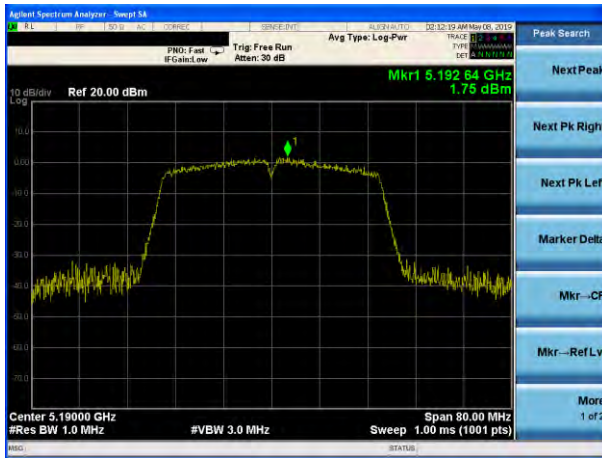

(802.11ac80) PSD plot on channel 42

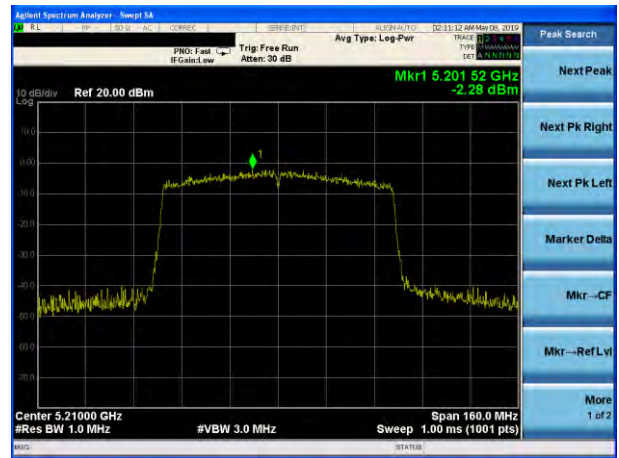

(802.11ac40) PSD plot on channel 46

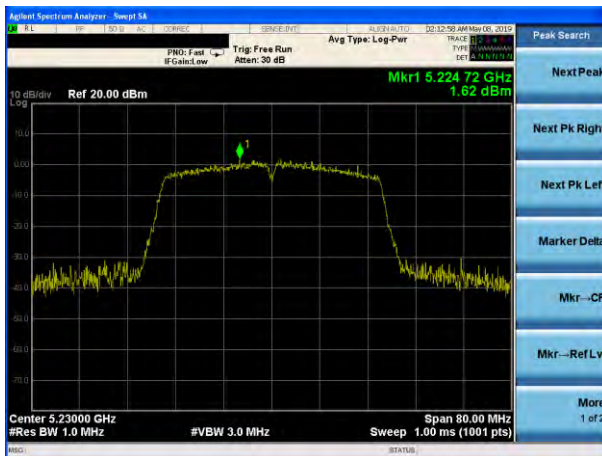

EUT :	Mobile Phone	Model Name. :	GQ3081
Temperature :	25 °C	Relative Humidity :	56%
Pressure :	1015 hPa	Test Voltage :	DC 3.85V
Test Mode :	TX Frequency Band IV (5725-5850MHz)		

Mode	Frequency	Measured Power Density (dBm)	Calculate power density (dBm)(Note 1)	Limit (dBm)	Result
802.11 a	5745 MHz	1.27	1.184	30	PASS
	5785 MHz	0.75	0.664	30	PASS
	5825 MHz	0.79	0.704	30	PASS
802.11 n20	5745 MHz	0.45	0.364	30	PASS
	5785 MHz	0.98	0.894	30	PASS
	5825 MHz	0.71	0.624	30	PASS
802.11 n40	5755 MHz	-2.45	-2.536	30	PASS
	5795 MHz	-2.59	-2.676	30	PASS
802.11 ac20	5745 MHz	1.62	1.534	30	PASS
	5785 MHz	0.63	0.544	30	PASS
	5825 MHz	1.84	1.754	30	PASS
802.11 ac40	5755 MHz	-1.31	-1.396	30	PASS
	5795 MHz	-1.25	-1.336	30	PASS
802.11 ac80	5775 MHz	-4.92	-5.006	30	PASS

Note:

(1) Calculate power density= Measured Power Density+10log(500kHz/RBW)= Measured Power Density+(-0.086)
 RBW=0.51MHz

(802.11a) PSD plot on channel 149

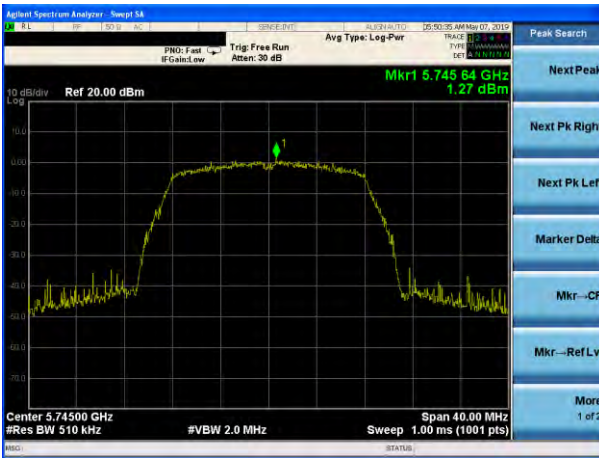

(802.11n20) PSD plot on channel 149

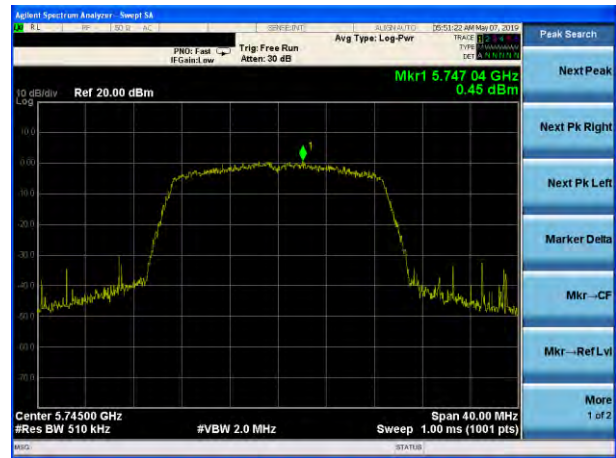

(802.11a) PSD plot on channel 157

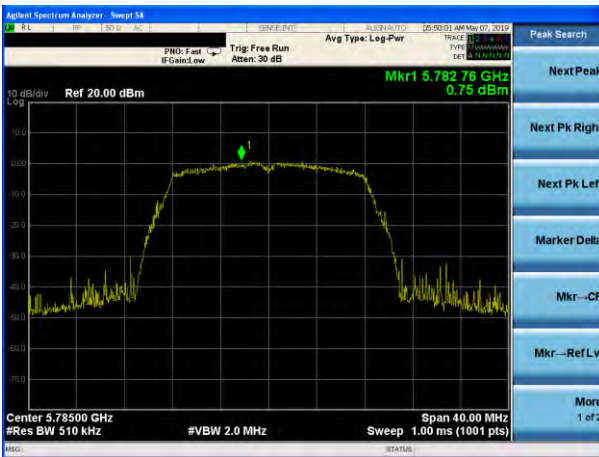

(802.11n20) PSD plot on channel 157

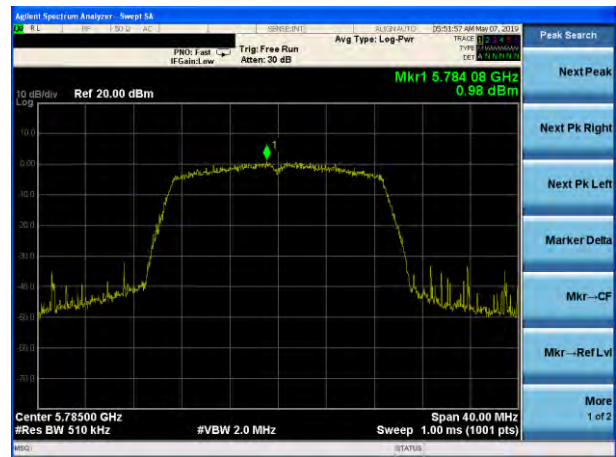

(802.11a) PSD plot on channel 165

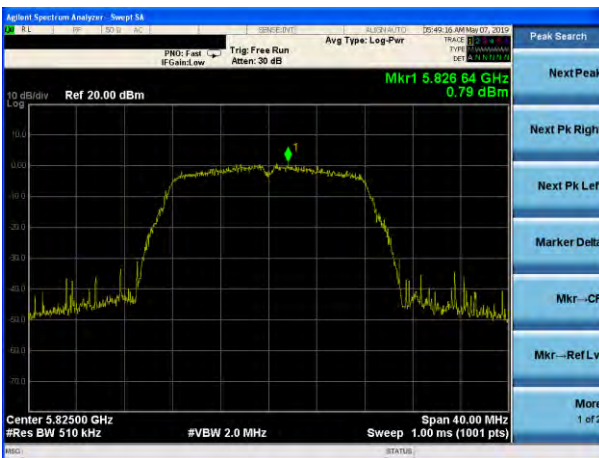

(802.11n20) PSD plot on channel 165

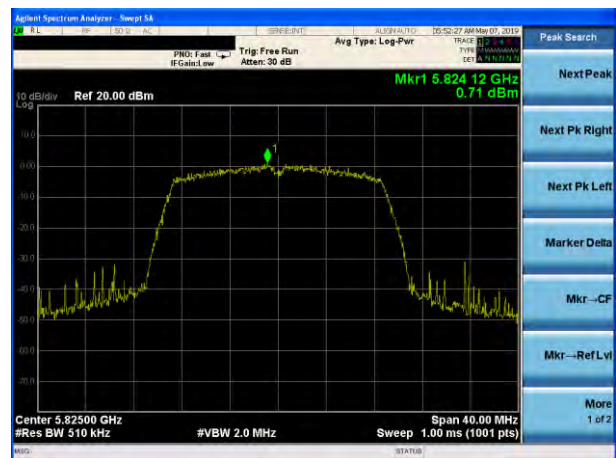

(802.11n40) PSD plot on channel 151

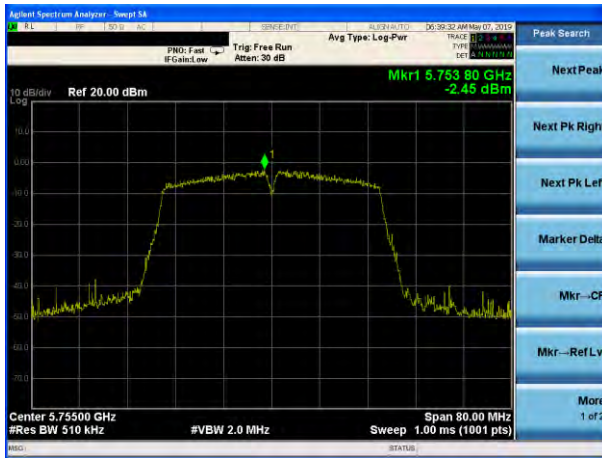

(802.11ac20) PSD plot on channel 149



(802.11n40) PSD plot on channel 159

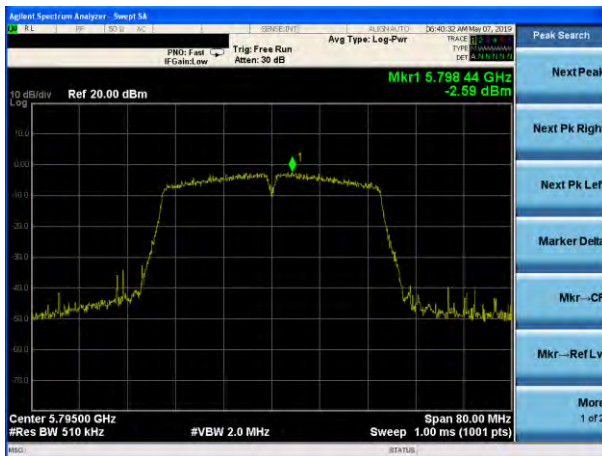

(802.11ac20) PSD plot on channel 157

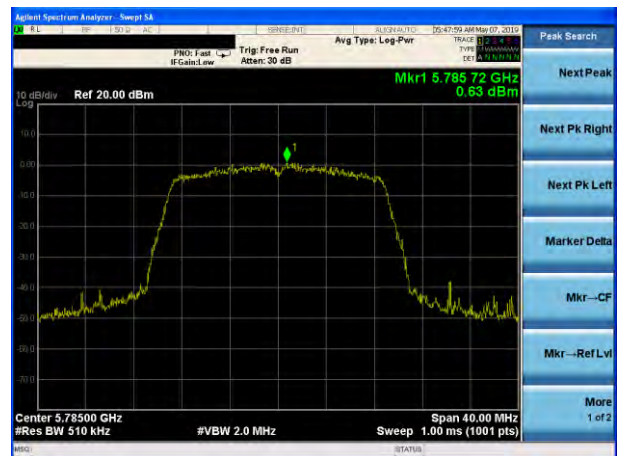

(802.11ac20) PSD plot on channel 165

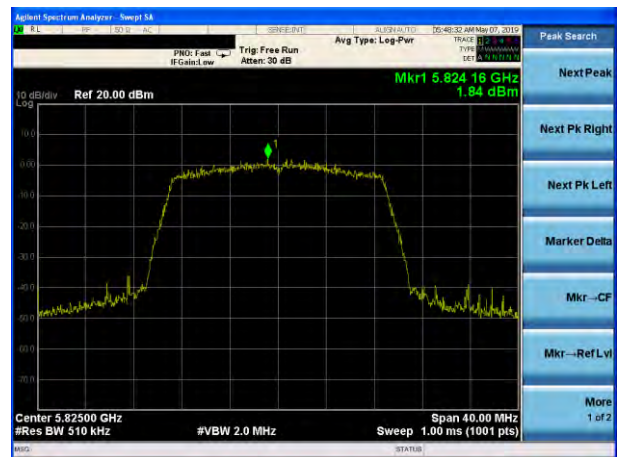

(802.11ac40) PSD plot on channel 151



(802.11ac80) PSD plot on channel 155

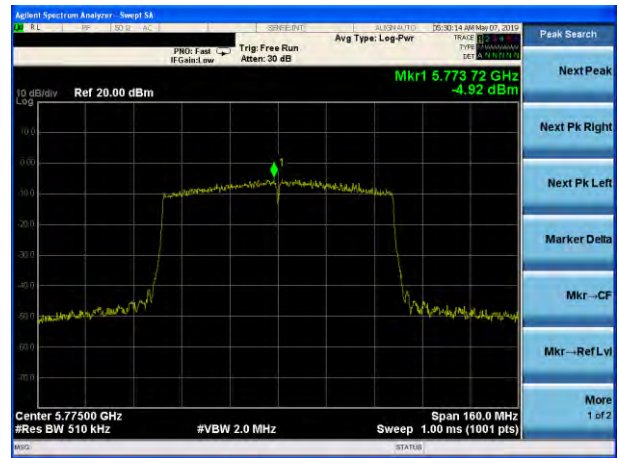

(802.11ac40) PSD plot on channel 159

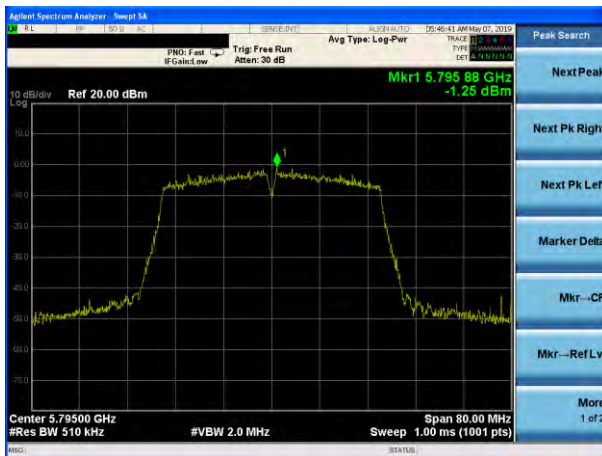

5. 26DB & 99% EMISSION BANDWIDTH

5.1 APPLIED PROCEDURES / LIMIT

The maximum power spectral density is measured as a conducted emission by direct connection of a calibrated test instrument to the equipment under test. If the device cannot be connected directly, alternative techniques acceptable to the Commission may be used. Measurements in the 5.725-5.85 GHz band are made over a reference bandwidth of 500 kHz or the 26 dB emission bandwidth of the device, whichever is less. Measurements in the 5.15-5.25 GHz, 5.25-5.35 GHz, and the 5.47-5.725 GHz bands are made over a bandwidth of 1 MHz or the 26 dB emission bandwidth of the device, whichever is less. A narrower resolution bandwidth can be used, provided that the measured power is integrated over the full reference bandwidth.

5.2 TEST PROCEDURE

- a) Set RBW = approximately 1% of the emission bandwidth.
- b) Set the VBW > RBW.
- c) Detector = Peak.
- d) Trace mode = max hold.
- e) Measure the maximum width of the emission that is 26 dB down from the maximum of the emission. Compare this with the RBW setting of the analyzer. Readjust RBW and repeat measurement as needed until the RBW/EBW ratio is approximately 1%.

The following procedure shall be used for measuring (99 %) power bandwidth:

1. Set center frequency to the nominal EUT channel center frequency.
2. Set span = 1.5 times to 5.0 times the OBW.
3. Set RBW = 1 % to 5 % of the OBW
4. Set VBW ≥ 3 · RBW
5. Video averaging is not permitted. Where practical, a sample detection and single sweep mode shall be used. Otherwise, peak detection and max hold mode (until the trace stabilizes) shall be used.
6. Use the 99 % power bandwidth function of the instrument (if available).
7. If the instrument does not have a 99 % power bandwidth function, the trace data points are recovered and directly summed in power units. The recovered amplitude data points, beginning at the lowest frequency, are placed in a running sum until 0.5 % of the total is reached; that frequency is recorded as the lower frequency. The process is repeated until 99.5 % of the total is reached; that frequency is recorded as the upper frequency. The 99% occupied bandwidth is the difference between these two frequencies.

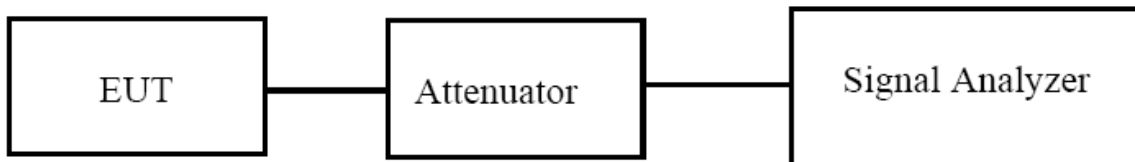

5.3 EUT OPERATION CONDITIONS

The EUT tested system was configured as the statements of 2.4 Unless otherwise a special operating condition is specified in the follows during the testing.

5.4 TEST RESULTS

EUT :	Mobile Phone	Model Name. :	GQ3081
Temperature :	25 °C	Relative Humidity :	56%
Pressure :	1012 hPa	Test Voltage :	DC 3.85V
Test Mode :	TX Frequency Band 1 (5150-5250MHz)		

Mode	Channel	Frequency (MHz)	99% bandwidth(MHz)	26dB bandwidth (MHz)	Result
802.11a	CH36	5180	16.660	20.16	Pass
	CH40	5200	16.607	20.11	Pass
	CH48	5240	16.619	20.13	Pass
802.11 n20	CH36	5180	17.743	20.42	Pass
	CH40	5200	17.685	20.49	Pass
	CH48	5240	17.719	20.47	Pass
802.11 n40	CH 38	5190	36.027	40.28	Pass
	CH 46	5230	36.176	40.78	Pass
802.11 ac20	CH36	5180	17.671	20.20	Pass
	CH40	5200	17.641	20.13	Pass
	CH48	5240	17.659	20.08	Pass
802.11 ac40	CH 38	5190	36.009	40.25	Pass
	CH 46	5230	35.949	40.00	Pass
802.11 ac80	CH 42	5210	75.295	80.63	Pass

Test plot

(802.11a) -26dB&99%Bandwidth plot on channel 36

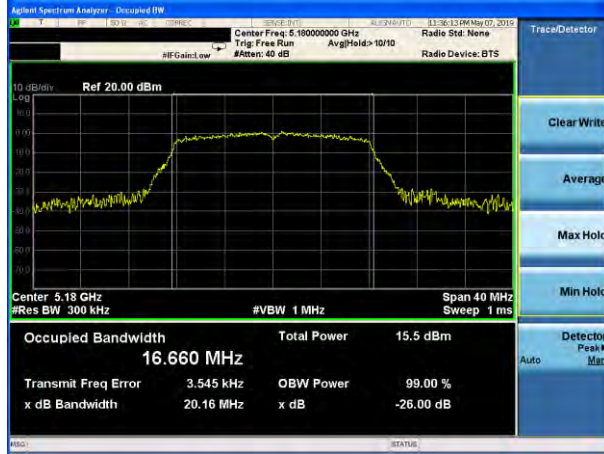

(802.11 n20) -26dB&99%Bandwidth plot on channel 36

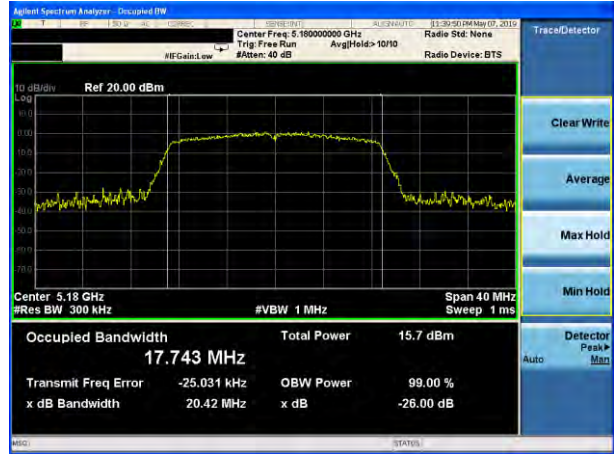

(802.11a) -26dB&99%Bandwidth plot on channel 40

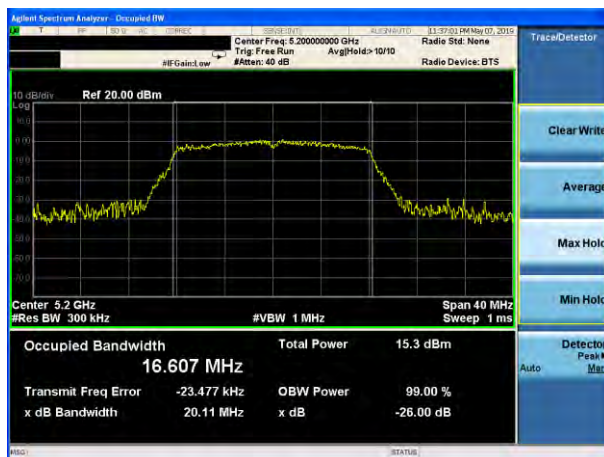

(802.11 n20) -26dB&99%Bandwidth plot on channel 40

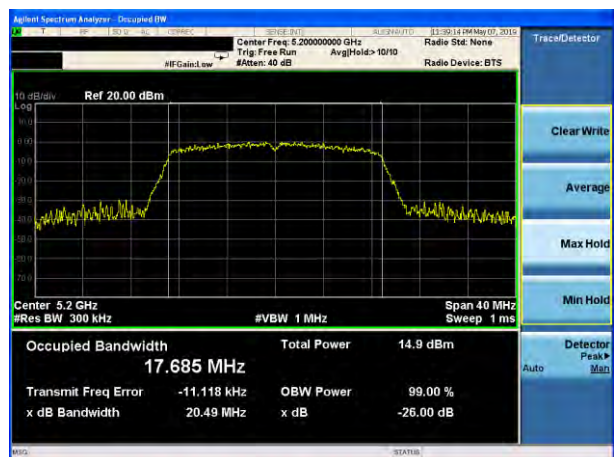

(802.11a) -26dB&99%Bandwidth plot on channel 48

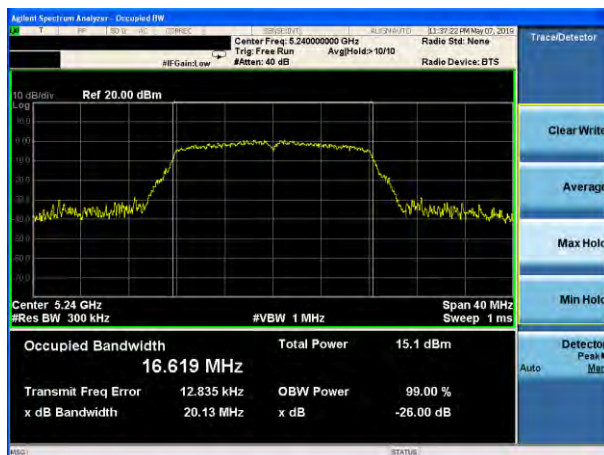

(802.11 n20) -26dB&99%Bandwidth plot on channel 48

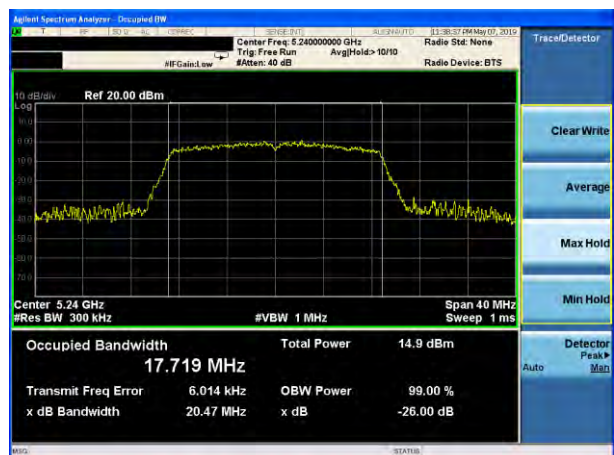

Test plot

(802.11 n40) -26dB&99%Bandwidth plot on channel 38

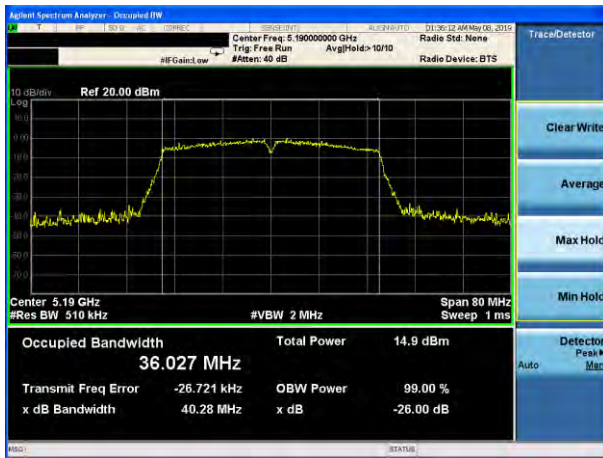

(802.11 ac20) -26dB&99%Bandwidth plot on channel 36



(802.11 n40) -26dB&99%Bandwidth plot on channel 46

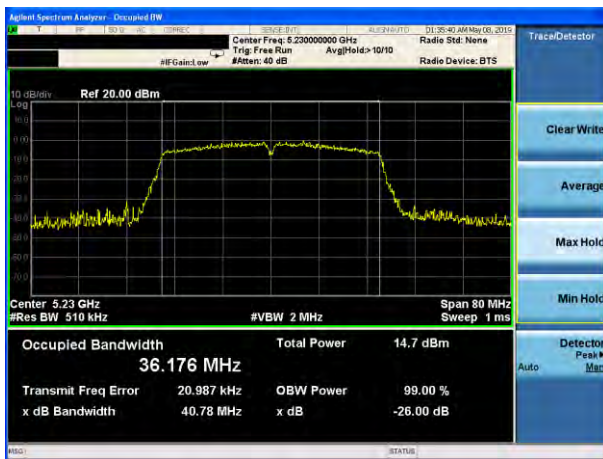

(802.11 ac20) -26dB&99%Bandwidth plot on channel 40



(802.11 ac20) -26dB&99%Bandwidth plot on channel 48

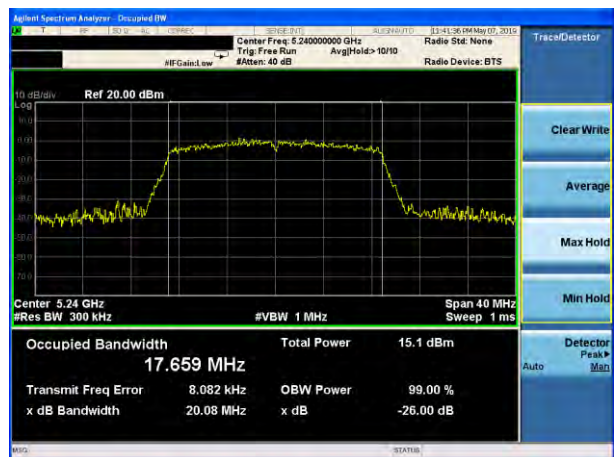

Test plot

(802.11 ac40) -26dB&99%Bandwidth plot on channel 38



(802.11 ac80) -26dB&99%Bandwidth plot on channel 42

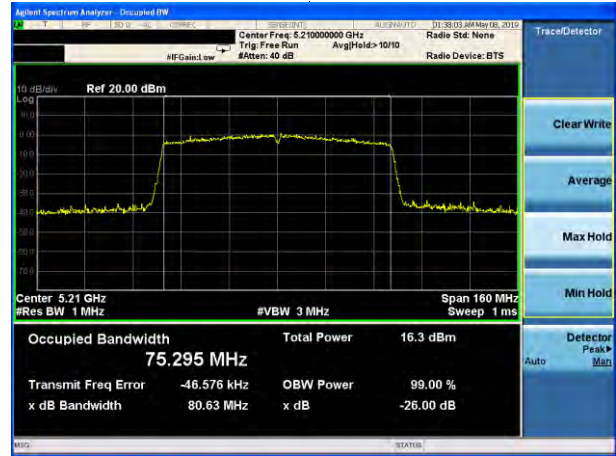

(802.11 ac40) -26dB&99%Bandwidth plot on channel 46

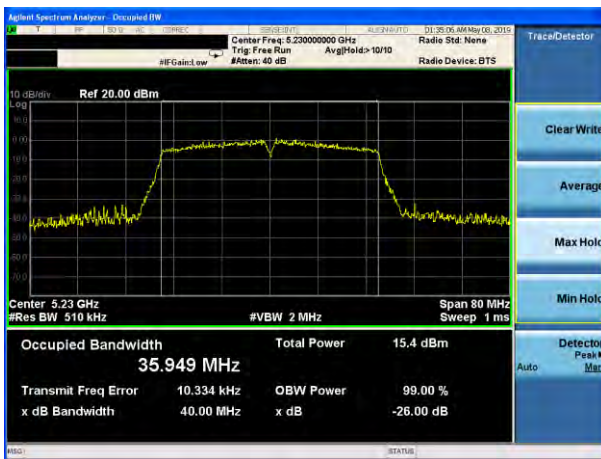

EUT :	Mobile Phone	Model Name. :	GQ3081
Temperature :	25 °C	Relative Humidity :	56%
Pressure :	1012 hPa	Test Voltage :	DC 3.85V
Test Mode :	TX Frequency Band IV (5725-5850MHz)		

Mode	Channel	Frequency (MHz)	99% bandwidth(MHz)	26dB bandwidth (MHz)	Result
802.11a	CH149	5745	16.620	20.17	Pass
	CH157	5785	16.557	20.00	Pass
	CH165	5825	16.601	19.80	Pass
802.11 n20	CH149	5745	17.629	20.31	Pass
	CH157	5785	17.640	20.36	Pass
	CH165	5825	17.661	20.42	Pass
802.11 n40	CH151	5755	36.016	40.52	Pass
	CH159	5795	36.122	40.61	Pass
802.11 ac20	CH149	5745	17.655	20.10	Pass
	CH157	5785	17.633	20.12	Pass
	CH165	5825	17.653	20.26	Pass
802.11 ac40	CH151	5755	35.990	40.49	Pass
	CH159	5795	36.078	40.07	Pass
802.11 ac80	CH155	5775	75.347	80.26	Pass

Test plot

(802.11a) -26dB&99%Bandwidth plot on channel 149

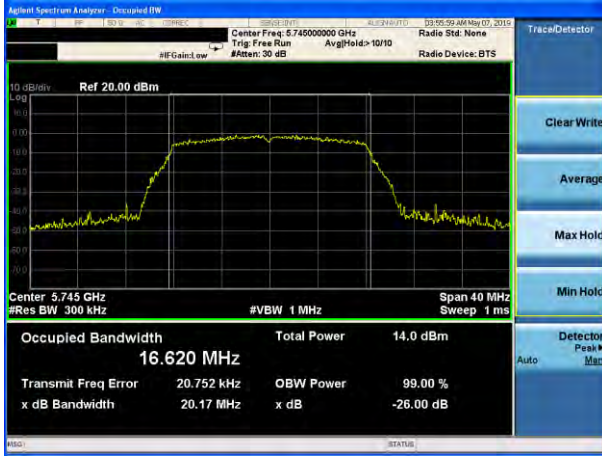

(802.11 n20) -26dB&99%Bandwidth plot on channel 149

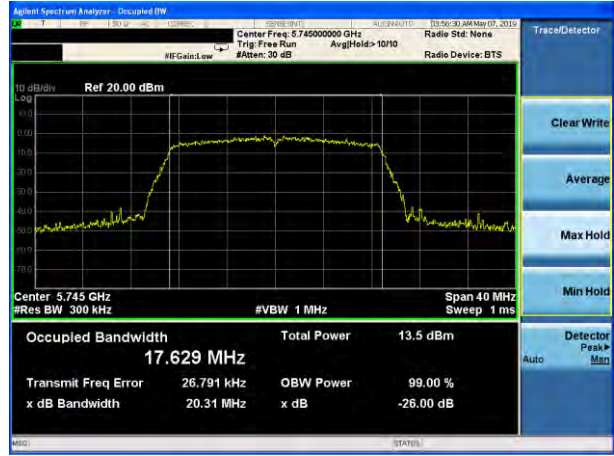

(802.11a) -26dB&99%Bandwidth plot on channel 157

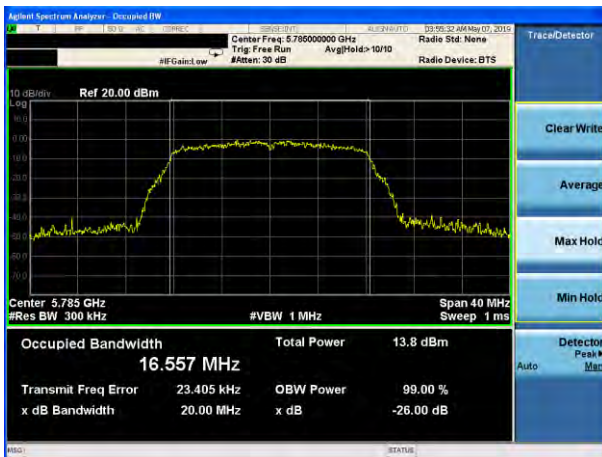

(802.11 n20) -26dB&99%Bandwidth plot on channel 157

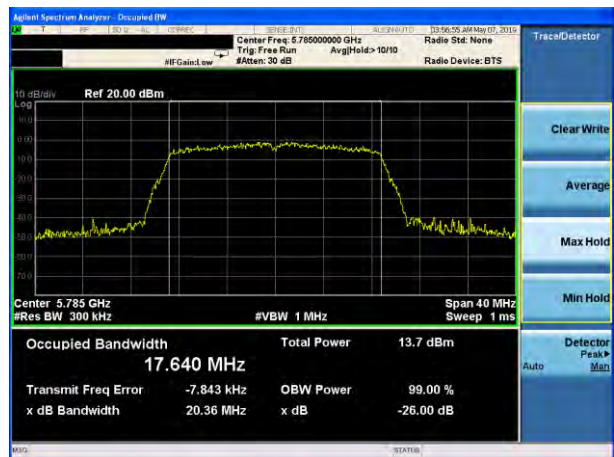

(802.11a) -26dB&99%Bandwidth plot on channel 165

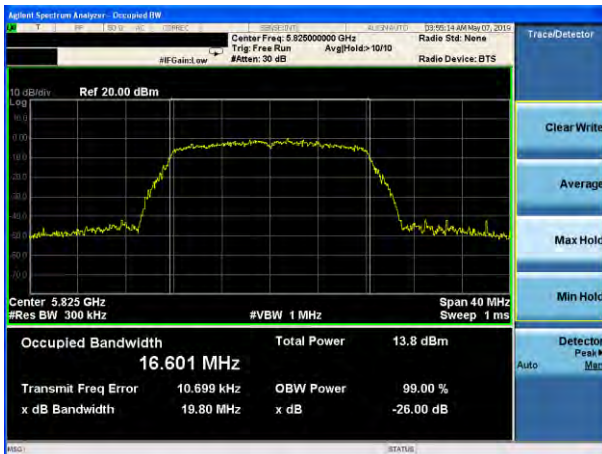

(802.11 n20) -26dB&99%Bandwidth plot on channel 165

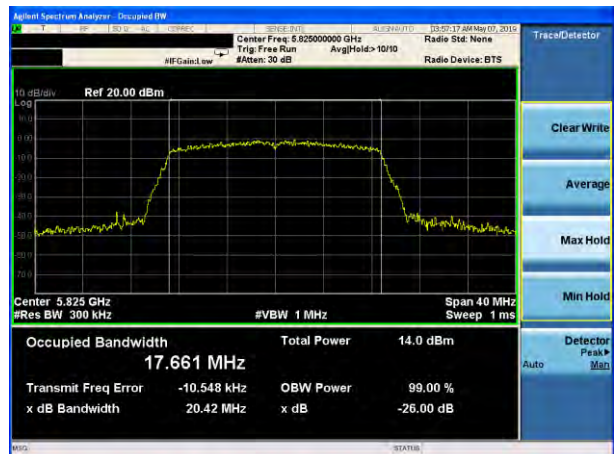

Test plot

(802.11 n40) -26dB&99%Bandwidth plot on channel 151

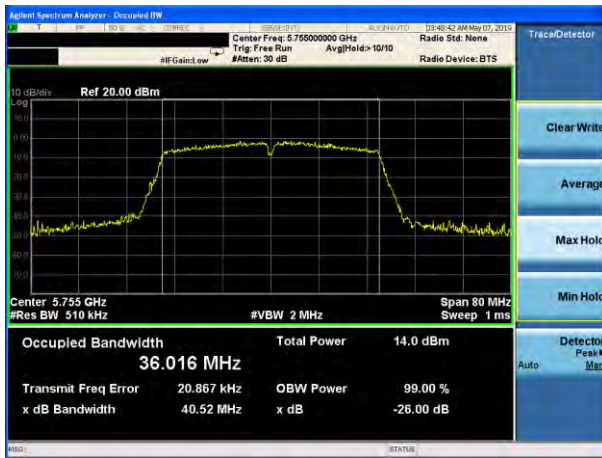

(802.11 ac20) -26dB&99%Bandwidth plot on channel 149

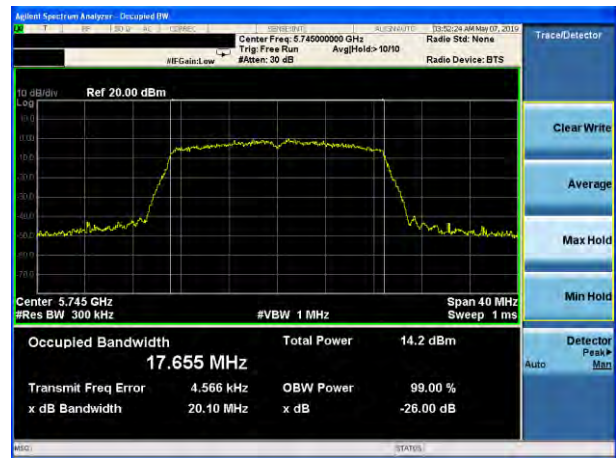

(802.11 n40) -26dB&99%Bandwidth plot on channel 159



(802.11 ac20) -26dB&99%Bandwidth plot on channel 157

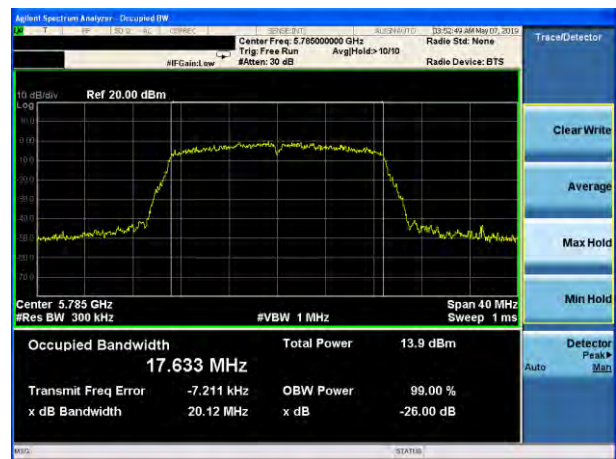

(802.11 ac20) -26dB&99%Bandwidth plot on channel 165

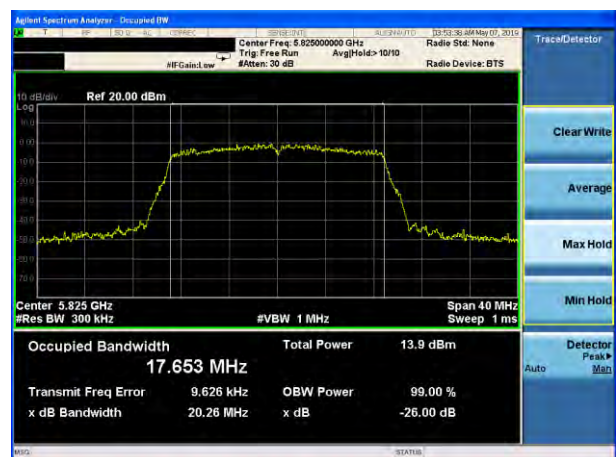

Test plot

(802.11 ac40) -26dB&99%Bandwidth plot on channel 151

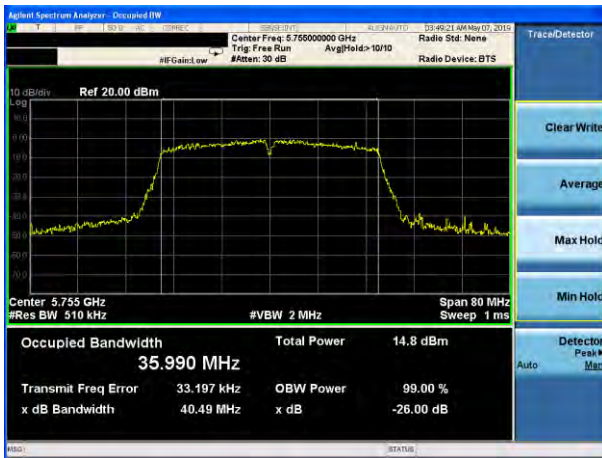

(802.11 ac80) -26dB&99%Bandwidth plot on channel 155

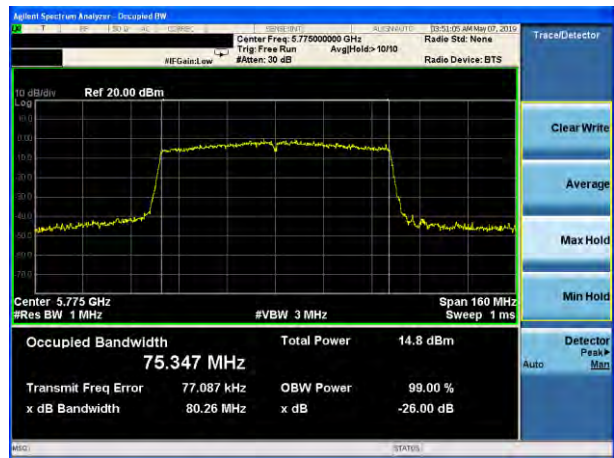

(802.11 ac40) -26dB&99%Bandwidth plot on channel 159

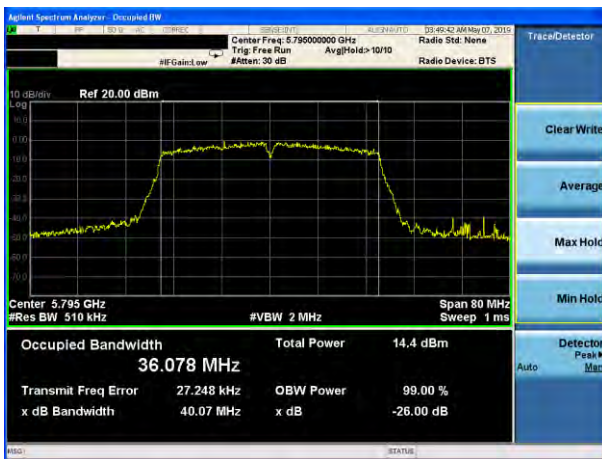

6. MINIMUM 6 DB BANDWIDTH

6.1 APPLIED PROCEDURES / LIMIT

According to FCC §15.407(e)

(e) Within the 5.725-5.85 GHz band, the minimum 6 dB bandwidth of U-NII devices shall be at least 500 kHz.

6.2 TEST PROCEDURE

Section 15.407(e) specifies the minimum 6 dB emission bandwidth of at least 500 KHz for the band 5.715-5.85 GHz. The following procedure shall be used for measuring this bandwidth:

- a) Set RBW = 100 kHz.
- b) Set the video bandwidth (VBW) $\geq 3 \times$ RBW.
- c) Detector = Peak.
- d) Trace mode = max hold.
- e) Sweep = auto couple.
- f) Allow the trace to stabilize.
- g) Measure the maximum width of the emission that is constrained by the frequencies associated with the two outermost amplitude points (upper and lower frequencies) that are attenuated by 6 dB relative to the maximum level measured in the fundamental emission.

6.3 DEVIATION FROM STANDARD

No deviation.

6.4 TEST SETUP

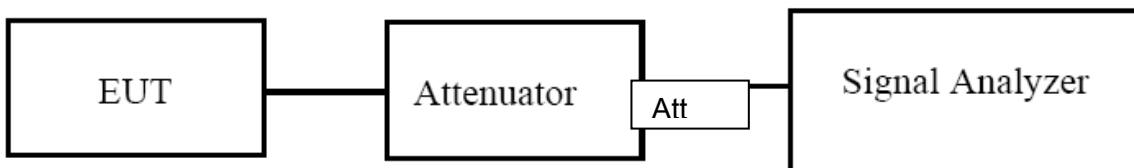

6.5 EUT OPERATION CONDITIONS

The EUT tested system was configured as the statements of 2.4 Unless otherwise a special operating condition is specified in the follows during the testing.

6.6 TEST RESULTS

EUT :	Mobile Phone	Model Name. :	GQ3081
Temperature :	25 °C	Relative Humidity :	60%
Pressure :	1012 hPa	Test Voltage :	DC 3.85V
Test Mode :	TX Frequency Band IV (5725-5850MHz)		

Mode	Channel	Frequency (MHz)	-6dB bandwidth (MHz)	Limit (KHz)	Result
802.11a	149	5745	16.36	≧ 500	Pass
	157	5785	16.37	≧ 500	Pass
	165	5825	16.39	≧ 500	Pass
802.11 n20	149	5745	17.63	≧ 500	Pass
	157	5785	17.62	≧ 500	Pass
	165	5825	17.62	≧ 500	Pass
802.11 n40	151	5755	35.83	≧ 500	Pass
	159	5795	35.91	≧ 500	Pass
802.11 ac20	149	5745	17.63	≧ 500	Pass
	157	5785	17.60	≧ 500	Pass
	165	5825	17.31	≧ 500	Pass
802.11 ac40	149	5745	35.45	≧ 500	Pass
	157	5785	36.25	≧ 500	Pass
802.11 ac80	155	5775	76.51	≧ 500	Pass

Test plot

(802.11a) 6dB Bandwidth plot on channel 149

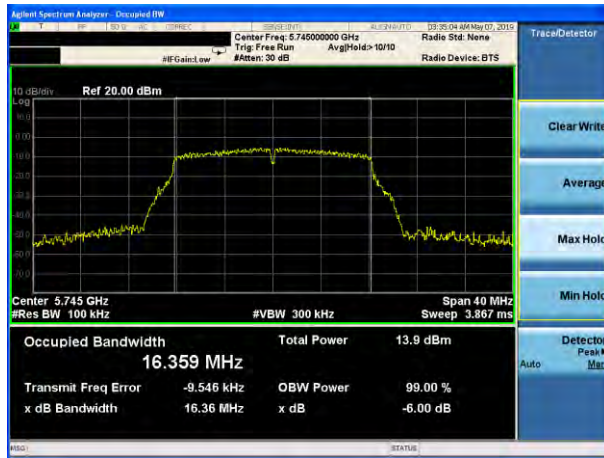

(802.11 n20) 6dB Bandwidth plot on channel 149

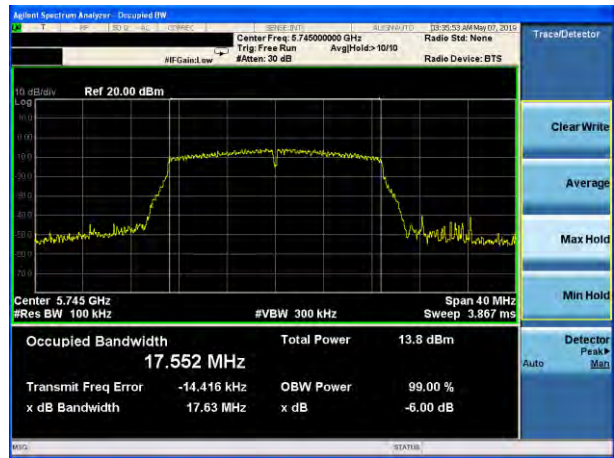

(802.11a) 6dB Bandwidth plot on channel 157



(802.11 n20) 6dB Bandwidth plot on channel 157

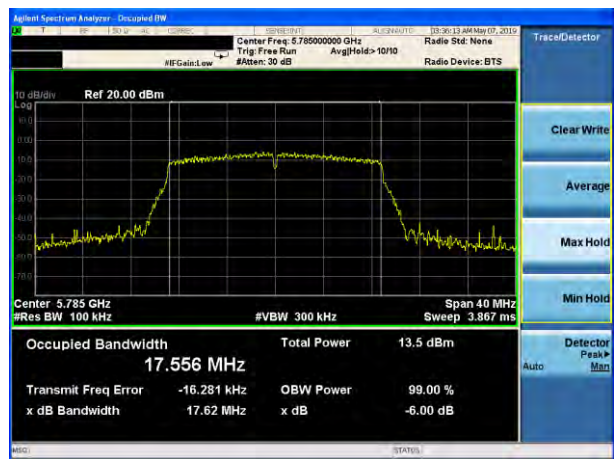

(802.11a) 6dB Bandwidth plot on channel 165

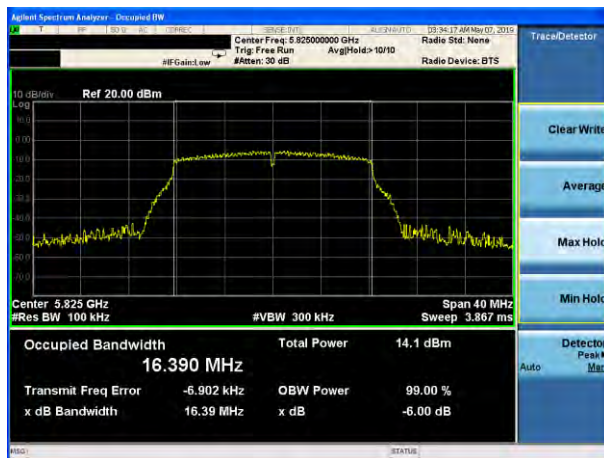

(802.11 n20) 6dB Bandwidth plot on channel 165

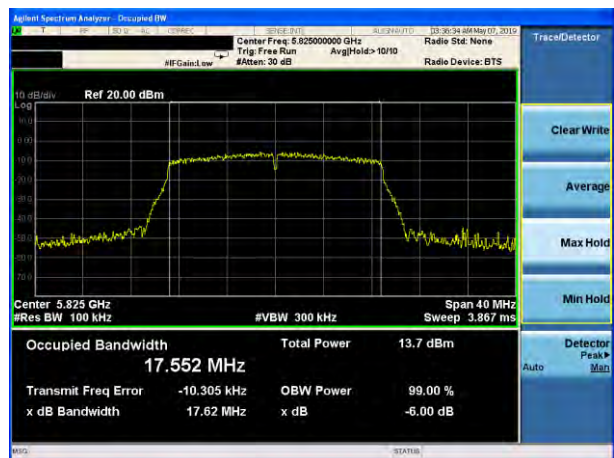

Test plot

(802.11 n40) 6dB Bandwidth plot on channel 151

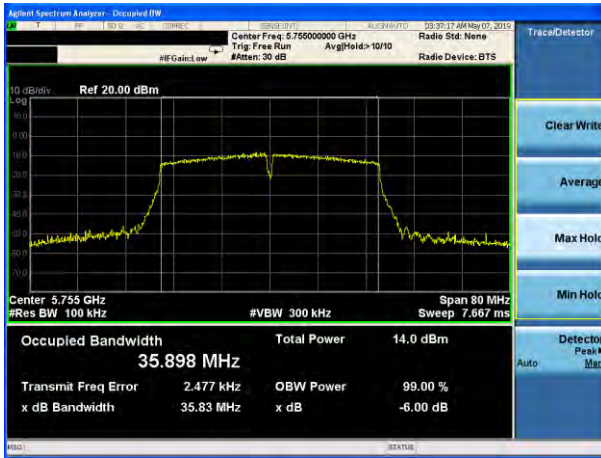

(802.11 ac20) 6dB Bandwidth plot on channel 149

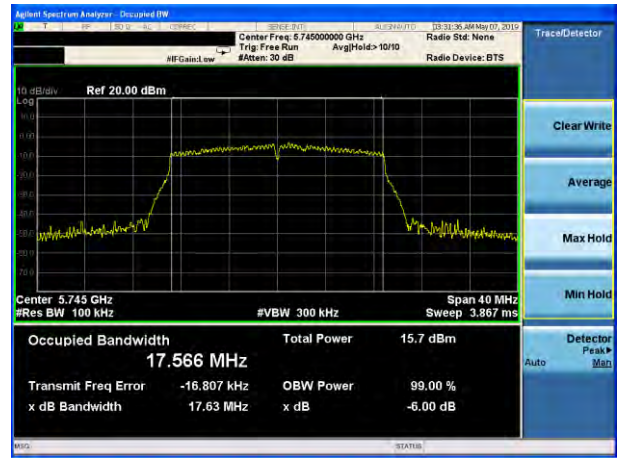

(802.11 n40) 6dB Bandwidth plot on channel 159

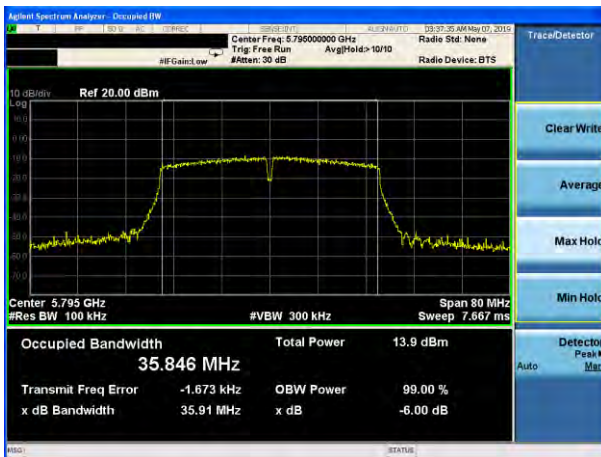

(802.11 ac20) 6dB Bandwidth plot on channel 157

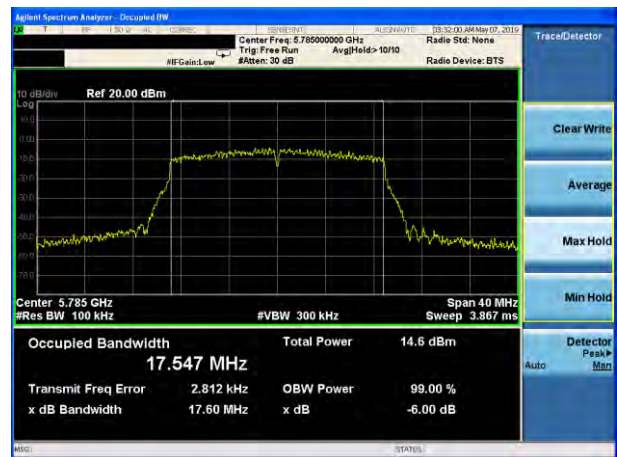

(802.11 ac20) 6dB Bandwidth plot on channel 165

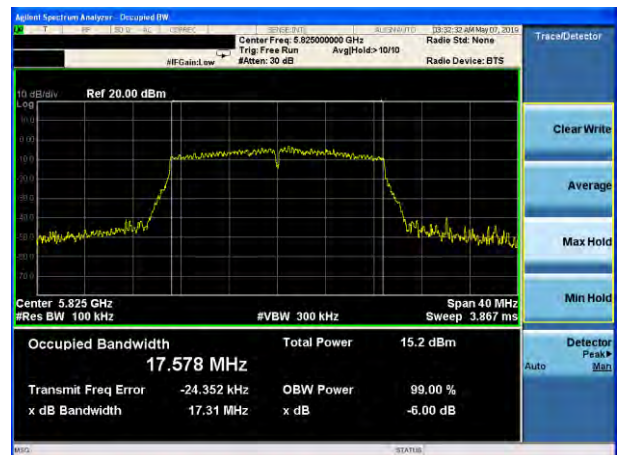

Test plot

(802.11 ac40) 6dB Bandwidth plot on channel 151

(802.11 ac80) 6dB Bandwidth plot on channel 155

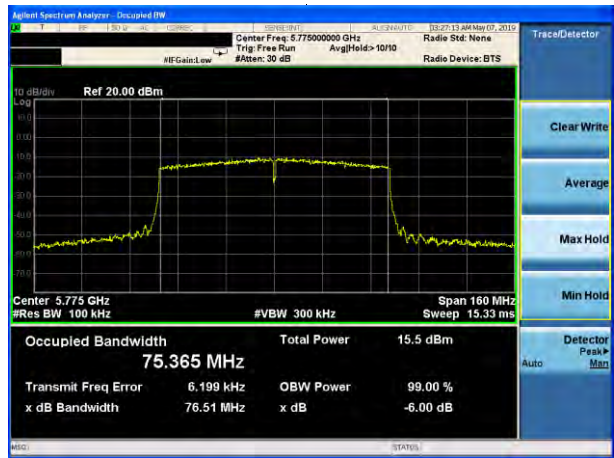
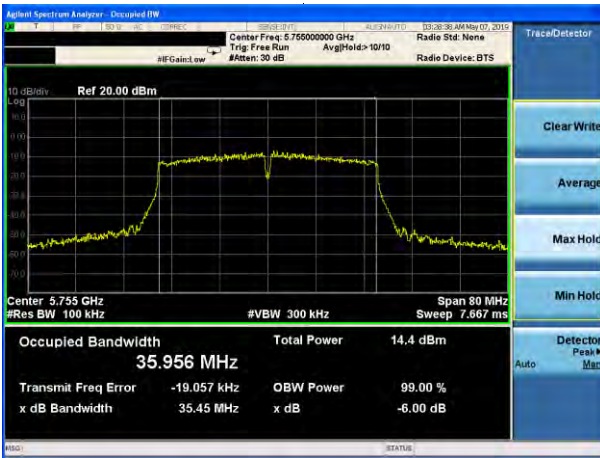

(802.11 ac40) 6dB Bandwidth plot on channel 159

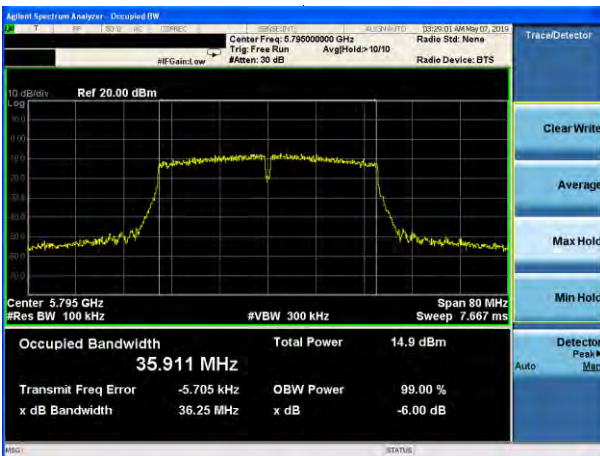

7. MAXIMUM CONDUCTED OUTPUT POWER

7.1 PPLIED PROCEDURES / LIMIT

According to FCC §15.407

The maximum conducted output power should not exceed:

Frequency Band(MHz)	Limit
5150~5250	250mW
5250~5350	250 mW or 11 dBm + 10 log B (Note)
5470~5725	250 mW or 11 dBm + 10 log B (Note)
5725~5850	1W

Note: the maximum conducted output power over the frequency bands of operation shall not exceed the lesser of 250 mW or 11 dBm + 10 log B, where B is the 26 dB emission bandwidth in megahertz.

7.2 TEST PROCEDURE

- Maximum conducted output power may be measured using a spectrum analyzer/EMI receiver or an RF power meter.

1. Device Configuration

If possible, configure or modify the operation of the EUT so that it transmits continuously at its maximum power control level (see section II.B.).

a) The intent is to test at 100 percent duty cycle; however a small reduction in duty cycle (to no lower than 98 percent) is permitted if required by the EUT for amplitude control purposes. Manufacturers are expected to provide software to the test lab to permit such continuous operation.

b) If continuous transmission (or at least 98 percent duty cycle) cannot be achieved due to hardware limitations (e.g., overheating), the EUT shall be operated at its maximum power control level with the transmit duration as long as possible and the duty cycle as high as possible.

2. Measurement using a Spectrum Analyzer or EMI Receiver (SA)

Measurement of maximum conducted output power using a spectrum analyzer requires integrating the spectrum across a frequency span that encompasses, at a minimum, either the EBW or the 99-percent occupied bandwidth of the signal.¹ However, the EBW must be used to determine bandwidth dependent limits on maximum conducted output power in accordance with § 15.407(a).

a) The test method shall be selected as follows: (i) Method SA-1 or SA-1 Alternative (averaging with the EUT transmitting at full power throughout each sweep) shall be applied if either of the following conditions can be satisfied:

- The EUT transmits continuously (or with a duty cycle ≥ 98 percent).
- Sweep triggering or gating can be implemented in a way that the device transmits at the maximum power control level throughout the duration of each of the instrument sweeps to be averaged. This condition can generally be achieved by triggering the instrument's sweep if the duration of the sweep (with the analyzer configured as in Method SA-1, below) is equal to or shorter than the duration T of each transmission from the EUT and if those transmissions exhibit full power throughout their durations.

(ii) Method SA-2 or SA-2 Alternative (averaging across on and off times of the EUT transmissions, followed by duty cycle correction) shall be applied if the conditions of (i) cannot be achieved and the transmissions exhibit a constant duty cycle during the measurement duration. Duty cycle will be considered to be constant if variations are less than ± 2 percent.

(iii) Method SA-3 (RMS detection with max hold) or SA-3 Alternative (reduced VBW with max hold) shall be applied if the conditions of (i) and (ii) cannot be achieved.

b) Method SA-1 (trace averaging with the EUT transmitting at full power throughout each sweep): (i) Set span to encompass the entire emission bandwidth (EBW) (or, alternatively, the entire 99% occupied bandwidth) of the signal.

(ii) Set RBW = 1 MHz.

(iii) Set VBW ≥ 3 MHz.

(iv) Number of points in sweep ≥ 2 Span / RBW. (This ensures that bin-to-bin spacing is \leq RBW/2, so that narrowband signals are not lost between frequency bins.)

(v) Sweep time = auto.

(vi) Detector = RMS (i.e., power averaging), if available. Otherwise, use sample detector mode.

(vii) If transmit duty cycle < 98 percent, use a video trigger with the trigger level set to enable triggering only on full power pulses. Transmitter must operate at maximum power control level for the entire duration of every sweep. If the EUT transmits continuously (i.e., with no off intervals) or at duty cycle ≥ 98 percent, and if each transmission is entirely at the maximum power control level, then the trigger shall be set to "free run".

(viii) Trace average at least 100 traces in power averaging (i.e., RMS) mode.

(ix) Compute power by integrating the spectrum across the EBW (or, alternatively, the entire 99% occupied bandwidth) of the signal using the instrument's band power measurement function with band limits set equal to the EBW (or occupied bandwidth) band edges. If the instrument does not have a band power function, sum the spectrum

7.3 DEVIATION FROM STANDARD

No deviation.

7.4 TEST SETUP

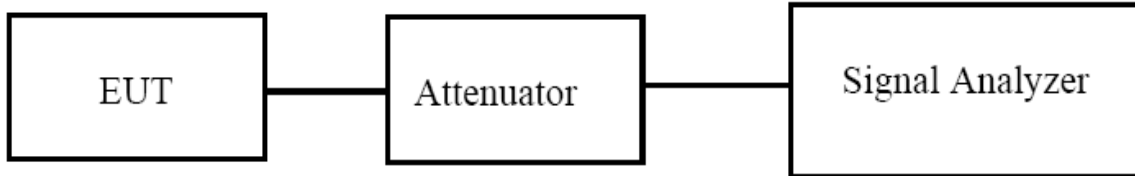

7.5 EUT OPERATION CONDITIONS

The EUT tested system was configured as the statements of 2.4 Unless otherwise a special operating condition is specified in the follows during the testing.

7.6 TEST RESULTS

EUT :	Mobile Phone	Model Name. :	GQ3081
Temperature :	25 °C	Relative Humidity :	60%
Pressure :	1012 hPa	Test Voltage :	DC 3.85V
Test Mode :	TX (5G) Mode Frequency Band 1 (5150-5250MHz)		

Test Channel	Frequency	Maximum output power. Antenna port (AV)	LIMIT	Result
	(MHz)	(dBm)	dBm	
TX 802.11a Mode				
CH36	5180	10.5	23.98	Pass
CH40	5200	10.6	23.98	Pass
CH48	5240	10.6	23.98	Pass
TX 802.11 n20M Mode				
CH36	5180	10.3	23.98	Pass
CH40	5200	10.2	23.98	Pass
CH48	5240	10.8	23.98	Pass
TX 802.11 n40M Mode				
CH38	5190	10.3	23.98	Pass
CH46	5230	10.5	23.98	Pass
TX 802.11 ac20M Mode				
CH36	5180	10.3	23.98	Pass
CH40	5200	10.6	23.98	Pass
CH48	5240	10.6	23.98	Pass
TX 802.11 ac40M Mode				
CH38	5190	10.1	23.98	Pass
CH46	5230	10.7	23.98	Pass
TX 802.11 ac80M Mode				
CH42	5210	9.6	23.98	Pass

EUT :	Mobile Phone	Model Name. :	GQ3081
Temperature :	25 °C	Relative Humidity :	60%
Pressure :	1012 hPa	Test Voltage :	DC 3.85V
Test Mode :	TX (5G) Mode Frequency Band IV (5725-5850MHz)		

Test Channel	Frequency	Maximum output power. Antenna port (AV)	LIMIT	Result
	(MHz)	(dBm)	dBm	
TX 802.11a Mode				
CH149	5745	8.5	30.00	Pass
CH157	5785	9.2	30.00	Pass
CH165	5825	10.0	30.00	Pass
TX 802.11 n20M Mode				
CH149	5745	8.2	30.00	Pass
CH157	5785	8.8	30.00	Pass
CH165	5825	9.8	30.00	Pass
TX 802.11 n40M Mode				
CH151	5755	8.5	30.00	Pass
CH159	5795	9.0	30.00	Pass
TX 802.11 ac20M Mode				
CH149	5745	8.3	30.00	Pass
CH157	5785	8.6	30.00	Pass
CH165	5825	9.2	30.00	Pass
TX 802.11 ac40M Mode				
CH151	5755	8.4	30.00	Pass
CH159	5795	8.9	30.00	Pass
TX 802.11 ac80M Mode				
CH155	5775	7.9	30.00	Pass

8. OUT OF BAND EMISSIONS

8.1 APPLICABLE STANDARD

According to FCC §15.407(b)

Undesirable emission limits. Except as shown in paragraph (b)(7) of this section, the maximum emissions outside of the frequency bands of operation shall be attenuated in accordance with the following limits:

- (1) For transmitters operating in the 5.15-5.25 GHz band: All emissions outside of the 5.15-5.35 GHz band shall not exceed an e.i.r.p. of -27 dBm/MHz.
- (2) For transmitters operating in the 5.25-5.35 GHz band: All emissions outside of the 5.15-5.35 GHz band shall not exceed an e.i.r.p. of -27 dBm/MHz.
- (3) For transmitters operating in the 5.47-5.725 GHz band: All emissions outside of the 5.47-5.725 GHz band shall not exceed an e.i.r.p. of -27 dBm/MHz.
- (4) For transmitters operating in the 5.725-5.85 GHz band: All emissions shall be limited to a level of -27 dBm/MHz at 75 MHz or more above or below the band edge increasing linearly to 10 dBm/MHz at 25 MHz above or below the band edge, and from 25 MHz above or below the band edge increasing linearly to a level of 15.6 dBm/MHz at 5 MHz above or below the band edge, and from 5 MHz above or below the band edge increasing linearly to a level of 27 dBm/MHz at the band edge.

8.2 TEST PROCEDURE

1. Check the calibration of the measuring instrument using either an internal calibrator or a known signal from an external generator.
2. Position the EUT without connection to measurement instrument. Turn on the EUT and connect its antenna terminal to measurement instrument via a low loss cable. Then set it to any one measured frequency within its operating range, and make sure the instrument is operated in its linear range.
3. Set RBW of spectrum analyzer to 1 MHz with a convenient frequency span.
4. Measure the highest amplitude appearing on spectral display and set it as a reference level. Plot the graph with marking the highest point and edge frequency.
5. Repeat above procedures until all measured frequencies were complete.

8.3 DEVIATION FROM STANDARD

No deviation.

8.4 TEST SETUP

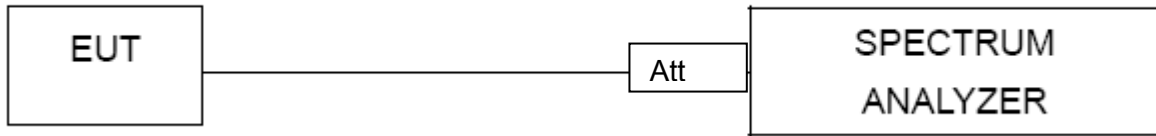

8.5 EUT OPERATION CONDITIONS

The EUT tested system was configured as the statements of 2.4 Unless otherwise a special operating condition is specified in the follows during the testing.

8.6 TEST RESULTS

EUT :	Mobile Phone	Model Name. :	GQ3081
Temperature :	25 °C	Relative Humidity :	56%
Pressure :	1012 hPa	Test Voltage :	DC 3.85V

5.2G

5.15~5.25 GHz

(802.11a) Band Edge, Left Side

(802.11n20) Band Edge, Left Side

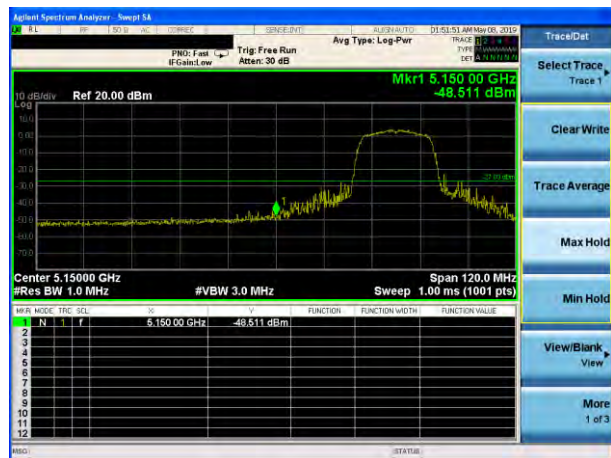
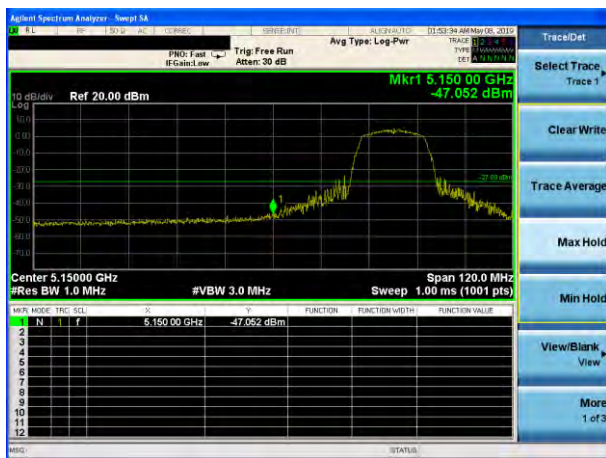

(802.11a) Band Edge, Right Side

(802.11n20) Band Edge, Right Side

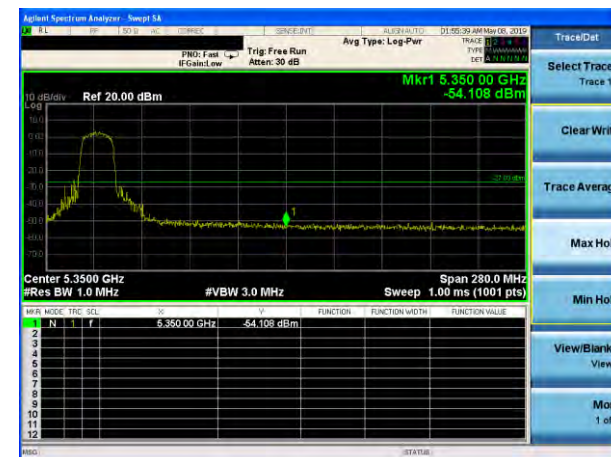
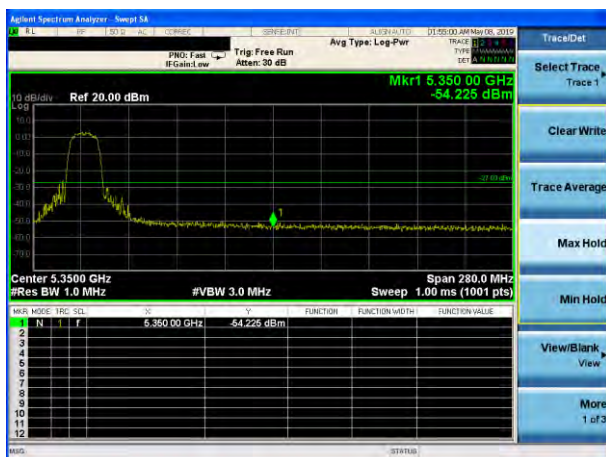

5.15~5.25 GHz

(802.11n40) Band Edge, Left Side



(802.11ac20) Band Edge, Left Side

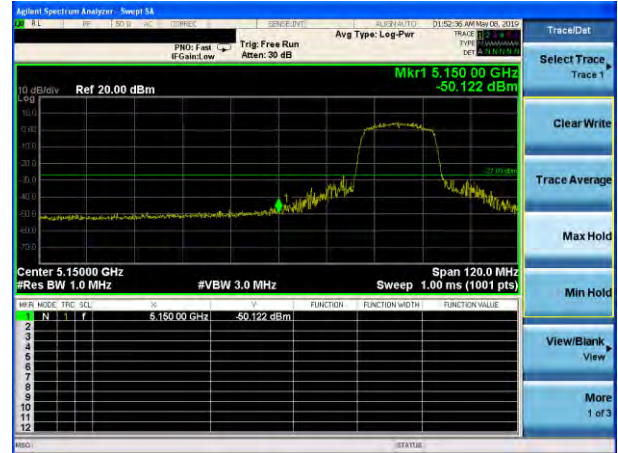

(802.11n40) Band Edge, Right Side



(802.11ac20) Band Edge, Right Side



5.15~5.25 GHz

(802.11ac40) Band Edge, Left Side

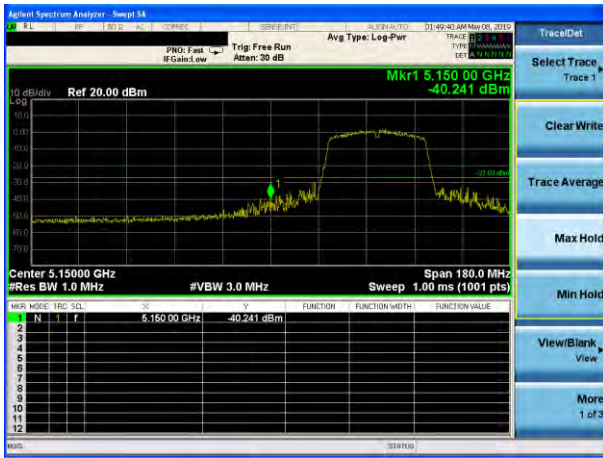

(802.11ac80) Band Edge, Left Side

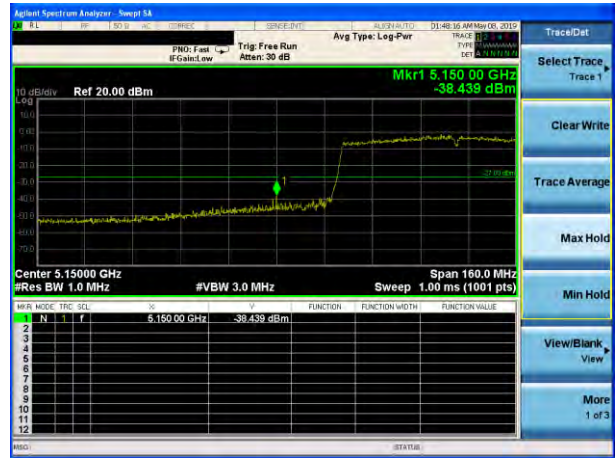

(802.11ac40) Band Edge, Right Side

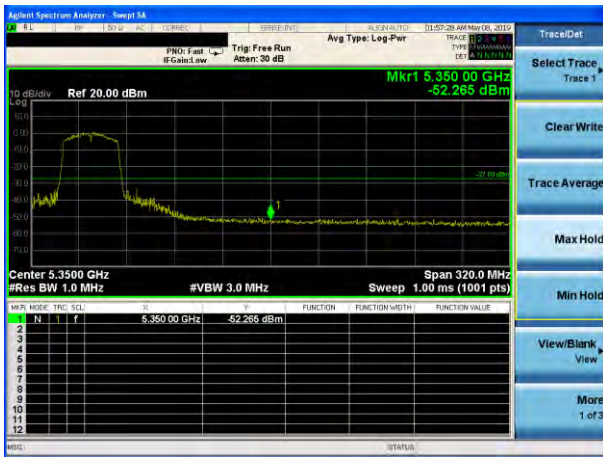

(802.11ac80) Band Edge, Right Side

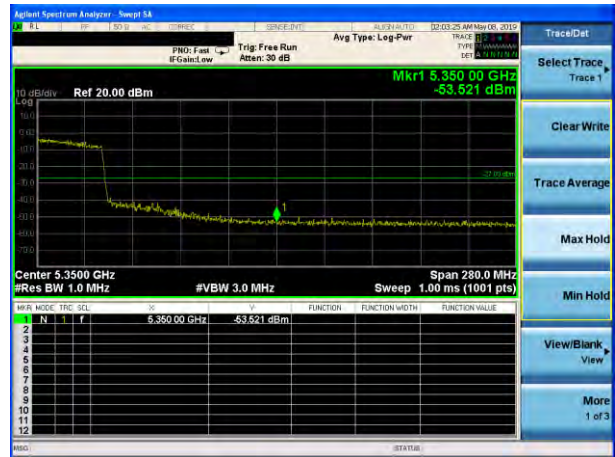

5.8G

5.725~5.850 GHz

(802.11a) Band Edge, Left Side

(802.11n20) Band Edge, Left Side

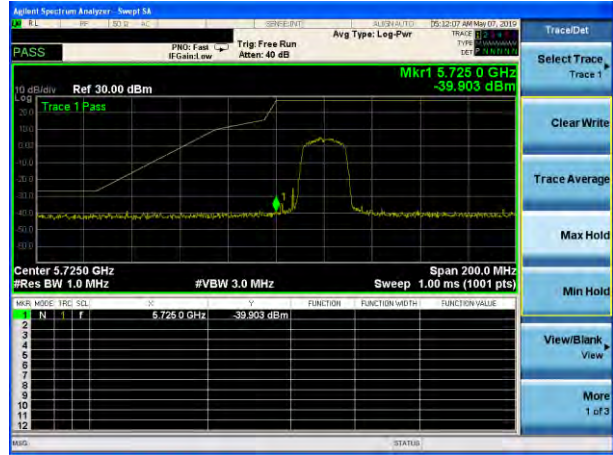
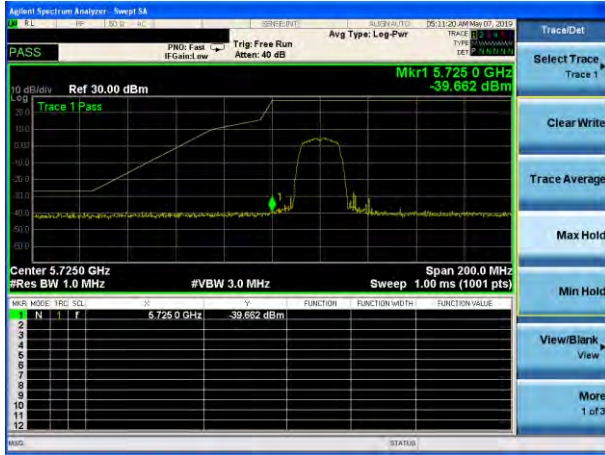

(802.11a) Band Edge, Right Side

(802.11n20) Band Edge, Right Side

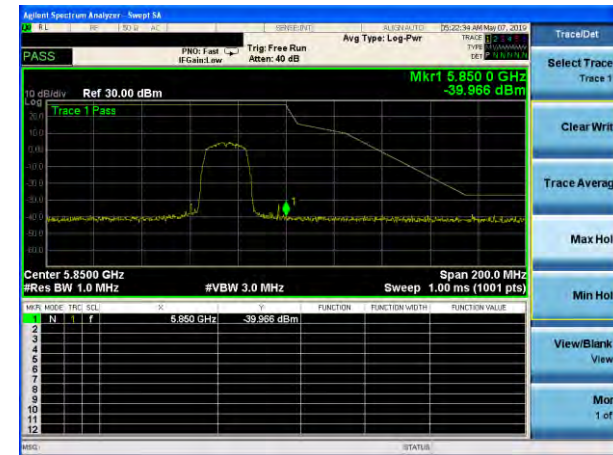
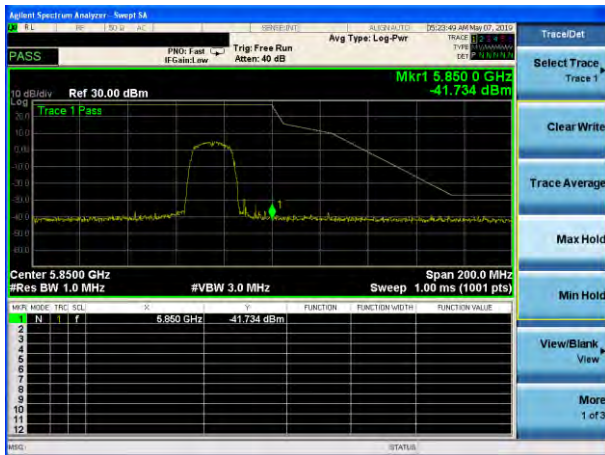

5.725~5.850 GHz

(802.11n40) Band Edge, Left Side

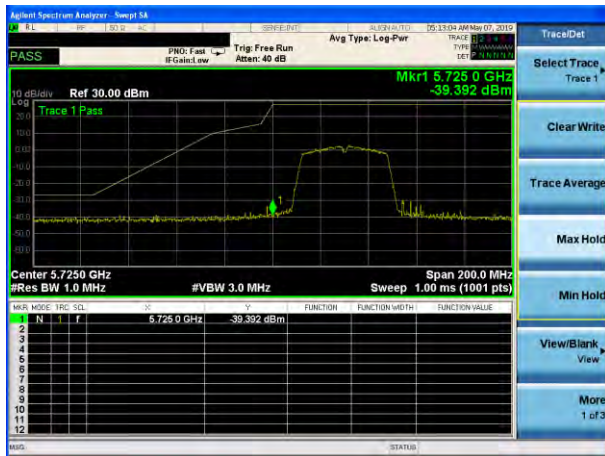

(802.11ac20) Band Edge, Left Side

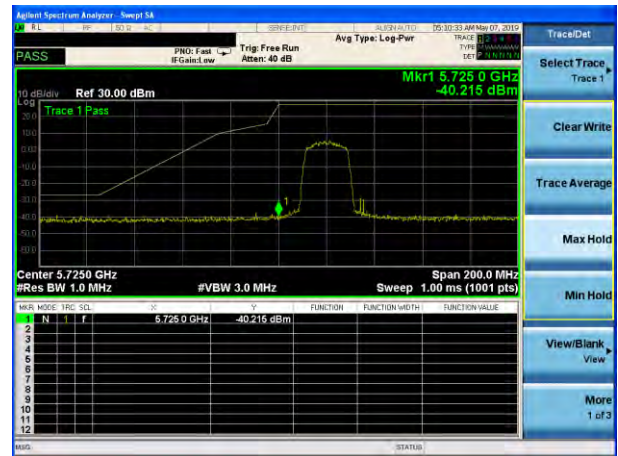

(802.11n40) Band Edge, Right Side

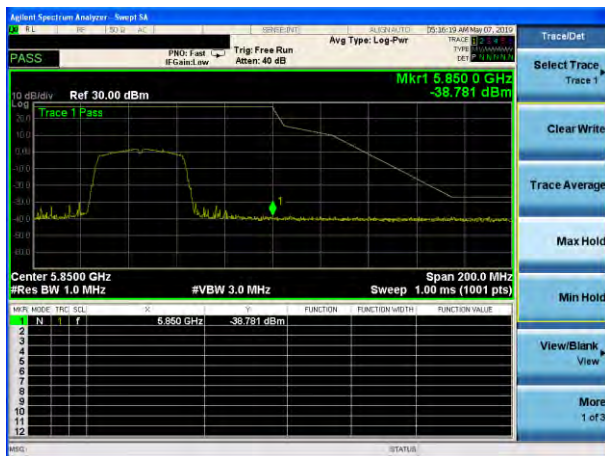

(802.11ac20) Band Edge, Right Side

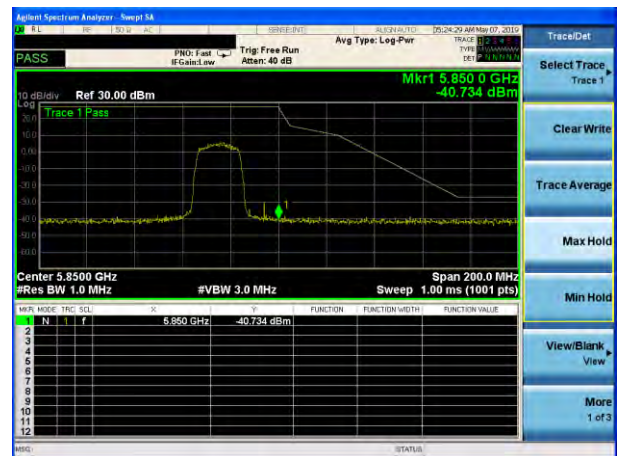

5.725~5.850 GHz

(802.11ac40) Band Edge, Left Side

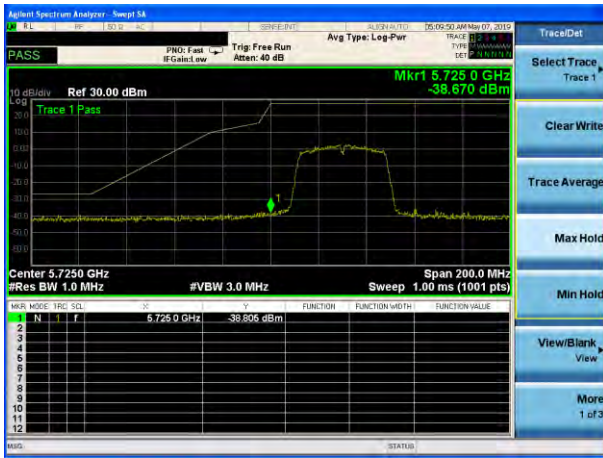

(802.11ac80) Band Edge, Left Side



(802.11ac40) Band Edge, Right Side

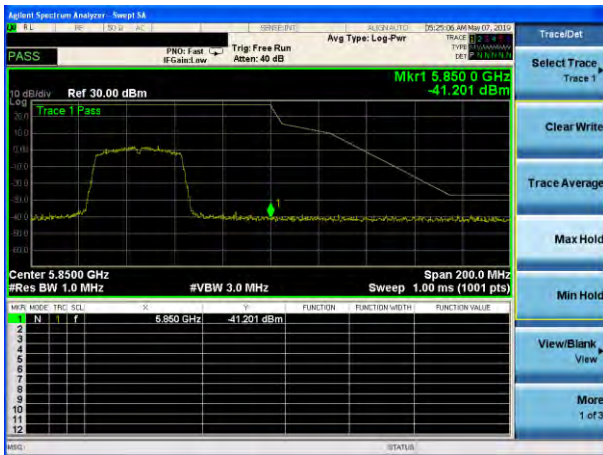

(802.11ac80) Band Edge, Right Side



9.SPURIOUS RF CONDUCTED EMISSIONS

9.1CONFORMANCE LIMIT

1. Below -20dB of the highest emission level in operating band.
2. Fall in the restricted bands listed in section 15.205. The maximum permitted average field strength is listed in section 15.209.

9.2MEASURING INSTRUMENTS

The Measuring equipment is listed in the section 6.3 of this test report.

9.3TEST SETUP

Please refer to Section 6.1 of this test report.

9.4TEST PROCEDURE

The Spurious RF conducted emissions compliance of RF radiated emission should be measured by following the guidance in ANSI C63.10-2013 with respect to maximizing the emission by rotating the EUT, measuring the emission while the EUT is situated in three orthogonal planes (if appropriate), adjusting the measurement antenna height and polarization etc. Set RBW=100kHz and VBW= 300KHz to measure the peak field strength , and mwasure frequeny range from 9KHz to 26.5GHz.

9.5TEST RESULTS

Remark: The measurement frequency range is from 9KHz to the 10th harmonic of the fundamental frequency. The lowest, middle and highest channels are tested to verify the spurious emissions and bandege measurement data.

5.2G
Test Plot

802.11a on channel 36

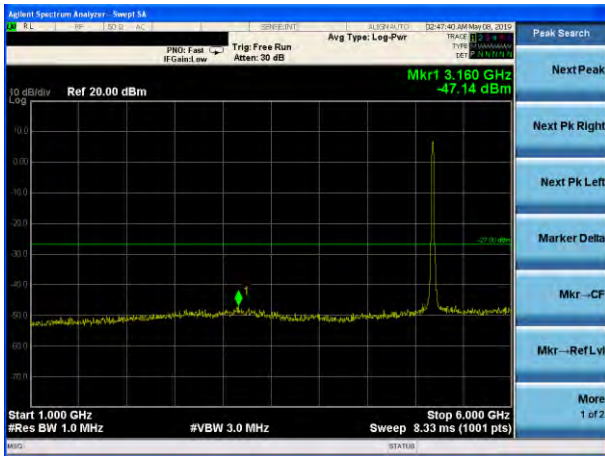

802.11n20 on channel 36

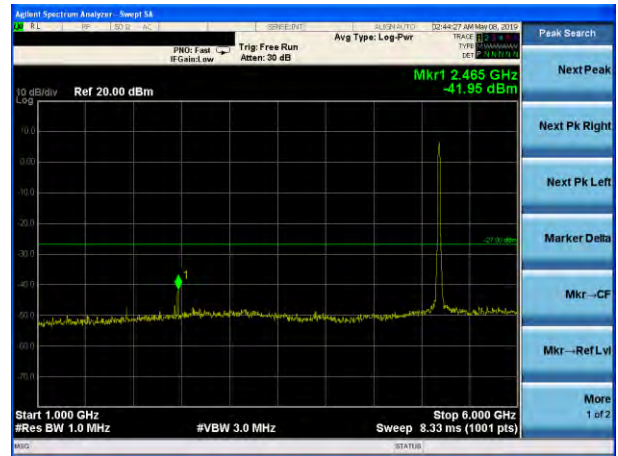

802.11a on channel 36



802.11n20 on channel 36



Note: Pre-test all modes and channels, only the worst data is recorded in the report

Test Plot

802.11n40 on channel 38

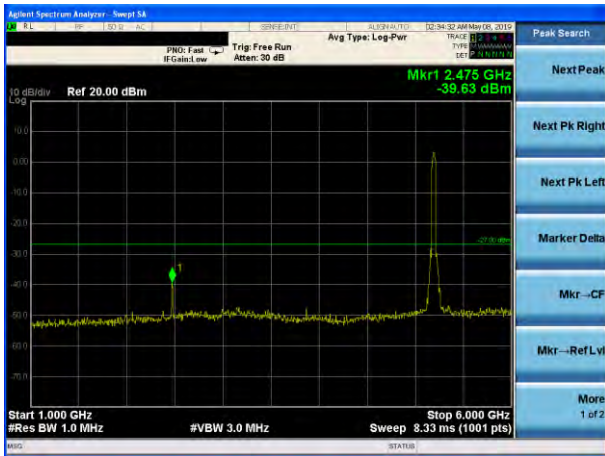

802.11ac20 on channel 36

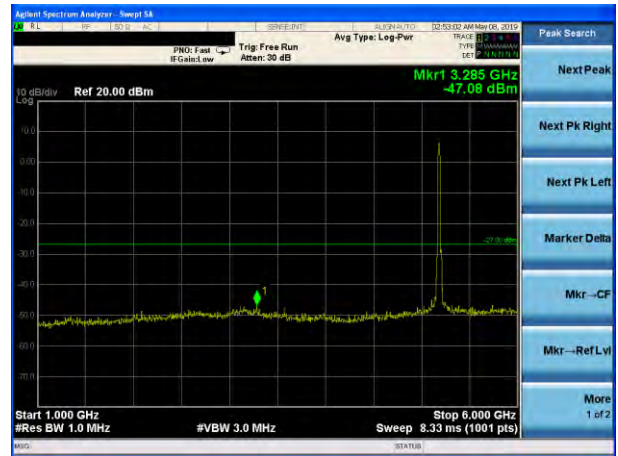

802.11n40 on channel 38



802.11ac20 on channel 36



Note: Pre-test all modes and channels, only the worst data is recorded in the report

Test Plot

802.11ac40 on channel 38

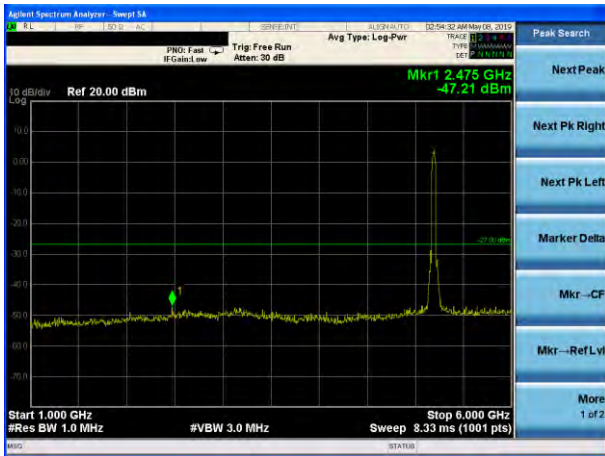

802.11ac80 on channel 42

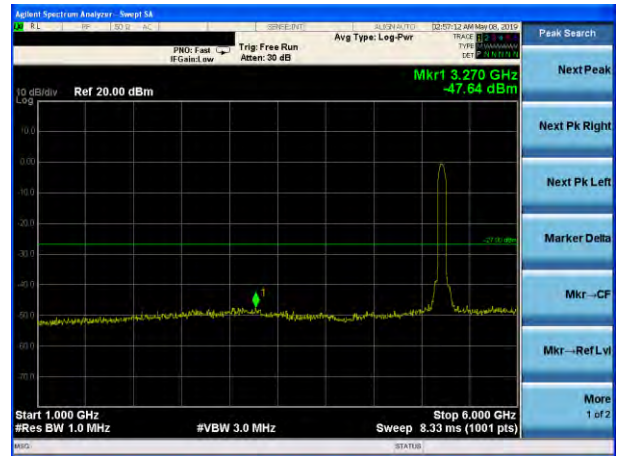

802.11ac40 on channel 38



802.11ac80 on channel 42



Note: Pre-test all modes and channels, only the worst data is recorded in the report

5.8G
Test Plot

802.11a on channel 149

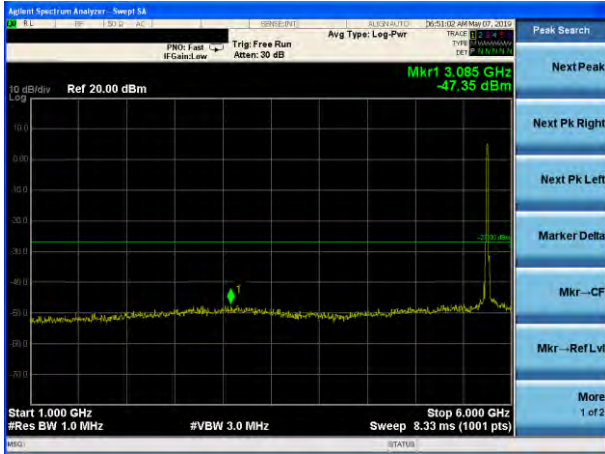

802.11n20 on channel 149

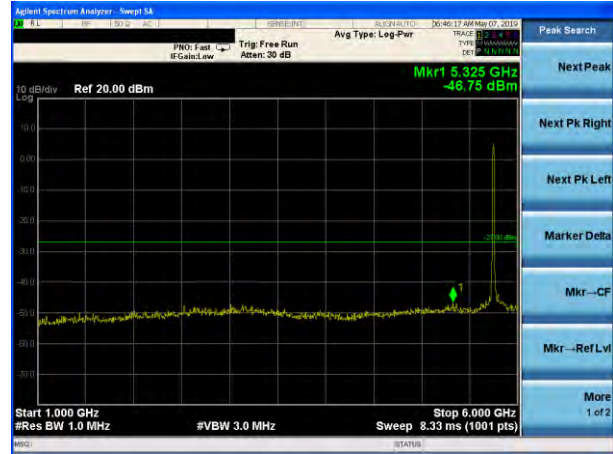

802.11a on channel 149



802.11n20 on channel 149



Note: Pre-test all modes and channels, only the worst data is recorded in the report

Test Plot

802.11n40 on channel 151

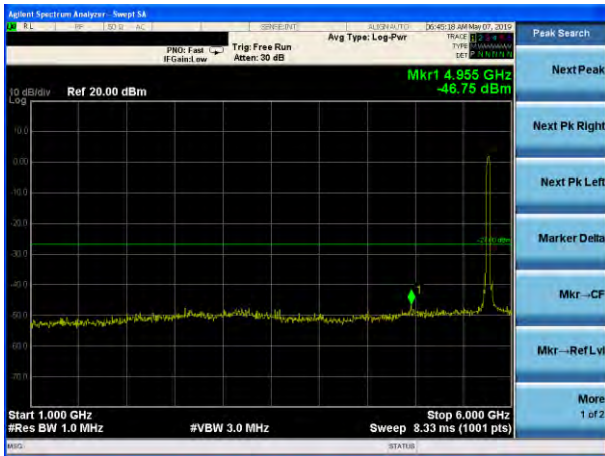

802.11ac20 on channel 149

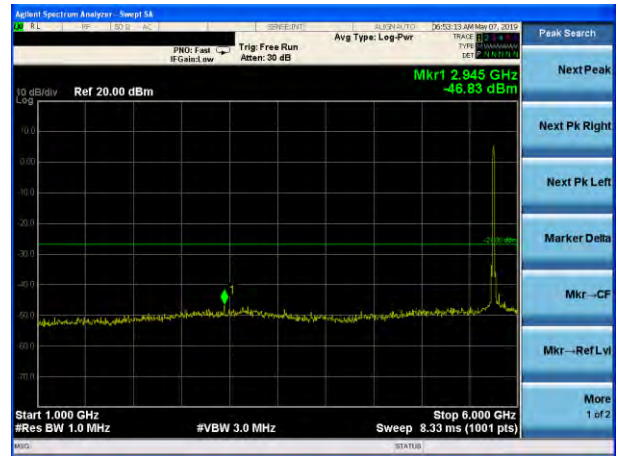

802.11n40 on channel 151



802.11ac20 on channel 149



Note: Pre-test all modes and channels, only the worst data is recorded in the report

Test Plot

802.11ac40 on channel 151

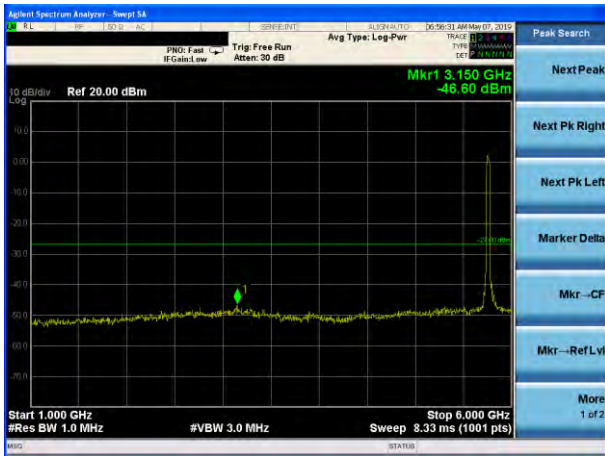

802.11ac80 on channel 155



802.11ac40 on channel 151



802.11ac80 on channel 155



Note: Pre-test all modes and channels, only the worst data is recorded in the report

10. FREQUENCY STABILITY MEASUREMENT

10.1 LIMIT

Manufactures of U-NII devices are responsible for ensuring frequency stability such that an emission is maintained within the band of operation under all conditions of normal operation as specified in the user's manual.

The transmitter center frequency tolerance shall be ± 20 ppm maximum for the 5 GHz band (IEEE 802.11n specification).

10.2 TEST PROCEDURES

1. The transmitter output (antenna port) was connected to the spectrum analyzer.
2. EUT have transmitted absence of modulation signal and fixed channelize.
3. Set the spectrum analyzer span to view the entire absence of modulation emissions bandwidth.
4. Set RBW = 10 kHz, VBW = 10 kHz with peak detector and maxhold settings.
5. f_c is declaring of channel frequency. Then the frequency error formula is $(f_c - f) / f_c \times 10^6$ ppm and the limit is less than ± 20 ppm (IEEE 802.11n specification).
6. The test extreme voltage is to change the primary supply voltage from 85 to 115 percent of the nominal value
7. Extreme temperature is $-20^{\circ}\text{C} \sim 70^{\circ}\text{C}$.

10.3 TEST SETUP LAYOUT

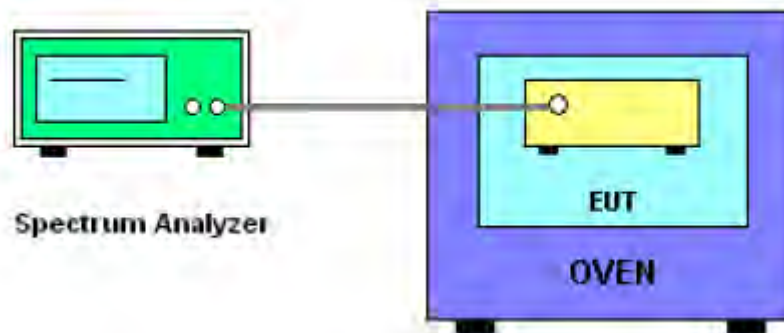

10.4 EUT OPERATION DURING TEST

The EUT was programmed to be in continuously un-modulation transmitting mode.

10.5 TEST RESULTS

EUT :	Mobile Phone	Model Name. :	GQ3081
Temperature :	25 °C	Relative Humidity :	56%
Pressure :	1012 hPa	Test Voltage :	DC 3.85V
Test Mode :	TX Frequency Band I (5150-5250MHz)		

Voltage vs. Frequency Stability

TEST CONDITIONS				Reference Frequency: 5180MHz			
				f	fc	Max. Deviation (MHz)	Max. Deviation (ppm)
T nom (°C)	20	V nom (V)	3.85	5180.0324	5180	0.0324	-6.2548
		V max (V)	4.20	5180.0271	5180	0.0271	-5.2317
		V min (V)	3.40	5180.0203	5180	0.0203	-3.9189
Limits				± 20 ppm			
Result				Complies			

Temperature vs. Frequency Stability

TEST CONDITIONS				Reference Frequency: 5180MHz			
				f	fc	Max. Deviation (MHz)	Max. Deviation (ppm)
V nom (V)	3.85	T (°C)	-20	5180.0312	5180	0.0312	-6.0232
		T (°C)	-10	5180.0317	5180	0.0317	-6.1197
		T (°C)	0	5180.0309	5180	0.0309	-5.9653
		T (°C)	10	5180.0299	5180	0.0299	-5.7722
		T (°C)	20	5180.0222	5180	0.0222	-4.2857
		T (°C)	30	5180.0324	5180	0.0324	-6.2548
		T (°C)	40	5180.0517	5180	0.0517	-9.9807
		T (°C)	50	5180.0416	5180	0.0416	-8.0309
		T (°C)	60	5180.0213	5180	0.0213	-4.1120
		T (°C)	70	5180.0311	5180	0.0311	-6.0039
Limits				± 20 ppm			
Result				Complies			

Voltage vs. Frequency Stability

TEST CONDITIONS				Reference Frequency: 5200MHz			
				f	fc	Max. Deviation (MHz)	Max. Deviation (ppm)
T nom (°C)	20	V nom (V)	3.85	5200.0203	5200	0.0203	-3.9038
		V max (V)	4.20	5200.0219	5200	0.0219	-4.2115
		V min (V)	3.40	5200.0218	5200	0.0218	-4.1923
Limits				± 20 ppm			
Result				Complies			

Temperature vs. Frequency Stability

TEST CONDITIONS				Reference Frequency: 5200MHz			
				f	fc	Max. Deviation (MHz)	Max. Deviation (ppm)
V nom (V)	3.85	T (°C)	-20	5200.0213	5200	0.0213	-4.0962
		T (°C)	-10	5200.0214	5200	0.0214	-4.1154
		T (°C)	0	5200.0224	5200	0.0224	-4.3077
		T (°C)	10	5200.0196	5200	0.0196	-3.7692
		T (°C)	20	5200.0312	5200	0.0312	-6.0000
		T (°C)	30	5200.0217	5200	0.0217	-4.1731
		T (°C)	40	5200.0214	5200	0.0214	-4.1154
		T (°C)	50	5200.0208	5200	0.0208	-4.0000
		T (°C)	60	5200.0213	5200	0.0213	-4.0962
		T (°C)	70	5200.0220	5200	0.0220	-4.2308
Limits				± 20 ppm			
Result				Complies			

Voltage vs. Frequency Stability

TEST CONDITIONS				Reference Frequency: 5240MHz			
				f	fc	Max. Deviation (MHz)	Max. Deviation (ppm)
T nom (°C)	20	V nom (V)	3.85	5240.0351	5240	0.0351	-6.6985
		V max (V)	4.20	5240.0327	5240	0.0327	-6.2405
		V min (V)	3.40	5240.0336	5240	0.0336	-6.4122
Limits				± 20 ppm			
Result				Complies			

Temperature vs. Frequency Stability

TEST CONDITIONS				Reference Frequency: 5240MHz			
				f	fc	Max. Deviation (MHz)	Max. Deviation (ppm)
V nom (V)	3.85	T (°C)	-20	5240.0318	5240	0.0318	-6.0687
		T (°C)	-10	5240.0317	5240	0.0317	-6.0496
		T (°C)	0	5240.0325	5240	0.0325	-6.2023
		T (°C)	10	5240.0308	5240	0.0308	-5.8779
		T (°C)	20	5240.0319	5240	0.0319	-6.0878
		T (°C)	30	5240.0336	5240	0.0336	-6.4122
		T (°C)	40	5240.0328	5240	0.0328	-6.2595
		T (°C)	50	5240.0309	5240	0.0309	-5.8969
		T (°C)	60	5240.0303	5240	0.0303	-5.7824
		T (°C)	70	5240.0315	5240	0.0315	-6.0115
Limits				± 20 ppm			
Result				Complies			

EUT :	Mobile Phone	Model Name. :	GQ3081
Temperature :	25 °C	Relative Humidity :	56%
Pressure :	1012 hPa	Test Voltage :	DC 3.85V
Test Mode :	TX Frequency Band IV (5725-5850MHz)		

Voltage vs. Frequency Stability

TEST CONDITIONS				Reference Frequency: 5745MHz			
				f	fc	Max. Deviation (MHz)	Max. Deviation (ppm)
T nom (°C)	20	V nom (V)	3.85	5745.00909	5745	0.00909	-1.5815
		V max (V)	4.20	5745.00008	5745	0.00008	-0.0147
		V min (V)	3.40	5745.00572	5745	0.00572	-0.9953
Limits				± 20 ppm			
Result				Complies			

Temperature vs. Frequency Stability

TEST CONDITIONS				Reference Frequency: 5745MHz			
				f	fc	Max. Deviation (MHz)	Max. Deviation (ppm)
V nom (V)	3.85	T (°C)	-20	5745.01219	5745	0.01219	-2.1214
		T (°C)	-10	5745.00015	5745	0.00015	-0.0258
		T (°C)	0	5745.00571	5745	0.00571	-0.9933
		T (°C)	10	5745.01309	5745	0.01309	-2.2793
		T (°C)	20	5745.00897	5745	0.00897	-1.5608
		T (°C)	30	5745.00650	5745	0.00650	-1.1322
		T (°C)	40	5745.00535	5745	0.00535	-0.9316
		T (°C)	50	5745.01027	5745	0.01027	-1.7869
		T (°C)	60	5745.01112	5745	0.01112	-1.9350
		T (°C)	70	5745.00963	5745	0.00963	-1.6757
Limits				± 20 ppm			
Result				Complies			

Voltage vs. Frequency Stability

TEST CONDITIONS				Reference Frequency: 5785MHz			
				f	fc	Max. Deviation (MHz)	Max. Deviation (ppm)
T nom (°C)	20	V nom (V)	3.85	5785.01335	5785	0.01335	-2.3080
		V max (V)	4.20	5785.00290	5785	0.00290	-0.5006
		V min (V)	3.40	5785.00032	5785	0.00032	-0.0554
Limits				± 20 ppm			
Result				Complies			

Temperature vs. Frequency Stability

TEST CONDITIONS				Reference Frequency: 5785MHz			
				f	fc	Max. Deviation (MHz)	Max. Deviation (ppm)
V nom (V)	3.85	T (°C)	-20	5785.00178	5785	0.00178	-0.3071
		T (°C)	-10	5785.01180	5785	0.01180	-2.0401
		T (°C)	0	5785.00914	5785	0.00914	-1.5802
		T (°C)	10	5785.01175	5785	0.01175	-2.0313
		T (°C)	20	5785.00013	5785	0.00013	-0.0221
		T (°C)	30	5785.00257	5785	0.00257	-0.4441
		T (°C)	40	5785.00593	5785	0.00593	-1.0253
		T (°C)	50	5785.00418	5785	0.00418	-0.7228
		T (°C)	60	5785.00783	5785	0.00783	-1.3536
		T (°C)	70	5785.00650	5785	0.00650	-1.1240
Limits				± 20 ppm			
Result				Complies			

Voltage vs. Frequency Stability

TEST CONDITIONS				Reference Frequency: 5825MHz			
				f	fc	Max. Deviation (MHz)	Max. Deviation (ppm)
T nom (°C)	20	V nom (V)	3.85	5825.00688	5825	0.00688	-1.1819
		V max (V)	4.20	5825.00658	5825	0.00658	-1.1300
		V min (V)	3.40	5825.01178	5825	0.01178	-2.0218
Limits				± 20 ppm			
Result				Complies			

Temperature vs. Frequency Stability

TEST CONDITIONS				Reference Frequency: 5825MHz			
				f	fc	Max. Deviation (MHz)	Max. Deviation (ppm)
V nom (V)	3.85	T (°C)	-20	5825.00880	5825	0.00880	-1.5101
		T (°C)	-10	5825.00175	5825	0.00175	-0.3012
		T (°C)	0	5825.00194	5825	0.00194	-0.3335
		T (°C)	10	5825.00014	5825	0.00014	-0.0243
		T (°C)	20	5825.00232	5825	0.00232	-0.3979
		T (°C)	30	5825.00384	5825	0.00384	-0.6595
		T (°C)	40	5825.00637	5825	0.00637	-1.0935
		T (°C)	50	5825.01257	5825	0.01257	-2.1574
		T (°C)	60	5825.00537	5825	0.00537	-0.9219
		T (°C)	70	5825.00030	5825	0.00030	-0.0520
Limits				± 20 ppm			
Result				Complies			

11. ANTENNA REQUIREMENT

11.1 STANDARD REQUIREMENT

15.203 requirement: For intentional device, according to 15.203: an intentional radiator shall be designed to ensure that no antenna other than that furnished by the responsible party shall be used with the device.

11.2 EUT ANTENNA

The EUT antenna is permanent attached PIFA antenna (antenna gain: 1dBi). It comply with the standard requirement.

END OF REPORT