

# FCC RADIO TEST REPORT

## FCC ID: 2AOWK3081

**Product:** Mobile Phone

**Trade Mark:** ulefone

**Model No.:** GQ3081

**Family Model:** Power 6, Power 6S, Power 6X,  
Power 6E, Power 6 Pro, Power 6 Plus

**Report No.:** S19040800205005

**Issue Date:** 05 Jun. 2019

### Prepared for

Shenzhen Gotron Electronic CO.,LTD.  
518, 5F, R&D building, Tsinghua Hi-Tech park, Nanshan district,  
Shenzhen 518057 P.R.China

### Prepared by

Shenzhen NTEK Testing Technology Co., Ltd.  
1/F, Building E, Fenda Science Park, Sanwei Community,  
Xixiang Street Bao'an District, Shenzhen P.R. China  
Tel.: +86-755-6115 6588  
Fax.: +86-755-6115 6599  
Website:<http://www.ntek.org.cn>

**TABLE OF CONTENTS**

<b>1</b>	<b>TEST RESULT CERTIFICATION .....</b>	<b>3</b>
<b>2</b>	<b>SUMMARY OF TEST RESULTS.....</b>	<b>4</b>
<b>3</b>	<b>FACILITIES AND ACCREDITATIONS .....</b>	<b>5</b>
3.1	FACILITIES.....	5
3.2	LABORATORY ACCREDITATIONS AND LISTINGS .....	5
3.3	MEASUREMENT UNCERTAINTY .....	5
<b>4</b>	<b>GENERAL DESCRIPTION OF EUT .....</b>	<b>6</b>
<b>5</b>	<b>DESCRIPTION OF TEST MODES .....</b>	<b>8</b>
<b>6</b>	<b>SETUP OF EQUIPMENT UNDER TEST .....</b>	<b>9</b>
6.1	BLOCK DIAGRAM CONFIGURATION OF TEST SYSTEM.....	9
6.2	SUPPORT EQUIPMENT.....	10
6.3	EQUIPMENTS LIST FOR ALL TEST ITEMS.....	11
<b>7</b>	<b>TEST REQUIREMENTS .....</b>	<b>12</b>
7.1	FIELD STRENGTH OF SPURIOUS RADIATION .....	12
7.2	EFFECTIVE RADIATED POWER AND EFFECTIVE ISOTROPIC RADIATED POWER.....	23
7.3	CONDUCTED OUTPUT POWER .....	29
7.4	FREQUENCY STABILITY .....	35
7.5	PEAK-TO-AVERAGE RATIO .....	42
7.6	26DB BANDWIDTH AND 99% OCCUPIED BANDWIDTH .....	49
7.7	CONDUCTED BAND EDGE .....	56
7.8	CONDUCTED SPURIOUS EMISSION AT ANTENNA TERMINAL .....	62

**1 TEST RESULT CERTIFICATION**

Applicant's name .....	Shenzhen Gotron Electronic CO.,LTD.
Address .....	518, 5F, R&D building, Tsinghua Hi-Tech park, Nanshan district, Shenzhen 518057 P.R.China
Manufacturer's Name .....	Shenzhen Gotron Electronic CO.,LTD.
Address .....	518, 5F, R&D building, Tsinghua Hi-Tech park, Nanshan district, Shenzhen 518057 P.R.China
Product description	
Product name .....	Mobile Phone
Model and/or type reference .....	GQ3081
Family Model .....	Power 6, Power 6S, Power 6X, Power 6E, Power 6 Pro, Power 6 Plus

Measurement Procedure Used:

APPLICABLE STANDARDS	
APPLICABLE STANDARD/ TEST PROCEDURE	TEST RESULT
47 CFR Part 2, Part 22H, Part 24E, Part 27L ANSI/TIA-603-E-2016 FCC KDB 971168 D01 Power Meas License Digital Systems v03 ANSI C63.26:2015	Complied

This device described above has been tested by Shenzhen NTEK Testing Technology Co., Ltd., and the test results show that the equipment under test (EUT) is in compliance with the FCC requirements. And it is applicable only to the tested sample identified in the report.

This report shall not be reproduced except in full, without the written approval of Shenzhen NTEK Testing Technology Co., Ltd., this document may be altered or revised by Shenzhen NTEK Testing Technology Co., Ltd., personnel only, and shall be noted in the revision of the document.

The test results of this report relate only to the tested sample identified in this report.

Date of Test : Apr. 10, 2019 ~ May. 17, 2019

Testing Engineer : *Cheng Jiawen*  
(Cheng Jiawen)

Technical Manager : *Jason chen*  
(Jason Chen)

Authorized Signatory : *Sam. Chen*  
(Sam Chen)

## 2 SUMMARY OF TEST RESULTS

### FCC Part22, Subpart H/ FCC Part24, Subpart E, FCC Part27, Subpart L, KDB 971168 D01 Power Meas License Digital Systems v03

FCC Rule	Test Item	Verdict	Remark
2.1046	Conducted Output Power	PASS	
24.232(d) KDB 971168 D01 Clause 5.7	Peak-to-Average Ratio	PASS	
2.1049 22.917(b) 24.238(b) KDB 971168 D01 Clause 4.2	Occupied Bandwidth	PASS	
2.1051 22.917(a) 24.238(a) KDB 971168 D01 Clause 6	Band Edge	PASS	
22.913(a)(2) KDB 971168 D01 Clause 5.6	Effective Radiated Power	PASS	
24.232(c) KDB 971168 D01 Clause 5.6	Equivalent Isotropic Radiated Power	PASS	
2.1053 22.917(a) 24.238(a) KDB 971168 D01 Clause 7	Field Strength of Spurious Radiation	PASS	
2.1055 22.355 24.235 KDB 971168 D01 Clause 9	Frequency Stability for Temperature & Voltage	PASS	
2.1051 22.917(a) 24.238(a) KDB 971168 D01 Clause 6	Conducted Emission	PASS	

Remark:

1. "N/A" denotes test is not applicable in this Test Report.
2. All test items were verified and recorded according to the standards and without any deviation during the test.
3. No modifications are made to the EUT during all test items.

### 3 FACILITIES AND ACCREDITATIONS

#### 3.1 FACILITIES

All measurement facilities used to collect the measurement data are located at 1/F, Building E, Fenda Science Park, Sanwei Community, Xixiang Street, Bao'an District, Shenzhen 518126 P.R. China.

The sites are constructed in conformance with the requirements of ANSI C63.7, ANSI C63.10 and CISPR Publication 22.

#### 3.2 LABORATORY ACCREDITATIONS AND LISTINGS

Site Description

CNAS-Lab. : The Laboratory has been assessed and proved to be in compliance with CNAS-CL01:2006 (identical to ISO/IEC 17025:2005)  
The Certificate Registration Number is L5516.

IC-Registration : The Certificate Registration Number is 9270A-1.

FCC- Accredited : Test Firm Registration Number: 463705.  
Designation Number: CN1184

A2LA-Lab. : The Certificate Registration Number is 4298.01  
This laboratory is accredited in accordance with the recognized International Standard ISO/IEC 17025:2005 General requirements for the competence of testing and calibration laboratories.  
This accreditation demonstrates technical competence for a defined scope and the operation of a laboratory quality management system (refer to joint ISO-ILAC-IAF Communiqué dated 8 January 2009).

Name of Firm : Shenzhen NTEK Testing Technology Co., Ltd.

Site Location : 1/F, Building E, Fenda Science Park, Sanwei Community, Xixiang Street, Bao'an District, Shenzhen 518126 P.R. China.

#### 3.3 MEASUREMENT UNCERTAINTY

The reported uncertainty of measurement, where expanded uncertainty U is based on a standard uncertainty multiplied by a coverage factor of k=2, providing a level of confidence of approximately 95 %.

No.	Item	Uncertainty
1	Measuring Uncertainty for a Level of Confidence of 95% (U = 2Uc(y))	2.5dB

#### 4 GENERAL DESCRIPTION OF EUT

Product Feature and Specification	
Equipment	Mobile Phone
Trade Mark	ulefone
FCC ID	2AOWK3081
Model No.	GQ3081
Family Model	Power 6, Power 6S, Power 6X, Power 6E, Power 6 Pro, Power 6 Plus
Model Difference	All models are the same circuit and RF module, except the model name.
Operating Frequency	<input checked="" type="checkbox"/> GSM850: TX824.2MHz~848.8MHz /RX869.2MHz~893.8MHz; <input checked="" type="checkbox"/> UMTS FDD Band V: TX826.4MHz~846.6MHz /RX871.4MHz~891.6MHz; <input checked="" type="checkbox"/> PCS1900: TX1850.2MHz~1909.8MHz /RX1930.2MHz~1989.8MHz; <input checked="" type="checkbox"/> UMTS FDD Band II: TX1852.4MHz~1907.6MHz /RX1932.4MHz~1987.6MHz; <input checked="" type="checkbox"/> UMTS-FDD Band IV:TX1710MHz~1755MHz /RX2110MHz~2155MHz
Modulation	<input checked="" type="checkbox"/> GMSK for GSM/GPRS; <input checked="" type="checkbox"/> 8PSK for EGPRS; <input checked="" type="checkbox"/> QPSK for UMTS bands;
GPRS Class	<input checked="" type="checkbox"/> Multi-Class12 <input checked="" type="checkbox"/> Only 4 timeslots are used for GPRS
SIM CARD	SIM 1 and SIM 2 is a chipset unit and tested as a single chipset. The SIM 1 is chosen for test.
Antenna Type	PIFA Antenna
Antenna Gain	GSM850: -0.75dBi; GSM1900: 0.5dBi; WCDMA 850: -0.75dBi; WCDMA 1900: 0.5dBi; WCDMA 1750: 0.5dBi;
Power supply	<input checked="" type="checkbox"/> DC supply: DC 3.85V/6350mAh from Battery or DC 5V from USB Port.
	<input checked="" type="checkbox"/> Adapter supply: Model:HJ-0503000K7-US Input: 100-240V~50/60Hz 0.6A Output: 5V $\overline{\text{---}}$ 3000mA
HW Version	HCT-M860MB-B1
SW Version	Power_6_SF1_EEA_V01

Note: Based on the application, features, or specification exhibited in User's Manual, the EUT is considered as an ITE/Computing Device. More details of EUT technical specification, please refer to the User's Manual. The High Voltage 4.2V and Low Voltage 3.4V was declared by manufacturer, The EUT couldn't be operate normally with higher or lower voltage.

**Revision History**

Report No.	Version	Description	Issued Date
S19040800205005	Rev.01	Initial issue of report	05 Jun. 2019

## 5 DESCRIPTION OF TEST MODES

During the testing, the EUT was controlled via Rhode & Schwarz Digital Radio Communication Tester(CMU 200) to ensure max power transmission and proper modulation. Three channels (The low channel, the middle channel and the high channel) were chosen for testing on all frequency band.

Note: GSM/GPRS/EGPRS 850, GSM/GPRS/EGPRS 1900, WCDMA/HSDPA/HSUPA band II, WCDMA/HSDPA/HSUPA band V, HSDPA band IV, HSUPA band IV modes have been tested during the test. the worst condition (GSM850, GSM1900, RMC 12.2k) be recorded in the test report if no other modes test data.

Antenna port conducted and radiated test items were performed according to KDB 971168 D01 Power Meas. License Digital Systems v03 with maximum output power.

Radiated measurements were performed with rotating EUT in different three orthogonal test planes to find the maximum emission.

Radiated emissions were investigated as following frequency range:

1. 30 MHz to 10th harmonic for GSM850/UMTS FDD Band V/ UMTS FDD Band IV.
2. 30 MHz to 10th harmonic for GSM1900/UMTS FDD Band II.

All modes and data rates and positions were investigated.

Test modes are chosen to be reported as the worst case configuration below:

Test Modes		
Band	For Conducted Test Cases	For Radiated Test Cases
GSM 850	GSM Link	GSM Link
GSM 1900	GSM Link	GSM Link
UMTS Band II	RMC 12.2Kbps Link	RMC 12.2Kbps Link
UMTS Band V	RMC 12.2Kbps Link	RMC 12.2Kbps Link

Test Frequency and Channels:

Frequency Band	<input checked="" type="checkbox"/> GSM 850		<input checked="" type="checkbox"/> GSM 1900		<input checked="" type="checkbox"/> UMTS Band II		<input checked="" type="checkbox"/> UMTS Band V	
	Channel	Frequency (MHz)	Channel	Frequency (MHz)	Channel	Frequency (MHz)	Channel	Frequency (MHz)
CH_H	251	848.8	810	1909.8	9538	1907.6	4233	846.6
CH_M	190	836.6	661	1880.0	9400	1880.0	4183	836.6
CH_L	128	824.2	512	1850.2	9262	1852.4	4132	826.4

Frequency Band	<input checked="" type="checkbox"/> UMTS Band IV	
	Channel	Frequency (MHz)
CH_H	1513	1752.6
CH_M	1412	1732.6
CH_L	1312	1712.4



## 6 SETUP OF EQUIPMENT UNDER TEST

### 6.1 BLOCK DIAGRAM CONFIGURATION OF TEST SYSTEM

For Radiated Test Cases

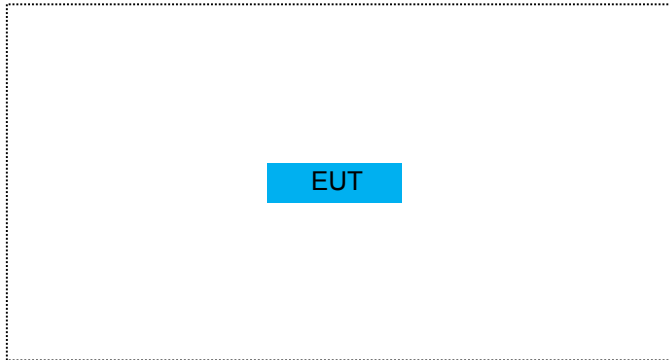

For Conducted Output Power

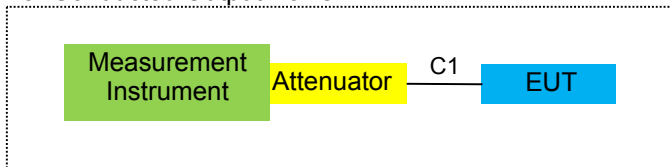

For Peak-to Average Ratio, Occupied Bandwidth, Conducted Band edge and Conducted Spurious Emission

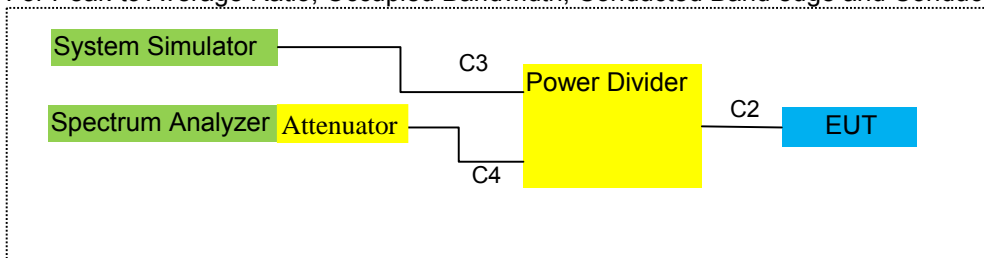

For Frequency Stability

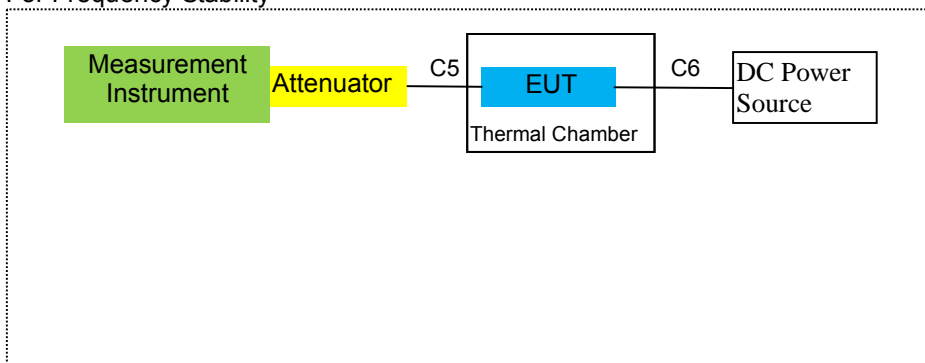

**6.2 SUPPORT EQUIPMENT**

The EUT has been tested as an independent unit together with other necessary accessories or support units. The following support units or accessories were used to form a representative test configuration during the tests.

Item	Equipment	Mfr/Brand	Model/Type No.	Series No.	Note

Item	Cable Type	Shielded Type	Ferrite Core	Length
C-1	RF Cable	YES	NO	0.1m
C-2	RF Cable	YES	NO	0.1m
C-3	RF Cable	YES	NO	0.1m
C-4	RF Cable	YES	NO	0.2m
C-5	RF Cable	YES	NO	0.2m
C-6	DC Cable	NO	NO	1.0m

**Notes:**

- (1) The support equipment was authorized by Declaration of Confirmation.
- (2) For detachable type I/O cable should be specified the length in cm in 『Length』 column.
- (3) “YES” is means “shielded” “with core”; “NO” is means “unshielded” “without core”.

**6.3 EQUIPMENTS LIST FOR ALL TEST ITEMS**

Item	Kind of Equipment	Manufacturer	Type No.	Serial No.	Last calibration	Calibrated until	Calibration period
1	MXA Signal Analyzer	Agilent	N9020A	MY49100060	2018.10.08	2019.10.07	1 year
2	Test Receiver	R&S	ESPI	101318	2018.05.19	2019.05.18	1 year
3	Bilog Antenna	TESEQ	CBL6111D	31216	2019.04.15	2020.04.14	1 year
4	50Ω Coaxial Switch	Anritsu	MP59B	6200983705	2018.05.19	2019.05.18	1 year
5	Horn Antenna	EM	EM-AH-1018 0	2011071402	2018.05.19	2019.05.18	1 year
6	Horn Ant	Schwarzbeck	BBHA 9170	9170-181	2019.04.15	2020.04.14	1 year
7	Amplifier	EM	EM-30180	060538	2018.08.05	2019.08.04	1 year
8	Loop Antenna	ARA	PLA-1030/B	1029	2018.05.19	2019.05.18	1 year
9	Power Meter	R&S	NRVS	100696	2018.08.05	2019.08.04	1 year
10	Power Sensor	R&S	URV5-Z4	0395.1619.0 5	2018.05.19	2019.05.18	1 year
11	Test Cable	N/A	R-01	N/A	2017.04.21	2020.04.20	3 year
12	Test Cable	N/A	R-02	N/A	2017.04.21	2020.04.20	3 year
13	Test Cable	N/A	R-03	N/A	2017.04.21	2020.04.20	3 year
14	Test Receiver	R&S	ESCI	101160	2018.05.19	2019.05.18	1 year
15	LISN	R&S	ENV216	101313	2019.04.15	2020.04.14	1 year
16	LISN	EMCO	3816/2	00042990	2018.05.19	2019.05.18	1 year
17	50Ω Coaxial Switch	Anritsu	MP59B	6200264417	2018.05.19	2019.05.18	1 year
18	Passive Voltage Probe	R&S	ESH2-Z3	100196	2017.04.21	2020.04.20	3 year
19	Test Cable	N/A	C01	N/A	2017.04.21	2020.04.20	3 year
20	Test Cable	N/A	C02	N/A	2017.04.21	2020.04.20	3 year
21	Test Cable	N/A	C03	N/A	2018.04.19	2019.04.18	1 year
22	Attenuator	MCE	24-10-34	BN9258	2019.04.15	2020.04.14	1 year
23	Spectrum Analyzer	agilent	e4440a	us44300399	2018.05.19	2019.05.18	1 year
24	test receiver	R&S	ESCI	a0304218	2018.05.19	2019.05.18	1 year
25	Communication Tester	R&S	CMU200	A0304247	2018.10.08	2019.10.07	1 year
26	Thermal Chamber	Ten Billion	TTC-B3C	TBN-960502	2018.05.19	2019.05.18	1 year
27	DC Power Source	N/A	PS-6005D	2017040292 3	2017.06.06	2020.06.05	3 year

Note: Each piece of equipment is scheduled for calibration once a year except the Test Cable& DC Power Source which is scheduled for calibration every 3 years.

## 7 TEST REQUIREMENTS

### 7.1 FIELD STRENGTH OF SPURIOUS RADIATION

#### 7.1.1 Applicable Standard

According to FCC KDB 971168 D01 v03 Section 5.8 and ANSI/TIA-603-E-2016 Section 2.2.12

#### 7.1.2 Conformance Limit

The power of any emission outside of the authorized operating frequency ranges must be attenuated below the transmitter power (P) by a factor of at least  $43 + 10 \log (P)$  dB. The spectrum is scanned from 30 MHz up to a frequency including its 10th harmonic.

#### 7.1.3 Measuring Instruments

The Measuring equipment is listed in the section 6.3 of this test report.

#### 7.1.4 Test Configuration

According to the ANSI/TIA-603-E-2016 test method, The Receiver or Spectrum was scanned from 9 KHz to the 10th harmonic of the highest frequency generated within the equipment, which is the transmitted carrier that can be as high as 1910 MHz The resolution bandwidth is set as outlined in Part 24.238, Part 22.917. The spectrum is scanned with the mobile station transmitting at carrier frequencies that pertain to low, mid and high channels of WCDMA Band II / WCDMA Band V / GSM 850 / GSM 1900.

### TEST CONFIGURATION

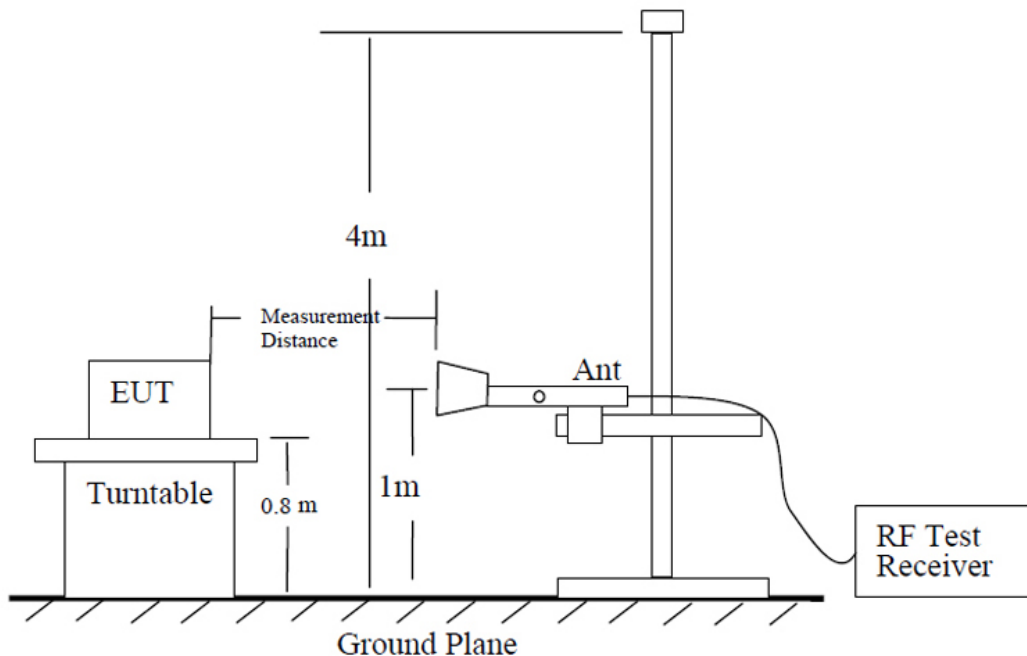

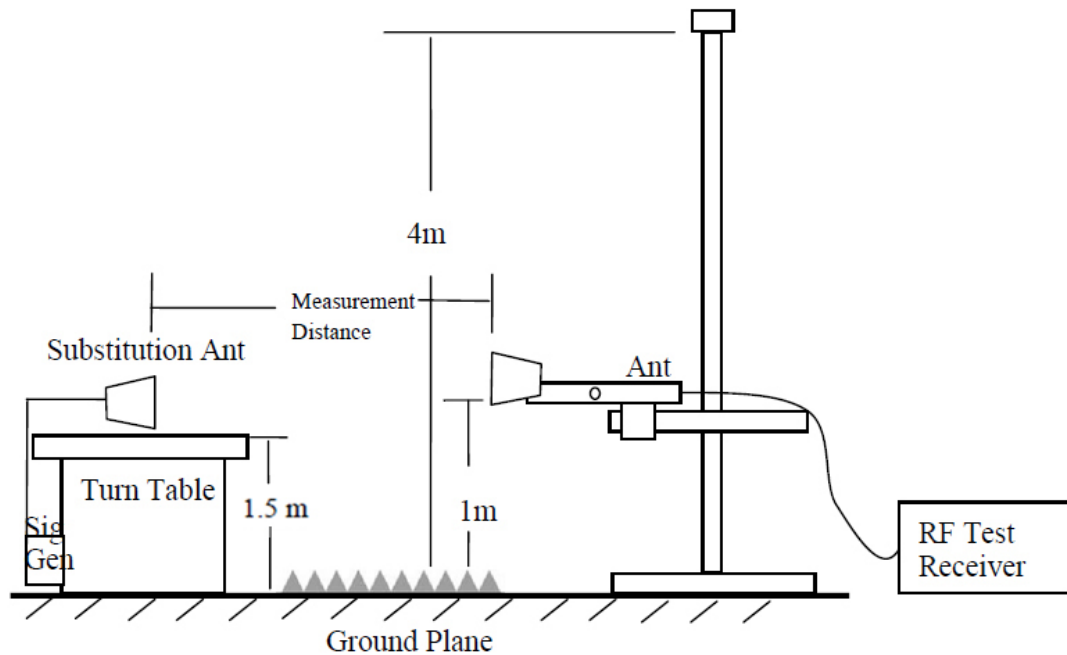

### 7.1.5 Test Procedure

1. EUT was placed on a 0.8 meter (For frequency above 1G, EUT should be placed on 1.5m) high non-conductive stand at a 3 meter test distance from the receive antenna. A receiving antenna was placed on the antenna mast 3 meters from the EUT for emission measurements. The height of receiving antenna is 1.50 meter. Detected emissions were maximized at each frequency by rotating the EUT through 360° and adjusting the receiving antenna polarization. The radiated emission measurements of all transmit frequencies in three channels (High, Middle, Low) were measured with peak detector.
2. A log-periodic antenna or double-ridged waveguide horn antenna shall be substituted in place of the EUT. The log-periodic antenna will be driven by a signal generator and the level will be adjusted till the same power value on the spectrum analyzer or receiver. The level of the spurious emissions can be calculated through the level of the signal generator, cable loss, the gain of the substitution antenna and the reading of the spectrum analyzer or receiver.
3. The EUT is then put into continuously transmitting mode at its maximum power level during the test. Set Test Receiver or Spectrum RBW=1MHz, VBW=3MHz, And the maximum value of the receiver should be recorded as ( $P_r$ ).
4. The EUT shall be replaced by a substitution antenna. In the chamber, an substitution antenna for the frequency band of interest is placed at the reference point of the chamber. An RF Signal source for the frequency band of interest is connected to the substitution antenna with a cable that has been constructed to not interfere with the radiation pattern of the antenna. A power (SG Level) is applied to the input of the substitution antenna, and adjust the level of the signal generator output until the value of the receiver reach the previously recorded ( $P_r$ ). The power of signal source (SG Level) is recorded. The test should be performed by rotating the test item and adjusting the receiving antenna polarization.
5. A amplifier should be connected to the Signal Source output port. And the cable should be connect between the Amplifier and the Substitution Antenna. The cable loss (Cable Loss), the Substitution Antenna Gain should be recorded after test.  
The measurement results are obtained as described below:  
Power(EIRP)= SG Level- Cable Loss+ Antenna Gain
6. This value is EIRP since the measurement is calibrated using an antenna of known gain (2.15 dBi) and known input power.
7. ERP can be calculated from EIRP by subtracting the gain of the dipole, ERP = EIRP -2.15dBi.

**7.1.6 Test Results**

EUT:	Mobile Phone	Model No.:	GQ3081
Temperature:	20 °C	Relative Humidity:	48%
Test Mode:	GSM/GPRS/EGPRS 850/ GSM/GPRS/EGPRS 1900 UMTS band II/ UMTS band V/ UMTS band IV	Test By:	Cheng Jiawen

■ Radiated Spurious Emission

GSM 850							
Frequency	SG Level	Cable Loss	Antenna Gain	Absolute Level	Limit	Over Limit	Polarity
(MHz)	(dBm)	(dB)	(dB)	(dBm)	(dBm)	(dBm)	
Test Results for Channel 128/824.2 MHz							
1648.4	-48.62	2.80	27.50	-23.92	-13	-10.92	Vertical
1648.4	-45.60	2.80	27.50	-20.90	-13	-7.90	Horizontal
2472.6	-47.05	2.91	27.80	-22.16	-13	-9.16	Vertical
2472.6	-49.43	2.91	27.80	-24.54	-13	-11.54	Horizontal
3296.8	-46.29	4.02	29.87	-20.44	-13	-7.44	Vertical
3296.8	-48.96	4.02	29.87	-23.11	-13	-10.11	Horizontal
Test Results for Channel 190/836.6 MHz							
1673.2	-44.35	2.80	27.48	-19.67	-13	-6.67	Vertical
1673.2	-45.02	2.80	27.48	-20.34	-13	-7.34	Horizontal
2509.8	-50.85	2.91	27.70	-26.06	-13	-13.06	Vertical
2509.8	-49.25	2.91	27.70	-24.46	-13	-11.46	Horizontal
3346.4	-46.27	4.02	29.82	-20.47	-13	-7.47	Vertical
3346.4	-50.13	4.02	29.82	-24.33	-13	-11.33	Horizontal
Test Results for Channel 251/848.8 MHz							
1697.6	-47.20	2.80	27.42	-22.58	-13	-9.58	Vertical
1697.6	-47.67	2.80	27.42	-23.05	-13	-10.05	Horizontal
2546.4	-50.54	2.91	27.68	-25.77	-13	-12.77	Vertical
2546.4	-44.20	2.91	27.68	-19.43	-13	-6.43	Horizontal
3395.2	-43.93	4.02	29.80	-18.15	-13	-5.15	Vertical
3395.2	-47.67	4.02	29.80	-21.89	-13	-8.89	Horizontal

Remark:

1. We were tested all Configuration refer 3GPP TS134 121.
2. Absolute Level = SG Level- Cable Loss+ Antenna Gain
3. Over Limit= Absolute Level (dBm)-Limit(dBm)

GPRS 850							
Frequency	SG Level	Cable Loss	Antenna Gain	Absolute Level	Limit	Over Limit	Polarity
(MHz)	(dBm)	(dB)	(dB)	(dBm)	(dBm)	(dBm)	
Test Results for Channel 128/824.2 MHz							
1648.4	-43.68	2.80	27.50	-18.98	-13	-5.98	Vertical
1648.4	-42.25	2.80	27.50	-17.55	-13	-4.55	Horizontal
2472.6	-51.24	2.91	27.80	-26.35	-13	-13.35	Vertical
2472.6	-46.88	2.91	27.80	-21.99	-13	-8.99	Horizontal
3296.8	-50.05	4.02	29.87	-24.20	-13	-11.20	Vertical
3296.8	-44.26	4.02	29.87	-18.41	-13	-5.41	Horizontal
Test Results for Channel 190/836.6 MHz							
1673.2	-52.70	2.80	27.48	-28.02	-13	-15.02	Vertical
1673.2	-45.26	2.80	27.48	-20.58	-13	-7.58	Horizontal
2509.8	-52.45	2.91	27.70	-27.66	-13	-14.66	Vertical
2509.8	-46.22	2.91	27.70	-21.43	-13	-8.43	Horizontal
3346.4	-43.51	4.02	29.82	-17.71	-13	-4.71	Vertical
3346.4	-51.70	4.02	29.82	-25.90	-13	-12.90	Horizontal
Test Results for Channel 251/848.8 MHz							
1697.6	-49.97	2.80	27.42	-25.35	-13	-12.35	Vertical
1697.6	-46.73	2.80	27.42	-22.11	-13	-9.11	Horizontal
2546.4	-42.78	2.91	27.68	-18.01	-13	-5.01	Vertical
2546.4	-49.24	2.91	27.68	-24.47	-13	-11.47	Horizontal
3395.2	-47.91	4.02	29.80	-22.13	-13	-9.13	Vertical
3395.2	-50.71	4.02	29.80	-24.93	-13	-11.93	Horizontal

Remark:

1. We were tested all Configuration refer 3GPP TS134 121.
2. Absolute Level = SG Level- Cable Loss+ Antenna Gain
3. Over Limit= Absolute Level (dBm)-Limit(dBm)

EGPRS 850							
Frequency	SG Level	Cable Loss	Antenna Gain	Absolute Level	Limit	Over Limit	Polarity
(MHz)	(dBm)	(dB)	(dB)	(dBm)	(dBm)	(dBm)	
Test Results for Channel 128/824.2 MHz							
1648.4	-50.25	2.80	27.50	-25.55	-13	-12.55	Vertical
1648.4	-47.01	2.80	27.50	-22.31	-13	-9.31	Horizontal
2472.6	-54.14	2.91	27.80	-29.25	-13	-16.25	Vertical
2472.6	-48.50	2.91	27.80	-23.61	-13	-10.61	Horizontal
3296.8	-51.03	4.02	29.87	-25.18	-13	-12.18	Vertical
3296.8	-44.53	4.02	29.87	-18.68	-13	-5.68	Horizontal
Test Results for Channel 190/836.6 MHz							
1673.2	-49.75	2.80	27.48	-25.07	-13	-12.07	Vertical
1673.2	-49.84	2.80	27.48	-25.16	-13	-12.16	Horizontal
2509.8	-51.16	2.91	27.70	-26.37	-13	-13.37	Vertical
2509.8	-48.82	2.91	27.70	-24.03	-13	-11.03	Horizontal
3346.4	-49.15	4.02	29.82	-23.35	-13	-10.35	Vertical
3346.4	-45.57	4.02	29.82	-19.77	-13	-6.77	Horizontal
Test Results for Channel 251/848.8 MHz							
1697.6	-46.54	2.80	27.42	-21.92	-13	-8.92	Vertical
1697.6	-44.38	2.80	27.42	-19.76	-13	-6.76	Horizontal
2546.4	-52.46	2.91	27.68	-27.69	-13	-14.69	Vertical
2546.4	-47.31	2.91	27.68	-22.54	-13	-9.54	Horizontal
3395.2	-46.57	4.02	29.80	-20.79	-13	-7.79	Vertical
3395.2	-45.99	4.02	29.80	-20.21	-13	-7.21	Horizontal

Remark:

1. We were tested all Configuration refer 3GPP TS134 121.
2. Absolute Level = SG Level- Cable Loss+ Antenna Gain
3. Over Limit= Absolute Level (dBm)-Limit(dBm)



GSM 1900							
Frequency	SG Level	Cable Loss	Antenna Factor	Absolute Level	Limit	Over Limit	Polarity
(MHz)	(dBm)	(dB)	(dB)	(dBm)	(dBm)	(dBm)	
Test Results for Channel 512/1850.2MHz							
3700.4	-47.88	4.04	33.51	-18.41	-13	-5.41	Vertical
3700.4	-54.42	4.04	33.51	-24.95	-13	-11.95	Horizontal
5550.6	-56.51	5.24	35.84	-25.91	-13	-12.91	Vertical
5550.6	-53.16	5.24	35.84	-22.56	-13	-9.56	Horizontal
Test Results for Channel 661/1880.0MHz							
3760	-52.48	4.04	33.56	-22.96	-13	-9.96	Vertical
3760	-46.77	4.04	33.56	-17.25	-13	-4.25	Horizontal
5640	-56.47	5.24	35.91	-25.80	-13	-12.80	Vertical
5640	-54.65	5.24	35.91	-23.98	-13	-10.98	Horizontal
Test Results for Channel 810/1909.8MHz							
3819.6	-53.66	4.04	34.00	-23.70	-13	-10.70	Vertical
3819.6	-56.56	4.04	34.00	-26.60	-13	-13.60	Horizontal
5729.4	-52.56	5.24	36.04	-21.76	-13	-8.76	Vertical
5729.4	-54.83	5.24	36.04	-24.03	-13	-11.03	Horizontal

Remark:

1. We were tested all Configuration refer 3GPP TS134 121.
2. Absolute Level = SG Level- Cable Loss+ Antenna Gain
3. Over Limit= Absolute Level (dBm)-Limit(dBm)

GPRS 1900							
Frequency	SG Level	Cable Loss	Antenna Factor	Absolute Level	Limit	Over Limit	Polarity
(MHz)	(dBm)	(dB)	(dB)	(dBm)	(dBm)	(dBm)	
Test Results for Channel 512/1850.2MHz							
3700.4	-55.65	4.04	33.51	-26.18	-13	-13.18	Vertical
3700.4	-56.49	4.04	33.51	-27.02	-13	-14.02	Horizontal
5550.6	-48.52	5.24	35.84	-17.92	-13	-4.92	Vertical
5550.6	-53.50	5.24	35.84	-22.90	-13	-9.90	Horizontal
Test Results for Channel 661/1880.0MHz							
3760	-47.18	4.04	33.56	-17.66	-13	-4.66	Vertical
3760	-50.34	4.04	33.56	-20.82	-13	-7.82	Horizontal
5640	-56.48	5.24	35.91	-25.81	-13	-12.81	Vertical
5640	-49.84	5.24	35.91	-19.17	-13	-6.17	Horizontal
Test Results for Channel 810/1909.8MHz							
3819.6	-50.68	4.04	34.00	-20.72	-13	-7.72	Vertical
3819.6	-48.76	4.04	34.00	-18.80	-13	-5.80	Horizontal
5729.4	-48.56	5.24	36.04	-17.76	-13	-4.76	Vertical
5729.4	-49.78	5.24	36.04	-18.98	-13	-5.98	Horizontal

Remark:

1. We were tested all Configuration refer 3GPP TS134 121.
2. Absolute Level = SG Level- Cable Loss+ Antenna Gain
3. Over Limit= Absolute Level (dBm)-Limit(dBm)

<b>EGPRS 1900</b>							
Frequency	SG Level	Cable Loss	Antenna Factor	Absolute Level	Limit	Over Limit	Polarity
(MHz)	(dBm)	(dB)	(dB)	(dBm)	(dBm)	(dBm)	
Test Results for Channel 512/1850.2MHz							
3700.4	-50.37	4.04	33.51	-20.90	-13	-7.90	Vertical
3700.4	-45.50	4.04	33.51	-16.03	-13	-3.03	Horizontal
5550.6	-48.05	5.24	35.84	-17.45	-13	-4.45	Vertical
5550.6	-47.37	5.24	35.84	-16.77	-13	-3.77	Horizontal
Test Results for Channel 661/1880.0MHz							
3760	-47.54	4.04	33.56	-18.02	-13	-5.02	Vertical
3760	-48.83	4.04	33.56	-19.31	-13	-6.31	Horizontal
5640	-47.93	5.24	35.91	-17.26	-13	-4.26	Vertical
5640	-47.18	5.24	35.91	-16.51	-13	-3.51	Horizontal
Test Results for Channel 810/1909.8MHz							
3819.6	-52.73	4.04	34.00	-22.77	-13	-9.77	Vertical
3819.6	-49.14	4.04	34.00	-19.18	-13	-6.18	Horizontal
5729.4	-54.76	5.24	36.04	-23.96	-13	-10.96	Vertical
5729.4	-49.58	5.24	36.04	-18.78	-13	-5.78	Horizontal

Remark:

1. We were tested all Configuration refer 3GPP TS134 121.
2. Absolute Level = SG Level- Cable Loss+ Antenna Gain
3. Over Limit= Absolute Level (dBm)-Limit(dBm)

<b>WCDMA Band II</b>							
Frequency	SG Level	Cable Loss	Antenna Factor	Absolute Level	Limit	Over Limit	Polarity
(MHz)	(dBm)	(dB)	(dB)	(dBm)	(dBm)	(dBm)	
Test Results for Channel 9262/1852.4MHz							
3704.8	-56.75	4.04	33.51	-27.28	-13	-14.28	Vertical
3704.8	-48.99	4.04	33.51	-19.52	-13	-6.52	Horizontal
5557.2	-53.23	5.24	35.84	-22.63	-13	-9.63	Vertical
5557.2	-47.73	5.24	35.84	-17.13	-13	-4.13	Horizontal
Test Results for Channel 9400/1880MHz							
3760	-48.78	4.04	33.56	-19.26	-13	-6.26	Vertical
3760	-56.89	4.04	33.56	-27.37	-13	-14.37	Horizontal
5640	-51.68	5.24	35.91	-21.01	-13	-8.01	Vertical
5640	-51.83	5.24	35.91	-21.16	-13	-8.16	Horizontal
Test Results for Channel 9538/1907.6MHz							
3815.2	-47.65	4.04	34.00	-17.69	-13	-4.69	Vertical
3815.2	-48.46	4.04	34.00	-18.50	-13	-5.50	Horizontal
5722.8	-56.39	5.24	36.04	-25.59	-13	-12.59	Vertical
5722.8	-56.33	5.24	36.04	-25.53	-13	-12.53	Horizontal

**Remark:**

1. We were tested all Configuration refer 3GPP TS134 121.
2. Absolute Level = SG Level- Cable Loss+ Antenna Gain
3. Over Limit= Absolute Level (dBm)-Limit(dBm)

WCDMA Band V							
Frequency	SG Level	Cable Loss	Antenna Gain	Absolute Level	Limit	Over Limit	Polarity
(MHz)	(dBm)	(dB)	(dB)	(dBm)	(dBm)	(dBm)	
Test Results for Channel 4233/846.6MHz							
1693.2	-42.66	2.80	27.50	-17.96	-13	-4.96	Vertical
1693.2	-46.93	2.80	27.50	-22.23	-13	-9.23	Horizontal
2539.8	-50.44	2.91	27.80	-25.55	-13	-12.55	Vertical
2539.8	-47.06	2.91	27.80	-22.17	-13	-9.17	Horizontal
3386.4	-42.52	4.02	29.87	-16.67	-13	-3.67	Vertical
3386.4	-48.22	4.02	29.87	-22.37	-13	-9.37	Horizontal
Test Results for Channel 4182/836.4MHz							
1672.8	-44.34	2.80	27.48	-19.66	-13	-6.66	Vertical
1672.8	-41.21	2.80	27.48	-16.53	-13	-3.53	Horizontal
2509.2	-49.24	2.91	27.70	-24.45	-13	-11.45	Vertical
2509.2	-41.97	2.91	27.70	-17.18	-13	-4.18	Horizontal
3345.6	-47.00	4.02	29.82	-21.20	-13	-8.20	Vertical
3345.6	-48.93	4.02	29.82	-23.13	-13	-10.13	Horizontal
Test Results for Channel 4132/826.4MHz							
1652.8	-44.34	2.80	27.42	-19.72	-13	-6.72	Vertical
1652.8	-45.26	2.80	27.42	-20.64	-13	-7.64	Horizontal
2479.2	-49.40	2.91	27.68	-24.63	-13	-11.63	Vertical
2479.2	-44.06	2.91	27.68	-19.29	-13	-6.29	Horizontal
3305.6	-47.96	4.02	29.80	-22.18	-13	-9.18	Vertical
3305.6	-49.42	4.02	29.80	-23.64	-13	-10.64	Horizontal

Remark:

1. We were tested all Configuration refer 3GPP TS134 121.
2. Absolute Level = SG Level- Cable Loss+ Antenna Gain
3. Over Limit= Absolute Level (dBm)-Limit(dBm)

<b>WCDMA Band IV</b>							
Frequency	SG Level	Cable Loss	Antenna Factor	Absolute Level	Limit	Over Limit	Polarity
(MHz)	(dBm)	(dB)	(dB)	(dBm)	(dBm)	(dBm)	
Test Results for Channel 1312/1712.4MHz							
3424.8	-51.06	4.02	29.80	-25.28	-13	-12.28	Vertical
3424.8	-48.94	4.02	29.80	-23.16	-13	-10.16	Horizontal
5137.2	-49.37	5.24	35.84	-18.77	-13	-5.77	Vertical
5137.2	-46.84	5.24	35.84	-16.24	-13	-3.24	Horizontal
Test Results for Channel 1412/1732.4MHz							
3464.8	-41.39	4.03	30.00	-15.42	-13	-2.42	Vertical
3464.8	-47.08	4.03	30.00	-21.11	-13	-8.11	Horizontal
5197.2	-46.84	5.25	35.86	-16.23	-13	-3.23	Vertical
5197.2	-47.53	5.25	35.86	-16.92	-13	-3.92	Horizontal
Test Results for Channel 1513/1752.6MHz							
3505.2	-50.50	2.91	27.68	-25.73	-13	-12.73	Vertical
3505.2	-47.37	2.91	27.68	-22.60	-13	-9.60	Horizontal
5257.8	-49.44	5.26	35.86	-18.84	-13	-5.84	Vertical
5257.8	-52.63	5.26	35.86	-22.03	-13	-9.03	Horizontal

Remark:

1. We were tested all Configuration refer 3GPP TS134 121.
2. Absolute Level = SG Level- Cable Loss+ Antenna Gain
3. Over Limit= Absolute Level (dBm)-Limit(dBm)

## 7.2 EFFECTIVE RADIATED POWER AND EFFECTIVE ISOTROPIC RADIATED POWER

### 7.2.1 Applicable Standard

According to FCC KDB 971168 D01 v03 Section 5.2.1/ Section 5.2.2.2 and ANSI/TIA-603-E-2016 Section 2.2.17

### 7.2.2 Conformance Limit

The substitution method, in ANSI/TIA-603-E-2016, was used for ERP/EIRP measurement, and the spectrum analyzer configuration follows KDB 971168 D01 Power Meas. License Digital Systems v03. The ERP of mobile transmitters must not exceed 7 Watts (Cellular Band) and the EIRP of mobile transmitters are limited to 2 Watts (PCS Band).

### 7.2.3 Measuring Instruments

The Measuring equipment is listed in the section 6.3 of this test report.

### 7.2.4 Test Configuration

(a) For E.R.P and E.I.R.P Measurements  
Please refer to the section 7.1.4 in this report.

### 7.2.5 Test Procedure

The measurements procedures specified in ANSI/TIA-603-E-2016 were applied. In an anechoic antenna test chamber, a half-wave dipole antenna for the frequency band of interest is placed at the reference centre of the chamber. An RF Signal source for the frequency band of interest is connected to the dipole with a cable that has been constructed to not interfere with the radiation pattern of the antenna. A known (measured) power ( $P_{in}$ ) is applied to the input of the dipole, and the power received ( $P_r$ ) at the chamber's probe antenna is recorded.

The relevant equation for determining the ERP or EIRP from the conducted RF output power measured using the guidance provided above is:

$$ERP/EIRP = SGLevel - P_{cl} + G_a$$

where:

ERP/EIRP = effective or equivalent radiated power, respectively (expressed in the same units as SGLevel, typically dBW or dBm);

SGLevel = Signal generator output power or PSD, in dBm or dBW;

$G_a$  = gain of the transmitting antenna, in dBd (ERP) or dBi (EIRP);

$P_{cl}$  = signal attenuation in the connecting cable between the transmitter and antenna, in dB.<sup>2</sup>

The EUT is substituted for the dipole at the reference centre of the chamber and a scan is performed to obtain the radiation pattern.

From the radiation pattern, the co-ordinates where the maximum antenna gain occurs are identified.

The EUT is then put into continuously transmitting mode at its maximum power level.

Power mode measurements are performed with the receiving antenna placed at the coordinates determined in Step 3 to determine the output power as defined in Rule 24.232 (b) and (c). The "reference path loss" from Step1 is added to this result.

This value is EIRP since the measurement is calibrated using a half-wave dipole antenna of known gain (2.15 dBi) and known input power ( $P_{in}$ ).

ERP can be calculated from EIRP by subtracting the gain of the dipole,  $ERP = EIRP - 2.15dBi$ .

Both horizontal and vertical antenna polarities were tested and performed pretest to three orthogonal axis. The worst case emissions were reported.

Substitution antenna and Receiving Antenna:

Item	Kind of Equipment	Manufacturer	Type No.	Serial No.	Character	Note
1	Bilog Antenna	TESEQ	CBL6111D	31216	30MHz~2GHz	Receiving Antenna
2	Horn Antenna	EM	EM-AH-10180	2011071402	1GHz~18GHz	Receiving Antenna
3	Bilog Antenna	TESEQ	CBL6111D	31216	30MHz~2GHz	Substitution antenna
4	Horn Antenna	EM	EM-AH-10180	2011071402	1GHz~18GHz	Substitution antenna

Use the following spectrum analyzer settings:

	GSM/GPRS/EGPRS	UMTS band
Span	500KHz	10MHz
RBW	10KHz	300KHz
VBW	30KHz	1MHz
Detector	RMS	RMS
Trace	Average	Average
Average Type	Power	Power
Sweep Count	100	100



**7.2.6 Test Results**

EUT:	Mobile Phone	Model No.:	GQ3081
Temperature:	20 °C	Relative Humidity:	48%
Test Mode:	GSM/GPRS/EGPRS 850/ GSM/GPRS/EGPRS 1900 UMTS band II/ UMTS band V/ UMTS band IV	Test By:	Cheng Jiawen

■ Effective Radiated Power

Radiated Power (ERP) for GSM850							
Frequency	Polarization	SG Level	Pcl	Ga Antenna Gain	Correction	ERP	ERP
(MHz)		(dBm)	(dB)	(dB)	(dB)	(dBm)	(W)
824.2	H	12.56	2.11	23.84	2.15	32.14	1.636453
836.6	H	13.07	2.13	23.15	2.15	31.94	1.563033
848.8	H	13.03	2.13	23.06	2.15	31.81	1.516446
824.2	V	13.24	2.11	23.11	2.15	32.09	1.616416
836.6	V	13.33	2.13	23.07	2.15	32.12	1.629805
848.8	V	13.29	2.13	23.25	2.15	32.26	1.684419

Radiated Power (ERP) for GPRS850							
Frequency	Polarization	SG Level	Pcl	Ga Antenna Gain	Correction	ERP	ERP
(MHz)		(dBm)	(dB)	(dB)	(dB)	(dBm)	(W)
824.2	H	12.78	2.11	23.84	2.15	32.36	1.720336
836.6	H	14.04	2.13	23.15	2.15	32.91	1.953379
848.8	H	12.80	2.13	23.06	2.15	31.58	1.438488
824.2	V	13.88	2.11	23.11	2.15	32.73	1.876349
836.6	V	13.47	2.13	23.07	2.15	32.26	1.681458
848.8	V	13.76	2.13	23.25	2.15	32.73	1.874311

Radiated Power (ERP) for EGPRS850							
Frequency	Polarization	SG Level	Pcl	Ga Antenna Gain	Correction	ERP	ERP
(MHz)		(dBm)	(dB)	(dB)	(dB)	(dBm)	(W)
824.2	H	7.27	2.11	23.84	2.15	26.85	0.484005
836.6	H	7.01	2.13	23.15	2.15	25.88	0.387250
848.8	H	7.29	2.13	23.06	2.15	26.07	0.405011
824.2	V	7.50	2.11	23.11	2.15	26.35	0.431985
836.6	V	7.62	2.13	23.07	2.15	26.41	0.437089
848.8	V	7.18	2.13	23.25	2.15	26.15	0.411867

Radiated Power (ERP) for UMTS band V							
Frequency	Polarization	SG Level	Pcl	Ga Antenna Gain	Correction	ERP	ERP
(MHz)		(dBm)	(dB)	(dB)	(dB)	(dBm)	(W)
826.4	H	3.59	2.11	23.84	2.15	23.17	0.207408
835	H	4.32	2.13	23.15	2.15	23.19	0.208210
846.6	H	4.13	2.13	23.06	2.15	22.91	0.195282
826.4	V	4.79	2.11	23.11	2.15	23.64	0.231417
835	V	4.37	2.13	23.07	2.15	23.16	0.207197
846.6	V	4.79	2.13	23.25	2.15	23.76	0.237816

Note:

SG Level= Signal generator output

Pcl= cable loss

Ga= Antenna Gain

Peak EIRP(dBm)= SGLevel -Pcl +Ga

ERP(dBm)=EIRP-2.15

■ Effective Isotropic Radiated Power

Radiated Power (E.I.R.P) for GSM1900						
Frequency	Polarization	SG Level	Pcl	Ga Antenna Gain	EIRP	EIRP
(MHz)		(dBm)	(dB)	(dB)	(dBm)	(W)
1850.2	H	6.50	3.76	28.24	30.98	1.253180
1880	H	5.71	3.91	28.22	30.02	1.005662
1909.8	H	5.67	3.93	28.20	29.94	0.986201
1850.2	V	6.46	3.76	27.32	30.02	1.004121
1880	V	6.43	3.91	27.33	29.85	0.966526
1909.8	V	6.92	3.93	27.31	30.30	1.070695

Radiated Power (E.I.R.P) for GPRS1900						
Frequency	Polarization	SG Level	Pcl	Ga Antenna Gain	EIRP	EIRP
(MHz)		(dBm)	(dB)	(dB)	(dBm)	(W)
1850.2	H	5.82	3.76	28.24	30.30	1.072478
1880	H	5.63	3.91	28.22	29.94	0.985474
1909.8	H	6.16	3.93	28.20	30.43	1.103015
1850.2	V	6.75	3.76	27.32	30.31	1.073943
1880	V	6.33	3.91	27.33	29.75	0.944746
1909.8	V	6.44	3.93	27.31	29.82	0.958997

Radiated Power (E.I.R.P) for EGPRS1900						
Frequency	Polarization	SG Level	Pcl	Ga Antenna Gain	EIRP	EIRP
(MHz)		(dBm)	(dB)	(dB)	(dBm)	(W)
1850.2	H	1.71	3.76	28.24	26.19	0.416141
1880	H	1.99	3.91	28.22	26.30	0.427028
1909.8	H	2.40	3.93	28.20	26.67	0.464534
1850.2	V	2.84	3.76	27.32	26.40	0.436655
1880	V	2.21	3.91	27.33	25.63	0.365467
1909.8	V	2.31	3.93	27.31	25.69	0.371103

Radiated Power (E.I.R.P) for UMTS band II						
Frequency	Polarization	SG	Pcl	Ga	EIRP	EIRP
(MHz)		Level	(dB)	Antenna Gain	(dBm)	(W)
		(dBm)	(dB)	(dB)	(dBm)	(W)
1852.4	H	-1.63	3.76	28.24	22.85	0.192915
1880	H	-0.93	3.91	28.22	23.38	0.217643
1907.6	H	-1.18	3.93	28.20	23.09	0.203485
1852.4	V	-1.18	3.76	27.32	22.38	0.173175
1880	V	-0.56	3.91	27.33	22.86	0.193195
1907.6	V	-0.23	3.93	27.31	23.15	0.206482

Radiated Power (E.I.R.P) for UMTS band IV						
Frequency	Polarization	SG	Pcl	Ga	EIRP	EIRP
(MHz)		Level	(dB)	Antenna Gain	(dBm)	(W)
		(dBm)	(dB)	(dB)	(dBm)	(W)
1712.4	H	-1.22	3.13	27.63	23.28	0.212634
1732.4	H	-0.69	3.27	27.61	23.65	0.231799
1752.6	H	-1.19	3.30	27.60	23.11	0.204610
1712.4	V	-1.49	3.13	27.63	23.01	0.199930
1732.4	V	-1.66	3.27	27.61	22.68	0.185426
1752.6	V	-1.17	3.30	27.60	23.13	0.205643

Note:

SG Level= Signal generator output

Pcl= cable loss

Ga= Antenna Gain

Peak EIRP(dBm)= SGLevel –Pcl+Ga.

### 7.3 CONDUCTED OUTPUT POWER

#### 7.3.1 Applicable Standard

According to FCC Part 2.1046 and FCC Part 22.913(a)(2) and FCC Part 24.232(c) and FCC KDB 971168 D01 v03 Section 5.2

#### 7.3.2 Conformance Limit

Extend coverage on a secondary basis into cellular unserved areas, as those areas are defined in §22.949, the ERP of base transmitters and cellular repeaters of such systems must not exceed 1000 Watts. The ERP of mobile transmitters and auxiliary test transmitters must not exceed 7 Watts(38.5dBm).

Mobile and portable stations are limited to 2 watts (33dBm)EIRP and the equipment must employ a means for limiting power to the minimum necessary for successful communications..

#### 7.3.3 Measuring Instruments

The Measuring equipment is listed in the section 6.3 of this test report.

#### 7.3.4 Test Setup

Please refer to Section 6.1 of this test report.

#### 7.3.5 Test Procedure

Connect the EUT to Universal Radio Communication Tester CMU200 or CMU500 via the antenna connector. A call is set up by the SS according to the generic call set up procedure on a channel with ARFCN in the ARFCN range, power control level set to Max power. The frequency band is set as selected frequency, The RF output of the transmitter was connected to base station simulator.

Set EUT at maximum average power by base station simulator.

Set RBW = 1-5% of the OBW, not to exceed 1 MHz.

Set VBW  $\geq 3 \times$  RBW.

Number of points in sweep  $\geq 2 \times$  span / RBW. (This gives bin-to-bin spacing  $\leq$  RBW/2, so that narrowband signals are not lost between frequency bins.)

Sweep time = auto.

Detector = RMS (power averaging).

Set sweep trigger to "free run".

Trace average at least 100 traces in power averaging (i.e., RMS) mode; however, the number of traces to be averaged shall be increased above 100 as needed such that the average accurately represents the true average over the on and off periods of the transmitter.

Compute power by integrating the spectrum across the OBW of the signal using the instrument's band power measurement function with band limits set equal to the OBW band edges. If the instrument does not have a band power function, sum the spectrum levels (in power units) at intervals equal to the RBW extending across the entire OBW of the spectrum.

Add  $10 \log(1/x)$ , where x is the duty cycle, to the measured power in order to compute the average power during the actual transmission times (because the measurement represents an average over both the on and off times of the transmission). For example, add  $10 \log(1/0.25) = 6$  dB if the duty cycle is a constant 25%.

Measure lowest, middle, and highest channels for each bandwidth and different modulation.

Measure and record the results in the test report.

**7.3.6 Test Results**

EUT:	Mobile Phone	Model No.:	GQ3081
Temperature:	20 °C	Relative Humidity:	48%
Test Mode:	GSM/GPRS/EGPR S850/ GSM/GPRS/EGPRS 1900 UMTS band II/ UMTS band V/ UMTS band IV	Test By:	Cheng Jiawen

Output Power for GSM850

Mode	Frequency (MHz)	Maximum Burst-Average Output Power
GSM850	824.2	32.50
	836.6	32.37
	848.8	32.47
GPRS850 (1 Slot)	824.2	32.45
	836.6	32.41
	848.8	32.48
GPRS850 (2 Slot)	824.2	30.45
	836.6	30.48
	848.8	30.39
GPRS850 (3 Slot)	824.2	29.35
	836.6	29.48
	848.8	29.45
GPRS850 (4 Slot)	824.2	28.47
	836.6	28.50
	848.8	28.34
EGPRS850 (1 Slot)	824.2	27.44
	836.6	27.41
	848.8	27.48
EGPRS850 (2 Slot)	824.2	26.49
	836.6	26.43
	848.8	26.38
EGPRS850 (3 Slot)	824.2	25.34
	836.6	25.48
	848.8	25.48
EGPRS850 (4 Slot)	824.2	24.33
	836.6	24.42
	848.8	24.49

N/A: Not Applicable

Output Power for PCS1900

Mode	Frequency (MHz)	Maximum Burst-Average Output Power
GSM1900	1850.2	29.45
	1880	29.47
	1909.8	29.31
GPRS1900 (1 Slot)	1850.2	29.43
	1880	29.38
	1909.8	29.32
GPRS1900 (2 Slot)	1850.2	28.44
	1880	28.48
	1909.8	28.46
GPRS1900 (3 Slot)	1850.2	27.50
	1880	27.42
	1909.8	27.35
GPRS1900 (4 Slot)	1850.2	26.47
	1880	26.46
	1909.8	26.34
EGPRS1900 (1 Slot)	1850.2	25.42
	1880	25.46
	1909.8	25.38
EGPRS1900 (2 Slot)	1850.2	24.39
	1880	24.47
	1909.8	24.45
EGPRS1900 (3 Slot)	1850.2	23.47
	1880	23.43
	1909.8	23.41
EGPRS1900 (4 Slot)	1850.2	22.37
	1880	22.48
	1909.8	22.42

N/A: Not Applicable

Output Power for UMTS BAND II

Mode	Frequency(MHz)	Maximum Burst-Average Output Power
WCDMA 1900 RMC	1852.4	22.49
	1880	22.48
	1907.6	22.47
WCDMA 1900 AMR	1852.4	22.04
	1880	22.36
	1907.6	22.15
HSDPA Subtest 1	1852.4	21.44
	1880	21.48
	1907.6	21.49
HSDPA Subtest 2	1852.4	20.37
	1880	20.32
	1907.6	20.47
HSDPA Subtest 3	1852.4	20.39
	1880	20.38
	1907.6	20.29
HSDPA Subtest 4	1852.4	20.34
	1880	20.29
	1907.6	20.32
HSUPA Subtest 1	1852.4	20.45
	1880	20.34
	1907.6	20.35
HSUPA Subtest 2	1852.4	20.41
	1880	20.37
	1907.6	20.36
HSUPA Subtest 3	1852.4	20.33
	1880	20.41
	1907.6	20.42
HSUPA Subtest 4	1852.4	20.31
	1880	20.47
	1907.6	20.41
HSUPA Subtest 5	1852.4	21.45
	1880	21.48
	1907.6	21.50



Output Power for UMTS BAND V

Mode	Frequency(MHz)	Maximum Burst-Average Output Power
WCDMA 850 RMC	826.4	23.45
	835	23.49
	846.6	23.48
WCDMA 850 AMR	826.4	23.19
	835	23.10
	846.6	22.97
HSDPA Subtest 1	826.4	22.24
	835	22.35
	846.6	22.14
HSDPA Subtest 2	826.4	21.45
	835	21.44
	846.6	21.39
HSDPA Subtest 3	826.4	21.36
	835	21.33
	846.6	21.50
HSDPA Subtest 4	826.4	21.32
	835	21.40
	846.6	21.37
HSUPA Subtest 1	826.4	21.45
	835	21.37
	846.6	21.38
HSUPA Subtest 2	826.4	21.29
	835	21.32
	846.6	21.41
HSUPA Subtest 3	826.4	21.42
	835	21.30
	846.6	21.45
HSUPA Subtest 4	826.4	21.31
	835	21.48
	846.6	21.41
HSUPA Subtest 5	826.4	22.30
	835	22.42
	846.6	22.10

Output Power for UMTS BAND IV

Mode	Frequency(MHz)	Maximum Burst-Average Output Power
WCDMA Band IV RMC	1712.4	23.21
	1732.4	23.18
	1752.6	23.20
WCDMA Band IV AMR	1712.4	23.13
	1732.4	23.17
	1752.6	23.15
HSDPA Subtest 1	1712.4	22.20
	1732.4	22.12
	1752.6	22.01
HSDPA Subtest 2	1712.4	21.12
	1732.4	21.09
	1752.6	21.14
HSDPA Subtest 3	1712.4	21.10
	1732.4	21.13
	1752.6	21.12
HSDPA Subtest 4	1712.4	21.11
	1732.4	21.24
	1752.6	21.24
HSUPA Subtest 1	1712.4	21.08
	1732.4	21.20
	1752.6	21.20
HSUPA Subtest 2	1712.4	21.07
	1732.4	21.16
	1752.6	21.17
HSUPA Subtest 3	1712.4	21.13
	1732.4	21.17
	1752.6	21.14
HSUPA Subtest 4	1712.4	21.06
	1732.4	21.14
	1752.6	21.10
HSUPA Subtest 5	1712.4	22.18
	1732.4	22.10
	1752.6	22.04

**7.4 FREQUENCY STABILITY**

**7.4.1 Applicable Standard**

According to FCC Part 2.1055 and FCC Part 22.355 and FCC Part 24.235 and FCC KDB 971168 D01 Section 9.0

**7.4.2 Conformance Limit**

The frequency stability shall be measured by variation of ambient temperature and variation of primary supply voltage to ensure that the fundamental emission stays within the authorized frequency block. The frequency stability of the transmitter shall be maintained within  $\pm 0.00025\%$  ( $\pm 2.5\text{ppm}$ ) of the center frequency.

**7.4.3 Measuring Instruments**

The Measuring equipment is listed in the section 6.3 of this test report.

**7.4.4 Test Setup**

Please refer to Section 6.1 of this test report.

**7.4.5 Test Procedure**

Connect the EUT to Universal Radio Communication Tester CMU200 or CMU500 via the antenna connector. A call is set up by the SS according to the generic call set up procedure on a channel with ARFCN in the ARFCN range, power control level set to Max power. MS TXPWR\_MAX\_CCH is set to the maximum value supported by the Power Class of the Mobile under test.

EUT was placed at temperature chamber and connected to an external power supply. Temperature and voltage condition shall be tested to confirm frequency stability.

For Temperature Variation

1. The testing follows FCC KDB 971168 D01 v03 Section 9.0.
2. The EUT was set up in the thermal chamber and connected with the system simulator.
3. With power OFF, the temperature was decreased to  $-30^{\circ}\text{C}$  and the EUT was stabilized before testing. Power was applied and the maximum change in frequency was recorded within one minute.
4. With power OFF, the temperature was raised in  $10^{\circ}\text{C}$  steps up to  $50^{\circ}\text{C}$ . The EUT was stabilized at each step for at least half an hour. Power was applied and the maximum frequency change was recorded within one minute.

For Voltage Variation

1. The testing follows FCC KDB 971168 D01 v03 Section 9.0.
2. The EUT was placed in a temperature chamber at  $25\pm 5^{\circ}\text{C}$  and connected with the system simulator.
3. The power supply voltage to the EUT was varied from 85% to 115% of the nominal value measured at the input to the EUT.
4. The variation in frequency was measured for the worst case.

**7.4.6 Test Results**

EUT:	Mobile Phone	Model No.:	GQ3081
Temperature:	20 °C	Relative Humidity:	48%
Test Mode:	GSM/GPRS/EGPRS 850/ GSM/GPRS/EGPRS 1900 UMTS band II/ UMTS band V/ UMTS band IV	Test By:	Cheng Jiawen

Results: PASS

Frequency Error Against Voltage for GSM 850 band		
Voltage (V)	Frequency Error (Hz)	Frequency Error (ppm)
3.4	-10	-0.0120
3.85	-11	-0.0131
4.2	-11	-0.0131

Frequency Error Against Temperature for GSM 850 band		
Temperature (°C)	Frequency Error (Hz)	Frequency Error (ppm)
-30	-9	-0.0108
-20	-15	-0.0179
-10	-11	-0.0131
0	-19	-0.0227
10	-16	-0.0191
20	-17	-0.0203
30	-13	-0.0155
40	-10	-0.0120
50	-14	-0.0167

Frequency Error Against Voltage for GPRS850 band		
Voltage (V)	Frequency Error (Hz)	Frequency Error (ppm)
3.4	-9	-0.0108
3.85	-13	-0.0155
4.2	-11	-0.0131

Frequency Error Against Temperature for GPRS850 band		
Temperature (°C)	Frequency Error (Hz)	Frequency Error (ppm)
-30	-14	-0.0167
-20	-15	-0.0179
-10	-13	-0.0155
0	-12	-0.0143
10	-7	-0.0084
20	-5	-0.0060
30	-10	-0.0120
40	-8	-0.0096
50	-4	-0.0048

Frequency Error Against Voltage for EGPRS850 band		
Voltage (V)	Frequency Error (Hz)	Frequency Error (ppm)
3.4	-5	-0.0060
3.85	-9	-0.0108
4.2	-10	-0.0120

Frequency Error Against Temperature for EGPRS850 band		
Temperature (°C)	Frequency Error (Hz)	Frequency Error (ppm)
-30	-5	-0.0060
-20	-11	-0.0131
-10	-8	-0.0096
0	-6	-0.0072
10	-7	-0.0084
20	-7	-0.0084
30	-9	-0.0108
40	-11	-0.0131
50	-11	-0.0131

Note:

1. Normal Voltage = 3.85V; Battery End Point (BEP) = 3.4V; Maximum Voltage =4.2V
2. The frequency fundamental emissions stay within the authorized frequency block based on the frequency deviation measured is small.

Frequency Error Against Voltage for PCS 1900 band		
Voltage (V)	Frequency Error (Hz)	Frequency Error (ppm)
3.4	-17	-0.0090
3.85	-14	-0.0074
4.2	-20	-0.0106

Frequency Error Against Temperature for PCS 1900 band		
Temperature (°C)	Frequency Error (Hz)	Frequency Error (ppm)
-30	-19	-0.0101
-20	-16	-0.0085
-10	-15	-0.0080
0	-21	-0.0112
10	-19	-0.0101
20	-23	-0.0122
30	-23	-0.0122
40	-16	-0.0085
50	-17	-0.0090

Frequency Error Against Voltage for GPRS1900 band		
Voltage (V)	Frequency Error (Hz)	Frequency Error (ppm)
3.4	-13	-0.0069
3.85	-19	-0.0101
4.2	-22	-0.0117

Frequency Error Against Temperature for GPRS1900 band		
Temperature (°C)	Frequency Error (Hz)	Frequency Error (ppm)
-30	-14	-0.0074
-20	-17	-0.0090
-10	-21	-0.0112
0	-16	-0.0085
10	-15	-0.0080
20	-19	-0.0101
30	-18	-0.0096
40	-13	-0.0069
50	-16	-0.0085

Frequency Error Against Voltage for EGPRS1900 band		
Voltage (V)	Frequency Error (Hz)	Frequency Error (ppm)
3.4	-11	-0.0059
3.85	-16	-0.0085
4.2	-19	-0.0101

Frequency Error Against Temperature for EGPRS1900 band		
Temperature (°C)	Frequency Error (Hz)	Frequency Error (ppm)
-30	-14	-0.0074
-20	-21	-0.0112
-10	-17	-0.0090
0	-22	-0.0117
10	-18	-0.0096
20	-17	-0.0090
30	-15	-0.0080
40	-14	-0.0074
50	-16	-0.0085

**Note:**

1. Normal Voltage = 3.85V; Battery End Point (BEP) = 3.4V; Maximum Voltage =4.2V
2. The frequency fundamental emissions stay within the authorized frequency block based on the frequency deviation measured is small.

Frequency Error Against Voltage for UMTS band II		
Voltage (V)	Frequency Error (Hz)	Frequency Error (ppm)
3.4	-19	-0.0101
3.85	-13	-0.0069
4.2	-11	-0.0059

Frequency Error Against Temperature for UMTS band II		
Temperature (°C)	Frequency Error (Hz)	Frequency Error (ppm)
-30	-16	-0.0085
-20	-15	-0.0080
-10	-18	-0.0096
0	-19	-0.0101
10	-21	-0.0112
20	-20	-0.0106
30	-17	-0.0090
40	-19	-0.0101
50	-21	-0.0112

Frequency Error Against Voltage for UMTS band V		
Voltage (V)	Frequency Error (Hz)	Frequency Error (ppm)
3.4	-15	-0.0179
3.85	-12	-0.0143
4.2	-9	-0.0108

Frequency Error Against Temperature for UMTS band V		
Temperature (°C)	Frequency Error (Hz)	Frequency Error (ppm)
-30	-13	-0.0155
-20	-17	-0.0203
-10	-15	-0.0179
0	-10	-0.0120
10	-13	-0.0155
20	-12	-0.0143
30	-16	-0.0191
40	-14	-0.0167
50	-12	-0.0143



Frequency Error Against Voltage for UMTS band IV		
Voltage (V)	Frequency Error (Hz)	Frequency Error (ppm)
3.4	-13	-0.0075
3.85	-17	-0.0098
4.2	-13	-0.0075

Frequency Error Against Temperature for UMTS band IV		
Temperature (°C)	Frequency Error (Hz)	Frequency Error (ppm)
-30	-12	-0.0069
-20	-17	-0.0098
-10	-15	-0.0087
0	-11	-0.0063
10	-16	-0.0092
20	-14	-0.0081
30	-12	-0.0069
40	-15	-0.0087
50	-18	-0.0104

Note:

1. Normal Voltage = 3.85V; Battery End Point (BEP) = 3.4V; Maximum Voltage =4.2V
2. The frequency fundamental emissions stay within the authorized frequency block based on the frequency deviation measured is small.

## 7.5 PEAK-TO-AVERAGE RATIO

### 7.5.1 Applicable Standard

According to FCC 22.913 and FCC 24.232(d) and FCC KDB 971168 D01 Section 5.7.1

### 7.5.2 Conformance Limit

The peak-to-average power ratio (PAPR) of the transmitter output power must not exceed 13 dB. The PAPR measurements should be made using either an instrument with complementary cumulative distribution function (CCDF) capabilities to determine that PAPR will not exceed 13 dB for more than 0.1 percent of the time or other Commission approved procedure. The measurement must be performed using a signal corresponding to the highest PAPR expected during periods of continuous transmission.

### 7.5.3 Measuring Instruments

The Measuring equipment is listed in the section 6.3 of this test report.

### 7.5.4 Test Setup

Please refer to Section 6.1 of this test report.

### 7.5.5 Test Procedure

The EUT was connected to Spectrum Analyzer and Base Station via power divider.

The RF output of EUT was connected to the spectrum analyzer by RF cable and attenuator. The path loss was compensated to the results for each measurement.

Set the number of counts to a value that stabilizes the measured CCDF curve.

Set the measurement interval to 1 ms.

Record the maximum PAPR level associated with a probability of 0.1%.

a) Refer to instrument's analyzer instruction manual for details on how to use the power statistics/CCDF function;

b) Set resolution/measurement bandwidth  $\geq$  signal's occupied bandwidth;

c) Set the number of counts to a value that stabilizes the measured CCDF curve;

d) Set the measurement interval as follows:

1) for continuous transmissions, set to 1 ms,

2) for burst transmissions, employ an external trigger that is synchronized with the EUT burst timing sequence, or use the internal burst trigger with a trigger level that allows the burst to stabilize and set the measurement interval to a time that is less than or equal to the burst duration.

e) Record the maximum PAPR level associated with a probability of 0.1%.

### 7.5.6 Test Results

EUT:	Mobile Phone	Model No.:	GQ3081
Temperature:	20 °C	Relative Humidity:	48%
Test Mode:	GSM/GPRS/ EGPRS 850/ GSM/GPRS/ EGPRS 1900 /UMTS band II/ UMTS band V/ UMTS band IV	Test By:	Cheng Jiawen
Results: PASS			

Cellular Band						
Modes	GSM850			GSM1900		
Channel	128 (Low)	190 (Mid)	251 (High)	512 (Low)	661 (Mid)	810 (High)
Frequency(MHz)	824.2	836.6	848.8	1850.2	1880	1909.8
Peak-to-Average Ratio (dB)	2.62	2.62	2.62	2.63	2.64	2.65

Cellular Band						
Modes	GPRS850			GPRS1900		
Channel	128 (Low)	190 (Mid)	251 (High)	512 (Low)	661 (Mid)	810 (High)
Frequency(MHz)	824.2	836.6	848.8	1850.2	1880	1909.8
Peak-to-Average Ratio (dB)	2.62	2.62	2.62	2.63	2.64	2.66

Cellular Band						
Modes	EGPRS850			EGPRS1900		
Channel	128 (Low)	190 (Mid)	251 (High)	512 (Low)	661 (Mid)	810 (High)
Frequency(MHz)	824.2	836.6	848.8	1850.2	1880	1909.8
Peak-to-Average Ratio (dB)	5.36	5.36	5.35	5.70	6.00	6.02

UMTS Band						
Modes	WCDMA Band II (RMC 12.2Kbps)			WCDMA Band V (RMC 12.2Kbps)		
Channel	9262 (Low)	9400 (Mid)	9538 (High)	4132 (Low)	4175 (Mid)	4233 (High)
Frequency(MHz)	1852.4	1880	1907.6	826.4	836.6	846.6
Peak-to-Average Ratio (dB)	3.05	3.09	3.02	2.93	2.92	2.90

Modes	WCDMA Band IV (RMC 12.2Kbps)		
Channel	1312 (Low)	1412 (Mid)	1513 (High)
Frequency(MHz)	1712.4	1732.6	1752.6
Peak-to-Average Ratio (dB)	2.93	2.91	3.02

**Test plot**

(GSM850)

(GSM1900)

Peak-to-Average Ratio on channel 128

Peak-to-Average Ratio on channel 512



Peak-to-Average Ratio on channel 190

Peak-to-Average Ratio on channel 661

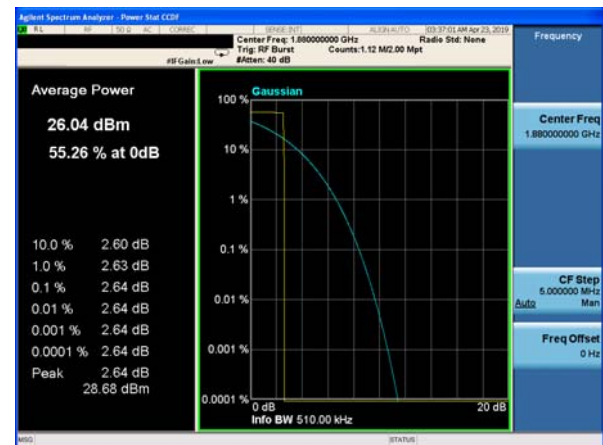
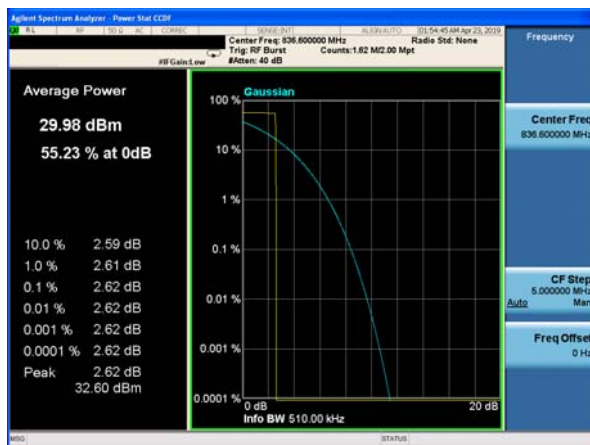

Peak-to-Average Ratio on channel 251

Peak-to-Average Ratio on channel 810

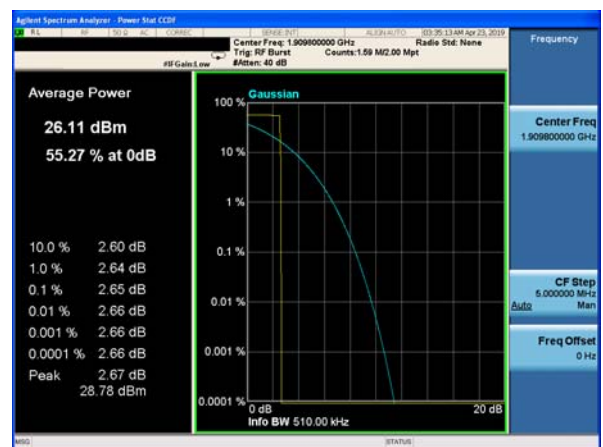
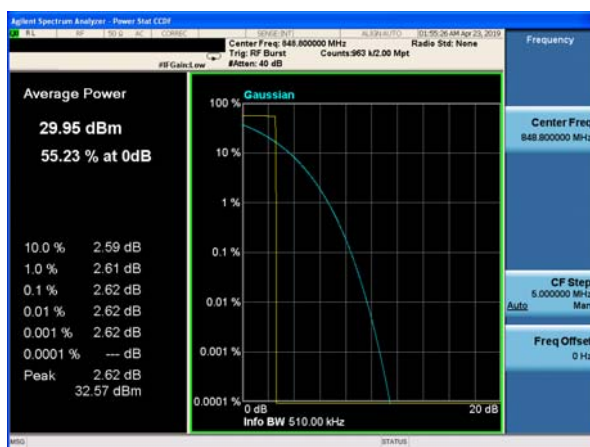

**Test plot**

(GPRS850)

(GPRS1900)

Peak-to-Average Ratio on channel 128

Peak-to-Average Ratio on channel 512

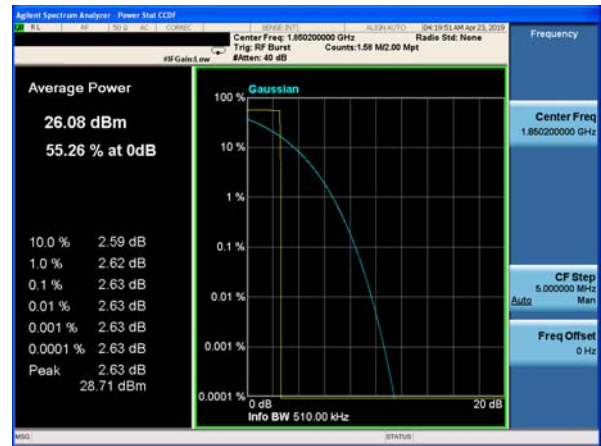
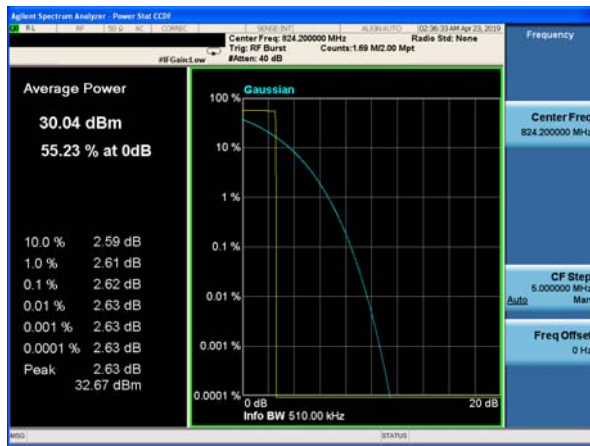

Peak-to-Average Ratio on channel 190

Peak-to-Average Ratio on channel 661

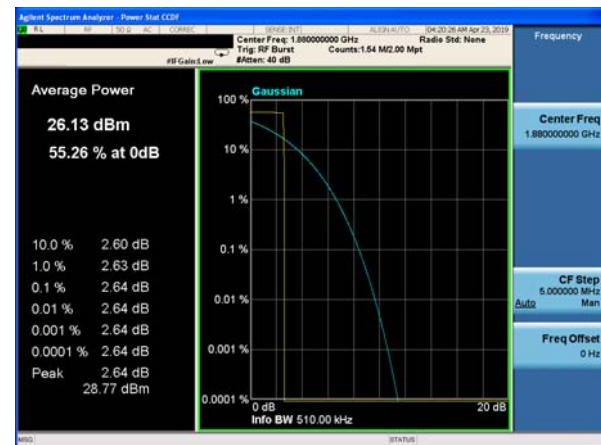
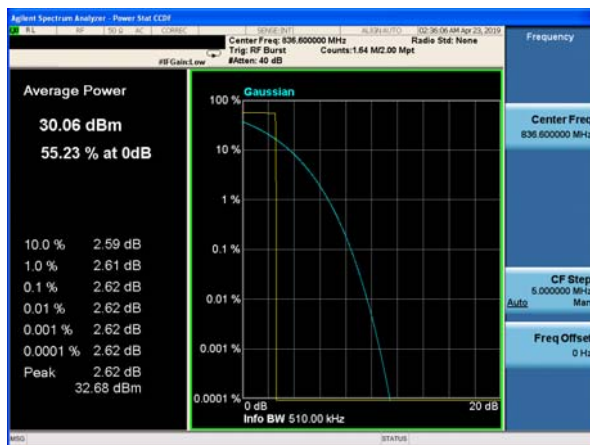

Peak-to-Average Ratio on channel 251

Peak-to-Average Ratio on channel 810

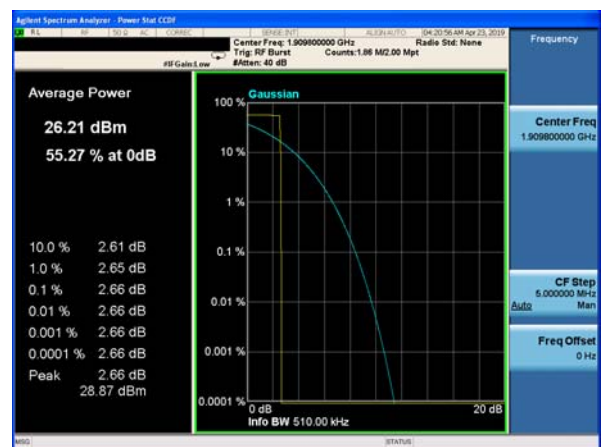
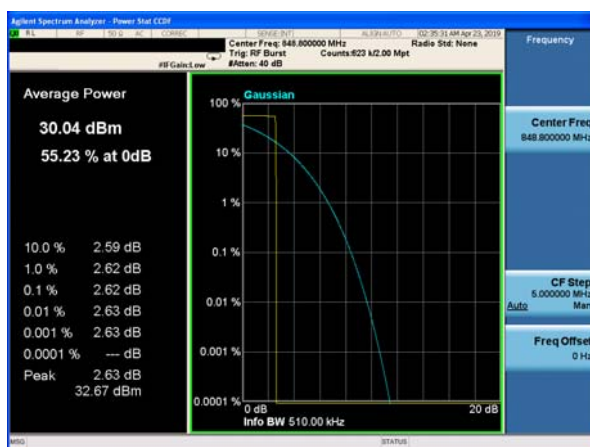

**Test plot**

(EGPRS850)

(EGPRS1900)

Peak-to-Average Ratio on channel 128

Peak-to-Average Ratio on channel 512

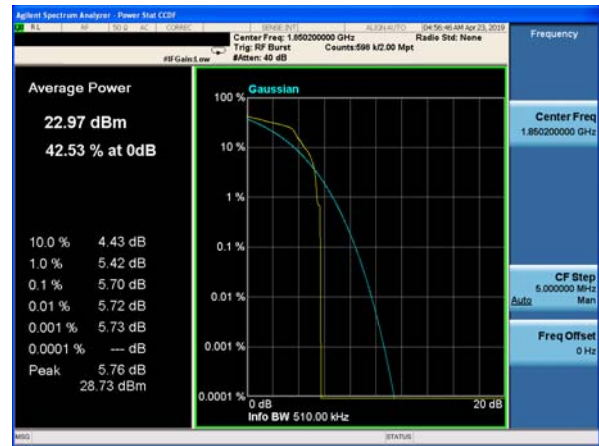
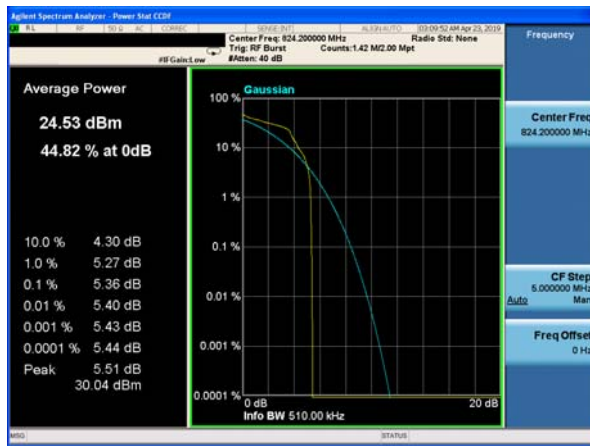

Peak-to-Average Ratio on channel 190

Peak-to-Average Ratio on channel 661

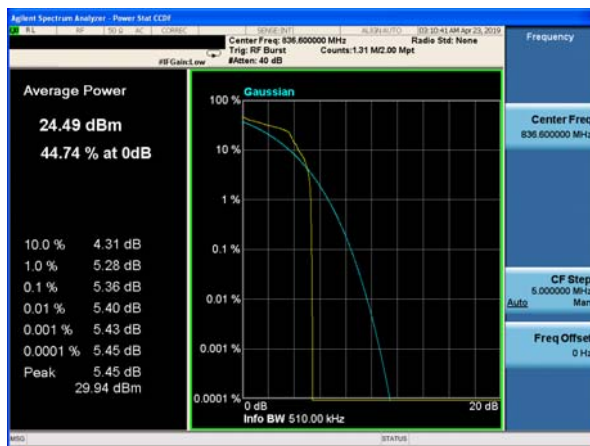

Peak-to-Average Ratio on channel 251

Peak-to-Average Ratio on channel 810

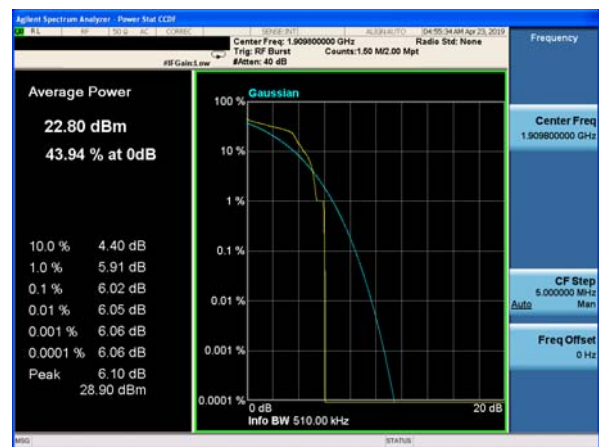

**Test plot**

**UMTS Band V**

**UMTS Band II**

**Peak-to-Average Ratio on channel 4132**

**Peak-to-Average Ratio on channel 9262**

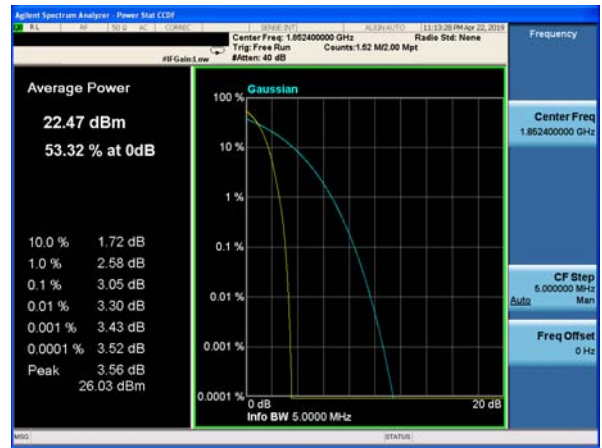
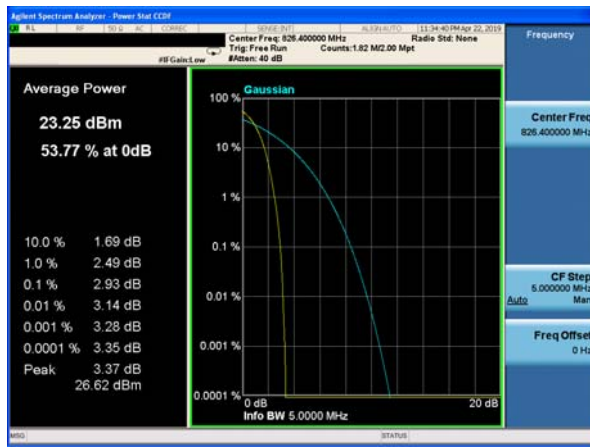

**Peak-to-Average Ratio on channel 4183**

**Peak-to-Average Ratio on channel 9400**



**Peak-to-Average Ratio on channel 4233**

**Peak-to-Average Ratio on channel 9538**

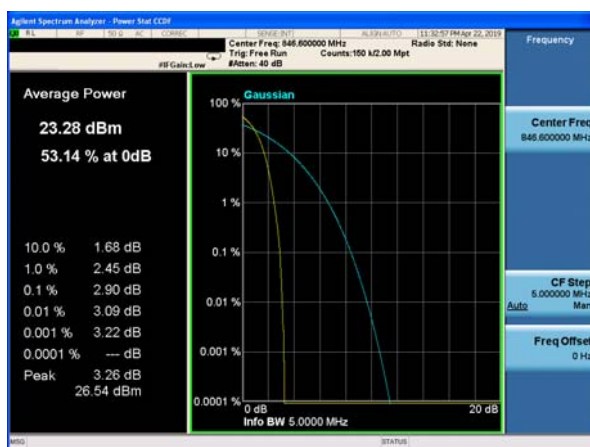

**Test plot**

UMTS Band IV

Peak-to-Average Ratio on channel 1312

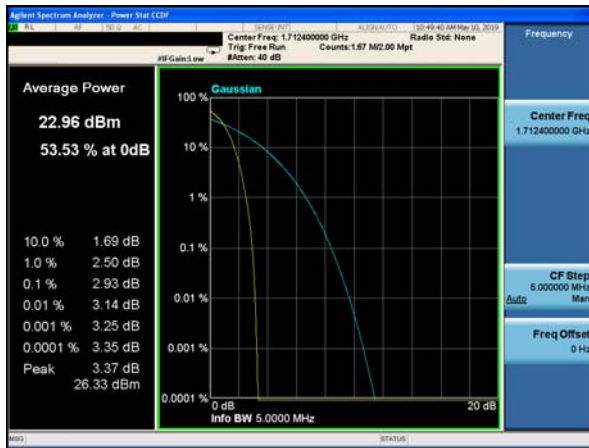

Peak-to-Average Ratio on channel 1412

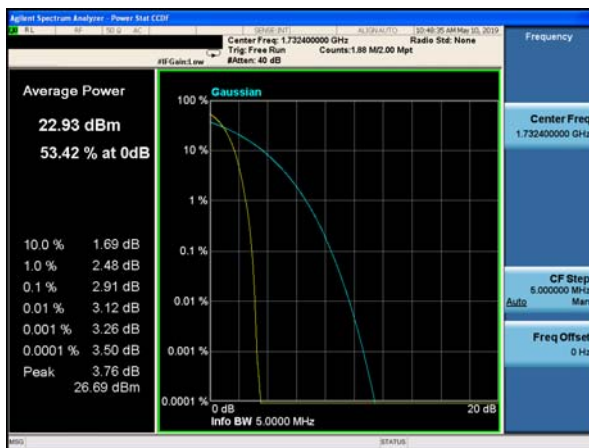

Peak-to-Average Ratio on channel 1513

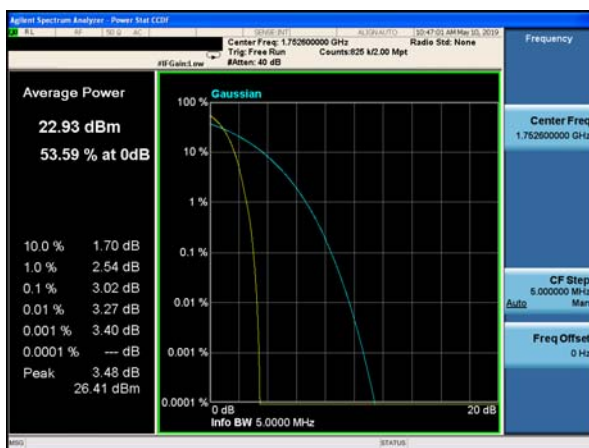



## 7.6 26DB BANDWIDTH AND 99% OCCUPIED BANDWIDTH

### 7.6.1 Applicable Standard

According to FCC Part 2.1049 and FCC Part 22H and FCC Part 24E and FCC KDB 971168 D01 Section 4.0

### 7.6.2 Conformance Limit

The occupied bandwidth is the width of a frequency band such that, below the lower and above the upper frequency limits, the mean powers emitted are each equal to a specified percentage 0.5% of the total mean transmitted power.

The 26 dB emission bandwidth is defined as the frequency range between two points, one above and one below the carrier frequency, at which the spectral density of the emission is attenuated 26 dB below the maximum in-band spectral density of the modulated signal. Spectral density (power per unit bandwidth) is to be measured with a detector of resolution bandwidth equal to approximately 1.0% of the emission bandwidth.

### 7.6.3 Measuring Instruments

The Measuring equipment is listed in the section 6.3 of this test report.

### 7.6.4 Test Setup

Please refer to Section 6.1 of this test report.

### 7.6.5 Test Procedure

The testing follows FCC KDB 971168 v03 Section 4.0.

The EUT was connected to Spectrum Analyzer and Base Station via power divider.

The RF output of EUT was connected to the spectrum analyzer by RF cable and attenuator. The path loss was compensated to the results for each measurement.

The spectrum analyzer center frequency is set to the nominal EUT channel center frequency. The span range for the spectrum analyzer shall be between two and five times the anticipated OBW.

The nominal resolution bandwidth (RBW) shall be in the range of 1 to 5 % of the anticipated OBW, and the VBW shall be at least 3 times the RBW.

Set the detection mode to peak, and the trace mode to max hold.

Determine the reference value: Set the EUT to transmit a modulated signal. Allow the trace to stabilize. Set the spectrum analyzer marker to the highest level of the displayed trace.

(this is the reference value)

Determine the “-26 dB down amplitude” as equal to (Reference Value – X).

Place two markers, one at the lowest and the other at the highest frequency of the envelope of the spectral display such that each marker is at or slightly below the “-X dB down amplitude” determined in step 6. If a marker is below this “-X dB down amplitude” value it shall be placed as close as possible to this value. The OBW is the positive frequency difference between the two markers.

Use the 99 % power bandwidth function of the spectrum analyzer and report the measured bandwidth.

**7.6.6 Test Results**

EUT:	Mobile Phone	Model No.:	GQ3081
Temperature:	20 °C	Relative Humidity:	48%
Test Mode:	GSM/GPRS/EGPRS 850/ GSM/GPRS/EGPRS 1900 /UMTS band II/ UMTS band V/ UMTS band IV	Test By:	Cheng Jiawen
Results: PASS			

Operation Mode	Channel Number	Channel Frequency (MHz)	99% Occupied Bandwidth (kHz)	26dB Bandwidth (kHz)	Limit (kHz)	Verdict
GSM 850	128	824.2	248.29	317.8	N/A	PASS
	190	836.6	246.26	317.9	N/A	PASS
	251	848.8	247.31	320.6	N/A	PASS
GSM 1900	512	1850.2	247.74	322.6	N/A	PASS
	661	1880.0	247.18	324.2	N/A	PASS
	810	1909.8	245.46	316.6	N/A	PASS
GPRS 850	128	824.2	246.00	318.4	N/A	PASS
	190	836.6	243.73	321.8	N/A	PASS
	251	848.8	247.96	321.6	N/A	PASS
GPRS 1900	512	1850.2	245.48	322.9	N/A	PASS
	661	1880.0	243.49	319.2	N/A	PASS
	810	1909.8	246.69	324.1	N/A	PASS
EGPRS 850	128	824.2	252.91	317.3	N/A	PASS
	190	836.6	251.27	318.7	N/A	PASS
	251	848.8	250.67	318.9	N/A	PASS
EGPRS 1900	512	1850.2	246.77	320.3	N/A	PASS
	661	1880.0	242.41	312.3	N/A	PASS
	810	1909.8	243.80	320.4	N/A	PASS
UMTS Band V	4132	826.4	4178.1	4717	N/A	PASS
	4183	836.6	4163.8	4716	N/A	PASS
	4233	846.6	4161.3	4698	N/A	PASS
UMTS Band II	9262	1852.4	4172.0	4711	N/A	PASS
	9400	1880.0	4177.1	4704	N/A	PASS
	9538	1907.6	4162.4	4711	N/A	PASS
UMTS Band IV	1312	1712.4	4164.8	4699	N/A	PASS
	1412	1732.6	4160.5	4707	N/A	PASS
	1513	1752.6	4159.9	4717	N/A	PASS

**Test plot**

(GSM850)

(GSM1900)

-26dB&99% Bandwidth plot on channel 128

-26dB&99% Bandwidth plot on channel 512

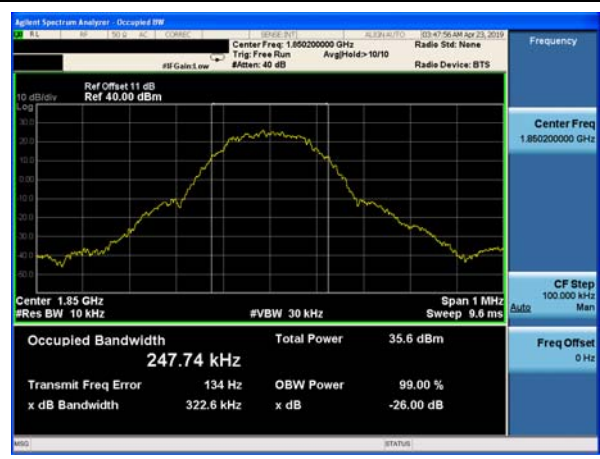
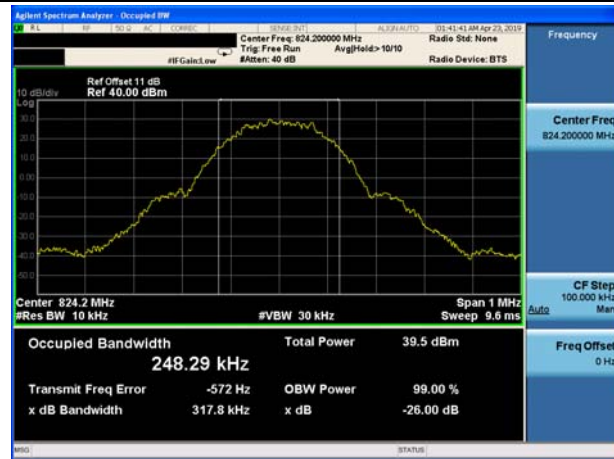

-26dB&99% Bandwidth plot on channel 190

-26dB&99% Bandwidth plot on channel 661



-26dB&99% Bandwidth plot on channel 251

-26dB&99% Bandwidth plot on channel 810

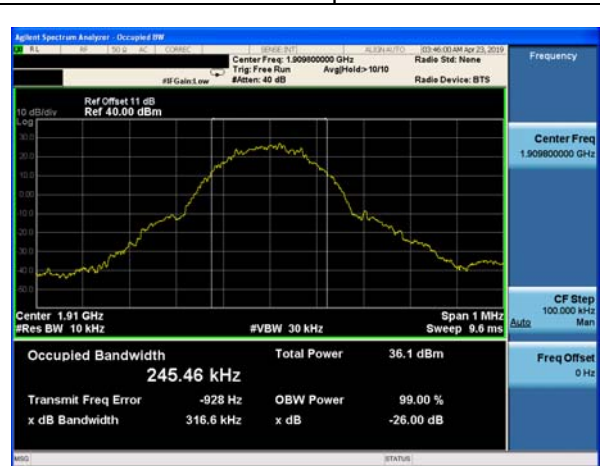
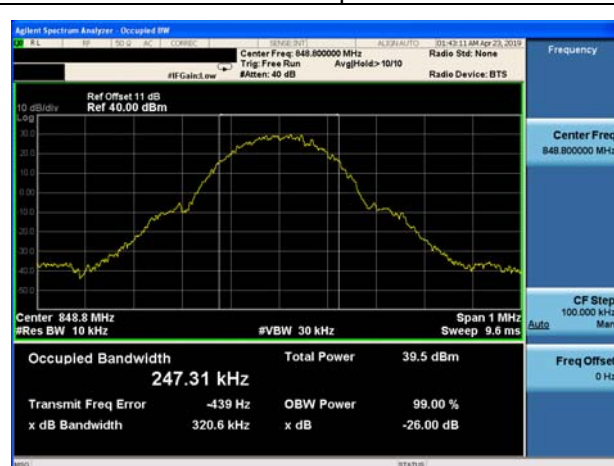

**Test plot**

(GPRS850)

(GPRS1900)

-26dB&99% Bandwidth plot on channel 128

-26dB&99% Bandwidth plot on channel 512

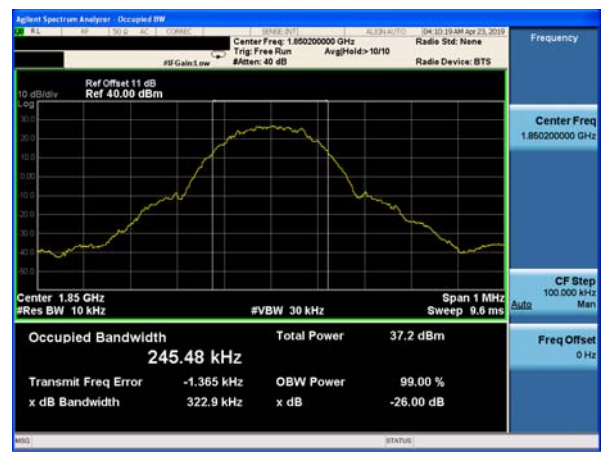
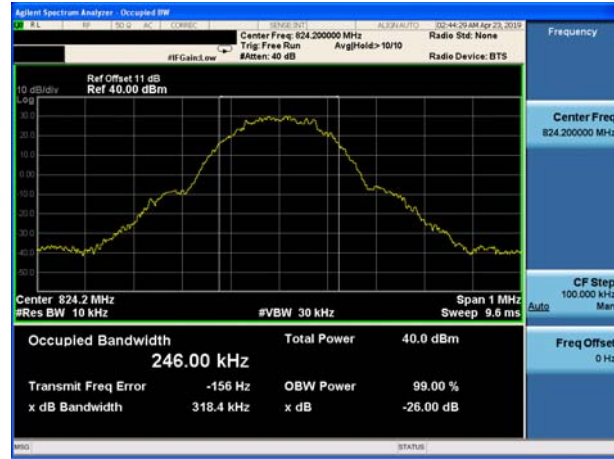

-26dB&99% Bandwidth plot on channel 190

-26dB&99% Bandwidth plot on channel 661

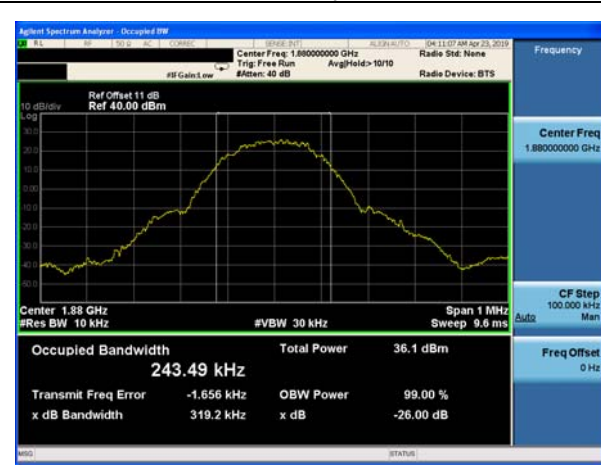
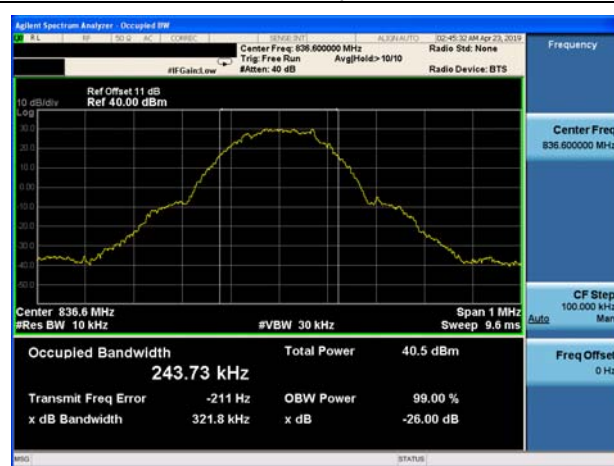

-26dB&99% Bandwidth plot on channel 251

-26dB&99% Bandwidth plot on channel 810



**Test plot**

(EGPRS850)

(EGPRS1900)

-26dB&99% Bandwidth plot on channel 128

-26dB&99% Bandwidth plot on channel 512

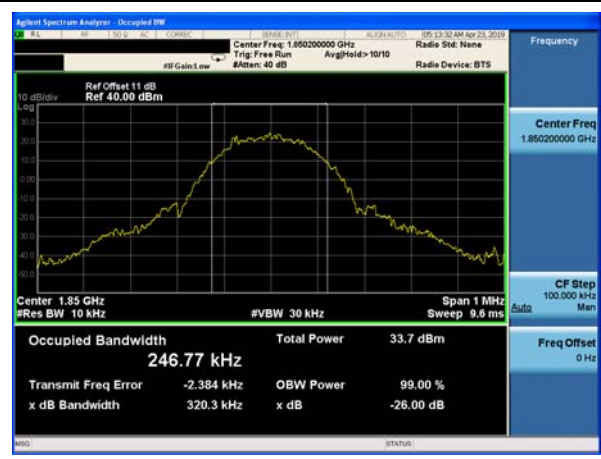

-26dB&99% Bandwidth plot on channel 190

-26dB&99% Bandwidth plot on channel 661

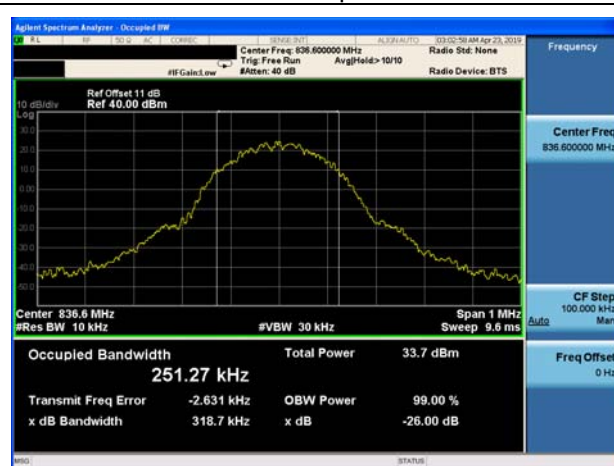

-26dB&99% Bandwidth plot on channel 251

-26dB&99% Bandwidth plot on channel 810

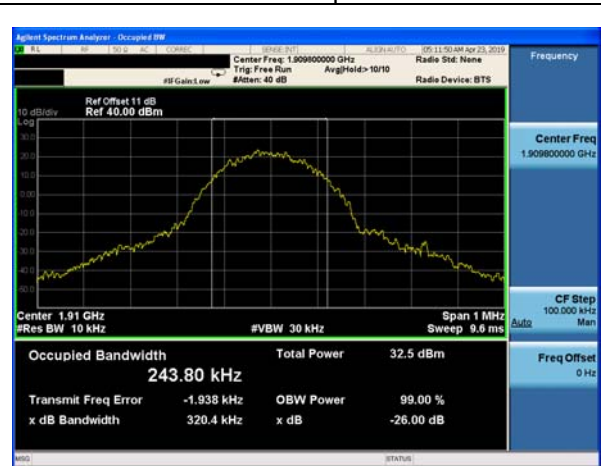
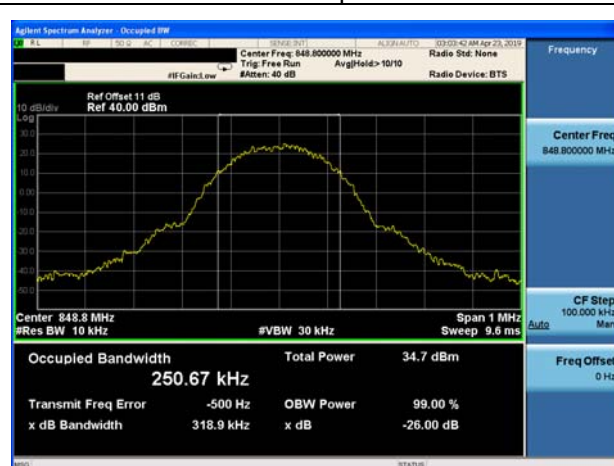

**Test plot**

**UMTS Band V**

**UMTS Band II**

**-26dB&99% Bandwidth plot on channel 4132**

**-26dB&99% Bandwidth plot on channel 9262**

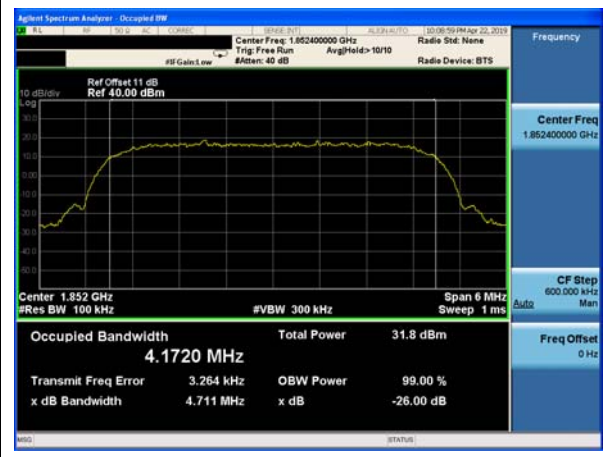

**-26dB&99% Bandwidth plot on channel 4183**

**-26dB&99% Bandwidth plot on channel 9400**

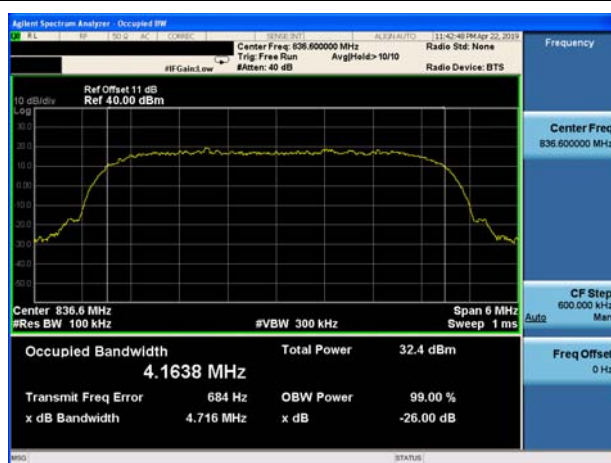

**-26dB&99% Bandwidth plot on channel 4233**

**-26dB&99% Bandwidth plot on channel 9538**

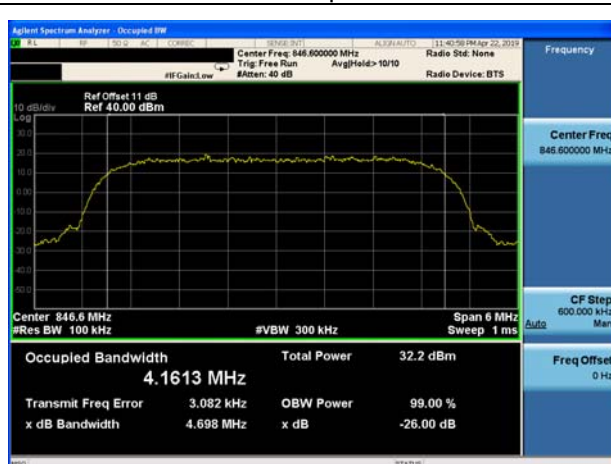

**Test plot**

UMTS Band IV

-26dB&99% Bandwidth plot on channel 1312



-26dB&99% Bandwidth plot on channel 1412



-26dB&99% Bandwidth plot on channel 1513



**7.7 CONDUCTED BAND EDGE**

**7.7.1 Applicable Standard**

According to FCC Part 2.1051 and FCC Part 22.917(a) and 24.238(a) and FCC KDB 971168 D01 Section6.0

**7.7.2 Conformance Limit**

The power of any emission outside of the authorized operating frequency ranges must be lower than the transmitter power (P) by a factor of at least  $43 + 10 \log (P)$  dB.

**7.7.3 Measuring Instruments**

The Measuring equipment is listed in the section 6.3 of this test report.

**7.7.4 Test Setup**

Please refer to Section 6.1 of this test report.

**7.7.5 Test Procedure**

The testing follows FCC KDB 971168 v03 Section 6.0.  
 The EUT was connected to Spectrum Analyzer and Base Station via power divider.  
 The RF output of EUT was connected to the spectrum analyzer by RF cable and attenuator.  
 The path loss was compensated to the results for each measurement.  
 The band edges of low and high channels for the highest RF powers were measured.  
 The RF fundamental frequency should be excluded against the limit line in the operating frequency band.  
 The limit line is derived from  $43 + 10\log(P)$  dB below the transmitter power P(Watts)  
 =  $P(W) - [43 + 10\log(P)]$  (dB)  
 =  $[30 + 10\log(P)]$  (dBm) -  $[43 + 10\log(P)]$  (dB)  
 = -13dBm.

**7.7.6 Test Results**

EUT:	Mobile Phone	Model No.:	GQ3081
Temperature:	20 °C	Relative Humidity:	48%
Test Mode:	GSM/GPRS/EGPRS 850/ GSM/GPRS/EGPRS 1900/ UMTS band II/ UMTS band V/ UMTS band IV	Test By:	Cheng Jiawen
Results: PASS			



**Test plot For**

(GSM850)

(GSM1900)

Conducted Band Edge plot on channel 128

Conducted Band Edge plot on channel 512

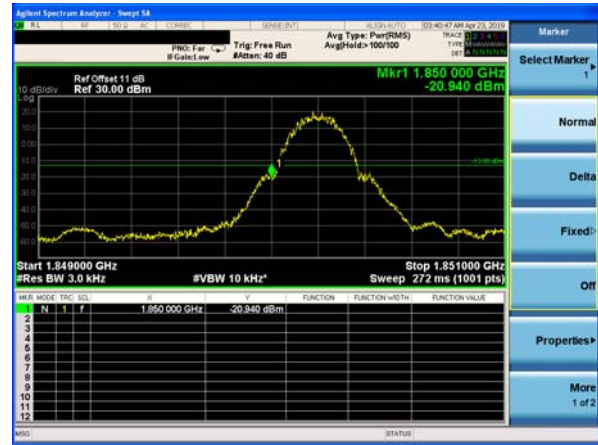
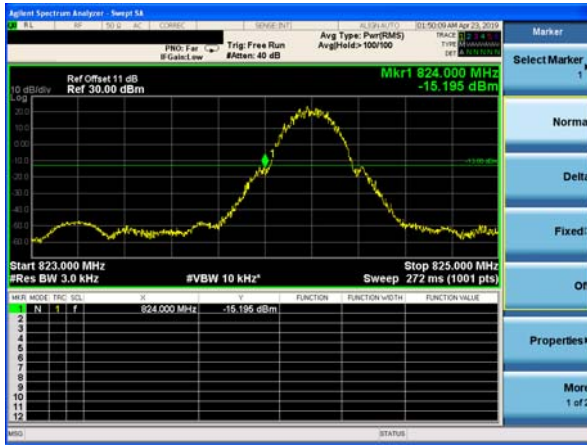

Conducted Band Edge plot on channel 251

Conducted Band Edge plot on channel 810

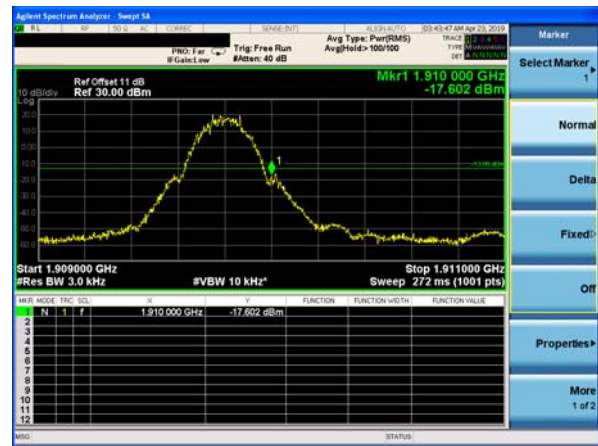
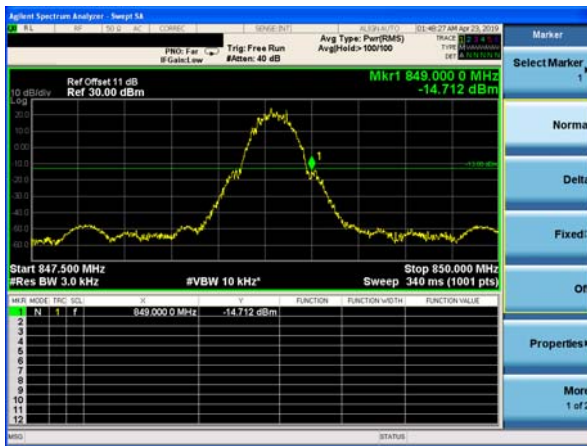

**Test plot For**

(GPRS850)

(GPRS1900)

Conducted Band Edge plot on channel 128

Conducted Band Edge plot on channel 512

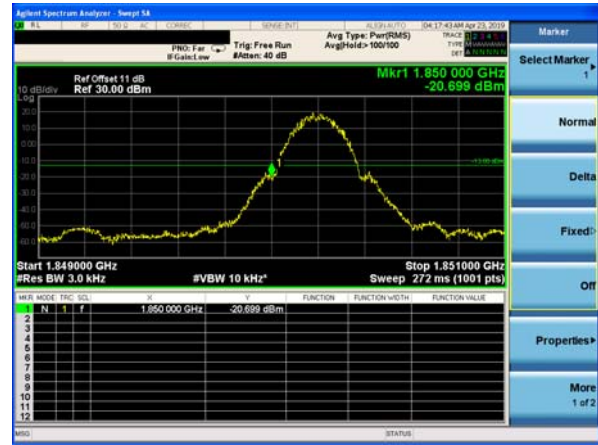
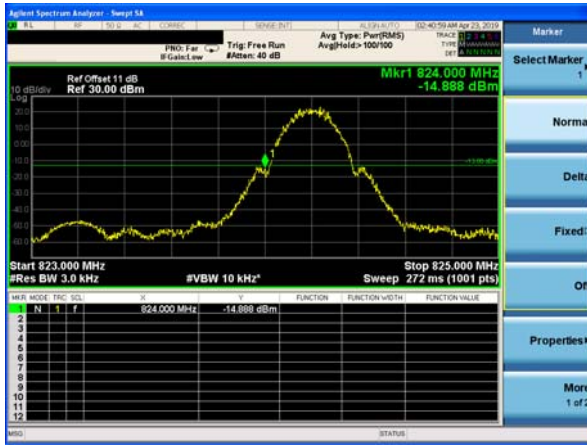

Conducted Band Edge plot on channel 251

Conducted Band Edge plot on channel 810

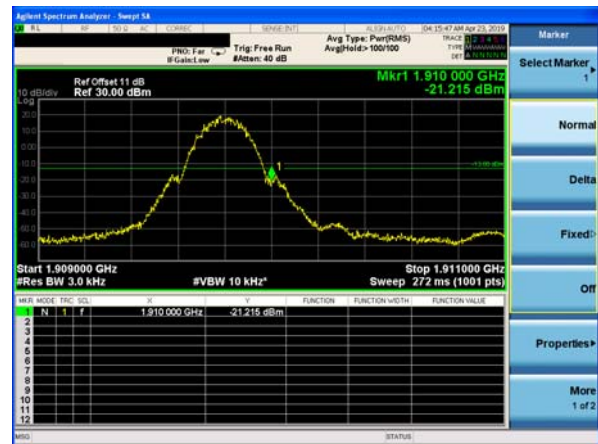
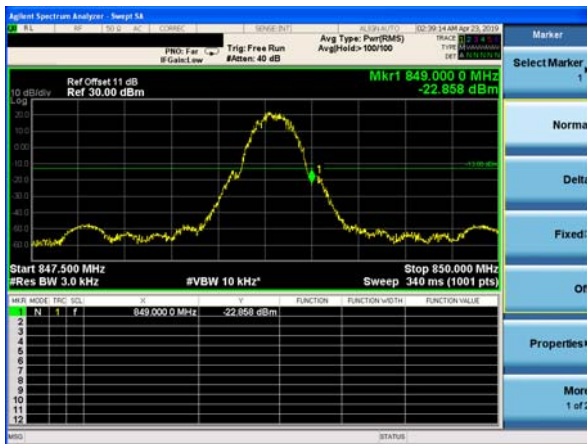

**Test plot For**

(EGPRS850)

(EGPRS1900)

Conducted Band Edge plot on channel 128

Conducted Band Edge plot on channel 512

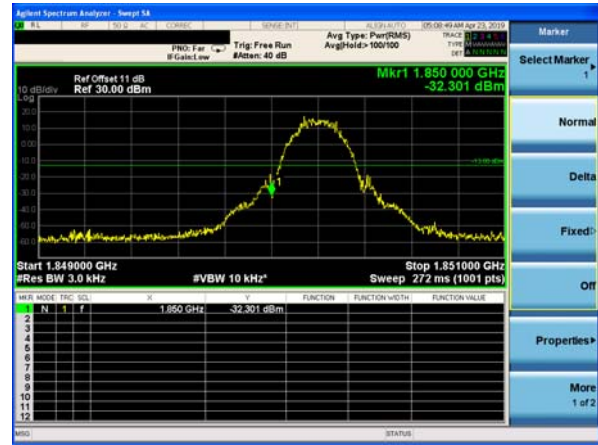
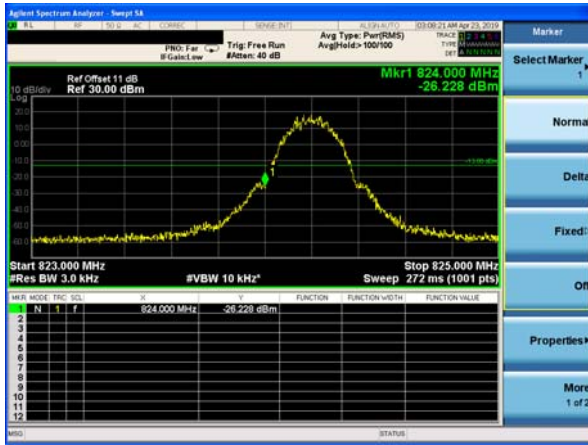

Conducted Band Edge plot on channel 251

Conducted Band Edge plot on channel 810

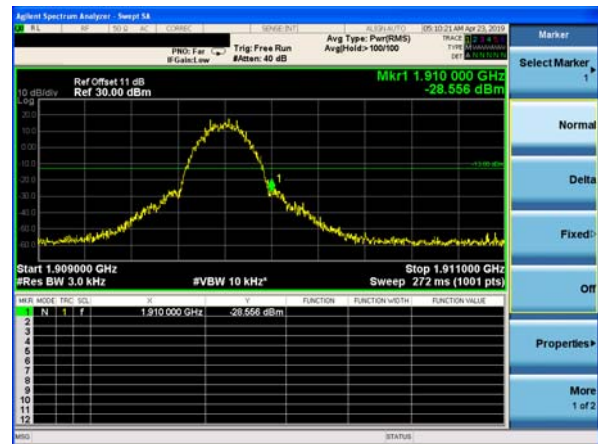
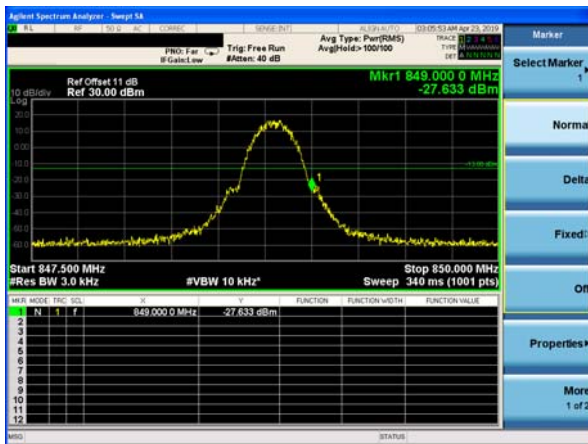

**Test plot For**

UMTS Band V

UMTS Band II

Conducted Band Edge plot on channel 4132

Conducted Band Edge plot on channel 9262



Conducted Band Edge plot on channel 4233

Conducted Band Edge plot on channel 9538



Test plot For

UMTS Band IV

Conducted Band Edge plot on channel 1312



Conducted Band Edge plot on channel 1513

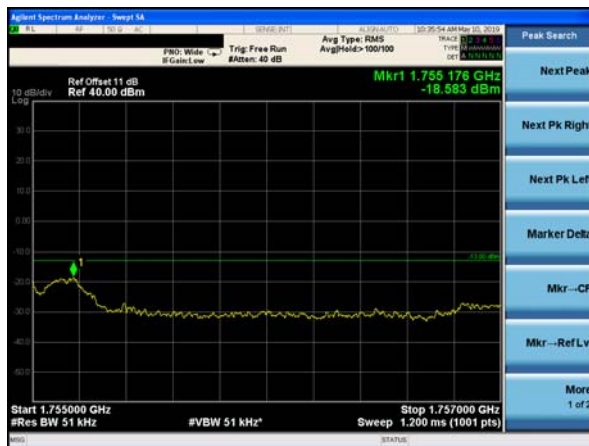

**7.8 CONDUCTED SPURIOUS EMISSION AT ANTENNA TERMINAL**

**7.8.1 Applicable Standard**

According to FCC Part 2.1051 and FCC Part 22.917(a) and Part 24.238(a) and FCC KDB 971168 D01 Section6.0

**7.8.2 Conformance Limit**

The power of any emission outside of the authorized operating frequency ranges must be lower than the transmitter power (P) by a factor of at least  $43 + 10 \log(P)$  dB.  
It is measured by means of a calibrated spectrum analyzer and scanned from 30 MHz up to a frequency including its 10th harmonic.

**7.8.3 Measuring Instruments**

The Measuring equipment is listed in the section 6.3 of this test report.

**7.8.4 Test Setup**

Please refer to Section 6.1 of this test report.

**7.8.5 Test Procedure**

The testing follows FCC KDB 971168 v03 Section 6.0.  
The EUT was connected to Spectrum Analyzer and Base Station via power divider.  
The RF output of EUT was connected to the spectrum analyzer by RF cable and attenuator.  
The path loss was compensated to the results for each measurement.  
The middle channel for the highest RF power within the transmitting frequency was measured.  
The conducted spurious emission for the whole frequency range was taken.  
The RF fundamental frequency should be excluded against the limit line in the operating frequency band.  
The limit line is derived from  $43 + 10\log(P)$  dB below the transmitter power P(Watts)  
 $= P(W) - [43 + 10\log(P)]$  (dB)  
 $= [30 + 10\log(P)]$  (dBm) -  $[43 + 10\log(P)]$  (dB)  
 $= -13dBm$ .

**7.8.6 Test Results**

EUT:	Mobile Phone	Model No.:	GQ3081
Temperature:	20 °C	Relative Humidity:	48%
Test Mode:	GSM/GPRS/EGPRS 850/ GSM/GPRS/EGPRS 1900/ UMTS band II/ UMTS band V/ UMTS band IV	Test By:	Cheng Jiawen
Results: PASS			

**Test Plot**

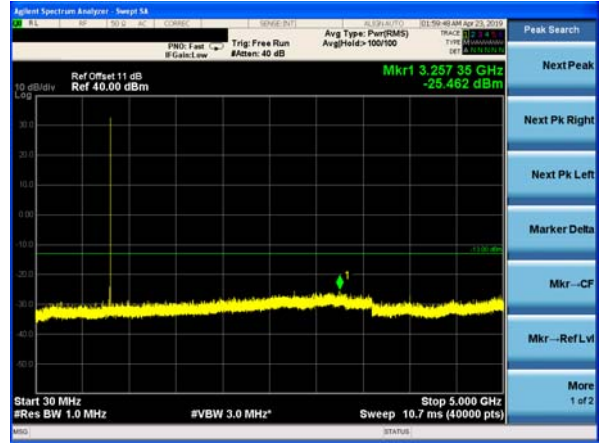
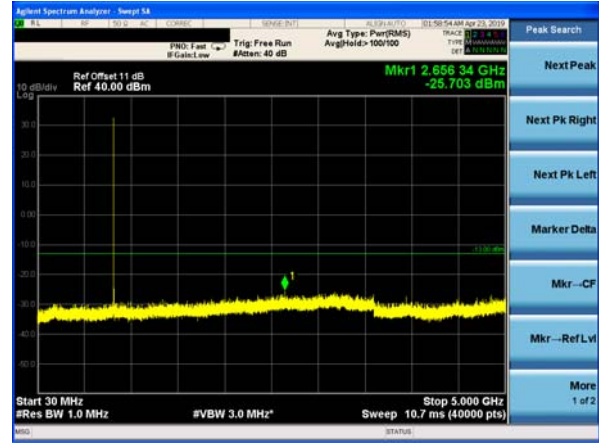
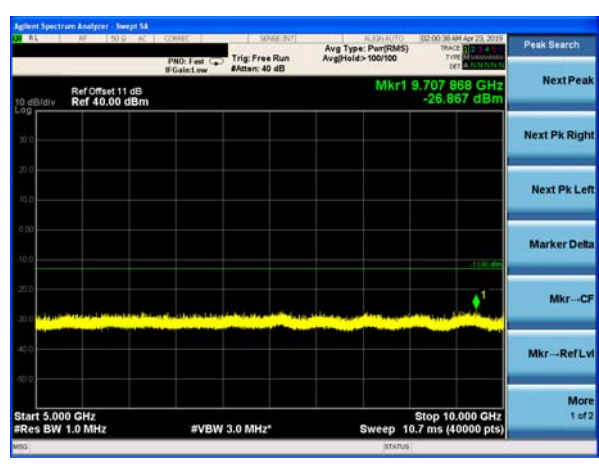
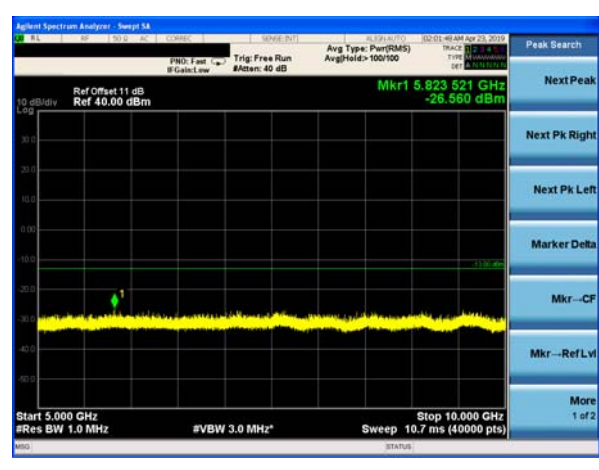
GSM850	GSM850
<p>Conducted Emission Transmitting Mode CH 128 30MHz – 5GHz</p>	<p>Conducted Emission Transmitting Mode CH 190 30MHz – 5GHz</p>
	
<p>Conducted Emission Transmitting Mode CH 128 5GHz – 10GHz</p>	<p>Conducted Emission Transmitting Mode CH 190 5GHz – 10GHz</p>
	

**Test Plot**

**GSM850**

**GSM1900**

Conducted Emission Transmitting Mode CH 251  
30MHz – 5GHz

Conducted Emission Transmitting Mode CH 512  
30MHz – 10GHz

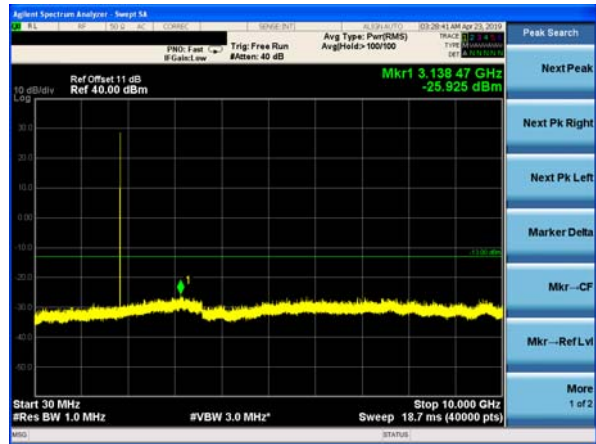
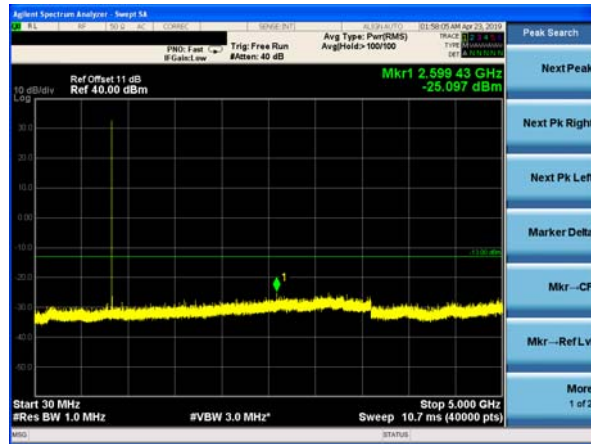

Conducted Emission Transmitting Mode CH 251  
5GHz – 10GHz

Conducted Emission Transmitting Mode CH 512  
10GHz – 20GHz

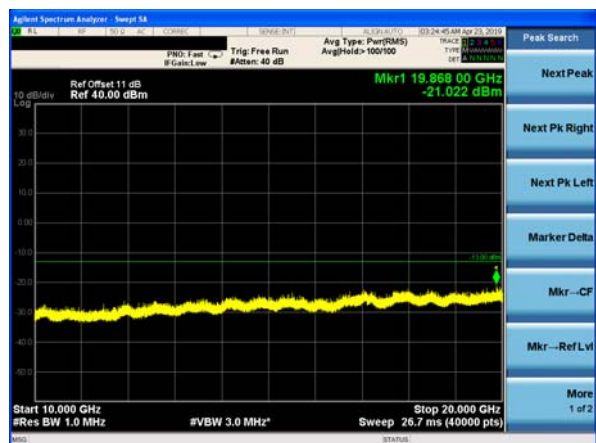
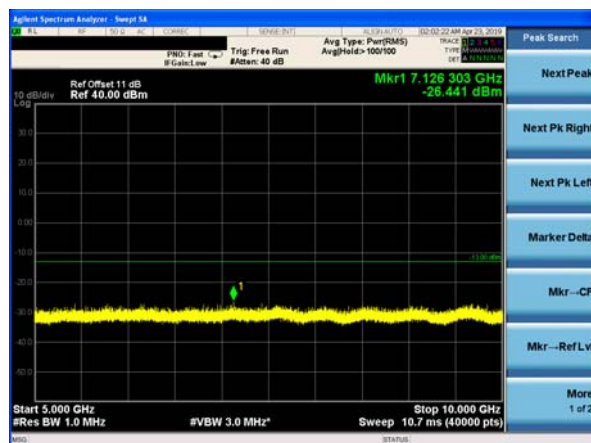

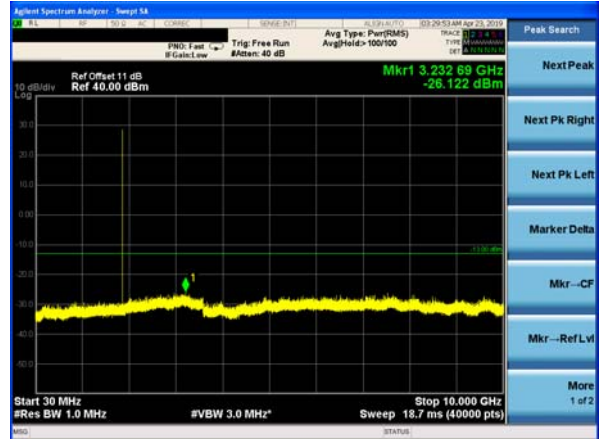
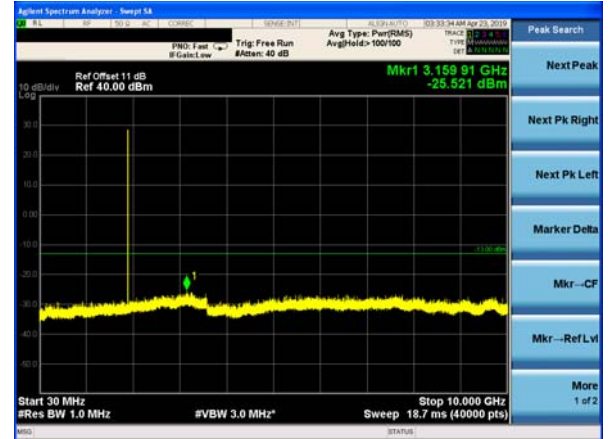
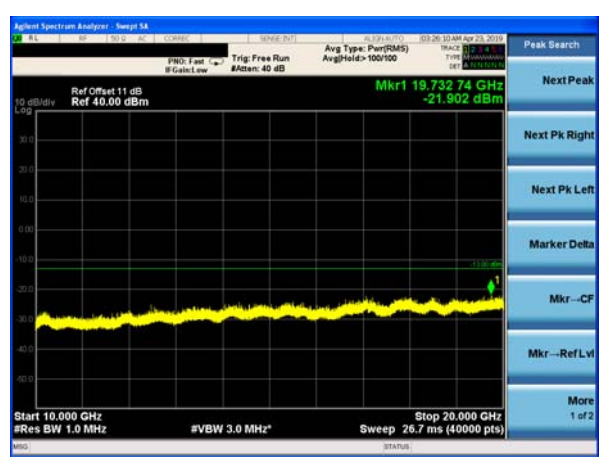
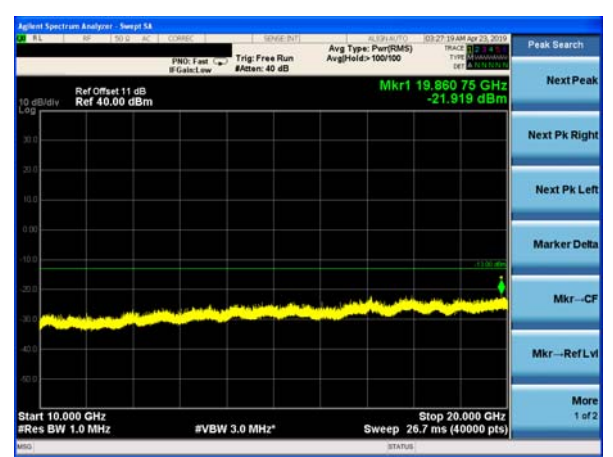

Test Plot

<p>GSM1900 Conducted Emission Transmitting Mode CH 661 30MHz – 10GHz</p>	<p>GSM1900 Conducted Emission Transmitting Mode CH 810 30MHz – 10GHz</p>
 <p>Agilent Spectrum Analyzer - Sweep 54 Peak Search Mkr1 3.23289 GHz -26.122 dBm Start 30 MHz #Res BW 1.0 MHz #VBW 3.0 MHz* Stop 10.000 GHz Sweep 18.7 ms (40000 pts)</p>	 <p>Agilent Spectrum Analyzer - Sweep 54 Peak Search Mkr1 3.16991 GHz -25.521 dBm Start 30 MHz #Res BW 1.0 MHz #VBW 3.0 MHz* Stop 10.000 GHz Sweep 18.7 ms (40000 pts)</p>
<p>Conducted Emission Transmitting Mode CH 661 10GHz – 20GHz</p>	<p>Conducted Emission Transmitting Mode CH 810 10GHz – 20GHz</p>
 <p>Agilent Spectrum Analyzer - Sweep 54 Peak Search Mkr1 19.73274 GHz -21.902 dBm Start 10.000 GHz #Res BW 1.0 MHz #VBW 3.0 MHz* Stop 20.000 GHz Sweep 26.7 ms (40000 pts)</p>	 <p>Agilent Spectrum Analyzer - Sweep 54 Peak Search Mkr1 19.86075 GHz -21.919 dBm Start 10.000 GHz #Res BW 1.0 MHz #VBW 3.0 MHz* Stop 20.000 GHz Sweep 26.7 ms (40000 pts)</p>

Test Plot

<p>GPRS850 Conducted Emission Transmitting Mode CH 128 30MHz – 5GHz</p>	<p>GPRS850 Conducted Emission Transmitting Mode CH 190 30MHz – 5GHz</p>
<p>Agilent Spectrum Analyzer - Sweep 54          Ref Offset 11 dB          Ref 40.00 dBm          Mkr1 3.29278 GHz          -25.583 dBm          Start 30 MHz #Res BW 1.0 MHz #VBW 3.0 MHz* Sweep 10.7 ms (40000 pts)</p>	<p>Agilent Spectrum Analyzer - Sweep 54          Ref Offset 11 dB          Ref 40.00 dBm          Mkr1 3.19174 GHz          -25.591 dBm          Start 30 MHz #Res BW 1.0 MHz #VBW 3.0 MHz* Sweep 10.7 ms (40000 pts)</p>
<p>Conducted Emission Transmitting Mode CH 128 5GHz – 10GHz</p>	<p>Conducted Emission Transmitting Mode CH 190 5GHz – 10GHz</p>
<p>Agilent Spectrum Analyzer - Sweep 54          Ref Offset 11 dB          Ref 40.00 dBm          Mkr1 8.606215 GHz          -26.939 dBm          Start 5.000 GHz #Res BW 1.0 MHz #VBW 3.0 MHz* Sweep 10.7 ms (40000 pts)</p>	<p>Agilent Spectrum Analyzer - Sweep 54          Ref Offset 11 dB          Ref 40.00 dBm          Mkr1 7.584940 GHz          -26.390 dBm          Start 5.000 GHz #Res BW 1.0 MHz #VBW 3.0 MHz* Sweep 10.7 ms (40000 pts)</p>

Test Plot

GPRS850

GPRS1900

Conducted Emission Transmitting Mode CH 251  
30MHz – 5GHz

Conducted Emission Transmitting Mode CH 512  
30MHz – 10GHz

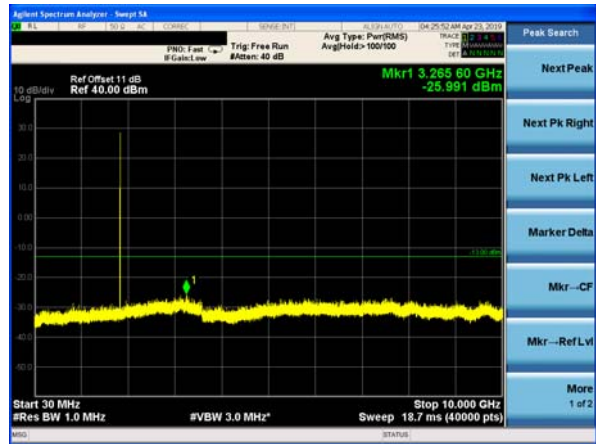

Conducted Emission Transmitting Mode CH 251  
5GHz – 10GHz

Conducted Emission Transmitting Mode CH 512  
10GHz – 20GHz

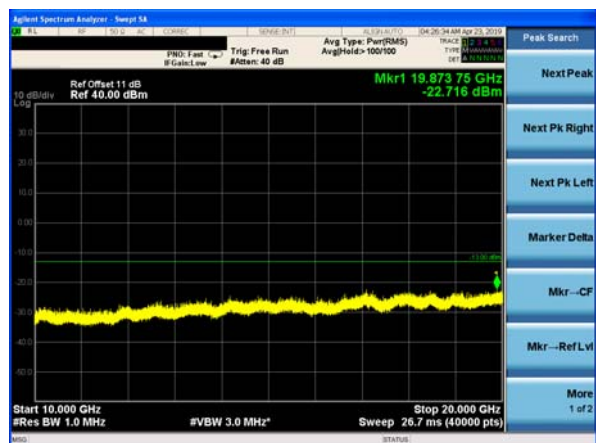
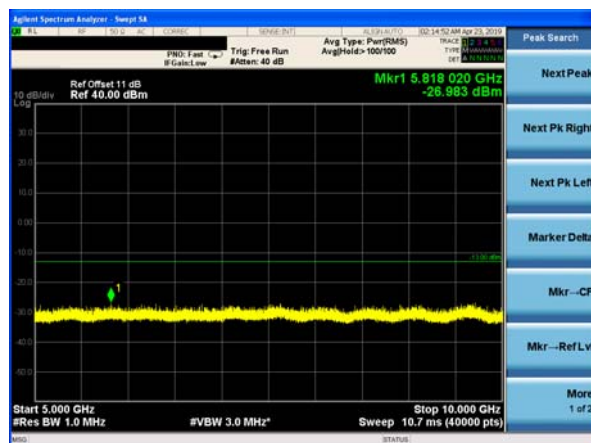

**Test Plot**

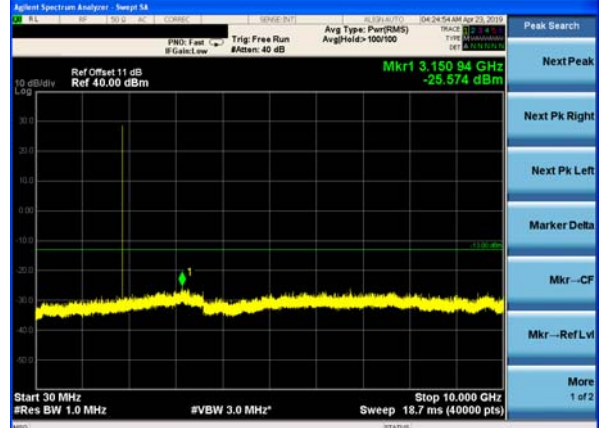
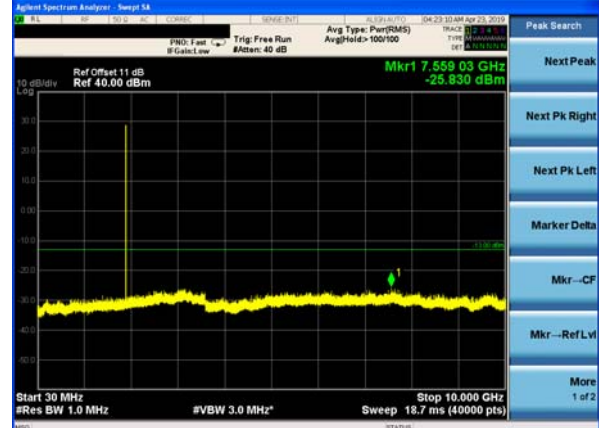
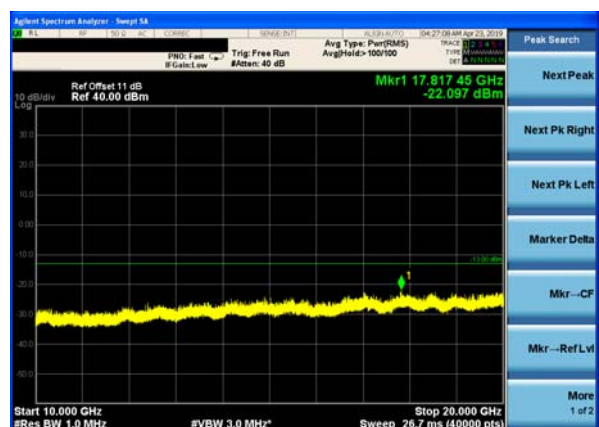
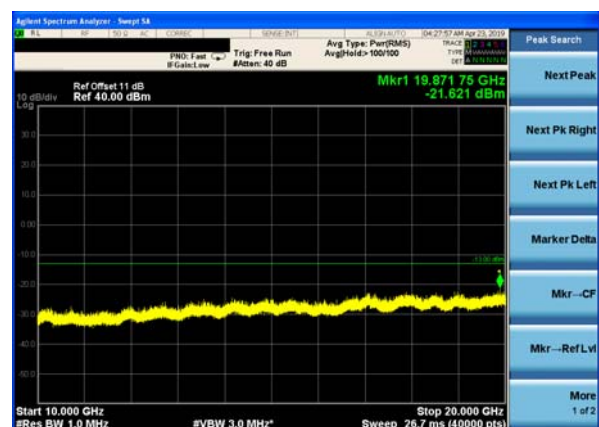
<p style="text-align: center;"><b>GPRS1900</b> Conducted Emission Transmitting Mode CH 661 30MHz – 10GHz</p>	<p style="text-align: center;"><b>GPRS1900</b> Conducted Emission Transmitting Mode CH 810 30MHz – 10GHz</p>
	
<p style="text-align: center;"><b>Conducted Emission Transmitting Mode CH 661</b> 10GHz – 20GHz</p>	<p style="text-align: center;"><b>Conducted Emission Transmitting Mode CH 810</b> 10GHz – 20GHz</p>
	

**Test Plot**

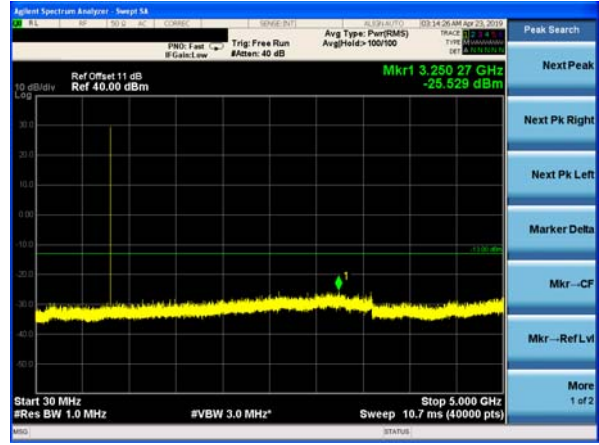
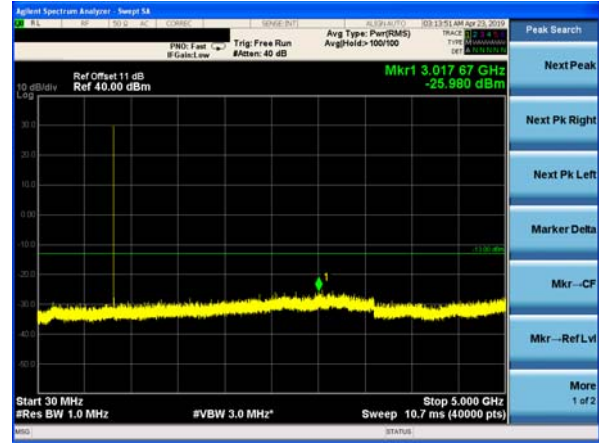
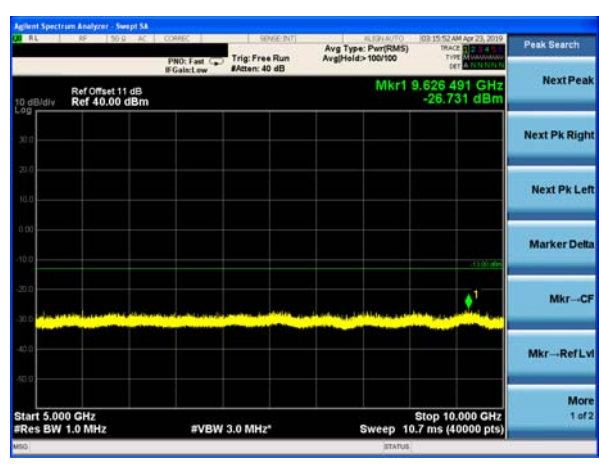
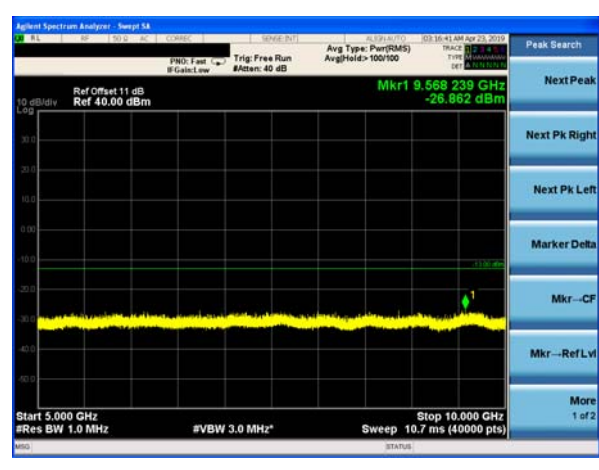
EGPRS850	EGPRS850
<p>Conducted Emission Transmitting Mode CH 128 30MHz – 5GHz</p>	<p>Conducted Emission Transmitting Mode CH 190 30MHz – 5GHz</p>
 <p>Agilent Spectrum Analyzer - Sweep 54</p> <p>Ref Offset 11 dB Ref 40.00 dBm</p> <p>Mkr1 3.250 27 GHz -25.529 dBm</p> <p>Start 30 MHz #Res BW 1.0 MHz #VBW 3.0 MHz* Sweep 10.7 ms (40000 pts)</p>	 <p>Agilent Spectrum Analyzer - Sweep 54</p> <p>Ref Offset 11 dB Ref 40.00 dBm</p> <p>Mkr1 3.017 67 GHz -25.989 dBm</p> <p>Start 30 MHz #Res BW 1.0 MHz #VBW 3.0 MHz* Sweep 10.7 ms (40000 pts)</p>
<p>Conducted Emission Transmitting Mode CH 128 5GHz – 10GHz</p>	<p>Conducted Emission Transmitting Mode CH 190 5GHz – 10GHz</p>
 <p>Agilent Spectrum Analyzer - Sweep 54</p> <p>Ref Offset 11 dB Ref 40.00 dBm</p> <p>Mkr1 9.626 491 GHz -26.731 dBm</p> <p>Start 5.000 GHz #Res BW 1.0 MHz #VBW 3.0 MHz* Sweep 10.7 ms (40000 pts)</p>	 <p>Agilent Spectrum Analyzer - Sweep 54</p> <p>Ref Offset 11 dB Ref 40.00 dBm</p> <p>Mkr1 9.568 239 GHz -26.862 dBm</p> <p>Start 5.000 GHz #Res BW 1.0 MHz #VBW 3.0 MHz* Sweep 10.7 ms (40000 pts)</p>

Test Plot

EGPRS850

Conducted Emission Transmitting Mode CH 251  
30MHz – 5GHz

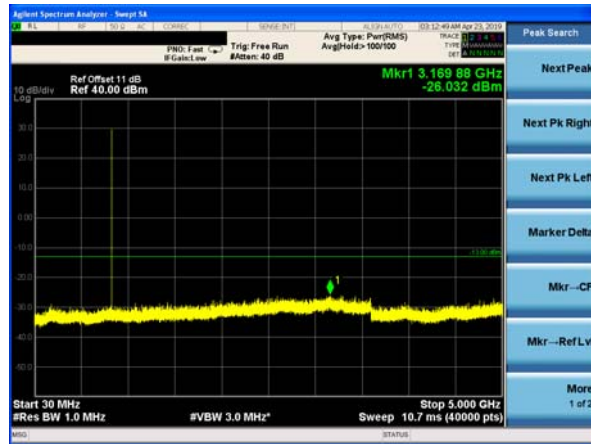

EGPRS1900

Conducted Emission Transmitting Mode CH 512  
30MHz – 10GHz

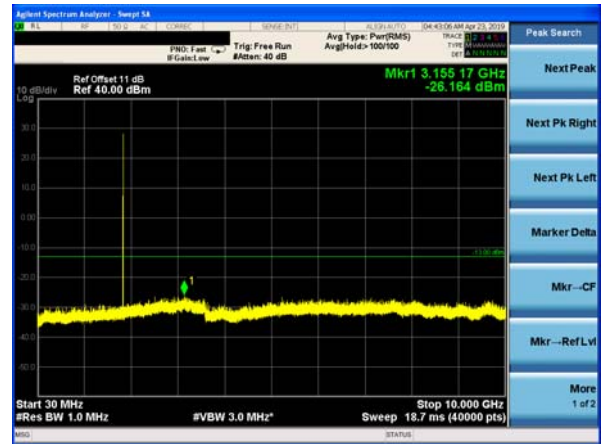

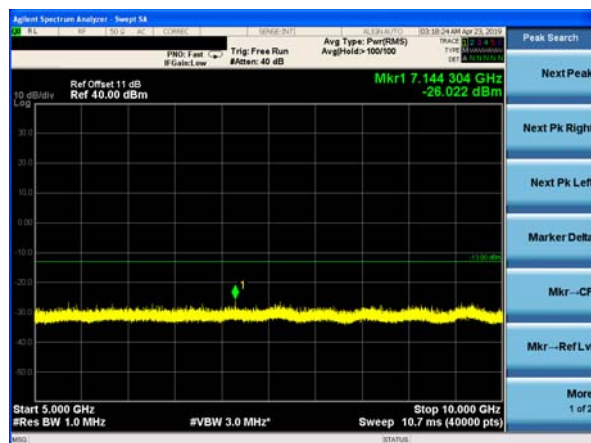

Conducted Emission Transmitting Mode CH 251  
5GHz – 10GHz

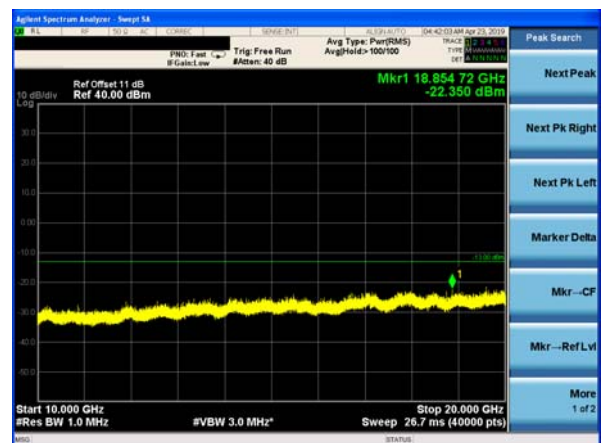

Conducted Emission Transmitting Mode CH 512  
10GHz – 20GHz

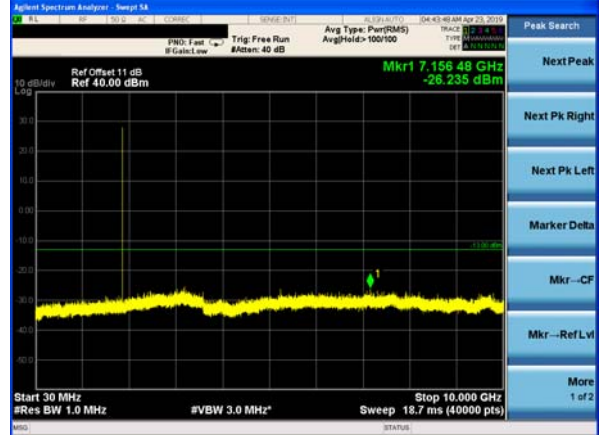
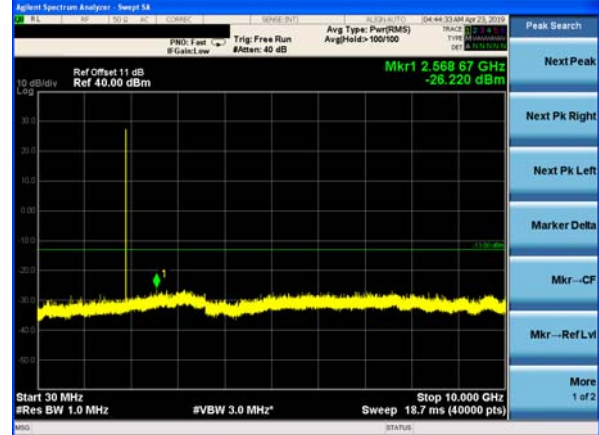

**Test Plot**

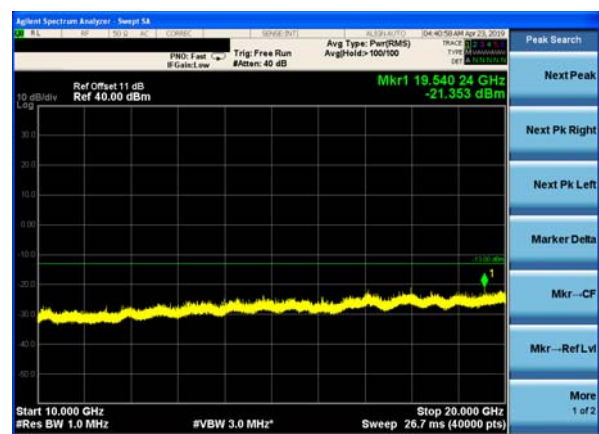
<p align="center"><b>EGPRS1900</b> Conducted Emission Transmitting Mode CH 661 30MHz – 10GHz</p>	<p align="center"><b>EGPRS1900</b> Conducted Emission Transmitting Mode CH 810 30MHz – 10GHz</p>
 <p>Agilent Spectrum Analyzer - Sweep 54 Peak Search Ref Offset 11 dB Ref 40.00 dBm Mkr1 7.156 48 GHz -26.235 dBm Start 30 MHz #Res BW 1.0 MHz #VBW 3.0 MHz* Sweep 18.7 ms (40000 pts)</p>	 <p>Agilent Spectrum Analyzer - Sweep 54 Peak Search Ref Offset 11 dB Ref 40.00 dBm Mkr1 2.569 87 GHz -26.220 dBm Start 30 MHz #Res BW 1.0 MHz #VBW 3.0 MHz* Sweep 18.7 ms (40000 pts)</p>
<p align="center"><b>Conducted Emission Transmitting Mode CH 661</b> 10GHz – 20GHz</p>	<p align="center"><b>Conducted Emission Transmitting Mode CH 810</b> 10GHz – 20GHz</p>
 <p>Agilent Spectrum Analyzer - Sweep 54 Peak Search Ref Offset 11 dB Ref 40.00 dBm Mkr1 17.749 94 GHz -22.652 dBm Start 10.000 GHz #Res BW 1.0 MHz #VBW 3.0 MHz* Sweep 26.7 ms (40000 pts)</p>	 <p>Agilent Spectrum Analyzer - Sweep 54 Peak Search Ref Offset 11 dB Ref 40.00 dBm Mkr1 19.540 24 GHz -21.353 dBm Start 10.000 GHz #Res BW 1.0 MHz #VBW 3.0 MHz* Sweep 26.7 ms (40000 pts)</p>

**Test Plot**

UMTS band V  
Conducted Emission Transmitting Mode CH  
4132 30MHz – 5GHz

UMTS band V  
Conducted Emission Transmitting Mode CH 4183  
30MHz – 5GHz

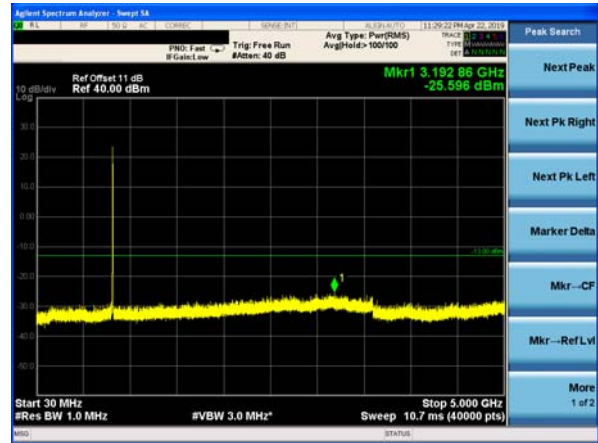
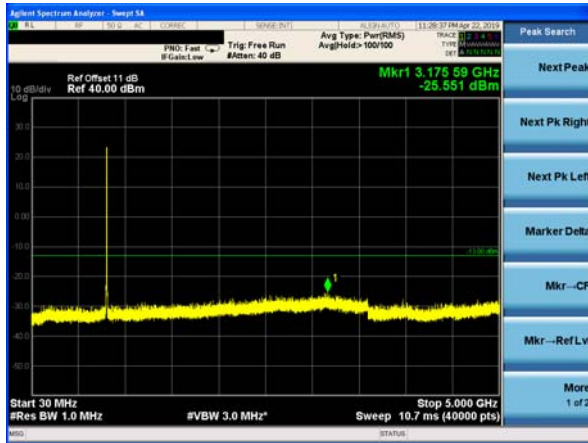



Conducted Emission Transmitting Mode CH  
4132 5GHz – 10GHz

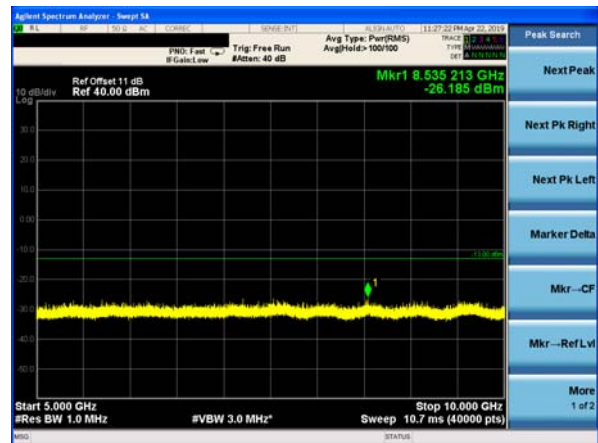
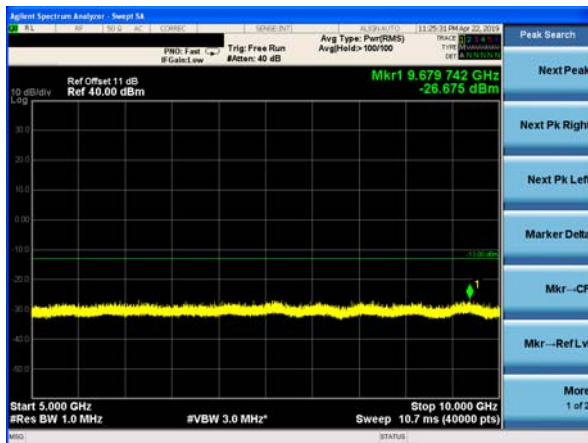

Conducted Emission Transmitting Mode CH 4183  
5GHz – 10GHz



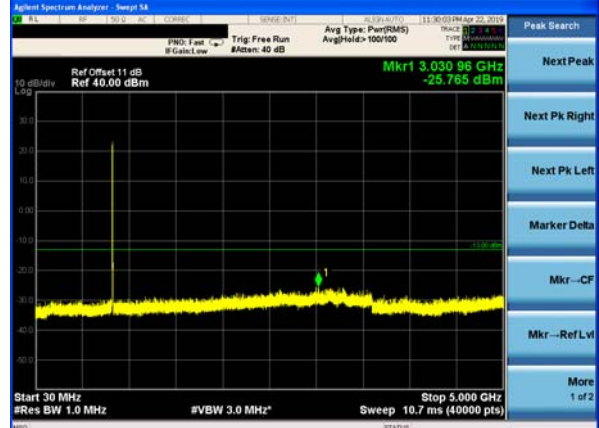
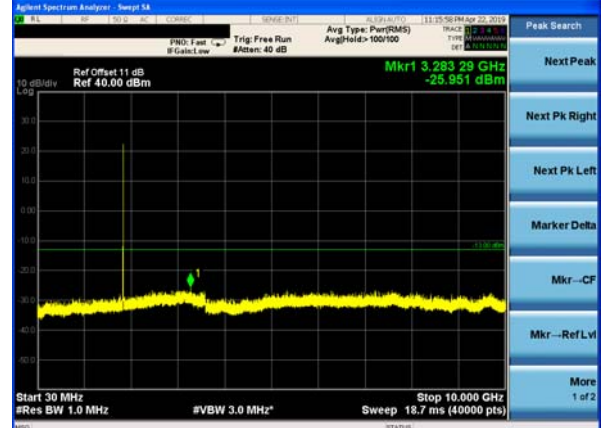

**Test Plot**

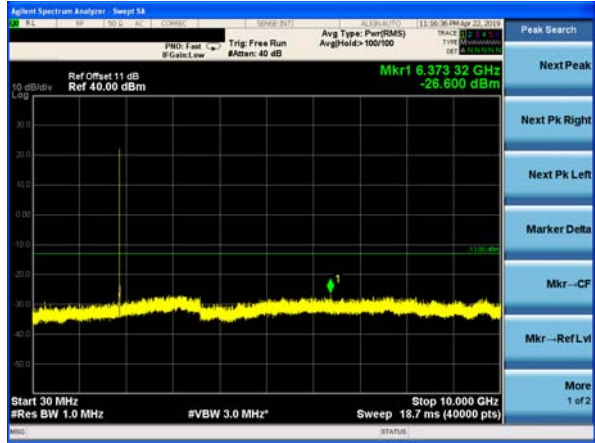
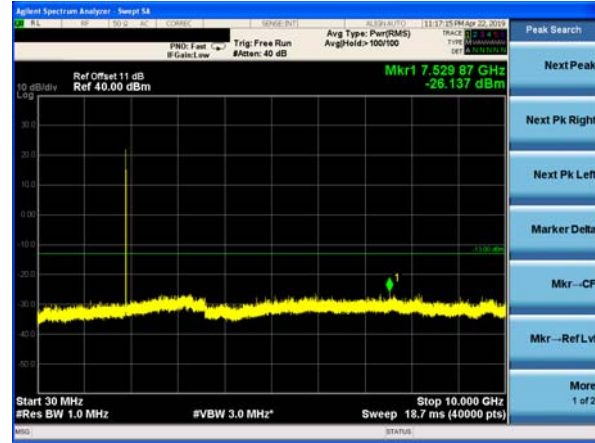
<p align="center"><b>UMTS band V</b> Conducted Emission Transmitting Mode CH 4233 30MHz – 5GHz</p>	<p align="center"><b>UMTS band II</b> Conducted Emission Transmitting Mode CH 9262 30MHz – 10GHz</p>
	
<p align="center"><b>Conducted Emission Transmitting Mode CH</b> 4233 5GHz – 10GHz</p>	<p align="center"><b>Conducted Emission Transmitting Mode CH 9262</b> 10GHz – 20GHz</p>
	

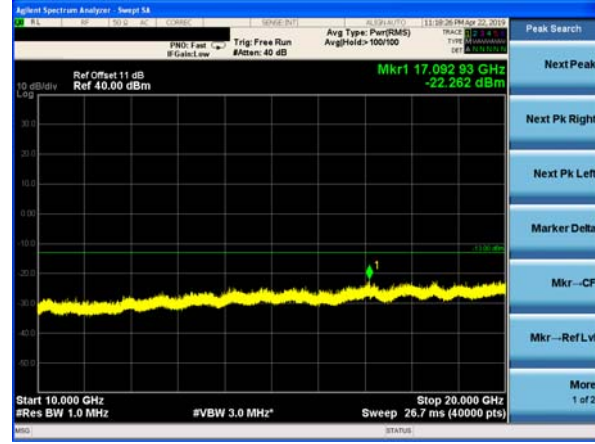
Test Plot	
UMTS band II Conducted Emission Transmitting Mode CH 9400 30MHz – 10GHz	UMTS band II Conducted Emission Transmitting Mode CH 9538 30MHz – 10GHz
	
Conducted Emission Transmitting Mode CH 9400 10GHz – 20GHz	Conducted Emission Transmitting Mode CH 9538 10GHz – 20GHz
	

Test Plot

UMTS band IV  
 Conducted Emission Transmitting Mode CH  
 1312 30MHz – 10GHz

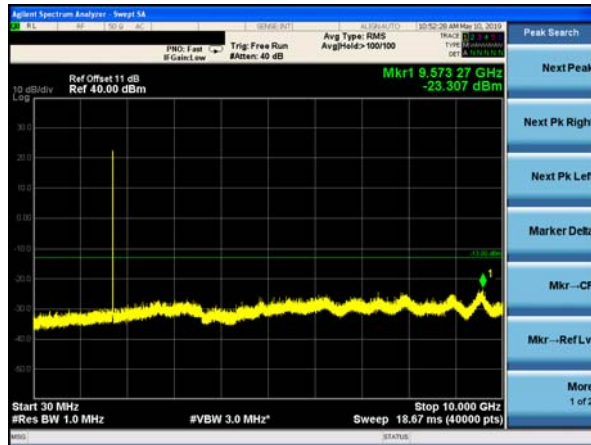

UMTS band IV  
 Conducted Emission Transmitting Mode CH 1412  
 30MHz – 10GHz

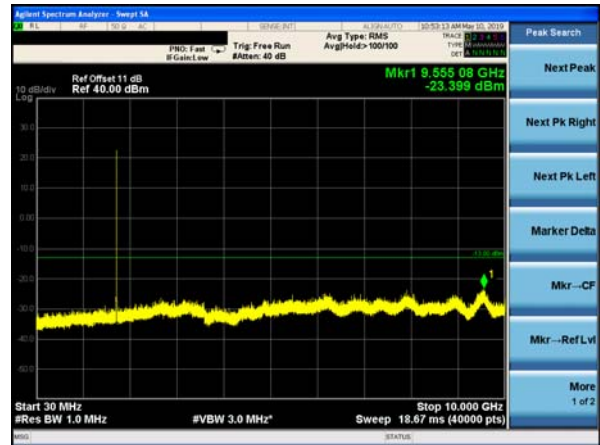

Conducted Emission Transmitting Mode CH  
 1312 10GHz – 20GHz



Conducted Emission Transmitting Mode CH 1412  
 10GHz – 20GHz

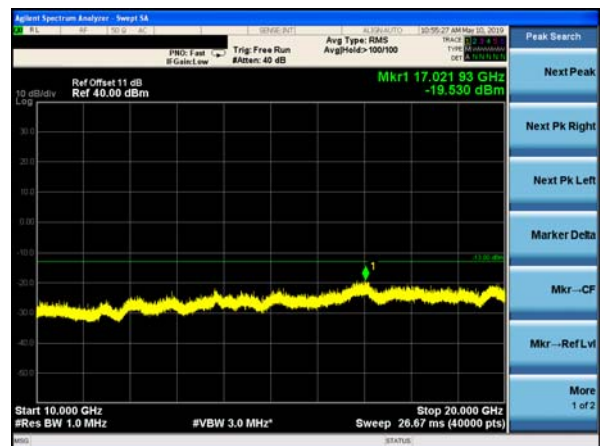

Test Plot

UMTS band IV

Conducted Emission Transmitting Mode CH  
1513 30MHz – 10GHz

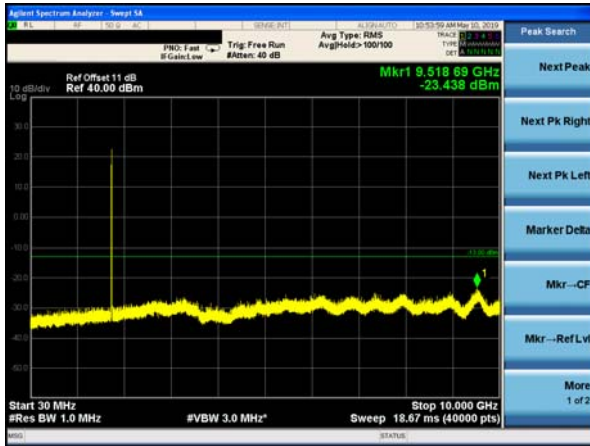

Conducted Emission Transmitting Mode CH  
1513 10GHz – 20GHz

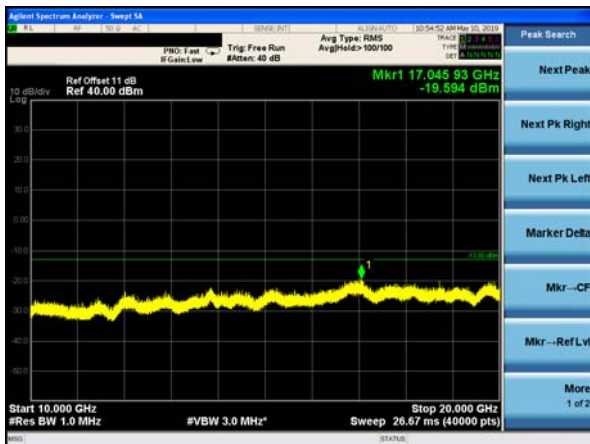

END OF REPORT