

FCC SAR EVALUATION REPORT

**In accordance with the requirements of
FCC 47 CFR Part 2(2.1093), ANSI/IEEE C95.1-1992 and
IEEE Std 1528-2013**

Product Name : Mobile Phone

Brand Name : ulefone

Model Name : Armor 23 Ultra

Family Model : GQ5005, Armor 23, Armor 23E, Armor 23S, Armor
23 Lite, Armor 23 Pro, Armor 23 Pro+, Armor 23s,
Armor 23s Pro

Report No. : S23101702906001

FCC ID : 2AOWK-5005AF1

Prepared for

Shenzhen Gotron Electronic CO.,LTD.

7B01, Building A, Block 1, Anhongji Tianyao Plaza, Longhua District, Shenzhen City,
Guangdong Province China Delaware U.S.A.

Prepared by

Shenzhen NTEK Testing Technology Co., Ltd.

1/F, Building E, Fenda Science Park, Sanwei Community,
Xixiang Street Bao'an District, Shenzhen 518126 P.R. China

Tel. 400-800-6106, 0755-2320 0050, 0755-2320 0090

Website: <http://www.ntek.org.cn>

TEST RESULT CERTIFICATION

Applicant's name Shenzhen Gotron Electronic CO.,LTD.
Address..... 7B01, Building A, Block 1, Anhongji Tianyao Plaza, Longhua District, Shenzhen City, Guangdong Province China

Manufacturer's Name . Shenzhen Gotron Electronic CO.,LTD.
Address..... 7B01, Building A, Block 1, Anhongji Tianyao Plaza, Longhua District, Shenzhen City, Guangdong Province China

Product description

Product name Mobile Phone
Brand Name ulefone
Model and/or type reference Armor 23 Ultra
Family Model GQ5005, Armor 23, Armor 23E, Armor 23S, Armor 23 Lite, Armor 23 Pro, Armor 23 Pro+, Armor 23s, Armor 23s Pro
FCC 47 CFR Part 2(2.1093)
ANSI/IEEE C95.1-1992

Standards IEEE Std 1528-2013
Published RF exposure KDB procedures

This device described above has been tested by Shenzhen NTEK. In accordance with the measurement methods and procedures specified in IEEE Std 1528-2013 and KDB 865664 D01. Testing has shown that this device is capable of compliance with localized specific absorption rate (SAR) specified in FCC 47 CFR Part 2(2.1093) and ANSI/IEEE C95.1-1992. The test results in this report apply only to the tested sample of the stated device/equipment. Other similar device/equipment will not necessarily produce the same results due to production tolerance and measurement uncertainties.

This report shall not be reproduced except in full, without the written approval of Shenzhen NTEK, this document may be altered or revised by Shenzhen NTEK, personal only, and shall be noted in the revision of the document.

Test Sample Number S231017029002

Date of Test

Date (s) of performance of tests... Oct. 19, 2023 ~ Oct. 31, 2023

Date of Issue Dec. 21, 2023

Test Result..... Pass

Prepared By : Jack Li
Jack Li
(Project Engineer)

Reviewed By : Aaron Cheng
Aaron Cheng
(Supervisor)

Approved By : Alex Li
Alex Li
(Manager)

※ ※ **Revision History** ※ ※

REV.	DESCRIPTION	ISSUED DATE	REMARK
Rev.1.0	Initial Test Report Release	Dec. 21, 2023	Jack Li

TABLE OF CONTENTS

1. General Information	6
1.1. RF exposure limits	6
1.2. Statement of Compliance	7
1.3. EUT Description	7
1.4. Test specification(s)	9
1.5. Ambient Condition	9
2. SAR Measurement System	10
2.1. SATIMO SAR Measurement Set-up Diagram	10
2.2. Robot	11
2.3. E-Field Probe	12
2.3.1. E-Field Probe Calibration	12
2.4. SAM phantoms	13
2.4.1. Technical Data	14
2.5. Device Holder	15
2.6. Test Equipment List	16
3. SAR Measurement Procedures	19
3.1. Power Reference	19
3.2. Area scan & Zoom scan	19
3.3. Description of interpolation/extrapolation scheme	21
3.4. Volumetric Scan	21
3.5. Power Drift	21
4. System Verification Procedure	22
4.1. Tissue Verification	22
4.1.1. Tissue Dielectric Parameter Check Results	23
4.2. System Verification Procedure	24
4.2.1. System Verification Results	25
5. SAR Measurement variability and uncertainty	26
5.1. SAR measurement variability	26
5.2. SAR measurement uncertainty	26
6. RF Exposure Positions	27
6.1. Ear and handset reference point	27
6.2. Definition of the cheek position	27
6.3. Definition of the tilt position	29
6.4. Body Worn Accessory	29
6.5. Wireless Router Devices	30
7. RF Output Power	31
7.1. GSM Conducted Power	31
7.2. WCDMA Conducted Power	31
7.3. LTE Conducted Power	33

7.4. NR SA Power	51
7.5. WLAN & Bluetooth Output Power	63
8. Antenna Location.....	66
9. Stand-alone SAR test exclusion.....	66
10. SAR Results	67
10.1. SAR measurement Result.....	67
10.1.1. SAR measurement Result of GSM850.....	67
10.1.2. SAR measurement Result of GSM1900.....	68
10.1.3. SAR measurement Result of WCDMA Band 2.....	69
10.1.4. SAR measurement Result of WCDMA Band 4.....	70
10.1.5. SAR measurement Result of WCDMA Band 5.....	71
10.1.6. SAR measurement Result of LTE Band 2	72
10.1.7. SAR measurement Result of LTE Band 4	74
10.1.8. SAR measurement Result of LTE Band 5	76
10.1.9. SAR measurement Result of LTE Band 7	78
10.1.10. SAR measurement Result of LTE Band 12	80
10.1.11. SAR measurement Result of LTE Band 17	81
10.1.12. SAR measurement Result of LTE Band 41	83
10.1.13. SAR measurement Result of LTE Band 66	85
10.1.14. SAR measurement Result of LTE Band 71	87
10.1.15. SAR measurement Result of NR n41.....	89
10.1.16. SAR measurement Result of NR n78.....	90
10.1.17. SAR measurement Result of WLAN2.4G.....	91
10.1.18. SAR measurement Result of WLAN5.2G.....	92
10.1.19. SAR measurement Result of WLAN5.8G.....	93
10.2. Simultaneous Transmission Analysis.....	94
1. Appendix A. Photo documentation.....	96
2. Appendix B. System Check Plots	97
1. Appendix C. Plots of High SAR Measurement.....	116
2. Appendix D. Calibration Certificate	194

1. General Information

1.1. RF exposure limits

(A).Limits for Occupational/Controlled Exposure (W/kg)

Whole-Body	Partial-Body	Hands, Wrists, Feet and Ankles
0.4	8.0	20.0

(B).Limits for General Population/Uncontrolled Exposure (W/kg)

Whole-Body	Partial-Body	Hands, Wrists, Feet and Ankles
0.08	1.6	4.0

NOTE: **Whole-Body SAR** is averaged over the entire body, **partial-body SAR** is averaged over any 1 gram of tissue defined as a tissue volume in the shape of a cube. **SAR for hands, wrists, feet and ankles** is averaged over any 10 grams of tissue defined as a tissue volume in the shape of a cube.

Occupational/Controlled Environments:

Are defined as locations where there is exposure that may be incurred by people who are aware of the potential for exposure, (i.e. as a result of employment or occupation).

General Population/Uncontrolled Environments:

Are defined as locations where there is the exposure of individuals who have no knowledge or control of their exposure.

NOTE
 HEAD AND TRUNK LIMIT
 1.6 W/kg
 APPLIED TO THIS EUT

1.2. Statement of Compliance

The maximum results of Specific Absorption Rate (SAR) found during testing for Armor 23 Ultra are as follows.

RF Exposure Conditions		Max Reported SAR Value(W/kg)
1-g Head		0.564
1-g Body-Worn (Separation distance of 10mm)		0.400
1-g Hotspot (Separation distance of 10mm)		0.400
Max Simultaneous Tx	Head	1.014
	Body-Worn	0.531
	Hotspot	0.531

RF Exposure Conditions		Max Reported SAR Value(W/kg)
10-g Body (Separation distance of 0mm)		0.854
Max Simultaneous Tx	Body	0.929

Note: The Max Simultaneous Tx is calculated based on the same configuration and test position.

This device is in compliance with Specific Absorption Rate (SAR) for general population/uncontrolled exposure limits (1.6 W/kg, 4.0W/kg for Body 10g SAR) specified in FCC 47 CFR Part 2(2.1093) and ANSI/IEEE C95.1-1992, and had been tested in accordance with the measurement methods and procedures specified in IEEE Std 1528-2013 & KDB 865664 D01.

1.3. EUT Description

Device Information	
Product Name	Mobile Phone
Brand Name	ulefone
Model Name	Armor 23 Ultra
Family Model	GQ5005, Armor 23, Armor 23E, Armor 23S, Armor 23 Lite, Armor 23 Pro, Armor 23 Pro+, Armor 23s, Armor 23s Pro
Model Difference	All the model are the same circuit and RF module, except the model names.
FCC ID	2AOWK-5005AF1
Device Phase	Identical Prototype
Exposure Category	General population / Uncontrolled environment
Antenna Type	PIFA Antenna
Battery Information	DC 7.74V, 2640mAh, 20.434Wh
HW Version	A500-02
SW Version	N/A

Device Operating Configurations			
Supporting Mode(s)	GSM850/1900,WCDMABand2/4/5,LTEBand2/4/5/7/12/17/41/66/71, NR SA n41/n78, NR NSA n78+LTE Band 5, WLAN 2.4G/5G, Bluetooth, NFC		
Test Modulation	GSM(GMSK/8PSK), WCDMA(QPSK), LTE(QPSK/16QAM), NR(DFT-s-OFDM:PI/2 BPSK/QPSK/16-QAM/64QAM/256QAM CP-OFDM: QPSK/16-QAM/64QAM/256QAM), WLAN(DSSS/OFDM), Bluetooth(GFSK, $\pi/4$ -DQPSK, 8DPSK), NFC(ASK)		
Device Class	B		
Operating Frequency Range(s)	Band	Tx (MHz)	Rx (MHz)
	GSM 850	824-849	869-894
	GSM 1900	1850-1910	1930-1990
	WCDMA Band 2	1850-1910	1930-1990
	WCDMA Band 4	1710-1755	2110-2155
	WCDMA Band 5	824-849	869-894
	LTE Band 2	1850-1910	1930-1990
	LTE Band 4	1710-1755	2110-2155
	LTE Band 5	824-849	869-894
	LTE Band 7	2500-2570	2620-2690
	LTE Band 12	699-716	729-746
	LTE Band 17	704-716	734-746
	LTE Band 41	2496-2690	
	LTE Band 66	1710-1780	2110-2200
	LTE Band 71	663-698	617-652
	NR n41	2496-2690	
	NR n78	3450-3550	
	WLAN 2.4G	2412-2462	
	WLAN 5.2G	5180-5240	
	WLAN 5.8G	5745-5825	
NFC	13.56		
Bluetooth	2402-2480		
GPRS Multislot Class(12)	Max Number of Timeslots in Uplink		4
	Max Number of Timeslots in Downlink		4
	Max Total Timeslot		5
EGPRS Multislot Class(12)	Max Number of Timeslots in Uplink		4
	Max Number of Timeslots in Downlink		4
	Max Total Timeslot		5
Power Class	4, tested with power level 5(GSM 850)		
	1, tested with power level 0(GSM 1900)		

3, tested with power control —all”(WCDMA Band 2)
3, tested with power control —all”(WCDMA Band 4)
3, tested with power control —all”(WCDMA Band 5)
3, tested with power control all Max.(LTE Band 2)
3, tested with power control all Max.(LTE Band 4)
3, tested with power control all Max.(LTE Band 5)
3, tested with power control all Max.(LTE Band 7)
3, tested with power control all Max.(LTE Band 12)
3, tested with power control all Max.(LTE Band 17)
3, tested with power control all Max.(LTE Band 41)
3, tested with power control all Max.(LTE Band 66)
3, tested with power control all Max.(LTE Band 71)
3, tested with power control all Max.(NR n41)
3, tested with power control all Max.(NR n78)

1.4. Test specification(s)

FCC 47 CFR Part 2(2.1093)
ANSI/IEEE C95.1-1992
IEEE Std 1528-2013
KDB 865664 D01 SAR measurement 100 MHz to 6 GHz
KDB 865664 D02 RF Exposure Reporting
KDB 447498 D01 General RF Exposure Guidance
KDB 248227 D01 802.11 Wi-Fi SAR
KDB 941225 D01 3G SAR Procedures
KDB 941225 D05 SAR for LTE Devices
KDB 941225 D06 Hotspot SAR
KDB 648474 D04 Handset SAR

1.5. Ambient Condition

Ambient temperature	20°C – 24°C
Relative Humidity	30% – 70%

2. SAR Measurement System

2.1. SATIMO SAR Measurement Set-up Diagram

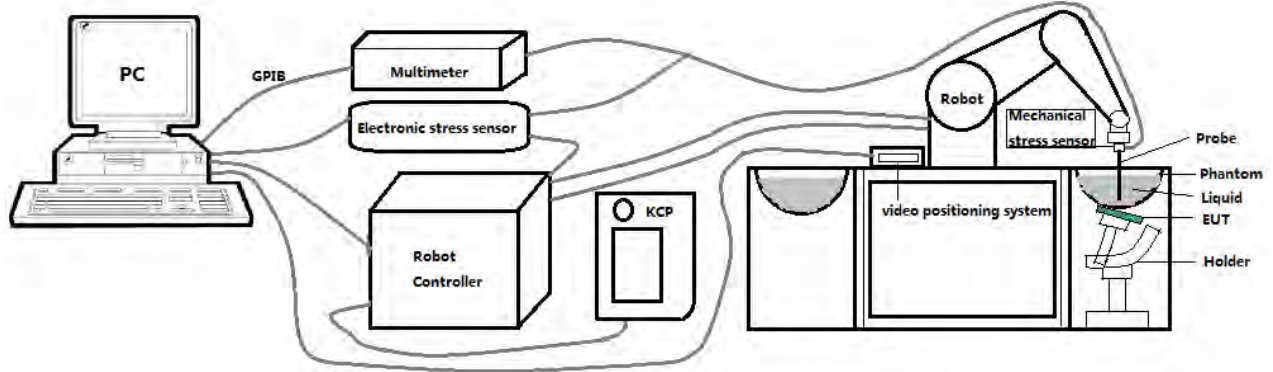

These measurements were performed with the automated near-field scanning system OPENSAR from SATIMO. The system is based on a high precision robot (working range: 901 mm), which positions the probes with a positional repeatability of better than ± 0.03 mm. The SAR measurements were conducted with dosimetric probe (manufactured by SATIMO), designed in the classical triangular configuration and optimized for dosimetric evaluation.

The first step of the field measurement is the evaluation of the voltages induced on the probe by the device under test. Probe diode detectors are nonlinear. Below the diode compression point, the output voltage is proportional to the square of the applied E-field; above the diode compression point, it is linear to the applied E-field. The compression point depends on the diode, and a calibration procedure is necessary for each sensor of the probe.

The Keithley multimeter reads the voltage of each sensor and send these three values to the PC. The corresponding E field value is calculated using the probe calibration factors, which are stored in the working directory. This evaluation includes linearization of the diode characteristics. The field calculation is done separately for each sensor. Each component of the E field is displayed on the "Dipole Area Scan Interface" and the total E field is displayed on the "3D Interface"

2.2. Robot

The SATIMO SAR system uses the high precision robots from KUKA. For the 6-axis controller system, the robot controller version (KUKA) from KUKA is used. The KUKA robot series have many features that are important for our application:



- High precision (repeatability ± 0.03 mm)
- High reliability (industrial design)
- Jerk-free straight movements
- Low ELF interference (the closed metallic construction shields against motor control fields)

2.3. E-Field Probe

This E-field detection probe is composed of three orthogonal dipoles linked to special Schottky diodes with low detection thresholds. The probe allows the measurement of electric fields in liquids such as the one defined in the IEEE and CENELEC standards.

For the measurements the Specific Dosimetric E-Field Probe 3423-EPGO-426 with following specifications is used



- Dynamic range: 0.01-100 W/kg
 - Tip Diameter : 2.5 mm
 - Distance between probe tip and sensor center: 1 mm
 - Distance between sensor center and the inner phantom surface: 2 mm (repeatability better than ± 1 mm).
 - Probe linearity: ± 0.06 dB
 - Axial isotropy: ± 0.01 dB
 - Hemispherical Isotropy: ± 0.01 dB
 - Calibration range: 650MHz to 5900MHz for head & body simulating liquid.
 - Lower detection limit: 8mW/kg
- Angle between probe axis (evaluation axis) and surface normal line: less than 30° .

2.3.1. E-Field Probe Calibration

Each probe needs to be calibrated according to a dosimetric assessment procedure with accuracy better than $\pm 10\%$. The spherical isotropy shall be evaluated and within ± 0.25 dB. The sensitivity parameters (Norm X, Norm Y, and Norm Z), the diode compression parameter (DCP) and the conversion factor (Conv F) of the probe are tested. The calibration data can be referred to appendix D of this report.

2.4. SAM phantoms

Photo of SAM phantom SN 16/15 SAM119



The SAM phantom is used to measure the SAR relative to people exposed to electro-magnetic field radiated by Smart Phones.

2.4.1. Technical Data

Serial Number	Shell thickness	Filling volume	Dimensions	Positionner Material	Permittivity	Loss Tangent
SN 16/15 SAM119	2 mm ±0.2 mm	27 liters	Length:1000 mm Width:500 mm Height:200 mm	Gelcoat with fiberglass	3.4	0.02

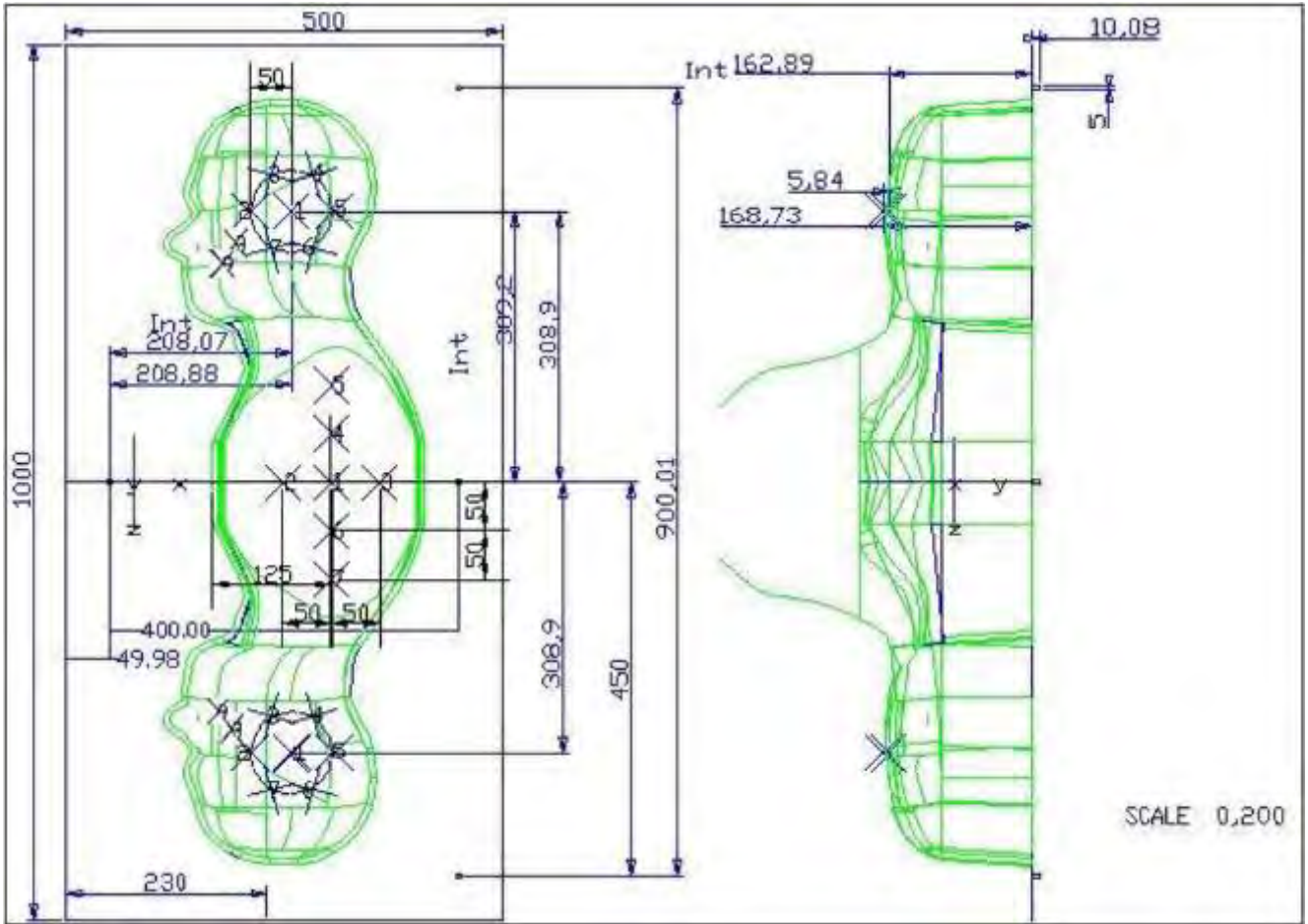

Serial Number	Left Head(mm)		Right Head(mm)		Flat Part(mm)	
	1	2	1	2	1	2
SN 16/15 SAM119	2	2.02	2	2.08	1	2.09
	3	2.05	3	2.06	2	2.06
	4	2.07	4	2.07	3	2.08
	5	2.08	5	2.08	4	2.10
	6	2.05	6	2.07	5	2.10
	7	2.05	7	2.05	6	2.07
	8	2.07	8	2.06	7	2.07
	9	2.08	9	2.06	-	-

The test, based on ultrasonic system, allows measuring the thickness with an accuracy of 10 µm.

2.5. Device Holder

The positioning system allows obtaining cheek and tilting position with a very good accuracy. In compliance with CENELEC, the tilt angle uncertainty is lower than 1 degree.

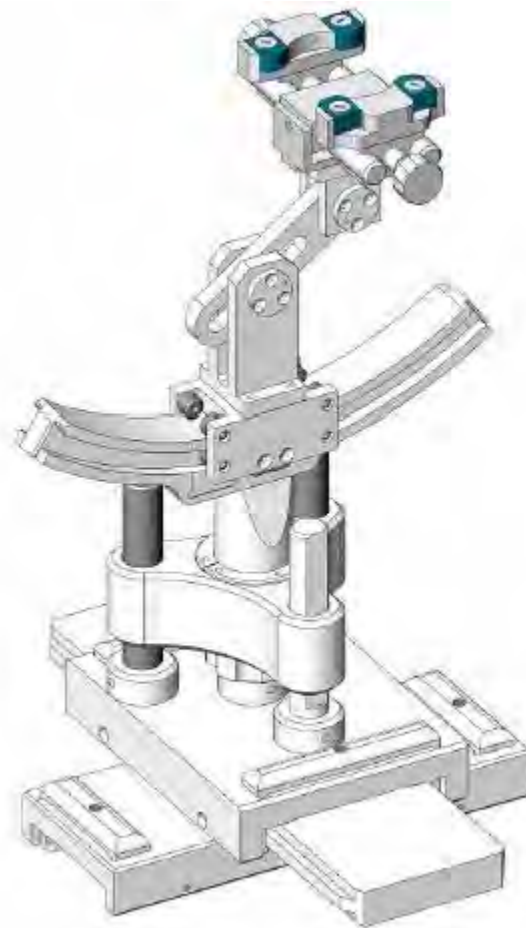

Serial Number	Holder Material	Permittivity	Loss Tangent
SN 16/15 MSH100	Delrin	3.7	0.005

2.6. Test Equipment List

This table gives a complete overview of the SAR measurement equipment.

Devices used during the test described are marked

	Manufacturer	Name of Equipment	Type/Model	Serial Number	Calibration	
					Last Cal.	Due Date
<input checked="" type="checkbox"/>	MVG	E FIELD PROBE	SSE2	3423-EPGO-426	Sep. 18, 2023	Sep. 17, 2024
<input checked="" type="checkbox"/>	MVG	750 MHz Dipole	SID750	SN 03/15 DIP 0G750-355	Mar. 01, 2021	Feb. 28, 2024
<input checked="" type="checkbox"/>	MVG	835 MHz Dipole	SID835	SN 03/15 DIP 0G835-347	Mar. 01, 2021	Feb. 28, 2024
<input type="checkbox"/>	MVG	900 MHz Dipole	SID900	SN 03/15 DIP 0G900-348	Mar. 01, 2021	Feb. 28, 2024
<input checked="" type="checkbox"/>	MVG	1800 MHz Dipole	SID1800	SN 03/15 DIP 1G800-349	Mar. 01, 2021	Feb. 28, 2024
<input checked="" type="checkbox"/>	MVG	1900 MHz Dipole	SID1900	SN 03/15 DIP 1G900-350	Mar. 01, 2021	Feb. 28, 2024
<input type="checkbox"/>	MVG	2000 MHz Dipole	SID2000	SN 03/15 DIP 2G000-351	Mar. 01, 2021	Feb. 28, 2024
<input type="checkbox"/>	MVG	2300 MHz Dipole	SID2300	SN 03/16 DIP 2G300-358	Mar. 01, 2021	Feb. 28, 2024
<input checked="" type="checkbox"/>	MVG	2450 MHz Dipole	SID2450	SN 03/15 DIP 2G450-352	Mar. 01, 2021	Feb. 28, 2024
<input checked="" type="checkbox"/>	MVG	2600 MHz Dipole	SID2600	SN 03/15 DIP 2G600-356	Mar. 01, 2021	Feb. 28, 2024
<input checked="" type="checkbox"/>	MVG	3500 MHz Dipole	SID3500	SN 09/12 DIP 3G500-360	Oct. 15, 2022	Oct. 14, 2025
<input checked="" type="checkbox"/>	MVG	5000 MHz Dipole	SWG5500	SN 13/14 WGA 33	Mar. 01, 2021	Feb. 28, 2024
<input checked="" type="checkbox"/>	MVG	Liquid measurement Kit	SCLMP	SN 21/15 OCPG 72	NCR	NCR
<input checked="" type="checkbox"/>	MVG	Power Amplifier	N.A	AMPLISAR_28/14_003	NCR	NCR
<input checked="" type="checkbox"/>	KEITHLEY	Millivoltmeter	2000	4072790	NCR	NCR
<input checked="" type="checkbox"/>	R&S	Universal radio communication tester	CMU200	117858	May 29, 2023	May 28, 2024
<input checked="" type="checkbox"/>	R&S	Wideband radio communication	CMW500	103917	May 29, 2023	May 28, 2024

		tester				
<input checked="" type="checkbox"/>	HP	Network Analyzer	8753D	3410J01136	May 29, 2023	May 28, 2024
<input checked="" type="checkbox"/>	Agilent	MXG Vector Signal Generator	N5182A	MY47070317	May 29, 2023	May 28, 2024
<input checked="" type="checkbox"/>	Agilent	Power meter	E4419B	MY45102538	May 29, 2023	May 28, 2024
<input checked="" type="checkbox"/>	Agilent	Power sensor	E9301A	MY41495644	May 29, 2023	May 28, 2024
<input checked="" type="checkbox"/>	Agilent	Power sensor	E9301A	US39212148	May 29, 2023	May 28, 2024
<input checked="" type="checkbox"/>	MCLI/USA	Directional Coupler	CB11-20	0D2L51502	Jul. 04, 2023	Jul. 03, 2024
<input checked="" type="checkbox"/>	N/A	Thermometer	N/A	LES-085	Mar. 27, 2023	Mar. 26, 2026
<input checked="" type="checkbox"/>	MVG	SAM Phantom	SSM2	SN 16/15 SAM119	NCR	NCR
<input checked="" type="checkbox"/>	MVG	Device Holder	SMPPD	SN 16/15 MSH100	NCR	NCR
<input checked="" type="checkbox"/>	Shenzhen Tianxu Communication Technology Co., Ltd.	Human Simulating Liquid	Head 750	Head 750	NCR	NCR
<input checked="" type="checkbox"/>	Shenzhen Tianxu Communication Technology Co., Ltd.	Human Simulating Liquid	Head 835	Head 835	NCR	NCR
<input checked="" type="checkbox"/>	Shenzhen Tianxu Communication Technology Co., Ltd.	Human Simulating Liquid	Head 1800	Head 1800	NCR	NCR
<input checked="" type="checkbox"/>	Shenzhen Tianxu Communication Technology Co., Ltd.	Human Simulating Liquid	Head 1900	Head 1900	NCR	NCR
<input checked="" type="checkbox"/>	Shenzhen Tianxu Communication	Human Simulating Liquid	Head 2450	Head 2450	NCR	NCR

	Technology Co., Ltd.					
<input checked="" type="checkbox"/>	Shenzhen Tianxu Communication Technology Co., Ltd.	Human Simulating Liquid	Head 2600	Head 2600	NCR	NCR
<input checked="" type="checkbox"/>	Shenzhen Tianxu Communication Technology Co., Ltd.	Human Simulating Liquid	Head 3500	Head 3500	NCR	NCR
<input checked="" type="checkbox"/>	Shenzhen Tianxu Communication Technology Co., Ltd.	Human Simulating Liquid	Head 5200	Head 5200	NCR	NCR
<input checked="" type="checkbox"/>	Shenzhen Tianxu Communication Technology Co., Ltd.	Human Simulating Liquid	Head 5800	Head 5800	NCR	NCR

3. SAR Measurement Procedures

The measurement procedures are as follows:

<Conducted power measurement>

- (a) For WWAN power measurement, use base station simulator to configure EUT WWAN transmission in conducted connection with RF cable, at maximum power in each supported wireless interface and frequency band.
- (b) Read the WWAN RF power level from the base station simulator.
- (c) For Wi-Fi/BT power measurement, use engineering software to configure EUT Wi-Fi/BT continuously transmission, at maximum RF power in each supported wireless interface and frequency band.
- (d) Connect EUT RF port through RF cable to the power meter, and measure Wi-Fi/BT output power.

<SAR measurement>

- (a) Use base station simulator to configure EUT WWAN transmission in radiated connection, and engineering software to configure EUT Wi-Fi/BT continuously transmission, at maximum RF power, in the highest power channel.
- (b) Place the EUT in the positions as Appendix A demonstrates.
- (c) Set scan area, grid size and other setting on the OPENSAR software.
- (d) Measure SAR results for the highest power channel on each testing position.
- (e) Find out the largest SAR result on these testing positions of each band.
- (f) Measure SAR results for other channels in worst SAR testing position if the reported SAR of highest power channel is larger than 0.8 W/kg.

According to the test standard, the recommended procedure for assessing the peak spatial-average SAR value consists of the following steps:

- (a) Power reference measurement
- (b) Area scan
- (c) Zoom scan
- (d) Power drift measurement

3.1. Power Reference

The Power Reference Measurement and Power Drift Measurements are for monitoring the power drift of the device under test in the batch process. The minimum distance of probe sensors to surface determines the closest measurement point to phantom surface. This distance cannot be smaller than the distance of sensor calibration points to probe tip as defined in the probe properties.

3.2. Area scan & Zoom scan

The area scan is a 2D scan to find the hot spot location on the DUT. The zoom scan is a 3D scan

above the hot spot to calculate the 1g and 10g SAR value.

Measurement of the SAR distribution with a grid of 8 to 16 mm * 8 to 16 mm and a constant distance to the inner surface of the phantom. Since the sensors cannot directly measure at the inner phantom surface, the values between the sensors and the inner phantom surface are extrapolated. With these values the area of the maximum SAR is calculated by an interpolation scheme. Around this point, a cube of 30 * 30 * 30 mm or 32 * 32 * 32 mm is assessed by measuring 5 or 8 * 5 or 8 * 4 or 5 mm. With these data, the peak spatial-average SAR value can be calculated.

From the scanned SAR distribution, identify the position of the maximum SAR value, in addition identify the positions of any local maxima with SAR values within 2 dB of the maximum value that will not be within the zoom scan of other peaks; additional peaks shall be measured only when the primary peak is within 2 dB of the SAR compliance limit (e.g., 1 W/kg for 1,6 W/kg 1 g limit, or 1,26 W/kg for 2 W/kg, 10 g limit).

Area scan & Zoom scan scan parameters extracted from FCC KDB 865664 D01 SAR measurement 100 MHz to 6 GHz.

		≤ 3 GHz	> 3 GHz
Maximum distance from closest measurement point (geometric center of probe sensors) to phantom surface		5 ± 1 mm	$\frac{1}{2} \cdot \delta \cdot \ln(2) \pm 0.5$ mm
Maximum probe angle from probe axis to phantom surface normal at the measurement location		30° ± 1°	20° ± 1°
Maximum area scan spatial resolution: Δx_{Area} , Δy_{Area}		≤ 2 GHz: ≤ 15 mm 2 – 3 GHz: ≤ 12 mm	3 – 4 GHz: ≤ 12 mm 4 – 6 GHz: ≤ 10 mm
		When the x or y dimension of the test device, in the measurement plane orientation, is smaller than the above, the measurement resolution must be ≤ the corresponding x or y dimension of the test device with at least one measurement point on the test device.	
Maximum zoom scan spatial resolution: Δx_{Zoom} , Δy_{Zoom}		≤ 2 GHz: ≤ 8 mm 2 – 3 GHz: ≤ 5 mm*	3 – 4 GHz: ≤ 5 mm* 4 – 6 GHz: ≤ 4 mm*
Maximum zoom scan spatial resolution, normal to phantom surface	uniform grid: $\Delta z_{Zoom}(n)$	≤ 5 mm	3 – 4 GHz: ≤ 4 mm 4 – 5 GHz: ≤ 3 mm 5 – 6 GHz: ≤ 2 mm
	graded grid	$\Delta z_{Zoom}(1)$: between 1 st two points closest to phantom surface	≤ 4 mm 3 – 4 GHz: ≤ 3 mm 4 – 5 GHz: ≤ 2.5 mm 5 – 6 GHz: ≤ 2 mm
		$\Delta z_{Zoom}(n>1)$: between subsequent points	≤ 1.5 · $\Delta z_{Zoom}(n-1)$
Minimum zoom scan volume	x, y, z	≥ 30 mm	3 – 4 GHz: ≥ 28 mm 4 – 5 GHz: ≥ 25 mm 5 – 6 GHz: ≥ 22 mm

Note: δ is the penetration depth of a plane-wave at normal incidence to the tissue medium; see draft standard IEEE P1528-2011 for details.

* When zoom scan is required and the *reported* SAR from the *area scan based 1-g SAR estimation* procedures of KDB 447498 is ≤ 1.4 W/kg, ≤ 8 mm, ≤ 7 mm and ≤ 5 mm zoom scan resolution may be applied, respectively, for 2 GHz to 3 GHz, 3 GHz to 4 GHz and 4 GHz to 6 GHz.

3.3. Description of interpolation/extrapolation scheme

The local SAR inside the phantom is measured using small dipole sensing elements inside a probe body. The probe tip must not be in contact with the phantom surface in order to minimise measurements errors, but the highest local SAR will occur at the surface of the phantom.

An extrapolation is using to determinate this highest local SAR values. The extrapolation is based on a fourth-order least-square polynomial fit of measured data. The local SAR value is then extrapolated from the liquid surface with a 1 mm step.

The measurements have to be performed over a limited time (due to the duration of the battery) so the step of measurement is high. It could vary between 5 and 8 mm. To obtain an accurate assessment of the maximum SAR averaged over 10 grams and 1 gram requires a very fine resolution in the three dimensional scanned data array.

3.4. Volumetric Scan

The volumetric scan consists to a full 3D scan over a specific area. This 3D scan is useful form multi Tx SAR measurement. Indeed, it is possible with OpenSAR to add, point by point, several volumetric scan to calculate the SAR value of the combined measurement as it is define in the standard IEEE1528 and IEC62209.

3.5. Power Drift

All SAR testing is under the EUT install full charged battery and transmit maximum output power. In OpenSAR measurement software, the power reference measurement and power drift measurement procedures are used for monitoring the power drift of EUT during SAR test. Both these procedures measure the field at a specified reference position before and after the SAR testing. The software will calculate the field difference in V/m. If the power drifts more than $\pm 5\%$, the SAR will be retested.

4. System Verification Procedure

4.1. Tissue Verification

The following tissue formulations are provided for reference only as some of the parameters have not been thoroughly verified. The composition of ingredients may be modified accordingly to achieve the desired target tissue parameters required for routine SAR evaluation.

Ingredients (% of weight)	Head Tissue									
	750	835	900	1800	1900	2000	2450	2600	5200	5800
Frequency Band (MHz)										
Water	34.40	34.40	34.40	55.36	55.36	57.87	57.87	57.87	65.53	65.53
NaCl	0.79	0.79	0.79	0.35	0.35	0.16	0.16	0.16	0.00	0.00
1,2-Propanediol	64.81	64.81	64.81	0.00	0.00	0.00	0.00	0.00	0.00	0.00
Triton X-100	0.00	0.00	0.00	30.45	30.45	19.97	19.97	19.97	24.24	24.24
DGBE	0.00	0.00	0.00	13.84	13.84	22.00	22.00	22.00	10.23	10.23

For SAR measurement of the field distribution inside the phantom, the phantom must be filled with homogeneous tissue simulating liquid to a depth of at least 15 cm. For head SAR testing, the liquid depth from the ear reference point (ERP) of the phantom to the liquid top surface is larger than 15 cm.

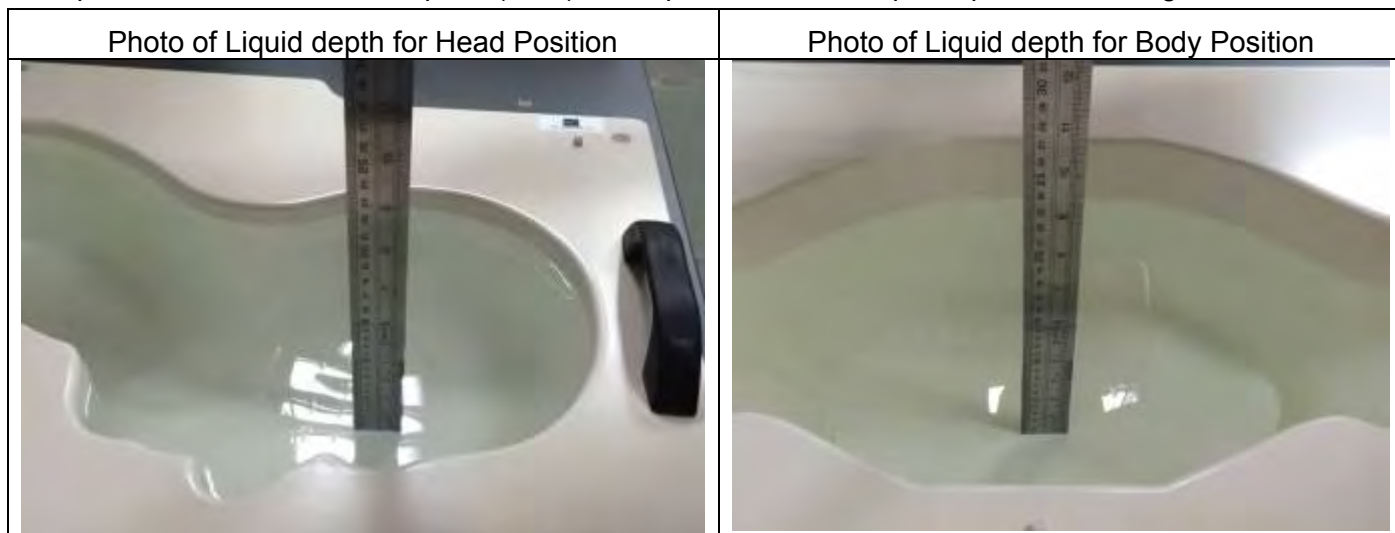

4.1.1. Tissue Dielectric Parameter Check Results

The simulating liquids should be checked at the beginning of a series of SAR measurements to determine if the dielectric parameters are within the tolerances of the specified target values. The measured conductivity and relative permittivity should be within $\pm 5\%$ of the target values.

Tissue Type	Measured Frequency (MHz)	Target Tissue		Measured Tissue		Liquid Temp.	Test Date
		ϵ_r ($\pm 5\%$)	σ (S/m) ($\pm 5\%$)	ϵ_r	σ (S/m)		
Head 750	750	41.96 (39.86~44.06)	0.89 (0.85~0.93)	42.33	0.93	21.5 °C	Oct. 26, 2023
Head 850	835	41.50 (39.43~43.58)	0.90 (0.86~0.95)	41.55	0.90	21.5 °C	Oct. 23, 2023
Head 1800	1800	40.00 (38.00~42.00)	1.40 (1.33~1.47)	40.06	1.43	21.7 °C	Oct. 31, 2023
Head 1900	1900	40.00 (38.00~42.00)	1.40 (1.33~1.47)	39.02	1.44	21.5 °C	Oct. 24, 2023
Head 2450	2450	39.20 (37.24~41.16)	1.80 (1.71~1.89)	38.73	1.80	21.5 °C	Oct. 28, 2023
Head 2600	2600	39.01 (37.06~40.96)	1.96 (1.86~2.06)	38.57	1.91	21.4 °C	Oct. 29, 2023
Head 3500	3500	37.93 (36.04~39.82)	2.91 (2.77~3.05)	38.21	2.80	21.7 °C	Oct. 19, 2023
Head 5200	5200	36.00 (34.20~37.80)	4.66 (4.43~4.89)	35.78	4.57	21.5 °C	Oct. 21, 2023
Head 5800	5800	35.30 (33.54~37.07)	5.27 (5.01~5.53)	35.18	5.14	21.9 °C	Oct. 22, 2023

NOTE: The dielectric parameters of the tissue-equivalent liquid should be measured under similar ambient conditions and within 2 °C of the conditions expected during the SAR evaluation to satisfy protocol requirements.

4.2. System Verification Procedure

The system verification is performed for verifying the accuracy of the complete measurement system and performance of the software. The dipole is connected to the signal source consisting of signal generator and amplifier via a directional coupler, N-connector cable and adaption to SMA. It is fed with a power of 100mW (below 5GHz) or 100mW (above 5GHz). To adjust this power a power meter is used. The power sensor is connected to the cable before the system verification to measure the power at this point and do adjustments at the signal generator. At the outputs of the directional coupler both return loss as well as forward power are controlled during the system verification to make sure that emitted power at the dipole is kept constant. This can also be checked by the power drift measurement after the test (result on plot).

The system verification is shown as below picture:

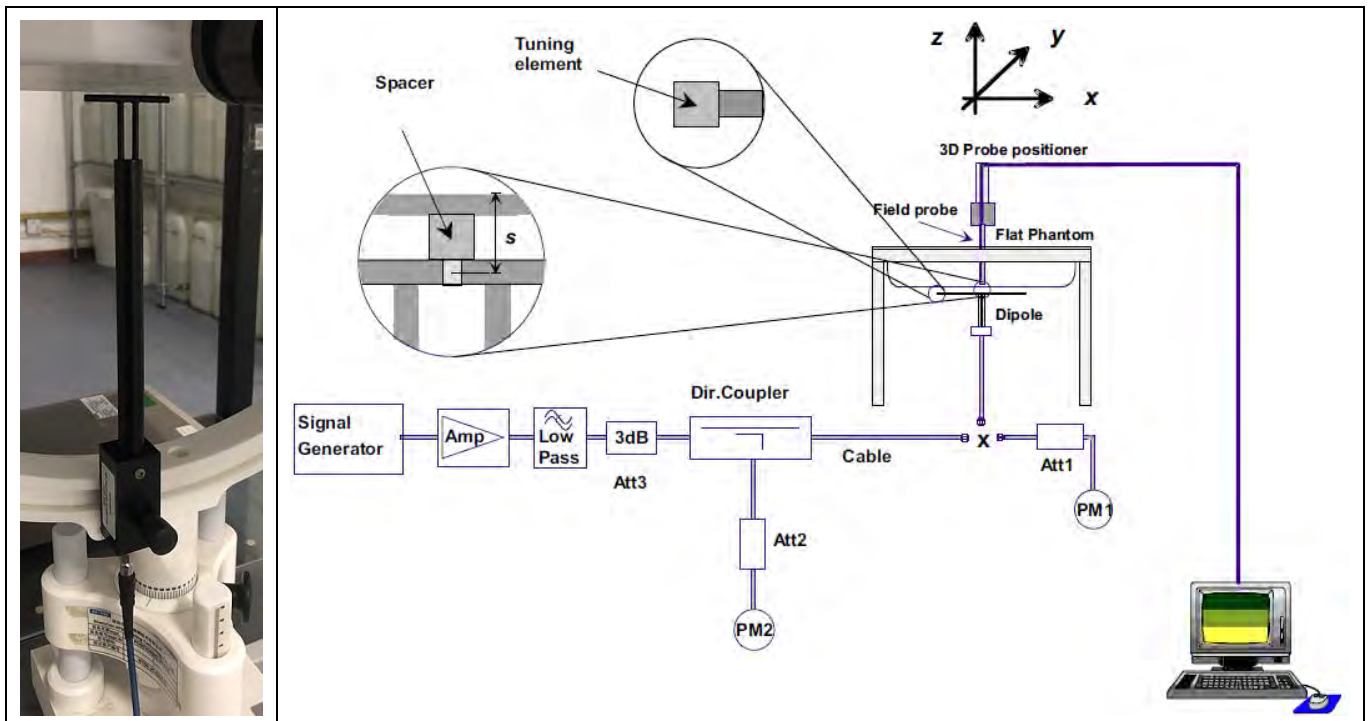

4.2.1. System Verification Results

Comparing to the original SAR value provided by SATIMO, the verification data should be within its specification of $\pm 10\%$. Below table shows the target SAR and measured SAR after normalized to 1W input power. The table below indicates the system performance verification can meet the variation criterion and the plots can be referred to Appendix B of this report.

System Verification	Target SAR (1W)		Measured SAR		Liquid Temp.	Delta (%)		Test Date
	($\pm 10\%$)		(Normalized to 1W)			1-g	10-g	
	1-g (W/Kg)	10-g (W/Kg)	1-g (W/Kg)	10-g (W/Kg)				
750MHz	8.53	5.56	9.17	5.25	21.5 °C	7.50%	-5.58%	Oct. 26, 2023
	(7.68~9.38)	(5.01~6.11)						
835MHz	9.84	6.22	9.95	5.72	21.5 °C	1.12%	-8.04%	Oct. 23, 2023
	(8.86~10.82)	(5.60~6.84)						
1800MHz	37.96	19.81	35.42	19.26	21.7 °C	-6.69%	-2.78%	Oct. 31, 2023
	(34.17~41.75)	(17.83~21.79)						
1900MHz	40.37	20.48	40.29	21.84	21.5 °C	-0.20%	6.64%	Oct. 24, 2023
	(36.34~44.40)	(18.44~22.52)						
2450MHz	53.69	23.94	53.39	22.05	21.5 °C	-0.56%	-6.37%	Oct. 28, 2023
	(48.33~59.05)	(21.55~26.33)						
2600MHz	55.83	24.19	59.68	24.97	21.4 °C	6.90%	3.22%	Oct. 29, 2023
	(50.25~61.41)	(21.78~26.60)						
3500MHz	67.18	24.50	63.89	25.07	21.7 °C	-4.90%	2.33%	Oct. 19, 2023
	(60.47~73.89)	(22.05~26.95)						
5200MHz	162.34	55.42	172.31	59.65	21.5 °C	6.14%	7.63%	Oct. 21, 2023
	(146.11~178.57)	(49.88~60.96)						
5800MHz	178.89	59.32	166.47	60.83	21.9 °C	-6.94%	2.55%	Oct. 22, 2023
	(161.01~196.77)	(53.39~65.25)						

5. SAR Measurement variability and uncertainty

5.1. SAR measurement variability

Per KDB865664 D01 SAR measurement 100 MHz to 6 GHz, SAR measurement variability must be assessed for each frequency band, which is determined by the SAR probe calibration point and tissue-equivalent medium used for the device measurements. The additional measurements are repeated after the completion of all measurements requiring the same head or body tissue-equivalent medium in a frequency band. The test device should be returned to ambient conditions (normal room temperature) with the battery fully charged before it is re-mounted on the device holder for the repeated measurement(s) to minimize any unexpected variations in the repeated results.

- 1) Repeated measurement is not required when the original highest measured SAR is < 0.80 W/kg; steps 2) through 4) do not apply.
- 2) When the original highest measured SAR is ≥ 0.80 W/kg, repeat that measurement once.
- 3) Perform a second repeated measurement only if the ratio of largest to smallest SAR for the original and first repeated measurements is > 1.20 or when the original or repeated measurement is ≥ 1.45 W/kg (~ 10% from the 1-g SAR limit).
- 4) Perform a third repeated measurement only if the original, first or second repeated measurement is ≥ 1.5 W/kg and the ratio of largest to smallest SAR for the original, first and second repeated measurements is > 1.20 .

5.2. SAR measurement uncertainty

Per KDB865664 D01 SAR Measurement 100 MHz to 6 GHz, when the highest measured 1-g SAR within a frequency band is < 1.5 W/kg, the extensive SAR measurement uncertainty analysis described in IEEE Std 1528-2013 is not required in SAR reports submitted for equipment approval. The equivalent ratio (1.5/1.6) is applied to extremity and occupational exposure conditions.

6. RF Exposure Positions

6.1. Ear and handset reference point

Figure 6.1.1 shows the front, back, and side views of the SAM phantom. The center-of-mouth reference point is labeled “M”, the left ear reference point (ERP) is marked “LE”, and the right ERP is marked —RE



Fig 6.1.1 Front, back, and side views of SAM phantom

6.2. Definition of the cheek position

1. Define two imaginary lines on the handset, the vertical centerline and the horizontal line. The vertical centerline passes through two points on the front side of the handset: the midpoint of the width w_t of the handset at the level of the acoustic output (point A in Figure 6.2.1 and Figure 6.2.2), and the midpoint of the width w_b of the bottom of the handset (point B). The horizontal line is perpendicular to the vertical centerline and passes through the center of the acoustic output (see Figure 6.2.1). The two lines intersect at point A. Note that for many handsets, point A coincides with the center of the acoustic output; however, the acoustic output may be located elsewhere on the horizontal line. Also note that the vertical centerline is not necessarily parallel to the front face of the handset (see Figure 6.2.2), especially for clamshell handsets, handsets with flip covers, and other irregularly-shaped handsets.
2. Position the handset close to the surface of the phantom such that point A is on the (virtual) extension of the line passing through points RE and LE on the phantom (see Figure 6.2.3), such that the plane defined by the vertical centerline and the horizontal line of the handset is approximately parallel to the sagittal plane of the phantom.
3. Translate the handset towards the phantom along the line passing through RE and LE until handset point A touches the pinna at the ERP
4. While maintaining the handset in this plane, rotate it around the LE-RE line until the vertical centerline is in the plane normal to the plane containing B-M and N-F lines, i.e., the Reference Plane.
5. Rotate the handset around the vertical centerline until the handset (horizontal line) is parallel to the N-F line.

6. While maintaining the vertical centerline in the Reference Plane, keeping point A on the line passing through RE and LE, and maintaining the handset contact with the pinna, rotate the handset about the N-F line until any point on the handset is in contact with a phantom point below the pinna on the cheek. See Figure 6.2.3. The actual rotation angles should be documented in the test report.

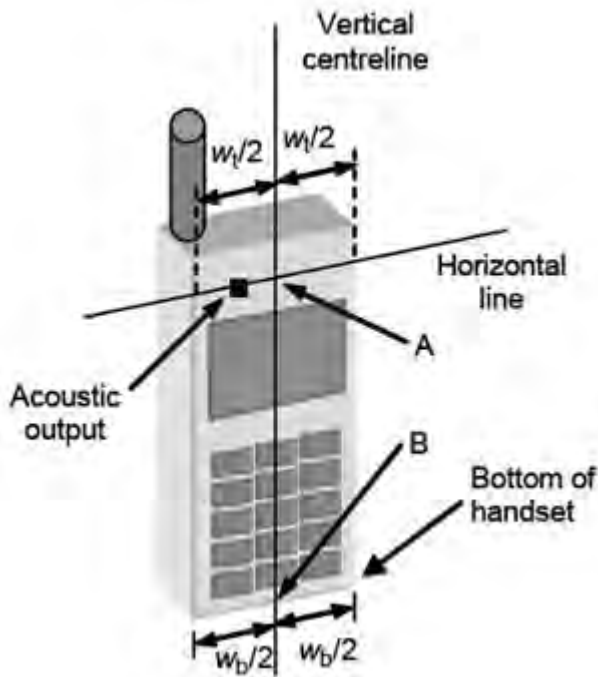

Fig 6.2.1 Handset vertical and horizontal reference lines—fixed case

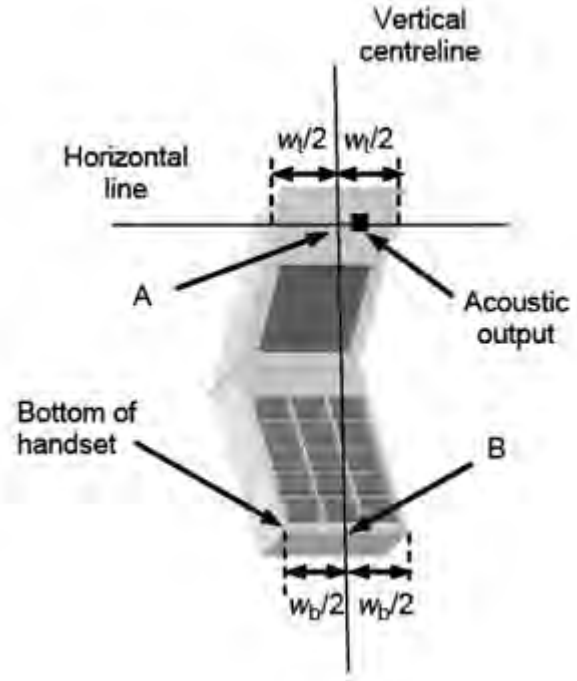

Fig 6.2.2 Handset vertical and horizontal reference lines—“clam-shell case”

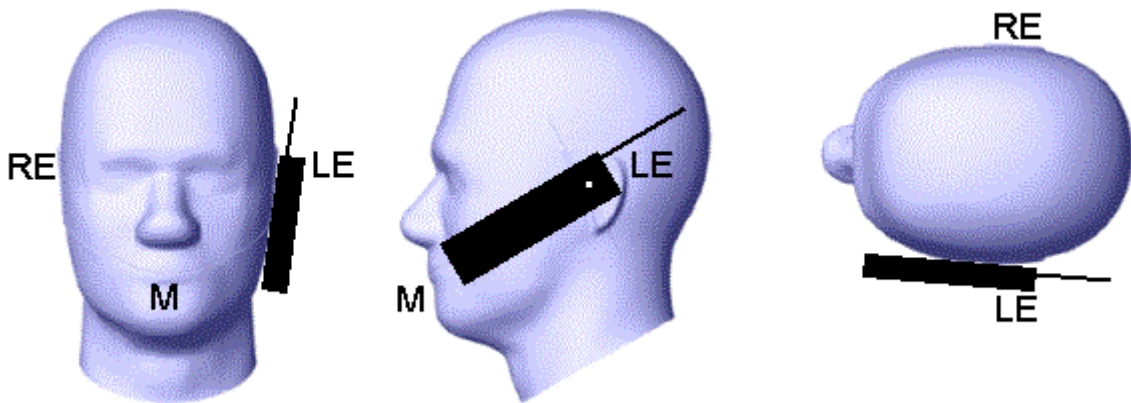

Fig 6.2.3 cheek or touch position. The reference points for the right ear (RE), left ear (LE), and mouth (M), which establish the Reference Plane for handset positioning, are indicated.

6.3. Definition of the tilt position

1. While maintaining the orientation of the handset, retract the handset parallel to the reference plane far enough away from the phantom to enable a rotation of the device by 15 degree.
2. Rotate the Handset around the horizontal line by 15 degree (see Figure 6.3.1).
3. While maintaining the orientation of the handset, move the handset towards the phantom on a line passing through RE and LE until any part of the handset touches the ear. The tilt position is obtained when the contact is on the pinna. If the contact is at any location other than the pinna, e.g., the antenna with the back of the phantom head, the angle of the handset shall be reduced. In this case, the tilt position is obtained if any part of the handset is in contact with the pinna as well as a second part of the handset is in contact with the phantom, e.g., the antenna with the back of the head.

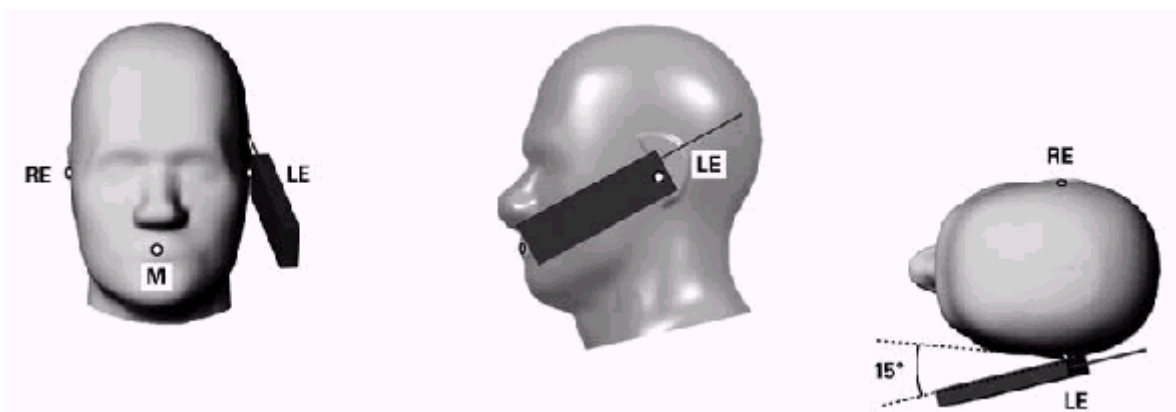

Figure 6.3.1 – Tilt position of the wireless device on the left side of SAM

6.4. Body Worn Accessory

1. Body-worn operating configurations are tested with the belt-clips and holsters attached to the device and positioned against a flat phantom in a normal use configuration (see Figure 6.4.1). Per KDB 648474 D04, body-worn accessory exposure is typically related to voice mode operations when handsets are carried in body-worn accessories. The body-worn accessory procedures in FCC KDB 447498 D01 should be used to test for body-worn accessory SAR compliance, without a headset connected to it. This enables the test results for such configuration to be compatible with that required for hotspot mode when the body-worn accessory test separation distance is greater than or equal to that required for hotspot mode, when applicable. When the reported SAR for body-worn accessory, measured without a headset connected to the handset is < 1.2 W/kg, the highest reported SAR configuration for that wireless mode and frequency band should be repeated for that body-worn accessory with a headset attached to the handset.
2. Accessories for body-worn operation configurations are divided into two categories: those that do not contain metallic components and those that do contain metallic components and those that do contain metallic components. When multiple accessories that do not contain metallic components are supplied with the device, the device is tested with only the accessory that dictates the closest

spacing to the body. Then multiple accessories that contain metallic components are tested with the device with each accessory. If multiple accessories share an identical metallic component (i.e. the same metallic belt-clip used with different holsters with no other metallic components) only the accessory that dictates the closest spacing to the body is tested.

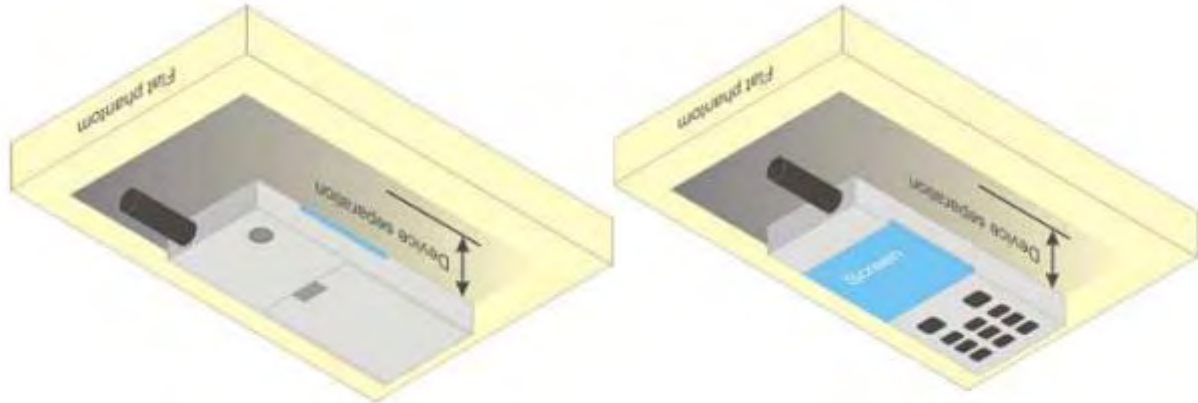

Figure 6.4.1 – Test positions for body-worn devices

6.5. Wireless Router Devices

Some battery-operated handsets have the capability to transmit and receive user through simultaneous transmission of WLAN simultaneously with a separate licensed transmitter. The FCC has provided guidance in FCC KDB Publication 941225 D06 where SAR test considerations for handsets ($L \times W \geq 9 \text{ cm} \times 5 \text{ cm}$) are based on a composite test separation distance of 10mm from the front, back and edges of the device containing transmitting antennas within 2.5cm of their edges, determined from general mixed use conditions for this type of devices. Since the hotspot SAR results may overlap with the body-worn accessory SAR requirements, the more conservative configurations can be considered, thus excluding some body-worn accessory SAR tests.

When the user enables the personal wireless router functions for the handset, actual operations include simultaneous transmission of both the WLAN transmitter and another licensed transmitter. Both transmitters often do not transmit at the same transmitting frequency and thus cannot be evaluated for SAR under actual use conditions due to the limitations of the SAR assessment probes. Therefore, SAR must be evaluated for each frequency transmission and mode separately and spatially summed with the WLAN transmitter according to FCC KDB Publication 447498 D01 publication procedures. The “Portable Hotspot” feature on the handset was NOT activated during SAR assessments, to ensure the SAR measurements were evaluated for a single transmission frequency RF signal at a time.

7. RF Output Power

7.1. GSM Conducted Power

Band GSM850		Burst-Averaged output Power (dBm)			Frame-Averaged output Power (dBm)			
Tx Channel	Tune-up (dBm)	128	189	251	Tune-up (dBm)	128	189	251
Frequency (MHz)		824.2	836.4	848.8		824.2	836.4	848.8
GSM (GMSK)	34.50	34.00	34.05	33.79	25.47	24.97	25.02	24.76
GPRS(GMSK,1 Tx slot)	34.50	33.98	34.02	33.77	25.47	24.95	24.99	24.74
GPRS(GMSK,2 Tx slot)	33.50	33.22	33.27	33.00	27.48	27.20	27.25	26.98
GPRS(GMSK,3 Tx slot)	32.00	31.50	31.52	31.28	27.74	27.24	27.26	27.02
GPRS(GMSK,4 Tx slot)	30.50	30.40	30.44	30.23	27.49	27.39	27.43	27.22
EGPRS(8PSK,1 Tx slot)	27.50	27.19	27.05	27.12	18.47	18.16	18.02	18.09
EGPRS(8PSK,2 Tx slot)	26.50	26.16	26.00	25.97	20.48	20.14	19.98	19.95
EGPRS(8PSK,3 Tx slot)	24.50	24.07	24.30	24.10	20.24	19.81	20.04	19.84
EGPRS(8PSK,4 Tx slot)	22.50	22.42	22.23	22.00	19.49	19.41	19.22	18.99
Band GSM1900		Burst-Averaged output Power (dBm)			Frame-Averaged output Power (dBm)			
Tx Channel	Tune-up (dBm)	512	661	810	Tune-up (dBm)	512	661	810
Frequency (MHz)		1850.2	1880	1909.8		1850.2	1880	1909.8
GSM (GMSK)	31.50	30.22	30.83	31.25	22.47	21.19	21.80	22.22
GPRS(GMSK,1 Tx slot)	31.50	30.18	30.86	31.26	22.47	21.15	21.83	22.23
GPRS(GMSK,2 Tx slot)	31.00	29.55	30.18	30.63	24.98	23.53	24.16	24.61
GPRS(GMSK,3 Tx slot)	29.50	27.85	28.53	29.02	25.24	23.59	24.27	24.76
GPRS(GMSK,4 Tx slot)	28.00	26.70	27.38	27.88	24.99	23.69	24.37	24.87
EGPRS(8PSK,1 Tx slot)	27.50	27.72	27.30	27.17	18.47	18.69	18.27	18.14
EGPRS(8PSK,2 Tx slot)	27.50	27.06	25.95	25.92	21.48	21.04	19.93	19.90
EGPRS(8PSK,3 Tx slot)	25.50	25.06	24.26	23.74	21.24	20.80	20.00	19.48
EGPRS(8PSK,4 Tx slot)	24.00	23.64	23.04	22.88	20.99	20.63	20.03	19.87

7.2. WCDMA Conducted Power

WCDMA Band 2	Burst-Averaged output Power (dBm)			
Tx Channel	Tune-up (dBm)	9262	9400	9538
Frequency (MHz)		1852.4	1880	1907.6
RMC12.2K	23.50	23.09	22.97	23.05
HSDPA Sub 1	22.50	22.09	22.06	22.11
HSDPA Sub 2	22.00	21.58	21.52	21.58

HSDPA Sub 3	21.00	20.56	20.33	20.54
HSDPA Sub 4	21.00	20.12	20.24	20.53
HSUPA Sub 1	22.00	20.93	21.77	21.85
HSUPA Sub 2	22.00	21.92	21.76	21.88
HSUPA Sub 3	21.00	20.19	20.67	20.79
HSUPA Sub 4	22.50	22.03	21.94	22.05
HSUPA Sub 5	21.50	20.38	21.03	21.45
WCDMA Band 4	Burst-Averaged output Power (dBm)			
Tx Channel	Tune-up (dBm)	1312	1413	1513
Frequency (MHz)		1712.4	1732.6	1752.6
RMC12.2K	24.50	24.09	23.82	23.88
HSDPA Sub 1	23.50	23.12	22.80	22.87
HSDPA Sub 2	23.00	22.65	22.37	22.48
HSDPA Sub 3	21.50	21.20	20.96	21.46
HSDPA Sub 4	22.00	21.59	21.00	21.41
HSUPA Sub 1	23.00	22.02	22.64	22.66
HSUPA Sub 2	23.00	22.98	22.67	22.73
HSUPA Sub 3	22.00	21.13	21.53	21.58
HSUPA Sub 4	23.50	23.08	22.79	22.84
HSUPA Sub 5	22.50	21.63	22.02	22.11
WCDMA Band 5	Burst-Averaged output Power (dBm)			
Tx Channel	Tune-up (dBm)	4132	4182	4233
Frequency (MHz)		826.4	836.4	846.6
RMC12.2K	24.50	24.46	24.49	24.38
HSDPA Sub 1	24.00	23.46	23.52	23.41
HSDPA Sub 2	23.50	23.05	23.06	22.93
HSDPA Sub 3	22.50	21.58	22.12	22.01
HSDPA Sub 4	22.50	21.82	21.80	22.04
HSUPA Sub 1	23.50	21.95	23.35	23.25
HSUPA Sub 2	23.50	23.41	23.33	23.30
HSUPA Sub 3	22.50	21.85	22.23	21.89
HSUPA Sub 4	24.00	23.48	23.50	23.41
HSUPA Sub 5	23.00	22.07	22.80	22.68

7.3. LTE Conducted Power

Band	Band Width	Modulation	RB Configuration		Tune-up (dBm)	Channel/Frequency(MHz)		
			RB Size	RB Offset		18607/1850.7	18900/1880	19193/1909.3
LTE Band 2	1.4MHz	QPSK	1	0	23.00	22.67	22.22	22.47
			1	2	23.00	22.66	22.28	22.53
			1	5	23.00	22.64	22.21	22.53
			3	0	23.00	22.64	22.27	22.54
			3	1	23.00	22.61	22.23	22.57
			3	2	23.00	22.62	22.21	22.57
		16QAM	6	0	22.00	21.65	21.28	21.59
			1	0	22.00	21.82	21.37	21.82
			1	2	22.00	21.75	21.42	21.86
			1	5	22.00	21.74	21.44	21.76
			3	0	22.00	21.59	21.25	21.51
			3	1	22.00	21.65	21.24	21.53
			3	2	22.00	21.54	21.21	21.50
			6	0	21.00	20.67	20.34	20.65
Band	Band Width	Modulation	RB Configuration		Tune-up (dBm)	Channel/Frequency(MHz)		
			RB Size	RB Offset		18615/1851.5	18900/1880	19185/1908.5
LTE Band 2	3MHz	QPSK	1	0	23.00	22.53	22.18	22.37
			1	7	23.00	22.52	22.20	22.46
			1	14	23.00	22.44	22.18	22.51
			8	0	22.00	21.53	21.20	21.46
			8	4	22.00	21.49	21.20	21.48
			8	7	22.00	21.47	21.19	21.47
			15	0	22.00	21.50	21.22	21.48
		16QAM	1	0	22.00	21.77	21.40	21.64
			1	7	22.00	21.77	21.42	21.77
			1	14	22.00	21.73	21.51	21.79
			8	0	21.00	20.59	20.33	20.53
			8	4	21.00	20.54	20.24	20.56
			8	7	21.00	20.52	20.26	20.62
			15	0	21.00	20.53	20.24	20.51
Band	Band Width	Modulation	RB Configuration		Tune-up (dBm)	Channel/Frequency(MHz)		

2			1	74	22.50	22.04	22.11	22.42			
			36	0	21.50	21.27	21.17	21.29			
			36	18	21.50	21.23	21.20	21.22			
			36	37	21.50	21.20	21.18	21.27			
			75	0	21.50	21.28	21.21	21.32			
		16QAM	1	0	22.00	21.64	21.19	21.33			
			1	37	22.00	21.53	21.47	21.43			
			1	74	22.00	21.34	21.32	21.62			
			36	0	20.50	20.28	20.16	20.30			
			36	18	20.50	20.21	20.18	20.22			
			36	37	20.50	20.24	20.23	20.31			
			75	0	20.50	20.21	20.19	20.34			
			Band	Band Width	Modulation	RB Configuration		Tune-up (dBm)	Channel/Frequency(MHz)		
						RB Size	RB Offset		18700/1860	18900/1880	19100/1900
LTE Band 2	20MHz	QPSK	1	0	22.50	22.39	21.94	22.08			
			1	49	22.50	22.18	22.16	22.22			
			1	99	22.50	21.98	21.97	22.36			
			50	0	21.50	21.04	21.31	21.28			
			50	24	21.50	21.22	21.18	21.25			
			50	49	21.50	21.12	21.34	21.05			
			100	0	21.50	21.06	21.28	21.26			
		16QAM	1	0	22.00	21.57	21.18	21.26			
			1	49	22.00	21.42	21.39	21.49			
			1	99	22.00	21.17	21.33	21.67			
			50	0	20.50	19.99	20.29	20.30			
			50	24	20.50	20.15	20.17	20.28			
			50	49	20.50	20.08	20.31	20.11			
			100	0	20.50	20.02	20.31	20.22			

Band	Band Width	Modulation	RB Configuration		Tune-up (dBm)	Channel/Frequency(MHz)		
			RB Size	RB Offset		19957/1710.7	20175/1732.5	20393/1754.3
LTE Band 4	1.4MHz	QPSK	1	0	24.00	23.76	23.36	23.16
			1	2	24.00	23.77	23.41	23.14
			1	5	24.00	23.69	23.36	23.15
			3	0	24.00	23.74	23.38	23.21
			3	1	24.00	23.74	23.34	23.21

			3	2	24.00	23.70	23.38	23.19
			6	0	23.00	22.73	22.41	22.22
		16QAM	1	0	23.00	23.00	22.59	22.45
			1	2	23.00	22.94	22.69	22.50
			1	5	23.00	22.94	22.64	22.35
			3	0	23.00	22.71	22.38	22.25
			3	1	23.00	22.73	22.35	22.22
			3	2	23.00	22.68	22.39	22.19
			6	0	22.00	21.79	21.47	21.30
Band	Band Width	Modulation	RB Configuration		Tune-up (dBm)	Channel/Frequency(MHz)		
			RB Size	RB Offset		19965/1711.5	20175/1732.5	20385/1753.5
LTE Band 4	3MHz	QPSK	1	0	24.00	23.67	23.33	23.16
			1	7	24.00	23.68	23.33	23.16
			1	14	24.00	23.59	23.33	23.14
			8	0	23.00	22.67	22.38	22.20
			8	4	23.00	22.63	22.37	22.20
			8	7	23.00	22.63	22.34	22.20
			15	0	23.00	22.69	22.36	22.20
		16QAM	1	0	23.00	22.84	22.66	22.45
			1	7	23.00	22.94	22.62	22.49
			1	14	23.00	22.79	22.58	22.36
			8	0	22.00	21.75	21.45	21.25
			8	4	22.00	21.73	21.41	21.28
			8	7	22.00	21.70	21.40	21.26
			15	0	22.00	21.69	21.40	21.24
Band	Band Width	Modulation	RB Configuration		Tune-up (dBm)	Channel/Frequency(MHz)		
			RB Size	RB Offset		19975/1712.5	20175/1732.5	20375/1752.5
LTE Band 4	5MHz	QPSK	1	0	24.00	23.71	23.41	23.23
			1	12	24.00	23.63	23.37	23.18
			1	24	24.00	23.61	23.41	23.22
			12	0	23.00	22.73	22.43	22.21
			12	6	23.00	22.69	22.40	22.25
			12	11	23.00	22.65	22.39	22.21
			25	0	23.00	22.68	22.40	22.23
		16QAM	1	0	23.00	22.92	22.64	22.51
			1	12	23.00	22.84	22.63	22.48

Band	Band Width	Modulation	RB Configuration		Tune-up (dBm)	Channel/Frequency(MHz)		
			RB Size	RB Offset		20000/1715	20175/1732.5	20350/1750
			1	24	23.00	22.92	22.66	22.49
			12	0	22.00	21.74	21.42	21.21
			12	6	22.00	21.70	21.39	21.21
			12	11	22.00	21.67	21.36	21.19
			25	0	22.00	21.69	21.39	21.24
LTE Band 4	10MHz	QPSK	1	0	24.00	23.71	23.40	23.20
			1	24	24.00	23.62	23.43	23.25
			1	49	24.00	23.47	23.39	23.18
			25	0	23.00	22.61	22.48	22.18
			25	12	23.00	22.56	22.41	22.27
			25	24	23.00	22.60	22.38	22.28
		16QAM	50	0	23.00	22.60	22.42	22.24
			1	0	23.00	22.99	22.70	22.48
			1	24	23.00	22.85	22.72	22.45
			1	49	23.00	22.67	22.64	22.37
			25	0	22.00	21.61	21.49	21.19
			25	12	22.00	21.58	21.47	21.30
			25	24	22.00	21.59	21.39	21.26
			50	0	22.00	21.63	21.41	21.20
Band	Band Width	Modulation	RB Configuration		Tune-up (dBm)	Channel/Frequency(MHz)		
			RB Size	RB Offset		20025/1717.5	20175/1732.5	20325/1747.5
LTE Band 4	15MHz	QPSK	1	0	24.00	23.60	23.34	23.17
			1	37	24.00	23.49	23.36	23.24
			1	74	24.00	23.29	23.26	23.13
			36	0	23.00	22.58	22.37	22.20
			36	18	23.00	22.47	22.37	22.28
			36	37	23.00	22.44	22.36	22.22
		16QAM	75	0	23.00	22.54	22.36	22.26
			1	0	23.00	22.88	22.60	22.53
			1	37	23.00	22.69	22.57	22.42
			1	74	23.00	22.59	22.53	22.39
			36	0	22.00	21.52	21.41	21.22
			36	18	22.00	21.51	21.31	21.24
			36	37	22.00	21.48	21.29	21.23

Band	Band Width	Modulation	RB Configuration		Tune-up (dBm)	Channel/Frequency(MHz)		
			RB Size	RB Offset		20050/1720	20175/1732.5	20300/1745
			75	0	21.50	21.47	21.40	21.21
LTE Band 4	20MHz	QPSK	1	0	24.00	23.56	23.21	23.25
			1	49	24.00	23.46	23.40	23.25
			1	99	24.00	23.31	23.23	23.11
			50	0	22.50	22.44	22.48	22.29
			50	24	22.50	22.48	22.41	22.27
			50	49	22.50	22.38	22.38	22.36
			100	0	22.50	22.46	22.38	22.33
		16QAM	1	0	23.00	22.86	22.46	22.53
			1	49	23.00	22.71	22.70	22.48
			1	99	23.00	22.49	22.53	22.36
			50	0	22.00	21.47	21.50	21.21
			50	24	22.00	21.44	21.39	21.28
			50	49	22.00	21.37	21.32	21.36
			100	0	21.50	21.39	21.40	21.31

Band	Band Width	Modulation	RB Configuration		Tune-up (dBm)	Channel/Frequency(MHz)		
			RB Size	RB Offset		20407/824.7	20525/836.5	20643/848.3
			LTE Band 5	1.4MHz	QPSK	1	0	24.50
1	2	24.50				24.39	24.28	24.29
1	5	24.50				24.41	24.25	24.24
3	0	24.50				24.42	24.33	24.33
3	1	24.50				24.41	24.31	24.35
3	2	24.50				24.40	24.27	24.31
6	0	23.50				23.40	23.36	23.34
16QAM	1	0			24.00	23.61	23.49	23.53
	1	2			24.00	23.60	23.56	23.49
	1	5			24.00	23.55	23.59	23.45
	3	0			23.50	23.42	23.41	23.38
	3	1			23.50	23.43	23.34	23.32
	3	2			23.50	23.42	23.33	23.36
	6	0			22.50	22.40	22.37	22.42
Band	Band Width	Modulation	RB Configuration		Tune-up (dBm)	Channel/Frequency(MHz)		

5			1	49	24.50	24.28	24.33	24.31	
			25	0	23.50	23.35	23.31	23.44	
			25	12	23.50	23.31	23.33	23.38	
			25	24	23.50	23.29	23.33	23.34	
			50	0	23.50	23.39	23.31	23.40	
	16QAM			1	0	24.00	23.54	23.51	23.55
				1	24	24.00	23.55	23.54	23.60
				1	49	24.00	23.47	23.54	23.58
				25	0	22.50	22.42	22.33	22.49
				25	12	22.50	22.32	22.38	22.40
				25	24	22.50	22.33	22.31	22.31
				50	0	22.50	22.38	22.34	22.40

Band	Band Width	Modulation	RB Configuration		Tune-up (dBm)	Channel/Frequency(MHz)		
			RB Size	RB Offset		20775/2502.5	21100/2535	21425/2567.5
LTE Band 7	5MHz	QPSK	1	0	23.50	23.02	23.35	23.01
			1	12	23.50	23.02	23.32	23.04
			1	24	23.50	23.02	23.31	23.05
			12	0	22.50	22.03	22.43	22.10
			12	6	22.50	22.02	22.32	22.08
			12	11	22.50	21.95	22.32	22.09
			25	0	22.50	22.01	22.33	22.07
		16QAM	1	0	23.00	22.09	22.65	22.21
			1	12	23.00	22.10	22.51	22.26
			1	24	23.00	22.15	22.47	22.30
			12	0	21.50	21.01	21.38	21.08
			12	6	21.50	21.02	21.35	21.03
			12	11	21.50	21.00	21.28	21.07
Band	Band Width	Modulation	RB Configuration		Tune-up (dBm)	Channel/Frequency(MHz)		
			RB Size	RB Offset		20800/2505	21100/2535	21400/2565
LTE Band 7	10MHz	QPSK	1	0	23.50	22.90	23.36	23.18
			1	24	23.50	22.94	23.32	23.02
			1	49	23.50	22.92	23.28	23.01
			25	0	22.50	22.00	22.46	22.13
			25	12	22.50	21.98	22.36	22.08

			25	24	22.50	21.98	22.30	22.00
			50	0	22.50	22.00	22.42	22.10
		16QAM	1	0	23.00	22.10	22.52	22.41
			1	24	23.00	22.23	22.60	22.23
			1	49	23.00	22.24	22.46	22.21
			25	0	21.50	21.07	21.45	21.12
			25	12	21.50	21.02	21.40	21.08
			25	24	21.50	21.01	21.35	21.08
			50	0	21.50	21.04	21.38	21.08
Band	Band Width	Modulation	RB Configuration		Tune-up (dBm)	Channel/Frequency(MHz)		
			RB Size	RB Offset		20825/2507.5	21100/2535	21375/2562.5
LTE Band 7	15MHz	QPSK	1	0	23.50	22.85	23.35	23.28
			1	37	23.50	22.93	23.32	23.03
			1	74	23.50	22.93	23.22	22.94
			36	0	22.50	21.96	22.44	22.21
			36	18	22.50	22.01	22.41	22.05
			36	37	22.50	22.05	22.24	22.00
			75	0	22.50	22.07	22.37	22.13
		16QAM	1	0	23.00	22.10	22.64	22.51
			1	37	23.00	22.23	22.54	22.27
			1	74	23.00	22.08	22.41	22.12
			36	0	21.50	21.03	21.43	21.16
			36	18	21.50	20.99	21.36	21.11
			36	37	21.50	21.04	21.29	21.01
			75	0	21.50	21.00	21.39	21.12
Band	Band Width	Modulation	RB Configuration		Tune-up (dBm)	Channel/Frequency(MHz)		
			RB Size	RB Offset		20850/2510	21100/2535	21350/2560
LTE Band 7	20MHz	QPSK	1	0	23.50	22.82	23.29	23.36
			1	49	23.50	22.94	23.34	23.18
			1	99	23.50	22.98	23.24	22.91
			50	0	22.50	21.98	22.48	22.31
			50	24	22.50	22.01	22.38	22.24
			50	49	22.50	22.17	22.22	22.02
			100	0	22.50	22.06	22.36	22.16
		16QAM	1	0	23.00	22.04	22.46	22.63
			1	49	23.00	22.21	22.55	22.37

			1	99	23.00	22.11	22.46	22.11
			50	0	21.50	20.99	21.46	21.21
			50	24	21.50	20.98	21.41	21.20
			50	49	21.50	21.08	21.23	21.04
			100	0	21.50	21.04	21.30	21.17

Band	Band Width	Modulation	RB Configuration		Tune-up (dBm)	Channel/Frequency(MHz)		
			RB Size	RB Offset		23017/699.7	23095/707.5	23173/715.3
LTE Band 12	1.4MHz	QPSK	1	0	24.50	24.23	24.16	23.92
			1	2	24.50	24.32	24.17	23.87
			1	5	24.50	24.23	24.09	23.83
			3	0	24.50	24.22	24.17	23.99
			3	1	24.50	24.28	24.16	23.97
			3	2	24.50	24.24	24.13	23.92
		16QAM	6	0	23.50	23.24	23.14	22.91
			1	0	24.00	23.41	23.42	23.17
			1	2	24.00	23.56	23.42	23.19
			1	5	24.00	23.34	23.39	23.12
			3	0	23.50	23.21	23.19	23.01
			3	1	23.50	23.25	23.13	22.97
			3	2	23.50	23.26	23.17	22.96
			6	0	22.50	22.23	22.23	21.97

Band	Band Width	Modulation	RB Configuration		Tune-up (dBm)	Channel/Frequency(MHz)		
			RB Size	RB Offset		23025/700.5	23095/707.5	23165/714.5
LTE Band 12	3MHz	QPSK	1	0	24.50	24.13	24.22	24.00
			1	7	24.50	24.17	24.11	23.97
			1	14	24.50	24.26	24.02	23.84
			8	0	23.50	23.19	23.22	23.02
			8	4	23.50	23.20	23.15	22.99
			8	7	23.50	23.17	23.11	22.90
			15	0	23.50	23.19	23.19	22.98
			16QAM	1	0	24.00	23.38	23.53
		1		7	24.00	23.35	23.33	23.13
		1		14	24.00	23.39	23.31	23.03
		8		0	22.50	22.29	22.32	22.07
		8		4	22.50	22.28	22.19	22.05

Band	Band Width	Modulation	RB Configuration		Tune-up (dBm)	Channel/Frequency(MHz)		
			RB Size	RB Offset		23035/701.5	23095/707.5	23155/713.5
			8	7	22.50	22.25	22.18	22.01
			15	0	22.50	22.24	22.22	22.00
LTE Band 12	5MHz	QPSK	1	0	24.50	24.20	24.27	24.07
			1	12	24.50	24.27	24.12	23.98
			1	24	24.50	24.27	24.12	23.87
			12	0	23.50	23.28	23.25	23.11
			12	6	23.50	23.29	23.20	23.03
			12	11	23.50	23.26	23.13	22.96
			25	0	23.50	23.24	23.18	23.01
		16QAM	1	0	24.00	23.40	23.48	23.24
			1	12	24.00	23.51	23.27	23.15
			1	24	24.00	23.55	23.28	23.11
			12	0	22.50	22.28	22.22	22.06
			12	6	22.50	22.26	22.18	22.03
			12	11	22.50	22.26	22.08	21.95
			25	0	22.50	22.28	22.18	22.00
Band	Band Width	Modulation	RB Configuration		Tune-up (dBm)	Channel/Frequency(MHz)		
			RB Size	RB Offset		23060/704	23095/707.5	23130/711
LTE Band 12	10MHz	QPSK	1	0	24.50	24.25	24.30	24.22
			1	24	24.50	24.29	24.22	24.10
			1	49	24.50	24.05	24.05	23.92
			25	0	23.50	23.36	23.24	23.12
			25	12	23.50	23.31	23.18	23.08
			25	24	23.50	23.30	23.14	22.96
			50	0	23.50	23.31	23.19	23.12
		16QAM	1	0	24.00	23.44	23.47	23.49
			1	24	24.00	23.54	23.35	23.29
			1	49	24.00	23.20	23.17	23.10
			25	0	22.50	22.34	22.24	22.16
			25	12	22.50	22.32	22.21	22.12
			25	24	22.50	22.33	22.19	22.01
			50	0	22.50	22.31	22.17	22.11

Band	Band	Modulation	RB	Tune-up	Channel/Frequency(MHz)
------	------	------------	----	---------	------------------------

LTE Band 41	5MHz	QPSK	1	0	28.00	27.87	27.43	26.37
			1	12	28.00	27.65	27.27	26.23
			1	24	28.00	27.54	27.19	26.11
			12	0	27.50	27.02	26.59	25.53
			12	6	27.50	27.00	26.57	25.54
			12	11	27.50	26.97	26.55	25.52
			25	0	27.00	26.98	26.57	25.42
		16QAM	1	0	27.50	27.02	26.64	25.60
			1	12	27.50	26.99	26.62	25.57
			1	24	27.50	26.99	26.63	25.54
			12	0	26.50	26.02	25.64	24.57
			12	6	26.50	26.03	25.61	24.59
			12	11	26.50	25.98	25.60	24.53
			25	0	26.50	26.08	25.66	24.58
Band	Band Width	Modulation	RB Configuration		Tune-up (dBm)	Channel/Frequency(MHz)		
			RB Size	RB Offset		40090/2540	40640/259 5	41190/2650
LTE Band 41	10MHz	QPSK	1	0	28.00	27.55	27.42	26.53
			1	24	28.00	27.46	27.31	26.36
			1	49	28.00	27.23	27.20	26.11
			25	0	27.00	26.97	26.57	25.63
			25	12	27.00	26.98	26.58	25.59
			25	24	27.00	26.93	26.56	25.47
			50	0	27.00	26.95	26.62	25.62
		16QAM	1	0	27.50	27.03	26.66	25.78
			1	24	27.50	27.03	26.67	25.64
			1	49	27.50	27.04	26.70	25.55
			25	0	26.50	26.08	25.68	24.75
			25	12	26.50	26.07	25.67	24.66
			25	24	26.50	26.01	25.65	24.60
			50	0	26.50	26.04	25.70	24.69
Band	Band Width	Modulation	RB Configuration		Tune-up (dBm)	Channel/Frequency(MHz)		
			RB Size	RB Offset		40115/2542.5	40640/259 5	41165/2647.5
LTE Band 41	15MHz	QPSK	1	0	28.00	27.60	27.33	26.34
			1	37	28.00	27.32	27.18	26.29
			1	74	28.00	27.11	27.09	26.84
			36	0	27.00	26.96	26.59	25.62

Band	Band Width	Modulation	RB Configuration		Tune-up (dBm)	Channel/Frequency(MHz)		
			RB Size	RB Offset		40140/2545	40640/2595	41140/2645
			36	18	27.00	26.97	26.57	25.54
			36	37	27.00	26.96	26.57	25.44
			75	0	27.00	26.96	26.61	25.51
		16QAM	1	0	27.50	26.97	26.54	25.61
			1	37	27.50	27.05	26.63	25.60
			1	74	27.50	26.76	26.63	25.67
			36	0	26.00	25.98	25.61	24.63
			36	18	26.00	25.99	25.59	24.59
			36	37	26.00	25.97	25.60	24.46
			75	0	26.00	26.00	25.66	24.55

Band	Band Width	Modulation	RB Configuration		Tune-up (dBm)	Channel/Frequency(MHz)		
			RB Size	RB Offset		131979/1710.7	132322/1745	132665/1779.3
LTE Band 66	1.4MHz	QPSK	1	0	24.00	23.71	23.22	23.52
			1	2	24.00	23.67	23.25	23.53
			1	5	24.00	23.65	23.20	23.56
			3	0	24.00	23.70	23.26	23.58
			3	1	24.00	23.68	23.22	23.61
			3	2	24.00	23.67	23.23	23.59
			6	0	23.00	22.69	22.27	22.57

Band	Band Width	Modulation	RB Configuration		Tune-up (dBm)	Channel/Frequency(MHz)		
			RB Size	RB Offset		131987/1711.5	132322/1745	132657/1778.5
		16QAM	1	0	23.00	22.92	22.52	22.82
			1	2	23.00	22.97	22.47	22.73
			1	5	23.00	22.91	22.49	22.78
			3	0	23.00	22.65	22.24	22.62
			3	1	23.00	22.65	22.22	22.54
			3	2	23.00	22.65	22.22	22.64
			6	0	22.00	21.70	21.33	21.65
LTE Band 66	3MHz	QPSK	1	0	24.00	23.61	23.22	23.49
			1	7	24.00	23.57	23.19	23.52
			1	14	24.00	23.58	23.19	23.54
			8	0	23.00	22.63	22.24	22.56
			8	4	23.00	22.59	22.20	22.55
			8	7	23.00	22.60	22.20	22.54
			15	0	23.00	22.61	22.20	22.57
		16QAM	1	0	23.00	22.94	22.46	22.65
			1	7	23.00	22.84	22.50	22.73
			1	14	23.00	22.89	22.45	22.80
			8	0	22.00	21.71	21.33	21.63
			8	4	22.00	21.67	21.26	21.65
			8	7	22.00	21.67	21.29	21.59
			15	0	22.00	21.64	21.23	21.62
	Band Width	Modulation	RB Configuration		Tune-up (dBm)	Channel/Frequency(MHz)		
			RB Size	RB Offset		131997/1712.5	132322/1745	132647/1777.5
LTE Band 66	5MHz	QPSK	1	0	24.00	23.69	23.28	23.50
			1	12	24.00	23.59	23.23	23.52
			1	24	24.00	23.55	23.24	23.58
			12	0	23.00	22.69	22.29	22.55
			12	6	23.00	22.62	22.26	22.60
			12	11	23.00	22.58	22.24	22.56
			25	0	23.00	22.64	22.26	22.51
		16QAM	1	0	23.00	22.98	22.57	22.68
			1	12	23.00	22.79	22.49	22.81
			1	24	23.00	22.85	22.41	22.86
12	0		22.00	21.61	21.24	21.51		

			12	6	22.00	21.60	21.22	21.53
			12	11	22.00	21.62	21.18	21.50
			25	0	22.00	21.65	21.25	21.53
Band	Band Width	Modulation	RB Configuration		Tune-up (dBm)	Channel/Frequency(MHz)		
			RB Size	RB Offset		132022/1715	132322/1745	132622/1775
LTE Band 66	10MHz	QPSK	1	0	24.00	23.66	23.31	23.37
			1	24	24.00	23.50	23.28	23.51
			1	49	24.00	23.37	23.14	23.57
			25	0	23.00	22.54	22.25	22.37
			25	12	23.00	22.50	22.23	22.50
			25	24	23.00	22.50	22.34	22.57
		16QAM	1	0	23.00	22.85	22.65	22.67
			1	24	23.00	22.69	22.61	22.70
			1	49	23.00	22.68	22.49	22.77
			25	0	22.00	21.54	21.27	21.40
			25	12	22.00	21.55	21.23	21.57
			25	24	22.00	21.54	21.28	21.61
			50	0	22.00	21.59	21.31	21.49
Band	Band Width	Modulation	RB Configuration		Tune-up (dBm)	Channel/Frequency(MHz)		
			RB Size	RB Offset		132047/1717.5	132322/1745	132597/1772.5
LTE Band 66	15MHz	QPSK	1	0	24.00	23.57	23.22	23.14
			1	37	24.00	23.41	23.26	23.38
			1	74	24.00	23.23	23.12	23.44
			36	0	22.50	22.47	22.25	22.26
			36	18	22.50	22.43	22.25	22.39
			36	37	22.50	22.40	22.23	22.48
			75	0	22.50	22.43	22.27	22.41
		16QAM	1	0	23.00	22.90	22.53	22.39
			1	37	23.00	22.62	22.60	22.74
			1	74	23.00	22.58	22.35	22.62
			36	0	21.50	21.45	21.23	21.23
			36	18	21.50	21.40	21.29	21.32
			36	37	21.50	21.34	21.29	21.44
			75	0	21.50	21.44	21.23	21.34
Band	Band	Modulation	RB		Tune-u	Channel/Frequency(MHz)		

	Width		Configuration		p (dBm)			
			RB Size	RB Offset		132072/1720	132322/1745	132572/1770
LTE Band 66	20MHz	QPSK	1	0	23.50	23.49	23.18	23.10
			1	49	23.50	23.34	23.29	23.31
			1	99	23.50	23.24	23.10	23.41
			50	0	23.00	22.40	22.27	22.37
			50	24	23.00	22.45	22.35	22.38
			50	49	23.00	22.34	22.32	22.56
			100	0	22.50	22.34	22.34	22.45
		16QAM	1	0	23.00	22.70	22.48	22.32
			1	49	23.00	22.60	22.41	22.65
			1	99	23.00	22.45	22.46	22.67
			50	0	22.00	21.40	21.27	21.37
			50	24	22.00	21.36	21.29	21.39
			50	49	22.00	21.32	21.30	21.51
			100	0	21.50	21.34	21.27	21.41

Band	Band Width	Modulation	RB Configuration		Tune-up (dBm)	Channel/Frequency(MHz)		
			RB Size	RB Offset		133147/665.5	133297/680.5	133447/695.5
LTE Band 71	5MHz	QPSK	1	0	24.50	24.16	24.26	24.03
			1	12	24.50	24.20	24.17	24.02
			1	24	24.50	24.28	24.15	24.09
			12	0	23.50	23.11	23.27	23.16
			12	6	23.50	23.17	23.23	23.09
			12	11	23.50	23.16	23.23	23.07
			25	0	23.50	23.14	23.25	23.12
		16QAM	1	0	24.00	23.38	23.50	23.30
			1	12	24.00	23.29	23.44	23.29
			1	24	24.00	23.49	23.37	23.33
			12	0	22.50	22.10	22.23	22.11
			12	6	22.50	22.14	22.19	22.04
			12	11	22.50	22.12	22.20	22.01
			25	0	22.50	22.17	22.25	22.13
Band	Band Width	Modulation	RB Configuration		Tune-up (dBm)	Channel/Frequency(MHz)		
RB Size	RB Offset	133172/668	133297/680.5	133422/693				

LTE Band 71	10MHz	QPSK	1	0	24.50	24.08	24.30	24.01
			1	24	24.50	24.18	24.24	24.03
			1	49	24.50	24.25	24.06	24.06
			25	0	23.50	23.16	23.31	23.10
			25	12	23.50	23.19	23.26	23.08
			25	24	23.50	23.34	23.26	23.02
			50	0	23.50	23.25	23.30	23.08
		16QAM	1	0	24.00	23.24	23.55	23.23
			1	24	24.00	23.43	23.41	23.21
			1	49	24.00	23.42	23.28	23.21
			25	0	22.50	22.22	22.32	22.13
			25	12	22.50	22.21	22.22	22.10
			25	24	22.50	22.35	22.30	21.99
			50	0	22.50	22.25	22.29	22.06
Band	Band Width	Modulation	RB Configuration		Tune-up (dBm)	Channel/Frequency(MHz)		
			RB Size	RB Offset		133197/670.5	133297/680.5	133397/690.5
LTE Band 71	15MHz	QPSK	1	0	24.50	24.10	24.25	24.10
			1	37	24.50	24.24	24.15	24.04
			1	74	24.50	24.18	23.92	23.94
			36	0	23.50	23.19	23.25	23.04
			36	18	23.50	23.24	23.19	23.04
			36	37	23.50	23.22	23.16	22.90
			75	0	23.50	23.26	23.24	23.05
		16QAM	1	0	24.00	23.27	23.58	23.37
			1	37	24.00	23.51	23.37	23.21
			1	74	24.00	23.45	23.25	23.16
			36	0	22.50	22.18	22.26	22.08
			36	18	22.50	22.22	22.19	22.00
			36	37	22.50	22.23	22.22	21.96
			75	0	22.50	22.23	22.22	22.01
Band	Band Width	Modulation	RB Configuration		Tune-up (dBm)	Channel/Frequency(MHz)		
			RB Size	RB Offset		133222/673	133322/683	133372/688
LTE Band 71	20MHz	QPSK	1	0	24.50	24.08	24.22	24.20
			1	49	24.50	24.27	24.20	23.95
			1	99	24.50	24.02	23.87	23.90
			50	0	23.50	23.15	23.32	23.02

16QAM	50	24	23.50	23.24	23.28	23.04
	50	49	23.50	23.23	23.24	22.91
	100	0	23.50	23.18	23.26	22.94
	1	0	24.00	23.31	23.45	23.47
	1	49	24.00	23.52	23.45	23.13
	1	99	24.00	23.28	23.17	23.07
	50	0	22.50	22.11	22.34	22.01
	50	24	22.50	22.20	22.22	22.06
	50	49	22.50	22.16	22.18	21.90
	100	0	22.50	22.11	22.21	21.90

7.4. NR SA Power

Band	SCS (kHz)	Bandwidth (MHz)	UL Channel	RB Allocation	Modulation	Tune-up	Power (dBm)
n41	30	10	500202	1@1	DFT_BPSK	21.00	20.59
n41	30	10	500202	24@0	DFT_QPSK	20.00	19.67
n41	30	10	500202	12@6	DFT_QPSK	21.00	20.60
n41	30	10	500202	1@1	DFT_QPSK	21.00	20.63
n41	30	10	500202	1@22	DFT_QPSK	21.00	20.32
n41	30	10	500202	1@1	DFT_QAM16	20.00	19.84
n41	30	10	500202	1@1	DFT_QAM64	19.00	18.32
n41	30	10	500202	1@1	DFT_QAM256	17.00	16.89
n41	30	10	500202	1@1	CP_QPSK	20.00	19.27
n41	30	10	518598	1@1	DFT_BPSK	22.00	21.55
n41	30	10	518598	24@0	DFT_QPSK	21.00	20.96
n41	30	10	518598	12@6	DFT_QPSK	22.00	21.90
n41	30	10	518598	1@1	DFT_QPSK	22.00	21.54
n41	30	10	518598	1@22	DFT_QPSK	22.00	21.90
n41	30	10	518598	1@1	DFT_QAM16	21.00	20.82
n41	30	10	518598	1@1	DFT_QAM64	20.00	19.28
n41	30	10	518598	1@1	DFT_QAM256	18.00	17.86
n41	30	10	518598	1@1	CP_QPSK	21.00	20.27
n41	30	10	537000	1@1	DFT_BPSK	21.00	20.66
n41	30	10	537000	24@0	DFT_QPSK	20.00	19.79
n41	30	10	537000	12@6	DFT_QPSK	21.00	20.70
n41	30	10	537000	1@1	DFT_QPSK	21.00	20.73
n41	30	10	537000	1@22	DFT_QPSK	21.00	20.46
n41	30	10	537000	1@1	DFT_QAM16	20.00	19.93

n41	30	10	537000	1@1	DFT_QAM64	19.00	18.44
n41	30	10	537000	1@1	DFT_QAM256	18.00	17.03
n41	30	10	537000	1@1	CP_QPSK	20.00	19.46
n41	30	15	500700	1@1	DFT_BPSK	22.00	21.46
n41	30	15	500700	36@0	DFT_QPSK	21.00	20.74
n41	30	15	500700	18@9	DFT_QPSK	22.00	21.68
n41	30	15	500700	1@1	DFT_QPSK	22.00	21.44
n41	30	15	500700	1@36	DFT_QPSK	22.00	21.51
n41	30	15	500700	1@1	DFT_QAM16	21.00	20.66
n41	30	15	500700	1@1	DFT_QAM64	20.00	19.10
n41	30	15	500700	1@1	DFT_QAM256	18.00	17.71
n41	30	15	500700	1@1	CP_QPSK	21.00	20.07
n41	30	15	518598	1@1	DFT_BPSK	22.00	21.46
n41	30	15	518598	36@0	DFT_QPSK	21.00	20.90
n41	30	15	518598	18@9	DFT_QPSK	22.00	21.83
n41	30	15	518598	1@1	DFT_QPSK	22.00	21.42
n41	30	15	518598	1@36	DFT_QPSK	22.00	21.91
n41	30	15	518598	1@1	DFT_QAM16	21.00	20.65
n41	30	15	518598	1@1	DFT_QAM64	20.00	19.14
n41	30	15	518598	1@1	DFT_QAM256	18.00	17.71
n41	30	15	518598	1@1	CP_QPSK	21.00	20.09
n41	30	15	536496	1@1	DFT_BPSK	21.00	20.92
n41	30	15	536496	36@0	DFT_QPSK	20.00	19.89
n41	30	15	536496	18@9	DFT_QPSK	21.00	20.80
n41	30	15	536496	1@1	DFT_QPSK	21.00	20.92
n41	30	15	536496	1@36	DFT_QPSK	21.00	20.37
n41	30	15	536496	1@1	DFT_QAM16	21.00	20.12
n41	30	15	536496	1@1	DFT_QAM64	21.00	20.20
n41	30	15	536496	1@1	DFT_QAM256	18.00	17.23
n41	30	15	536496	1@1	CP_QPSK	20.00	19.66
n41	30	20	501204	1@1	DFT_BPSK	22.00	21.43
n41	30	20	501204	50@0	DFT_QPSK	21.00	20.74
n41	30	20	501204	25@12	DFT_QPSK	22.00	21.77
n41	30	20	501204	1@1	DFT_QPSK	22.00	21.45
n41	30	20	501204	1@49	DFT_QPSK	22.00	21.52
n41	30	20	501204	1@1	DFT_QAM16	21.00	20.61
n41	30	20	501204	1@1	DFT_QAM64	20.00	19.07
n41	30	20	501204	1@1	DFT_QAM256	18.00	17.66
n41	30	20	501204	1@1	CP_QPSK	21.00	20.05

n41	30	20	518598	1@1	DFT_BPSK	22.00	21.39
n41	30	20	518598	50@0	DFT_QPSK	21.00	20.91
n41	30	20	518598	25@12	DFT_QPSK	22.00	21.91
n41	30	20	518598	1@1	DFT_QPSK	22.00	21.30
n41	30	20	518598	1@49	DFT_QPSK	22.00	21.85
n41	30	20	518598	1@1	DFT_QAM16	21.00	20.51
n41	30	20	518598	1@1	DFT_QAM64	20.00	19.04
n41	30	20	518598	1@1	DFT_QAM256	18.00	17.71
n41	30	20	518598	1@1	CP_QPSK	21.00	20.01
n41	30	20	535998	1@1	DFT_BPSK	22.00	21.06
n41	30	20	535998	50@0	DFT_QPSK	21.00	20.07
n41	30	20	535998	25@12	DFT_QPSK	22.00	21.04
n41	30	20	535998	1@1	DFT_QPSK	21.00	20.98
n41	30	20	535998	1@49	DFT_QPSK	21.00	20.39
n41	30	20	535998	1@1	DFT_QAM16	21.00	20.29
n41	30	20	535998	1@1	DFT_QAM64	19.00	18.72
n41	30	20	535998	1@1	DFT_QAM256	18.00	17.37
n41	30	20	535998	1@1	CP_QPSK	20.00	19.80
n41	30	40	503202	1@1	DFT_BPSK	22.00	21.10
n41	30	40	503202	100@0	DFT_QPSK	21.00	20.81
n41	30	40	503202	50@25	DFT_QPSK	22.00	21.82
n41	30	40	503202	1@1	DFT_QPSK	22.00	21.12
n41	30	40	503202	1@104	DFT_QPSK	22.00	21.51
n41	30	40	503202	1@1	DFT_QAM16	21.00	20.25
n41	30	40	503202	1@1	DFT_QAM64	19.00	18.80
n41	30	40	503202	1@1	DFT_QAM256	18.00	17.42
n41	30	40	503202	1@1	CP_QPSK	20.00	19.78
n41	30	40	518598	1@1	DFT_BPSK	22.00	21.38
n41	30	40	518598	100@0	DFT_QPSK	21.00	20.75
n41	30	40	518598	50@25	DFT_QPSK	22.00	21.77
n41	30	40	518598	1@1	DFT_QPSK	22.00	21.30
n41	30	40	518598	1@104	DFT_QPSK	22.00	21.18
n41	30	40	518598	1@1	DFT_QAM16	21.00	20.47
n41	30	40	518598	1@1	DFT_QAM64	20.00	19.07
n41	30	40	518598	1@1	DFT_QAM256	18.00	17.64
n41	30	40	518598	1@1	CP_QPSK	20.00	19.97
n41	30	40	534000	1@1	DFT_BPSK	21.00	20.30
n41	30	40	534000	100@0	DFT_QPSK	21.00	20.03
n41	30	40	534000	50@25	DFT_QPSK	22.00	21.23

n41	30	40	534000	1@1	DFT_QPSK	21.00	20.22
n41	30	40	534000	1@104	DFT_QPSK	21.00	20.17
n41	30	40	534000	1@1	DFT_QAM16	20.00	19.35
n41	30	40	534000	1@1	DFT_QAM64	18.00	17.95
n41	30	40	534000	1@1	DFT_QAM256	17.00	16.55
n41	30	40	534000	1@1	CP_QPSK	19.00	18.82
n41	30	50	504204	1@1	DFT_BPSK	22.00	21.30
n41	30	50	504204	128@0	DFT_QPSK	21.00	20.85
n41	30	50	504204	64@32	DFT_QPSK	22.00	21.93
n41	30	50	504204	1@1	DFT_QPSK	22.00	21.34
n41	30	50	504204	1@131	DFT_QPSK	22.00	21.55
n41	30	50	504204	1@1	DFT_QAM16	21.00	20.46
n41	30	50	504204	1@1	DFT_QAM64	20.00	19.07
n41	30	50	504204	1@1	DFT_QAM256	18.00	17.63
n41	30	50	504204	1@1	CP_QPSK	20.00	19.87
n41	30	50	518598	1@1	DFT_BPSK	22.00	21.77
n41	30	50	518598	128@0	DFT_QPSK	21.00	20.79
n41	30	50	518598	64@32	DFT_QPSK	22.00	21.86
n41	30	50	518598	1@1	DFT_QPSK	22.00	21.78
n41	30	50	518598	1@131	DFT_QPSK	22.00	21.25
n41	30	50	518598	1@1	DFT_QAM16	21.00	20.88
n41	30	50	518598	1@1	DFT_QAM64	20.00	19.53
n41	30	50	518598	1@1	DFT_QAM256	19.00	18.07
n41	30	50	518598	1@1	CP_QPSK	21.00	20.39
n41	30	50	532998	1@1	DFT_BPSK	22.00	21.10
n41	30	50	532998	128@0	DFT_QPSK	21.00	20.04
n41	30	50	532998	64@32	DFT_QPSK	22.00	21.15
n41	30	50	532998	1@1	DFT_QPSK	22.00	21.03
n41	30	50	532998	1@131	DFT_QPSK	21.00	20.43
n41	30	50	532998	1@1	DFT_QAM16	21.00	20.23
n41	30	50	532998	1@1	DFT_QAM64	19.00	18.82
n41	30	50	532998	1@1	DFT_QAM256	18.00	17.39
n41	30	50	532998	1@1	CP_QPSK	20.00	19.76
n41	30	60	505200	1@1	DFT_BPSK	22.00	21.09
n41	30	60	505200	162@0	DFT_QPSK	21.00	20.95
n41	30	60	505200	81@40	DFT_QPSK	22.00	21.99
n41	30	60	505200	1@1	DFT_QPSK	22.00	21.14
n41	30	60	505200	1@160	DFT_QPSK	22.00	21.45
n41	30	60	505200	1@1	DFT_QAM16	21.00	20.25

n41	30	60	505200	1@1	DFT_QAM64	19.00	18.88
n41	30	60	505200	1@1	DFT_QAM256	18.00	17.47
n41	30	60	505200	1@1	CP_QPSK	20.00	19.78
n41	30	60	518598	1@1	DFT_BPSK	22.00	21.58
n41	30	60	518598	162@0	DFT_QPSK	21.00	20.67
n41	30	60	518598	81@40	DFT_QPSK	22.00	21.83
n41	30	60	518598	1@1	DFT_QPSK	22.00	21.61
n41	30	60	518598	1@160	DFT_QPSK	22.00	21.10
n41	30	60	518598	1@1	DFT_QAM16	21.00	20.71
n41	30	60	518598	1@1	DFT_QAM64	20.00	19.34
n41	30	60	518598	1@1	DFT_QAM256	18.00	17.93
n41	30	60	518598	1@1	CP_QPSK	21.00	20.23
n41	30	60	531996	1@1	DFT_BPSK	22.00	21.05
n41	30	60	531996	162@0	DFT_QPSK	21.00	20.25
n41	30	60	531996	81@40	DFT_QPSK	22.00	21.14
n41	30	60	531996	1@1	DFT_QPSK	22.00	21.01
n41	30	60	531996	1@160	DFT_QPSK	21.00	20.39
n41	30	60	531996	1@1	DFT_QAM16	21.00	20.14
n41	30	60	531996	1@1	DFT_QAM64	19.00	18.79
n41	30	60	531996	1@1	DFT_QAM256	19.00	17.36
n41	30	60	531996	1@1	CP_QPSK	20.00	19.70
n41	30	80	507204	1@1	DFT_BPSK	21.00	20.91
n41	30	80	507204	216@0	DFT_QPSK	21.00	20.85
n41	30	80	507204	108@54	DFT_QPSK	22.00	21.98
n41	30	80	507204	1@1	DFT_QPSK	21.00	20.99
n41	30	80	507204	1@215	DFT_QPSK	22.00	21.46
n41	30	80	507204	1@1	DFT_QAM16	21.00	20.01
n41	30	80	507204	1@1	DFT_QAM64	19.00	18.67
n41	30	80	507204	1@1	DFT_QAM256	18.00	17.29
n41	30	80	507204	1@1	CP_QPSK	20.00	19.63
n41	30	80	518598	1@1	DFT_BPSK	21.00	20.99
n41	30	80	518598	216@0	DFT_QPSK	21.00	20.71
n41	30	80	518598	108@54	DFT_QPSK	22.00	21.85
n41	30	80	518598	1@1	DFT_QPSK	21.00	20.97
n41	30	80	518598	1@215	DFT_QPSK	22.00	21.37
n41	30	80	518598	1@1	DFT_QAM16	21.00	20.09
n41	30	80	518598	1@1	DFT_QAM64	19.00	18.71
n41	30	80	518598	1@1	DFT_QAM256	18.00	17.29
n41	30	80	518598	1@1	CP_QPSK	20.00	19.64

n41	30	80	529998	1@1	DFT_BPSK	21.00	20.67
n41	30	80	529998	216@0	DFT_QPSK	21.00	20.34
n41	30	80	529998	108@54	DFT_QPSK	22.00	21.41
n41	30	80	529998	1@1	DFT_QPSK	21.00	20.63
n41	30	80	529998	1@215	DFT_QPSK	21.00	20.37
n41	30	80	529998	1@1	DFT_QAM16	20.00	19.80
n41	30	80	529998	1@1	DFT_QAM64	19.00	18.42
n41	30	80	529998	1@1	DFT_QAM256	18.00	17.00
n41	30	80	529998	1@1	CP_QPSK	20.00	19.37
n41	30	90	508200	1@1	DFT_BPSK	21.00	20.77
n41	30	90	508200	240@0	DFT_QPSK	21.00	20.79
n41	30	90	508200	120@60	DFT_QPSK	22.00	21.87
n41	30	90	508200	1@1	DFT_QPSK	21.00	20.82
n41	30	90	508200	1@243	DFT_QPSK	21.00	20.97
n41	30	90	508200	1@1	DFT_QAM16	20.00	19.84
n41	30	90	508200	1@1	DFT_QAM64	19.00	18.51
n41	30	90	508200	1@1	DFT_QAM256	18.00	17.18
n41	30	90	508200	1@1	CP_QPSK	20.00	19.43
n41	30	90	518598	1@1	DFT_BPSK	21.00	20.69
n41	30	90	518598	240@0	DFT_QPSK	21.00	20.65
n41	30	90	518598	120@60	DFT_QPSK	22.00	21.77
n41	30	90	518598	1@1	DFT_QPSK	21.00	20.77
n41	30	90	518598	1@243	DFT_QPSK	22.00	21.31
n41	30	90	518598	1@1	DFT_QAM16	20.00	19.67
n41	30	90	518598	1@1	DFT_QAM64	19.00	18.46
n41	30	90	518598	1@1	DFT_QAM256	18.00	17.03
n41	30	90	518598	1@1	CP_QPSK	20.00	19.34
n41	30	90	528996	1@1	DFT_BPSK	21.00	20.92
n41	30	90	528996	240@0	DFT_QPSK	21.00	20.34
n41	30	90	528996	120@60	DFT_QPSK	22.00	21.33
n41	30	90	528996	1@1	DFT_QPSK	21.00	20.93
n41	30	90	528996	1@243	DFT_QPSK	21.00	20.23
n41	30	90	528996	1@1	DFT_QAM16	20.00	19.89
n41	30	90	528996	1@1	DFT_QAM64	19.00	18.72
n41	30	90	528996	1@1	DFT_QAM256	18.00	17.25
n41	30	90	528996	1@1	CP_QPSK	20.00	19.64
n41	30	100	509202	1@1	DFT_BPSK	21.00	20.59
n41	30	100	509202	270@0	DFT_QPSK	21.00	20.68
n41	30	100	509202	135@67	DFT_QPSK	22.00	21.82

n41	30	100	509202	1@1	DFT_QPSK	21.00	20.68
n41	30	100	509202	1@271	DFT_QPSK	22.00	21.14
n41	30	100	509202	1@1	DFT_QAM16	20.00	19.66
n41	30	100	509202	1@1	DFT_QAM64	19.00	18.36
n41	30	100	509202	1@1	DFT_QAM256	18.00	16.96
n41	30	100	509202	1@1	CP_QPSK	20.00	19.23
n41	30	100	518598	1@1	DFT_BPSK	21.00	20.59
n41	30	100	518598	270@0	DFT_QPSK	21.00	20.49
n41	30	100	518598	135@67	DFT_QPSK	22.00	21.74
n41	30	100	518598	1@1	DFT_QPSK	21.00	20.64
n41	30	100	518598	1@271	DFT_QPSK	22.00	21.03
n41	30	100	518598	1@1	DFT_QAM16	20.00	19.54
n41	30	100	518598	1@1	DFT_QAM64	19.00	18.38
n41	30	100	518598	1@1	DFT_QAM256	18.00	16.98
n41	30	100	518598	1@1	CP_QPSK	20.00	19.03
n41	30	100	528000	1@1	DFT_BPSK	21.00	20.53
n41	30	100	528000	270@0	DFT_QPSK	21.00	20.29
n41	30	100	528000	135@67	DFT_QPSK	22.00	21.28
n41	30	100	528000	1@1	DFT_QPSK	21.00	20.51
n41	30	100	528000	1@271	DFT_QPSK	21.00	20.09
n41	30	100	528000	1@1	DFT_QAM16	20.00	19.69
n41	30	100	528000	1@1	DFT_QAM64	19.00	18.20
n41	30	100	528000	1@1	DFT_QAM256	18.00	16.87
n41	30	100	528000	1@1	CP_QPSK	20.00	19.20
n78	30	10	630334	1@1	DFT_BPSK	24.00	23.83
n78	30	10	630334	24@0	DFT_QPSK	24.00	23.40
n78	30	10	630334	12@6	DFT_QPSK	25.00	24.42
n78	30	10	630334	1@1	DFT_QPSK	24.00	23.81
n78	30	10	630334	1@22	DFT_QPSK	24.00	23.73
n78	30	10	630334	1@1	DFT_QAM16	23.00	22.94
n78	30	10	630334	1@1	DFT_QAM64	22.00	21.25
n78	30	10	630334	1@1	DFT_QAM256	20.00	19.21
n78	30	10	630334	1@1	CP_QPSK	23.00	22.35
n78	30	10	633333	1@1	DFT_BPSK	25.00	24.24
n78	30	10	633333	24@0	DFT_QPSK	24.00	23.87
n78	30	10	633333	12@6	DFT_QPSK	25.00	24.87
n78	30	10	633333	1@1	DFT_QPSK	25.00	24.14
n78	30	10	633333	1@22	DFT_QPSK	25.00	24.20
n78	30	10	633333	1@1	DFT_QAM16	24.00	23.32

n78	30	10	633333	1@1	DFT_QAM64	22.00	21.76
n78	30	10	633333	1@1	DFT_QAM256	20.00	19.60
n78	30	10	633333	1@1	CP_QPSK	23.00	22.78
n78	30	10	636333	1@1	DFT_BPSK	25.00	24.39
n78	30	10	636333	24@0	DFT_QPSK	25.00	24.07
n78	30	10	636333	12@6	DFT_QPSK	26.00	25.08
n78	30	10	636333	1@1	DFT_QPSK	25.00	24.31
n78	30	10	636333	1@22	DFT_QPSK	25.00	24.38
n78	30	10	636333	1@1	DFT_QAM16	24.00	23.64
n78	30	10	636333	1@1	DFT_QAM64	22.00	21.95
n78	30	10	636333	1@1	DFT_QAM256	20.00	19.86
n78	30	10	636333	1@1	CP_QPSK	23.00	22.93
n78	30	15	630500	1@1	DFT_BPSK	24.00	23.81
n78	30	15	630500	36@0	DFT_QPSK	24.00	23.42
n78	30	15	630500	18@9	DFT_QPSK	25.00	24.41
n78	30	15	630500	1@1	DFT_QPSK	24.00	23.78
n78	30	15	630500	1@36	DFT_QPSK	24.00	23.68
n78	30	15	630500	1@1	DFT_QAM16	23.00	22.88
n78	30	15	630500	1@1	DFT_QAM64	22.00	21.24
n78	30	15	630500	1@1	DFT_QAM256	20.00	19.23
n78	30	15	630500	1@1	CP_QPSK	23.00	22.35
n78	30	15	633333	1@1	DFT_BPSK	25.00	24.21
n78	30	15	633333	36@0	DFT_QPSK	24.00	23.93
n78	30	15	633333	18@9	DFT_QPSK	25.00	24.86
n78	30	15	633333	1@1	DFT_QPSK	25.00	24.17
n78	30	15	633333	1@36	DFT_QPSK	25.00	24.27
n78	30	15	633333	1@1	DFT_QAM16	24.00	23.35
n78	30	15	633333	1@1	DFT_QAM64	22.00	21.68
n78	30	15	633333	1@1	DFT_QAM256	20.00	19.68
n78	30	15	633333	1@1	CP_QPSK	23.00	22.78
n78	30	15	636166	1@1	DFT_BPSK	25.00	24.24
n78	30	15	636166	36@0	DFT_QPSK	25.00	24.08
n78	30	15	636166	18@9	DFT_QPSK	26.00	25.05
n78	30	15	636166	1@1	DFT_QPSK	25.00	24.14
n78	30	15	636166	1@36	DFT_QPSK	25.00	24.33
n78	30	15	636166	1@1	DFT_QAM16	24.00	23.42
n78	30	15	636166	1@1	DFT_QAM64	22.00	21.72
n78	30	15	636166	1@1	DFT_QAM256	20.00	19.73
n78	30	15	636166	1@1	CP_QPSK	23.00	22.82

n78	30	20	630667	1@1	DFT_BPSK	24.00	23.78
n78	30	20	630667	50@0	DFT_QPSK	24.00	23.44
n78	30	20	630667	25@12	DFT_QPSK	25.00	24.45
n78	30	20	630667	1@1	DFT_QPSK	24.00	23.76
n78	30	20	630667	1@49	DFT_QPSK	24.00	23.73
n78	30	20	630667	1@1	DFT_QAM16	23.00	22.83
n78	30	20	630667	1@1	DFT_QAM64	22.00	21.30
n78	30	20	630667	1@1	DFT_QAM256	20.00	19.14
n78	30	20	630667	1@1	CP_QPSK	23.00	22.28
n78	30	20	633333	1@1	DFT_BPSK	25.00	24.21
n78	30	20	633333	50@0	DFT_QPSK	24.00	23.91
n78	30	20	633333	25@12	DFT_QPSK	25.00	24.94
n78	30	20	633333	1@1	DFT_QPSK	25.00	24.16
n78	30	20	633333	1@49	DFT_QPSK	25.00	24.25
n78	30	20	633333	1@1	DFT_QAM16	24.00	23.36
n78	30	20	633333	1@1	DFT_QAM64	22.00	21.71
n78	30	20	633333	1@1	DFT_QAM256	20.00	19.68
n78	30	20	633333	1@1	CP_QPSK	23.00	22.76
n78	30	20	636000	1@1	DFT_BPSK	25.00	24.02
n78	30	20	636000	50@0	DFT_QPSK	25.00	24.00
n78	30	20	636000	25@12	DFT_QPSK	26.00	25.04
n78	30	20	636000	1@1	DFT_QPSK	25.00	24.03
n78	30	20	636000	1@49	DFT_QPSK	25.00	24.21
n78	30	20	636000	1@1	DFT_QAM16	24.00	23.30
n78	30	20	636000	1@1	DFT_QAM64	22.00	21.59
n78	30	20	636000	1@1	DFT_QAM256	20.00	19.50
n78	30	20	636000	1@1	CP_QPSK	23.00	22.60
n78	30	40	631334	1@1	DFT_BPSK	24.00	23.47
n78	30	40	631334	100@0	DFT_QPSK	24.00	23.49
n78	30	40	631334	50@25	DFT_QPSK	25.00	24.51
n78	30	40	631334	1@1	DFT_QPSK	24.00	23.38
n78	30	40	631334	1@104	DFT_QPSK	24.00	23.84
n78	30	40	631334	1@1	DFT_QAM16	23.00	22.46
n78	30	40	631334	1@1	DFT_QAM64	21.00	20.83
n78	30	40	631334	1@1	DFT_QAM256	19.00	18.85
n78	30	40	631334	1@1	CP_QPSK	22.00	21.95
n78	30	40	633333	1@1	DFT_BPSK	24.00	23.92
n78	30	40	633333	100@0	DFT_QPSK	24.00	23.77
n78	30	40	633333	50@25	DFT_QPSK	25.00	24.87

n78	30	40	633333	1@1	DFT_QPSK	24.00	23.88
n78	30	40	633333	1@104	DFT_QPSK	24.00	23.80
n78	30	40	633333	1@1	DFT_QAM16	24.00	23.00
n78	30	40	633333	1@1	DFT_QAM64	22.00	21.38
n78	30	40	633333	1@1	DFT_QAM256	20.00	19.41
n78	30	40	633333	1@1	CP_QPSK	23.00	22.49
n78	30	40	635333	1@1	DFT_BPSK	25.00	24.01
n78	30	40	635333	100@0	DFT_QPSK	24.00	23.76
n78	30	40	635333	50@25	DFT_QPSK	25.00	24.75
n78	30	40	635333	1@1	DFT_QPSK	24.00	23.94
n78	30	40	635333	1@104	DFT_QPSK	24.00	23.89
n78	30	40	635333	1@1	DFT_QAM16	24.00	23.13
n78	30	40	635333	1@1	DFT_QAM64	22.00	21.48
n78	30	40	635333	1@1	DFT_QAM256	20.00	19.47
n78	30	40	635333	1@1	CP_QPSK	23.00	22.57
n78	30	50	631667	1@1	DFT_BPSK	24.00	23.70
n78	30	50	631667	128@0	DFT_QPSK	24.00	23.59
n78	30	50	631667	64@32	DFT_QPSK	25.00	24.68
n78	30	50	631667	1@1	DFT_QPSK	24.00	23.63
n78	30	50	631667	1@131	DFT_QPSK	24.00	23.90
n78	30	50	631667	1@1	DFT_QAM16	23.00	22.76
n78	30	50	631667	1@1	DFT_QAM64	22.00	21.12
n78	30	50	631667	1@1	DFT_QAM256	20.00	19.14
n78	30	50	631667	1@1	CP_QPSK	23.00	22.23
n78	30	50	633333	1@1	DFT_BPSK	25.00	24.05
n78	30	50	633333	128@0	DFT_QPSK	24.00	23.88
n78	30	50	633333	64@32	DFT_QPSK	25.00	24.89
n78	30	50	633333	1@1	DFT_QPSK	25.00	24.01
n78	30	50	633333	1@131	DFT_QPSK	24.00	23.86
n78	30	50	633333	1@1	DFT_QAM16	24.00	23.16
n78	30	50	633333	1@1	DFT_QAM64	22.00	21.54
n78	30	50	633333	1@1	DFT_QAM256	20.00	19.46
n78	30	50	633333	1@1	CP_QPSK	23.00	22.65
n78	30	50	635000	1@1	DFT_BPSK	25.00	24.14
n78	30	50	635000	128@0	DFT_QPSK	24.00	23.85
n78	30	50	635000	64@32	DFT_QPSK	25.00	24.86
n78	30	50	635000	1@1	DFT_QPSK	25.00	24.10
n78	30	50	635000	1@131	DFT_QPSK	25.00	24.16
n78	30	50	635000	1@1	DFT_QAM16	24.00	23.29

n78	30	50	635000	1@1	DFT_QAM64	22.00	21.66
n78	30	50	635000	1@1	DFT_QAM256	20.00	19.66
n78	30	50	635000	1@1	CP_QPSK	23.00	22.70
n78	30	60	632000	1@1	DFT_BPSK	24.00	23.53
n78	30	60	632000	162@0	DFT_QPSK	24.00	23.66
n78	30	60	632000	81@40	DFT_QPSK	25.00	24.84
n78	30	60	632000	1@1	DFT_QPSK	24.00	23.45
n78	30	60	632000	1@160	DFT_QPSK	25.00	24.01
n78	30	60	632000	1@1	DFT_QAM16	23.00	22.53
n78	30	60	632000	1@1	DFT_QAM64	21.00	20.89
n78	30	60	632000	1@1	DFT_QAM256	19.00	18.93
n78	30	60	632000	1@1	CP_QPSK	23.00	22.04
n78	30	60	633333	1@1	DFT_BPSK	24.00	23.66
n78	30	60	633333	162@0	DFT_QPSK	24.00	23.79
n78	30	60	633333	81@40	DFT_QPSK	25.00	24.95
n78	30	60	633333	1@1	DFT_QPSK	24.00	23.59
n78	30	60	633333	1@160	DFT_QPSK	24.00	23.64
n78	30	60	633333	1@1	DFT_QAM16	23.00	22.69
n78	30	60	633333	1@1	DFT_QAM64	22.00	21.07
n78	30	60	633333	1@1	DFT_QAM256	20.00	19.04
n78	30	60	633333	1@1	CP_QPSK	23.00	22.21
n78	30	60	634666	1@1	DFT_BPSK	25.00	24.00
n78	30	60	634666	162@0	DFT_QPSK	24.00	23.85
n78	30	60	634666	81@40	DFT_QPSK	25.00	24.90
n78	30	60	634666	1@1	DFT_QPSK	24.00	23.95
n78	30	60	634666	1@160	DFT_QPSK	25.00	24.03
n78	30	60	634666	1@1	DFT_QAM16	24.00	23.06
n78	30	60	634666	1@1	DFT_QAM64	22.00	21.49
n78	30	60	634666	1@1	DFT_QAM256	20.00	19.44
n78	30	60	634666	1@1	CP_QPSK	23.00	22.51
n78	30	80	632667	1@1	DFT_BPSK	24.00	23.41
n78	30	80	632667	216@0	DFT_QPSK	24.00	23.73
n78	30	80	632667	108@54	DFT_QPSK	25.00	24.96
n78	30	80	632667	1@1	DFT_QPSK	24.00	23.38
n78	30	80	632667	1@215	DFT_QPSK	24.00	23.53
n78	30	80	632667	1@1	DFT_QAM16	23.00	22.43
n78	30	80	632667	1@1	DFT_QAM64	21.00	20.81
n78	30	80	632667	1@1	DFT_QAM256	19.00	18.95
n78	30	80	632667	1@1	CP_QPSK	22.00	21.85

n78	30	80	633333	1@1	DFT_BPSK	24.00	23.35
n78	30	80	633333	216@0	DFT_QPSK	24.00	23.74
n78	30	80	633333	108@54	DFT_QPSK	26.00	25.04
n78	30	80	633333	1@1	DFT_QPSK	24.00	23.31
n78	30	80	633333	1@215	DFT_QPSK	24.00	23.73
n78	30	80	633333	1@1	DFT_QAM16	23.00	22.35
n78	30	80	633333	1@1	DFT_QAM64	21.00	20.75
n78	30	80	633333	1@1	DFT_QAM256	19.00	18.72
n78	30	80	633333	1@1	CP_QPSK	22.00	21.83
n78	30	80	634000	1@1	DFT_BPSK	24.00	23.56
n78	30	80	634000	216@0	DFT_QPSK	24.00	23.82
n78	30	80	634000	108@54	DFT_QPSK	26.00	25.00
n78	30	80	634000	1@1	DFT_QPSK	24.00	23.54
n78	30	80	634000	1@215	DFT_QPSK	24.00	23.83
n78	30	80	634000	1@1	DFT_QAM16	23.00	22.59
n78	30	80	634000	1@1	DFT_QAM64	21.00	20.95
n78	30	80	634000	1@1	DFT_QAM256	20.00	19.00
n78	30	80	634000	1@1	CP_QPSK	23.00	22.01
n78	30	90	633000	1@1	DFT_BPSK	24.00	23.26
n78	30	90	633000	240@0	DFT_QPSK	24.00	23.60
n78	30	90	633000	120@60	DFT_QPSK	25.00	24.96
n78	30	90	633000	1@1	DFT_QPSK	24.00	23.25
n78	30	90	633000	1@243	DFT_QPSK	24.00	23.58
n78	30	90	633000	1@1	DFT_QAM16	23.00	22.31
n78	30	90	633000	1@1	DFT_QAM64	21.00	20.93
n78	30	90	633000	1@1	DFT_QAM256	19.00	18.72
n78	30	90	633000	1@1	CP_QPSK	22.00	21.81
n78	30	90	633333	1@1	DFT_BPSK	24.00	23.23
n78	30	90	633333	240@0	DFT_QPSK	24.00	23.70
n78	30	90	633333	120@60	DFT_QPSK	25.00	24.99
n78	30	90	633333	1@1	DFT_QPSK	24.00	23.19
n78	30	90	633333	1@243	DFT_QPSK	24.00	23.72
n78	30	90	633333	1@1	DFT_QAM16	23.00	22.29
n78	30	90	633333	1@1	DFT_QAM64	21.00	20.87
n78	30	90	633333	1@1	DFT_QAM256	19.00	18.72
n78	30	90	633333	1@1	CP_QPSK	22.00	21.81
n78	30	90	633666	1@1	DFT_BPSK	24.00	23.23
n78	30	90	633666	240@0	DFT_QPSK	24.00	23.76
n78	30	90	633666	120@60	DFT_QPSK	26.00	25.01

n78	30	90	633666	1@1	DFT_QPSK	24.00	23.22
n78	30	90	633666	1@243	DFT_QPSK	24.00	23.74
n78	30	90	633666	1@1	DFT_QAM16	23.00	22.29
n78	30	90	633666	1@1	DFT_QAM64	21.00	20.91
n78	30	90	633666	1@1	DFT_QAM256	19.00	18.75
n78	30	90	633666	1@1	CP_QPSK	22.00	21.80
n78	30	100	633333	1@1	DFT_BPSK	24.00	23.11
n78	30	100	633333	270@0	DFT_QPSK	24.00	23.59
n78	30	100	633333	135@67	DFT_QPSK	25.00	24.87
n78	30	100	633333	1@1	DFT_QPSK	24.00	23.11
n78	30	100	633333	1@271	DFT_QPSK	24.00	23.63
n78	30	100	633333	1@1	DFT_QAM16	23.00	22.19
n78	30	100	633333	1@1	DFT_QAM64	21.00	20.76
n78	30	100	633333	1@1	DFT_QAM256	19.00	18.57
n78	30	100	633333	1@1	CP_QPSK	22.00	21.64

7.5. WLAN & Bluetooth Output Power

Mode	Channel	Frequency (MHz)	Tune-up (dBm)	Output Power (dBm)
802.11b	1	2412	17.00	16.53
	6	2437	17.00	16.31
	11	2462	17.00	16.00
802.11g	1	2412	14.00	13.63
	6	2437	14.00	13.12
	11	2462	14.00	13.76
802.11n HT20	1	2412	12.00	11.65
	6	2437	12.00	11.28
	11	2462	12.00	11.27
802.11n HT40	3	2422	12.00	11.70
	6	2437	12.00	11.42
	9	2452	12.00	11.37
ax20	1	2412	12.00	11.84
	6	2437	12.00	11.47
	11	2462	12.00	11.55
ax40	3	2422	12.00	11.91
	6	2437	12.00	11.73
	9	2452	12.00	11.55

NOTE: Power measurement results of WLAN 2.4G.

Mode	Channel	Frequency (MHz)	Tune-up (dBm)	Output Power (dBm)
802.11a	36	5180	13.00	12.39
	40	5200	13.00	12.74
	48	5240	13.00	12.67
802.11n HT20	36	5180	13.00	12.31
	40	5200	13.00	12.51
	48	5240	13.00	12.49
802.11n HT40	38	5190	13.00	12.18
	46	5230	13.00	12.52
802.11ac VHT20	36	5180	13.00	12.32
	40	5200	13.00	12.55
	48	5240	13.00	12.43
802.11ac VHT40	38	5190	12.50	12.31
	46	5230	12.50	12.46
802.11ac VHT80	42	5210	12.00	11.81
ax20	36	5180	13.00	12.68
	40	5200	13.00	12.75
	48	5240	13.00	12.65
ax40	38	5190	13.00	12.28
	46	5230	13.00	12.67
ax80	42	5210	13.00	11.87

NOTE: Power measurement results of WLAN 5.2G.

Mode	Channel	Frequency (MHz)	Tune-up (dBm)	Output Power (dBm)
802.11a	149	5745	13.50	12.66
	157	5785	13.50	13.31
	165	5825	13.50	13.36
802.11n HT20	149	5745	11.50	11.13
	157	5785	11.50	11.31
	165	5825	11.50	11.35
802.11n HT40	151	5755	11.50	11.01
	159	5795	11.50	11.28
802.11ac VHT20	149	5745	11.50	11.03
	157	5785	11.50	11.35
	165	5825	11.50	11.31
802.11ac VHT40	151	5755	11.50	11.06

	159	5795	11.50	11.09
802.11ac VHT80	155	5775	11.00	10.72
ax20	149	5745	12.00	11.20
	157	5785	12.00	11.38
	165	5825	12.00	11.54
ax40	151	5755	12.00	11.12
	159	5795	12.00	11.28
ax80	155	5775	12.00	10.95

NOTE: Power measurement results of WLAN 5.8G.

BR+EDR	Output Power (dBm)				
	Channel	Tune-up (dBm)	Data Rates		
			1M	2M	3M
	0CH	0.00	-0.48	-1.69	-0.84
	39CH	0.00	-0.38	-0.81	-0.37
	78CH	0.00	-0.79	-0.66	-0.20

BLE	Channel	Tune-up (dBm)	Output Power (dBm)	
			1M	2M
		0CH	6.50	6.04
	19CH	6.50	6.36	6.42
	39CH	6.00	5.51	5.62

NOTE: Power measurement results of Bluetooth.

8. Antenna Location

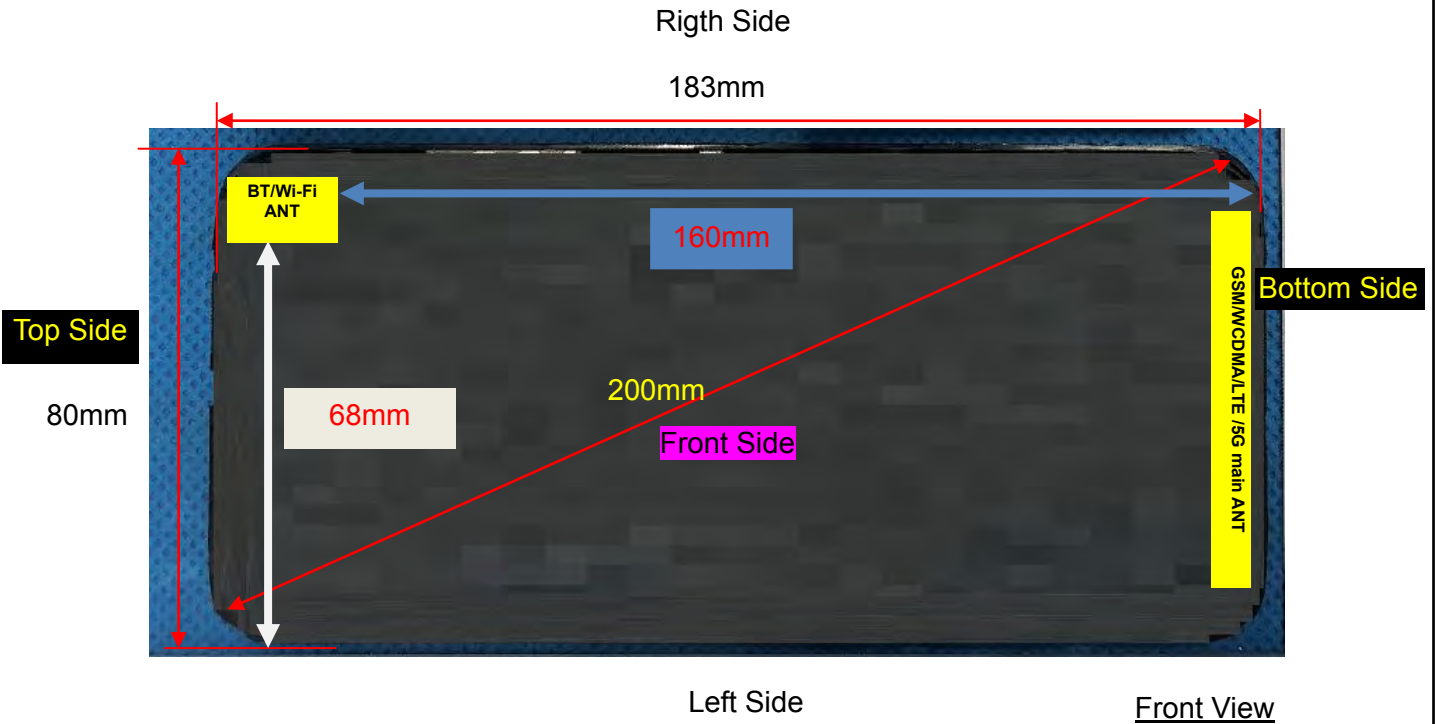

Note: Since the confidentiality request of EUT, the antenna location example diagram see as above.

Distance of the Antenna to the EUT surface/edge						
Antennas	Front Side	Back Side	Left Side	Right Side	Top Side	Bottom Side
WWAN Main ANT	≤ 25mm	≤ 25mm	≤ 25mm	≤ 25mm	> 25mm	≤ 25mm
WLAN & Bluetooth	≤ 25mm	≤ 25mm	>25mm	≤ 25mm	≤ 25mm	>25mm
Positions for SAR tests						
Antennas	Front Side	Back Side	Left Side	Right Side	Top Side	Bottom Side
WWAN Main ANT	Yes	Yes	Yes	Yes	NO	Yes
WLAN & Bluetooth	Yes	Yes	NO	Yes	Yes	NO

9. Stand-alone SAR test exclusion

Refer to FCC KDB 447498D01, the 1-g SAR and 10-g SAR test exclusion thresholds for 100 MHz to 6 GHz at test separation distances ≤ 50 mm are determined by:

$$[(\text{max. power of channel, including tune-up tolerance, mW}) / (\text{min. test separation distance, mm})] \cdot [\sqrt{f_{\text{(GHZ)}}}] \leq 3.0 \text{ for 1-g SAR and } \leq 7.5 \text{ for 10-g extremity SAR, where:}$$

- $f_{\text{(GHZ)}}$ is the RF channel transmit frequency in GHz
- Power and distance are rounded to the nearest mW and mm before calculation
- The result is rounded to one decimal place for comparison

When the minimum test separation distance is < 5 mm, a distance of 5 mm is applied to determine SAR test exclusion.

Mode	P_{max}	P_{max}	Distance	f	Calculation	SAR Exclusion	SAR test
------	------------------	------------------	----------	---	-------------	---------------	----------

	(dBm)	(mW)	(mm)	(GHz)	Result	threshold	exclusion
Bluetooth	6.50	4.47	5	2.480	1.4	3	Yes

NOTE: Standalone SAR test exclusion for Bluetooth.

When standalone SAR test exclusion applies to an antenna that transmits simultaneously with other antennas, the standalone SAR must be estimated according to following to determine simultaneous transmission SAR test exclusion:

$[(\text{max. power of channel, including tune-up tolerance, mW}) / (\text{min. test separation distance, mm})] * [\sqrt{f_{(\text{GHz})}} / x]$ W/kg for test separation distances $\leq 50\text{mm}$, where $x = 7.5$ for 1-g SAR and $x = 18.75$ for 10-g SAR.

When the minimum test separation distance is < 5 mm, a distance of 5 mm is applied to determine SAR test exclusion.

Mode	Position	P _{max} (dBm)	P _{max} (mW)	Distance (mm)	f (GHz)	x	Estimated SAR (W/Kg)
Bluetooth	Head	6.50	4.47	5	2.48	7.5	0.187
Bluetooth	Body	6.50	4.47	10	2.48	7.5	0.094
Bluetooth	Hotspot	6.50	4.47	10	2.48	7.5	0.094
Bluetooth	Body	6.50	4.47	5	2.48	18.75	0.075

NOTE: Estimated SAR calculation for Bluetooth

10. SAR Results

10.1. SAR measurement Result

10.1.1. SAR measurement Result of GSM850

Test Position of Head	Test channel /Freq.	Mode	SAR Value (W/kg)		Power Drift(%)	Conducted Power (dBm)	Tune-up Power (dBm)	Scaled SAR 1-g (W/Kg)	Date	Plot
			1-g	10-g						
Left Cheek	189/836.4	GPRS(GMSK 3TS)	0.093	0.073	1.40	31.52	32.00	0.104	2023/10/23	1#
Left Tilt 15 Degree	189/836.4	GPRS(GMSK 3TS)	0.051	0.039	1.24	31.52	32.00	0.057	2023/10/23	
Right Cheek	189/836.4	GPRS(GMSK 3TS)	0.085	0.064	-1.88	31.52	32.00	0.095	2023/10/23	
Right Tilt 15 Degree	189/836.4	GPRS(GMSK 3TS)	0.042	0.033	-2.20	31.52	32.00	0.047	2023/10/23	

NOTE: Head SAR test results of GSM850.

Test Position of Body-Worn with 10mm	Test channel /Freq.	Test Mode	SAR Value (W/kg)		Power Drift (±5%)	Conducted power (dBm)	Tune-up power (dBm)	Scaled SAR 1g (W/Kg)	Date	Plot
			1g	10g						
Front Side	189/836.4	GPRS(GMSK 3TS)	0.198	0.118	-2.90	31.52	32.00	0.221	2023/10/23	
Back Side	189/836.4	GPRS(GMSK 3TS)	0.312	0.189	2.80	31.52	32.00	0.348	2023/10/23	2#

NOTE: Body-Worn SAR test results of GSM850

Test Position of Hotspot with 10mm	Test channel /Freq.	Mode	SAR Value (W/kg)		Power Drift(%)	Conducted Power (dBm)	Tune-up Power (dBm)	Scaled SAR 1-g (W/Kg)	Date	Plot
			1-g	10-g						
Front Side	189/836.4	GPRS(GMSK 3TS)	0.198	0.118	-2.90	31.52	32.00	0.221	2023/10/23	
Back Side	189/836.4	GPRS(GMSK 3TS)	0.312	0.189	2.80	31.52	32.00	0.348	2023/10/23	2#
Left Side	189/836.4	GPRS(GMSK 3TS)	0.105	0.064	-3.39	31.52	32.00	0.117	2023/10/23	
Right Side	189/836.4	GPRS(GMSK 3TS)	0.108	0.062	-0.11	31.52	32.00	0.121	2023/10/23	
Bottom Side	189/836.4	GPRS(GMSK 3TS)	0.180	0.106	0.82	31.52	32.00	0.201	2023/10/23	

NOTE: Hotspot SAR test results of GSM850

10.1.2. SAR measurement Result of GSM1900

Test Position of Head	Test channel /Freq.	Mode	SAR Value (W/kg)		Power Drift(%)	Conducted Power (dBm)	Tune-up Power (dBm)	Scaled SAR 1-g (W/Kg)	Date	Plot
			1-g	10-g						
Left Cheek	661/1880	GPRS(GMSK 3TS)	0.064	0.042	2.75	28.53	29.50	0.080	2023/10/24	3#
Left Tilt 15 Degree	661/1880	GPRS(GMSK 3TS)	0.033	0.021	-0.54	28.53	29.50	0.041	2023/10/24	
Right Cheek	661/1880	GPRS(GMSK 3TS)	0.059	0.037	3.49	28.53	29.50	0.074	2023/10/24	
Right Tilt 15	661/1880	GPRS(GMSK 3TS)	0.031	0.020	-1.73	28.53	29.50	0.039	2023/10/24	

Degree										
--------	--	--	--	--	--	--	--	--	--	--

NOTE: Head SAR test results of GSM1900

Test Position of Body-Worn with 10mm	Test channel /Freq.	Test Mode	SAR Value (W/kg)		Power Drift (±5%)	Conducted power (dBm)	Tune-up power (dBm)	Scaled SAR 1g (W/Kg)	Date	Plot
			1g	10g						
Front Side	661/1880	GPRS(GMSK 3TS)	0.229	0.125	0.30	28.53	29.50	0.286	2023/10/24	
Back Side	661/1880	GPRS(GMSK 3TS)	0.320	0.182	4.57	28.53	29.50	0.400	2023/10/24	4#

NOTE: Body-Worn SAR test results of GSM1900

Test Position of Hotspot with 10mm	Test channel /Freq.	Mode	SAR Value (W/kg)		Power Drift(%)	Conducted Power (dBm)	Tune-up Power (dBm)	Scaled SAR 1-g (W/Kg)	Date	Plot
			1-g	10-g						
Front Side	661/1880	GPRS(GMSK 3TS)	0.229	0.125	0.30	28.53	29.50	0.286	2023/10/24	
Back Side	661/1880	GPRS(GMSK 3TS)	0.320	0.182	4.57	28.53	29.50	0.400	2023/10/24	4#
Left Side	661/1880	GPRS(GMSK 3TS)	0.102	0.056	-0.56	28.53	29.50	0.128	2023/10/24	
Right Side	661/1880	GPRS(GMSK 3TS)	0.111	0.061	2.57	28.53	29.50	0.139	2023/10/24	
Bottom Side	661/1880	GPRS(GMSK 3TS)	0.160	0.086	2.80	28.53	29.50	0.200	2023/10/24	

NOTE: Hotspot SAR test results of GSM1900

10.1.3. SAR measurement Result of WCDMA Band 2

Test Position of Head	Test channel /Freq	Mode	SAR Value (W/kg)		Power Drift(%)	Conducted Power (dBm)	Tune-up Power (dBm)	Scaled SAR 1-g (W/Kg)	Date	Plot
			1-g	10-g						
Left Cheek	9400/1880	RMC12.2K	0.044	0.030	0.98	22.97	23.50	0.050	2023/10/24	5#
Left Tilt 15 Degree	9400/1880	RMC12.2K	0.023	0.015	3.17	22.97	23.50	0.026	2023/10/24	
Right Cheek	9400/1880	RMC12.2K	0.042	0.028	-1.19	22.97	23.50	0.047	2023/10/24	
Right Tilt 15 Degree	9400/1880	RMC12.2K	0.019	0.017	-2.93	22.97	23.50	0.021	2023/10/24	

NOTE: Head SAR test results of WCDMA Band 2

Test Position of Body-Worn	Test channel /Freq.	Test Mode	SAR Value (W/kg)		Power Drift (±5%)	Conducted power (dBm)	Tune-up power (dBm)	Scaled SAR 1g	Date	Plot
			1g	10g						

with 10mm								(W/Kg)		
Front Side	9400/1880	RMC12.2K	0.170	0.095	-0.48	22.97	23.50	0.192	2023/10/24	
Back Side	9400/1880	RMC12.2K	0.220	0.130	1.44	22.97	23.50	0.249	2023/10/24	6#

NOTE: Body-Worn SAR test results of WCDMA Band 2

Test Position of Hotspot with 10mm	Test channel /Freq.	Mode	SAR Value (W/kg)		Power Drift(%)	Conducted Power (dBm)	Tune-up Power (dBm)	Scaled SAR 1-g (W/Kg)	Date	Plot
			1-g	10-g						
Front Side	9400/1880	RMC12.2K	0.170	0.095	-0.48	22.97	23.50	0.192	2023/10/24	
Back Side	9400/1880	RMC12.2K	0.220	0.130	1.44	22.97	23.50	0.249	2023/10/24	6#
Left Side	9400/1880	RMC12.2K	0.069	0.040	-0.10	22.97	23.50	0.078	2023/10/24	
Right Side	9400/1880	RMC12.2K	0.078	0.046	0.35	22.97	23.50	0.088	2023/10/24	
Bottom Side	9400/1880	RMC12.2K	0.120	0.067	2.51	22.97	23.50	0.136	2023/10/24	

NOTE: Hotspot SAR test results of WCDMA Band 2

10.1.4. SAR measurement Result of WCDMA Band 4

Test Position of Head	Test channel /Freq	Mode	SAR Value (W/kg)		Power Drift(%)	Conducted Power (dBm)	Tune-up Power (dBm)	Scaled SAR 1-g (W/Kg)	Date	Plot
			1-g	10-g						
Left Cheek	1413/1732.6	RMC12.2K	0.027	0.021	0.43	23.82	24.50	0.032	2023/10/31	7#
Left Tilt 15 Degree	1413/1732.6	RMC12.2K	0.016	0.014	-1.72	23.82	24.50	0.019	2023/10/31	
Right Cheek	1413/1732.6	RMC12.2K	0.024	0.018	-3.35	23.82	24.50	0.028	2023/10/31	
Right Tilt 15 Degree	1413/1732.6	RMC12.2K	0.011	0.009	-0.54	23.82	24.50	0.013	2023/10/31	

NOTE: Head SAR test results of WCDMA Band 4

Test Position of Body-Worn with 10mm	Test channel /Freq.	Test Mode	SAR Value (W/kg)		Power Drift (±5%)	Conducted power (dBm)	Tune-up power (dBm)	Scaled SAR 1g (W/Kg)	Date	Plot
			1g	10g						
Front Side	1413/1732.6	RMC12.2K	0.245	0.128	1.07	23.82	24.50	0.287	2023/10/31	8#
Back Side	1413/1732.6	RMC12.2K	0.176	0.098	1.38	23.82	24.50	0.206	2023/10/31	

NOTE: Body-Worn SAR test results of WCDMA Band 4

Test Position of Hotspot with 10mm	Test channel /Freq.	Mode	SAR Value (W/kg)		Power Drift(%)	Conducted Power (dBm)	Tune-up Power (dBm)	Scaled SAR 1-g (W/Kg)	Date	Plot
			1-g	10-g						
Front Side	1413/1732.6	RMC12.2K	0.245	0.128	1.07	23.82	24.50	0.287	2023/10/31	8#
Back Side	1413/1732.6	RMC12.2K	0.176	0.098	1.38	23.82	24.50	0.206	2023/10/31	
Left Side	1413/1732.6	RMC12.2K	0.060	0.032	-1.35	23.82	24.50	0.070	2023/10/31	
Right Side	1413/1732.6	RMC12.2K	0.063	0.033	1.22	23.82	24.50	0.074	2023/10/31	
Bottom Side	1413/1732.6	RMC12.2K	0.095	0.050	2.52	23.82	24.50	0.111	2023/10/31	

NOTE: Hotspot SAR test results of WCDMA Band 4

10.1.5. SAR measurement Result of WCDMA Band 5

Test Position of Head	Test channel /Freq	Mode	SAR Value (W/kg)		Power Drift(%)	Conducted Power (dBm)	Tune-up Power (dBm)	Scaled SAR 1-g (W/Kg)	Date	Plot
			1-g	10-g						
Left Cheek	4182/836.4	RMC12.2K	0.050	0.040	4.48	24.49	24.50	0.050	2023/10/23	9#
Left Tilt 15 Degree	4182/836.4	RMC12.2K	0.028	0.022	-1.79	24.49	24.50	0.028	2023/10/23	
Right Cheek	4182/836.4	RMC12.2K	0.046	0.035	-2.25	24.49	24.50	0.046	2023/10/23	
Right Tilt 15 Degree	4182/836.4	RMC12.2K	0.021	0.016	2.76	24.49	24.50	0.021	2023/10/23	

NOTE: Head SAR test results of WCDMA Band 5

Test Position of Body-Worn with 10mm	Test channel /Freq.	Test Mode	SAR Value (W/kg)		Power Drift (±5%)	Conducted power (dBm)	Tune-up power (dBm)	Scaled SAR 1g (W/Kg)	Date	Plot
			1g	10g						
Front Side	4182/836.4	RMC12.2K	0.161	0.100	0.15	24.49	24.50	0.161	2023/10/23	10#
Back Side	4182/836.4	RMC12.2K	0.115	0.050	1.23	24.49	24.50	0.115	2023/10/23	

NOTE: Body-Worn SAR test results of WCDMA Band 5

Test Position of Hotspot with 10mm	Test channel /Freq.	Mode	SAR Value (W/kg)		Power Drift(%)	Conducted Power (dBm)	Tune-up Power (dBm)	Scaled SAR 1-g (W/Kg)	Date	Plot
			1-g	10-g						
Front Side	4182/836.4	RMC12.2K	0.161	0.100	0.15	24.49	24.50	0.161	2023/10/23	10#
Back Side	4182/836.4	RMC12.2K	0.115	0.050	1.23	24.49	24.50	0.115	2023/10/23	
Left Side	4182/836.4	RMC12.2K	0.030	0.018	0.20	24.49	24.50	0.030	2023/10/23	
Right Side	4182/836.4	RMC12.2K	0.028	0.016	1.30	24.49	24.50	0.028	2023/10/23	
Bottom Side	4182/836.4	RMC12.2K	0.060	0.030	1.52	24.49	24.50	0.060	2023/10/23	

NOTE: Hotspot SAR test results of WCDMA Band 5

10.1.6. SAR measurement Result of LTE Band 2

Test Position of Head	Test channel /Freq.	Mode	SAR Value (W/kg)		Power Drift(%)	Conducte d Power (dBm)	Tune-up Power (dBm)	Scaled SAR 1-g (W/Kg)	Date	Plot
			1-g	10-g						
1RB										
Left Cheek	18900/1880	20M QPSK(1,0)	0.045	0.030	3.69	21.94	22.50	0.051	2023/10/24	17#
Left Tilt 15 Degree	18900/1880	20M QPSK(1,0)	0.026	0.017	0.99	21.94	22.50	0.030	2023/10/24	
Right	18900/1880	20M QPSK(1,0)	0.041	0.027	-2.77	21.94	22.50	0.047	2023/10/24	

Cheek										
Right Tilt 15 Degree	18900/1880	20M QPSK(1,0)	0.022	0.014	-3.12	21.94	22.50	0.025	2023/10/24	
50%RB										
Left Cheek	18900/1880	20M QPSK(50,49)	0.025	0.016	-1.73	21.34	21.50	0.026	2023/10/24	
Left Tilt 15 Degree	18900/1880	20M QPSK(50,49)	0.013	0.009	3.04	21.34	21.50	0.013	2023/10/24	
Right Cheek	18900/1880	20M QPSK(50,49)	0.022	0.015	1.82	21.34	21.50	0.023	2023/10/24	
Right Tilt 15 Degree	18900/1880	20M QPSK(50,49)	0.011	0.008	1.59	21.34	21.50	0.011	2023/10/24	

NOTE: Head SAR test results of LTE Band 2

Test Position of Body-Worn with 10mm	Test channel /Freq.	Test Mode	SAR Value (W/kg)		Power Drift (±5%)	Conducted power (dBm)	Tune-up power (dBm)	Scaled SAR 1g (W/Kg)	Date	Plot
			1g	10g						
1RB										
Front Side	18900/1880	20M QPSK(1,0)	0.189	0.103	1.14	21.94	22.50	0.215	2023/10/24	
Back Side	18900/1880	20M QPSK(1,0)	0.225	0.135	2.37	21.94	22.50	0.256	2023/10/24	18#
50%RB										
Front Side	18900/1880	20M QPSK(50,49)	0.102	0.053	-4.72	21.34	21.50	0.106	2023/10/24	
Back Side	18900/1880	20M QPSK(50,49)	0.124	0.075	3.34	21.34	21.50	0.129	2023/10/24	

NOTE: Body-Worn SAR test results of LTE Band 2

Test Position of Hotspot with 10mm	Test channel /Freq.	Mode	SAR Value (W/kg)		Power Drift(%)	Conducted Power (dBm)	Tune-up Power (dBm)	Scaled SAR 1-g (W/Kg)	Date	Plot
			1-g	10-g						
1RB										
Front Side	18900/1880	20M QPSK(1,0)	0.189	0.103	1.14	21.94	22.50	0.215	2023/10/24	
Back Side	18900/1880	20M QPSK(1,0)	0.225	0.135	2.37	21.94	22.50	0.256	2023/10/24	18#
Left Side	18900/1880	20M QPSK(1,0)	0.081	0.048	-1.66	21.94	22.50	0.092	2023/10/24	
Right Side	18900/1880	20M QPSK(1,0)	0.069	0.039	-0.97	21.94	22.50	0.078	2023/10/24	

Bottom Side	18900/1880	20M QPSK(1,0)	0.130	0.077	1.01	21.94	22.50	0.148	2023/10/24	
50%RB										
Front Side	18900/1880	20M QPSK(50,49)	0.102	0.053	-4.72	21.34	21.50	0.106	2023/10/24	
Back Side	18900/1880	20M QPSK(50,49)	0.124	0.075	3.34	21.34	21.50	0.129	2023/10/24	
Left Side	18900/1880	20M QPSK(50,49)	0.043	0.027	-3.37	21.34	21.50	0.045	2023/10/24	
Right Side	18900/1880	20M QPSK(50,49)	0.040	0.023	-3.99	21.34	21.50	0.042	2023/10/24	
Bottom Side	18900/1880	20M QPSK(50,49)	0.067	0.040	0.02	21.34	21.50	0.070	2023/10/24	

NOTE: Hotspot SAR test results of LTE Band 2

10.1.7. SAR measurement Result of LTE Band 4

Test Position of Head	Test channel /Freq.	Mode	SAR Value (W/kg)		Power Drift(%)	Conducted Power (dBm)	Tune-up Power (dBm)	Scaled SAR 1-g (W/Kg)	Date	Plot
			1-g	10-g						
1RB										
Left Cheek	20175/1732.5	20M QPSK(1,0)	0.030	0.023	-0.19	23.21	24.00	0.036	2023/10/31	19#
Left Tilt 15 Degree	20175/1732.5	20M QPSK(1,0)	0.016	0.014	-1.21	23.21	24.00	0.019	2023/10/31	
Right Cheek	20175/1732.5	20M QPSK(1,0)	0.027	0.020	-0.42	23.21	24.00	0.032	2023/10/31	
Right Tilt 15 Degree	20175/1732.5	20M QPSK(1,0)	0.013	0.011	1.84	23.21	24.00	0.016	2023/10/31	
50%RB										
Left Cheek	20175/1732.5	20M QPSK(50,0)	0.016	0.012	1.22	22.48	22.50	0.016	2023/10/31	
Left Tilt 15 Degree	20175/1732.5	20M QPSK(50,0)	0.009	0.008	2.38	22.48	22.50	0.009	2023/10/31	
Right Cheek	20175/1732.5	20M QPSK(50,0)	0.015	0.011	0.73	22.48	22.50	0.015	2023/10/31	
Right Tilt 15 Degree	20175/1732.5	20M QPSK(50,0)	0.008	0.006	-1.99	22.48	22.50	0.008	2023/10/31	

NOTE: Head SAR test results of LTE Band 4

Test Position of Body-Worn with 10mm	Test channel /Freq.	Test Mode	SAR Value (W/kg)		Power Drift ($\pm 5\%$)	Conducted power (dBm)	Tune-up power (dBm)	Scaled SAR 1g (W/Kg)	Date	Plot
			1g	10g						
1RB										
Front Side	20175/1732.5	20M QPSK(1,0)	0.310	0.159	0.61	23.21	24.00	0.372	2023/10/31	20#
Back Side	20175/1732.5	20M QPSK(1,0)	0.216	0.120	-0.27	23.21	24.00	0.259	2023/10/31	
50%RB										
Front Side	20175/1732.5	20M QPSK(50,0)	0.176	0.084	-0.59	22.48	22.50	0.177	2023/10/31	
Back Side	20175/1732.5	20M QPSK(50,0)	0.119	0.062	2.97	22.48	22.50	0.120	2023/10/31	

NOTE: Body-Worn SAR test results of LTE Band 4

Test Position of Hotspot with 10mm	Test channel /Freq.	Mode	SAR Value (W/kg)		Power Drift(%)	Conducted Power (dBm)	Tune-up Power (dBm)	Scaled SAR 1-g (W/Kg)	Date	Plot
			1-g	10-g						
1RB										
Front Side	20175/1732.5	20M QPSK(1,0)	0.310	0.159	0.61	23.21	24.00	0.372	2023/10/31	20#
Back Side	20175/1732.5	20M QPSK(1,0)	0.216	0.120	-0.27	23.21	24.00	0.259	2023/10/31	
Left Side	20175/1732.5	20M QPSK(1,0)	0.066	0.037	2.73	23.21	24.00	0.079	2023/10/31	
Right Side	20175/1732.5	20M QPSK(1,0)	0.075	0.040	-1.58	23.21	24.00	0.090	2023/10/31	
Bottom Side	20175/1732.5	20M QPSK(1,0)	0.125	0.067	2.78	23.21	24.00	0.150	2023/10/31	
50%RB										
Front	20175/1732.5	20M QPSK(50,0)	0.176	0.084	-0.59	22.48	22.50	0.177	2023/10/31	

Side										
Back Side	20175/1732.5	20M QPSK(50,0)	0.119	0.062	2.97	22.48	22.50	0.120	2023/10/31	
Left Side	20175/1732.5	20M QPSK(50,0)	0.035	0.019	1.90	22.48	22.50	0.035	2023/10/31	
Right Side	20175/1732.5	20M QPSK(50,0)	0.043	0.023	-3.49	22.48	22.50	0.043	2023/10/31	
Bottom Side	20175/1732.5	20M QPSK(50,0)	0.063	0.034	-4.23	22.48	22.50	0.063	2023/10/31	

NOTE: Hotspot SAR test results of LTE Band 4

10.1.8. SAR measurement Result of LTE Band 5

Test Position of Head	Test channel /Freq.	Mode	SAR Value (W/kg)		Power Drift(%)	Conducted Power (dBm)	Tune-up Power (dBm)	Scaled SAR 1-g (W/Kg)	Date	Plot
			1-g	10-g						
1RB										
Left Cheek	20525/836.5	10M QPSK(1,24)	0.066	0.053	0.71	24.32	24.50	0.069	2023/10/23	21#
Left Tilt 15 Degree	20525/836.5	10M QPSK(1,24)	0.038	0.029	2.27	24.32	24.50	0.040	2023/10/23	
Right Cheek	20525/836.5	10M QPSK(1,24)	0.059	0.047	2.62	24.32	24.50	0.061	2023/10/23	
Right Tilt 15 Degree	20525/836.5	10M QPSK(1,24)	0.029	0.022	3.70	24.32	24.50	0.030	2023/10/23	
50%RB										
Left Cheek	20525/836.5	10M QPSK(25,0)	0.037	0.028	3.13	23.31	23.50	0.039	2023/10/23	
Left Tilt 15 Degree	20525/836.5	10M QPSK(25,0)	0.020	0.015	-3.29	23.31	23.50	0.021	2023/10/23	
Right Cheek	20525/836.5	10M QPSK(25,0)	0.033	0.027	-1.74	23.31	23.50	0.034	2023/10/23	
Right Tilt 15 Degree	20525/836.5	10M QPSK(25,0)	0.015	0.013	3.62	23.31	23.50	0.016	2023/10/23	

NOTE: Head SAR test results of LTE Band 5

Test Position of Body-Worn with 10mm	Test channel /Freq.	Test Mode	SAR Value (W/kg)		Power Drift (±5%)	Conducted power (dBm)	Tune-up power (dBm)	Scaled SAR 1g (W/Kg)	Date	Plot
			1g	10g						
1RB										
Front Side	20525/836.5	10M QPSK(1,24)	0.230	0.140	0.11	24.32	24.50	0.240	2023/10/23	22#
Back Side	20525/836.5	10M QPSK(1,24)	0.144	0.093	-0.08	24.32	24.50	0.150	2023/10/23	
50%RB										
Front Side	20525/836.5	10M QPSK(25,0)	0.129	0.084	-3.18	23.31	23.50	0.135	2023/10/23	
Back Side	20525/836.5	10M QPSK(25,0)	0.077	0.049	4.09	23.31	23.50	0.080	2023/10/23	

NOTE: Body-Worn SAR test results of LTE Band 5

Test Position of Hotspot with 10mm	Test channel /Freq.	Mode	SAR Value (W/kg)		Power Drift(%)	Conducted Power (dBm)	Tune-up Power (dBm)	Scaled SAR 1-g (W/Kg)	Date	Plot
			1-g	10-g						
1RB										
Front Side	20525/836.5	10M QPSK(1,24)	0.230	0.140	0.11	24.32	24.50	0.240	2023/10/23	22#
Back Side	20525/836.5	10M QPSK(1,24)	0.144	0.093	-0.08	24.32	24.50	0.150	2023/10/23	
Left Side	20525/836.5	10M QPSK(1,24)	0.057	0.035	2.73	24.32	24.50	0.059	2023/10/23	
Right Side	20525/836.5	10M QPSK(1,24)	0.045	0.028	2.72	24.32	24.50	0.047	2023/10/23	
Bottom Side	20525/836.5	10M QPSK(1,24)	0.075	0.046	2.46	24.32	24.50	0.078	2023/10/23	
50%RB										
Front Side	20525/836.5	10M QPSK(25,0)	0.129	0.084	-3.18	23.31	23.50	0.135	2023/10/23	

Back Side	20525/836.5	10M QPSK(25,0)	0.077	0.049	4.09	23.31	23.50	0.080	2023/10/23	
Left Side	20525/836.5	10M QPSK(25,0)	0.032	0.019	4.23	23.31	23.50	0.033	2023/10/23	
Right Side	20525/836.5	10M QPSK(25,0)	0.025	0.015	2.58	23.31	23.50	0.026	2023/10/23	
Bottom Side	20525/836.5	10M QPSK(25,0)	0.038	0.027	4.86	23.31	23.50	0.040	2023/10/23	

NOTE: Hotspot SAR test results of LTE Band 5

10.1.9. SAR measurement Result of LTE Band 7

Test Position of Head	Test channel /Freq.	Mode	SAR Value (W/kg)		Power Drift(%)	Conducted Power (dBm)	Tune-up Power (dBm)	Scaled SAR 1-g (W/Kg)	Date	Plot
			1-g	10-g						
1RB										
Left Cheek	21100/2535	20M QPSK(1,0)	0.056	0.036	3.60	23.29	23.50	0.059	2023/10/29	23#
Left Tilt 15 Degree	21100/2535	20M QPSK(1,0)	0.033	0.020	-2.44	23.29	23.50	0.035	2023/10/29	
Right Cheek	21100/2535	20M QPSK(1,0)	0.052	0.032	1.28	23.29	23.50	0.055	2023/10/29	
Right Tilt 15 Degree	21100/2535	20M QPSK(1,0)	0.027	0.017	-0.21	23.29	23.50	0.028	2023/10/29	
50%RB										
Left Cheek	21100/2535	20M QPSK(50,0)	0.030	0.021	-3.46	22.48	22.50	0.030	2023/10/29	
Left Tilt 15 Degree	21100/2535	20M QPSK(50,0)	0.017	0.011	-1.25	22.48	22.50	0.017	2023/10/29	
Right Cheek	21100/2535	20M QPSK(50,0)	0.028	0.019	-4.09	22.48	22.50	0.028	2023/10/29	
Right Tilt 15 Degree	21100/2535	20M QPSK(50,0)	0.015	0.010	0.96	22.48	22.50	0.015	2023/10/29	

NOTE: Head SAR test results of LTE Band 7

Test Position of Body-Worn with 10mm	Test channel /Freq.	Mode	SAR Value (W/kg)		Power Drift(%)	Conducted Power (dBm)	Tune-up Power (dBm)	Scaled SAR 1-g (W/Kg)	Date	Plot
			1-g	10-g						
1RB										
Front Side	21100/2535	20M QPSK(1,0)	0.116	0.063	3.95	23.29	23.50	0.122	2023/10/29	
Back Side	21100/2535	20M QPSK(1,0)	0.212	0.096	4.94	23.29	23.50	0.223	2023/10/29	24#
50%RB										
Front Side	21100/2535	20M QPSK(50,0)	0.068	0.033	-1.63	22.48	22.50	0.068	2023/10/29	
Back Side	21100/2535	20M QPSK(50,0)	0.122	0.053	-3.93	22.48	22.50	0.123	2023/10/29	

NOTE: Body-Worn SAR test results of LTE Band 7

Test Position of Hotspot with 10mm	Test channel /Freq.	Mode	SAR Value (W/kg)		Power Drift(%)	Conducted Power (dBm)	Tune-up Power (dBm)	Scaled SAR 1-g (W/Kg)	Date	Plot
			1-g	10-g						
1RB										
Front Side	21100/2535	20M QPSK(1,0)	0.116	0.063	3.95	23.29	23.50	0.122	2023/10/29	
Back Side	21100/2535	20M QPSK(1,0)	0.212	0.096	4.94	23.29	23.50	0.223	2023/10/29	24#
Left Side	21100/2535	20M QPSK(1,0)	0.078	0.035	-1.36	23.29	23.50	0.082	2023/10/29	
Right Side	21100/2535	20M QPSK(1,0)	0.080	0.037	-1.61	23.29	23.50	0.084	2023/10/29	
Bottom Side	21100/2535	20M QPSK(1,0)	0.115	0.051	-0.60	23.29	23.50	0.121	2023/10/29	
50%RB										
Front Side	21100/2535	20M QPSK(50,0)	0.068	0.033	-1.63	22.48	22.50	0.068	2023/10/29	
Back Side	21100/2535	20M QPSK(50,0)	0.122	0.053	-3.93	22.48	22.50	0.123	2023/10/29	
Left Side	21100/2535	20M QPSK(50,0)	0.041	0.018	2.51	22.48	22.50	0.041	2023/10/29	
Right Side	21100/2535	20M QPSK(50,0)	0.045	0.019	3.25	22.48	22.50	0.045	2023/10/29	
Bottom Side	21100/2535	20M QPSK(50,0)	0.066	0.028	0.31	22.48	22.50	0.066	2023/10/29	

NOTE: Hotspot SAR test results of LTE Band 7

10.1.10. SAR measurement Result of LTE Band 12

Test Position of Head	Test channel /Freq.	Mode	SAR Value (W/kg)		Power Drift(%)	Conducted Power (dBm)	Tune-up Power (dBm)	Scaled SAR 1-g (W/Kg)	Date	Plot
			1-g	10-g						
1RB										
Left Cheek	23095/707.5	10M QPSK(1,0)	0.042	0.036	0.97	24.30	24.50	0.044	2023/10/26	25#
Left Tilt 15 Degree	23095/707.5	10M QPSK(1,0)	0.024	0.020	0.79	24.30	24.50	0.025	2023/10/26	
Right Cheek	23095/707.5	10M QPSK(1,0)	0.039	0.033	3.57	24.30	24.50	0.041	2023/10/26	
Right Tilt 15 Degree	23095/707.5	10M QPSK(1,0)	0.019	0.017	-3.14	24.30	24.50	0.020	2023/10/26	
50%RB										
Left Cheek	23095/707.5	10M QPSK(25,0)	0.024	0.020	0.19	23.24	23.50	0.025	2023/10/26	
Left Tilt 15 Degree	23095/707.5	10M QPSK(25,0)	0.013	0.011	0.36	23.24	23.50	0.014	2023/10/26	
Right Cheek	23095/707.5	10M QPSK(25,0)	0.023	0.019	3.52	23.24	23.50	0.024	2023/10/26	
Right Tilt 15 Degree	23095/707.5	10M QPSK(25,0)	0.011	0.010	-0.37	23.24	23.50	0.012	2023/10/26	

NOTE: Head SAR test results of LTE Band 12

Test Position of Body-Worn with 10mm	Test channel /Freq.	Mode	SAR Value (W/kg)		Power Drift(%)	Conducted Power (dBm)	Tune-up Power (dBm)	Scaled SAR 1-g (W/Kg)	Date	Plot
			1-g	10-g						
1RB										
Front Side	23095/707.5	10M QPSK(1,0)	0.060	0.051	2.66	24.30	24.50	0.063	2023/10/26	
Back Side	23095/707.5	10M QPSK(1,0)	0.066	0.053	0.42	24.30	24.50	0.069	2023/10/26	26#
50%RB										

Front Side	23095/707.5	10M QPSK(25,0)	0.035	0.026	-0.79	23.24	23.50	0.037	2023/10/26	
Back Side	23095/707.5	10M QPSK(25,0)	0.037	0.032	-1.75	23.24	23.50	0.039	2023/10/26	

NOTE: Body-Worn SAR test results of LTE Band 12

Test Position of Hotspot with 10mm	Test channel /Freq.	Mode	SAR Value (W/kg)		Power Drift(%)	Conducted Power (dBm)	Tune-up Power (dBm)	Scaled SAR 1-g (W/Kg)	Date	Plot
			1-g	10-g						
1RB										
Front Side	23095/707.5	10M QPSK(1,0)	0.060	0.051	2.66	24.30	24.50	0.063	2023/10/26	
Back Side	23095/707.5	10M QPSK(1,0)	0.066	0.053	0.42	24.30	24.50	0.069	2023/10/26	26#
Left Side	23095/707.5	10M QPSK(1,0)	0.024	0.019	1.50	24.30	24.50	0.025	2023/10/26	
Right Side	23095/707.5	10M QPSK(1,0)	0.027	0.022	-3.85	24.30	24.50	0.028	2023/10/26	
Bottom Side	23095/707.5	10M QPSK(1,0)	0.040	0.032	-1.69	24.30	24.50	0.042	2023/10/26	
50%RB										
Front Side	23095/707.5	10M QPSK(25,0)	0.035	0.026	-0.79	23.24	23.50	0.037	2023/10/26	
Back Side	23095/707.5	10M QPSK(25,0)	0.037	0.032	-1.75	23.24	23.50	0.039	2023/10/26	
Left Side	23095/707.5	10M QPSK(25,0)	0.013	0.010	4.30	23.24	23.50	0.014	2023/10/26	
Right Side	23095/707.5	10M QPSK(25,0)	0.015	0.012	-3.44	23.24	23.50	0.016	2023/10/26	
Bottom Side	23095/707.5	10M QPSK(25,0)	0.021	0.018	2.42	23.24	23.50	0.022	2023/10/26	

NOTE: Hotspot SAR test results of LTE Band 12

10.1.11. SAR measurement Result of LTE Band 17

Test Position of Head	Test channel /Freq.	Mode	SAR Value (W/kg)		Power Drift(%)	Conducted Power (dBm)	Tune-up Power (dBm)	Scaled SAR 1-g (W/Kg)	Date	Plot
			1-g	10-g						

1RB										
Left Cheek	23790/710	10M QPSK(1,0)	0.039	0.033	1.25	24.29	24.50	0.041	2023/10/26	27#
Left Tilt 15 Degree	23790/710	10M QPSK(1,0)	0.021	0.017	-2.71	24.29	24.50	0.022	2023/10/26	
Right Cheek	23790/710	10M QPSK(1,0)	0.036	0.030	-2.71	24.29	24.50	0.038	2023/10/26	
Right Tilt 15 Degree	23790/710	10M QPSK(1,0)	0.017	0.015	-1.80	24.29	24.50	0.018	2023/10/26	
50%RB										
Left Cheek	23790/710	10M QPSK(25,0)	0.023	0.017	-4.76	23.17	23.50	0.025	2023/10/26	
Left Tilt 15 Degree	23790/710	10M QPSK(25,0)	0.011	0.009	-0.17	23.17	23.50	0.012	2023/10/26	
Right Cheek	23790/710	10M QPSK(25,0)	0.020	0.015	3.15	23.17	23.50	0.022	2023/10/26	
Right Tilt 15 Degree	23790/710	10M QPSK(25,0)	0.010	0.008	-2.93	23.17	23.50	0.011	2023/10/26	

NOTE: Head SAR test results of LTE Band 17

Test Position of Body-Worn with 10mm	Test channel /Freq.	Mode	SAR Value (W/kg)		Power Drift(%)	Conducted Power (dBm)	Tune-up Power (dBm)	Scaled SAR 1-g (W/Kg)	Date	Plot
			1-g	10-g						
1RB										
Front Side	23790/710	10M QPSK(1,0)	0.087	0.058	-0.38	24.29	24.50	0.091	2023/10/26	28#
Back Side	23790/710	10M QPSK(1,0)	0.064	0.050	-3.60	24.29	24.50	0.067	2023/10/26	
50%RB										
Front Side	23790/710	10M QPSK(25,0)	0.044	0.034	-2.17	23.17	23.50	0.047	2023/10/26	
Back Side	23790/710	10M QPSK(25,0)	0.033	0.027	-1.87	23.17	23.50	0.036	2023/10/26	

NOTE: Body-Worn SAR test results of LTE Band 17

Test Position of Hotspot	Test channel /Freq.	Mode	SAR Value (W/kg)		Power Drift(%)	Conducted Power (dBm)	Tune-up Power (dBm)	Scaled SAR 1-g (W/Kg)	Date	Plot
			1-g	10-g						

with 10mm										
1RB										
Front Side	23790/710	10M QPSK(1,0)	0.087	0.058	-0.38	24.29	24.50	0.091	2023/10/26	28#
Back Side	23790/710	10M QPSK(1,0)	0.064	0.050	-3.60	24.29	24.50	0.067	2023/10/26	
Left Side	23790/710	10M QPSK(1,0)	0.024	0.018	2.93	24.29	24.50	0.025	2023/10/26	
Right Side	23790/710	10M QPSK(1,0)	0.027	0.020	3.62	24.29	24.50	0.028	2023/10/26	
Bottom Side	23790/710	10M QPSK(1,0)	0.050	0.039	2.96	24.29	24.50	0.052	2023/10/26	
50%RB										
Front Side	23790/710	10M QPSK(25,0)	0.044	0.034	-2.17	23.17	23.50	0.047	2023/10/26	
Back Side	23790/710	10M QPSK(25,0)	0.033	0.027	-1.87	23.17	23.50	0.036	2023/10/26	
Left Side	23790/710	10M QPSK(25,0)	0.013	0.009	-0.35	23.17	23.50	0.014	2023/10/26	
Right Side	23790/710	10M QPSK(25,0)	0.014	0.011	-1.64	23.17	23.50	0.015	2023/10/26	
Bottom Side	23790/710	10M QPSK(25,0)	0.028	0.023	-3.59	23.17	23.50	0.030	2023/10/26	

NOTE: Hotspot SAR test results of LTE Band 17

10.1.12. SAR measurement Result of LTE Band 41

Test Position of Head	Test channel /Freq.	Mode	SAR Value (W/kg)		Power Drift(%)	Conducted Power (dBm)	Tune-up Power (dBm)	Scaled SAR 1-g (W/Kg)	Date	Plot
			1-g	10-g						
1RB										
Left Cheek	40620/2593	20M QPSK(1,0)	0.171	0.097	-2.51	27.22	27.50	0.182	2023/10/29	29#
Left Tilt 15 Degree	40620/2593	20M QPSK(1,0)	0.094	0.053	1.05	27.22	27.50	0.100	2023/10/29	
Right Cheek	40620/2593	20M QPSK(1,0)	0.153	0.086	1.70	27.22	27.50	0.163	2023/10/29	

Right Tilt 15 Degree	40620/2593	20M QPSK(1,0)	0.082	0.045	2.91	27.22	27.50	0.087	2023/10/29	
50%RB										
Left Cheek	40620/2593	20M QPSK(50,24)	0.098	0.053	-4.36	26.63	27.50	0.120	2023/10/29	
Left Tilt 15 Degree	40620/2593	20M QPSK(50,24)	0.049	0.028	2.53	26.63	27.50	0.060	2023/10/29	
Right Cheek	40620/2593	20M QPSK(50,24)	0.080	0.045	2.40	26.63	27.50	0.098	2023/10/29	
Right Tilt 15 Degree	40620/2593	20M QPSK(50,24)	0.047	0.027	4.31	26.63	27.50	0.057	2023/10/29	

NOTE: Head SAR test results of LTE Band 41

Test Position of Body-Worn with 10mm	Test channel /Freq.	Mode	SAR Value (W/kg)		Power Drift(%)	Conducted Power (dBm)	Tune-up Power (dBm)	Scaled SAR 1-g (W/Kg)	Date	Plot
			1-g	10-g						
1RB										
Front Side	40620/2593	20M QPSK(1,0)	0.090	0.047	-3.42	27.22	27.50	0.096	2023/10/29	
Back Side	40620/2593	20M QPSK(1,0)	0.144	0.079	4.05	27.22	27.50	0.154	2023/10/29	30#
50%RB										
Front Side	40620/2593	20M QPSK(50,24)	0.052	0.024	-4.01	26.63	27.50	0.064	2023/10/29	
Back Side	40620/2593	20M QPSK(50,24)	0.083	0.045	-3.78	26.63	27.50	0.101	2023/10/29	

NOTE: Body-Worn SAR test results of LTE Band 41

Test Position of Hotspot with 10mm	Test channel /Freq.	Mode	SAR Value (W/kg)		Power Drift(%)	Conducted Power (dBm)	Tune-up Power (dBm)	Scaled SAR 1-g (W/Kg)	Date	Plot
			1-g	10-g						
1RB										
Front Side	40620/2593	20M QPSK(1,0)	0.090	0.047	-3.42	27.22	27.50	0.096	2023/10/29	
Back Side	40620/2593	20M QPSK(1,0)	0.144	0.079	4.05	27.22	27.50	0.154	2023/10/29	30#
Left	40620/2593	20M QPSK(1,0)	0.045	0.023	0.54	27.22	27.50	0.048	2023/10/29	

Side										
Right Side	40620/2593	20M QPSK(1,0)	0.057	0.031	2.33	27.22	27.50	0.061	2023/10/29	
Bottom Side	40620/2593	20M QPSK(1,0)	0.090	0.047	1.99	27.22	27.50	0.096	2023/10/29	
50%RB										
Front Side	40620/2593	20M QPSK(50,24)	0.052	0.024	-4.01	26.63	27.50	0.064	2023/10/29	
Back Side	40620/2593	20M QPSK(50,24)	0.083	0.045	-3.78	26.63	27.50	0.101	2023/10/29	
Left Side	40620/2593	20M QPSK(50,24)	0.025	0.013	4.93	26.63	27.50	0.031	2023/10/29	
Right Side	40620/2593	20M QPSK(50,24)	0.029	0.017	1.48	26.63	27.50	0.035	2023/10/29	
Bottom Side	40620/2593	20M QPSK(50,24)	0.048	0.025	3.08	26.63	27.50	0.059	2023/10/29	

NOTE: Hotspot SAR test results of LTE Band 41

10.1.13. SAR measurement Result of LTE Band 66

Test Position of Head	Test channel /Freq.	Mode	SAR Value (W/kg)		Power Drift(%)	Conducted Power (dBm)	Tune-up Power (dBm)	Scaled SAR 1-g (W/Kg)	Date	Plot
			1-g	10-g						
1RB										
Left Cheek	132322/1745	20M QPSK(1,0)	0.028	0.022	-2.92	23.18	23.50	0.030	2023/10/31	33#
Left Tilt 15 Degree	132322/1745	20M QPSK(1,0)	0.014	0.012	-1.24	23.18	23.50	0.015	2023/10/31	
Right Cheek	132322/1745	20M QPSK(1,0)	0.026	0.020	-2.94	23.18	23.50	0.028	2023/10/31	
Right Tilt 15 Degree	132322/1745	20M QPSK(1,0)	0.014	0.012	-2.40	23.18	23.50	0.015	2023/10/31	
50%RB										
Left Cheek	132322/1745	20M QPSK(50,49)	0.016	0.013	4.44	22.32	23.00	0.019	2023/10/31	
Left Tilt	132322/1745	20M QPSK(50,49)	0.008	0.007	-2.69	22.32	23.00	0.009	2023/10/31	

15 Degree										
Right Cheek	132322/1745	20M QPSK(50,49)	0.013	0.011	0.72	22.32	23.00	0.015	2023/10/31	
Right Tilt 15 Degree	132322/1745	20M QPSK(50,49)	0.008	0.006	-3.79	22.32	23.00	0.009	2023/10/31	

NOTE: Head SAR test results of LTE Band 66

Test Position of Body-Worn with 10mm	Test channel /Freq.	Mode	SAR Value (W/kg)		Power Drift(%)	Conducted Power (dBm)	Tune-up Power (dBm)	Scaled SAR 1-g (W/Kg)	Date	Plot
			1-g	10-g						
1RB										
Front Side	132322/1745	20M QPSK(1,0)	0.269	0.139	-2.73	23.18	23.50	0.290	2023/10/31	34#
Back Side	132322/1745	20M QPSK(1,0)	0.187	0.103	-0.84	23.18	23.50	0.201	2023/10/31	
50%RB										
Front Side	132322/1745	20M QPSK(50,49)	0.153	0.070	-4.60	22.32	23.00	0.179	2023/10/31	
Back Side	132322/1745	20M QPSK(50,49)	0.094	0.054	-1.08	22.32	23.00	0.110	2023/10/31	

NOTE: Body-Worn SAR test results of LTE Band 66

Test Position of Hotspot with 10mm	Test channel /Freq.	Mode	SAR Value (W/kg)		Power Drift(%)	Conducted Power (dBm)	Tune-up Power (dBm)	Scaled SAR 1-g (W/Kg)	Date	Plot
			1-g	10-g						
1RB										
Front Side	132322/1745	20M QPSK(1,0)	0.269	0.139	-2.73	23.18	23.50	0.290	2023/10/31	34#
Back Side	132322/1745	20M QPSK(1,0)	0.187	0.103	-0.84	23.18	23.50	0.201	2023/10/31	
Left Side	132322/1745	20M QPSK(1,0)	0.063	0.034	-1.29	23.18	23.50	0.068	2023/10/31	
Right Side	132322/1745	20M QPSK(1,0)	0.057	0.030	2.30	23.18	23.50	0.061	2023/10/31	
Bottom Side	132322/1745	20M QPSK(1,0)	0.115	0.063	-0.69	23.18	23.50	0.124	2023/10/31	
50%RB										
Front	132322/1745	20M	0.153	0.070	-4.60	22.32	23.00	0.179	2023/10/31	

Side		QPSK(50,49)								
Back Side	132322/1745	20M QPSK(50,49)	0.094	0.054	-1.08	22.32	23.00	0.110	2023/10/31	
Left Side	132322/1745	20M QPSK(50,49)	0.036	0.019	1.00	22.32	23.00	0.042	2023/10/31	
Right Side	132322/1745	20M QPSK(50,49)	0.031	0.017	1.13	22.32	23.00	0.036	2023/10/31	
Bottom Side	132322/1745	20M QPSK(50,49)	0.059	0.032	-1.44	22.32	23.00	0.069	2023/10/31	

NOTE: Hotspot SAR test results of LTE Band 66

10.1.14. SAR measurement Result of LTE Band 71

Test Position of Head	Test channel /Freq.	Mode	SAR Value (W/kg)		Power Drift(%)	Conducted Power (dBm)	Tune-up Power (dBm)	Scaled SAR 1-g (W/Kg)	Date	Plot
			1-g	10-g						
1RB										
Left Cheek	133322/683	20M QPSK(1,49)	0.195	0.150	3.02	24.20	24.50	0.209	2023/10/26	37#
Left Tilt 15 Degree	133322/683	20M QPSK(1,49)	0.123	0.097	0.10	24.20	24.50	0.132	2023/10/26	
Right Cheek	133322/683	20M QPSK(1,49)	0.182	0.142	2.13	24.20	24.50	0.195	2023/10/26	
Right Tilt 15 Degree	133322/683	20M QPSK(1,49)	0.099	0.080	1.50	24.20	24.50	0.106	2023/10/26	
50%RB										
Left Cheek	133322/683	20M QPSK(50,0)	0.119	0.100	0.56	23.32	23.50	0.124	2023/10/26	
Left Tilt 15 Degree	133322/683	20M QPSK(50,0)	0.111	0.086	-0.94	23.32	23.50	0.116	2023/10/26	
Right Cheek	133322/683	20M QPSK(50,0)	0.068	0.051	1.94	23.32	23.50	0.071	2023/10/26	
Right Tilt 15 Degree	133322/683	20M QPSK(50,0)	0.093	0.082	4.11	23.32	23.50	0.097	2023/10/26	

NOTE: Head SAR test results of LTE Band 71

Test Position of Body-Worn with 10mm	Test channel /Freq.	Mode	SAR Value (W/kg)		Power Drift(%)	Conducted Power (dBm)	Tune-up Power (dBm)	Scaled SAR 1-g (W/Kg)	Date	Plot
			1-g	10-g						
1RB										
Front Side	133322/683	20M QPSK(1,49)	0.234	0.176	0.08	24.20	24.50	0.251	2023/10/26	
Back Side	133322/683	20M QPSK(1,49)	0.348	0.262	2.10	24.20	24.50	0.373	2023/10/26	38#
50%RB										
Front Side	133322/683	20M QPSK(50,0)	0.123	0.096	-2.38	23.32	23.50	0.128	2023/10/26	
Back Side	133322/683	20M QPSK(50,0)	0.196	0.161	2.70	23.32	23.50	0.204	2023/10/26	

NOTE: Body-Worn SAR test results of LTE Band 71

Test Position of Hotspot with 10mm	Test channel /Freq.	Mode	SAR Value (W/kg)		Power Drift(%)	Conducted Power (dBm)	Tune-up Power (dBm)	Scaled SAR 1-g (W/Kg)	Date	Plot
			1-g	10-g						
1RB										
Front Side	133322/683	20M QPSK(1,49)	0.234	0.176	0.08	24.20	24.50	0.251	2023/10/26	
Back Side	133322/683	20M QPSK(1,49)	0.348	0.262	2.10	24.20	24.50	0.373	2023/10/26	38#
Left Side	133322/683	20M QPSK(1,49)	0.117	0.089	-0.42	24.20	24.50	0.125	2023/10/26	
Right Side	133322/683	20M QPSK(1,49)	0.114	0.088	-3.14	24.20	24.50	0.122	2023/10/26	
Bottom Side	133322/683	20M QPSK(1,49)	0.185	0.148	-2.29	24.20	24.50	0.198	2023/10/26	
50%RB										
Front Side	133322/683	20M QPSK(50,0)	0.123	0.096	-2.38	23.32	23.50	0.128	2023/10/26	
Back Side	133322/683	20M QPSK(50,0)	0.196	0.161	2.70	23.32	23.50	0.204	2023/10/26	
Left Side	133322/683	20M QPSK(50,0)	0.062	0.050	-0.78	23.32	23.50	0.065	2023/10/26	
Right Side	133322/683	20M QPSK(50,0)	0.067	0.048	0.39	23.32	23.50	0.070	2023/10/26	
Bottom	133322/683	20M	0.100	0.085	-4.84	23.32	23.50	0.104	2023/10/26	

Side		QPSK(50,0)								
------	--	------------	--	--	--	--	--	--	--	--

NOTE: Hotspot SAR test results of LTE Band 71

10.1.15. SAR measurement Result of NR n41

Test Position of Head	Test channel /Freq.	Mode	SAR Value (W/kg)		Power Drift(%)	Conducted Power (dBm)	Tune-up Power (dBm)	Scaled SAR 1-g (W/Kg)	Date	Plot
			1-g	10-g						
Left Cheek	518598/2592.99	100M QPSK(1,1)	0.349	0.172	0.87	20.64	21.00	0.379	2023/10/29	31#
Left Tilt 15 Degree	518598/2592.99	100M QPSK(1,1)	0.206	0.096	-2.47	20.64	21.00	0.224	2023/10/29	
Right Cheek	518598/2592.99	100M QPSK(1,1)	0.307	0.151	1.62	20.64	21.00	0.334	2023/10/29	
Right Tilt 15 Degree	518598/2592.99	100M QPSK(1,1)	0.144	0.069	-0.70	20.64	21.00	0.156	2023/10/29	

NOTE: Head SAR test results of NR n41

Test Position of Body-Worn with 10mm	Test channel /Freq.	Mode	SAR Value (W/kg)		Power Drift(%)	Conducted Power (dBm)	Tune-up Power (dBm)	Scaled SAR 1-g (W/Kg)	Date	Plot
			1-g	10-g						
Front Side	518598/2592.99	100M QPSK(1,1)	0.120	0.068	-1.65	20.64	21.00	0.130	2023/10/29	
Back Side	518598/2592.99	100M QPSK(1,1)	0.184	0.104	-0.61	20.64	21.00	0.200	2023/10/29	32#

NOTE: Body-Worn SAR test results of NR n41

Test Position of Hotspot with 10mm	Test channel /Freq.	Mode	SAR Value (W/kg)		Power Drift(%)	Conducted Power (dBm)	Tune-up Power (dBm)	Scaled SAR 1-g (W/Kg)	Date	Plot
			1-g	10-g						
Front Side	518598/2592.99	100M QPSK(1,1)	0.120	0.068	-1.65	20.64	21.00	0.130	2023/10/29	
Back Side	518598/2592.99	100M QPSK(1,1)	0.184	0.104	-0.61	20.64	21.00	0.200	2023/10/29	32#

Left Side	518598/2592.99	100M QPSK(1,1)	0.066	0.037	-2.22	20.64	21.00	0.072	2023/10/29	
Right Side	518598/2592.99	100M QPSK(1,1)	0.060	0.033	3.70	20.64	21.00	0.065	2023/10/29	
Bottom Side	518598/2592.99	100M QPSK(1,1)	0.100	0.054	-0.18	20.64	21.00	0.109	2023/10/29	

NOTE: Hotspot SAR test results of NR n41

10.1.16. SAR measurement Result of NR n78

Test Position of Head	Test channel /Freq.	Mode	SAR Value (W/kg)		Power Drift(%)	Conducted Power (dBm)	Tune-up Power (dBm)	Scaled SAR 1-g (W/Kg)	Date	Plot
			1-g	10-g						
Left Cheek	633333/3500.00	100M QPSK(1,1)	0.310	0.154	2.45	23.11	24.00	0.381	2023/10/19	35#
Left Tilt 15 Degree	633333/3500.00	100M QPSK(1,1)	0.158	0.075	-1.45	23.11	24.00	0.194	2023/10/19	
Right Cheek	633333/3500.00	100M QPSK(1,1)	0.265	0.129	0.97	23.11	24.00	0.325	2023/10/19	
Right Tilt 15 Degree	633333/3500.00	100M QPSK(1,1)	0.126	0.063	-3.16	23.11	24.00	0.155	2023/10/19	

NOTE: Head SAR test results of NR n78

Test Position of Body-Worn with 10mm	Test channel /Freq.	Mode	SAR Value (W/kg)		Power Drift(%)	Conducted Power (dBm)	Tune-up Power (dBm)	Scaled SAR 1-g (W/Kg)	Date	Plot
			1-g	10-g						
Front Side	633333/3500.00	100M QPSK(1,1)	0.144	0.077	0.65	23.11	24.00	0.177	2023/10/19	
Back Side	633333/3500.00	100M QPSK(1,1)	0.234	0.125	-1.04	23.11	24.00	0.287	2023/10/19	36#

NOTE: Body-Worn SAR test results of NR n78

Test Position of Hotspot with	Test channel /Freq.	Mode	SAR Value (W/kg)		Power Drift(%)	Conducted Power (dBm)	Tune-up Power (dBm)	Scaled SAR 1-g (W/Kg)	Date	Plot
			1-g	10-g						

10mm										
Front Side	633333/3500.00	100M QPSK(1,1)	0.144	0.077	0.65	23.11	24.00	0.177	2023/10/19	
Back Side	633333/3500.00	100M QPSK(1,1)	0.234	0.125	-1.04	23.11	24.00	0.287	2023/10/19	36#
Left Side	633333/3500.00	100M QPSK(1,1)	0.072	0.037	1.76	23.11	24.00	0.088	2023/10/19	
Right Side	633333/3500.00	100M QPSK(1,1)	0.078	0.041	-0.16	23.11	24.00	0.096	2023/10/19	
Bottom Side	633333/3500.00	100M QPSK(1,1)	0.140	0.073	-1.31	23.11	24.00	0.172	2023/10/19	

NOTE: Hotspot SAR test results of NR n78

10.1.17. SAR measurement Result of WLAN2.4G

Test Position of Head	Test channel /Freq.	Mode	SAR Value (W/kg)		Power Drift(%)	Conducted Power (dBm)	Tune-up Power (dBm)	Scaled SAR 1-g (W/Kg)	Date	Plot
			1-g	10-g						
Left Cheek	1/2412	802.11b	0.280	0.134	0.07	16.53	17.00	0.312	2023/10/28	15#
Left Tilt 15 Degree	1/2412	802.11b	0.142	0.065	3.21	16.53	17.00	0.158	2023/10/28	
Right Cheek	1/2412	802.11b	0.241	0.112	-2.99	16.53	17.00	0.269	2023/10/28	
Right Tilt 15 Degree	1/2412	802.11b	0.124	0.057	1.40	16.53	17.00	0.138	2023/10/28	

NOTE: Head SAR test results of WLAN2.4G

Test Position of Body-Worn with 10mm	Test channel /Freq.	Mode	SAR Value (W/kg)		Power Drift(%)	Conducted Power (dBm)	Tune-up Power (dBm)	Scaled SAR 1-g (W/Kg)	Date	Plot
			1-g	10-g						
Front Side	1/2412	802.11b	0.048	0.031	1.32	16.53	17.00	0.053	2023/10/28	
Back Side	1/2412	802.11b	0.070	0.046	-3.50	16.53	17.00	0.078	2023/10/28	16#

NOTE: Body-worn SAR test results of WLAN2.4G

Test	Test	Mode	SAR Value	Power	Conducted	Tune-up	Scaled	Date	Plot
------	------	------	-----------	-------	-----------	---------	--------	------	------

Position of Hotspot with 10mm	channel /Freq.		(W/kg)		Drift(%)	Power (dBm)	Power (dBm)	SAR 1-g (W/Kg)		
			1-g	10-g						
Front Side	1/2412	802.11b	0.048	0.031	1.32	16.53	17.00	0.053	2023/10/28	
Back Side	1/2412	802.11b	0.070	0.046	-3.50	16.53	17.00	0.078	2023/10/28	16#
Right Side	1/2412	802.11b	0.027	0.017	-2.24	16.53	17.00	0.030	2023/10/28	
Top Side	1/2412	802.11b	0.036	0.023	-3.08	16.53	17.00	0.040	2023/10/28	

NOTE: Hotspot SAR test results of WLAN2.4G

10.1.18. SAR measurement Result of WLAN5.2G

Test Position of Head	Test channel /Freq.	Mode	SAR Value (W/kg)		Power Drift(%)	Conducted Power (dBm)	Tune-up Power (dBm)	Scaled SAR 1-g (W/Kg)	Date	Plot
			1-g	10-g						
Left Cheek	40/5200	ax20	0.532	0.200	-0.68	12.75	13.00	0.564	2023/10/21	11#
Left Tilt 15 Degree	40/5200	ax20	0.288	0.103	-1.13	12.75	13.00	0.305	2023/10/21	
Right Cheek	40/5200	ax20	0.464	0.173	3.82	12.75	13.00	0.491	2023/10/21	
Right Tilt 15 Degree	40/5200	ax20	0.249	0.092	0.80	12.75	13.00	0.264	2023/10/21	

NOTE: Head SAR test results of WLAN5.2G

Test Position of Body-Worn with 10mm	Test channel /Freq.	Mode	SAR Value (W/kg)		Power Drift(%)	Conducted Power (dBm)	Tune-up Power (dBm)	Scaled SAR 1-g (W/Kg)	Date	Plot
			1-g	10-g						
Front Side	40/5200	ax20	0.048	0.038	3.61	12.75	13.00	0.051	2023/10/21	
Back Side	40/5200	ax20	0.077	0.063	2.75	12.75	13.00	0.082	2023/10/21	13#

NOTE: Body-worn SAR test results of WLAN5.2G

Test Position of Hotspot with 10mm	Test channel /Freq.	Mode	SAR Value (W/kg)		Power Drift(%)	Conducted Power (dBm)	Tune-up Power (dBm)	Scaled SAR 1-g (W/Kg)	Date	Plot
			1-g	10-g						
Front Side	40/5200	ax20	0.048	0.038	3.61	12.75	13.00	0.051	2023/10/21	
Back Side	40/5200	ax20	0.077	0.063	2.75	12.75	13.00	0.082	2023/10/21	13#
Right Side	40/5200	ax20	0.027	0.021	-0.96	12.75	13.00	0.029	2023/10/21	
Top Side	40/5200	ax20	0.024	0.019	-2.93	12.75	13.00	0.025	2023/10/21	

NOTE: Hotspot SAR test results of WLAN5.2G

10.1.19. SAR measurement Result of WLAN5.8G

Test Position of Head	Test channel /Freq.	Mode	SAR Value (W/kg)		Power Drift(%)	Conducted Power (dBm)	Tune-up Power (dBm)	Scaled SAR 1-g (W/Kg)	Date	Plot
			1-g	10-g						
Left Cheek	165/5825	802.11a	0.174	0.106	-3.63	13.36	13.50	0.180	2023/10/22	12#
Left Tilt 15 Degree	165/5825	802.11a	0.103	0.062	-1.80	13.36	13.50	0.106	2023/10/22	
Right Cheek	165/5825	802.11a	0.159	0.097	2.40	13.36	13.50	0.164	2023/10/22	
Right Tilt 15 Degree	165/5825	802.11a	0.087	0.052	1.00	13.36	13.50	0.090	2023/10/22	

NOTE: Head SAR test results of WLAN5.8G

Test Position of Body-Worn with 10mm	Test channel /Freq.	Mode	SAR Value (W/kg)		Power Drift(%)	Conducted Power (dBm)	Tune-up Power (dBm)	Scaled SAR 1-g (W/Kg)	Date	Plot
			1-g	10-g						
Front Side	165/5825	802.11a	0.054	0.047	-1.96	13.36	13.50	0.056	2023/10/22	

Back Side	165/5825	802.11a	0.075	0.068	-4.28	13.36	13.50	0.077	2023/10/22	14#
-----------	----------	---------	-------	-------	-------	-------	-------	-------	------------	-----

NOTE: Body-worn SAR test results of WLAN5.8G

Test Position of Hotspot with 10mm	Test channel /Freq.	Mode	SAR Value (W/kg)		Power Drift(%)	Conducted Power (dBm)	Tune-up Power (dBm)	Scaled SAR 1-g (W/Kg)	Date	Plot
			1-g	10-g						
Front Side	165/5825	802.11a	0.054	0.047	-1.96	13.36	13.50	0.056	2023/10/22	
Back Side	165/5825	802.11a	0.075	0.068	-4.28	13.36	13.50	0.077	2023/10/22	14#
Right Side	165/5825	802.11a	0.024	0.021	3.12	13.36	13.50	0.025	2023/10/22	
Top Side	165/5825	802.11a	0.033	0.029	1.15	13.36	13.50	0.034	2023/10/22	

NOTE: Hotspot SAR test results of WLAN5.8G

10.2. Simultaneous Transmission Analysis

Per KDB 447498 D01, simultaneous transmission SAR is compliant if,

- 1) Scalar SAR summation < 1.6W/kg.
- 2) $SPLSR = (SAR_1 + SAR_2)^{1.5} / (\text{min. separation distance, mm})$, and the peak separation distance is determined from the square root of $[(x_1-x_2)^2 + (y_1-y_2)^2 + (z_1-z_2)^2]$, where (x_1, y_1, z_1) and (x_2, y_2, z_2) are the coordinates of the extrapolated peak SAR locations in the zoom scan. If $SPLSR \leq 0.04$, simultaneously transmission SAR measurement is not necessary.

Test Position		Scaled SAR _{MAX}		Σ 1-g SAR (W/Kg)	SPLSR	Remark
		WWAN	WIFI/ Bluetooth			
Head	Left Cheek	0.209	0.564	0.773	N/A	N/A
	Left Tilt 15 Degree	0.132	0.305	0.437	N/A	N/A
	Right Cheek	0.195	0.491	0.686	N/A	N/A
	Right Tilt 15 Degree	0.106	0.264	0.370	N/A	N/A

Body-Worn	Front Side	0.372	0.094	0.466	N/A	N/A
	Back Side	0.400	0.094	0.494	N/A	N/A
Hotspot	Front Side	0.372	0.094	0.466	N/A	N/A
	Back Side	0.400	0.094	0.494	N/A	N/A
	Left Side	0.128	N/A	0.128	N/A	N/A
	Right Side	0.139	0.094	0.233	N/A	N/A
	Top Side	N/A	0.094	0.094	N/A	N/A
	Bottom Side	0.200	N/A	0.200	N/A	N/A

Test Position		Scaled SAR _{MAX}			Σ 1-g SAR (W/Kg)	SPLSR	Remark
		LTE Band 5	NR NSA n78	WIFI/ Bluetooth			
Head	Left Cheek	0.069	0.381	0.564	1.014	N/A	N/A
	Left Tilt 15 Degree	0.040	0.194	0.305	0.539	N/A	N/A
	Right Cheek	0.061	0.325	0.491	0.877	N/A	N/A
	Right Tilt 15 Degree	0.030	0.155	0.264	0.449	N/A	N/A
Body-Worn	Front Side	0.240	0.177	0.094	0.511	N/A	N/A
	Back Side	0.150	0.287	0.094	0.531	N/A	N/A
Hotspot	Front Side	0.240	0.177	0.094	0.511	N/A	N/A
	Back Side	0.150	0.287	0.094	0.531	N/A	N/A
	Left Side	0.059	0.088	N/A	0.147	N/A	N/A
	Right Side	0.047	0.096	0.094	0.237	N/A	N/A
	Top Side	N/A	N/A	0.094	0.094	N/A	N/A
	Bottom Side	0.078	0.172	N/A	0.250	N/A	N/A

Test Position		Scaled SAR _{MAX}		Σ 1-g SAR (W/Kg)	SPLSR	Remark
		NTN	WIFI/ Bluetooth			
Body-Worn	Front Side	0.309	0.094	0.403	N/A	N/A
	Back Side	0.281	0.094	0.375	N/A	N/A

NOTE:NTN's SAR data comes from SPORTON LAB, report number FA391513.

Test Position	Scaled SAR _{MAX}	Σ 10-g SAR	SPLSR	Remark
---------------	---------------------------	------------	-------	--------

		NTN	WIFI/ Bluetooth	(W/Kg)		
Body	Front Side	0.693	0.075	0.768	N/A	N/A
	Back Side	0.320	0.075	0.395	N/A	N/A
	Left Side	0.095	N/A	0.095	N/A	N/A
	Right Side	0.161	0.075	0.236	N/A	N/A
	Top Side	0.854	0.075	0.929	N/A	N/A
	Bottom Side	N/A	N/A	N/A	N/A	N/A

NOTE:NTN's SAR data comes from SPORTON LAB, report number FA391513.

1. Appendix A. Photo documentation

Refer to appendix Test Setup photo---SAR

2. Appendix B. System Check Plots

Table of contents
MEASUREMENT 1 System Performance Check - 750MHz
MEASUREMENT 2 System Performance Check - 835MHz
MEASUREMENT 3 System Performance Check - 1800MHz
MEASUREMENT 4 System Performance Check - 1900MHz
MEASUREMENT 5 System Performance Check - 2450MHz
MEASUREMENT 6 System Performance Check - 2600MHz
MEASUREMENT 7 System Performance Check - 3500MHz
MEASUREMENT 8 System Performance Check - 5200MHz
MEASUREMENT 9 System Performance Check - 5800MHz

MEASUREMENT 1

Date of measurement: 26/10/2023

A. Experimental conditions.

Area Scan	<u>dx=15mm dy=15mm, h= 5.00 mm</u>
ZoomScan	<u>5x5x7,dx=8mm dy=8mm dz=5mm</u>
Phantom	<u>Validation plane</u>
Device Position	<u>Dipole</u>
Band	<u>CW750</u>
Channels	<u>Middle</u>
Signal	<u>CW (Crest factor: 1.0)</u>
ConvF	<u>2.37</u>

B. SAR Measurement Results

Frequency (MHz)	750.000000
Relative permittivity (real part)	42.327147
Relative permittivity (imaginary part)	22.234427
Conductivity (S/m)	0.926434
Variation (%)	-2.160000

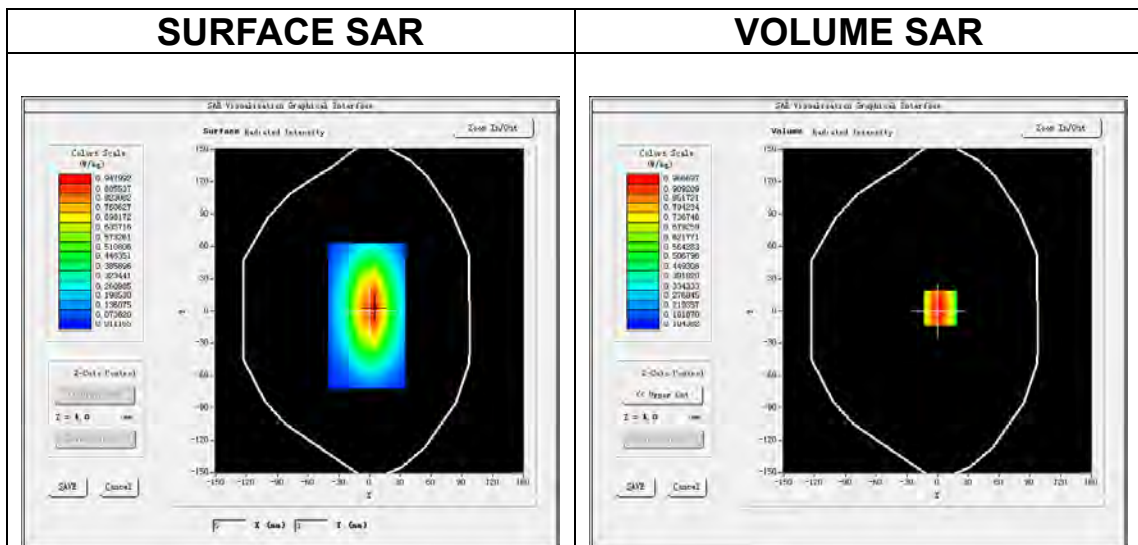

Maximum location: X=3.00, Y=3.00

SAR Peak: 1.30 W/kg

SAR 10g (W/Kg)	0.525318
SAR 1g (W/Kg)	0.917339

Z (mm)	0.00	4.00	9.00	14.00	19.00	24.00	29.00
SAR (W/Kg)	1.2959	0.9671	0.6766	0.4895	0.3453	0.2548	0.1896

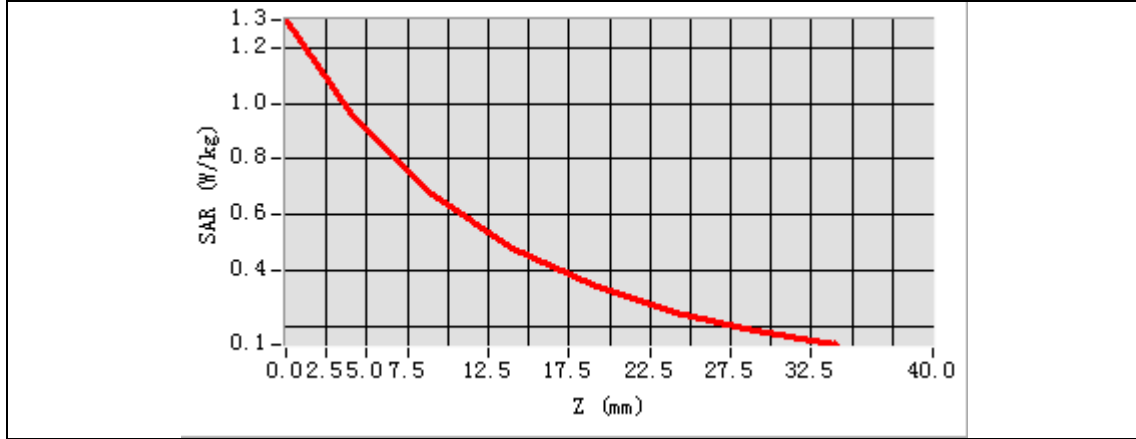

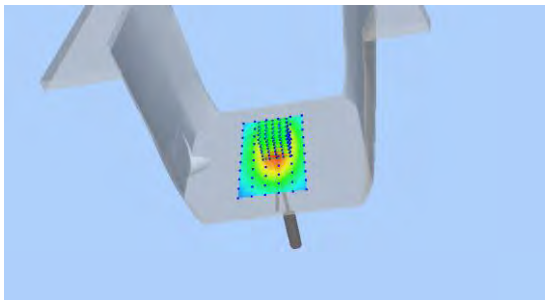
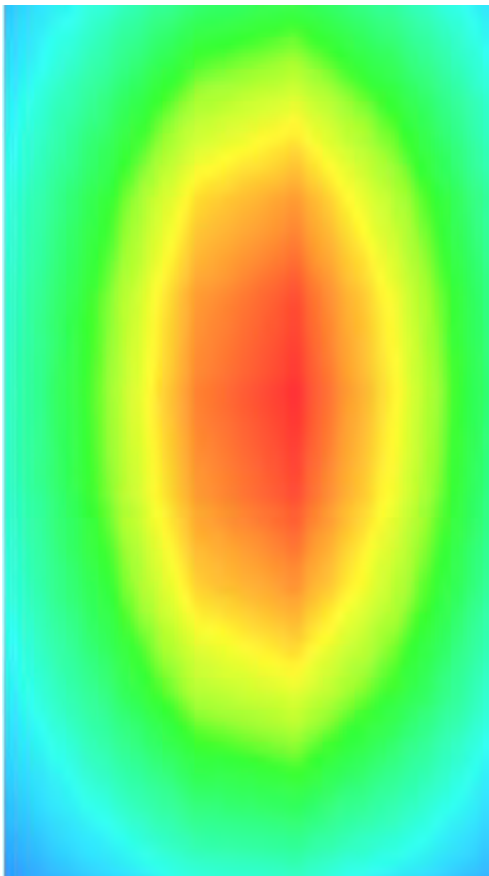
3D screen shot	Hot spot position
	

MEASUREMENT 2

Date of measurement: 23/10/2023

A. Experimental conditions.

Area Scan	<u>dx=15mm dy=15mm, h= 5.00 mm</u>
ZoomScan	<u>5x5x7, dx=8mm dy=8mm dz=5mm</u>
Phantom	<u>Validation plane</u>
Device Position	<u>Dipole</u>
Band	<u>CW835</u>
Channels	<u>Middle</u>
Signal	<u>CW (Crest factor: 1.0)</u>
ConvF	<u>2.32</u>

B. SAR Measurement Results

Frequency (MHz)	835.000000
Relative permittivity (real part)	41.553037
Relative permittivity (imaginary part)	19.421296
Conductivity (S/m)	0.900932
Variation (%)	-0.780000

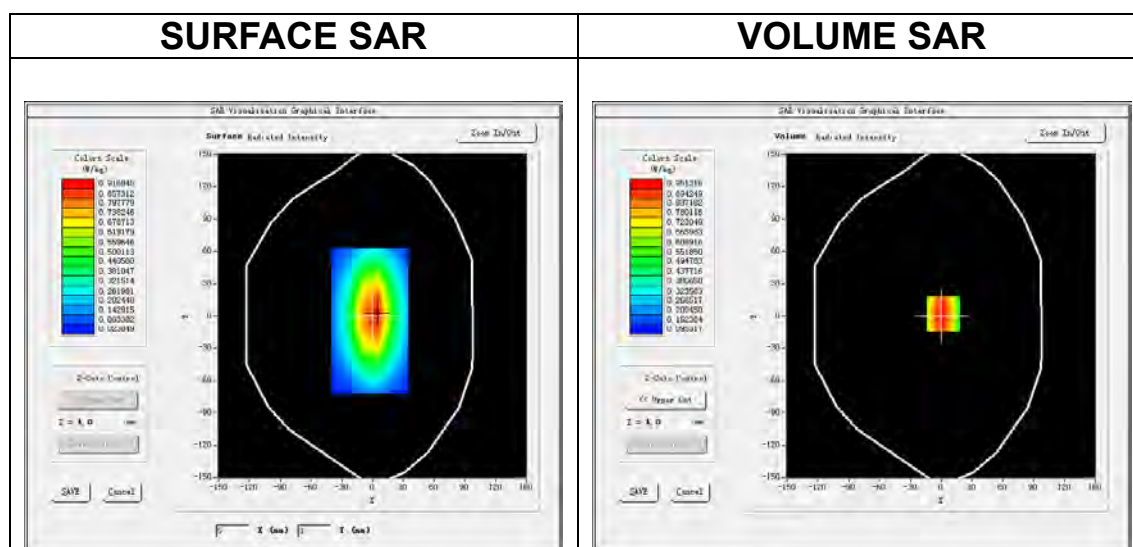

Maximum location: X=2.00, Y=2.00

SAR Peak: 1.29 W/kg

SAR 10g (W/Kg)	0.572115
SAR 1g (W/Kg)	0.995057

Z (mm)	0.00	4.00	9.00	14.00	19.00	24.00	29.00
SAR (W/Kg)	1.2865	0.9534	0.6576	0.4550	0.3268	0.2334	0.1795

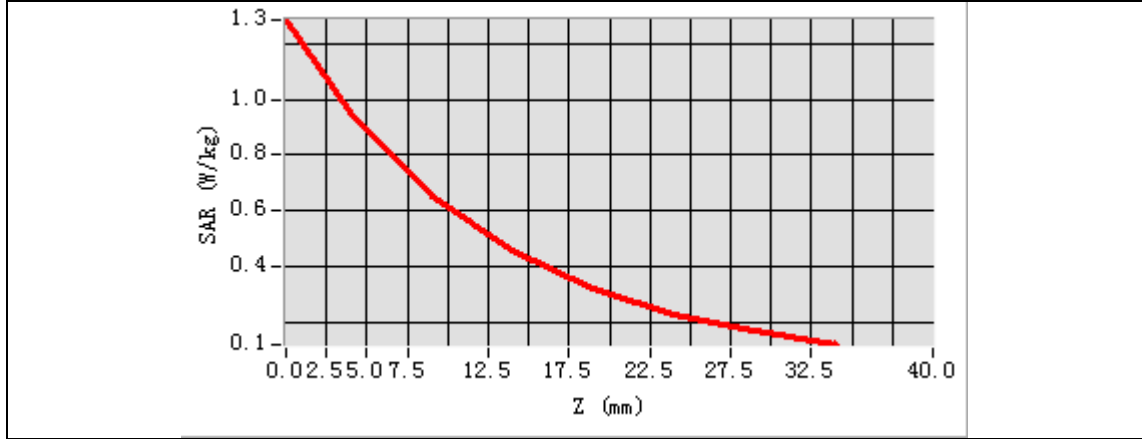

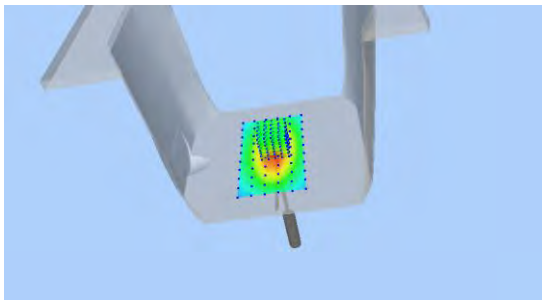
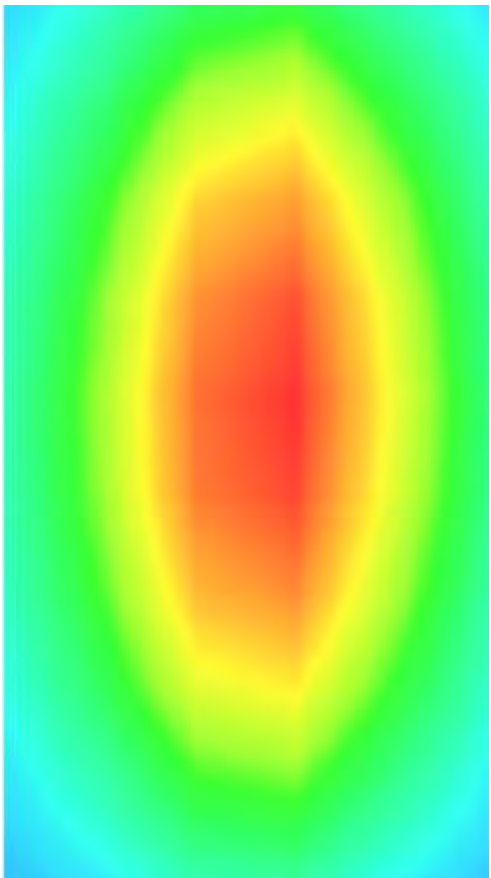
3D screen shot	Hot spot position
	

MEASUREMENT 3

Date of measurement: 31/10/2023

A. Experimental conditions.

Area Scan	<u>dx=15mm dy=15mm, h= 5.00 mm</u>
ZoomScan	<u>5x5x7, dx=8mm dy=8mm dz=5mm</u>
Phantom	<u>Validation plane</u>
Device Position	<u>Dipole</u>
Band	<u>CW1800</u>
Channels	<u>Middle</u>
Signal	<u>CW (Crest factor: 1.0)</u>
ConvF	<u>2.45</u>

B. SAR Measurement Results

Frequency (MHz)	1800.000000
Relative permittivity (real part)	40.056022
Relative permittivity (imaginary part)	14.318645
Conductivity (S/m)	1.431865
Variation (%)	-3.570000

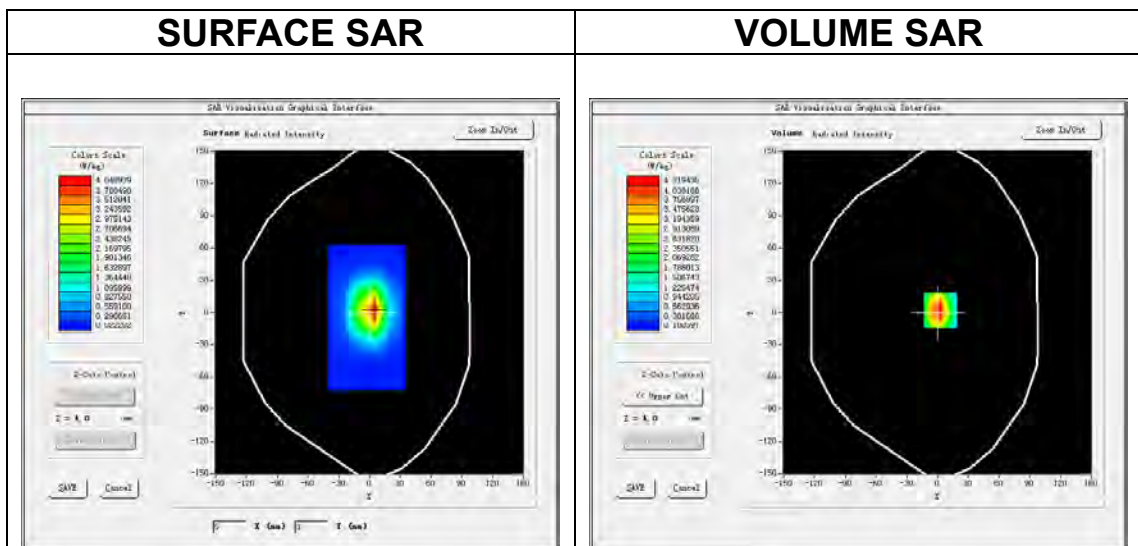

Maximum location: X=3.00, Y=2.00
SAR Peak: 6.82 W/kg

SAR 10g (W/Kg)	1.926138
SAR 1g (W/Kg)	3.542120

Z (mm)	0.00	4.00	9.00	14.00	19.00	24.00	29.00
SAR (W/Kg)	6.7454	4.3152	2.4363	1.4268	0.8532	0.5218	0.3235

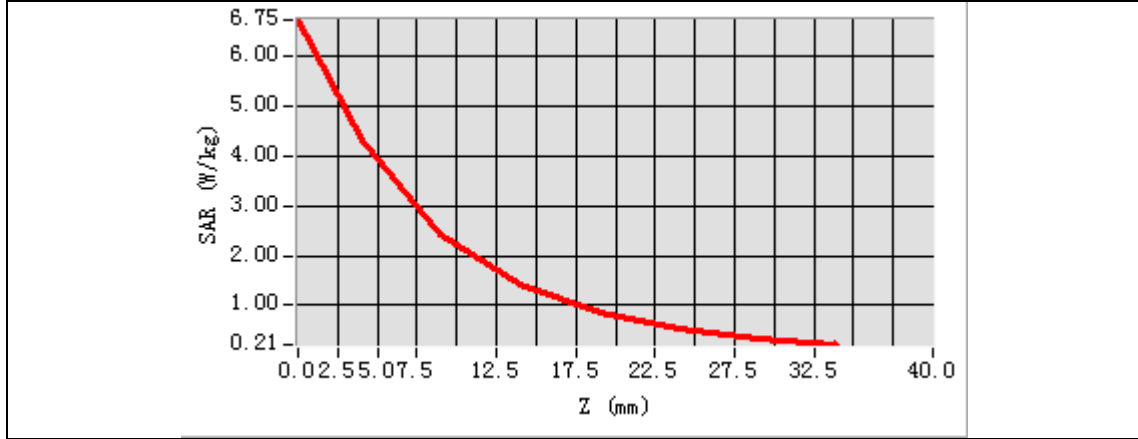

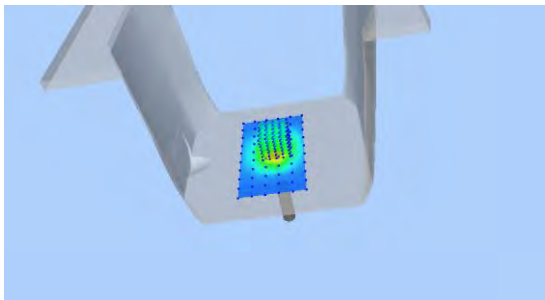
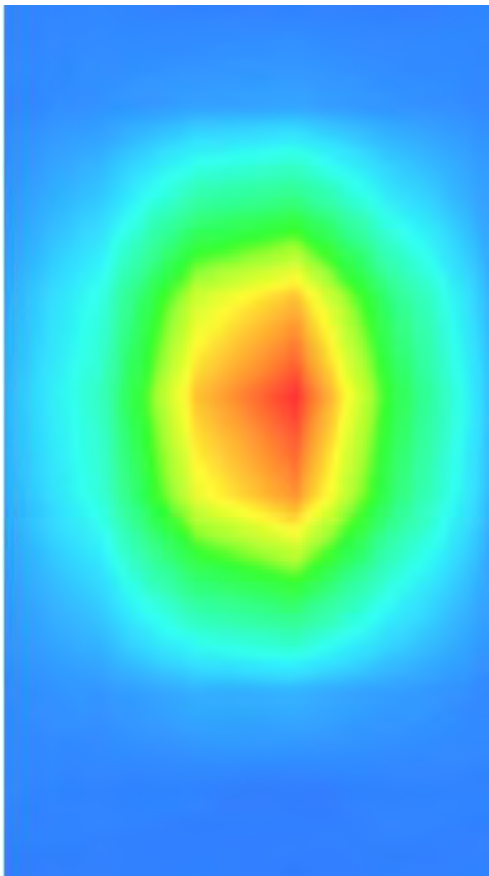
3D screen shot	Hot spot position
	

MEASUREMENT 4

Date of measurement: 24/10/2023

A. Experimental conditions.

Area Scan	<u>dx=15mm dy=15mm, h= 5.00 mm</u>
ZoomScan	<u>5x5x7, dx=8mm dy=8mm dz=5mm</u>
Phantom	<u>Validation plane</u>
Device Position	<u>Dipole</u>
Band	<u>CW1900</u>
Channels	<u>Middle</u>
Signal	<u>CW (Crest factor: 1.0)</u>
ConvF	<u>2.63</u>

B. SAR Measurement Results

Frequency (MHz)	1900.000000
Relative permittivity (real part)	39.022879
Relative permittivity (imaginary part)	13.628442
Conductivity (S/m)	1.438558
Variation (%)	-1.560000

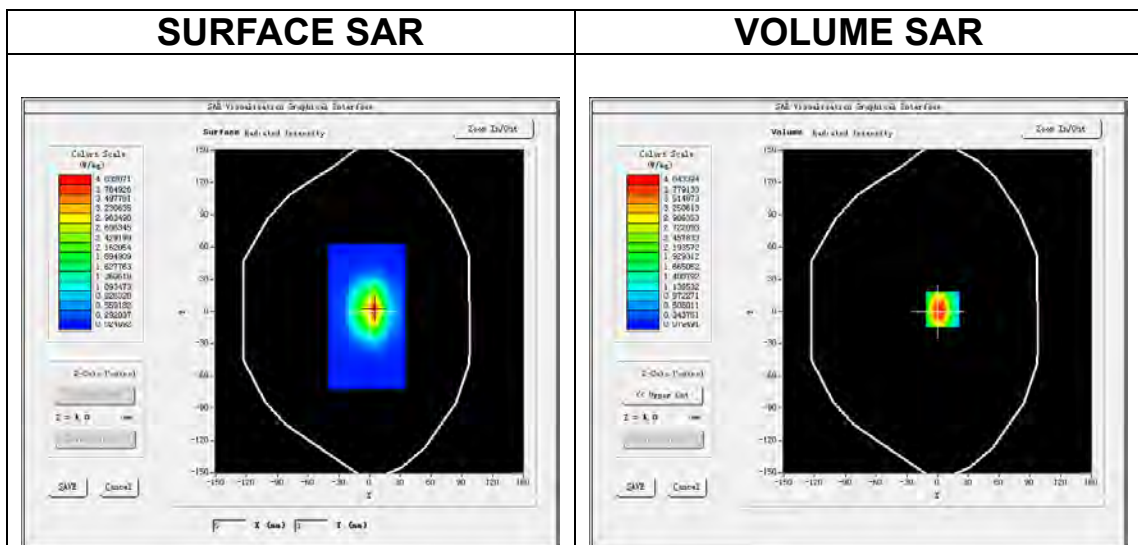

Maximum location: X=5.00, Y=2.00
SAR Peak: 6.70 W/kg

SAR 10g (W/Kg)	2.184012
SAR 1g (W/Kg)	4.029167

Z (mm)	0.00	4.00	9.00	14.00	19.00	24.00	29.00
SAR (W/Kg)	6.3290	4.0491	2.2626	1.3016	0.7652	0.4516	0.2711

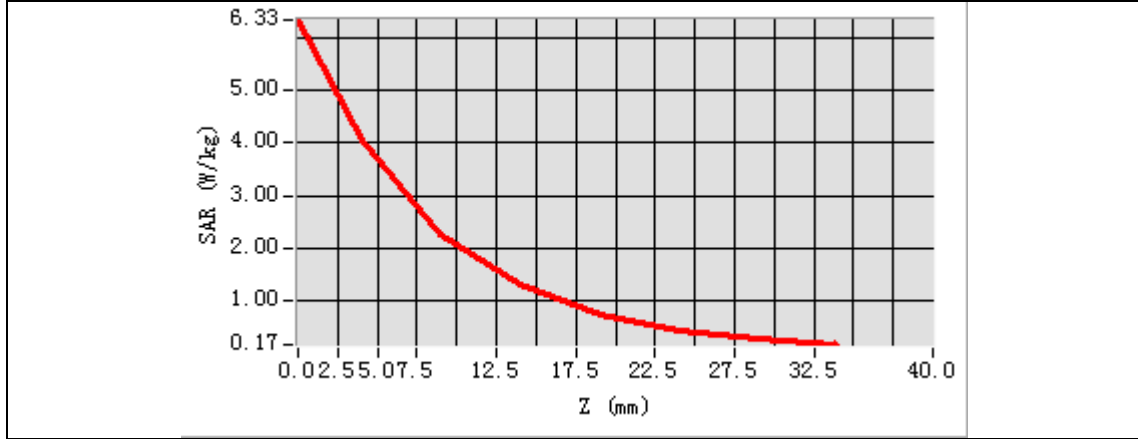

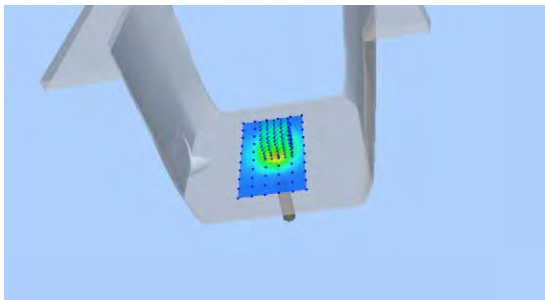
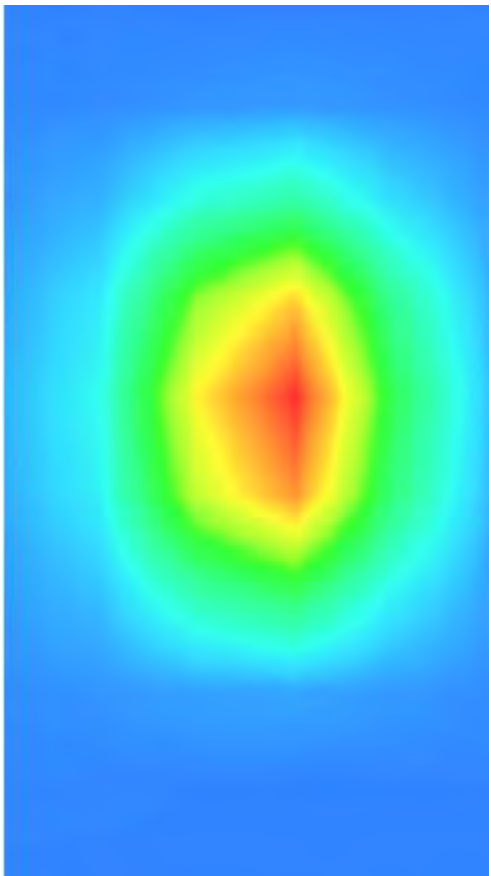
3D screen shot	Hot spot position
	

MEASUREMENT 5

Date of measurement: 28/10/2023

A. Experimental conditions.

<u>Area Scan</u>	<u>dx=12mm dy=12mm, h= 5.00 mm</u>
<u>ZoomScan</u>	<u>7x7x7,dx=5mm dy=5mm dz=5mm</u>
<u>Phantom</u>	<u>Validation plane</u>
<u>Device Position</u>	<u>Dipole</u>
<u>Band</u>	<u>CW2450</u>
<u>Channels</u>	<u>Middle</u>
<u>Signal</u>	<u>CW (Crest factor: 1.0)</u>
<u>ConvF</u>	<u>2.85</u>

B. SAR Measurement Results

Frequency (MHz)	2450.000000
Relative permittivity (real part)	38.728633
Relative permittivity (imaginary part)	13.215610
Conductivity (S/m)	1.798791
Variation (%)	-0.280000

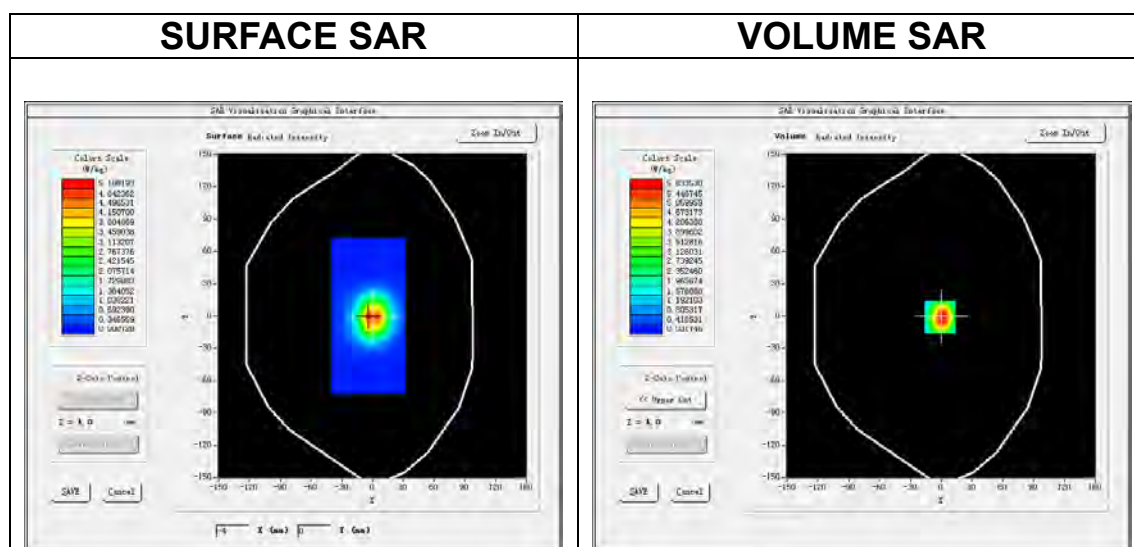

Maximum location: X=-1.00, Y=-1.00

SAR Peak: 9.83 W/kg

SAR 10g (W/Kg)	2.205331
SAR 1g (W/Kg)	5.339268

Z (mm)	0.00	4.00	9.00	14.00	19.00	24.00	29.00
SAR (W/Kg)	9.7137	5.8394	2.9217	1.4611	0.7462	0.3784	0.1917

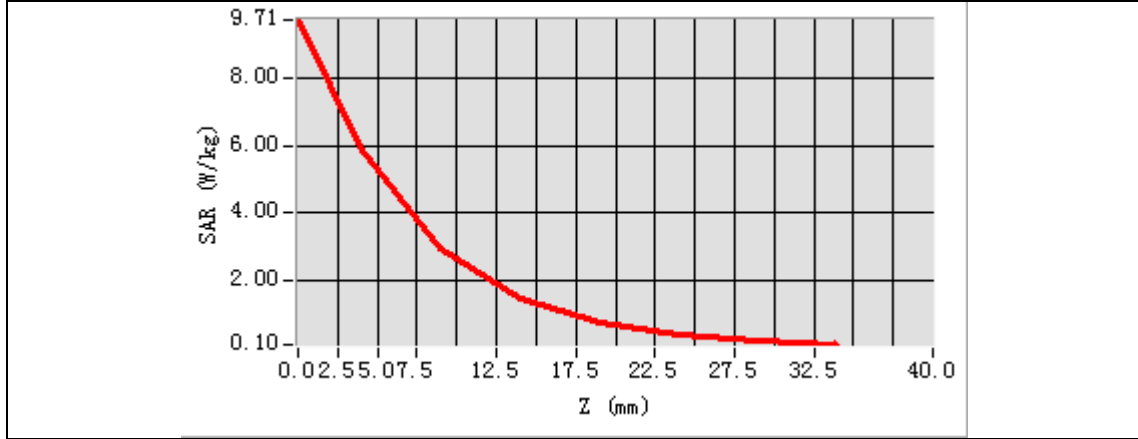

3D screen shot	Hot spot position

MEASUREMENT 6

Date of measurement: 29/10/2023

A. Experimental conditions.

Area Scan	<u>dx=12mm dy=12mm, h= 5.00 mm</u>
ZoomScan	<u>7x7x7,dx=5mm dy=5mm dz=5mm</u>
Phantom	<u>Validation plane</u>
Device Position	<u>Dipole</u>
Band	<u>CW2600</u>
Channels	<u>Middle</u>
Signal	<u>CW (Crest factor: 1.0)</u>
ConvF	<u>2.65</u>

B. SAR Measurement Results

Frequency (MHz)	2600.000000
Relative permittivity (real part)	38.574072
Relative permittivity (imaginary part)	13.237614
Conductivity (S/m)	1.912100
Variation (%)	2.500000

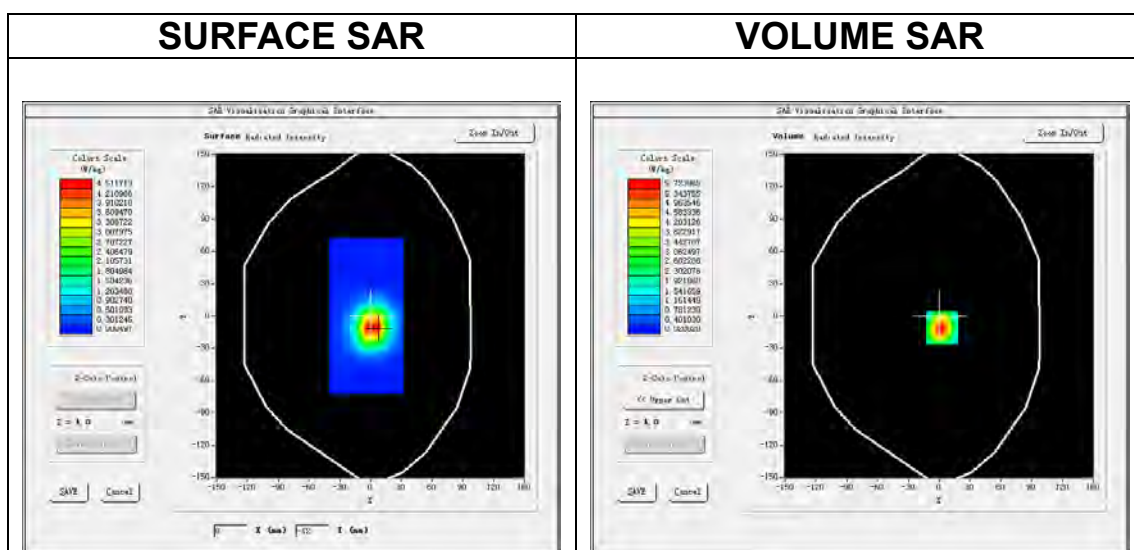

Maximum location: X=3.00, Y=-11.00

SAR Peak: 10.29 W/kg

SAR 10g (W/Kg)	2.497105
SAR 1g (W/Kg)	5.968294

Z (mm)	0.00	4.00	9.00	14.00	19.00	24.00	29.00
SAR (W/Kg)	10.328	5.7281	2.5000	1.1722	0.5705	0.2642	0.1260

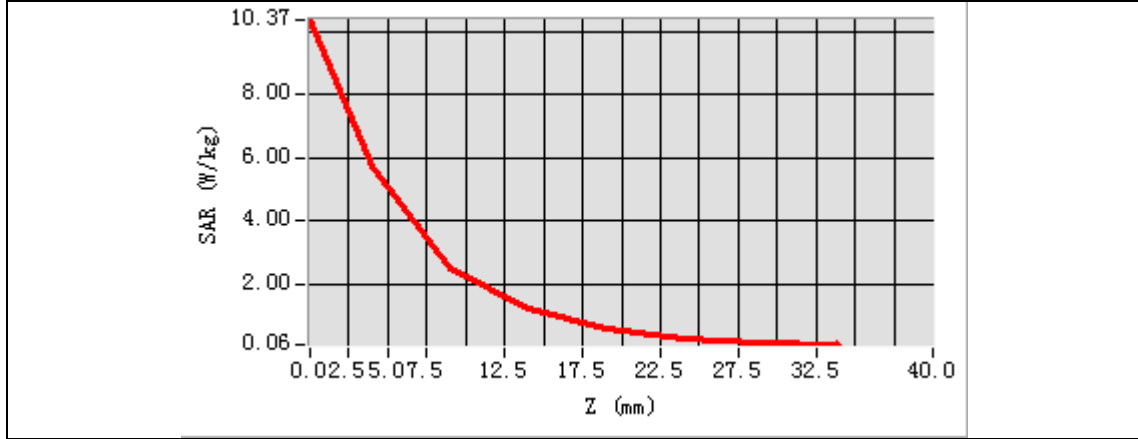

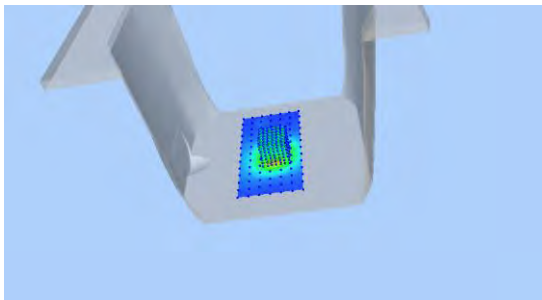
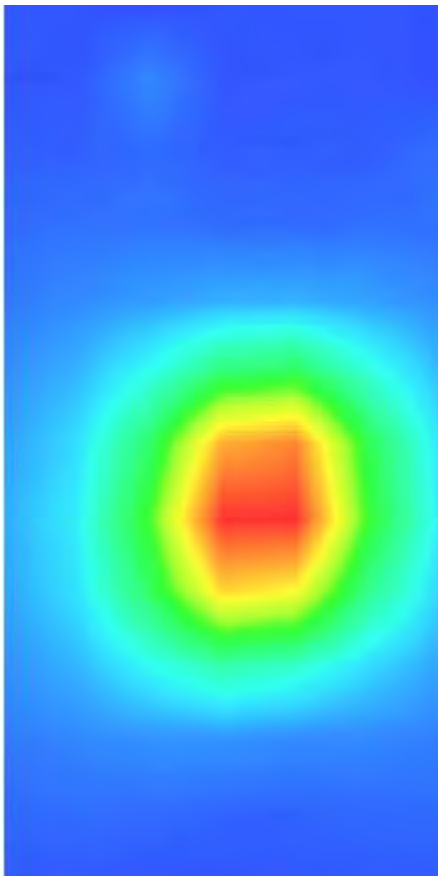
3D screen shot	Hot spot position
	

MEASUREMENT 7

Date of measurement: 19/10/2022

A. Experimental conditions.

Area Scan	<u>dx=12mm dy=12mm, h= 5.00 mm</u>
ZoomScan	<u>7x7x7,dx=5mm dy=5mm dz=5mm</u>
Phantom	<u>Validation plane</u>
Device Position	<u>Dipole</u>
Band	<u>CW3500</u>
Channels	<u>Middle</u>
Signal	<u>CW (Crest factor: 1.0)</u>
ConvF	<u>1.85</u>

B. SAR Measurement Results

Frequency (MHz)	3500.000000
Relative permittivity (real part)	38.213495
Relative permittivity (imaginary part)	14.402188
Conductivity (S/m)	2.800425
Variation (%)	-2.070000

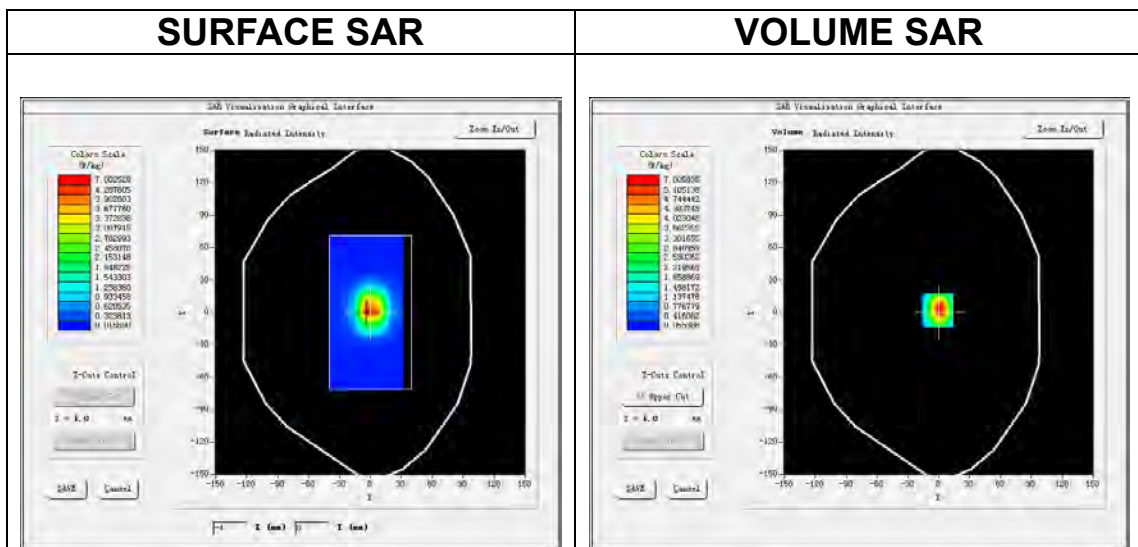

Maximum location: X=-1.00, Y=2.00

SAR Peak: 9.07 W/kg

SAR 10g (W/Kg)	2.507258
SAR 1g (W/Kg)	6.389367

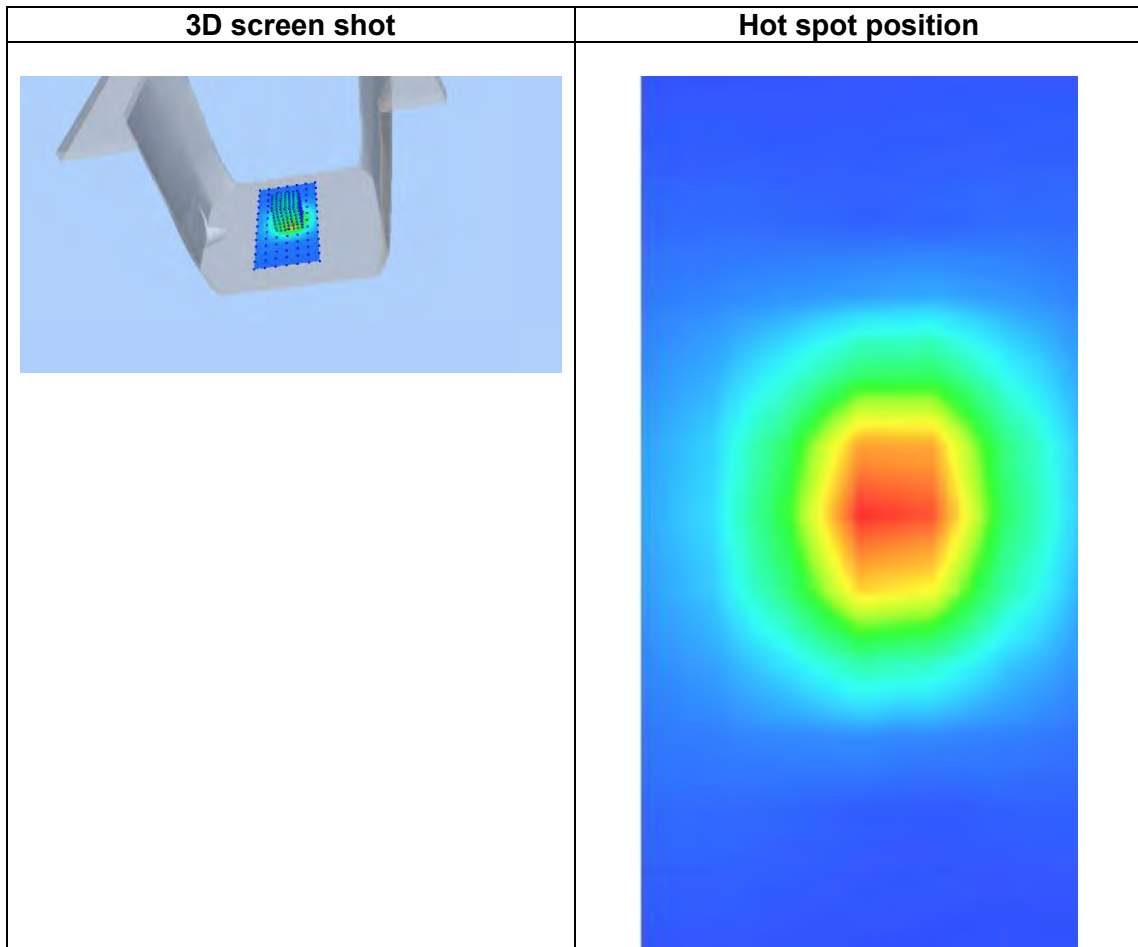
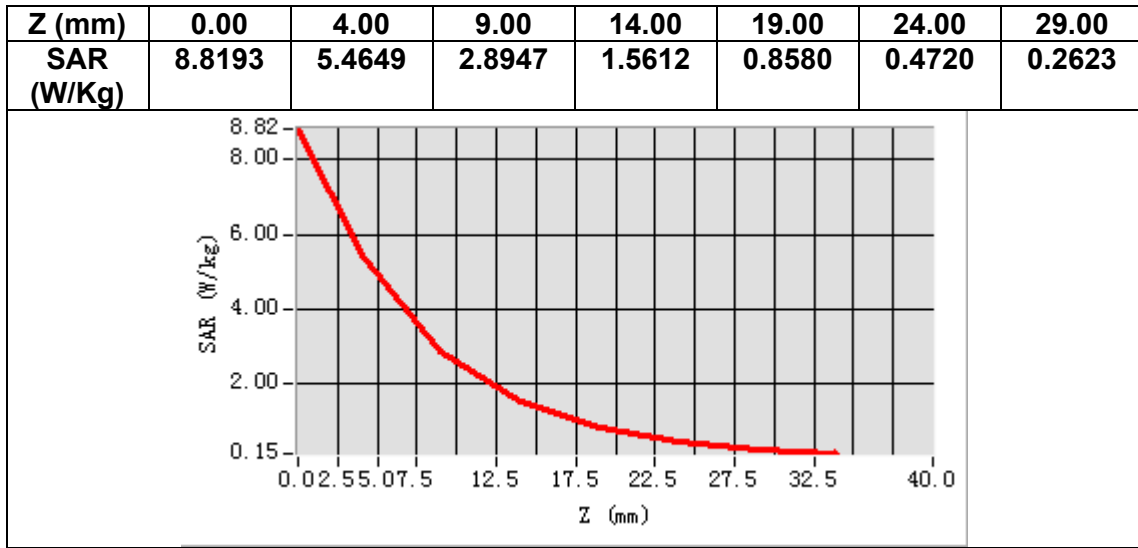

MEASUREMENT 8

Date of measurement: 21/10/2023

A. Experimental conditions.

Area Scan	<u>dx=10mm dy=10mm, h= 2.00 mm</u>
ZoomScan	<u>7x7x12,dx=4mm dy=4mm dz=2mm</u>
Phantom	<u>Validation plane</u>
Device Position	<u>Dipole</u>
Band	<u>CW5200</u>
Channels	<u>Middle</u>
Signal	<u>CW (Crest factor: 1.0)</u>
ConvF	<u>2.07</u>

B. SAR Measurement Results

Frequency (MHz)	5200.000000
Relative permittivity (real part)	35.782074
Relative permittivity (imaginary part)	15.813428
Conductivity (S/m)	4.568324
Variation (%)	3.790000

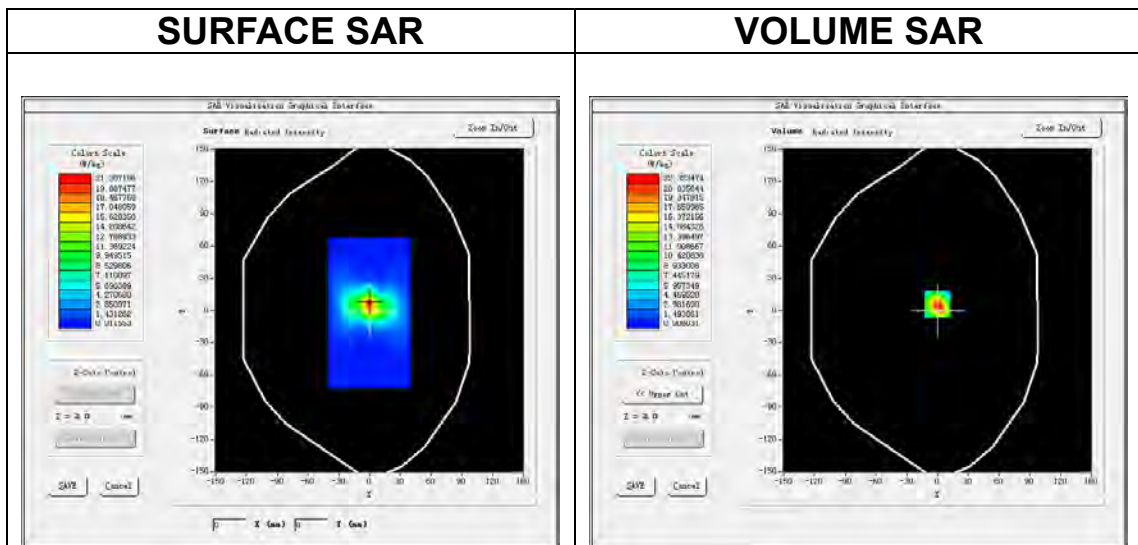

Maximum location: X=0.00, Y=6.00

SAR Peak: 40.06 W/kg

SAR 10g (W/Kg)	5.965217
SAR 1g (W/Kg)	17.231024

Z (m m)	0.00	2.00	4.00	6.00	8.00	10.0 0	12.0 0	14.0 0	16.0 0	18.0 0	20.0 0	22.0 0
SAR (W/ Kg)	37.8 23	22.3 59	11.3 97	5.66 31	2.82 50	1.40 23	0.71 98	0.36 20	0.18 37	0.10 96	0.05 42	0.03 27

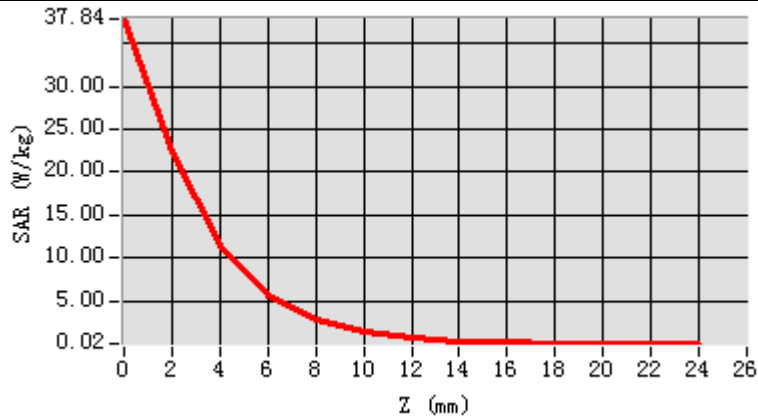

3D screen shot

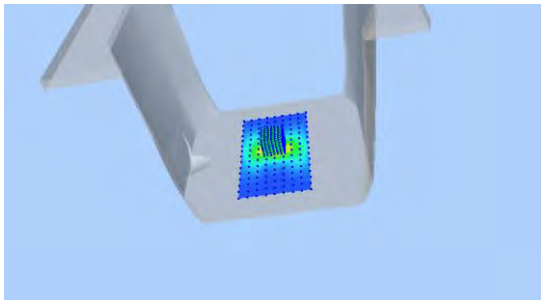

Hot spot position

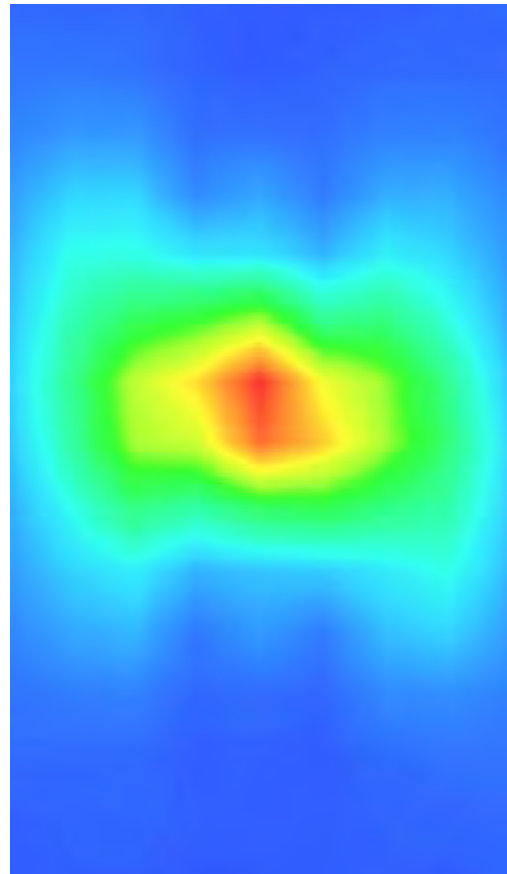

MEASUREMENT 9

Date of measurement: 22/10/2023

A. Experimental conditions.

Area Scan	<u>dx=10mm dy=10mm, h= 2.00 mm</u>
ZoomScan	<u>7x7x12,dx=4mm dy=4mm dz=2mm</u>
Phantom	<u>Validation plane</u>
Device Position	<u>Dipole</u>
Band	<u>CW5800</u>
Channels	<u>Middle</u>
Signal	<u>CW (Crest factor: 1.0)</u>
ConvF	<u>2.04</u>

B. SAR Measurement Results

Frequency (MHz)	5800.000000
Relative permittivity (real part)	35.177374
Relative permittivity (imaginary part)	15.945406
Conductivity (S/m)	5.137964
Variation (%)	-1.540000

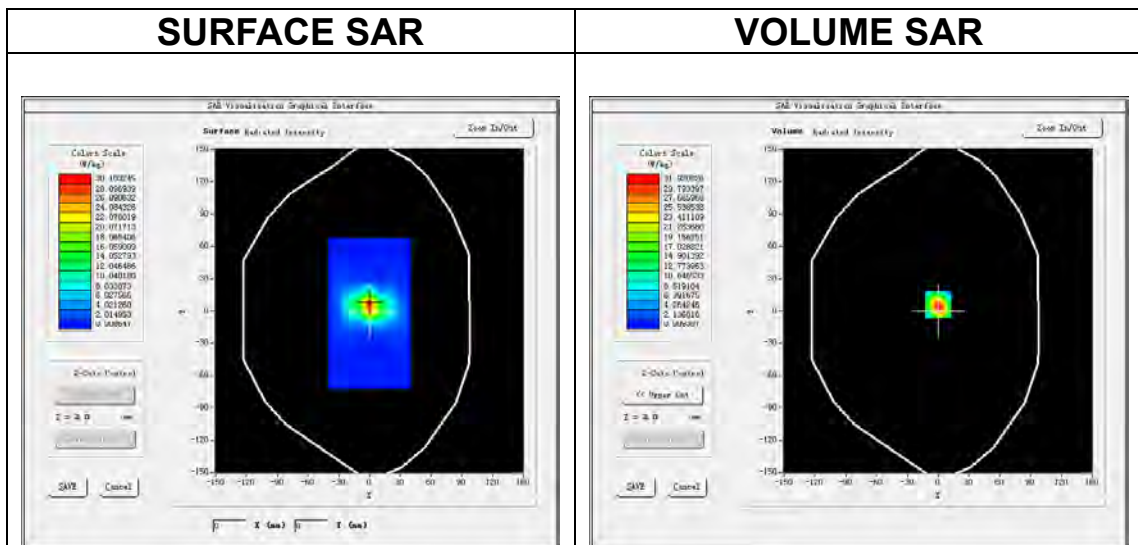

Maximum location: X=0.00, Y=6.00

SAR Peak: 57.37 W/kg

SAR 10g (W/Kg)	6.083177
SAR 1g (W/Kg)	16.647230

Z (m m)	0.00	2.00	4.00	6.00	8.00	10.0 0	12.0 0	14.0 0	16.0 0	18.0 0	20.0 0	22.0 0
SA R (W/ Kg)	54.0 86	31.9 68	16.1 33	8.17 88	4.08 88	2.05 75	1.03 36	0.51 12	0.27 70	0.15 30	0.07 74	0.04 74

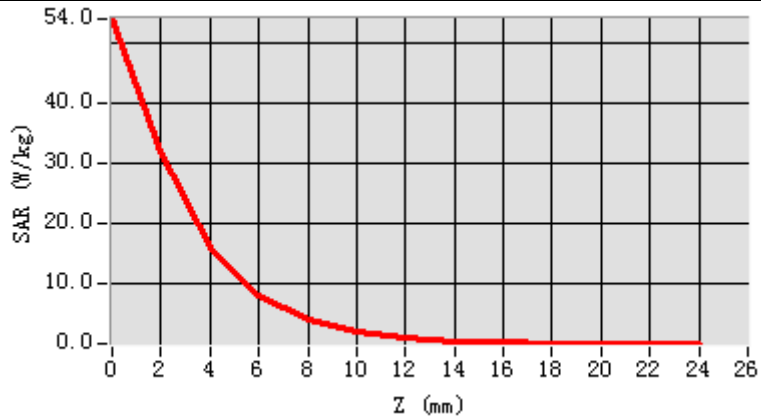

3D screen shot

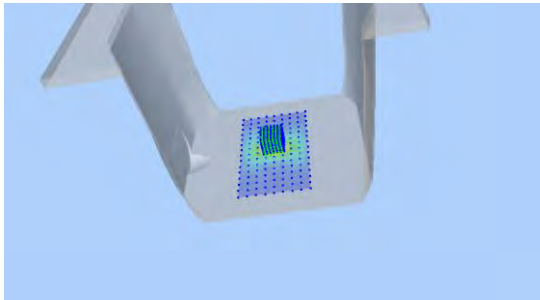

Hot spot position

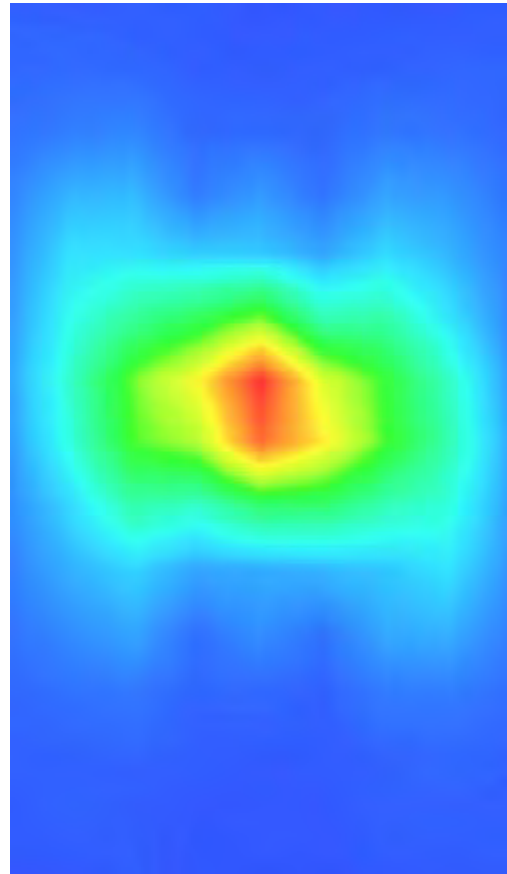

1. Appendix C. Plots of High SAR Measurement

Table of contents
MEASUREMENT 1 GSM 850 Head
MEASUREMENT 2 GSM 850 Body
MEASUREMENT 3 GSM 1900 Head
MEASUREMENT 4 GSM 1900 Body
MEASUREMENT 5 WCDMA Band 2 Head
MEASUREMENT 6 WCDMA Band 2 Body
MEASUREMENT 7 WCDMA Band 4 Head
MEASUREMENT 8 WCDMA Band 4 Body
MEASUREMENT 9 WCDMA Band 5 Head
MEASUREMENT 10 WCDMA Band 5 Body
MEASUREMENT 11 WLAN 5.2G Head
MEASUREMENT 12 WLAN 5.8G Head
MEASUREMENT 13 WLAN 5.2G Body
MEASUREMENT 14 WLAN 5.8G Body
MEASUREMENT 15 WLAN 2.4G Head
MEASUREMENT 16 WLAN 2.4G Body
MEASUREMENT 17 LTE Band 2 Head
MEASUREMENT 18 LTE Band 2 Body
MEASUREMENT 19 LTE Band 4 Head
MEASUREMENT 20 LTE Band 4 Body
MEASUREMENT 21 LTE Band 5 Head
MEASUREMENT 22 LTE Band 5 Body
MEASUREMENT 23 LTE Band 7 Head
MEASUREMENT 24 LTE Band 7 Body
MEASUREMENT 25 LTE Band 12 Head
MEASUREMENT 26 LTE Band 12 Body
MEASUREMENT 27 LTE Band 17 Head
MEASUREMENT 28 LTE Band 17 Body
MEASUREMENT 29 LTE Band 41 Head
MEASUREMENT 30 LTE Band 41 Body
MEASUREMENT 31 NR n41 Head
MEASUREMENT 32 NR n41 Body
MEASUREMENT 33 LTE Band 66 Head
MEASUREMENT 34 LTE Band 66 Body
MEASUREMENT 35 NR n78 Head
MEASUREMENT 36 NR n78 Body

MEASUREMENT 37 LTE Band 71 Head

MEASUREMENT 38 LTE Band 71 Body

MEASUREMENT 1

Date of measurement: 23/10/2023

A. Experimental conditions.

Area Scan	<u>dx=15mm dy=15mm, h= 5.00 mm</u>
ZoomScan	<u>5x5x7, dx=8mm dy=8mm dz=5mm</u>
Phantom	<u>Left head</u>
Device Position	<u>Cheek</u>
Band	<u>GSM850</u>
Channels	<u>Middle</u>
Signal	<u>TDMA (Crest factor: 2.7)</u>
ConvF	<u>2.32</u>

B. SAR Measurement Results

Frequency (MHz)	836.400000
Relative permittivity (real part)	41.562119
Relative permittivity (imaginary part)	19.428495
Conductivity (S/m)	0.902777
Variation (%)	1.400000

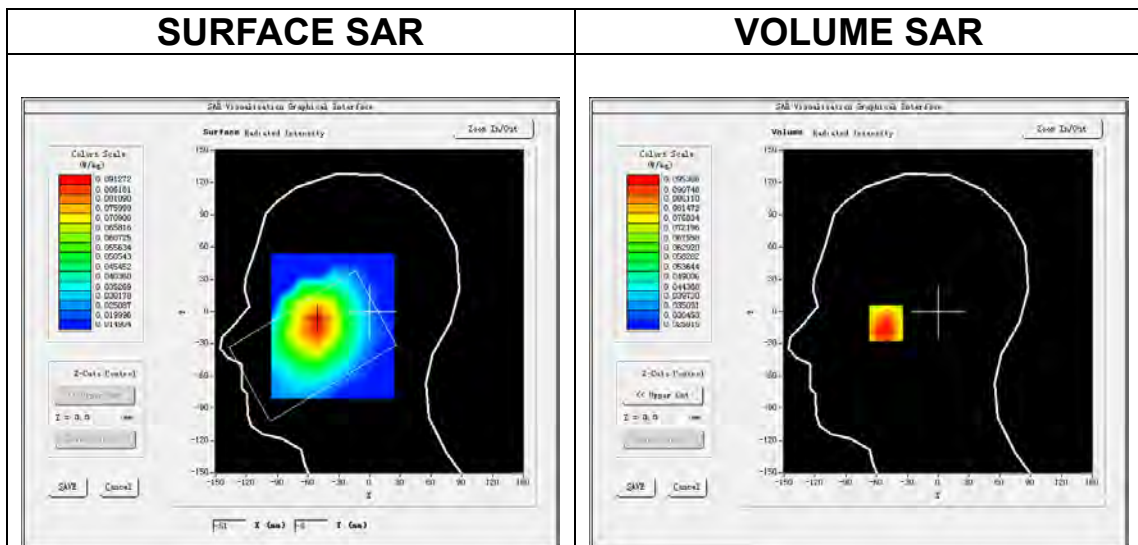

Maximum location: X=-51.00, Y=-9.00
SAR Peak: 0.11 W/kg

SAR 10g (W/Kg)	0.072942
SAR 1g (W/Kg)	0.092618

Z (mm)	0.00	4.00	9.00	14.00	19.00	24.00	29.00
SAR (W/Kg)	0.1136	0.0954	0.0780	0.0640	0.0562	0.0468	0.0421

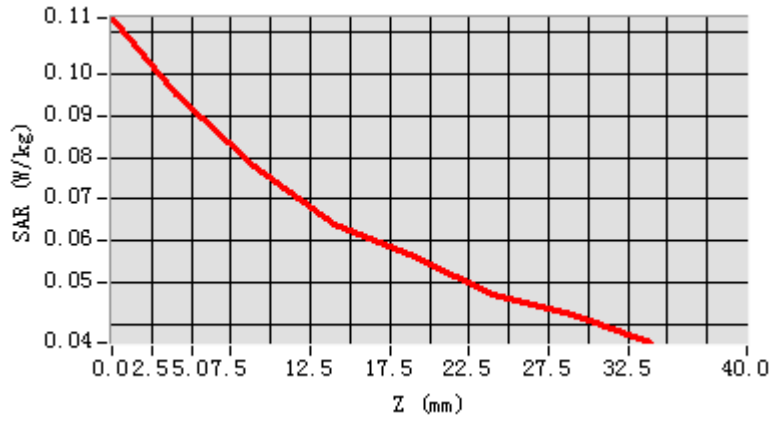

3D screen shot

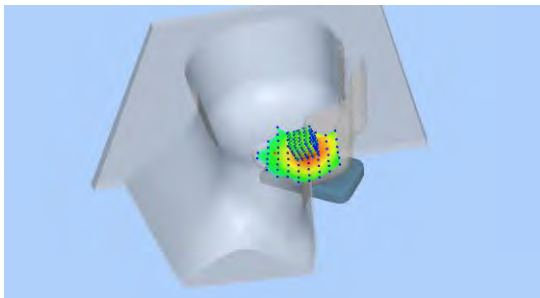

Hot spot position

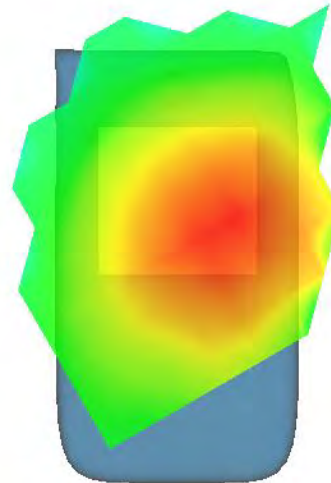

MEASUREMENT 2

Date of measurement: 23/10/2023

A. Experimental conditions.

Area Scan	<u>dx=15mm dy=15mm, h= 5.00 mm</u>
ZoomScan	<u>5x5x7,dx=8mm dy=8mm dz=5mm</u>
Phantom	<u>Validation plane</u>
Device Position	<u>Body</u>
Band	<u>GSM850</u>
Channels	<u>Middle</u>
Signal	<u>TDMA (Crest factor: 2.7)</u>
ConvF	<u>2.32</u>

B. SAR Measurement Results

Frequency (MHz)	836.400000
Relative permittivity (real part)	41.562119
Relative permittivity (imaginary part)	19.428495
Conductivity (S/m)	0.902777
Variation (%)	2.800000

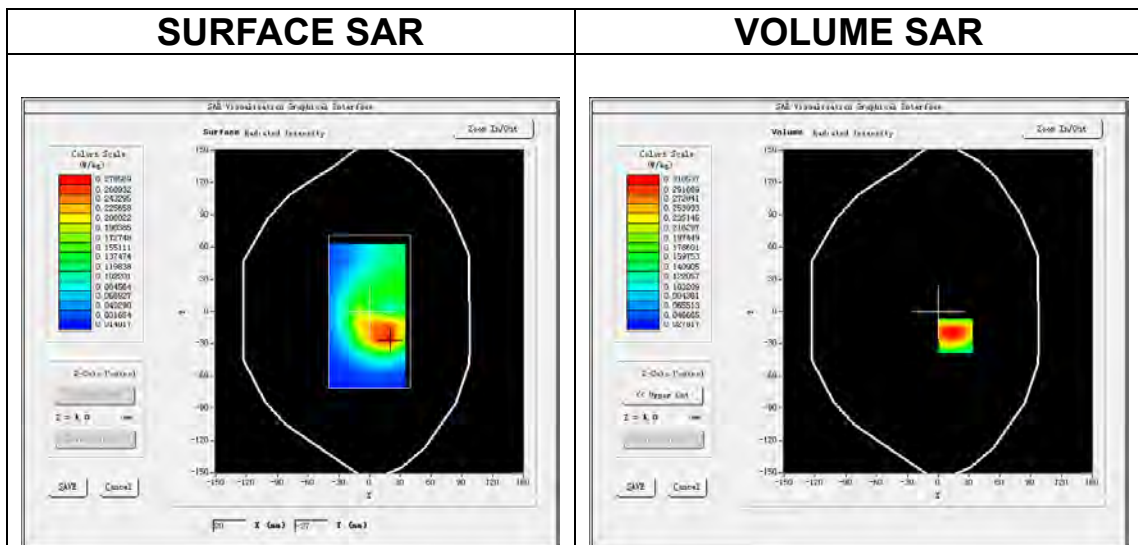

Maximum location: X=17.00, Y=-23.00
SAR Peak: 0.49 W/kg

SAR 10g (W/Kg)	0.189126
SAR 1g (W/Kg)	0.312074

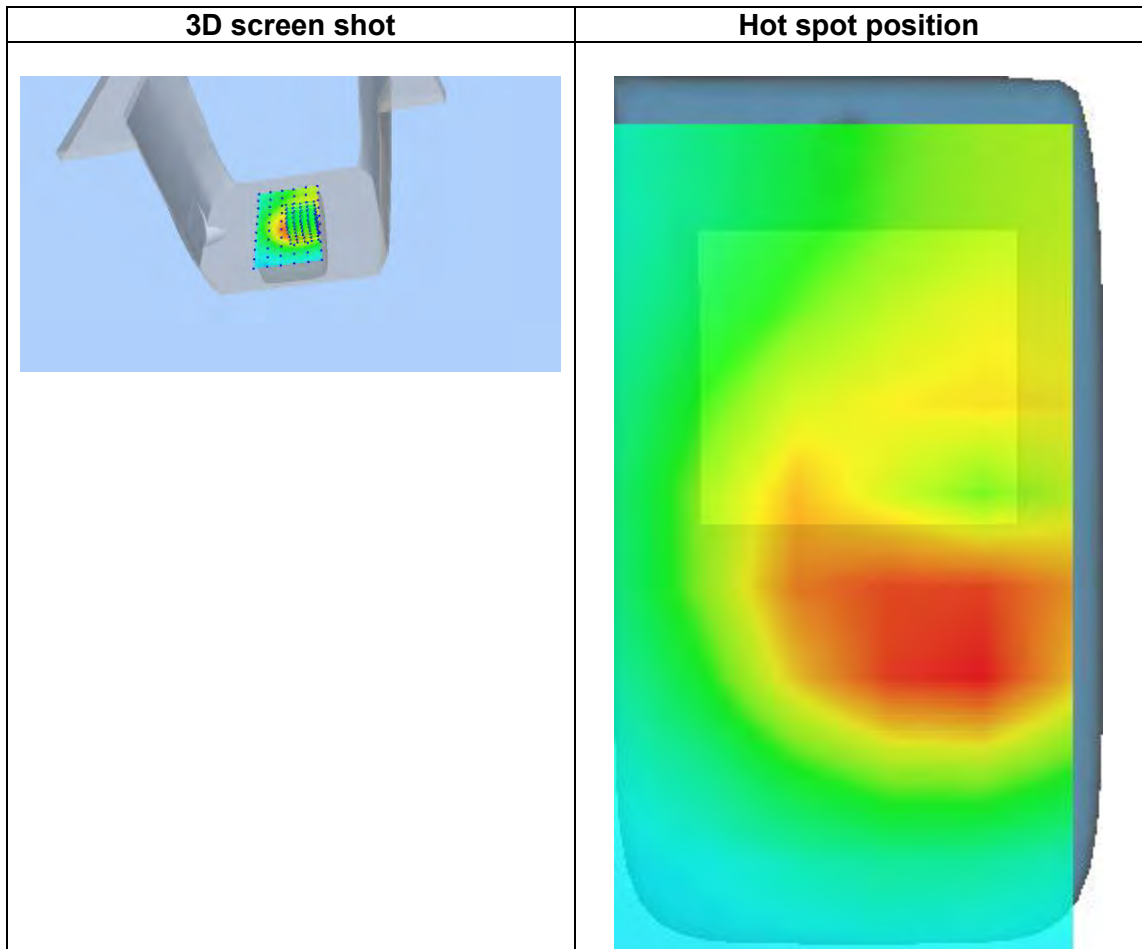
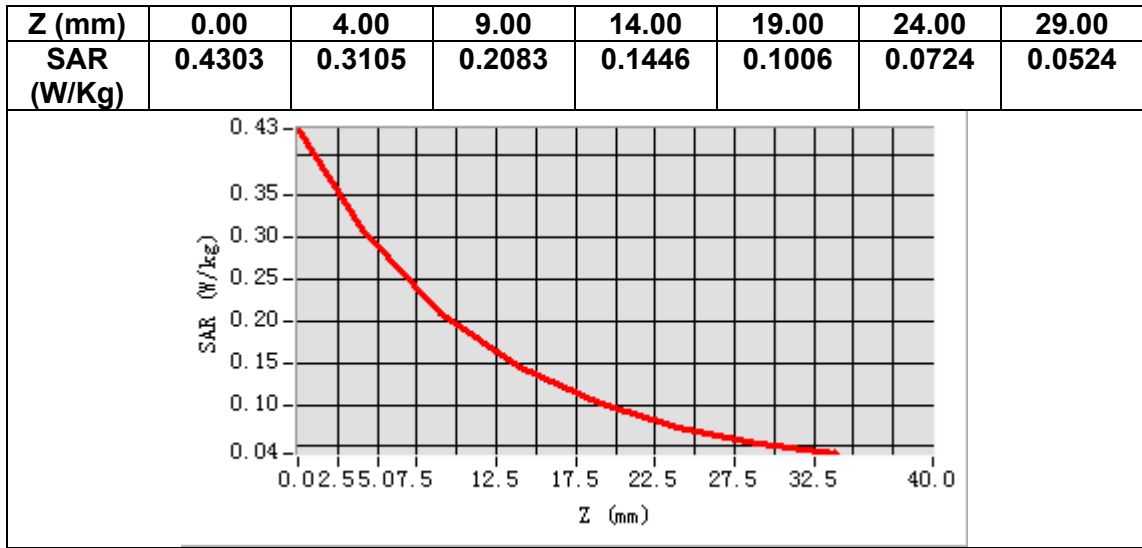

MEASUREMENT 3

Date of measurement: 24/10/2023

A. Experimental conditions.

Area Scan	<u>dx=15mm dy=15mm, h= 5.00 mm</u>
ZoomScan	<u>5x5x7, dx=8mm dy=8mm dz=5mm</u>
Phantom	<u>Left head</u>
Device Position	<u>Cheek</u>
Band	<u>GSM1900</u>
Channels	<u>Middle</u>
Signal	<u>TDMA (Crest factor: 2.7)</u>
ConvF	<u>2.63</u>

B. SAR Measurement Results

Frequency (MHz)	1880.000000
Relative permittivity (real part)	39.098179
Relative permittivity (imaginary part)	13.676342
Conductivity (S/m)	1.428418
Variation (%)	2.750000

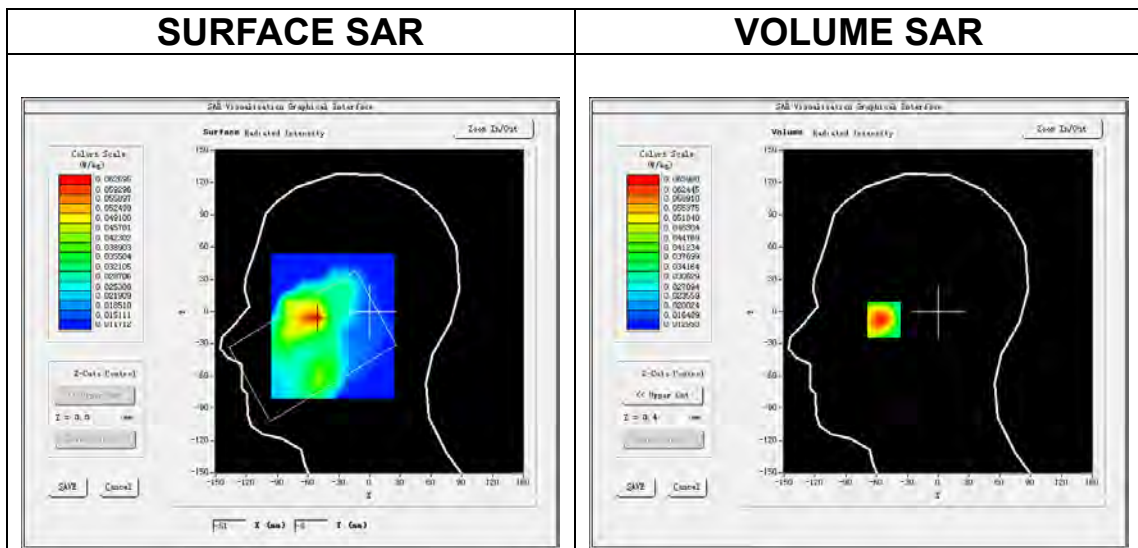

Maximum location: X=-53.00, Y=-5.00
SAR Peak: 0.09 W/kg

SAR 10g (W/Kg)	0.042305
SAR 1g (W/Kg)	0.063996

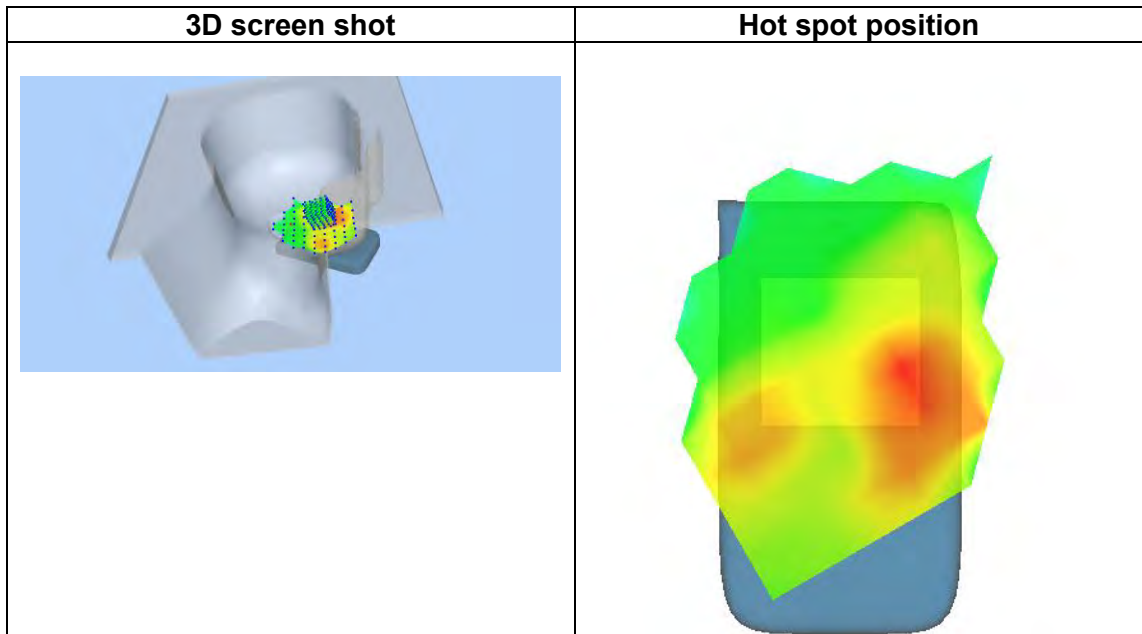
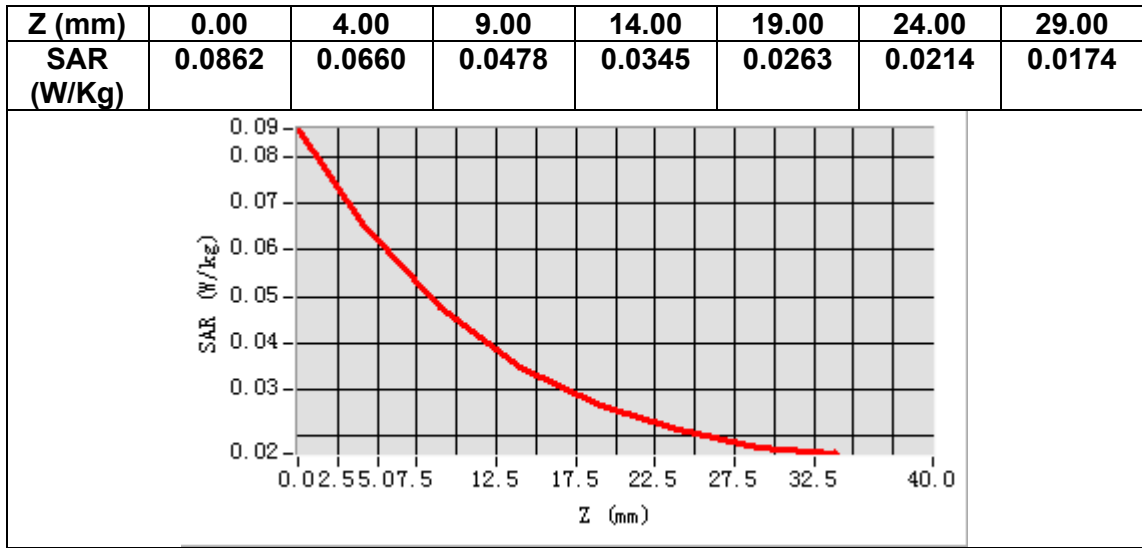

MEASUREMENT 4

Date of measurement: 24/10/2023

A. Experimental conditions.

Area Scan	<u>dx=15mm dy=15mm, h= 5.00 mm</u>
ZoomScan	<u>5x5x7, dx=8mm dy=8mm dz=5mm</u>
Phantom	<u>Validation plane</u>
Device Position	<u>Body</u>
Band	<u>GSM1900</u>
Channels	<u>Middle</u>
Signal	<u>TDMA (Crest factor: 2.7)</u>
ConvF	<u>2.63</u>

B. SAR Measurement Results

Frequency (MHz)	1880.000000
Relative permittivity (real part)	39.098179
Relative permittivity (imaginary part)	13.676342
Conductivity (S/m)	1.428418
Variation (%)	4.570000

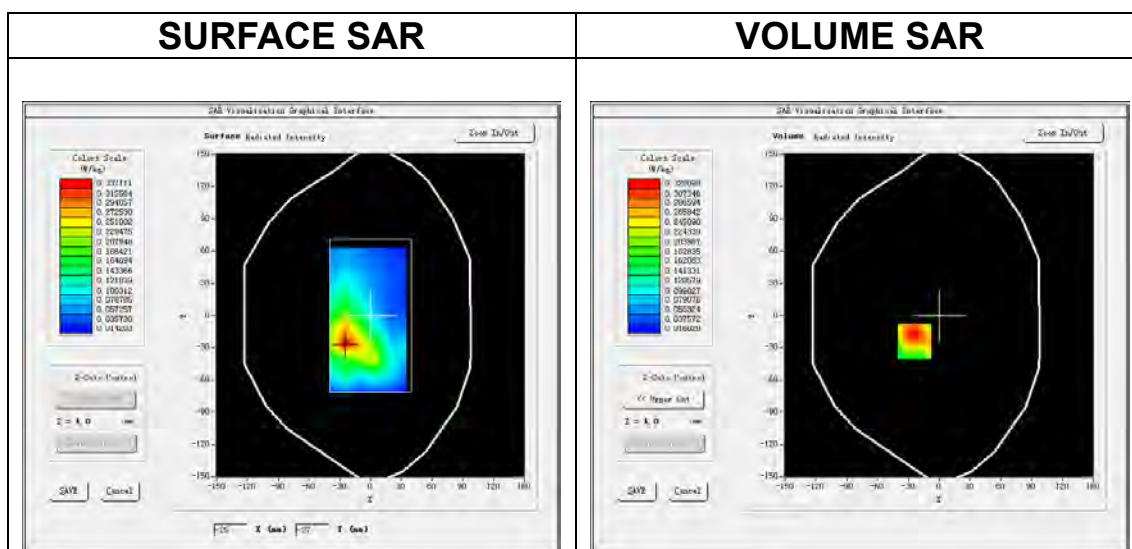

Maximum location: X=-24.00, Y=-24.00
SAR Peak: 0.50 W/kg

SAR 10g (W/Kg)	0.182284
SAR 1g (W/Kg)	0.320219

Z (mm)	0.00	4.00	9.00	14.00	19.00	24.00	29.00
SAR (W/Kg)	0.6346	0.3281	0.1283	0.1195	0.0531	0.0448	0.0272

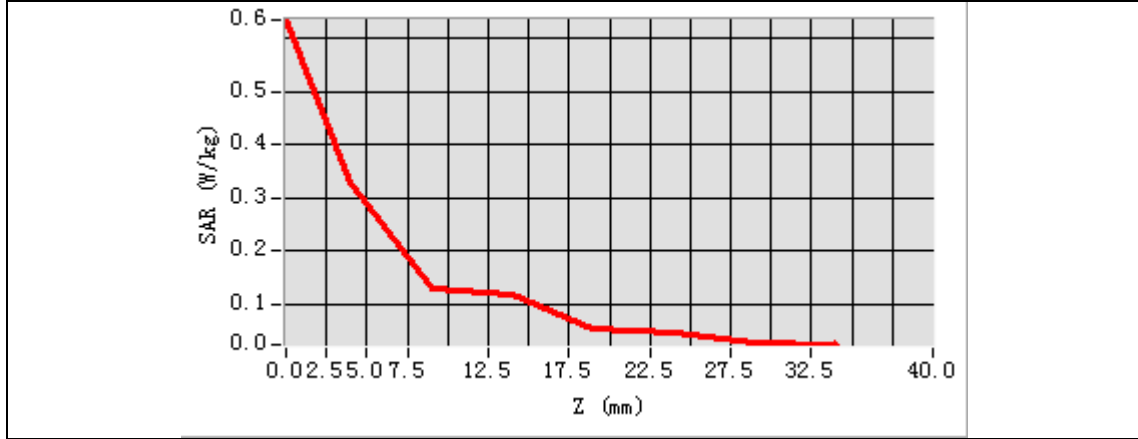

3D screen shot	Hot spot position

MEASUREMENT 5

Date of measurement: 24/10/2023

A. Experimental conditions.

Area Scan	<u>dx=15mm dy=15mm, h= 5.00 mm</u>
ZoomScan	<u>5x5x7, dx=8mm dy=8mm dz=5mm</u>
Phantom	<u>Left head</u>
Device Position	<u>Cheek</u>
Band	<u>Band2 WCDMA1900</u>
Channels	<u>Middle</u>
Signal	<u>WCDMA (Crest factor: 1.0)</u>
ConvF	<u>2.63</u>

B. SAR Measurement Results

Frequency (MHz)	1880.000000
Relative permittivity (real part)	39.098179
Relative permittivity (imaginary part)	13.676342
Conductivity (S/m)	1.428418
Variation (%)	0.980000

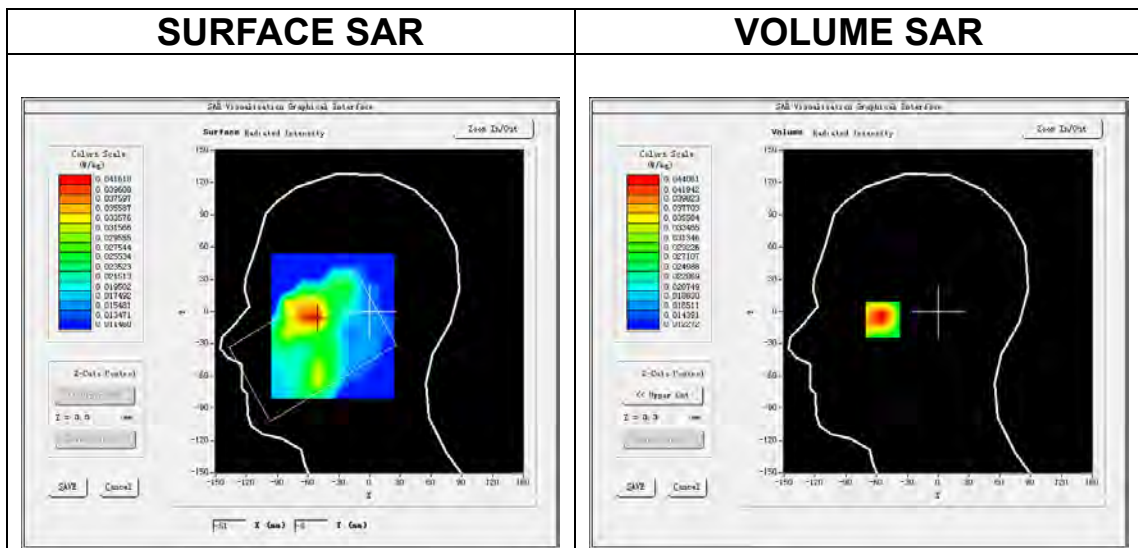

Maximum location: X=-54.00, Y=-5.00
SAR Peak: 0.06 W/kg

SAR 10g (W/Kg)	0.030171
SAR 1g (W/Kg)	0.043930

Z (mm)	0.00	4.00	9.00	14.00	19.00	24.00	29.00
SAR (W/Kg)	0.0565	0.0441	0.0333	0.0249	0.0208	0.0175	0.0153

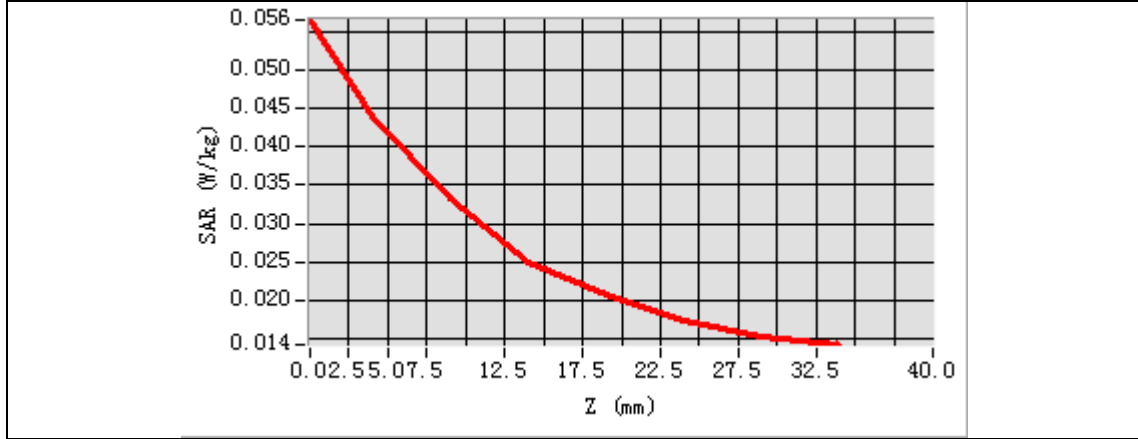

3D screen shot	Hot spot position

MEASUREMENT 6

Date of measurement: 24/10/2023

A. Experimental conditions.

Area Scan	<u>dx=15mm dy=15mm, h= 5.00 mm</u>
ZoomScan	<u>5x5x7, dx=8mm dy=8mm dz=5mm</u>
Phantom	<u>Validation plane</u>
Device Position	<u>Body</u>
Band	<u>Band2 WCDMA1900</u>
Channels	<u>Middle</u>
Signal	<u>WCDMA (Crest factor: 1.0)</u>
ConvF	<u>2.63</u>

B. SAR Measurement Results

Frequency (MHz)	1880.000000
Relative permittivity (real part)	39.098179
Relative permittivity (imaginary part)	13.676342
Conductivity (S/m)	1.428418
Variation (%)	1.440000

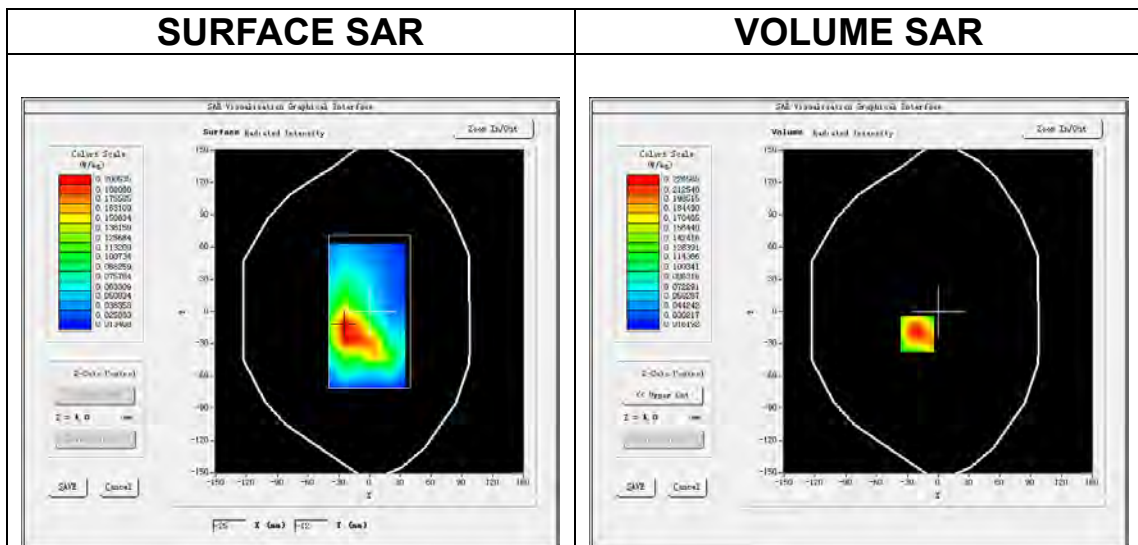

Maximum location: X=-20.00, Y=-21.00
SAR Peak: 0.33 W/kg

SAR 10g (W/Kg)	0.130437
SAR 1g (W/Kg)	0.220485

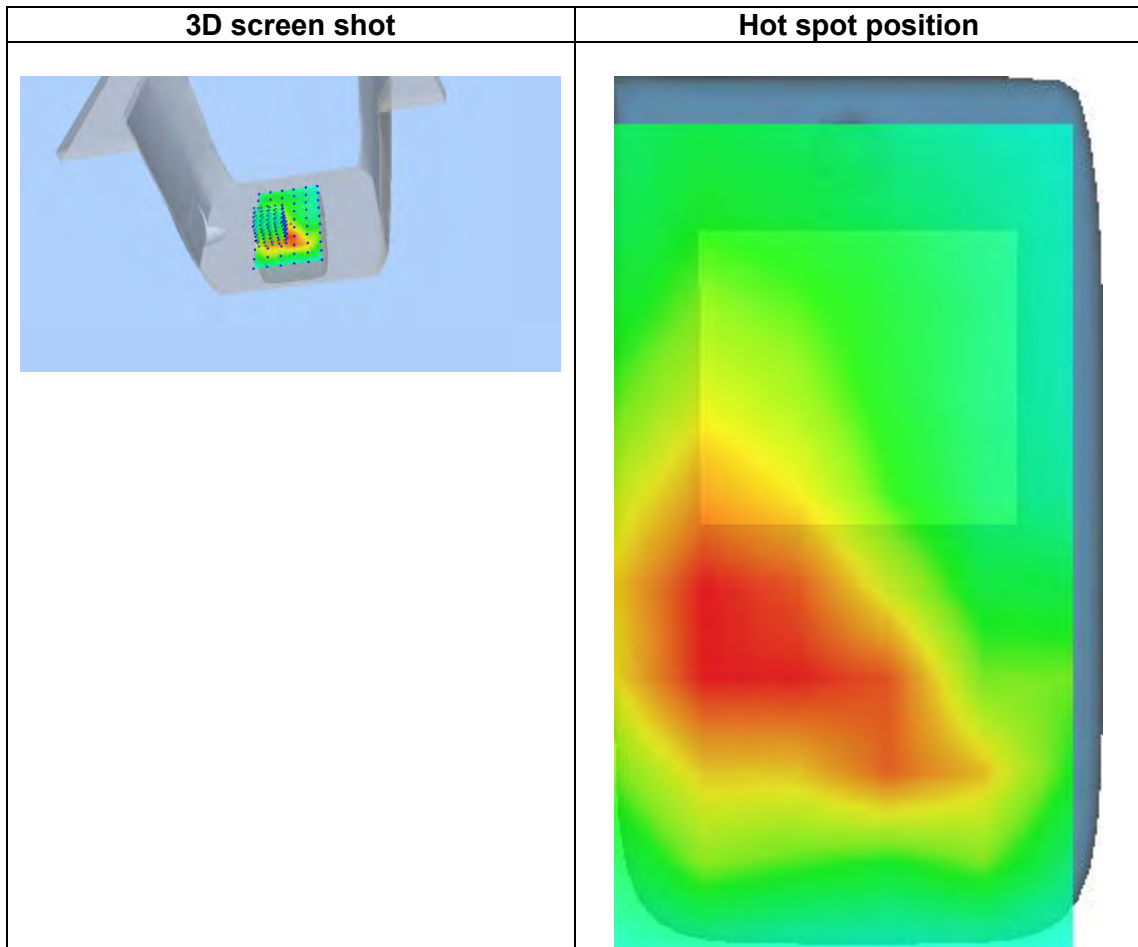
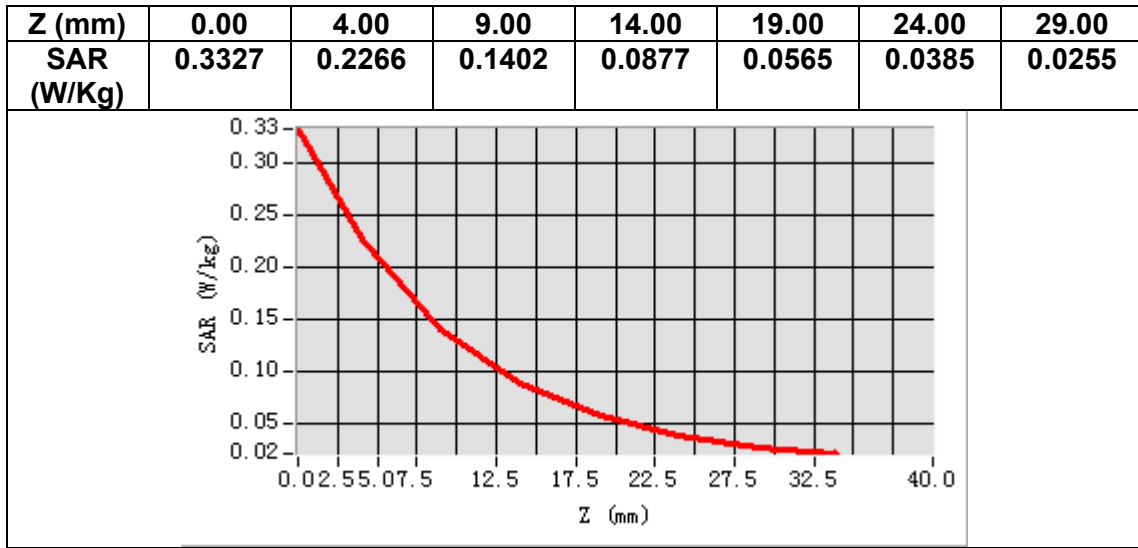

MEASUREMENT 7

Date of measurement: 31/10/2023

A. Experimental conditions.

Area Scan	<u>dx=15mm dy=15mm, h= 5.00 mm</u>
ZoomScan	<u>5x5x7, dx=8mm dy=8mm dz=5mm</u>
Phantom	<u>Left head</u>
Device Position	<u>Cheek</u>
Band	<u>Band4 WCDMA1700</u>
Channels	<u>Middle</u>
Signal	<u>WCDMA (Crest factor: 1.0)</u>
ConvF	<u>2.45</u>

B. SAR Measurement Results

Frequency (MHz)	1732.600000
Relative permittivity (real part)	40.515720
Relative permittivity (imaginary part)	14.270945
Conductivity (S/m)	1.373182
Variation (%)	0.430000

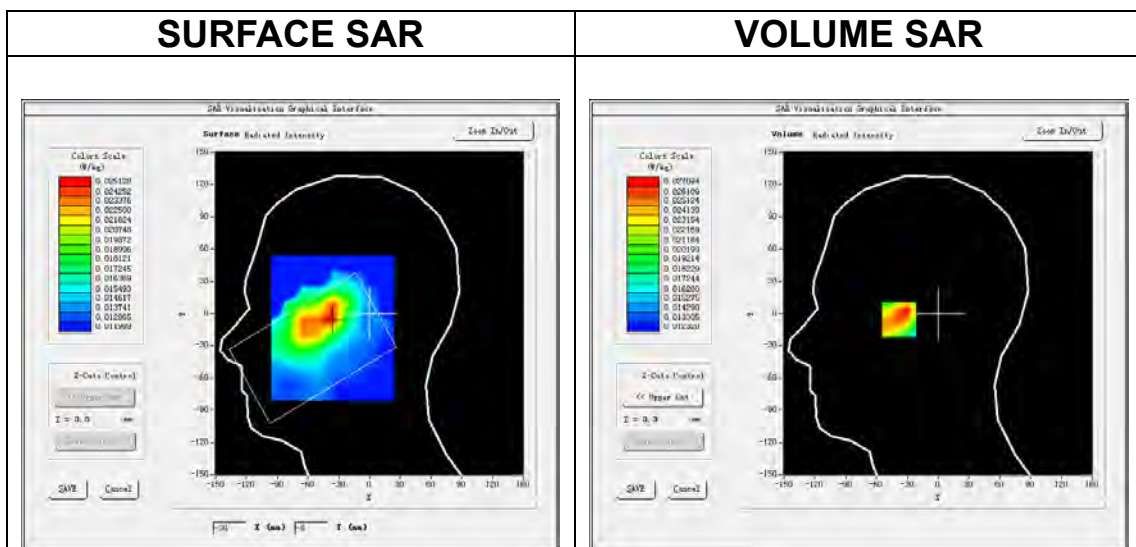

Maximum location: X=-38.00, Y=-3.00
SAR Peak: 0.04 W/kg

SAR 10g (W/Kg)	0.020629
SAR 1g (W/Kg)	0.026727

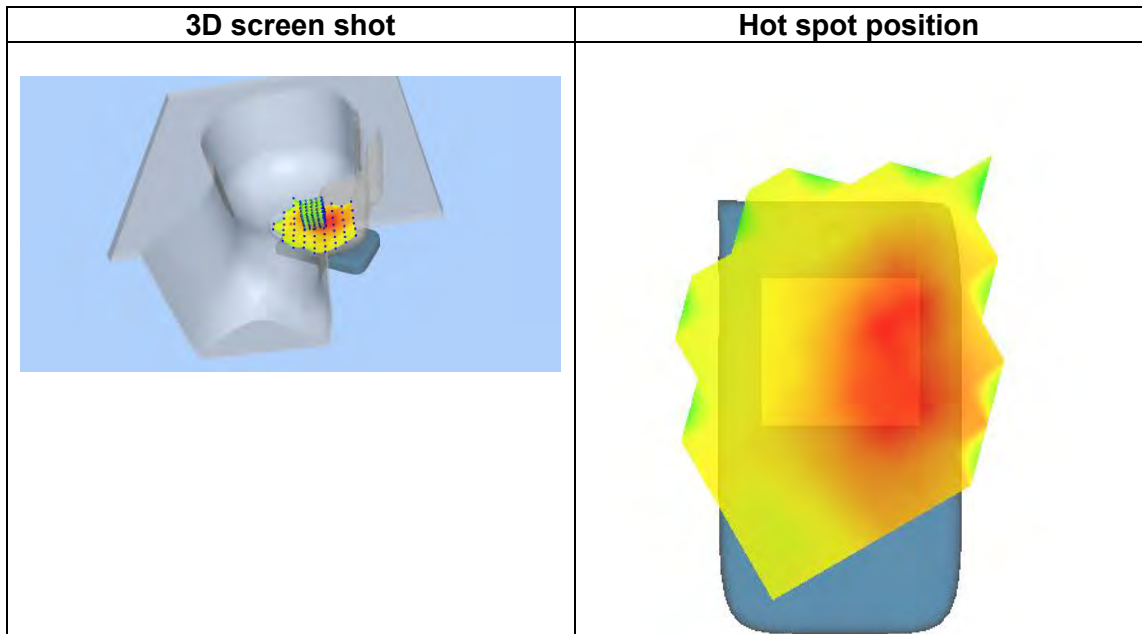
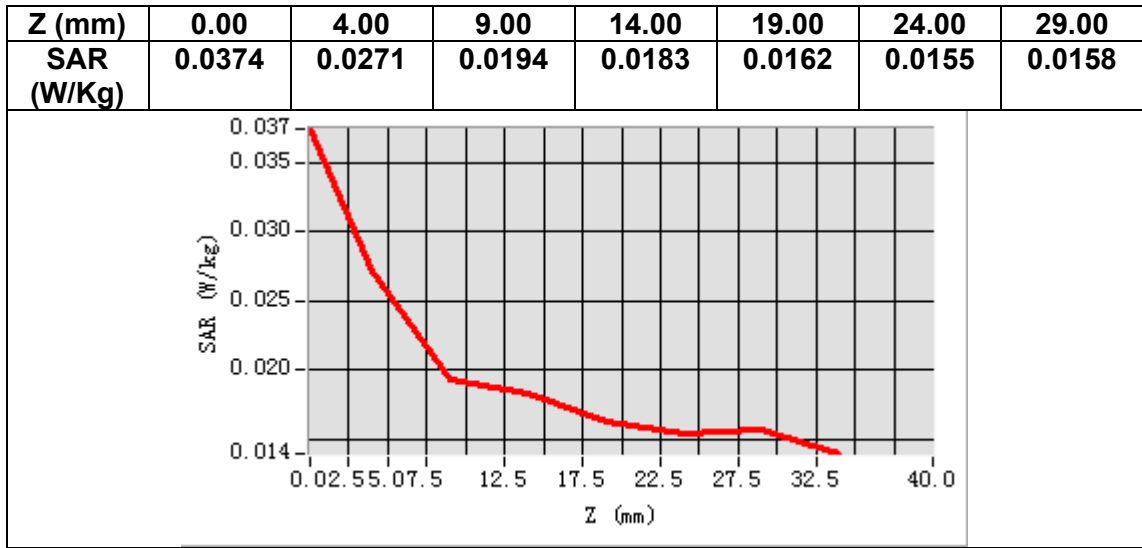

MEASUREMENT 8

Date of measurement: 31/10/2023

A. Experimental conditions.

Area Scan	<u>dx=15mm dy=15mm, h= 5.00 mm</u>
ZoomScan	<u>5x5x7, dx=8mm dy=8mm dz=5mm</u>
Phantom	<u>Validation plane</u>
Device Position	<u>Body</u>
Band	<u>Band4 WCDMA1700</u>
Channels	<u>Middle</u>
Signal	<u>WCDMA (Crest factor: 1.0)</u>
ConvF	<u>2.45</u>

B. SAR Measurement Results

Frequency (MHz)	1732.600000
Relative permittivity (real part)	40.515720
Relative permittivity (imaginary part)	14.270945
Conductivity (S/m)	1.373182
Variation (%)	1.070000

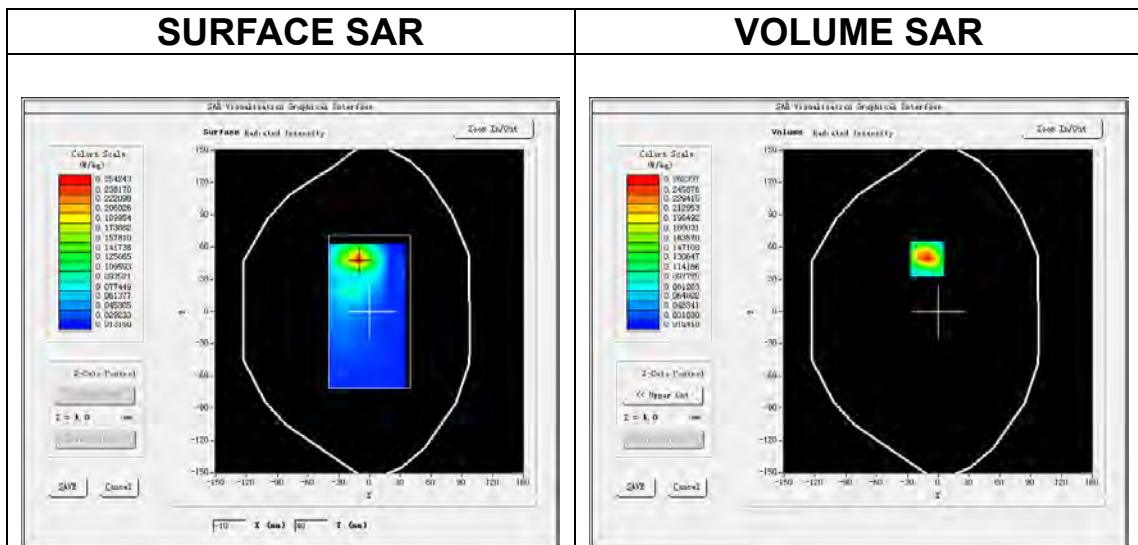

Maximum location: X=-11.00, Y=49.00
SAR Peak: 0.40 W/kg

SAR 10g (W/Kg)	0.128040
SAR 1g (W/Kg)	0.244663

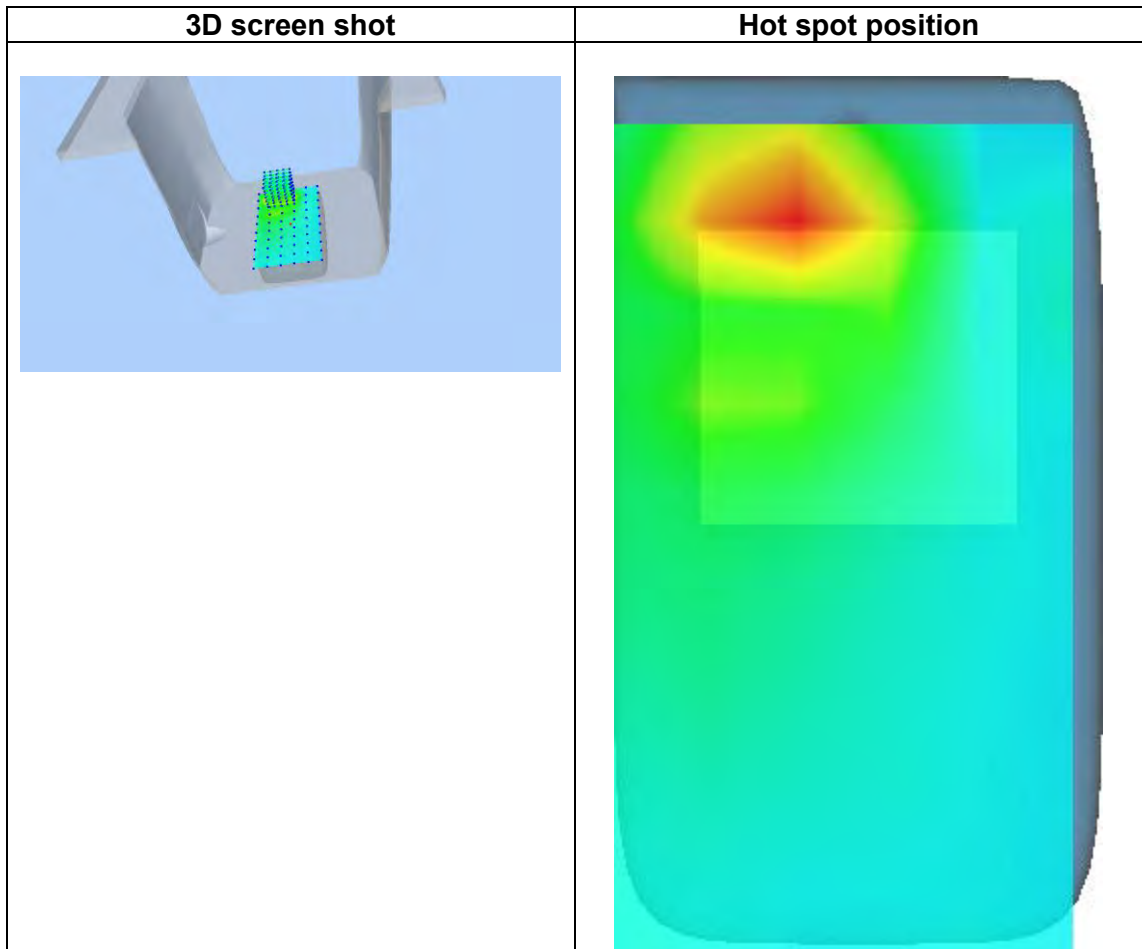
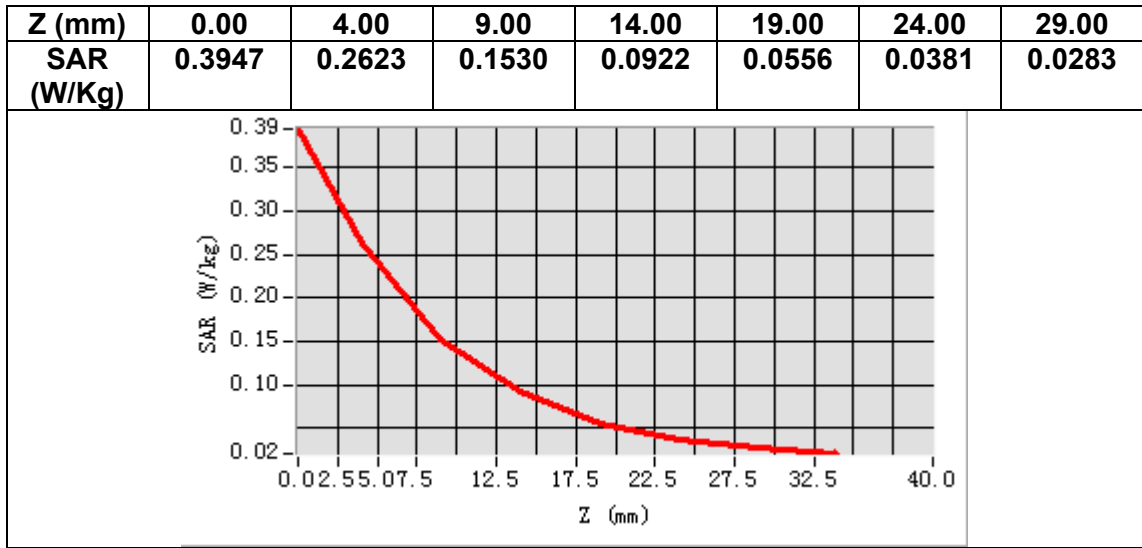

MEASUREMENT 9

Date of measurement: 23/10/2023

A. Experimental conditions.

Area Scan	<u>dx=15mm dy=15mm, h= 5.00 mm</u>
ZoomScan	<u>5x5x7,dx=8mm dy=8mm dz=5mm</u>
Phantom	<u>Left head</u>
Device Position	<u>Cheek</u>
Band	<u>Band5 WCDMA850</u>
Channels	<u>Middle</u>
Signal	<u>WCDMA (Crest factor: 1.0)</u>
ConvF	<u>2.32</u>

B. SAR Measurement Results

Frequency (MHz)	836.400000
Relative permittivity (real part)	41.562119
Relative permittivity (imaginary part)	19.428495
Conductivity (S/m)	0.902777
Variation (%)	4.480000

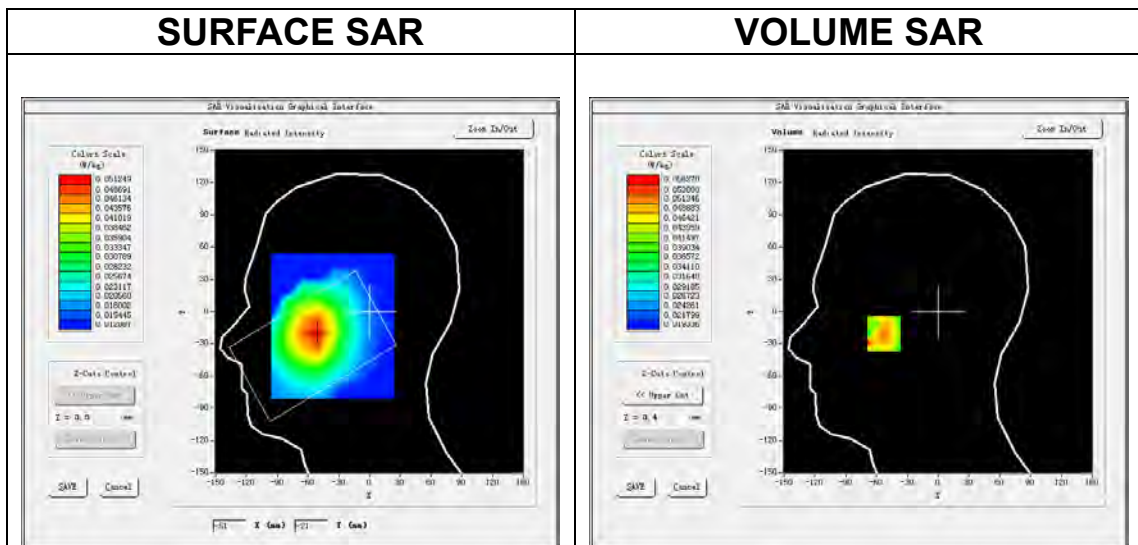

Maximum location: X=-53.00, Y=-20.00
SAR Peak: 0.08 W/kg

SAR 10g (W/Kg)	0.039784
SAR 1g (W/Kg)	0.050343

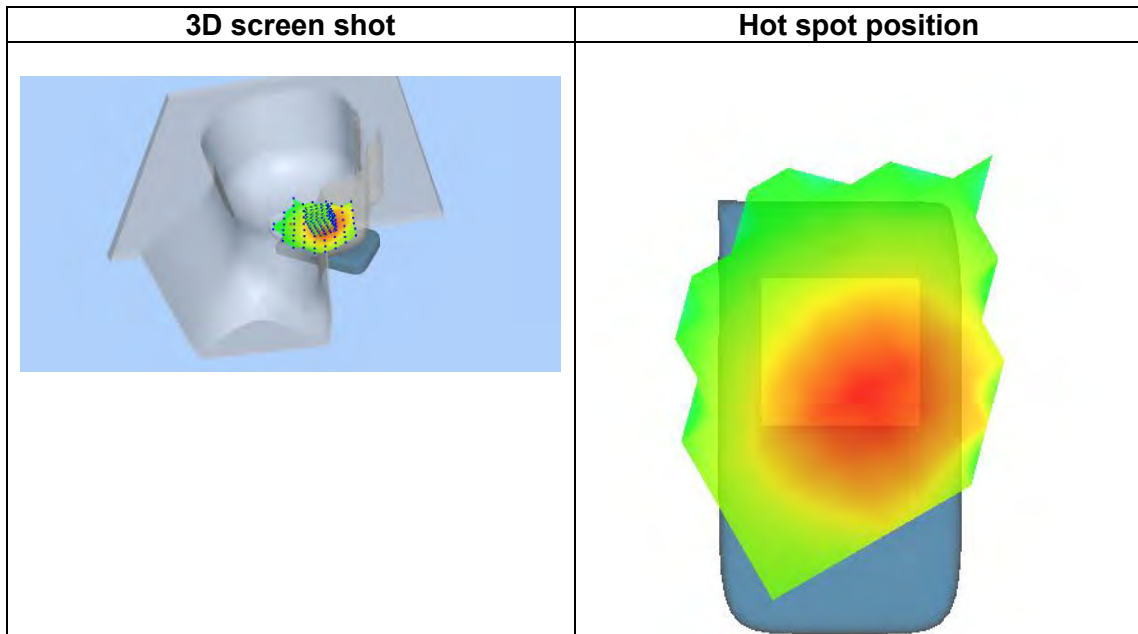
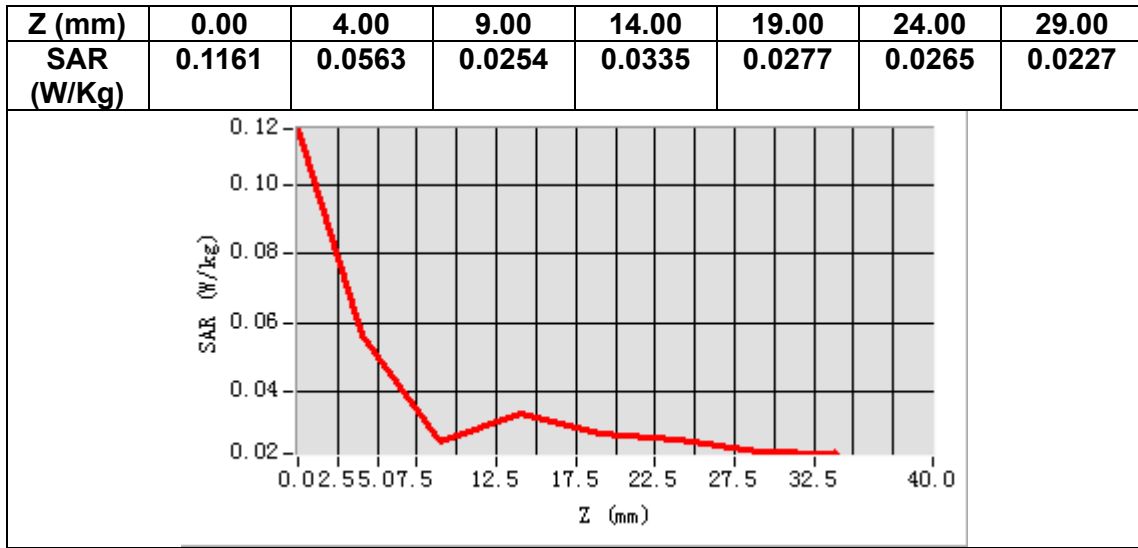

MEASUREMENT 10

Date of measurement: 23/10/2023

A. Experimental conditions.

Area Scan	<u>dx=15mm dy=15mm, h= 5.00 mm</u>
ZoomScan	<u>5x5x7, dx=8mm dy=8mm dz=5mm</u>
Phantom	<u>Validation plane</u>
Device Position	<u>Body</u>
Band	<u>Band5 WCDMA850</u>
Channels	<u>Middle</u>
Signal	<u>WCDMA (Crest factor: 1.0)</u>
ConvF	<u>2.32</u>

B. SAR Measurement Results

Frequency (MHz)	836.400000
Relative permittivity (real part)	41.562119
Relative permittivity (imaginary part)	19.428495
Conductivity (S/m)	0.902777
Variation (%)	0.150000

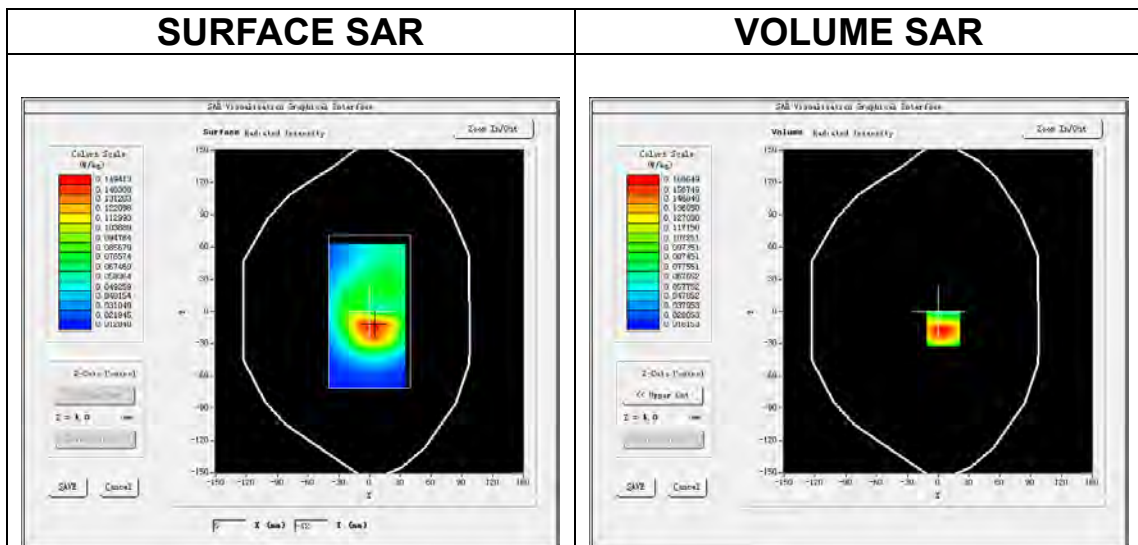

Maximum location: X=5.00, Y=-16.00
SAR Peak: 0.24 W/kg

SAR 10g (W/Kg)	0.100259
SAR 1g (W/Kg)	0.160859

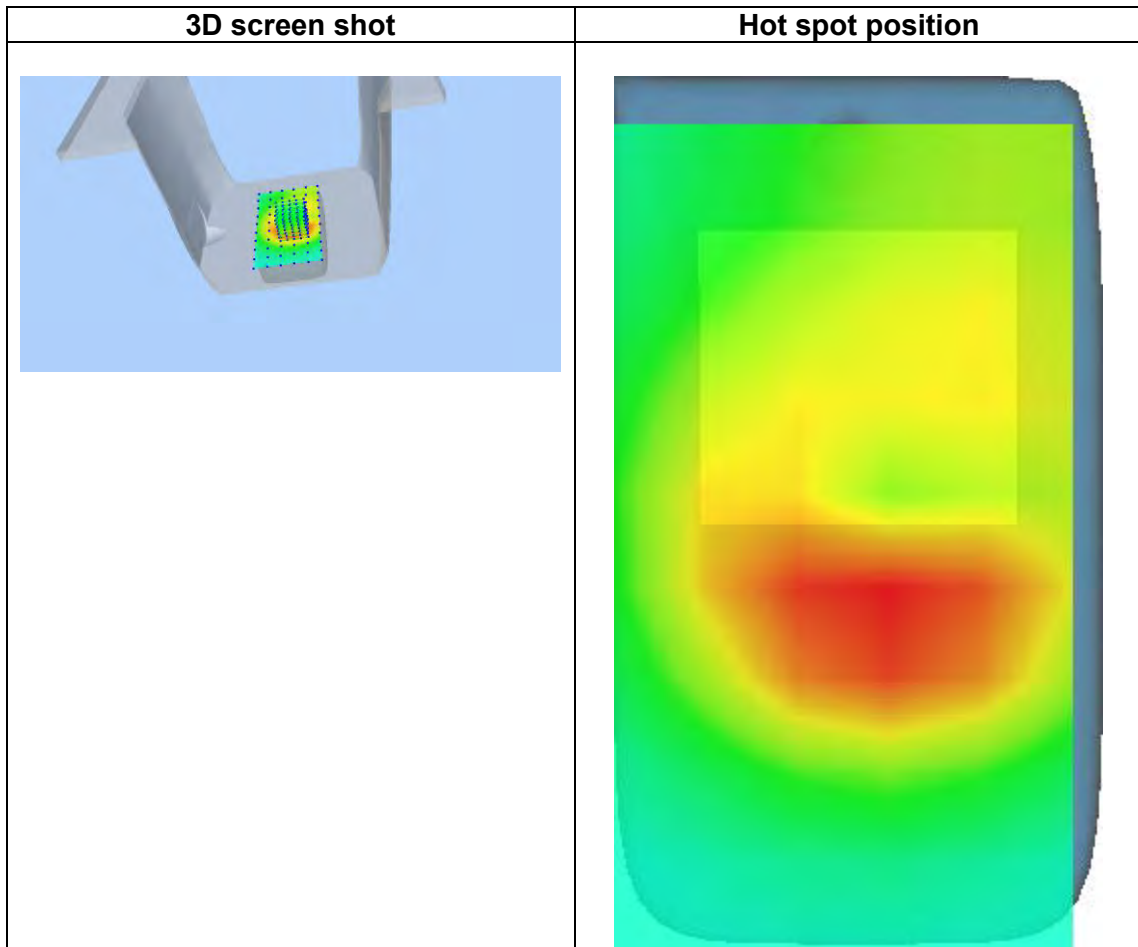
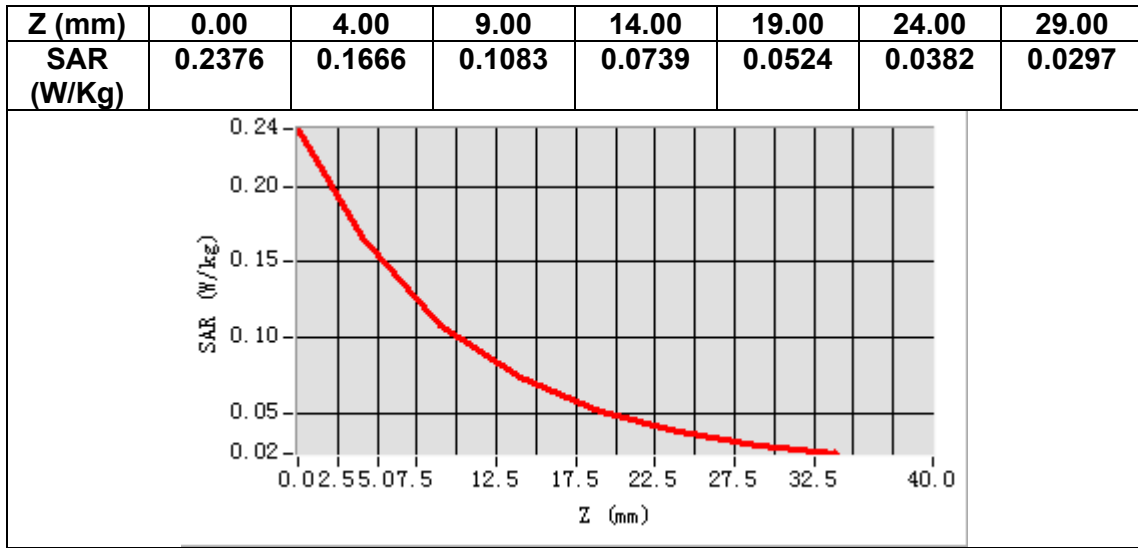

MEASUREMENT 11

Date of measurement: 21/10/2023

A. Experimental conditions.

Area Scan	<u>dx=10mm dy=10mm, h= 2.00 mm</u>
ZoomScan	<u>7x7x12,dx=4mm dy=4mm dz=2mm</u>
Phantom	<u>Left head</u>
Device Position	<u>Cheek</u>
Band	<u>IEEE 802.11ax U-NII</u>
Channels	<u>Middle</u>
Signal	<u>IEEE802.11ax (Crest factor: 1.0)</u>
ConvF	<u>2.07</u>

B. SAR Measurement Results

Frequency (MHz)	5200.000000
Relative permittivity (real part)	35.782074
Relative permittivity (imaginary part)	15.813428
Conductivity (S/m)	4.568324
Variation (%)	-0.680000

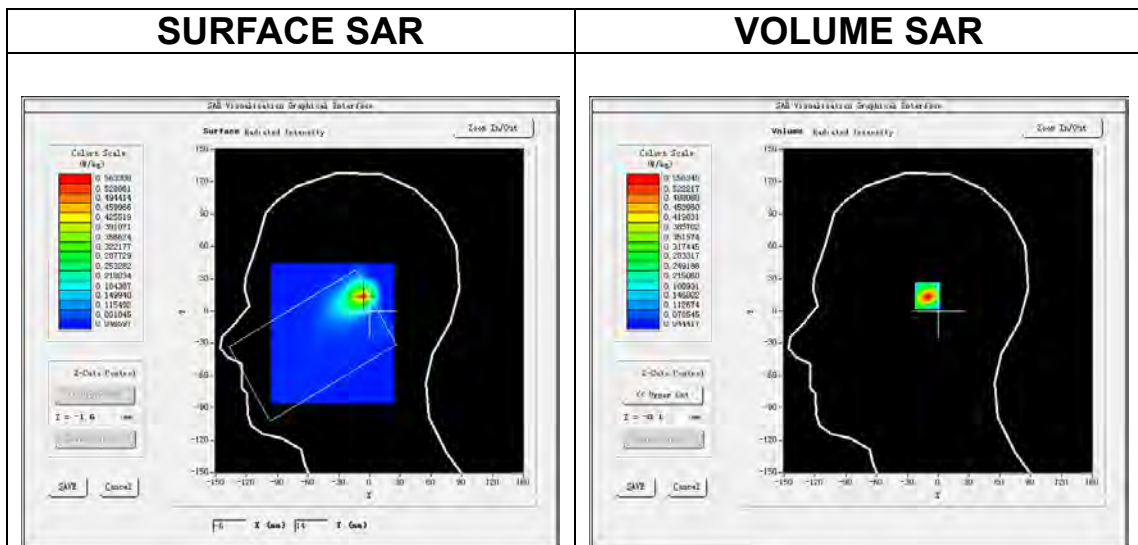

Maximum location: X=-7.00, Y=14.00

SAR Peak: 1.46 W/kg

SAR 10g (W/Kg)	0.200474
SAR 1g (W/Kg)	0.532467

Z (m m)	0.00	2.00	4.00	6.00	8.00	10.0	12.0	14.0	16.0	18.0	20.0	22.0
SAR (W/Kg)	0.9267	0.5563	0.2948	0.1668	0.1038	0.0759	0.0625	0.0604	0.0544	0.0578	0.0563	0.0477

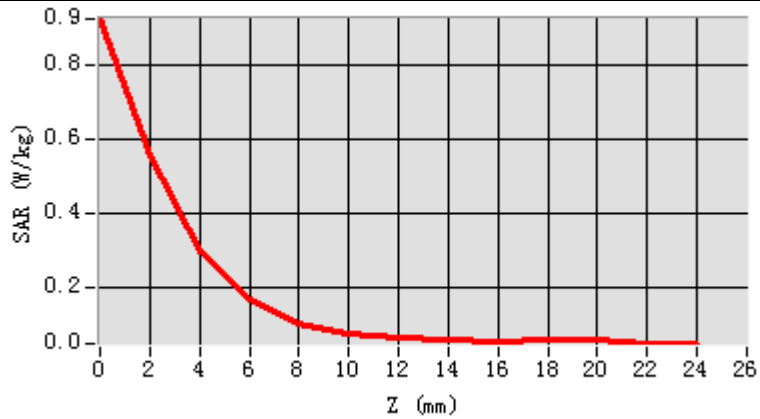

3D screen shot	Hot spot position

MEASUREMENT 12

Date of measurement: 22/10/2023

A. Experimental conditions.

Area Scan	<u>dx=10mm dy=10mm, h= 2.00 mm</u>
ZoomScan	<u>7x7x12,dx=4mm dy=4mm dz=2mm</u>
Phantom	<u>Left head</u>
Device Position	<u>Cheek</u>
Band	<u>IEEE 802.11ax U-NII</u>
Channels	<u>High</u>
Signal	<u>IEEE802.11ax (Crest factor: 1.0)</u>
ConvF	<u>2.04</u>

B. SAR Measurement Results

Frequency (MHz)	5825.000000
Relative permittivity (real part)	35.111285
Relative permittivity (imaginary part)	15.926337
Conductivity (S/m)	5.153940
Variation (%)	-3.630000

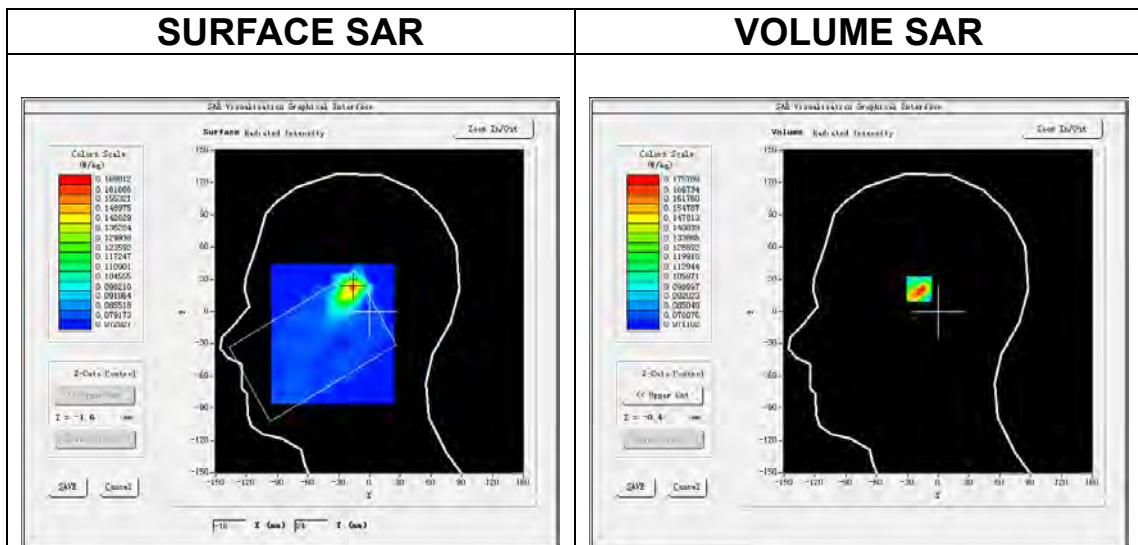

Maximum location: X=-16.00, Y=23.00
SAR Peak: 0.39 W/kg

SAR 10g (W/Kg)	0.106264
SAR 1g (W/Kg)	0.173848

Z (m m)	0.00	2.00	4.00	6.00	8.00	10.0	12.0	14.0	16.0	18.0	20.0	22.0
SAR (W/ Kg)	0.2564	0.1757	0.1136	0.0932	0.0824	0.0809	0.0765	0.0752	0.0797	0.0756	0.0764	0.0800

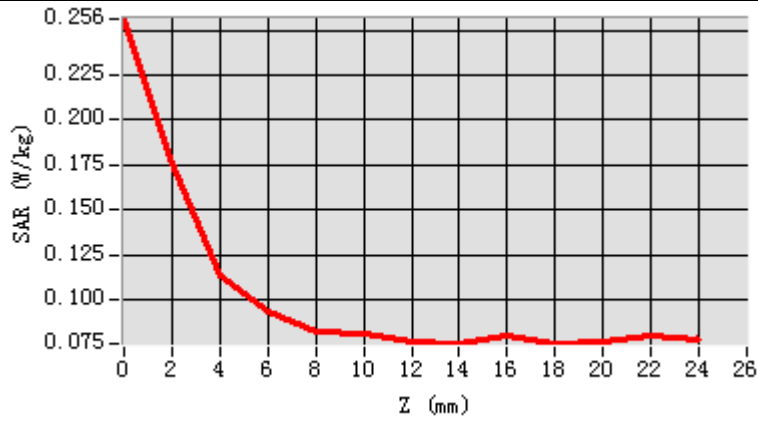

3D screen shot	Hot spot position

MEASUREMENT 13

Date of measurement: 21/10/2023

A. Experimental conditions.

Area Scan	<u>dx=10mm dy=10mm, h= 2.00 mm</u>
ZoomScan	<u>7x7x12,dx=4mm dy=4mm dz=2mm</u>
Phantom	<u>Validation plane</u>
Device Position	<u>Body</u>
Band	<u>IEEE 802.11ax U-NII</u>
Channels	<u>Middle</u>
Signal	<u>IEEE802.11ax (Crest factor: 1.0)</u>
ConvF	<u>2.07</u>

B. SAR Measurement Results

Frequency (MHz)	5200.000000
Relative permittivity (real part)	35.782074
Relative permittivity (imaginary part)	15.813428
Conductivity (S/m)	4.568324
Variation (%)	2.750000

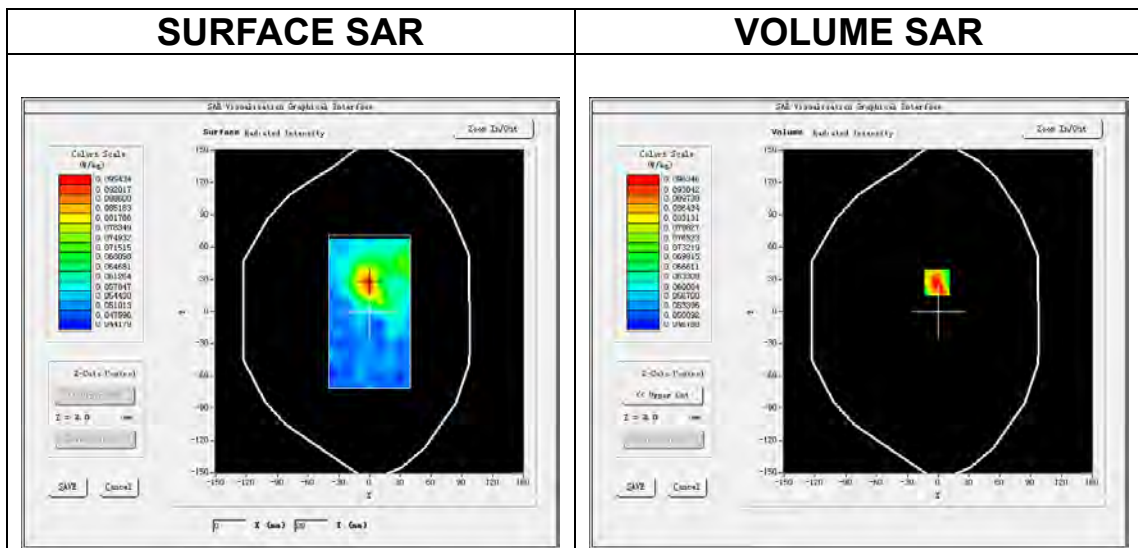

Maximum location: X=-1.00, Y=27.00
SAR Peak: 0.14 W/kg

SAR 10g (W/Kg)	0.062560
SAR 1g (W/Kg)	0.076930

Z (m m)	0.00	2.00	4.00	6.00	8.00	10.0	12.0	14.0	16.0	18.0	20.0	22.0
SA R (W/ Kg)	0.12 43	0.09 63	0.07 11	0.06 35	0.06 10	0.05 63	0.05 94	0.05 33	0.04 96	0.05 48	0.05 52	0.05 23

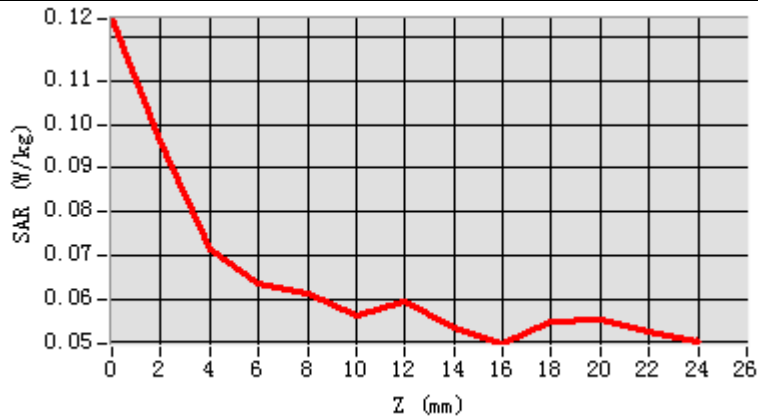

3D screen shot

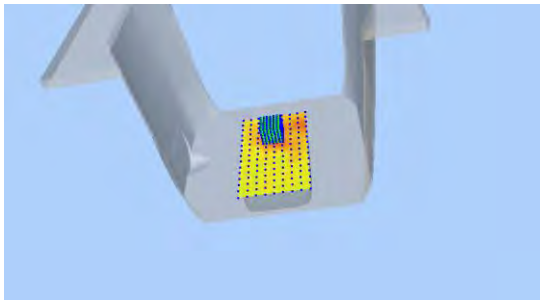

Hot spot position

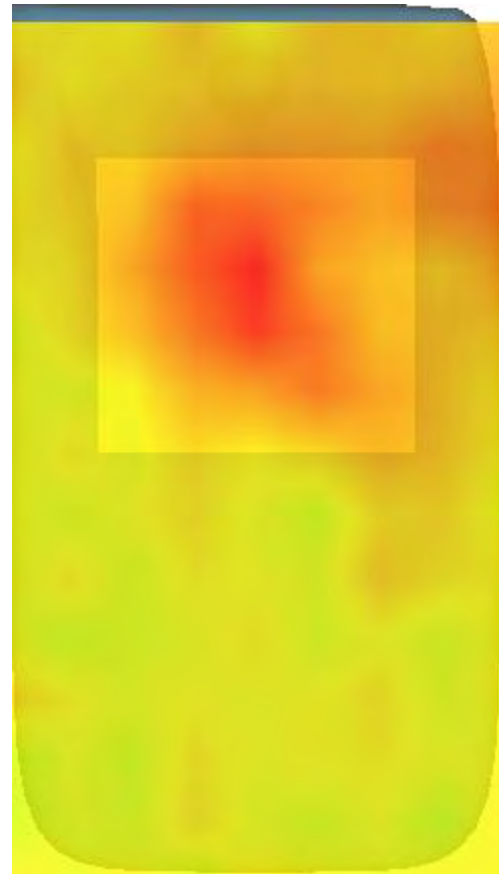

MEASUREMENT 14

Date of measurement: 22/10/2023

A. Experimental conditions.

Area Scan	<u>dx=10mm dy=10mm, h= 2.00 mm</u>
ZoomScan	<u>7x7x12,dx=4mm dy=4mm dz=2mm</u>
Phantom	<u>Validation plane</u>
Device Position	<u>Body</u>
Band	<u>IEEE 802.11ax U-NII</u>
Channels	<u>High</u>
Signal	<u>IEEE802.11ax (Crest factor: 1.0)</u>
ConvF	<u>2.04</u>

B. SAR Measurement Results

Frequency (MHz)	5825.000000
Relative permittivity (real part)	35.111285
Relative permittivity (imaginary part)	15.926337
Conductivity (S/m)	5.153940
Variation (%)	-4.280000

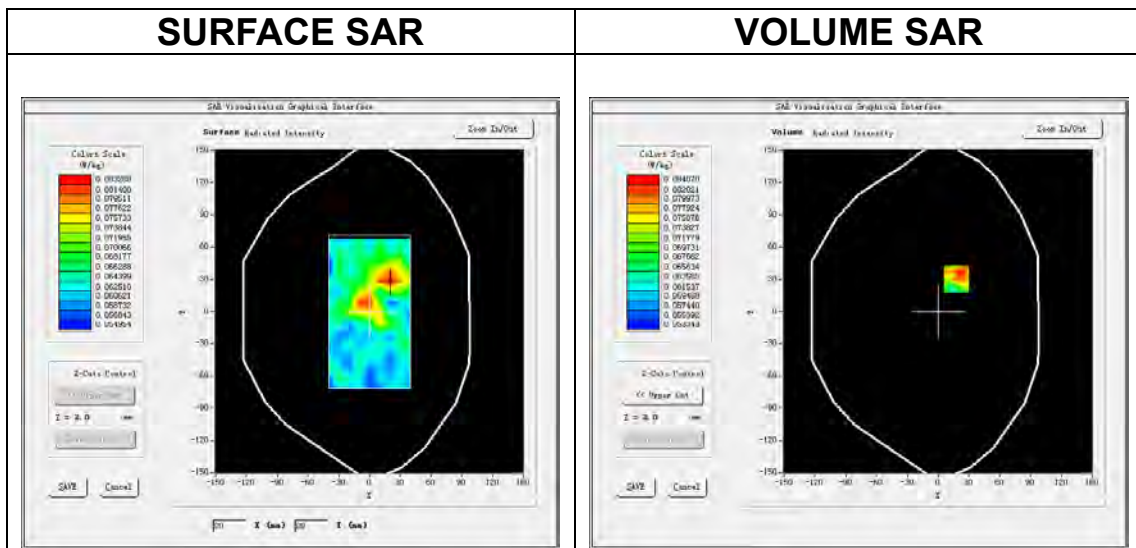

Maximum location: X=18.00, Y=30.00
SAR Peak: 0.11 W/kg

SAR 10g (W/Kg)	0.067546
SAR 1g (W/Kg)	0.074941

Z (m m)	0.00	2.00	4.00	6.00	8.00	10.00	12.00	14.00	16.00	18.00	20.00	22.00
SAR (W/Kg)	0.1060	0.0841	0.0658	0.0696	0.0583	0.0664	0.0636	0.0680	0.0665	0.0600	0.0639	0.0685

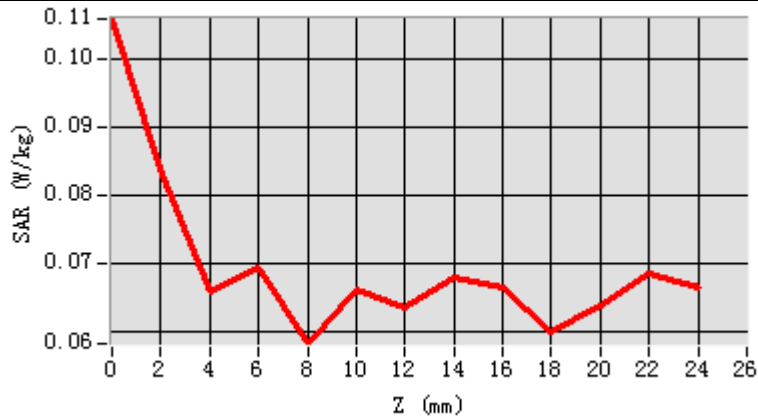

3D screen shot

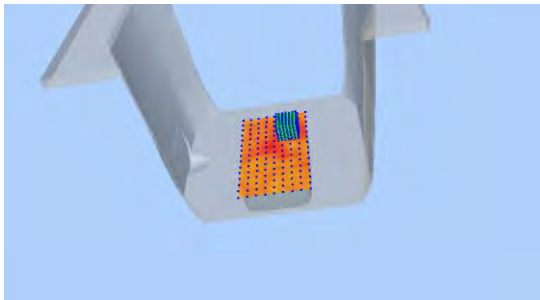

Hot spot position



MEASUREMENT 15

Date of measurement: 28/10/2023

A. Experimental conditions.

Area Scan	<u>dx=12mm dy=12mm, h= 5.00 mm</u>
ZoomScan	<u>7x7x7,dx=5mm dy=5mm dz=5mm</u>
Phantom	<u>Left head</u>
Device Position	<u>Cheek</u>
Band	<u>IEEE 802.11b ISM</u>
Channels	<u>Low</u>
Signal	<u>IEEE802.11b (Crest factor: 1.0)</u>
ConvF	<u>2.85</u>

B. SAR Measurement Results

Frequency (MHz)	2412.000000
Relative permittivity (real part)	38.825333
Relative permittivity (imaginary part)	13.164810
Conductivity (S/m)	1.764085
Variation (%)	0.070000

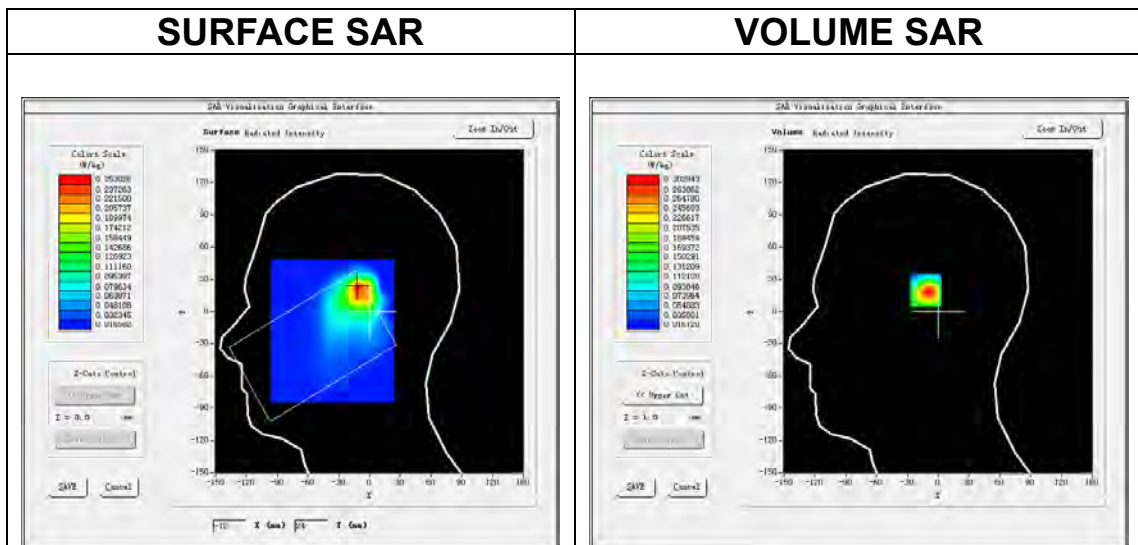

Maximum location: X=-10.00, Y=21.00
SAR Peak: 0.52 W/kg

SAR 10g (W/Kg)	0.134000
SAR 1g (W/Kg)	0.280384

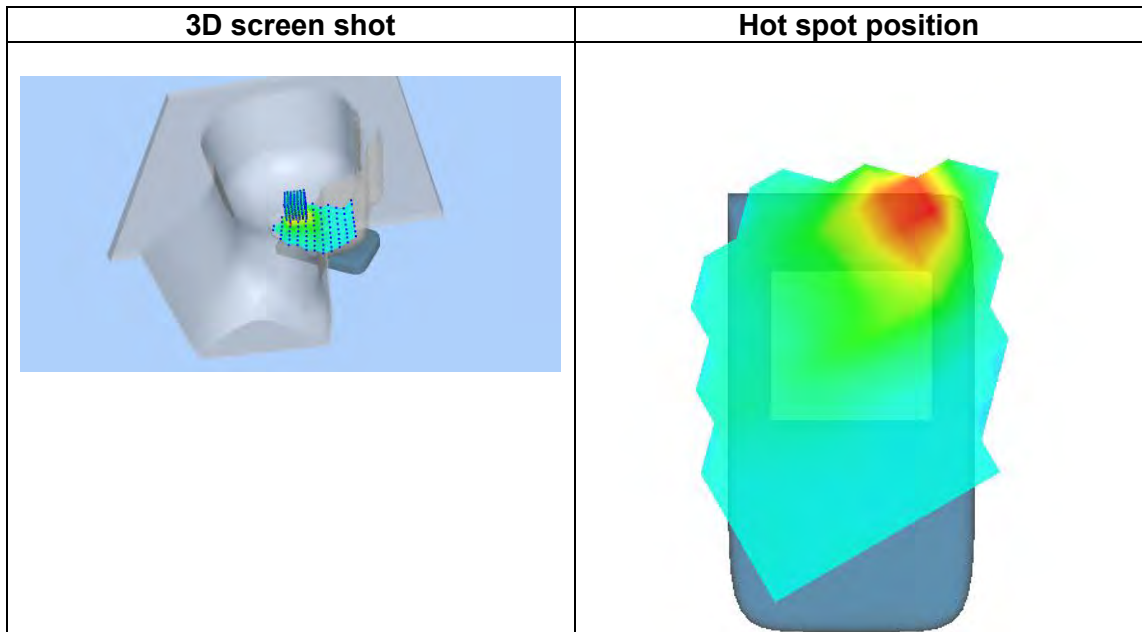
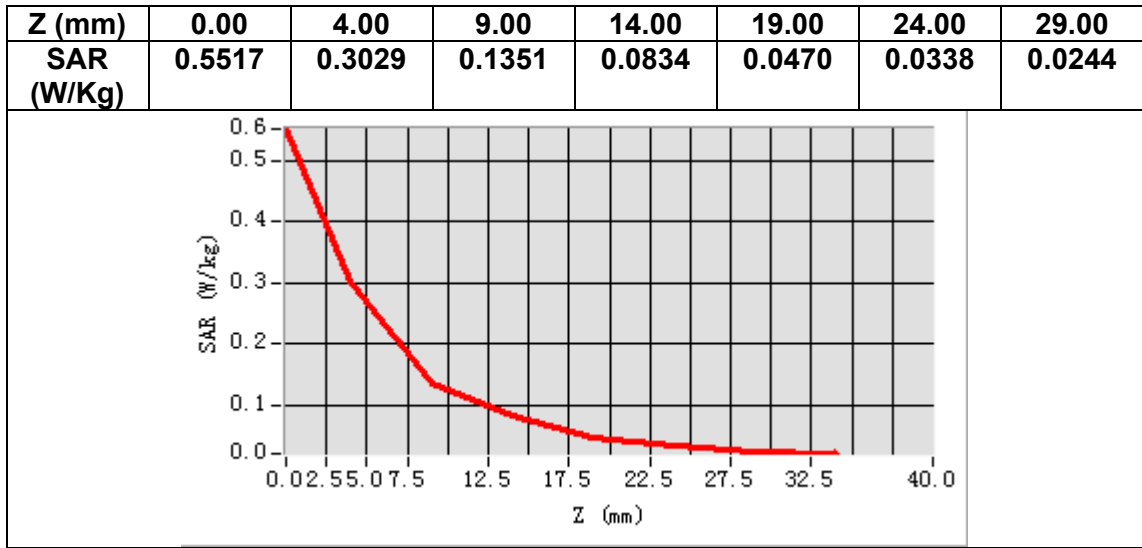

MEASUREMENT 16

Date of measurement: 28/10/2023

A. Experimental conditions.

Area Scan	<u>dx=12mm dy=12mm, h= 5.00 mm</u>
ZoomScan	<u>7x7x7,dx=5mm dy=5mm dz=5mm</u>
Phantom	<u>Validation plane</u>
Device Position	<u>Body</u>
Band	<u>IEEE 802.11b ISM</u>
Channels	<u>Low</u>
Signal	<u>IEEE802.11b (Crest factor: 1.0)</u>
ConvF	<u>2.85</u>

B. SAR Measurement Results

Frequency (MHz)	2412.000000
Relative permittivity (real part)	38.825333
Relative permittivity (imaginary part)	13.164810
Conductivity (S/m)	1.764085
Variation (%)	-3.500000

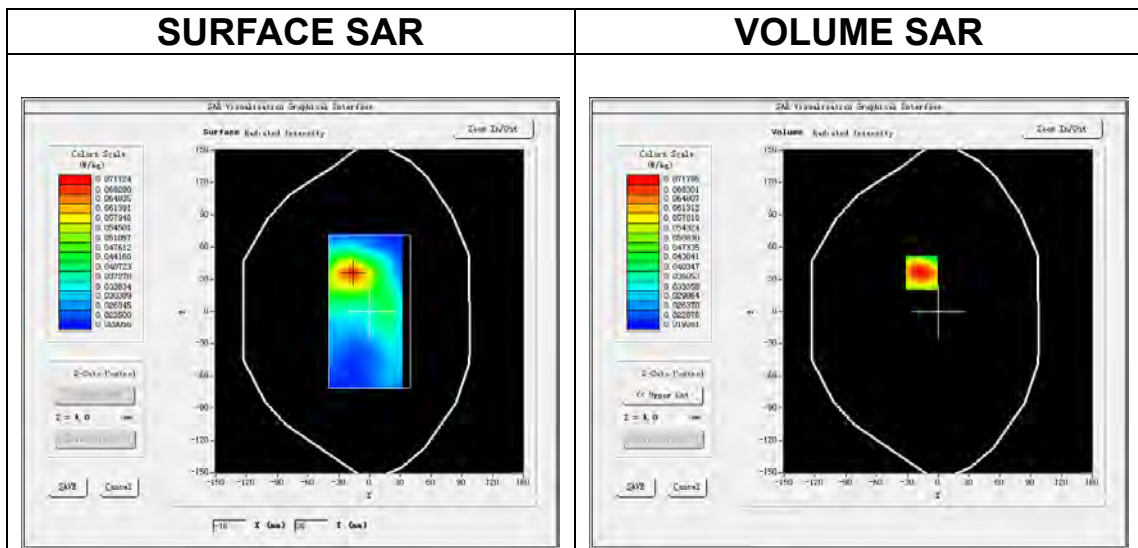

Maximum location: X=-16.00, Y=36.00
SAR Peak: 0.10 W/kg

SAR 10g (W/Kg)	0.046263
SAR 1g (W/Kg)	0.069566

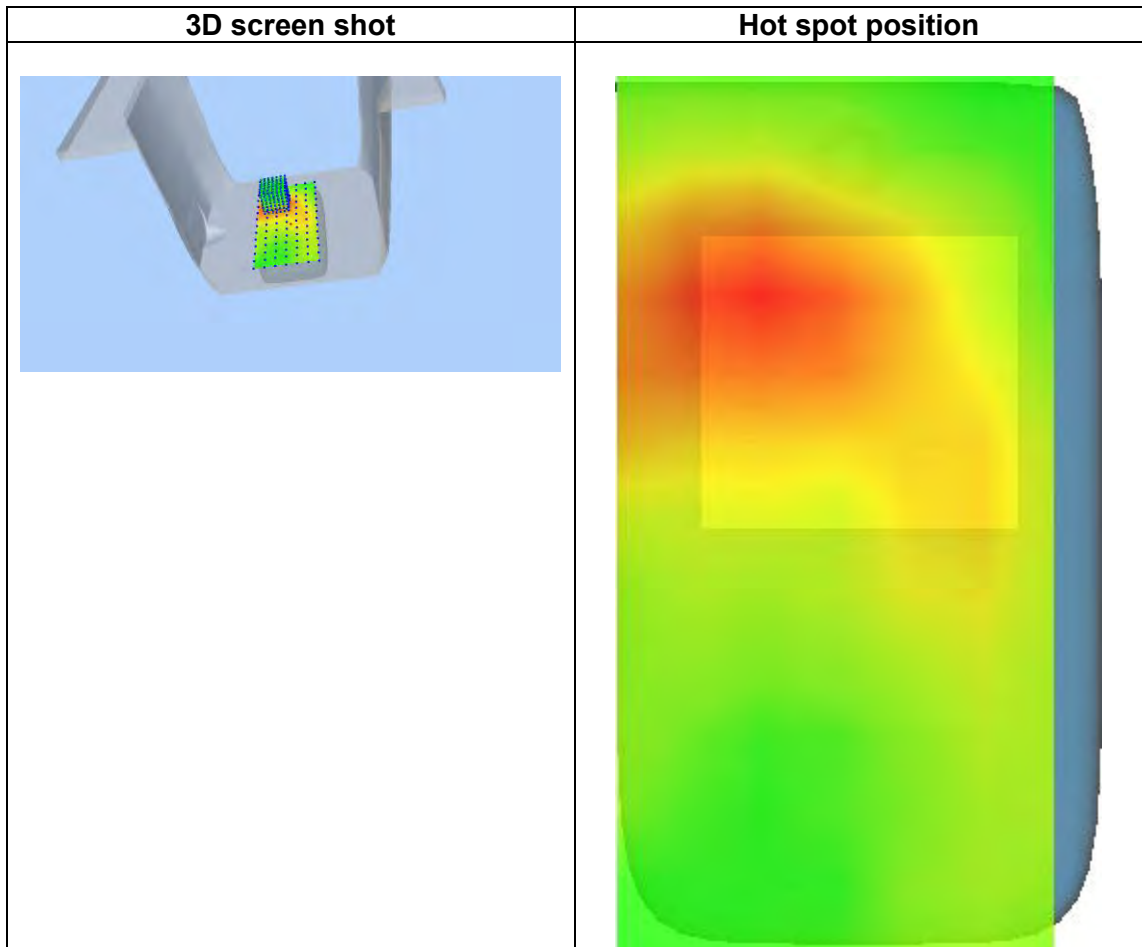
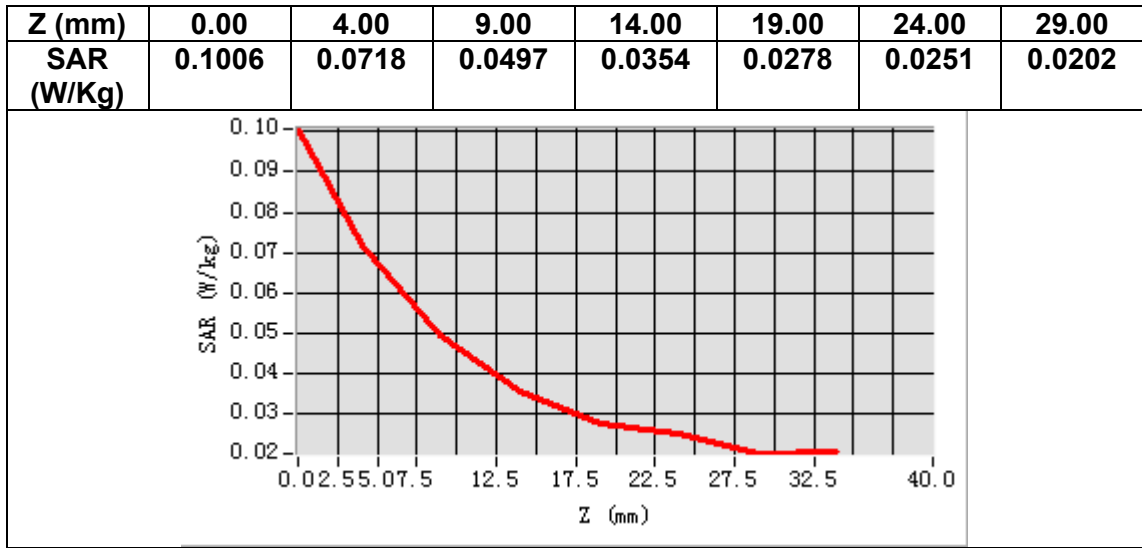

MEASUREMENT 17

Date of measurement: 24/10/2023

A. Experimental conditions.

Area Scan	<u>dx=15mm dy=15mm, h= 5.00 mm</u>
ZoomScan	<u>5x5x7, dx=8mm dy=8mm dz=5mm</u>
Phantom	<u>Left head</u>
Device Position	<u>Cheek</u>
Band	<u>LTE band 2</u>
Channels	<u>Middle</u>
Signal	<u>LTE (Crest factor: 1.0)</u>
ConvF	<u>2.63</u>

B. SAR Measurement Results

Frequency (MHz)	1880.000000
Relative permittivity (real part)	39.098179
Relative permittivity (imaginary part)	13.676342
Conductivity (S/m)	1.428418
Variation (%)	3.690000

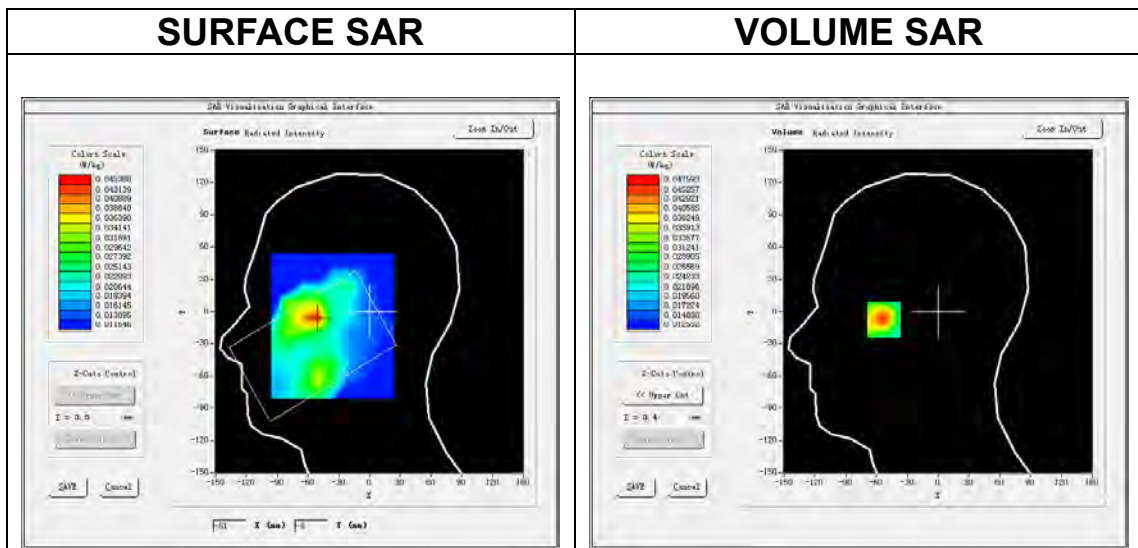

Maximum location: X=-53.00, Y=-5.00
SAR Peak: 0.06 W/kg

SAR 10g (W/Kg)	0.030404
SAR 1g (W/Kg)	0.045321

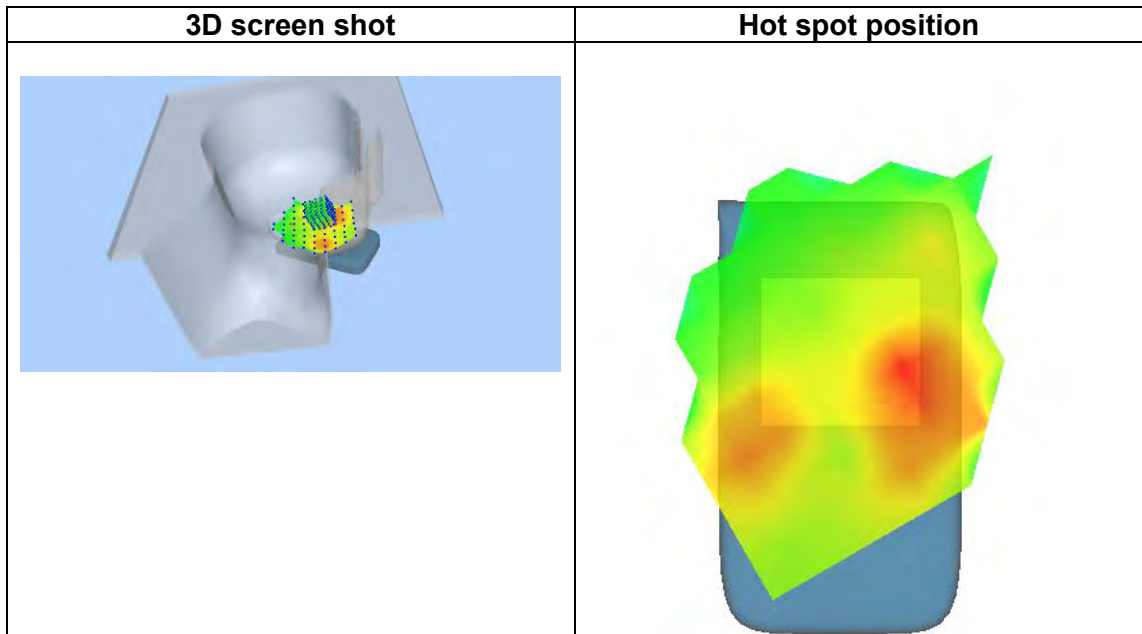
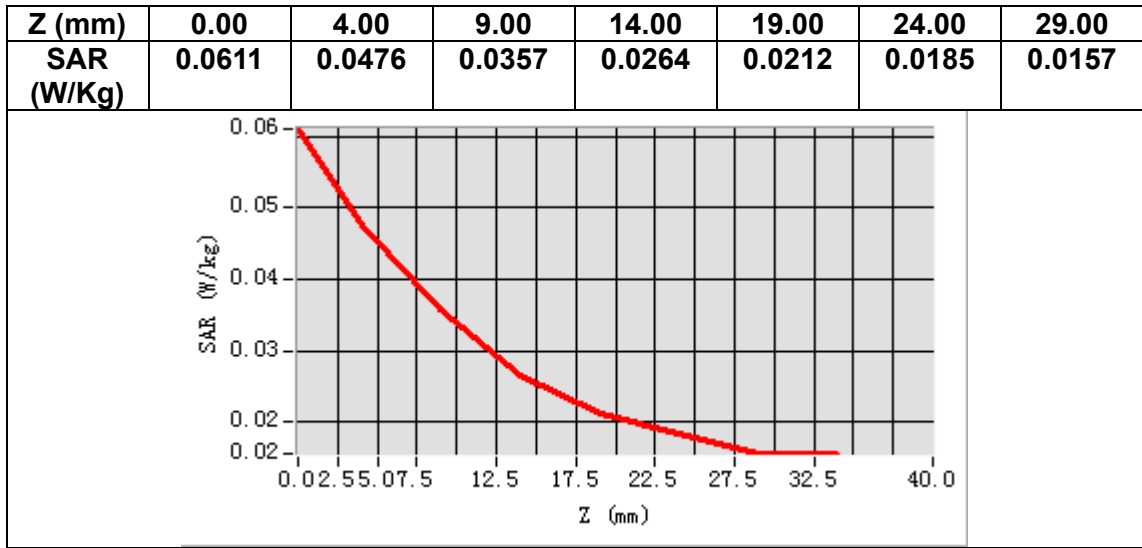

MEASUREMENT 18

Date of measurement: 24/10/2023

A. Experimental conditions.

Area Scan	<u>dx=15mm dy=15mm, h= 5.00 mm</u>
ZoomScan	<u>5x5x7, dx=8mm dy=8mm dz=5mm</u>
Phantom	<u>Validation plane</u>
Device Position	<u>Body</u>
Band	<u>LTE band 2</u>
Channels	<u>Middle</u>
Signal	<u>LTE (Crest factor: 1.0)</u>
ConvF	<u>2.63</u>

B. SAR Measurement Results

Frequency (MHz)	1880.000000
Relative permittivity (real part)	39.098179
Relative permittivity (imaginary part)	13.676342
Conductivity (S/m)	1.428418
Variation (%)	2.370000

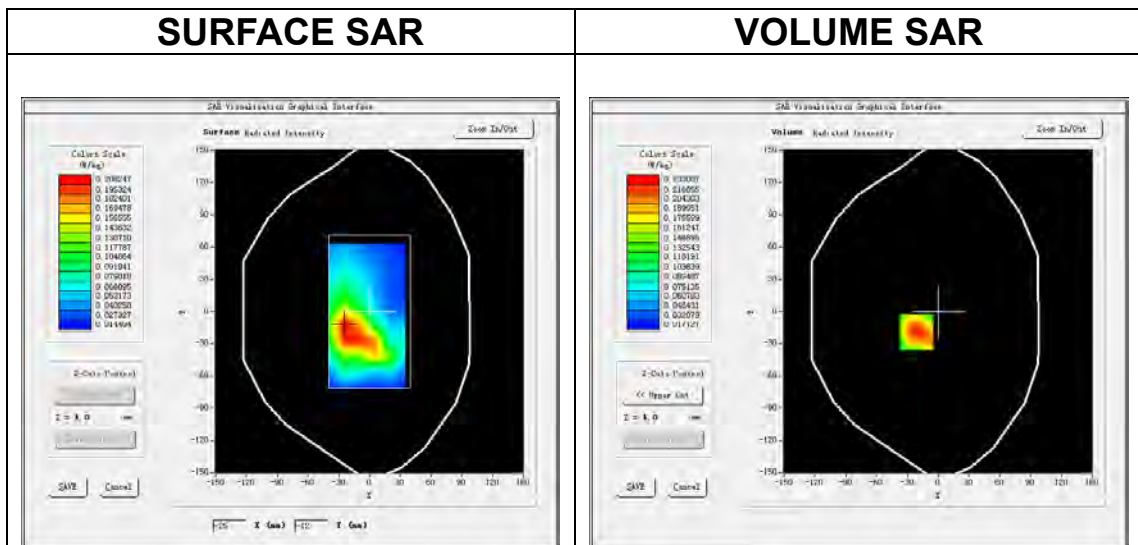

Maximum location: X=-21.00, Y=-19.00
SAR Peak: 0.33 W/kg

SAR 10g (W/Kg)	0.135326
SAR 1g (W/Kg)	0.224891

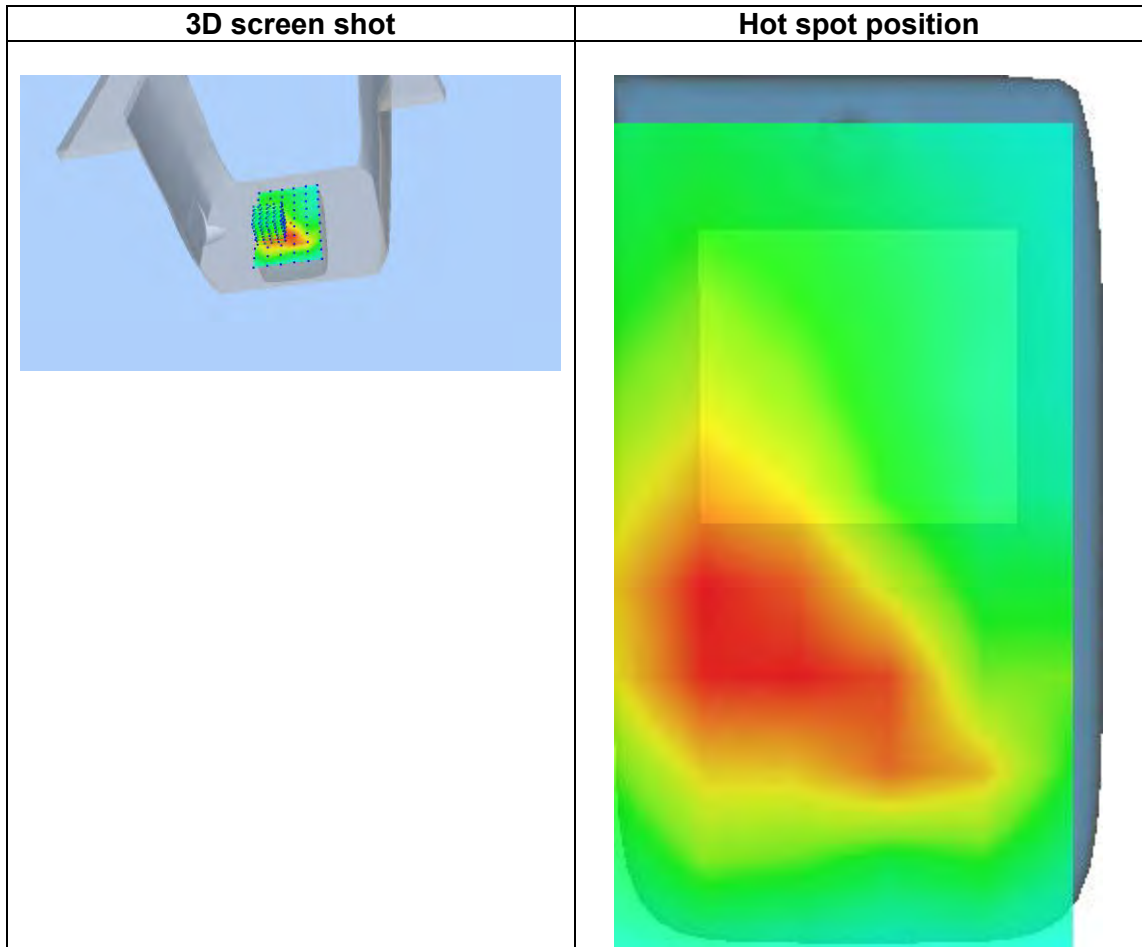
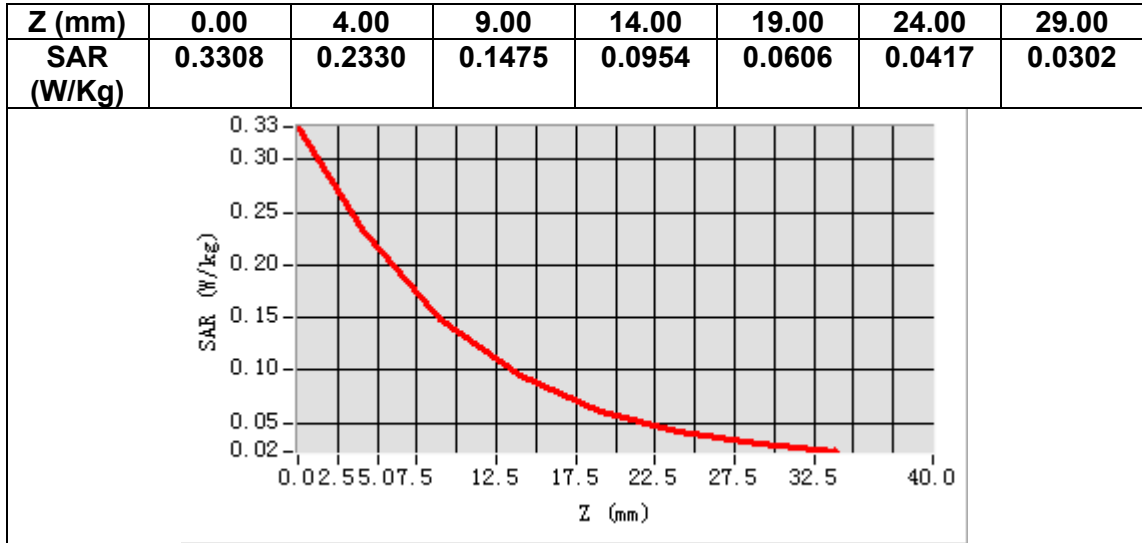

MEASUREMENT 19

Date of measurement: 31/10/2023

A. Experimental conditions.

Area Scan	<u>dx=15mm dy=15mm, h= 5.00 mm</u>
ZoomScan	<u>5x5x7,dx=8mm dy=8mm dz=5mm</u>
Phantom	<u>Left head</u>
Device Position	<u>Cheek</u>
Band	<u>LTE band 4</u>
Channels	<u>Middle</u>
Signal	<u>LTE (Crest factor: 1.0)</u>
ConvF	<u>2.45</u>

B. SAR Measurement Results

Frequency (MHz)	1732.500000
Relative permittivity (real part)	40.523621
Relative permittivity (imaginary part)	14.255795
Conductivity (S/m)	1.372120
Variation (%)	-0.190000

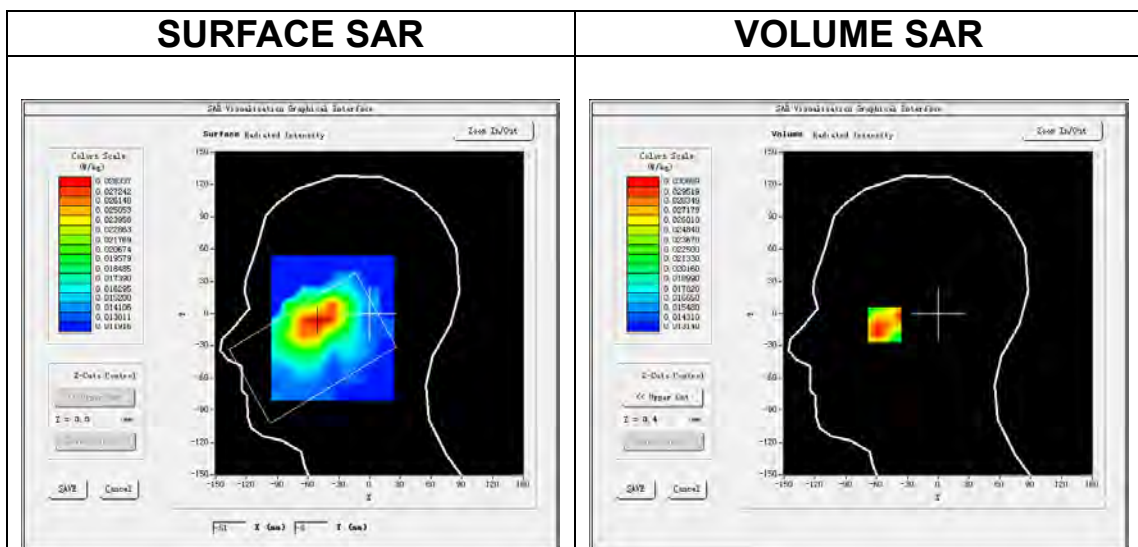

Maximum location: X=-52.00, Y=-8.00
SAR Peak: 0.04 W/kg

SAR 10g (W/Kg)	0.022906
SAR 1g (W/Kg)	0.030101

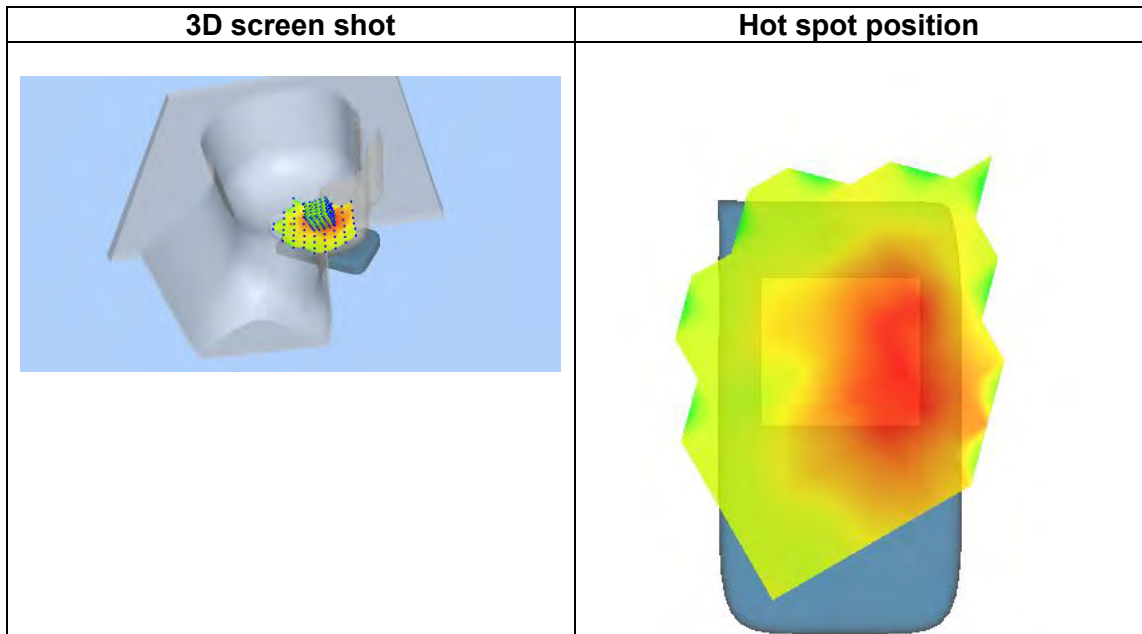
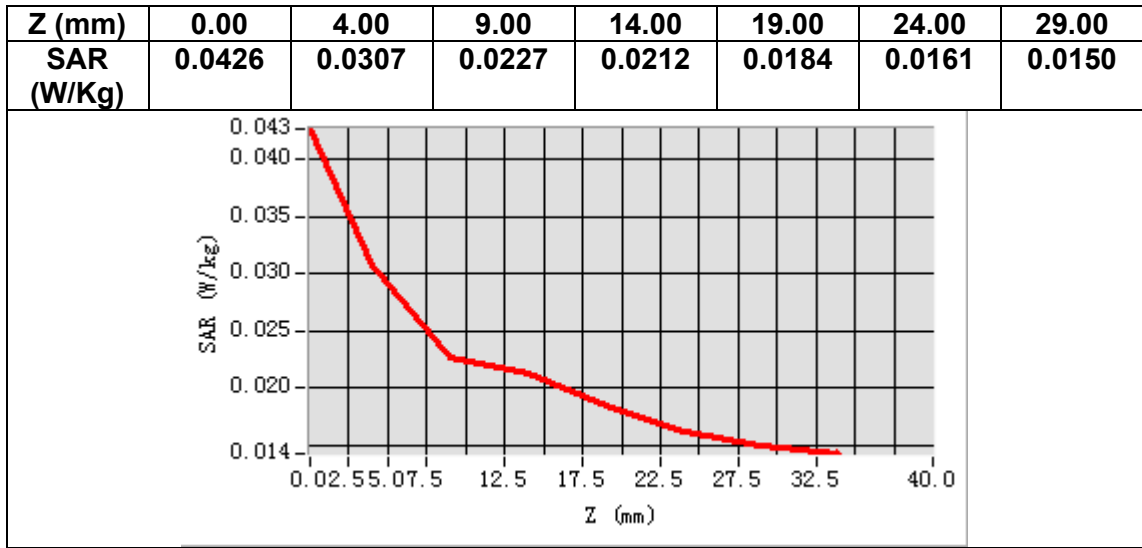

MEASUREMENT 20

Date of measurement: 31/10/2023

A. Experimental conditions.

Area Scan	<u>dx=15mm dy=15mm, h= 5.00 mm</u>
ZoomScan	<u>5x5x7, dx=8mm dy=8mm dz=5mm</u>
Phantom	<u>Validation plane</u>
Device Position	<u>Body</u>
Band	<u>LTE band 4</u>
Channels	<u>Middle</u>
Signal	<u>LTE (Crest factor: 1.0)</u>
ConvF	<u>2.45</u>

B. SAR Measurement Results

Frequency (MHz)	1732.500000
Relative permittivity (real part)	40.523621
Relative permittivity (imaginary part)	14.255795
Conductivity (S/m)	1.372120
Variation (%)	0.610000

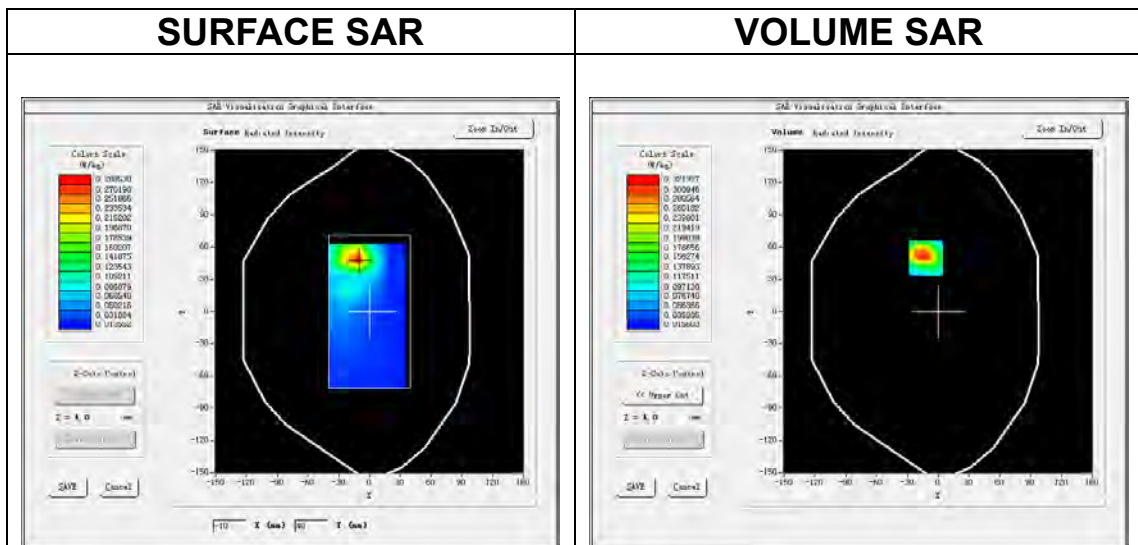

Maximum location: X=-12.00, Y=50.00
SAR Peak: 0.51 W/kg

SAR 10g (W/Kg)	0.159049
SAR 1g (W/Kg)	0.310352

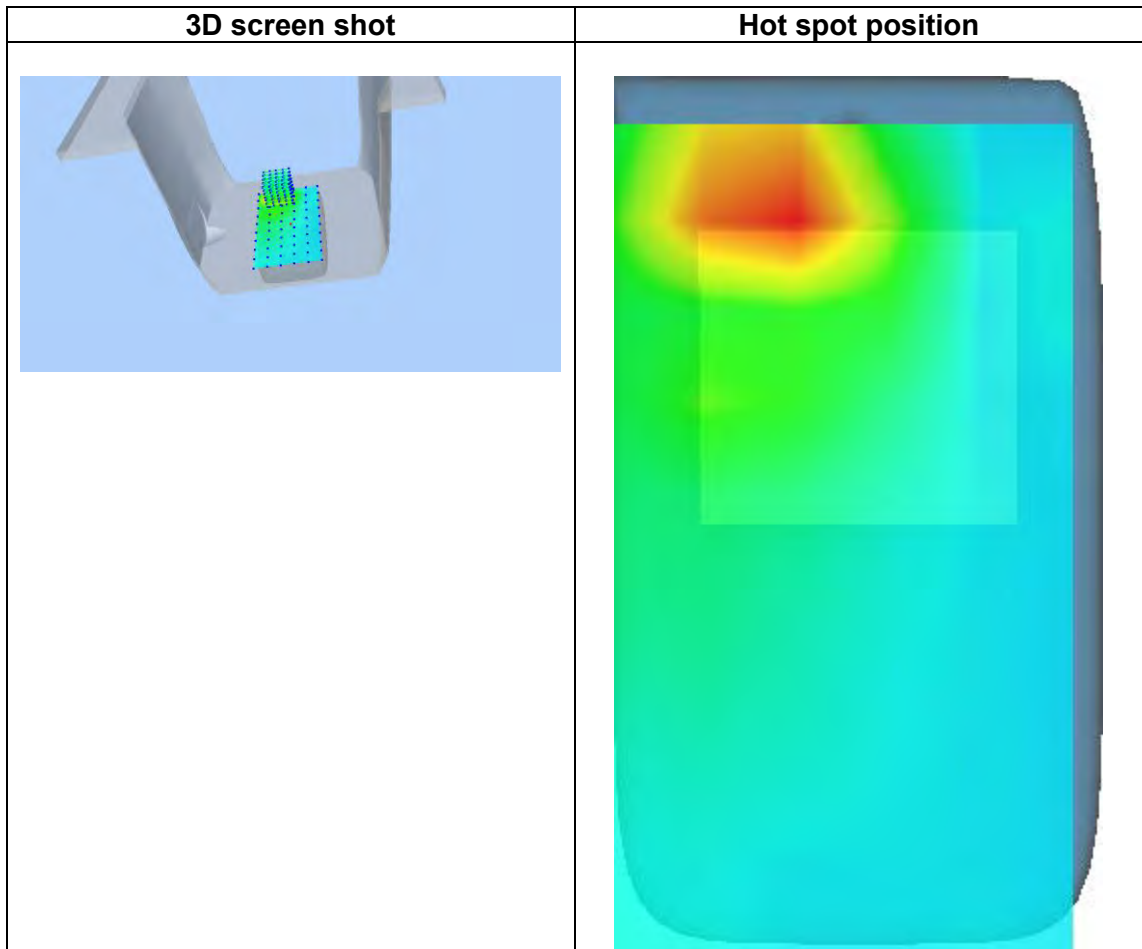
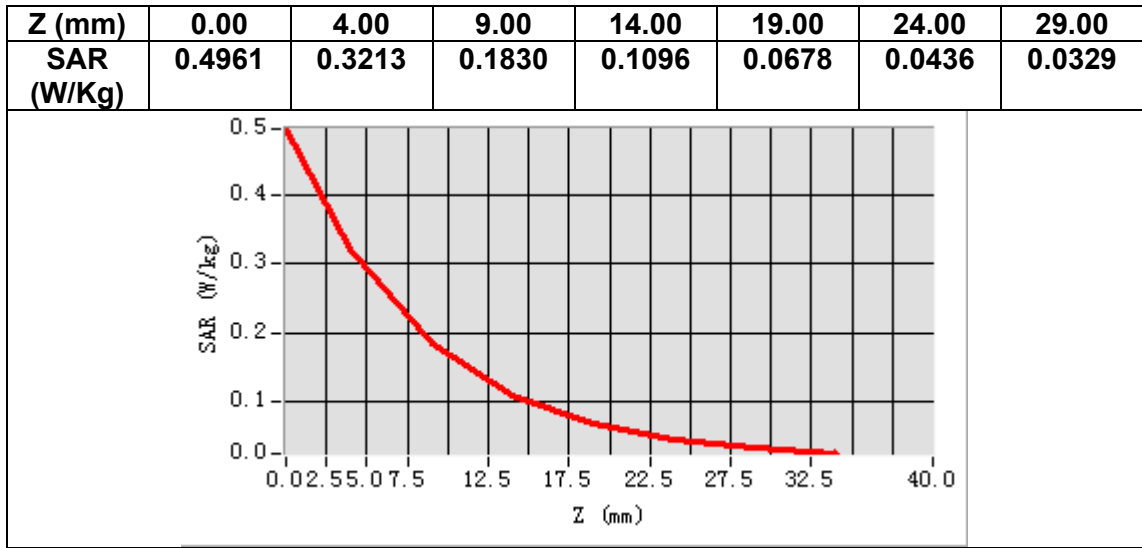

MEASUREMENT 21

Date of measurement: 23/10/2023

A. Experimental conditions.

Area Scan	<u>dx=15mm dy=15mm, h= 5.00 mm</u>
ZoomScan	<u>5x5x7, dx=8mm dy=8mm dz=5mm</u>
Phantom	<u>Left head</u>
Device Position	<u>Cheek</u>
Band	<u>LTE band 5</u>
Channels	<u>Middle</u>
Signal	<u>LTE (Crest factor: 1.0)</u>
ConvF	<u>2.32</u>

B. SAR Measurement Results

Frequency (MHz)	836.500000
Relative permittivity (real part)	41.298199
Relative permittivity (imaginary part)	21.628727
Conductivity (S/m)	1.005135
Variation (%)	0.710000

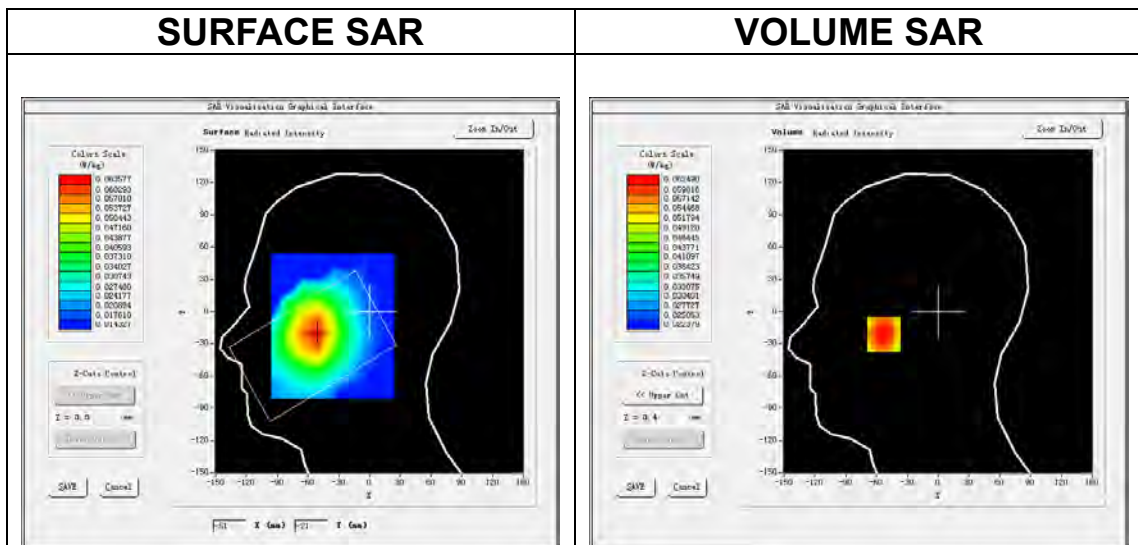

Maximum location: X=-53.00, Y=-21.00
SAR Peak: 0.07 W/kg

SAR 10g (W/Kg)	0.052805
SAR 1g (W/Kg)	0.065782

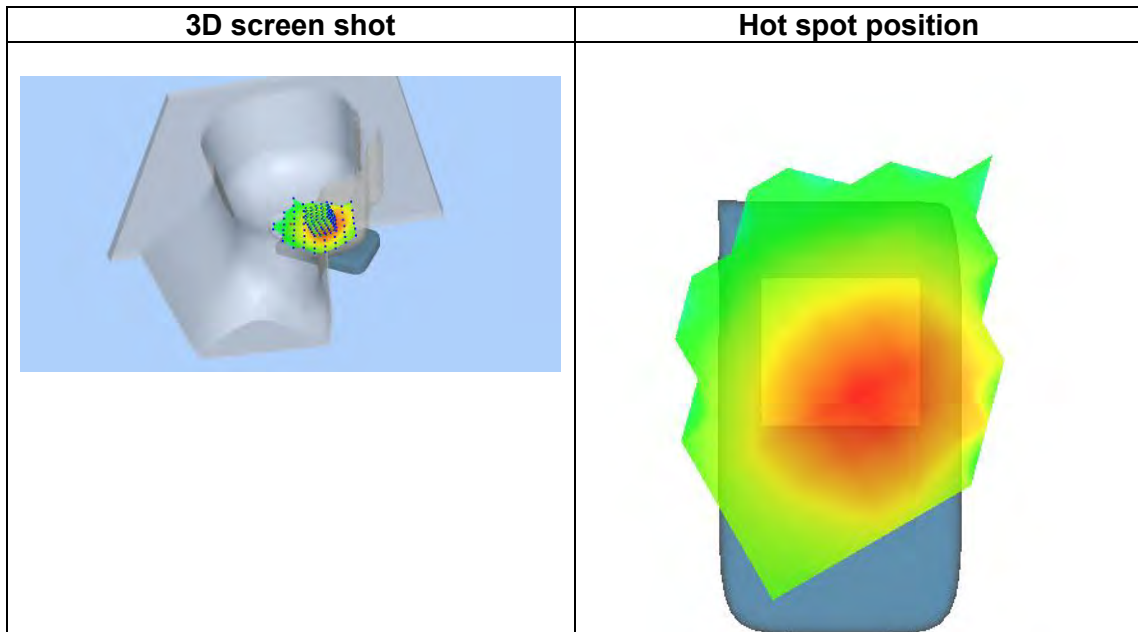
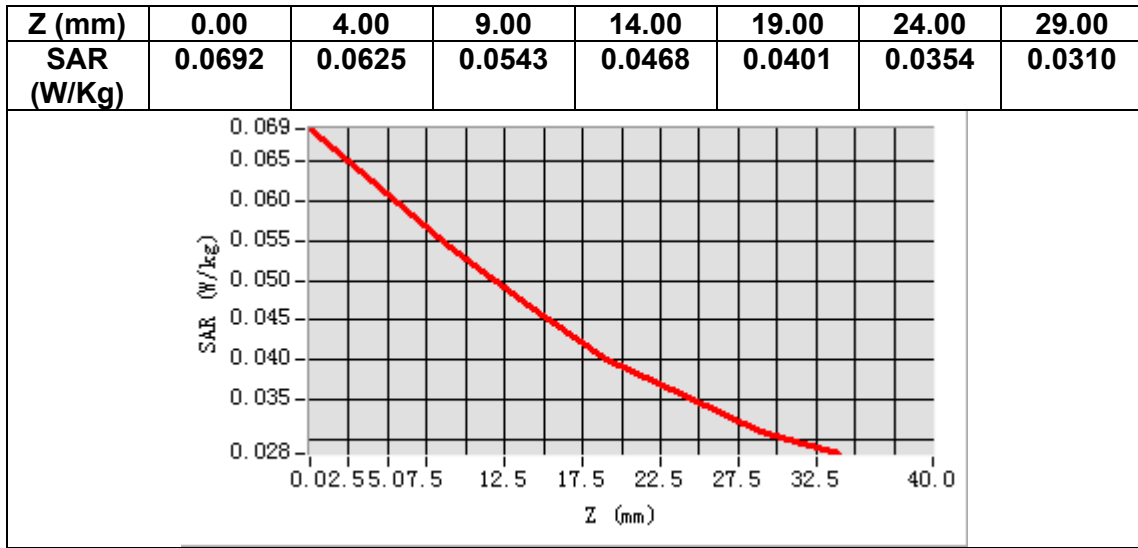

MEASUREMENT 22

Date of measurement: 23/10/2023

A. Experimental conditions.

Area Scan	<u>dx=15mm dy=15mm, h= 5.00 mm</u>
ZoomScan	<u>5x5x7, dx=8mm dy=8mm dz=5mm</u>
Phantom	<u>Validation plane</u>
Device Position	<u>Body</u>
Band	<u>LTE band 5</u>
Channels	<u>Middle</u>
Signal	<u>LTE (Crest factor: 1.0)</u>
ConvF	<u>2.32</u>

B. SAR Measurement Results

Frequency (MHz)	836.500000
Relative permittivity (real part)	41.298199
Relative permittivity (imaginary part)	21.628727
Conductivity (S/m)	1.005135
Variation (%)	0.110000

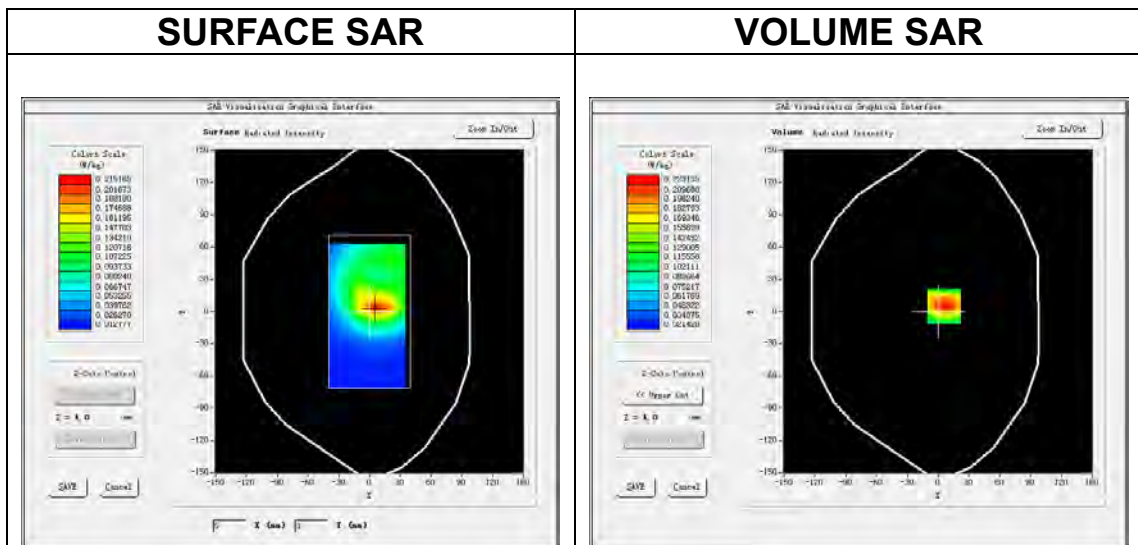

Maximum location: X=6.00, Y=5.00
SAR Peak: 0.32 W/kg

SAR 10g (W/Kg)	0.140292
SAR 1g (W/Kg)	0.229683

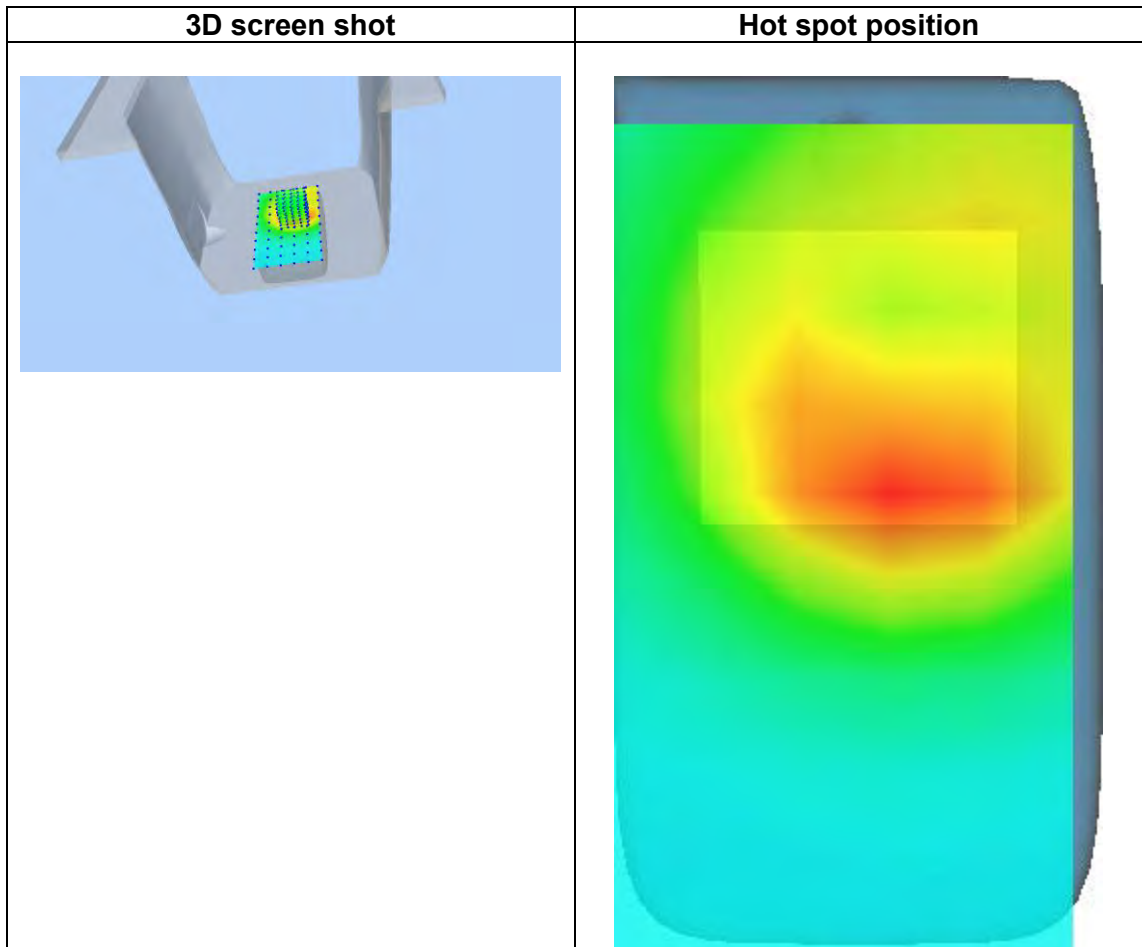
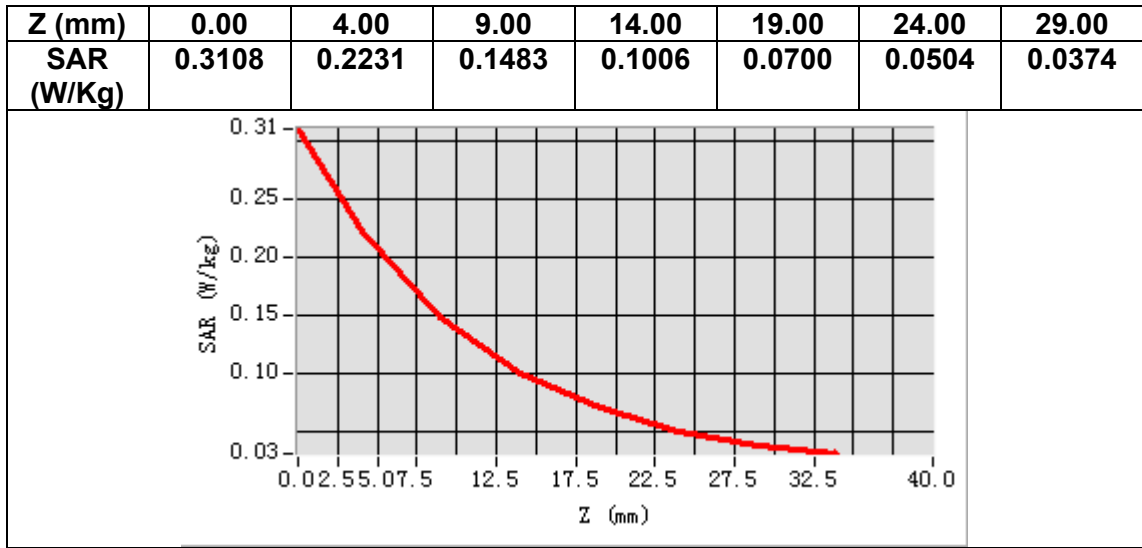

MEASUREMENT 23

Date of measurement: 29/10/2023

A. Experimental conditions.

<u>Area Scan</u>	<u>dx=12mm dy=12mm, h= 5.00 mm</u>
<u>ZoomScan</u>	<u>7x7x7,dx=5mm dy=5mm dz=5mm</u>
<u>Phantom</u>	<u>Left head</u>
<u>Device Position</u>	<u>Cheek</u>
<u>Band</u>	<u>LTE band 7</u>
<u>Channels</u>	<u>Middle</u>
<u>Signal</u>	<u>LTE (Crest factor: 1.0)</u>
<u>ConvF</u>	<u>2.65</u>

B. SAR Measurement Results

Frequency (MHz)	2535.000000
Relative permittivity (real part)	38.909370
Relative permittivity (imaginary part)	13.105514
Conductivity (S/m)	1.845693
Variation (%)	3.600000

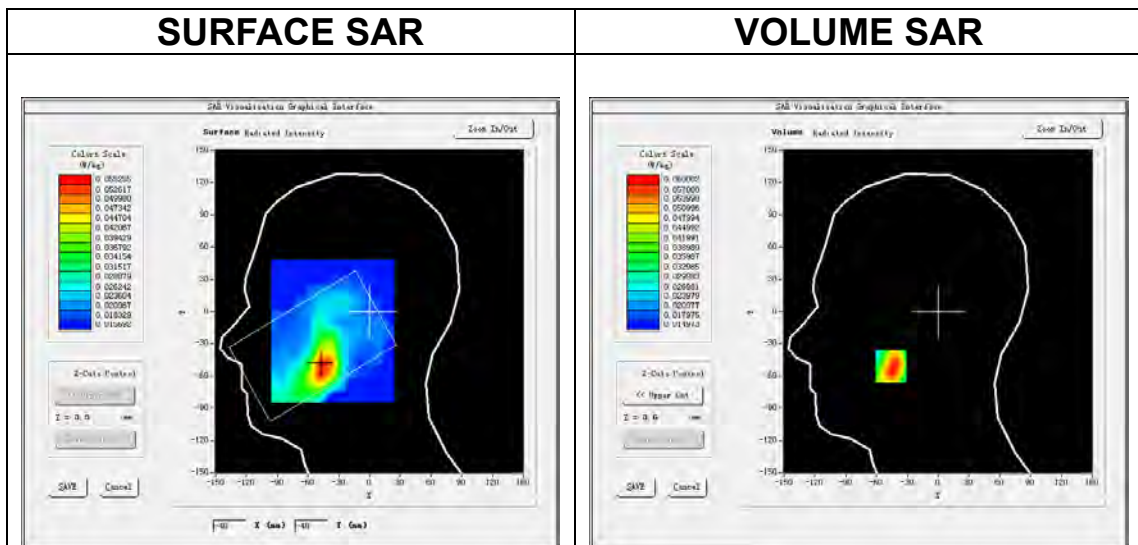

Maximum location: X=-46.00, Y=-51.00
SAR Peak: 0.09 W/kg

SAR 10g (W/Kg)	0.036380
SAR 1g (W/Kg)	0.056293

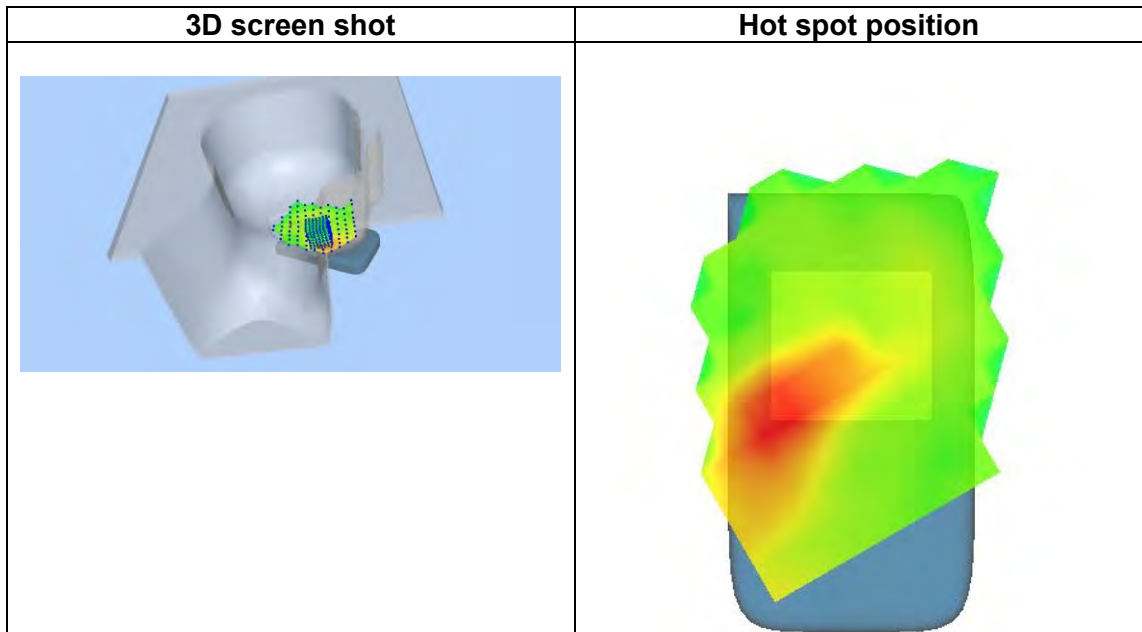
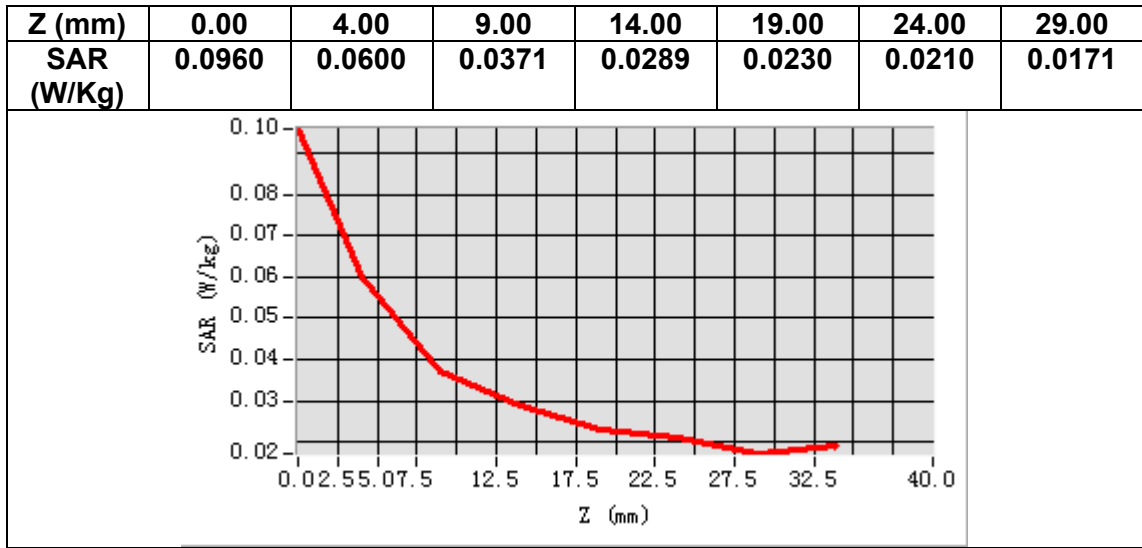

MEASUREMENT 24

Date of measurement: 29/10/2023

A. Experimental conditions.

Area Scan	<u>dx=12mm dy=12mm, h= 5.00 mm</u>
ZoomScan	<u>7x7x7,dx=5mm dy=5mm dz=5mm</u>
Phantom	<u>Validation plane</u>
Device Position	<u>Body</u>
Band	<u>LTE band 7</u>
Channels	<u>Middle</u>
Signal	<u>LTE (Crest factor: 1.0)</u>
ConvF	<u>2.65</u>

B. SAR Measurement Results

Frequency (MHz)	2535.000000
Relative permittivity (real part)	38.909370
Relative permittivity (imaginary part)	13.105514
Conductivity (S/m)	1.845693
Variation (%)	-4.940000

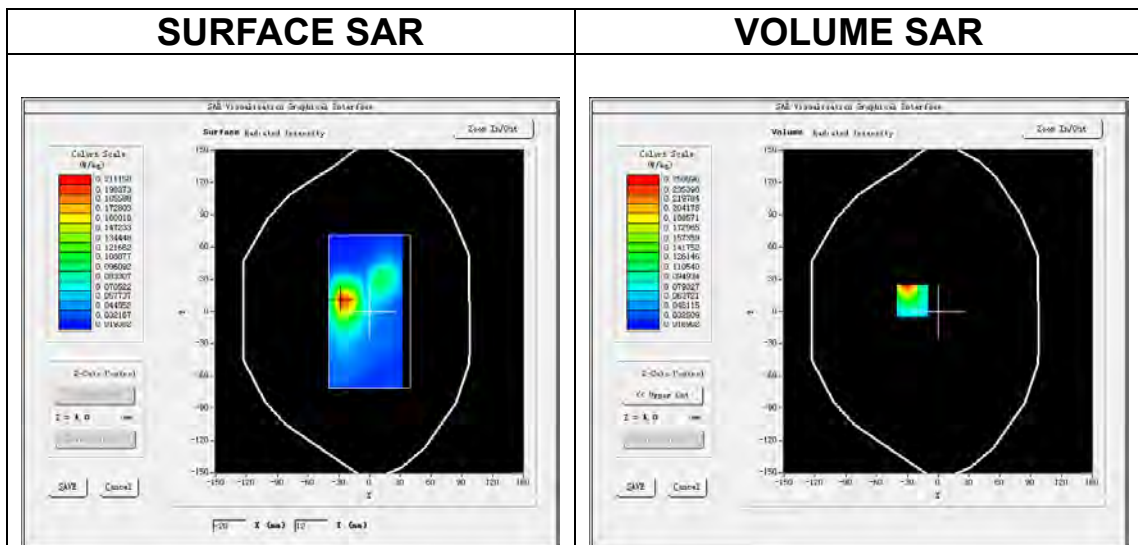

Maximum location: X=-25.00, Y=10.00
SAR Peak: 0.41 W/kg

SAR 10g (W/Kg)	0.095524
SAR 1g (W/Kg)	0.212409

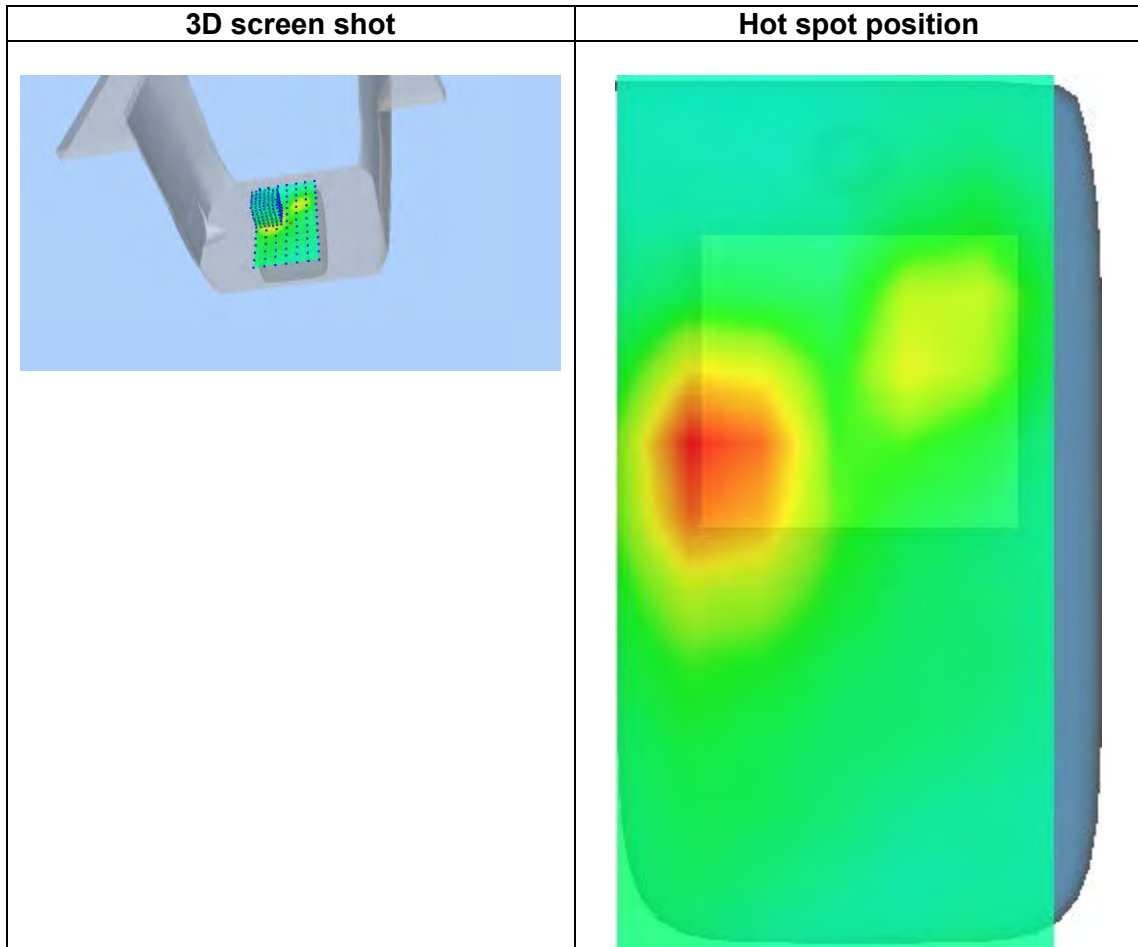
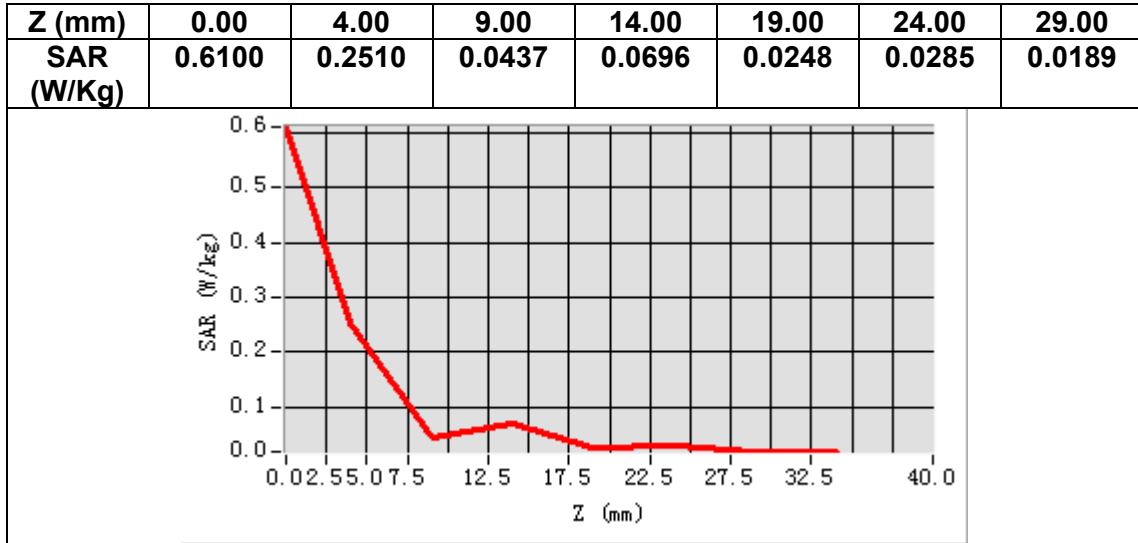

MEASUREMENT 25

Date of measurement: 26/10/2023

A. Experimental conditions.

Area Scan	<u>dx=15mm dy=15mm, h= 5.00 mm</u>
ZoomScan	<u>5x5x7, dx=8mm dy=8mm dz=5mm</u>
Phantom	<u>Left head</u>
Device Position	<u>Cheek</u>
Band	<u>LTE band 12</u>
Channels	<u>Middle</u>
Signal	<u>LTE (Crest factor: 1.0)</u>
ConvF	<u>2.37</u>

B. SAR Measurement Results

Frequency (MHz)	707.500000
Relative permittivity (real part)	42.839897
Relative permittivity (imaginary part)	22.038427
Conductivity (S/m)	0.866233
Variation (%)	0.970000

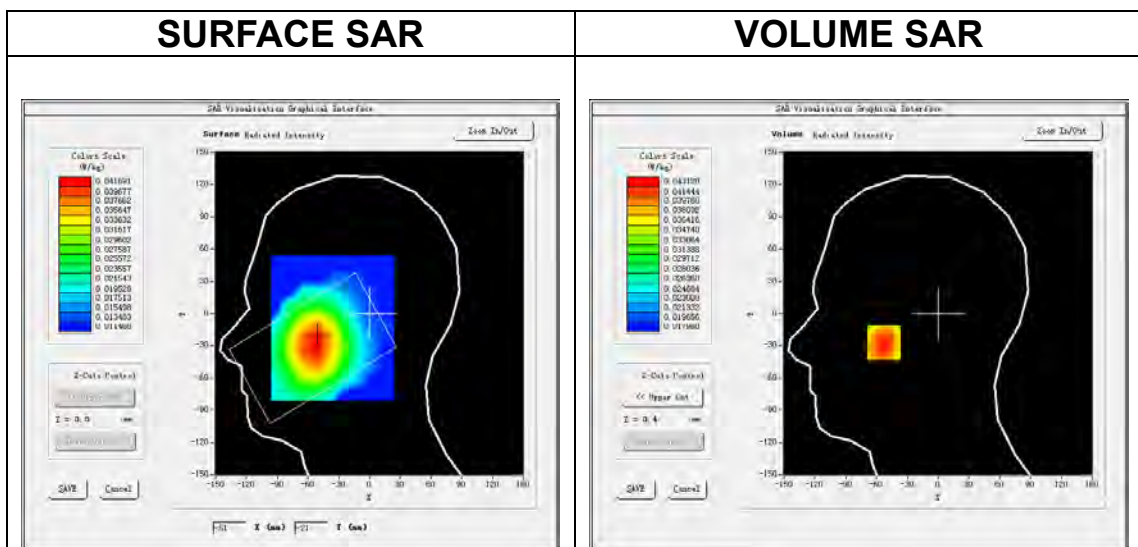

Maximum location: X=-53.00, Y=-27.00
SAR Peak: 0.05 W/kg

SAR 10g (W/Kg)	0.035727
SAR 1g (W/Kg)	0.042458

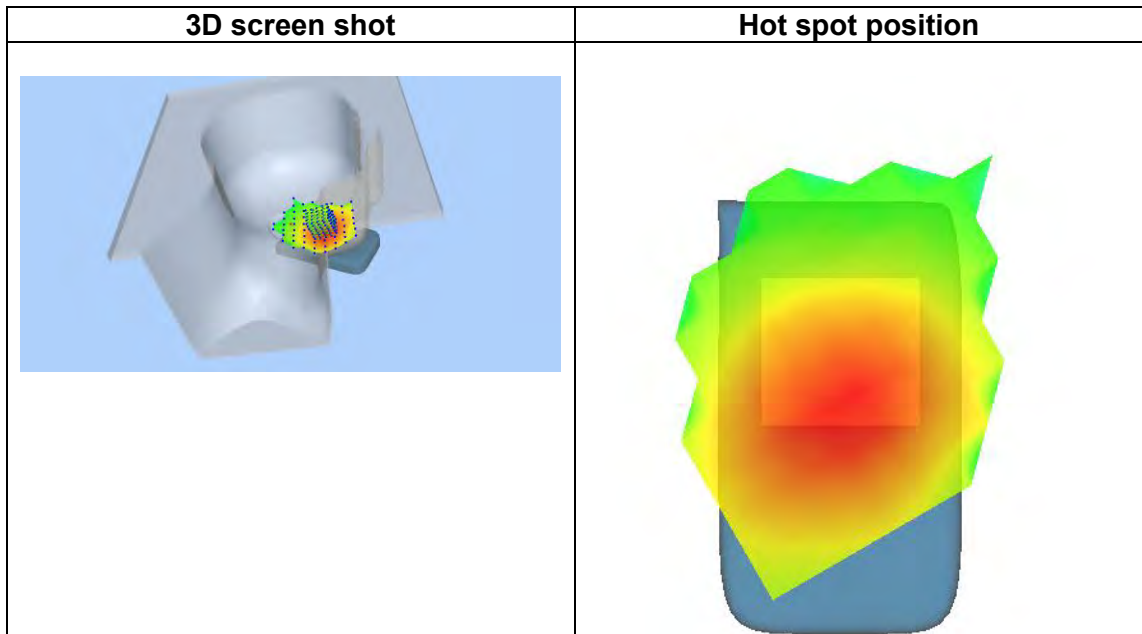
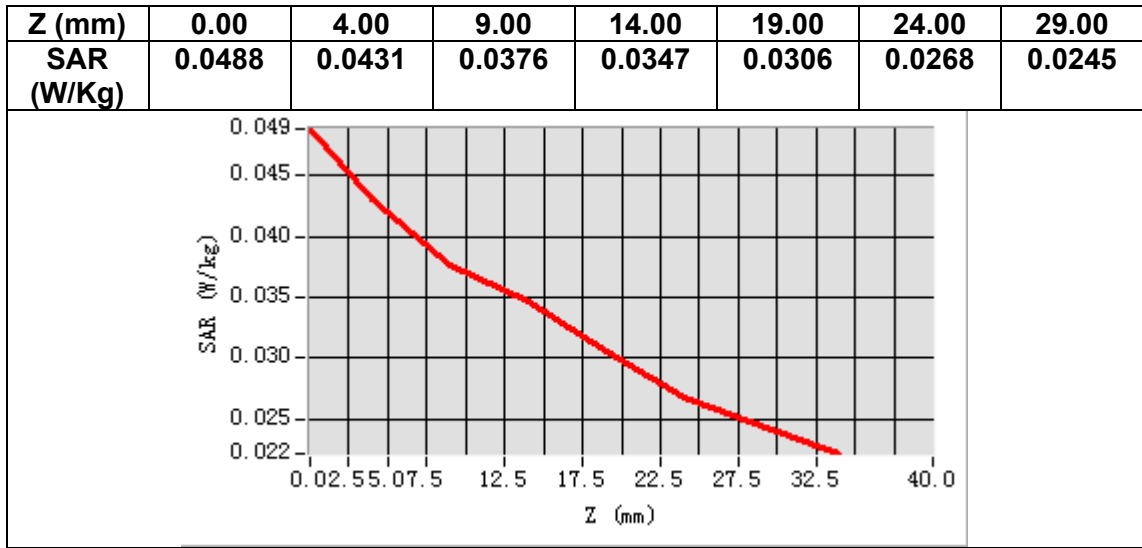

MEASUREMENT 26

Date of measurement: 26/10/2023

A. Experimental conditions.

Area Scan	<u>dx=15mm dy=15mm, h= 5.00 mm</u>
ZoomScan	<u>5x5x7, dx=8mm dy=8mm dz=5mm</u>
Phantom	<u>Validation plane</u>
Device Position	<u>Body</u>
Band	<u>LTE band 12</u>
Channels	<u>Middle</u>
Signal	<u>LTE (Crest factor: 1.0)</u>
ConvF	<u>2.37</u>

B. SAR Measurement Results

Frequency (MHz)	707.500000
Relative permittivity (real part)	42.839897
Relative permittivity (imaginary part)	22.038427
Conductivity (S/m)	0.866233
Variation (%)	0.420000

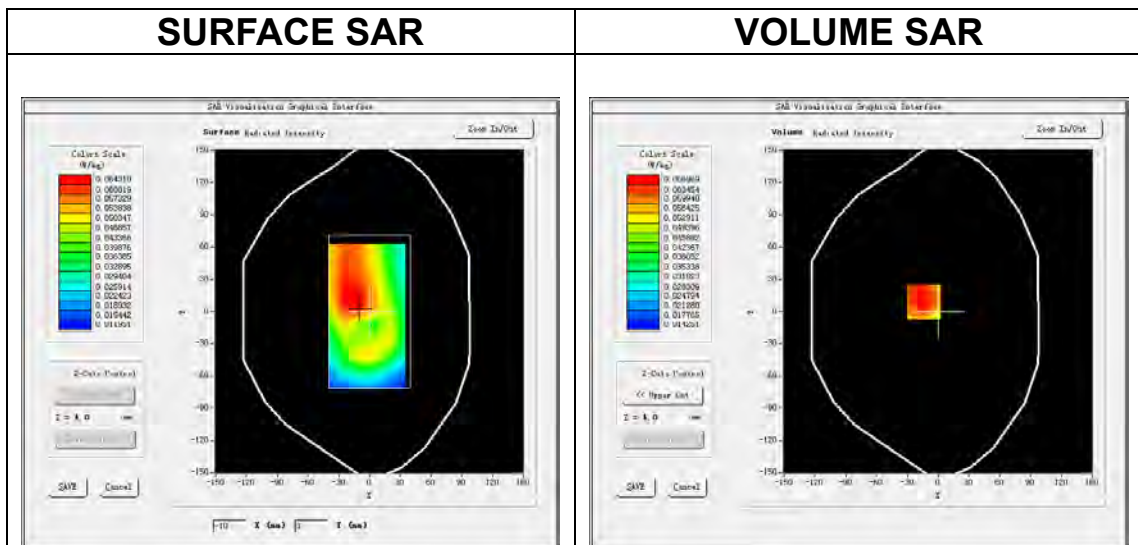

Maximum location: X=-14.00, Y=9.00
SAR Peak: 0.08 W/kg

SAR 10g (W/Kg)	0.052515
SAR 1g (W/Kg)	0.065619

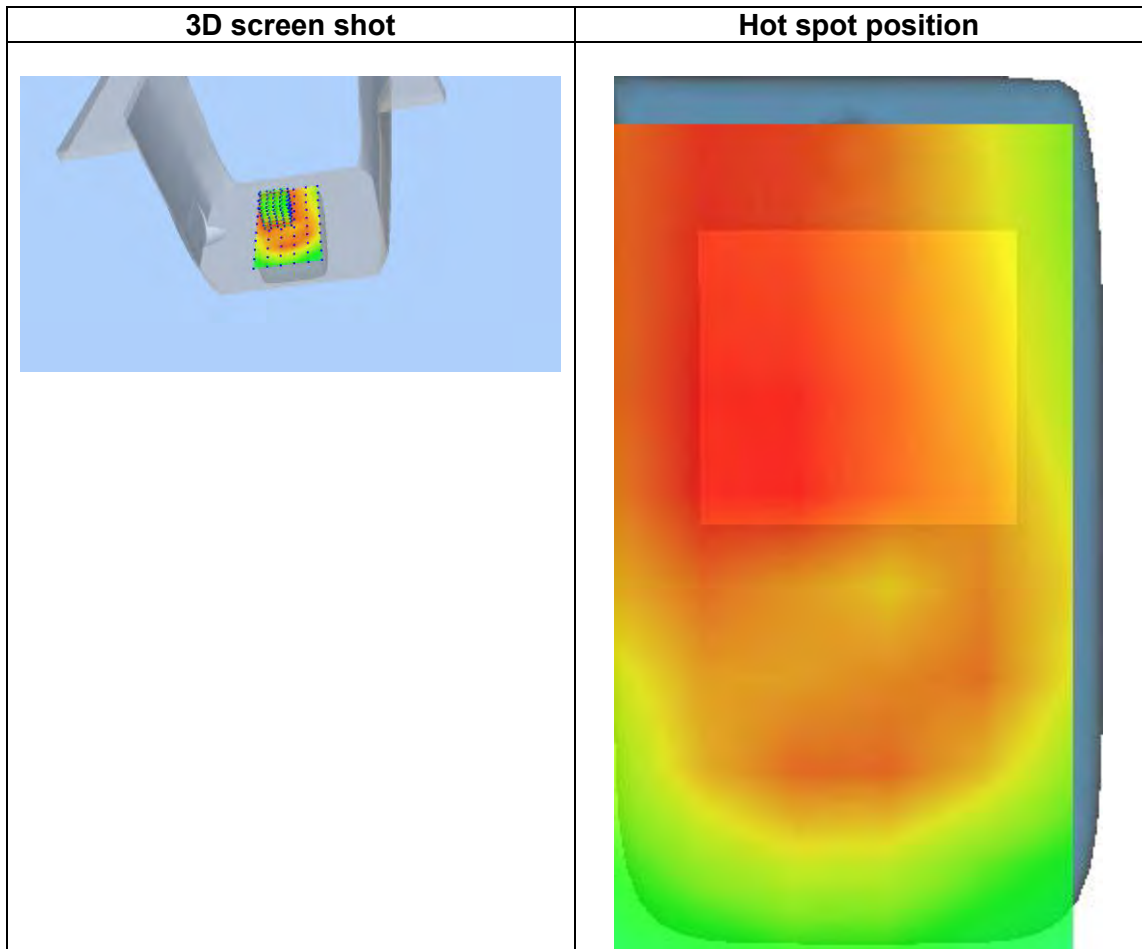
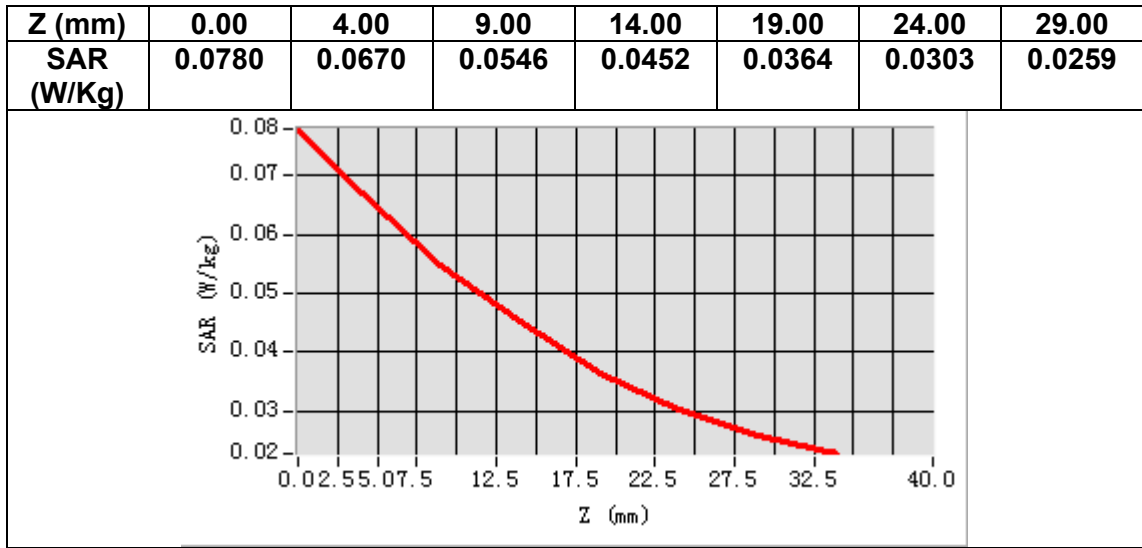

MEASUREMENT 27

Date of measurement: 26/10/2023

A. Experimental conditions.

Area Scan	<u>dx=15mm dy=15mm, h= 5.00 mm</u>
ZoomScan	<u>5x5x7, dx=8mm dy=8mm dz=5mm</u>
Phantom	<u>Left head</u>
Device Position	<u>Cheek</u>
Band	<u>LTE band 17</u>
Channels	<u>Middle</u>
Signal	<u>LTE (Crest factor: 1.0)</u>
ConvF	<u>2.37</u>

B. SAR Measurement Results

Frequency (MHz)	710.000000
Relative permittivity (real part)	42.818645
Relative permittivity (imaginary part)	22.066828
Conductivity (S/m)	0.870414
Variation (%)	1.250000

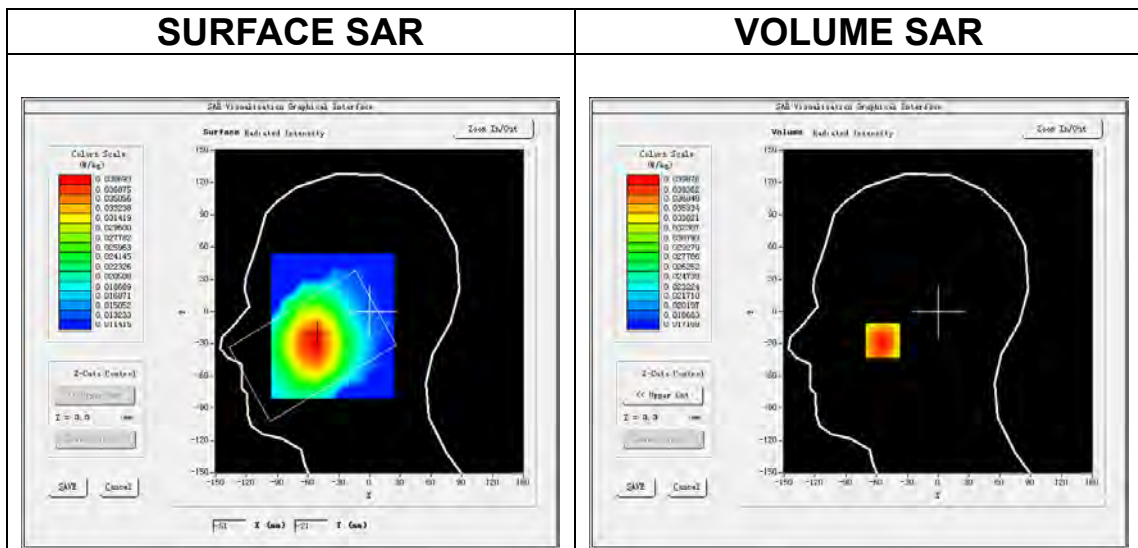

Maximum location: X=-54.00, Y=-27.00
SAR Peak: 0.04 W/kg

SAR 10g (W/Kg)	0.033209
SAR 1g (W/Kg)	0.038805

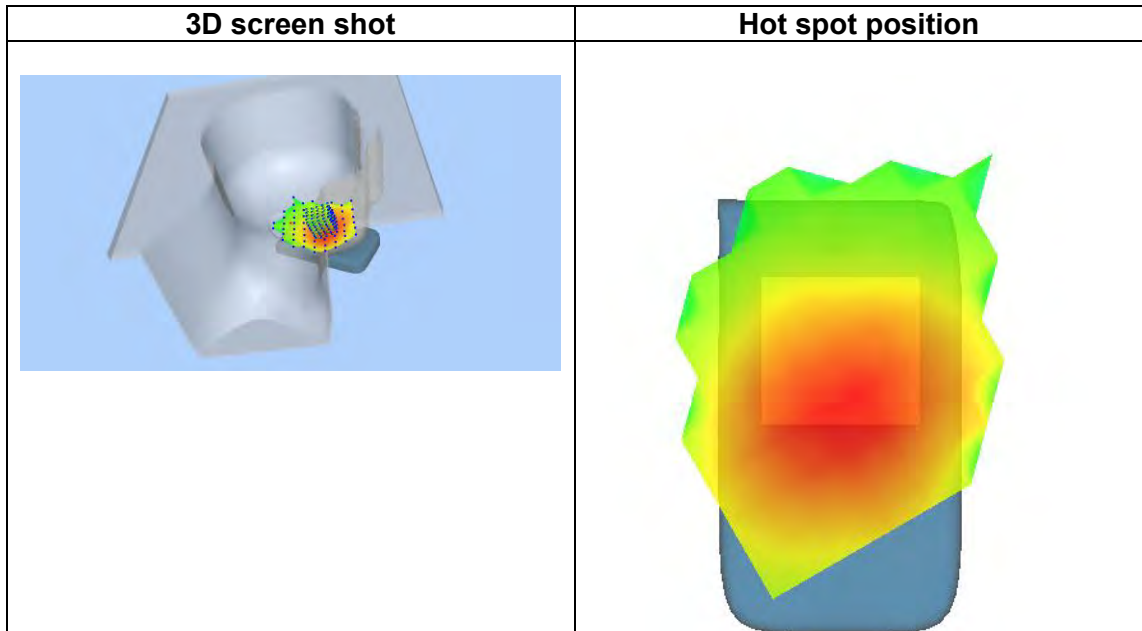
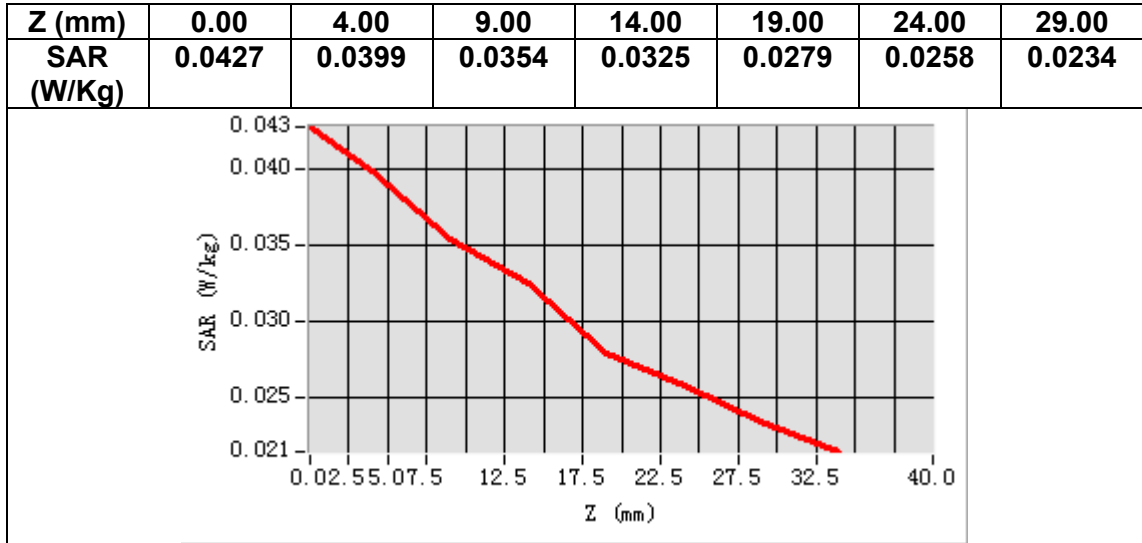

MEASUREMENT 28

Date of measurement: 26/10/2023

A. Experimental conditions.

Area Scan	<u>dx=15mm dy=15mm, h= 5.00 mm</u>
ZoomScan	<u>5x5x7, dx=8mm dy=8mm dz=5mm</u>
Phantom	<u>Validation plane</u>
Device Position	<u>Body</u>
Band	<u>LTE band 17</u>
Channels	<u>Middle</u>
Signal	<u>LTE (Crest factor: 1.0)</u>
ConvF	<u>2.37</u>

B. SAR Measurement Results

Frequency (MHz)	710.000000
Relative permittivity (real part)	42.818645
Relative permittivity (imaginary part)	22.066828
Conductivity (S/m)	0.870414
Variation (%)	-0.380000

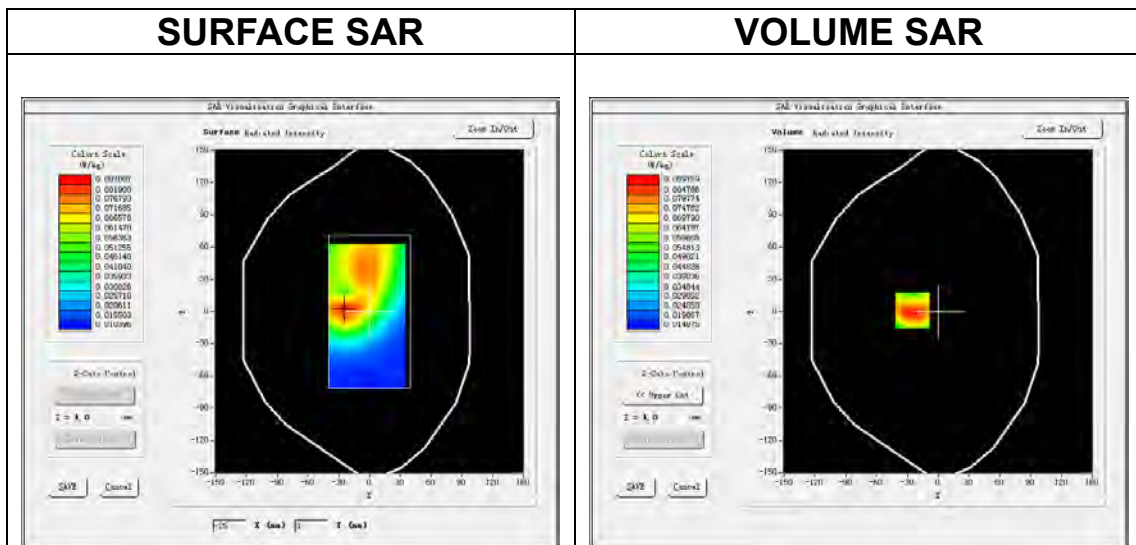

Maximum location: X=-25.00, Y=1.00
SAR Peak: 0.13 W/kg

SAR 10g (W/Kg)	0.057642
SAR 1g (W/Kg)	0.087092

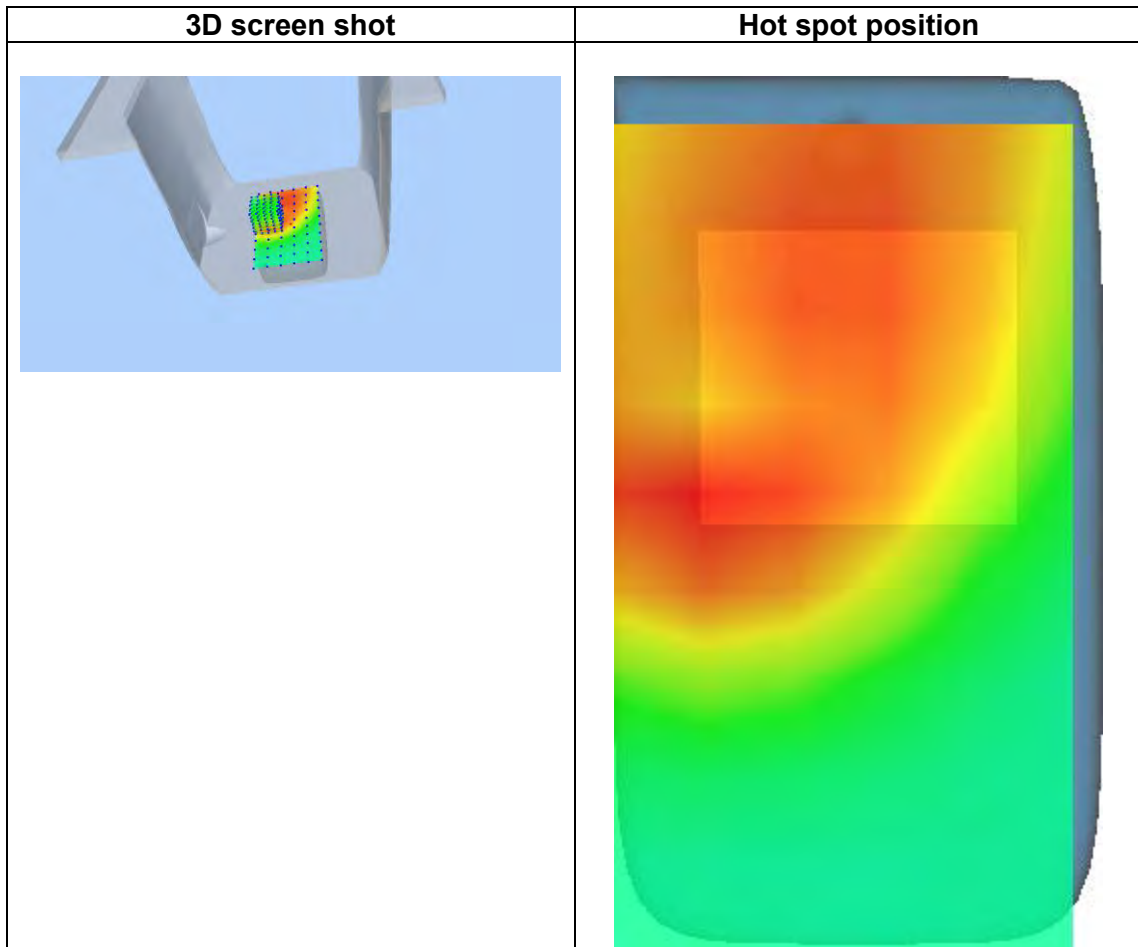
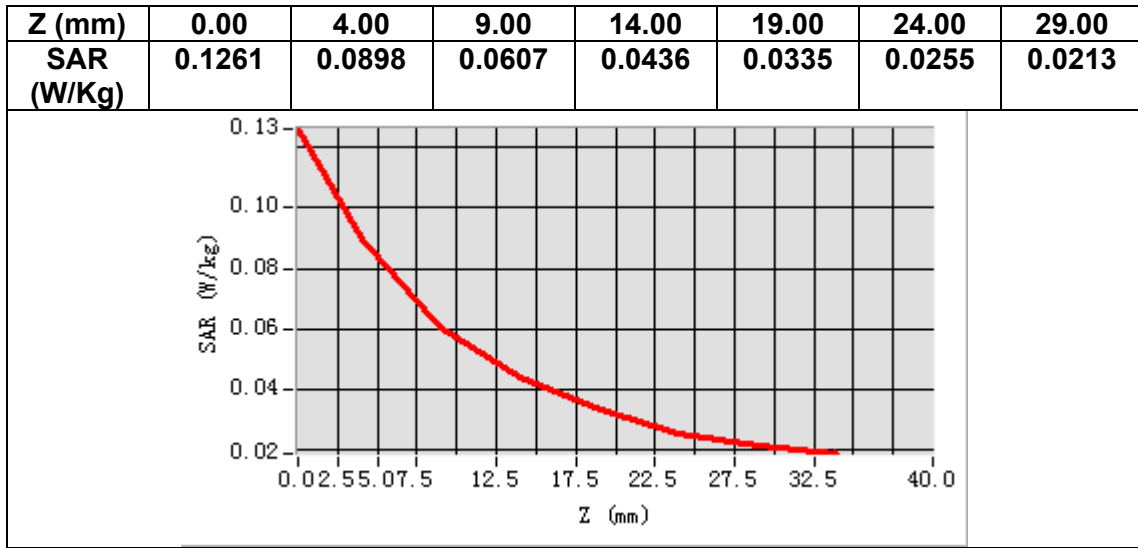

MEASUREMENT 29

Date of measurement: 29/10/2023

A. Experimental conditions.

Area Scan	<u>dx=12mm dy=12mm, h= 5.00 mm</u>
ZoomScan	<u>7x7x7,dx=5mm dy=5mm dz=5mm</u>
Phantom	<u>Left head</u>
Device Position	<u>Cheek</u>
Band	<u>LTE band 41</u>
Channels	<u>Middle</u>
Signal	<u>LTE (Crest factor: 1.0)</u>
ConvF	<u>2.65</u>

B. SAR Measurement Results

Frequency (MHz)	2593.000000
Relative permittivity (real part)	38.627872
Relative permittivity (imaginary part)	13.269114
Conductivity (S/m)	1.911490
Variation (%)	-2.510000

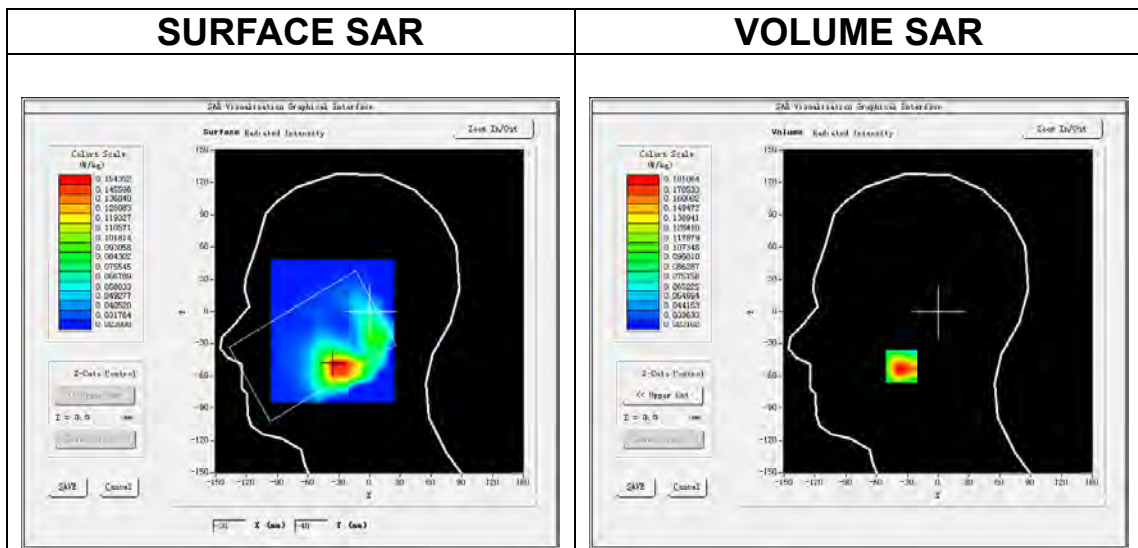

Maximum location: X=-30.00, Y=-51.00
SAR Peak: 0.28 W/kg

SAR 10g (W/Kg)	0.097100
SAR 1g (W/Kg)	0.171172

Z (mm)	0.00	4.00	9.00	14.00	19.00	24.00	29.00
SAR (W/Kg)	0.3013	0.1811	0.0952	0.0669	0.0435	0.0365	0.0307

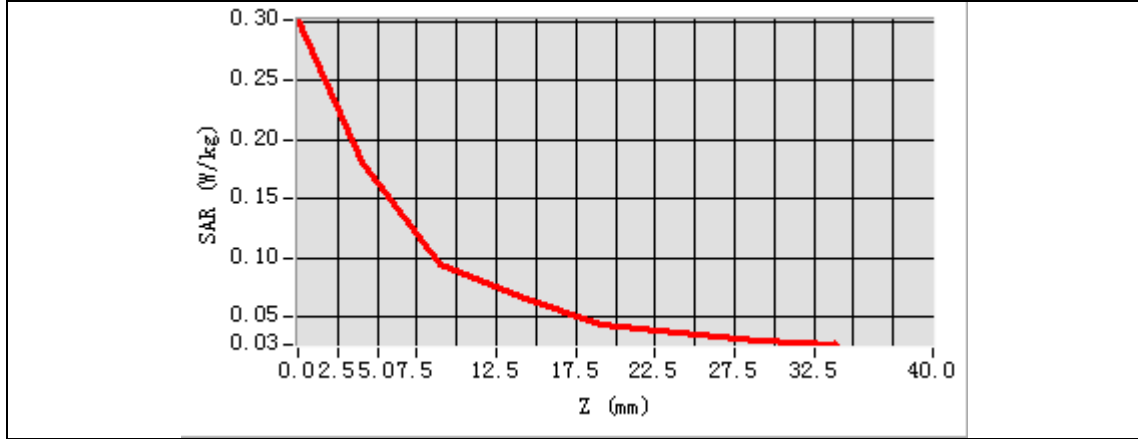

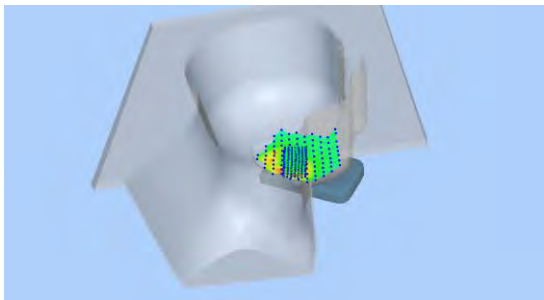
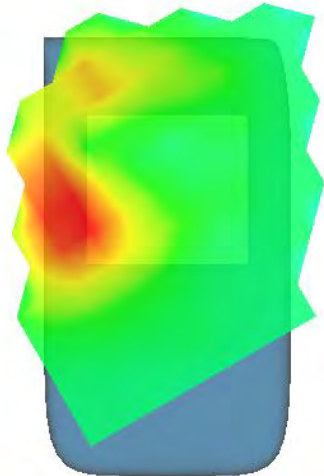
3D screen shot	Hot spot position
	

MEASUREMENT 30

Date of measurement: 29/10/2023

A. Experimental conditions.

Area Scan	<u>dx=12mm dy=12mm, h= 5.00 mm</u>
ZoomScan	<u>7x7x7,dx=5mm dy=5mm dz=5mm</u>
Phantom	<u>Validation plane</u>
Device Position	<u>Body</u>
Band	<u>LTE band 41</u>
Channels	<u>Middle</u>
Signal	<u>LTE (Crest factor: 1.0)</u>
ConvF	<u>2.65</u>

B. SAR Measurement Results

Frequency (MHz)	2593.000000
Relative permittivity (real part)	38.627872
Relative permittivity (imaginary part)	13.269114
Conductivity (S/m)	1.911490
Variation (%)	4.050000

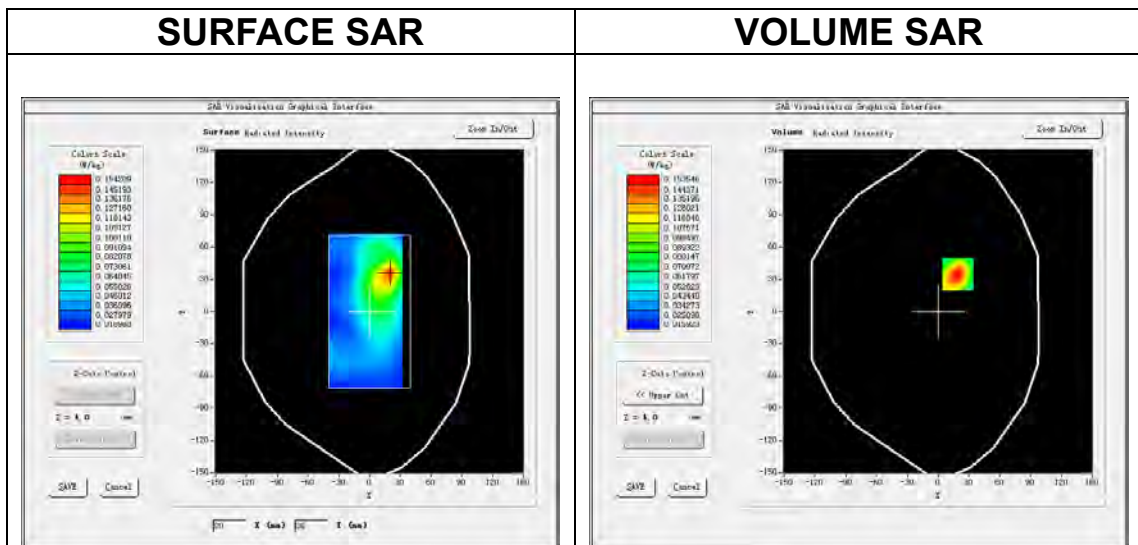

Maximum location: X=19.00, Y=35.00

SAR Peak: 0.24 W/kg

SAR 10g (W/Kg)	0.079215
SAR 1g (W/Kg)	0.144378

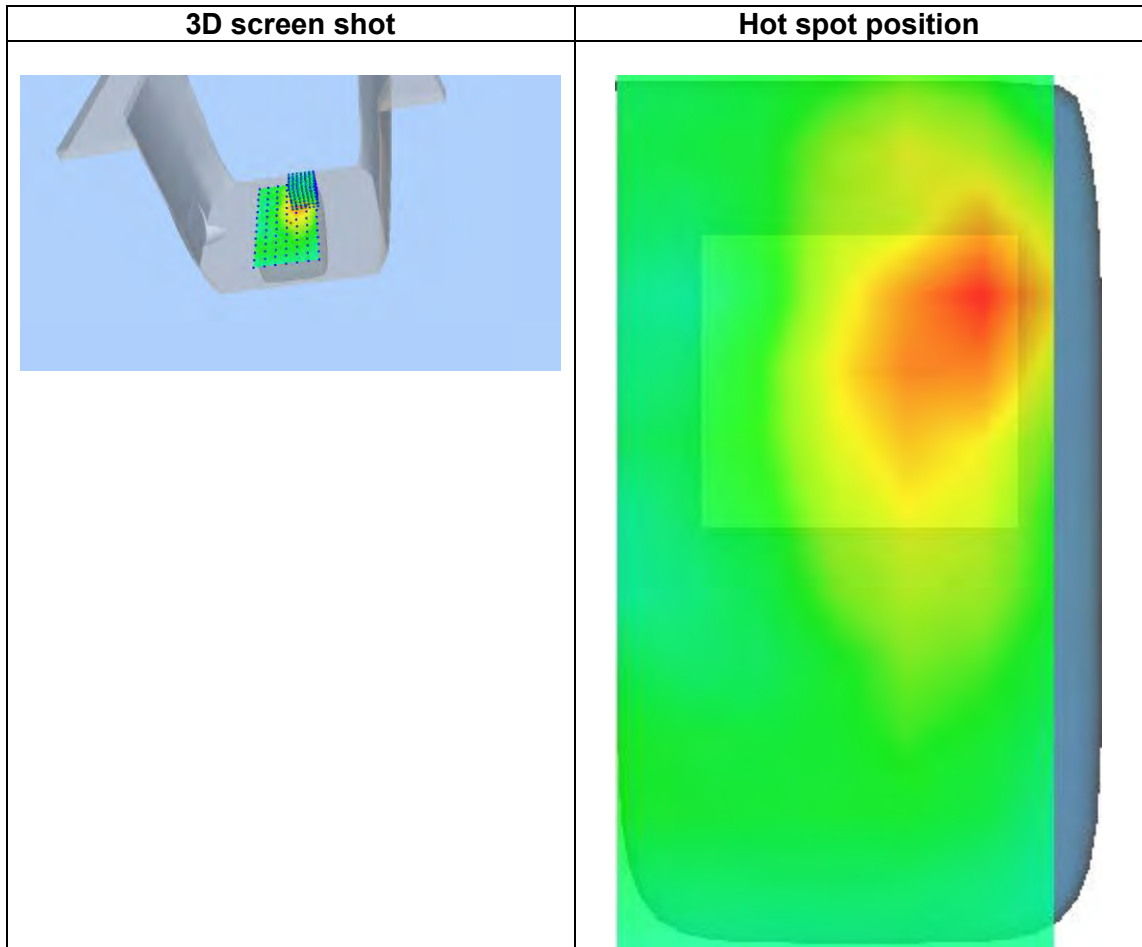
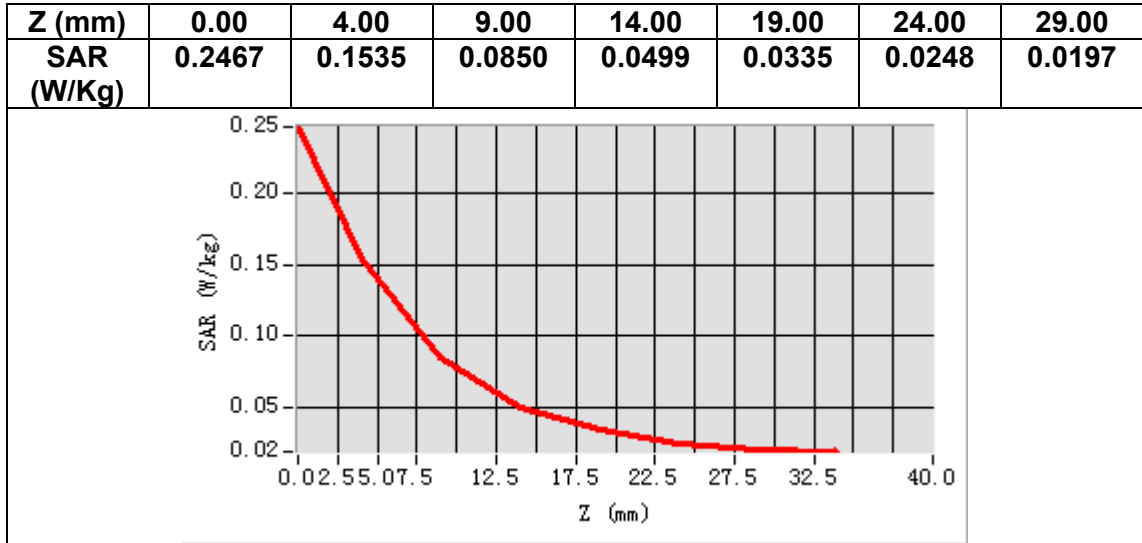

MEASUREMENT 31

Date of measurement: 29/10/2023

A. Experimental conditions.

Area Scan	<u>dx=12mm dy=12mm, h= 5.00 mm</u>
ZoomScan	<u>7x7x7,dx=5mm dy=5mm dz=5mm</u>
Phantom	<u>Left head</u>
Device Position	<u>Cheek</u>
Band	<u>SA n41</u>
Channels	<u>Middle</u>
Signal	<u>(Crest factor: 1.0)</u>
ConvF	<u>2.65</u>

B. SAR Measurement Results

Frequency (MHz)	2592.990000
Relative permittivity (real part)	38.627190
Relative permittivity (imaginary part)	13.269355
Conductivity (S/m)	1.911517
Variation (%)	0.870000

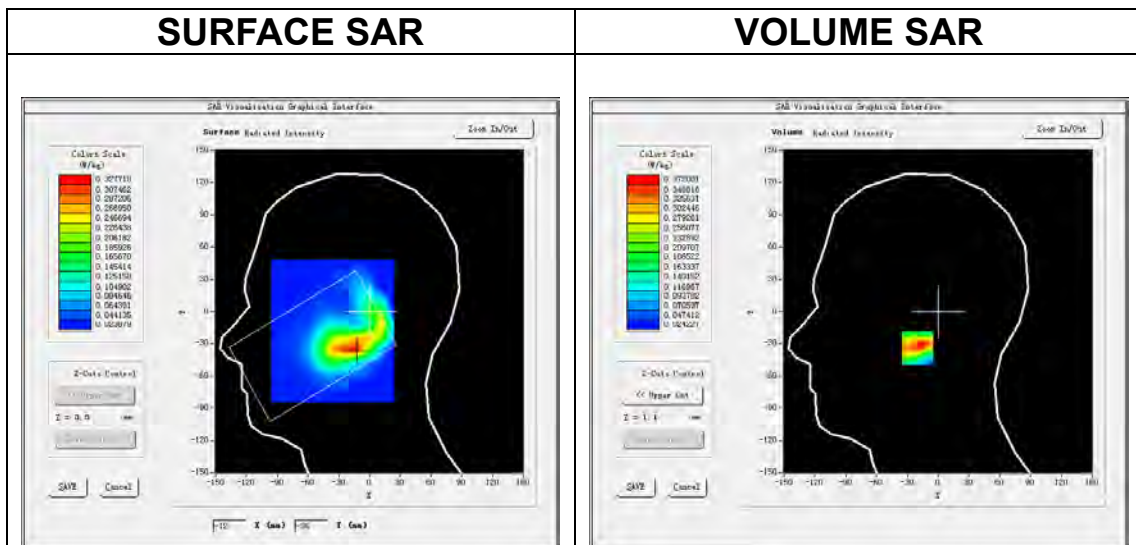

Maximum location: X=-14.00, Y=-34.00
SAR Peak: 0.63 W/kg

SAR 10g (W/Kg)	0.171809
SAR 1g (W/Kg)	0.348532

Z (mm)	0.00	4.00	9.00	14.00	19.00	24.00	29.00
SAR (W/Kg)	0.6876	0.3720	0.1644	0.1033	0.0646	0.0422	0.0336

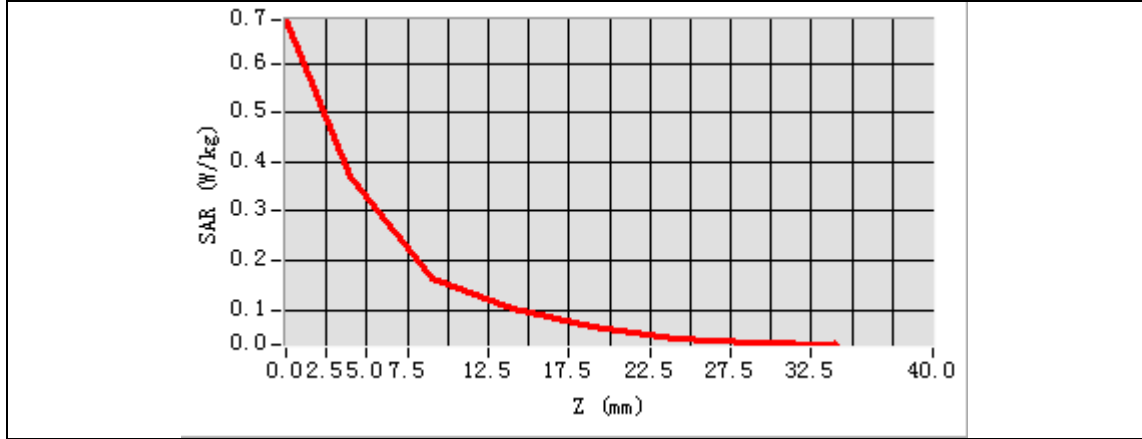

3D screen shot	Hot spot position
<p>A 3D rendering of a human head and neck model. A grid of small colored dots is overlaid on the neck area, representing the measurement points for SAR.</p>	<p>A 3D rendering of the same head and neck model, showing a color-coded 'hot spot' area. The colors range from red (highest SAR) to blue (lowest SAR), indicating the spatial distribution of the electromagnetic field.</p>

MEASUREMENT 32

Date of measurement: 29/10/2023

A. Experimental conditions.

Area Scan	<u>dx=12mm dy=12mm, h= 5.00 mm</u>
ZoomScan	<u>7x7x7,dx=5mm dy=5mm dz=5mm</u>
Phantom	<u>Validation plane</u>
Device Position	<u>Body</u>
Band	<u>SA_n41</u>
Channels	<u>Middle</u>
Signal	<u>(Crest factor: 1.0)</u>
ConvF	<u>2.65</u>

B. SAR Measurement Results

Frequency (MHz)	2592.990000
Relative permittivity (real part)	38.627190
Relative permittivity (imaginary part)	13.269355
Conductivity (S/m)	1.911517
Variation (%)	-0.610000

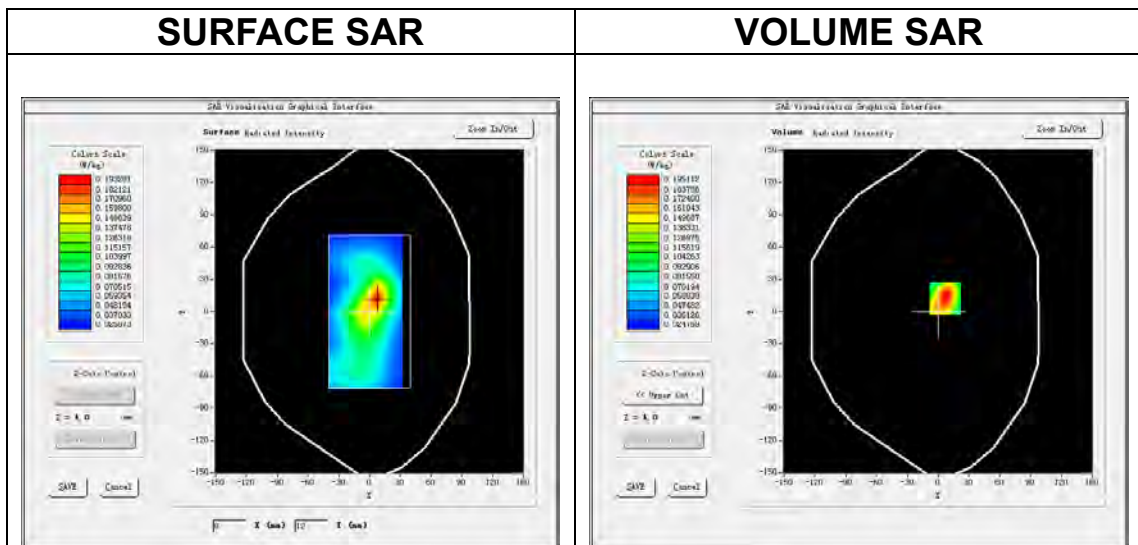

Maximum location: X=7.00, Y=12.00

SAR Peak: 0.30 W/kg

SAR 10g (W/Kg)	0.104283
SAR 1g (W/Kg)	0.184085

Z (mm)	0.00	4.00	9.00	14.00	19.00	24.00	29.00
SAR (W/Kg)	0.2999	0.1951	0.1121	0.0692	0.0465	0.0349	0.0315

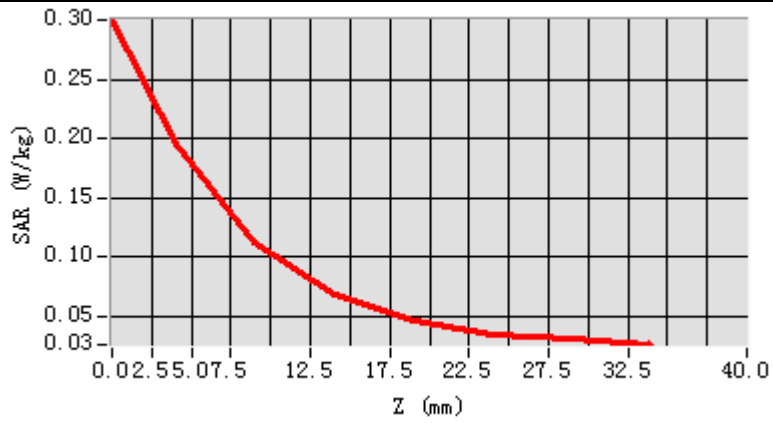

3D screen shot

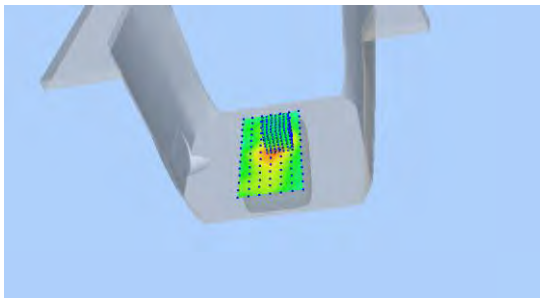

Hot spot position

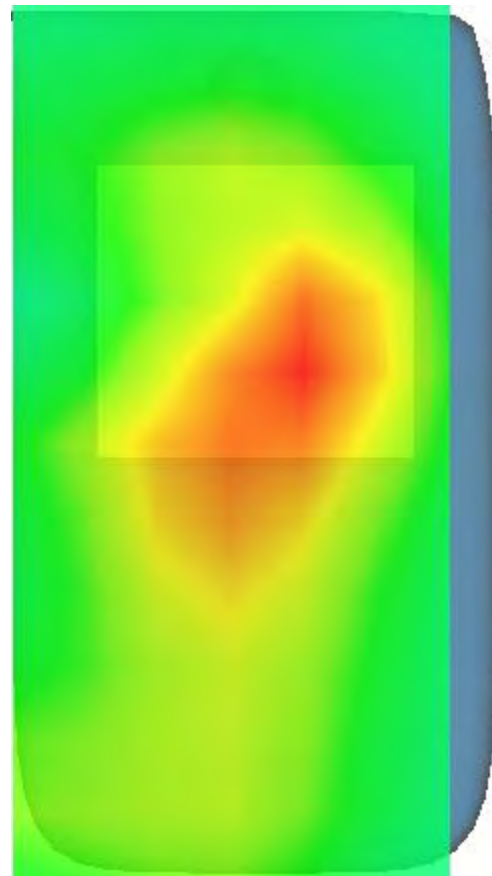

MEASUREMENT 33

Date of measurement: 31/10/2023

A. Experimental conditions.

Area Scan	<u>dx=15mm dy=15mm, h= 5.00 mm</u>
ZoomScan	<u>5x5x7, dx=8mm dy=8mm dz=5mm</u>
Phantom	<u>Left head</u>
Device Position	<u>Cheek</u>
Band	<u>FDDBand66</u>
Channels	<u>Middle</u>
Signal	<u>(Crest factor: 1.0)</u>
ConvF	<u>2.45</u>

B. SAR Measurement Results

Frequency (MHz)	1745.000000
Relative permittivity (real part)	40.451820
Relative permittivity (imaginary part)	14.253345
Conductivity (S/m)	1.381783
Variation (%)	-2.920000

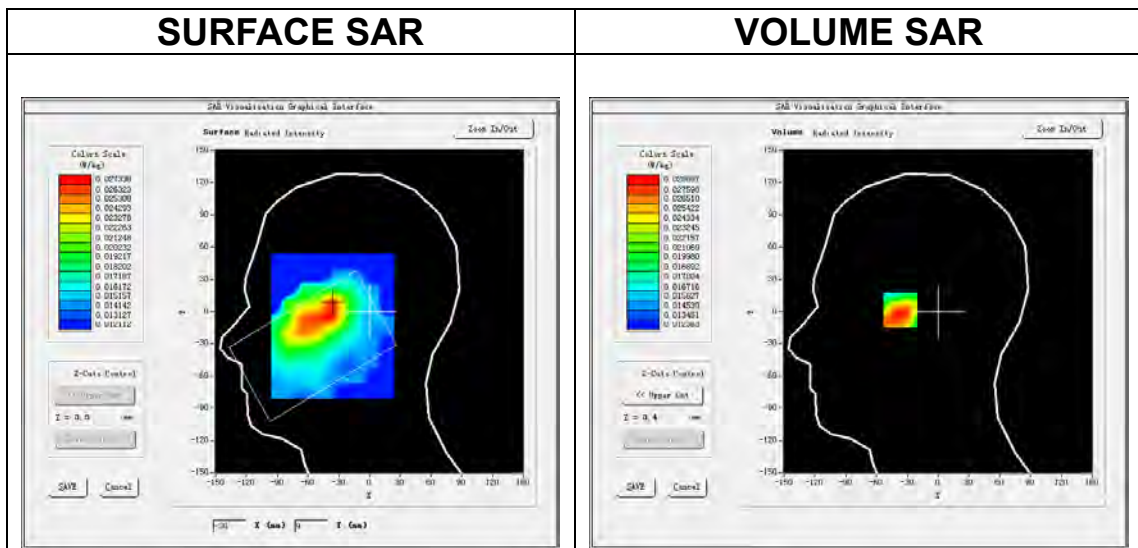

Maximum location: X=-37.00, Y=5.00
SAR Peak: 0.03 W/kg

SAR 10g (W/Kg)	0.022197
SAR 1g (W/Kg)	0.028037

Z (mm)	0.00	4.00	9.00	14.00	19.00	24.00	29.00
SAR (W/Kg)	0.0335	0.0287	0.0239	0.0198	0.0177	0.0166	0.0153

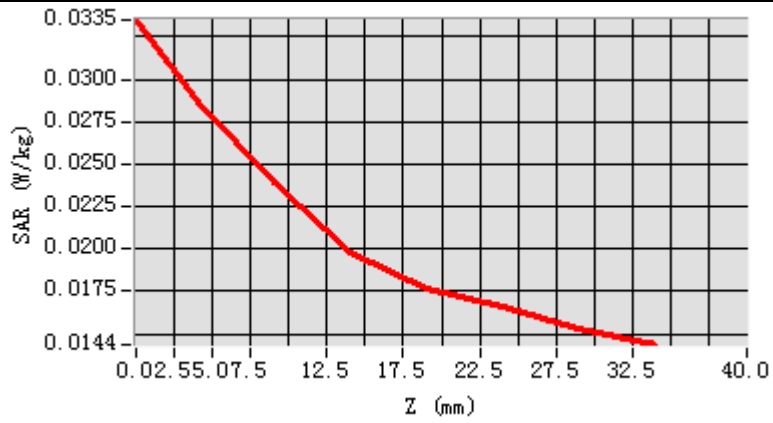

3D screen shot

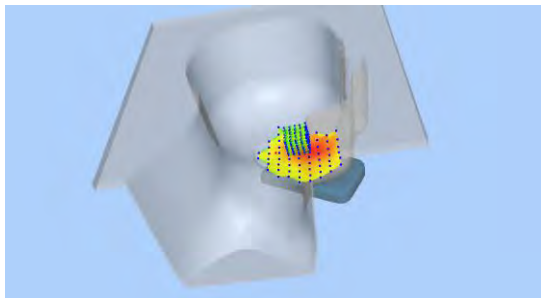

Hot spot position

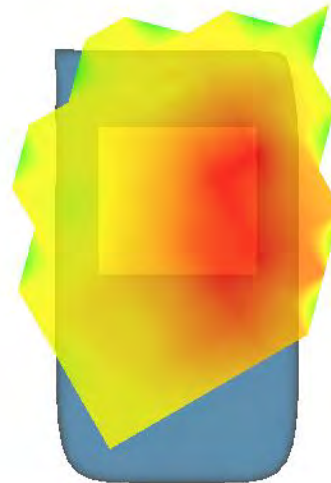

MEASUREMENT 34

Date of measurement: 31/10/2023

A. Experimental conditions.

Area Scan	<u>dx=15mm dy=15mm, h= 5.00 mm</u>
ZoomScan	<u>5x5x7, dx=8mm dy=8mm dz=5mm</u>
Phantom	<u>Validation plane</u>
Device Position	<u>Body</u>
Band	<u>FDDBand66</u>
Channels	<u>Middle</u>
Signal	<u>(Crest factor: 1.0)</u>
ConvF	<u>2.45</u>

B. SAR Measurement Results

Frequency (MHz)	1745.000000
Relative permittivity (real part)	40.451820
Relative permittivity (imaginary part)	14.253345
Conductivity (S/m)	1.381783
Variation (%)	-2.730000

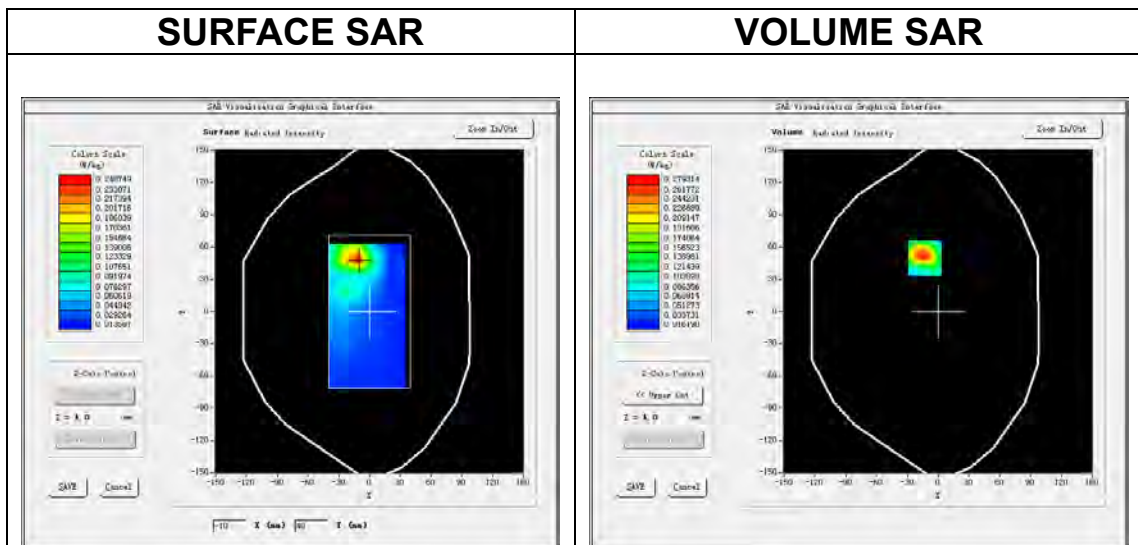

Maximum location: X=-13.00, Y=50.00
SAR Peak: 0.44 W/kg

SAR 10g (W/Kg)	0.139023
SAR 1g (W/Kg)	0.268706

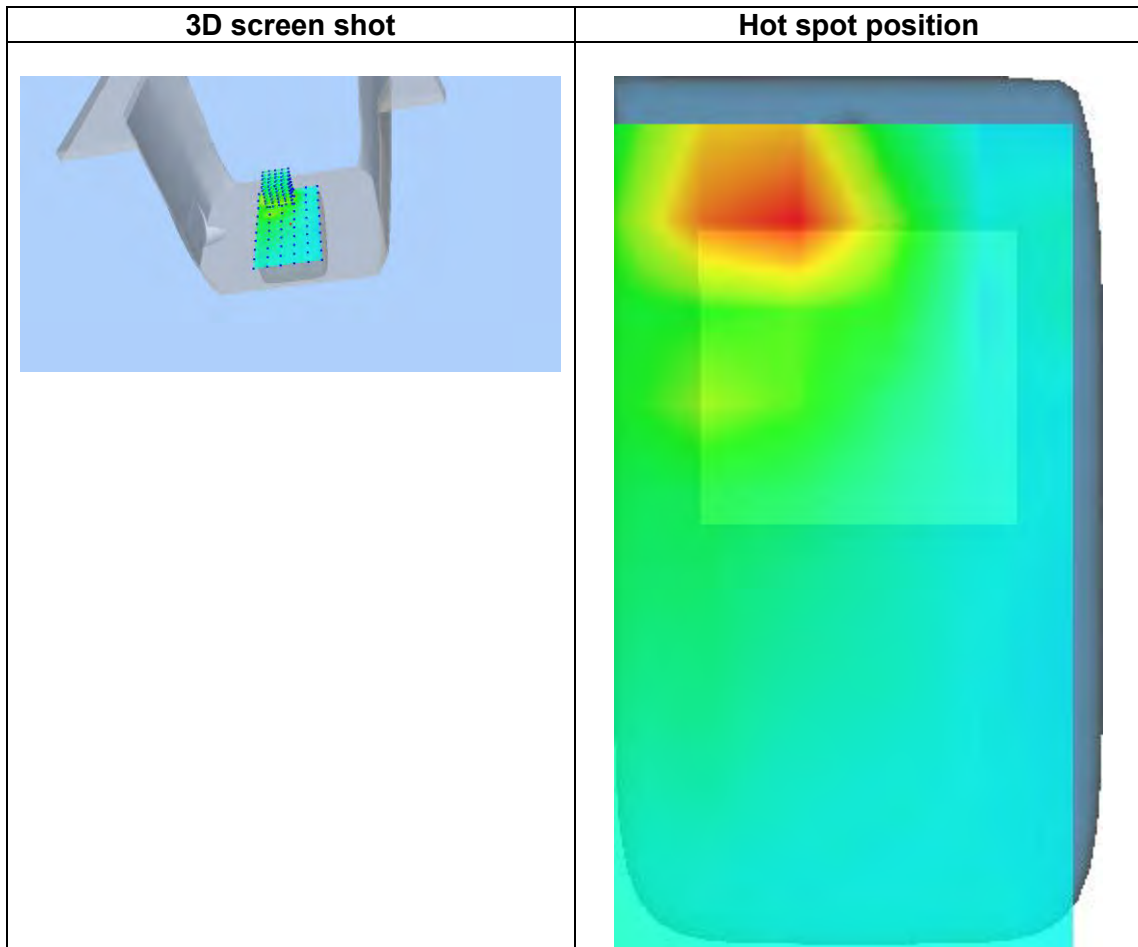
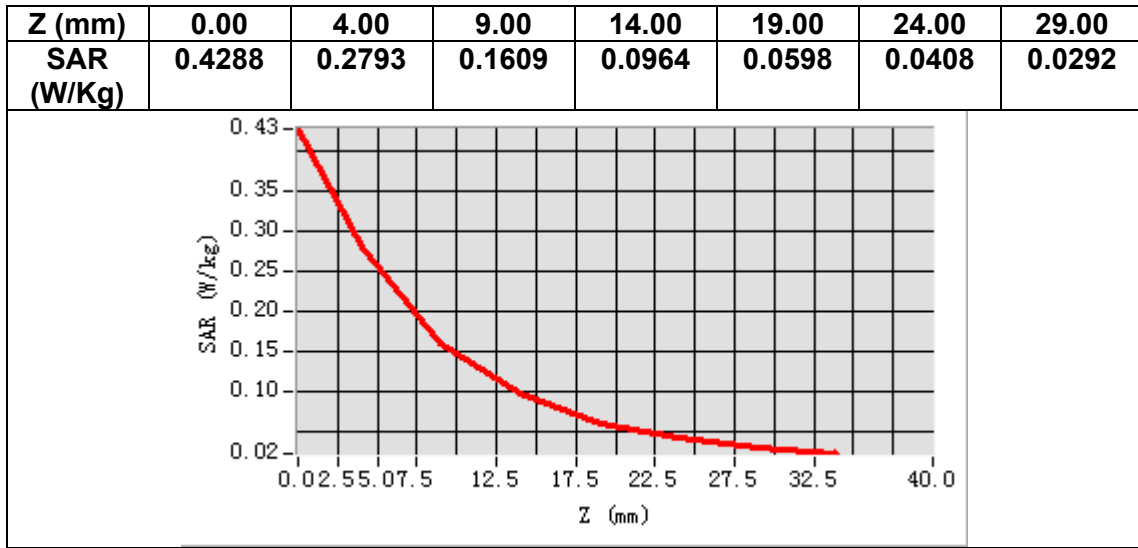

MEASUREMENT 35

Date of measurement: 19/10/2023

A. Experimental conditions.

<u>Area Scan</u>	<u>dx=12mm dy=12mm, h= 5.00 mm</u>
<u>ZoomScan</u>	<u>7x7x7,dx=5mm dy=5mm dz=5mm</u>
<u>Phantom</u>	<u>Left head</u>
<u>Device Position</u>	<u>Cheek</u>
<u>Band</u>	<u>SA n78</u>
<u>Channels</u>	<u>Middle</u>
<u>Signal</u>	<u>(Crest factor: 1.0)</u>
<u>ConvF</u>	<u>2.20</u>

B. SAR Measurement Results

Frequency (MHz)	3500.000000
Relative permittivity (real part)	38.213495
Relative permittivity (imaginary part)	14.402188
Conductivity (S/m)	2.800425
Variation (%)	2.450000

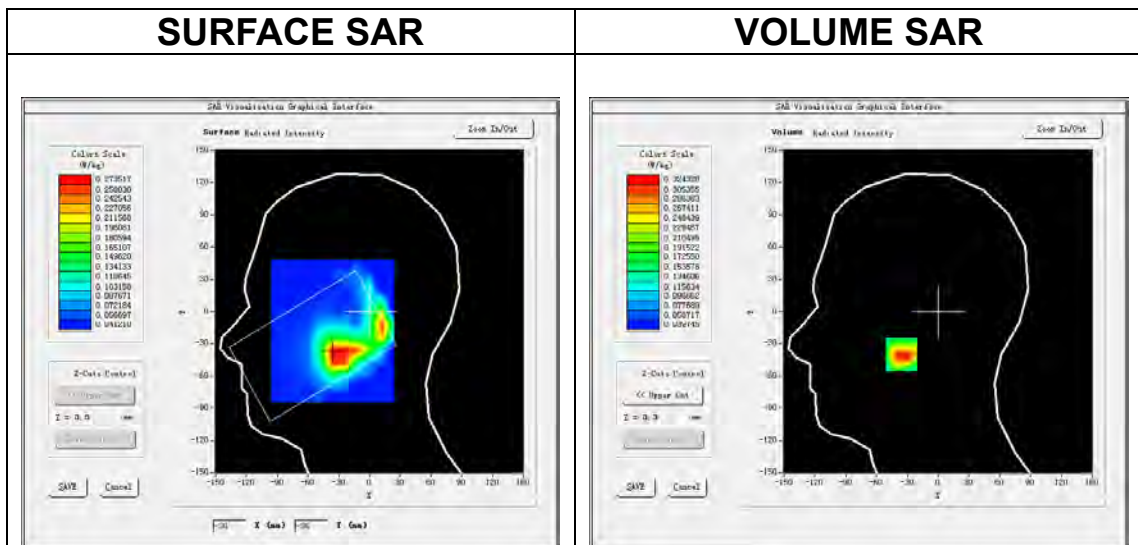

Maximum location: X=-31.00, Y=-40.00
SAR Peak: 0.61 W/kg

SAR 10g (W/Kg)	0.154039
SAR 1g (W/Kg)	0.309592

Z (mm)	0.00	4.00	9.00	14.00	19.00	24.00	29.00
SAR (W/Kg)	0.6096	0.3243	0.1389	0.0756	0.0570	0.0461	0.0463

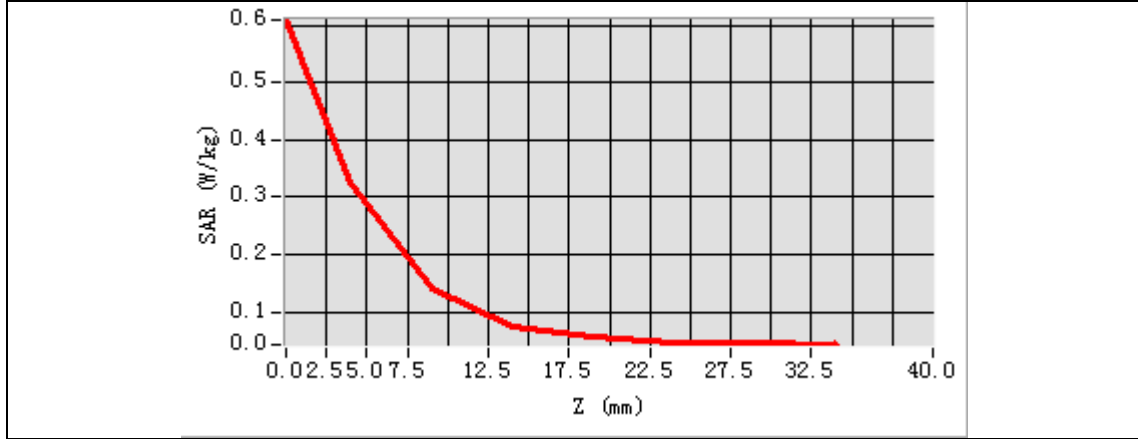

3D screen shot	Hot spot position
<p>A 3D rendering of a human head and neck model. A grid of small colored dots is overlaid on the neck area, representing the measurement points for SAR.</p>	<p>A 3D rendering of the same head and neck model. A color-coded area is overlaid on the neck, showing a 'hot spot' in red and yellow, indicating the highest SAR values. The rest of the neck area is shown in green.</p>

MEASUREMENT 36

Date of measurement: 19/10/2023

A. Experimental conditions.

Area Scan	<u>dx=12mm dy=12mm, h= 5.00 mm</u>
ZoomScan	<u>7x7x7,dx=5mm dy=5mm dz=5mm</u>
Phantom	<u>Validation plane</u>
Device Position	<u>Body</u>
Band	<u>SA n78</u>
Channels	<u>Middle</u>
Signal	<u>(Crest factor: 1.0)</u>
ConvF	<u>2.20</u>

B. SAR Measurement Results

Frequency (MHz)	3500.000000
Relative permittivity (real part)	38.213495
Relative permittivity (imaginary part)	14.402188
Conductivity (S/m)	2.800425
Variation (%)	-1.040000

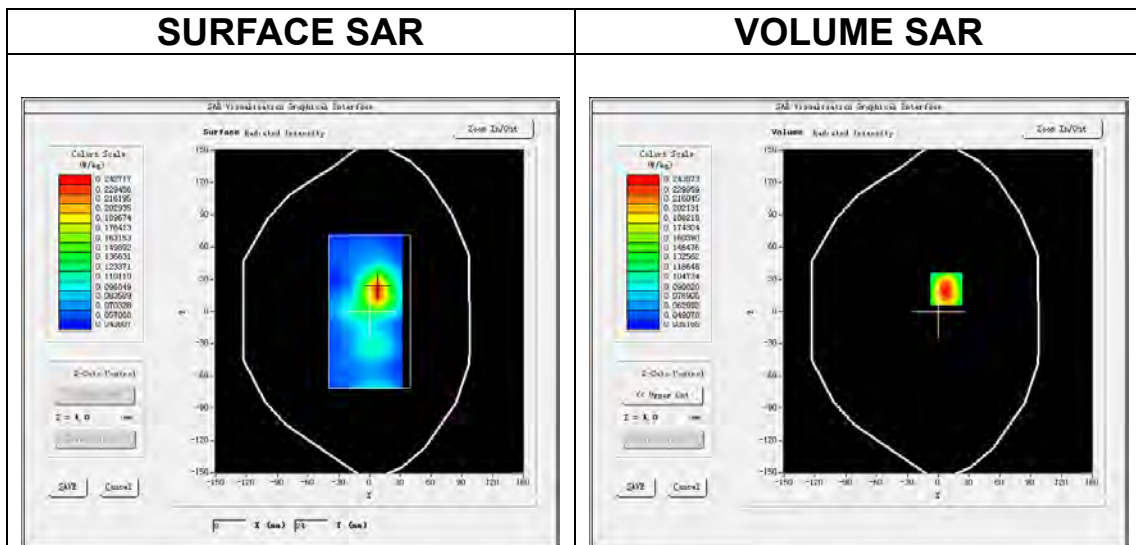

Maximum location: X=8.00, Y=21.00

SAR Peak: 0.43 W/kg

SAR 10g (W/Kg)	0.125185
SAR 1g (W/Kg)	0.233721

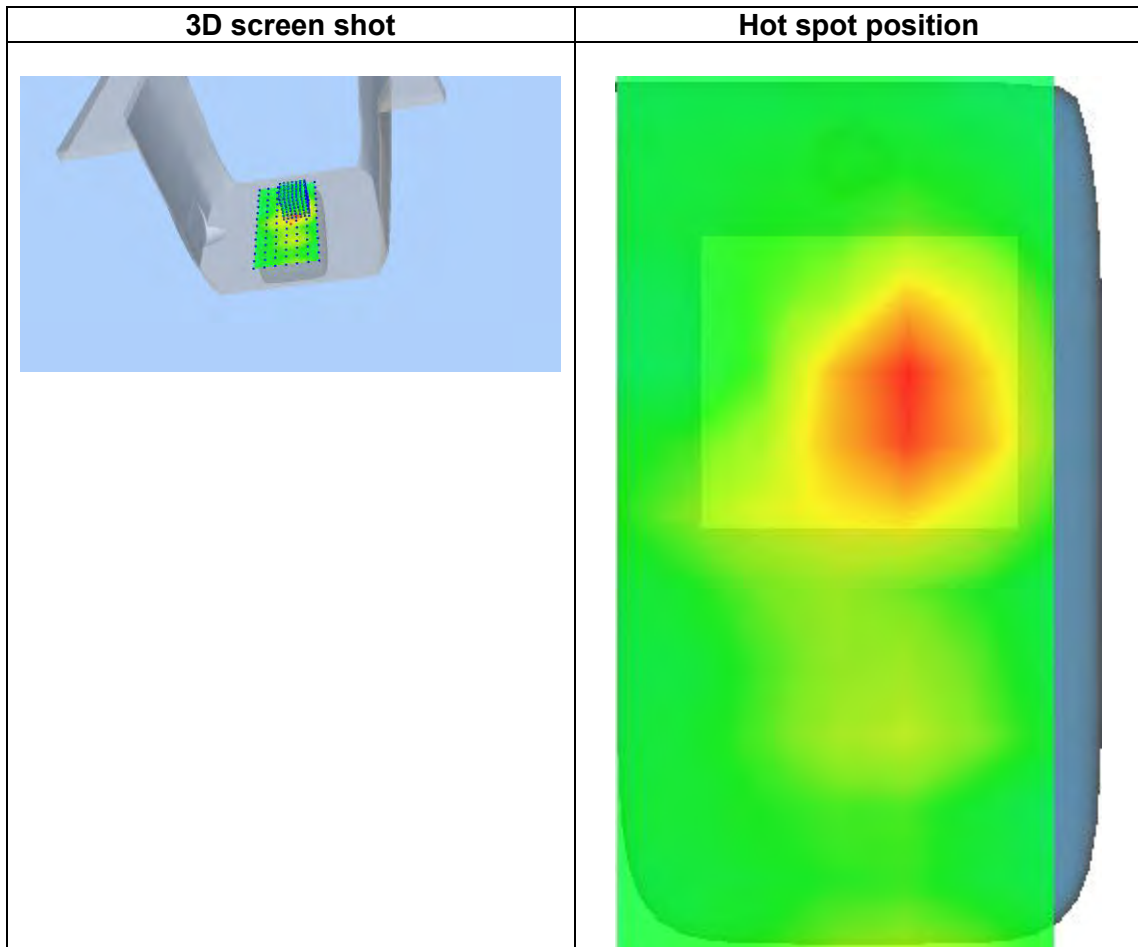
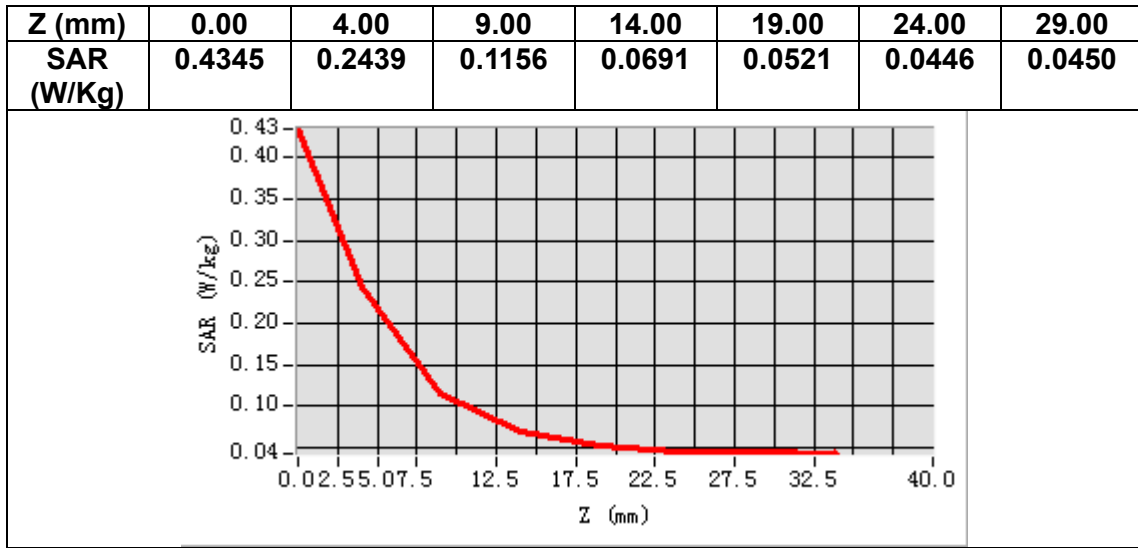

MEASUREMENT 37

Date of measurement: 26/10/2023

A. Experimental conditions.

Area Scan	<u>dx=15mm dy=15mm, h= 5.00 mm</u>
ZoomScan	<u>5x5x7,dx=8mm dy=8mm dz=5mm</u>
Phantom	<u>Left head</u>
Device Position	<u>Cheek</u>
Band	<u>FDDBand71</u>
Channels	<u>Middle</u>
Signal	<u>(Crest factor: 1.0)</u>
ConvF	<u>1.49</u>

B. SAR Measurement Results

Frequency (MHz)	683.000000
Relative permittivity (real part)	43.080847
Relative permittivity (imaginary part)	22.290627
Conductivity (S/m)	0.845805
Variation (%)	3.020000

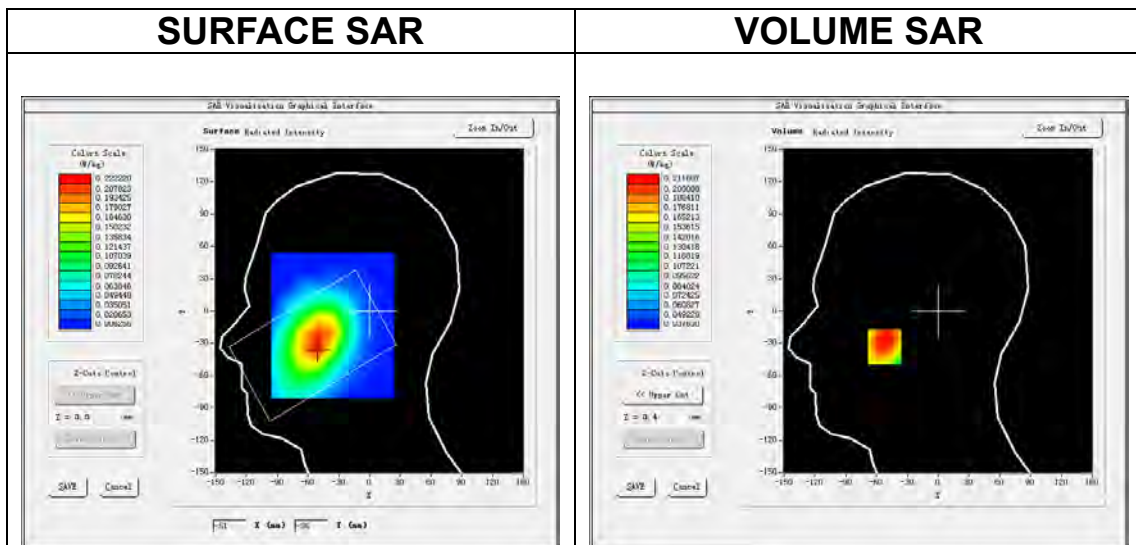

Maximum location: X=-52.00, Y=-33.00

SAR Peak: 0.23 W/kg

SAR 10g (W/Kg)	0.150231
SAR 1g (W/Kg)	0.195210

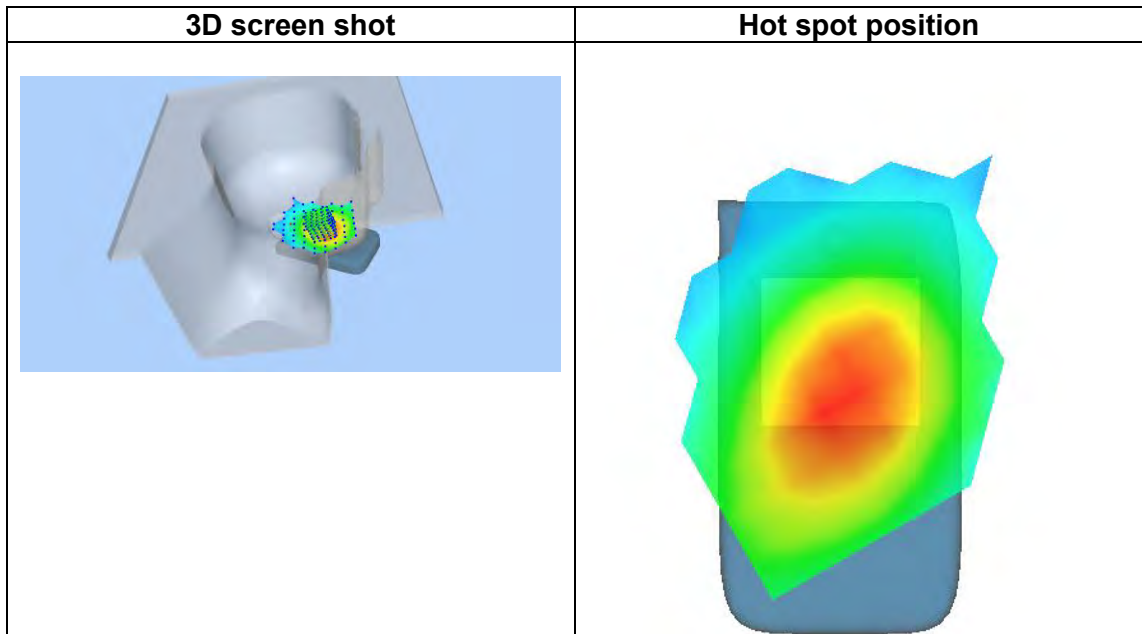
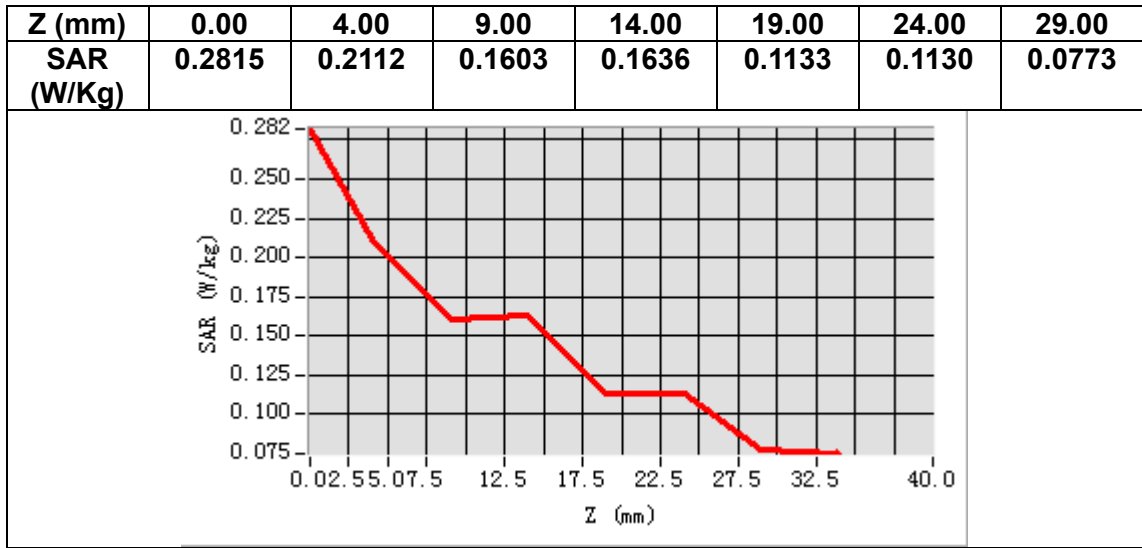

MEASUREMENT 38

Date of measurement: 26/10/2023

A. Experimental conditions.

Area Scan	<u>dx=15mm dy=15mm, h= 5.00 mm</u>
ZoomScan	<u>5x5x7, dx=8mm dy=8mm dz=5mm</u>
Phantom	<u>Validation plane</u>
Device Position	<u>Body</u>
Band	<u>FDDBand71</u>
Channels	<u>Middle</u>
Signal	<u>(Crest factor: 1.0)</u>
ConvF	<u>1.49</u>

B. SAR Measurement Results

Frequency (MHz)	683.000000
Relative permittivity (real part)	43.080847
Relative permittivity (imaginary part)	22.290627
Conductivity (S/m)	0.845805
Variation (%)	2.100000

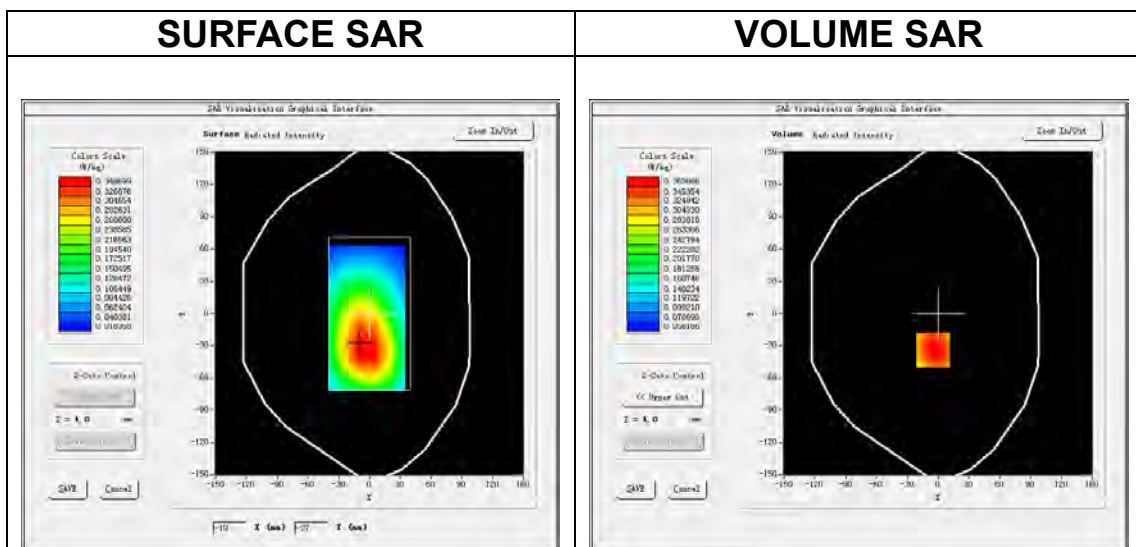

Maximum location: X=-5.00, Y=-34.00
SAR Peak: 0.44 W/kg

SAR 10g (W/Kg)	0.262312
SAR 1g (W/Kg)	0.348242

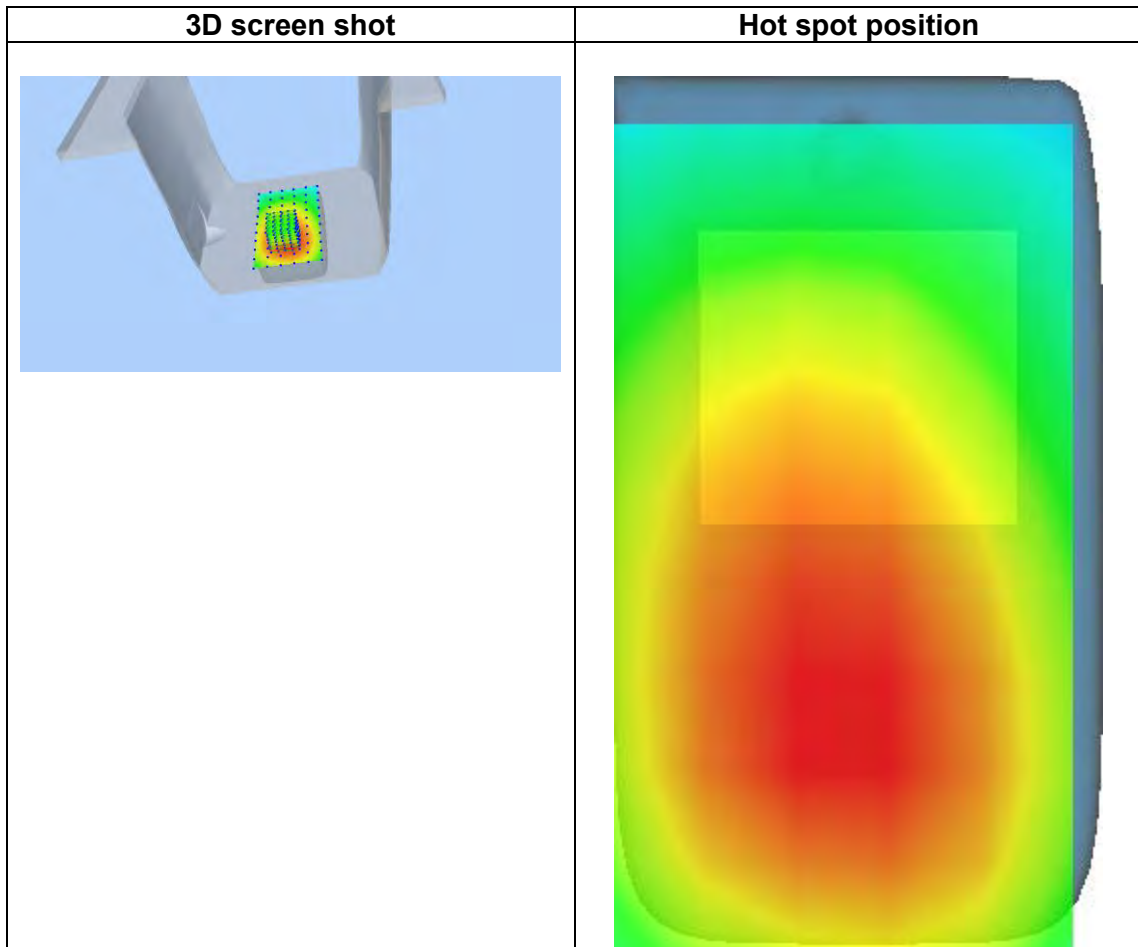
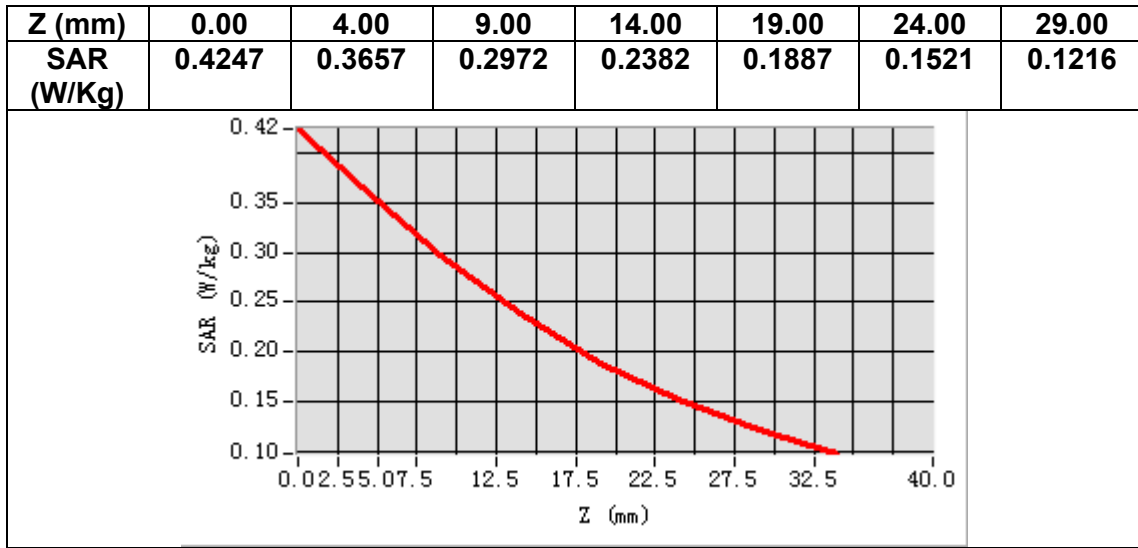

2. Appendix D. Calibration Certificate

Table of contents
E Field Probe - 3423-EPGO-426
750 MHz Dipole - SN 03/15 DIP 0G750-355
835 MHz Dipole - SN 03/15 DIP 0G835-347
1800 MHz Dipole - SN 03/15 DIP 1G800-349
1900 MHz Dipole - SN 03/15 DIP 1G900-350
2450 MHz Dipole - SN 03/15 DIP 2G450-352
2600 MHz Dipole - SN 03/15 DIP 2G600-356
3500 MHz Dipole - SN 09/12 DIP 3G500-360
5000-6000 MHz Dipole - SN 13/14 WGA 33
Extended Calibration Certificate



COMOSAR E-Field Probe Calibration Report

Ref : ACR.261.11.23.BES.A

**SHENZHEN NTEK TESTING TECHNOLOGY
CO., LTD.**

**BUILDING E, FENDA SCIENCE PARK, SANWEI
COMMUNITY, XIXIANG STREET,
BAO'AN DISTRICT, SHENZHEN GUANGDONG, CHINA
MVG COMOSAR DOSIMETRIC E-FIELD PROBE
SERIAL NO.: 3423-EPGO-426**

Calibrated at MVG

Z.I. de la pointe du diable

**Technopôle Brest Iroise – 295 avenue Alexis de Rochon
29280 PLOUZANE - FRANCE**

Calibration date: 09/18/2023



Accreditations #2-6789
Scope available on www.cofrac.fr

The use of the Cofrac brand and the accreditation references is prohibited from any reproduction.



Summary:

This document presents the method and results from an accredited COMOSAR Dosimetric E-Field Probe calibration performed at MVG, using the CALIPROBE test bench, for use with a MVG COMOSAR system only. The test results covered by accreditation are traceable to the International System of Units (SI).



COMOSAR E-FIELD PROBE CALIBRATION REPORT

Ref: ACR.261.11.23.BES.A

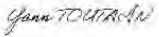
	<i>Name</i>	<i>Function</i>	<i>Date</i>	<i>Signature</i>
<i>Prepared by:</i>	Cyrille ONNEE	Measurement Responsible	9/18/2023	
<i>Checked & approved by:</i>	Jérôme Luc	Technical Manager	9/18/2023	
<i>Authorized by:</i>	Yann Toutain	Laboratory Director	9/19/2023	

Yann
Toutain ID 
Signature numérique de Yann Toutain ID
Date : 2023.09.19 09:08:14 +02'00'

	<i>Customer Name</i>
<i>Distribution :</i>	SHENZHEN NTEK TESTING TECHNOLOGY CO., LTD.

<i>Issue</i>	<i>Name</i>	<i>Date</i>	<i>Modifications</i>
A	Cyrille ONNEE	9/18/2023	Initial release



COMOSAR E-FIELD PROBE CALIBRATION REPORT

Ref: ACR.261.11.23.BES.A

TABLE OF CONTENTS

1	Device Under Test	4
2	Product Description	4
2.1	General Information	4
3	Measurement Method	4
3.1	Sensitivity	4
3.2	Linearity	5
3.3	Isotropy	5
3.4	Boundary Effect	5
4	Measurement Uncertainty	6
5	Calibration Results	6
5.1	Calibration in air	6
5.2	Calibration in liquid	7
6	Verification Results	8
7	List of Equipment	9



COMOSAR E-FIELD PROBE CALIBRATION REPORT

Ref: ACR.261.11.23.BES.A

1 DEVICE UNDER TEST

Device Under Test	
Device Type	COMOSAR DOSIMETRIC E FIELD PROBE
Manufacturer	MVG
Model	SSE2
Serial Number	3423-EPGO-426
Product Condition (new / used)	New
Frequency Range of Probe	0.15 GHz-7.5GHz
Resistance of Three Dipoles at Connector	Dipole 1: R1=0.261 MΩ Dipole 2: R2=0.213 MΩ Dipole 3: R3=0.233 MΩ

2 PRODUCT DESCRIPTION

2.1 GENERAL INFORMATION

MVG's COMOSAR E field Probes are built in accordance to the IEC/IEEE 62209-1528 and FCC KDB865664 D01 standards.



Figure 1 – MVG COMOSAR Dosimetric E field Probe

Probe Length	330 mm
Length of Individual Dipoles	2 mm
Maximum external diameter	8 mm
Probe Tip External Diameter	2.5 mm
Distance between dipoles / probe extremity	1 mm

3 MEASUREMENT METHOD

The IEC/IEEE 62209-1528 and FCC KDB865664 D01 standards provide recommended practices for the probe calibrations, including the performance characteristics of interest and methods by which to assess their effect. All calibrations / measurements performed meet the fore-mentioned standards.

3.1 SENSITIVITY

The sensitivity factors of the three dipoles were determined using a two step calibration method (air and tissue simulating liquid) using waveguides as outlined in the standards for frequency range 600-7500MHz and using the calorimeter cell method (transfer method) as outlined in the standards for frequency 150-450 MHz.



COMOSAR E-FIELD PROBE CALIBRATION REPORT

Ref: ACR 261.11.23.BES.A

3.2 LINEARITY

The evaluation of the linearity was done in free space using the waveguide, performing a power sweep to cover the SAR range 0.01W/kg to 100W/kg.

3.3 ISOTROPY

The axial isotropy was evaluated by exposing the probe to a reference wave from a standard dipole with the dipole mounted under the flat phantom in the test configuration suggested for system validations and checks. The probe was rotated along its main axis from 0 to 360 degrees in 15-degree steps. The hemispherical isotropy is determined by inserting the probe in a thin plastic box filled with tissue-equivalent liquid, with the plastic box illuminated with the fields from a half wave dipole. The dipole is rotated about its axis (0°-180°) in 15° increments. At each step the probe is rotated about its axis (0°-360°).

3.4 BOUNDARY EFFECT

The boundary effect is defined as the deviation between the SAR measured data and the expected exponential decay in the liquid when the probe is oriented normal to the interface. To evaluate this effect, the liquid filled flat phantom is exposed to fields from either a reference dipole or waveguide. With the probe normal to the phantom surface, the peak spatial average SAR is measured and compared to the analytical value at the surface.

The boundary effect uncertainty can be estimated according to the following uncertainty approximation formula based on linear and exponential extrapolations between the surface and $d_{be} + d_{step}$ along lines that are approximately normal to the surface:

$$SAR_{uncertainty} [\%] = \Delta SAR_{be} \frac{(d_{be} + d_{step})^2}{2d_{step}} \frac{(e^{-d_{be}/\delta})}{\delta/2} \text{ for } (d_{be} + d_{step}) < 10 \text{ mm}$$

where

- $SAR_{uncertainty}$ is the uncertainty in percent of the probe boundary effect
- d_{be} is the distance between the surface and the closest *zoom-scan* measurement point, in millimetre
- Δ_{step} is the separation distance between the first and second measurement points that are closest to the phantom surface, in millimetre, assuming the boundary effect at the second location is negligible
- δ is the minimum penetration depth in millimetres of the head tissue-equivalent liquids defined in this standard, i.e., $\delta \approx 14$ mm at 3 GHz;
- ΔSAR_{be} in percent of SAR is the deviation between the measured SAR value, at the distance d_{be} from the boundary, and the analytical SAR value.

The measured worst case boundary effect SARuncertainty[%] for scanning distances larger than 4mm is 1.0% Limit ,2%).



COMOSAR E-FIELD PROBE CALIBRATION REPORT

Ref: ACR.261.11.23.BES.A

4 MEASUREMENT UNCERTAINTY

The guidelines outlined in the IEC/IEEE 62209-1528 and FCC KDB865664 D01 standards were followed to generate the measurement uncertainty associated with a SAR probe calibration using the waveguide or calorimetric cell technique depending on the frequency.

The estimated expanded uncertainty (k=2) in calibration for SAR (W/kg) is +/-11% for the frequency range 150-450MHz.

The estimated expanded uncertainty (k=2) in calibration for SAR (W/kg) is +/-14% for the frequency range 600-7500MHz.

5 CALIBRATION RESULTS

Ambient condition	
Liquid Temperature	20 +/- 1 °C
Lab Temperature	20 +/- 1 °C
Lab Humidity	30-70 %

5.1 CALIBRATION IN AIR

The following curve represents the measurement in waveguide of the voltage picked up by the probe toward the E-field generated inside the waveguide.

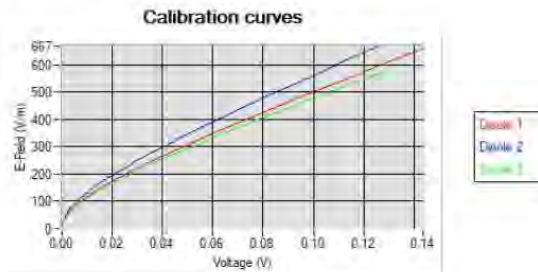

From this curve, the sensitivity in air is calculated using the below formula.

$$E^2 = \sum_{i=1}^3 \frac{V_i (1 + V_i / DCP_i)}{Norm_i}$$

where

Vi=voltage readings on the 3 channels of the probe

DCPi=diode compression point given below for the 3 channels of the probe

Normi=dipole sensitivity given below for the 3 channels of the probe