

FCC SAR EVALUATION REPORT

**In accordance with the requirements of
FCC 47 CFR Part 2(2.1093), ANSI/IEEE C95.1-1992 and
IEEE Std 1528-2013**

Product Name : Smart Phone
Brand Name : ulefone
Model Name : GQ5003
Family Model : Power Armor 19T, Power Armor 19,
Power Armor 19 Pro, Power Armor 19E,
Power Armor 19S, Power Armor 19 Plus,
Power Armor 19 Lite
Report No. : STR221128003009E
FCC ID : 2AOWK-5003TF

Prepared for

Shenzhen Gotron Electronic CO.,LTD
7B01, Building A, Block 1, Anhongji Tianyao Plaza, Longhua District, Shenzhen City,
Guangdong Province China

Prepared by

Shenzhen NTEK Testing Technology Co., Ltd.
1/F, Building E, Fenda Science Park, Sanwei Community, Xixiang Street,
Bao'an District, Shenzhen 518126 P.R.China.

Tel. 400-800-6106, 0755-2320 0050, 0755-2320 0090

Website: <http://www.ntek.org.cn>

TEST RESULT CERTIFICATION

Applicant's name : Shenzhen Gotron Electronic CO.,LTD
Address: 7B01, Building A, Block 1, Anhongji Tianyao Plaza, Longhua District, Shenzhen City, Guangdong Province China

Manufacturer's Name : Shenzhen Gotron Electronic CO.,LTD
Address: 7B01, Building A, Block 1, Anhongji Tianyao Plaza, Longhua District, Shenzhen City, Guangdong Province China

Product description

Product name : Smart Phone
Brand Name : ulefone
Model and/or type reference : GQ5003
Family Model : Power Armor 19T, Power Armor 19, Power Armor 19 Pro, Power Armor 19E, Power Armor 19S, Power Armor 19 Plus, Power Armor 19 Lite
FCC 47 CFR Part 2(2.1093)

Standards : ANSI/IEEE C95.1-1992
IEEE Std 1528-2013
Published RF exposure KDB procedures

This device described above has been tested by Shenzhen NTEK. In accordance with the measurement methods and procedures specified in IEEE Std 1528-2013 and KDB 865664 D01. Testing has shown that this device is capable of compliance with localized specific absorption rate (SAR) specified in FCC 47 CFR Part 2(2.1093) and ANSI/IEEE C95.1-1992. The test results in this report apply only to the tested sample of the stated device/equipment. Other similar device/equipment will not necessarily produce the same results due to production tolerance and measurement uncertainties.

This report shall not be reproduced except in full, without the written approval of Shenzhen NTEK, this document may be altered or revised by Shenzhen NTEK, personal only, and shall be noted in the revision of the document.

Test Sample Number : T221128002R002

Date of Test

Date (s) of performance of tests: Dec. 02, 2022 ~ Dec. 13, 2022

Date of Issue : Dec. 27, 2022

Test Result : Pass

Prepared By (Test Engineer) : Jacob Chen (Jacob Chen)

Approved By (Lab Manager) : Alex Li (Alex Li)

※ ※ Revision History ※ ※

REV.	DESCRIPTION	ISSUED DATE	REMARK
Rev.1.0	Initial Test Report Release	Dec. 27, 2022	Jacob Chen

TABLE OF CONTENTS

1.	General Information	6
1.1.	RF exposure limits.....	6
1.2.	Statement of Compliance	7
1.3.	EUT Description	7
1.4.	Test specification(s)	9
1.5.	Ambient Condition.....	9
2.	SAR Measurement System	10
2.1.	SATIMO SAR Measurement Set-up Diagram	10
2.2.	Robot	11
2.3.	E-Field Probe.....	12
2.3.1.	E-Field Probe Calibration	12
2.4.	SAM phantoms	13
2.4.1.	Technical Data	14
2.5.	Device Holder	15
2.6.	Test Equipment List	16
3.	SAR Measurement Procedures	18
3.1.	Power Reference	18
3.2.	Area scan & Zoom scan.....	18
3.3.	Description of interpolation/extrapolation scheme	20
3.4.	Volumetric Scan	20
3.5.	Power Drift	20
4.	System Verification Procedure	21
4.1.	Tissue Verification	21
4.1.1.	Tissue Dielectric Parameter Check Results	22
4.2.	System Verification Procedure	23
4.2.1.	System Verification Results.....	24
5.	SAR Measurement variability and uncertainty	25
5.1.	SAR measurement variability.....	25
5.2.	SAR measurement uncertainty	25
6.	RF Exposure Positions.....	26
6.1.	Ear and handset reference point	26
6.2.	Definition of the cheek position	26
6.3.	Definition of the tilt position	28
6.4.	Body Worn Accessory	28
6.5.	Wireless Router Devices	29
7.	RF Output Power	30
7.1.	GSM Conducted Power	30
7.2.	WCDMA Conducted Power	30
7.3.	LTE Conducted Power	31

7.4. WLAN & Bluetooth Output Power	49
8. Antenna Location.....	52
9. Stand-alone SAR test exclusion.....	52
10. SAR Results	53
10.1. SAR measurement Result.....	53
10.1.1. SAR measurement Result of GSM850.....	53
10.1.2. SAR measurement Result of GSM1900.....	54
10.1.3. SAR measurement Result of WCDMA Band 2.....	55
10.1.4. SAR measurement Result of WCDMA Band 4.....	56
10.1.5. SAR measurement Result of WCDMA Band 5.....	57
10.1.6. SAR measurement Result of LTE Band 2	58
10.1.7. SAR measurement Result of LTE Band 4	60
10.1.8. SAR measurement Result of LTE Band 5	62
10.1.9. SAR measurement Result of LTE Band 7	64
10.1.10. SAR measurement Result of LTE Band 12	66
10.1.11. SAR measurement Result of LTE Band 13	68
10.1.12. SAR measurement Result of LTE Band 17	70
10.1.13. SAR measurement Result of LTE Band 25	72
10.1.14. SAR measurement Result of LTE Band 41	74
10.1.15. SAR measurement Result of WLAN 2.4G	75
10.1.16. SAR measurement Result of WLAN 5.2G	76
10.1.17. SAR measurement Result of WLAN 5.8G	77
10.2. Simultaneous Transmission Analysis.....	78
11. Appendix A. Photo documentation	80
12. Appendix B. System Check Plots.....	80
13. Appendix C. Plots of High SAR Measurement.....	97
14. Appendix D. Calibration Certificate	166

1. General Information

1.1. RF exposure limits

(A).Limits for Occupational/Controlled Exposure (W/kg)

Whole-Body	Partial-Body	Hands, Wrists, Feet and Ankles
0.4	8.0	20.0

(B).Limits for General Population/Uncontrolled Exposure (W/kg)

Whole-Body	Partial-Body	Hands, Wrists, Feet and Ankles
0.08	1.6	4.0

NOTE: **Whole-Body SAR** is averaged over the entire body, **partial-body SAR** is averaged over any 1 gram of tissue defined as a tissue volume in the shape of a cube. **SAR for hands, wrists, feet and ankles** is averaged over any 10 grams of tissue defined as a tissue volume in the shape of a cube.

Occupational/Controlled Environments:

Are defined as locations where there is exposure that may be incurred by people who are aware of the potential for exposure, (i.e. as a result of employment or occupation).

General Population/Uncontrolled Environments:

Are defined as locations where there is the exposure of individuals who have no knowledge or control of their exposure.

NOTE
 HEAD AND TRUNK LIMIT
 1.6 W/kg
 APPLIED TO THIS EUT

1.2. Statement of Compliance

The maximum results of Specific Absorption Rate (SAR) found during testing for GQ5003 are as follows.

RF Exposure Conditions		Equipment Class -Highest Reported SAR (W/kg)			
		PCE	DTS	NII	DSS
1-g Head		1.196	0.379	0.398	N/A
1-g Body-Worn (Separation distance of 10mm)		1.065	0.092	0.272	N/A
1-g Hotspot (Separation distance of 10mm)		1.065	0.092	0.272	N/A
Max Simultaneous Tx	Head	1.594	1.575	1.594	1.363
	Body-Worn	1.337	1.157	1.337	1.149
	Hotspot	1.337	1.157	1.337	1.149

Note: The Max Simultaneous Tx is calculated based on the same configuration and test position. This device is in compliance with Specific Absorption Rate (SAR) for general population/uncontrolled exposure limits (1.6 W/kg) specified in FCC 47 CFR Part 2(2.1093) and ANSI/IEEE C95.1-1992, and had been tested in accordance with the measurement methods and procedures specified in IEEE Std 1528-2013 & KDB 865664 D01.

1.3. EUT Description

Device Information	
Product Name	Smart Phone
Brand Name	ulefone
Model Name	GQ5003
Family Model	Power Armor 19T, Power Armor 19, Power Armor 19 Pro, Power Armor 19E, Power Armor 19S, Power Armor 19 Plus, Power Armor 19 Lite
Model Difference	All models are the same circuit and RF module, except the model name.
FCC ID	2AOWK-5003TF
Device Phase	Identical Prototype
Exposure Category	General population / Uncontrolled environment
Antenna Type	PIFA Antenna
Battery Information	DC 3.87V, 9600mAh
HW Version	M118-MUB-V2
SW Version	Power_Armor_19_TF1_EEA_V10
Device Operating Configurations	
Supporting Mode(s)	GSM 850/1900, WCDMA Band 2/4/5, LTE Band 2/4/5/7/12/13

	/17/25/41, WLAN 2.4G/5G, Bluetooth, NFC		
Test Modulation	GSM(GMSK/8PSK), WCDMA(QPSK), LTE(QPSK/16QAM), WLAN(DSSS/OFDM), Bluetooth(GFSK, $\pi/4$ -DQPSK, 8DPSK), NFC(ASK)		
Device Class	B		
Operating Frequency Range(s)	Band	Tx (MHz)	Rx (MHz)
	GSM 850	824-849	869-894
	GSM 1900	1850-1910	1930-1990
	WCDMA Band 2	1850-1910	1930-1990
	WCDMA Band 4	1710-1755	2110-2155
	WCDMA Band 5	824-849	869-894
	LTE Band 2	1850-1910	1930-1990
	LTE Band 4	1710-1755	2110-2155
	LTE Band 5	824-849	869-894
	LTE Band 7	2500-2570	2620-2690
	LTE Band 12	699-716	729-746
	LTE Band 13	777-787	746-756
	LTE Band 17	704-716	734-746
	LTE Band 25	1850-1915	1930-1995
	LTE Band 41	2535-2655	
	WLAN 2.4G	2412-2462	
	WLAN 5.2G	5180-5240	
	WLAN 5.8G	5745-5825	
	Bluetooth	2402-2480	
NFC	13.56		
GPRS Multislot Class(12)	Max Number of Timeslots in Uplink	4	
	Max Number of Timeslots in Downlink	4	
	Max Total Timeslot	5	
EGPRS Multislot Class(12)	Max Number of Timeslots in Uplink	4	
	Max Number of Timeslots in Downlink	4	
	Max Total Timeslot	5	
Power Class	4, tested with power level 5(GSM 850)		
	1, tested with power level 0(GSM 1900)		
	3, tested with power control "all 1"(WCDMA Band 2)		
	3, tested with power control "all 1"(WCDMA Band 4)		
	3, tested with power control "all 1"(WCDMA Band 5)		
	3, tested with power control all Max.(LTE Band 2)		
	3, tested with power control all Max.(LTE Band 4)		
	3, tested with power control all Max.(LTE Band 5)		
3, tested with power control all Max.(LTE Band 7)			

	3, tested with power control all Max.(LTE Band 12)
	3, tested with power control all Max.(LTE Band 13)
	3, tested with power control all Max.(LTE Band 17)
	3, tested with power control all Max.(LTE Band 25)
	3, tested with power control all Max.(LTE Band 41)

1.4. Test specification(s)

FCC 47 CFR Part 2(2.1093)
ANSI/IEEE C95.1-1992
IEEE Std 1528-2013
KDB 865664 D01 SAR measurement 100 MHz to 6 GHz
KDB 865664 D02 RF Exposure Reporting
KDB 447498 D01 General RF Exposure Guidance
KDB 248227 D01 802.11 Wi-Fi SAR
KDB 941225 D01 3G SAR Procedures
KDB 941225 D05 SAR for LTE Devices
KDB 941225 D06 Hotspot SAR
KDB 648474 D04 Handset SAR

1.5. Ambient Condition

Ambient temperature	20°C – 24°C
Relative Humidity	30% – 70%

2. SAR Measurement System

2.1. SATIMO SAR Measurement Set-up Diagram

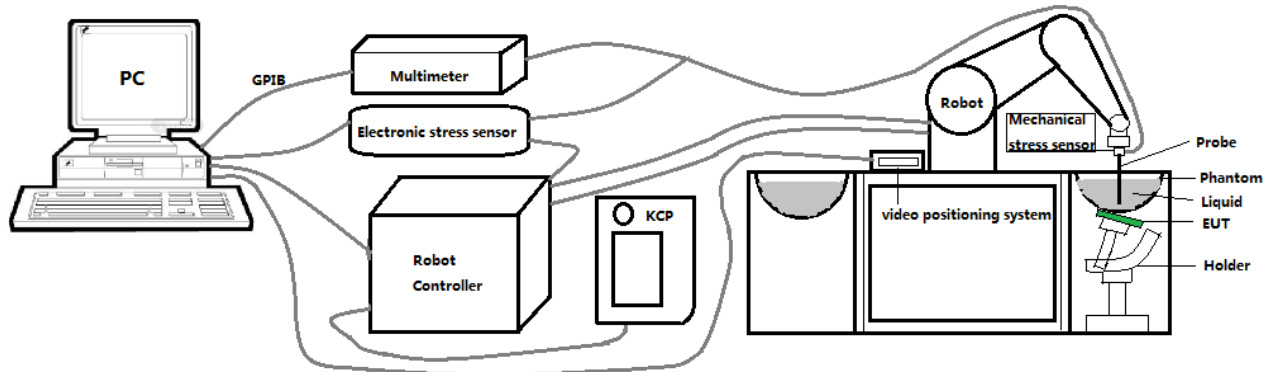

These measurements were performed with the automated near-field scanning system OPENSAR from SATIMO. The system is based on a high precision robot (working range: 901 mm), which positions the probes with a positional repeatability of better than ± 0.03 mm. The SAR measurements were conducted with dosimetric probe (manufactured by SATIMO), designed in the classical triangular configuration and optimized for dosimetric evaluation.

The first step of the field measurement is the evaluation of the voltages induced on the probe by the device under test. Probe diode detectors are nonlinear. Below the diode compression point, the output voltage is proportional to the square of the applied E-field; above the diode compression point, it is linear to the applied E-field. The compression point depends on the diode, and a calibration procedure is necessary for each sensor of the probe.

The Keithley multimeter reads the voltage of each sensor and send these three values to the PC. The corresponding E field value is calculated using the probe calibration factors, which are stored in the working directory. This evaluation includes linearization of the diode characteristics. The field calculation is done separately for each sensor. Each component of the E field is displayed on the "Dipole Area Scan Interface" and the total E field is displayed on the "3D Interface"

2.2. Robot

The SATIMO SAR system uses the high precision robots from KUKA. For the 6-axis controller system, the robot controller version (KUKA) from KUKA is used. The KUKA robot series have many features that are important for our application:



- High precision (repeatability ± 0.03 mm)
- High reliability (industrial design)
- Jerk-free straight movements
- Low ELF interference (the closed metallic construction shields against motor control fields)

2.3. E-Field Probe

This E-field detection probe is composed of three orthogonal dipoles linked to special Schottky diodes with low detection thresholds. The probe allows the measurement of electric fields in liquids such as the one defined in the IEEE and CENELEC standards.

For the measurements the Specific Dosimetric E-Field Probe SN 08/16 EPGO287 with following specifications is used



- Dynamic range: 0.01-100 W/kg
 - Tip Diameter : 2.5 mm
 - Distance between probe tip and sensor center: 1 mm
 - Distance between sensor center and the inner phantom surface: 2 mm (repeatability better than ± 1 mm).
 - Probe linearity: ± 0.08 dB
 - Axial isotropy: ± 0.01 dB
 - Hemispherical Isotropy: ± 0.01 dB
 - Calibration range: 650MHz to 5900MHz for head & body simulating liquid.
 - Lower detection limit: 8mW/kg
- Angle between probe axis (evaluation axis) and surface normal line: less than 30° .

2.3.1. E-Field Probe Calibration

Each probe needs to be calibrated according to a dosimetric assessment procedure with accuracy better than $\pm 10\%$. The spherical isotropy shall be evaluated and within ± 0.25 dB. The sensitivity parameters (Norm X, Norm Y, and Norm Z), the diode compression parameter (DCP) and the conversion factor (Conv F) of the probe are tested. The calibration data can be referred to appendix D of this report.

2.4. SAM phantoms

Photo of SAM phantom SN 16/15 SAM119



The SAM phantom is used to measure the SAR relative to people exposed to electro-magnetic field radiated by Smart Phones.

2.4.1. Technical Data

Serial Number	Shell thickness	Filling volume	Dimensions	Positionner Material	Permittivity	Loss Tangent
SN 16/15 SAM119	2 mm ±0.2 mm	27 liters	Length:1000 mm Width:500 mm Height:200 mm	Gelcoat with fiberglass	3.4	0.02

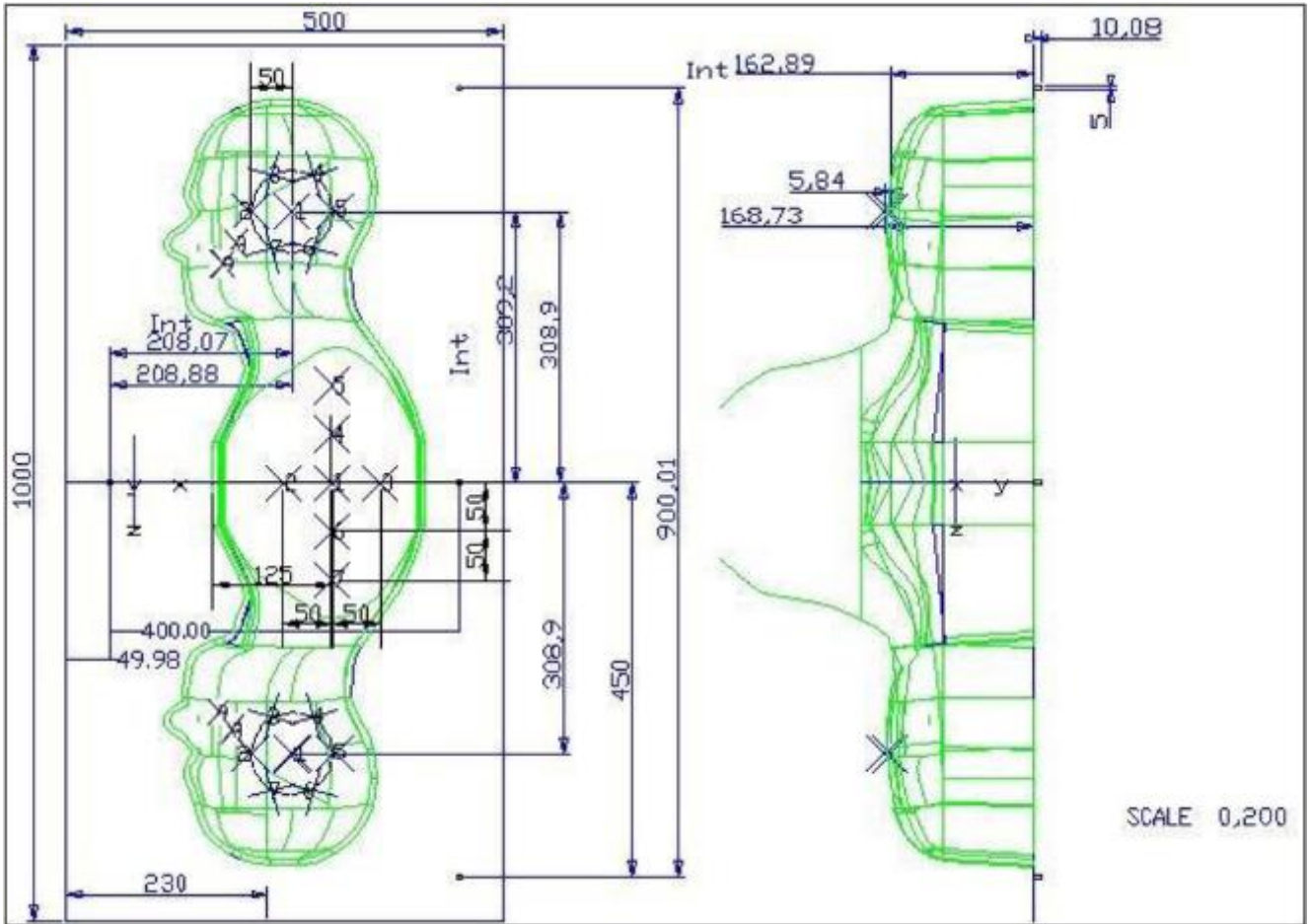

Serial Number	Left Head(mm)		Right Head(mm)		Flat Part(mm)	
	1	2	1	2	1	2
SN 16/15 SAM119	2	2.02	2	2.08	1	2.09
	3	2.05	3	2.06	2	2.06
	4	2.07	4	2.07	3	2.08
	5	2.08	5	2.08	4	2.10
	6	2.05	6	2.07	5	2.10
	7	2.05	7	2.05	6	2.07
	8	2.07	8	2.06	7	2.07
	9	2.08	9	2.06	-	-

The test, based on ultrasonic system, allows measuring the thickness with an accuracy of 10 µm.

2.5. Device Holder

The positioning system allows obtaining cheek and tilting position with a very good accuracy. In compliance with CENELEC, the tilt angle uncertainty is lower than 1 degree.

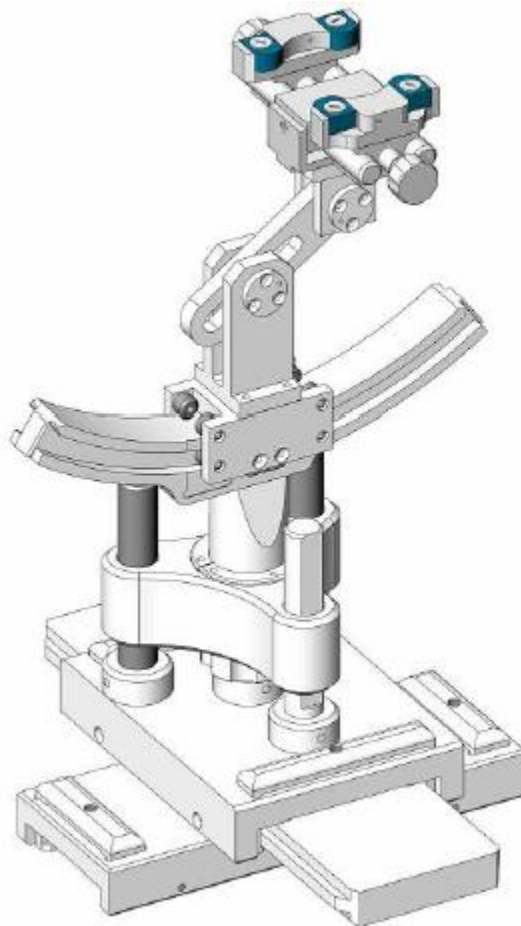

Serial Number	Holder Material	Permittivity	Loss Tangent
SN 16/15 MSH100	Delrin	3.7	0.005

2.6. Test Equipment List

This table gives a complete overview of the SAR measurement equipment.

Devices used during the test described are marked

	Manufacturer	Name of Equipment	Type/Model	Serial Number	Calibration	
					Last Cal.	Due Date
<input checked="" type="checkbox"/>	MVG	E FIELD PROBE	SSE2	SN 08/16 EPGO287	Feb. 01, 2022	Jan. 31, 2023
<input checked="" type="checkbox"/>	MVG	750 MHz Dipole	SID750	SN 03/15 DIP 0G750-355	Mar. 01, 2021	Feb. 28, 2024
<input checked="" type="checkbox"/>	MVG	835 MHz Dipole	SID835	SN 03/15 DIP 0G835-347	Mar. 01, 2021	Feb. 28, 2024
<input type="checkbox"/>	MVG	900 MHz Dipole	SID900	SN 03/15 DIP 0G900-348	Mar. 01, 2021	Feb. 28, 2024
<input checked="" type="checkbox"/>	MVG	1800 MHz Dipole	SID1800	SN 03/15 DIP 1G800-349	Mar. 01, 2021	Feb. 28, 2024
<input checked="" type="checkbox"/>	MVG	1900 MHz Dipole	SID1900	SN 03/15 DIP 1G900-350	Mar. 01, 2021	Feb. 28, 2024
<input type="checkbox"/>	MVG	2000 MHz Dipole	SID2000	SN 03/15 DIP 2G000-351	Mar. 01, 2021	Feb. 28, 2024
<input type="checkbox"/>	MVG	2300 MHz Dipole	SID2300	SN 03/16 DIP 2G300-358	Mar. 01, 2021	Feb. 28, 2024
<input checked="" type="checkbox"/>	MVG	2450 MHz Dipole	SID2450	SN 03/15 DIP 2G450-352	Mar. 01, 2021	Feb. 28, 2024
<input checked="" type="checkbox"/>	MVG	2600 MHz Dipole	SID2600	SN 03/15 DIP 2G600-356	Mar. 01, 2021	Feb. 28, 2024
<input checked="" type="checkbox"/>	MVG	5000 MHz Dipole	SWG5500	SN 13/14 WGA 33	Mar. 01, 2021	Feb. 28, 2024
<input checked="" type="checkbox"/>	MVG	Liquid measurement Kit	SCLMP	SN 21/15 OCPG 72	NCR	NCR
<input checked="" type="checkbox"/>	MVG	Power Amplifier	N.A	AMPLISAR_28/14_003	NCR	NCR
<input checked="" type="checkbox"/>	KEITHLEY	Millivoltmeter	2000	4072790	NCR	NCR
<input checked="" type="checkbox"/>	R&S	Universal radio communication tester	CMU200	117858	Jun. 17, 2022	Jun. 16, 2023
<input checked="" type="checkbox"/>	R&S	Wideband radio communication tester	CMW500	103917	Jun. 17, 2022	Jun. 16, 2023
<input checked="" type="checkbox"/>	HP	Network Analyzer	8753D	3410J01136	Jun. 17, 2022	Jun. 16, 2023

<input checked="" type="checkbox"/>	Agilent	MXG Vector Signal Generator	N5182A	MY47070317	Jun. 16, 2022	Jun. 15, 2023
<input checked="" type="checkbox"/>	Agilent	Power meter	E4419B	MY45102538	Jun. 17, 2022	Jun. 16, 2023
<input checked="" type="checkbox"/>	Agilent	Power sensor	E9301A	MY41495644	Jun. 17, 2022	Jun. 16, 2023
<input checked="" type="checkbox"/>	Agilent	Power sensor	E9301A	US39212148	Jun. 17, 2022	Jun. 16, 2023
<input checked="" type="checkbox"/>	MCLI/USA	Directional Coupler	CB11-20	0D2L51502	Jul. 17, 2020	Jul. 16, 2023

3. SAR Measurement Procedures

The measurement procedures are as follows:

<Conducted power measurement>

- (a) For WWAN power measurement, use base station simulator to configure EUT WWAN transmission in conducted connection with RF cable, at maximum power in each supported wireless interface and frequency band.
- (b) Read the WWAN RF power level from the base station simulator.
- (c) For Wi-Fi/BT power measurement, use engineering software to configure EUT Wi-Fi/BT continuously transmission, at maximum RF power in each supported wireless interface and frequency band.
- (d) Connect EUT RF port through RF cable to the power meter, and measure Wi-Fi/BT output power.

<SAR measurement>

- (a) Use base station simulator to configure EUT WWAN transmission in radiated connection, and engineering software to configure EUT Wi-Fi/BT continuously transmission, at maximum RF power, in the highest power channel.
- (b) Place the EUT in the positions as Appendix A demonstrates.
- (c) Set scan area, grid size and other setting on the OPENSAR software.
- (d) Measure SAR results for the highest power channel on each testing position.
- (e) Find out the largest SAR result on these testing positions of each band.
- (f) Measure SAR results for other channels in worst SAR testing position if the reported SAR of highest power channel is larger than 0.8 W/kg.

According to the test standard, the recommended procedure for assessing the peak spatial-average SAR value consists of the following steps:

- (a) Power reference measurement
- (b) Area scan
- (c) Zoom scan
- (d) Power drift measurement

3.1. Power Reference

The Power Reference Measurement and Power Drift Measurements are for monitoring the power drift of the device under test in the batch process. The minimum distance of probe sensors to surface determines the closest measurement point to phantom surface. This distance cannot be smaller than the distance of sensor calibration points to probe tip as defined in the probe properties.

3.2. Area scan & Zoom scan

The area scan is a 2D scan to find the hot spot location on the DUT. The zoom scan is a 3D scan

above the hot spot to calculate the 1g and 10g SAR value.

Measurement of the SAR distribution with a grid of 8 to 16 mm * 8 to 16 mm and a constant distance to the inner surface of the phantom. Since the sensors cannot directly measure at the inner phantom surface, the values between the sensors and the inner phantom surface are extrapolated. With these values the area of the maximum SAR is calculated by an interpolation scheme. Around this point, a cube of 30 * 30 * 30 mm or 32 * 32 * 32 mm is assessed by measuring 5 or 8 * 5 or 8 * 4 or 5 mm. With these data, the peak spatial-average SAR value can be calculated.

From the scanned SAR distribution, identify the position of the maximum SAR value, in addition identify the positions of any local maxima with SAR values within 2 dB of the maximum value that will not be within the zoom scan of other peaks; additional peaks shall be measured only when the primary peak is within 2 dB of the SAR compliance limit (e.g., 1 W/kg for 1,6 W/kg 1 g limit, or 1,26 W/kg for 2 W/kg, 10 g limit).

Area scan & Zoom scan scan parameters extracted from FCC KDB 865664 D01 SAR measurement 100 MHz to 6 GHz.

		≤ 3 GHz	> 3 GHz	
Maximum distance from closest measurement point (geometric center of probe sensors) to phantom surface		5 ± 1 mm	½·δ·ln(2) ± 0.5 mm	
Maximum probe angle from probe axis to phantom surface normal at the measurement location		30° ± 1°	20° ± 1°	
Maximum area scan spatial resolution: Δx _{Area} , Δy _{Area}		≤ 2 GHz: ≤ 15 mm 2 – 3 GHz: ≤ 12 mm	3 – 4 GHz: ≤ 12 mm 4 – 6 GHz: ≤ 10 mm	
		When the x or y dimension of the test device, in the measurement plane orientation, is smaller than the above, the measurement resolution must be ≤ the corresponding x or y dimension of the test device with at least one measurement point on the test device.		
Maximum zoom scan spatial resolution: Δx _{Zoom} , Δy _{Zoom}		≤ 2 GHz: ≤ 8 mm 2 – 3 GHz: ≤ 5 mm*	3 – 4 GHz: ≤ 5 mm* 4 – 6 GHz: ≤ 4 mm*	
Maximum zoom scan spatial resolution, normal to phantom surface	uniform grid: Δz _{Zoom} (n)	≤ 5 mm	3 – 4 GHz: ≤ 4 mm 4 – 5 GHz: ≤ 3 mm 5 – 6 GHz: ≤ 2 mm	
	graded grid	Δz _{Zoom} (1): between 1 st two points closest to phantom surface	≤ 4 mm	3 – 4 GHz: ≤ 3 mm 4 – 5 GHz: ≤ 2.5 mm 5 – 6 GHz: ≤ 2 mm
		Δz _{Zoom} (n>1): between subsequent points	≤ 1.5·Δz _{Zoom} (n-1)	
Minimum zoom scan volume	x, y, z	≥ 30 mm	3 – 4 GHz: ≥ 28 mm 4 – 5 GHz: ≥ 25 mm 5 – 6 GHz: ≥ 22 mm	

Note: δ is the penetration depth of a plane-wave at normal incidence to the tissue medium; see draft standard IEEE P1528-2011 for details.

* When zoom scan is required and the *reported* SAR from the *area scan based 1-g SAR estimation* procedures of KDB 447498 is ≤ 1.4 W/kg, ≤ 8 mm, ≤ 7 mm and ≤ 5 mm zoom scan resolution may be applied, respectively, for 2 GHz to 3 GHz, 3 GHz to 4 GHz and 4 GHz to 6 GHz.

3.3. Description of interpolation/extrapolation scheme

The local SAR inside the phantom is measured using small dipole sensing elements inside a probe body. The probe tip must not be in contact with the phantom surface in order to minimise measurements errors, but the highest local SAR will occur at the surface of the phantom.

An extrapolation is used to determine these highest local SAR values. The extrapolation is based on a fourth-order least-square polynomial fit of measured data. The local SAR value is then extrapolated from the liquid surface with a 1 mm step.

The measurements have to be performed over a limited time (due to the duration of the battery) so the step of measurement is high. It could vary between 5 and 8 mm. To obtain an accurate assessment of the maximum SAR averaged over 10 grams and 1 gram requires a very fine resolution in the three dimensional scanned data array.

3.4. Volumetric Scan

The volumetric scan consists of a full 3D scan over a specific area. This 3D scan is useful for multi Tx SAR measurement. Indeed, it is possible with OpenSAR to add, point by point, several volumetric scans to calculate the SAR value of the combined measurement as it is defined in the standard IEEE1528 and IEC62209.

3.5. Power Drift

All SAR testing is under the EUT installed with a full charged battery and transmit maximum output power. In OpenSAR measurement software, the power reference measurement and power drift measurement procedures are used for monitoring the power drift of EUT during SAR test. Both these procedures measure the field at a specified reference position before and after the SAR testing. The software will calculate the field difference in V/m. If the power drifts more than $\pm 5\%$, the SAR will be retested.

4. System Verification Procedure

4.1. Tissue Verification

The following tissue formulations are provided for reference only as some of the parameters have not been thoroughly verified. The composition of ingredients may be modified accordingly to achieve the desired target tissue parameters required for routine SAR evaluation.

Ingredients (% of weight)	Head Tissue									
	750	835	900	1800	1900	2000	2450	2600	5200	5800
Frequency Band (MHz)										
Water	34.40	34.40	34.40	55.36	55.36	57.87	57.87	57.87	65.53	65.53
NaCl	0.79	0.79	0.79	0.35	0.35	0.16	0.16	0.16	0.00	0.00
1,2-Propanediol	64.81	64.81	64.81	0.00	0.00	0.00	0.00	0.00	0.00	0.00
Triton X-100	0.00	0.00	0.00	30.45	30.45	19.97	19.97	19.97	24.24	24.24
DGBE	0.00	0.00	0.00	13.84	13.84	22.00	22.00	22.00	10.23	10.23

For SAR measurement of the field distribution inside the phantom, the phantom must be filled with homogeneous tissue simulating liquid to a depth of at least 15 cm. For head SAR testing, the liquid depth from the ear reference point (ERP) of the phantom to the liquid top surface is larger than 15 cm.

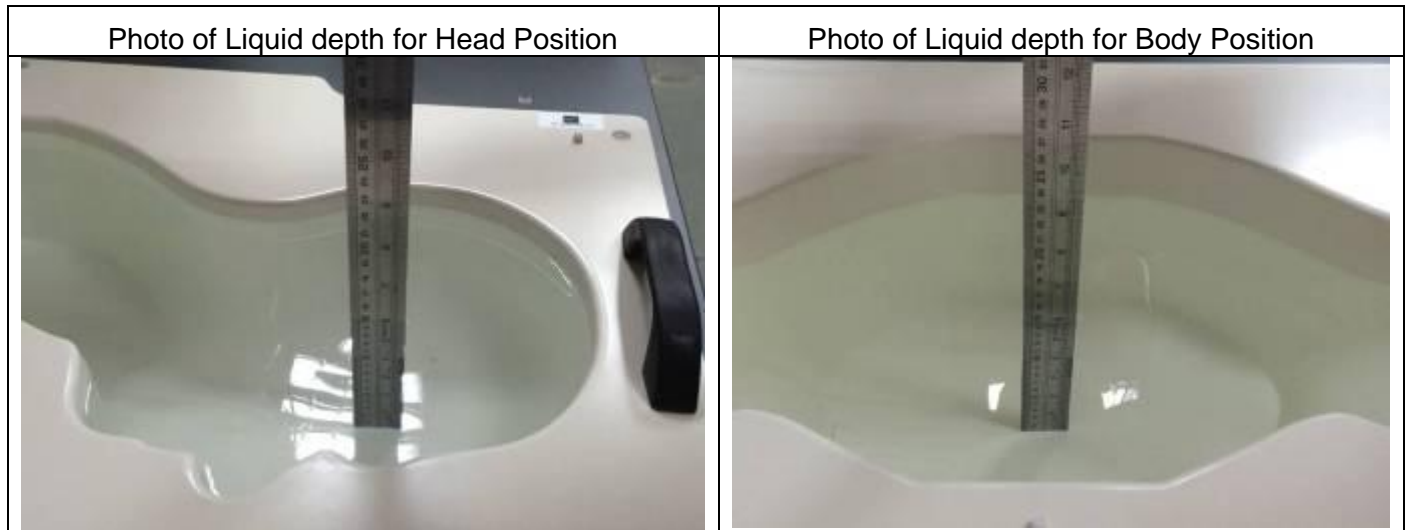

4.1.1. Tissue Dielectric Parameter Check Results

The simulating liquids should be checked at the beginning of a series of SAR measurements to determine if the dielectric parameters are within the tolerances of the specified target values. The measured conductivity and relative permittivity should be within $\pm 5\%$ of the target values.

Tissue Type	Measured Frequency (MHz)	Target Tissue		Measured Tissue		Liquid Temp.	Test Date
		ϵ_r ($\pm 5\%$)	σ (S/m) ($\pm 5\%$)	ϵ_r	σ (S/m)		
Head 750	750	41.96 (39.86~44.06)	0.89 (0.85~0.93)	40.64	0.90	21.8 °C	Dec. 13, 2022
Head 850	835	41.50 (39.43~43.58)	0.90 (0.86~0.95)	41.38	0.93	21.3 °C	Dec. 12, 2022
Head 1800	1800	40.00 (38.00~42.00)	1.40 (1.33~1.47)	38.92	1.39	21.4 °C	Dec. 06, 2022
Head 1900	1900	40.00 (38.00~42.00)	1.40 (1.33~1.47)	38.78	1.45	21.7 °C	Dec. 09, 2022
Head 2450	2450	39.20 (37.24~41.16)	1.80 (1.71~1.89)	38.00	1.83	21.7 °C	Dec. 02, 2022
Head 2600	2600	39.01 (37.06~40.96)	1.96 (1.86~2.06)	38.08	1.98	21.9 °C	Dec. 08, 2022
Head 5200	5200	36.00 (34.20~37.80)	4.66 (4.43~4.89)	35.93	4.79	21.6 °C	Dec. 07, 2022
Head 5800	5800	35.30 (33.54~37.07)	5.27 (5.01~5.53)	34.51	5.22	21.3 °C	Dec. 06, 2022

NOTE: The dielectric parameters of the tissue-equivalent liquid should be measured under similar ambient conditions and within 2 °C of the conditions expected during the SAR evaluation to satisfy protocol requirements.

4.2. System Verification Procedure

The system verification is performed for verifying the accuracy of the complete measurement system and performance of the software. The dipole is connected to the signal source consisting of signal generator and amplifier via a directional coupler, N-connector cable and adaption to SMA. It is fed with a power of 100mW (below 5GHz) or 100mW (above 5GHz). To adjust this power a power meter is used. The power sensor is connected to the cable before the system verification to measure the power at this point and do adjustments at the signal generator. At the outputs of the directional coupler both return loss as well as forward power are controlled during the system verification to make sure that emitted power at the dipole is kept constant. This can also be checked by the power drift measurement after the test (result on plot).

The system verification is shown as below picture:

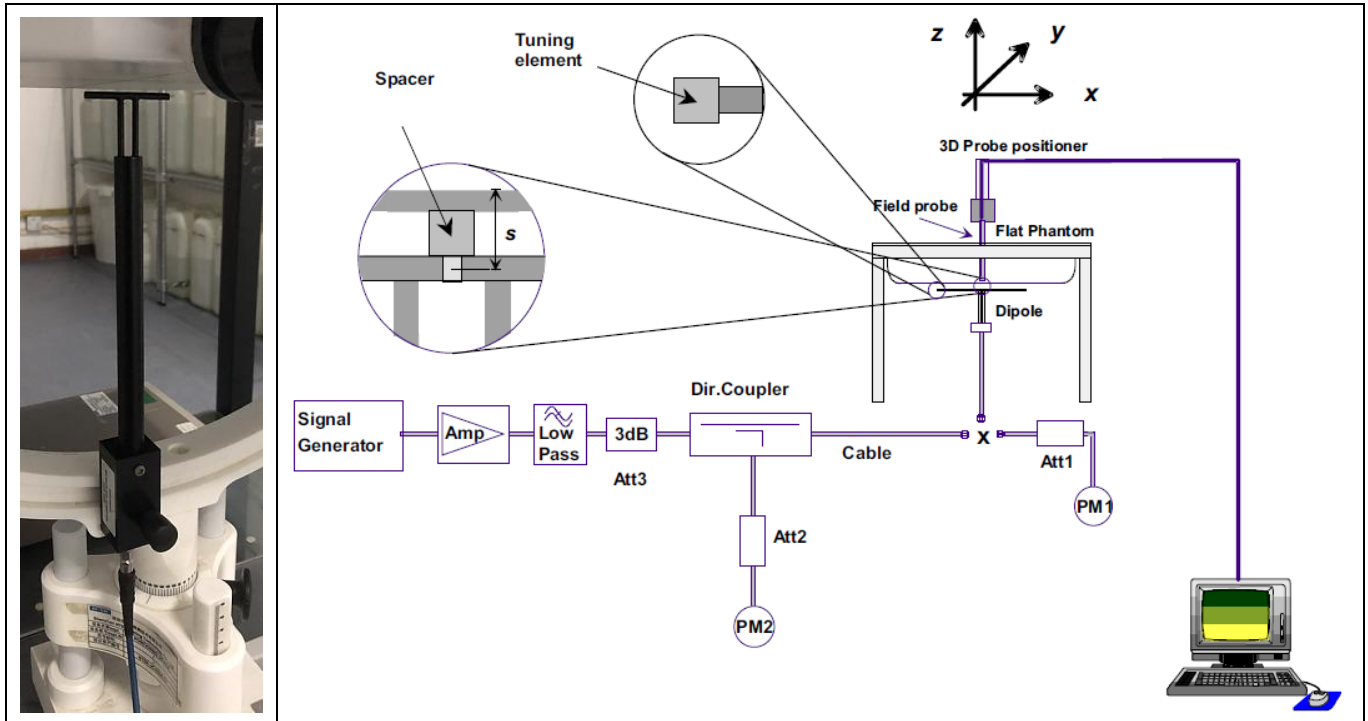

4.2.1. System Verification Results

Comparing to the original SAR value provided by SATIMO, the verification data should be within its specification of $\pm 10\%$. Below table shows the target SAR and measured SAR after normalized to 1W input power. The table below indicates the system performance verification can meet the variation criterion and the plots can be referred to Appendix B of this report.

System Verification	Target SAR (1W) ($\pm 10\%$)		Measured SAR (Normalized to 1W)		Liquid Temp.	Test Date
	1-g (W/Kg)	10-g (W/Kg)	1-g (W/Kg)	10-g (W/Kg)		
750MHz	8.53 (7.68~9.38)	5.56 (5.01~6.11)	8.92	5.10	21.8 °C	Dec. 13, 2022
835MHz	9.84 (8.86~10.82)	6.22 (5.60~6.84)	10.01	6.64	21.3 °C	Dec. 12, 2022
1800MHz	37.96 (34.17~41.75)	19.81 (17.83~21.79)	40.69	18.49	21.4 °C	Dec. 06, 2022
1900MHz	40.37 (36.34~44.40)	20.48 (18.44~22.52)	39.09	21.26	21.7 °C	Dec. 09, 2022
2450MHz	53.69 (48.33~59.05)	23.94 (21.55~26.33)	58.28	22.19	21.7 °C	Dec. 02, 2022
2600MHz	55.83 (50.25~61.41)	24.19 (21.78~26.60)	55.10	24.92	21.9 °C	Dec. 08, 2022
5200MHz	162.34 (146.11~178.57)	55.42 (49.88~60.96)	160.27	60.08	21.6 °C	Dec. 07, 2022
5800MHz	178.89 (161.01~196.77)	59.32 (53.39~65.25)	161.88	54.58	21.3 °C	Dec. 06, 2022

5. SAR Measurement variability and uncertainty

5.1. SAR measurement variability

Per KDB865664 D01 SAR measurement 100 MHz to 6 GHz, SAR measurement variability must be assessed for each frequency band, which is determined by the SAR probe calibration point and tissue-equivalent medium used for the device measurements. The additional measurements are repeated after the completion of all measurements requiring the same head or body tissue-equivalent medium in a frequency band. The test device should be returned to ambient conditions (normal room temperature) with the battery fully charged before it is re-mounted on the device holder for the repeated measurement(s) to minimize any unexpected variations in the repeated results.

- 1) Repeated measurement is not required when the original highest measured SAR is < 0.80 W/kg; steps 2) through 4) do not apply.
- 2) When the original highest measured SAR is ≥ 0.80 W/kg, repeat that measurement once.
- 3) Perform a second repeated measurement only if the ratio of largest to smallest SAR for the original and first repeated measurements is > 1.20 or when the original or repeated measurement is ≥ 1.45 W/kg (~ 10% from the 1-g SAR limit).
- 4) Perform a third repeated measurement only if the original, first or second repeated measurement is ≥ 1.5 W/kg and the ratio of largest to smallest SAR for the original, first and second repeated measurements is > 1.20 .

5.2. SAR measurement uncertainty

Per KDB865664 D01 SAR Measurement 100 MHz to 6 GHz, when the highest measured 1-g SAR within a frequency band is < 1.5 W/kg, the extensive SAR measurement uncertainty analysis described in IEEE Std 1528-2013 is not required in SAR reports submitted for equipment approval. The equivalent ratio (1.5/1.6) is applied to extremity and occupational exposure conditions.

6. RF Exposure Positions

6.1. Ear and handset reference point

Figure 6.1.1 shows the front, back, and side views of the SAM phantom. The center-of-mouth reference point is labeled “M”, the left ear reference point (ERP) is marked “LE”, and the right ERP is marked “RE”.



Fig 6.1.1 Front, back, and side views of SAM phantom

6.2. Definition of the cheek position

1. Define two imaginary lines on the handset, the vertical centerline and the horizontal line. The vertical centerline passes through two points on the front side of the handset: the midpoint of the width w_t of the handset at the level of the acoustic output (point A in Figure 6.2.1 and Figure 6.2.2), and the midpoint of the width w_b of the bottom of the handset (point B). The horizontal line is perpendicular to the vertical centerline and passes through the center of the acoustic output (see Figure 6.2.1). The two lines intersect at point A. Note that for many handsets, point A coincides with the center of the acoustic output; however, the acoustic output may be located elsewhere on the horizontal line. Also note that the vertical centerline is not necessarily parallel to the front face of the handset (see Figure 6.2.2), especially for clamshell handsets, handsets with flip covers, and other irregularly-shaped handsets.
2. Position the handset close to the surface of the phantom such that point A is on the (virtual) extension of the line passing through points RE and LE on the phantom (see Figure 6.2.3), such that the plane defined by the vertical centerline and the horizontal line of the handset is approximately parallel to the sagittal plane of the phantom.
3. Translate the handset towards the phantom along the line passing through RE and LE until handset point A touches the pinna at the ERP
4. While maintaining the handset in this plane, rotate it around the LE-RE line until the vertical centerline is in the plane normal to the plane containing B-M and N-F lines, i.e., the Reference Plane.
5. Rotate the handset around the vertical centerline until the handset (horizontal line) is parallel to the N-F line.

6. While maintaining the vertical centerline in the Reference Plane, keeping point A on the line passing through RE and LE, and maintaining the handset contact with the pinna, rotate the handset about the N-F line until any point on the handset is in contact with a phantom point below the pinna on the cheek. See Figure 6.2.3. The actual rotation angles should be documented in the test report.

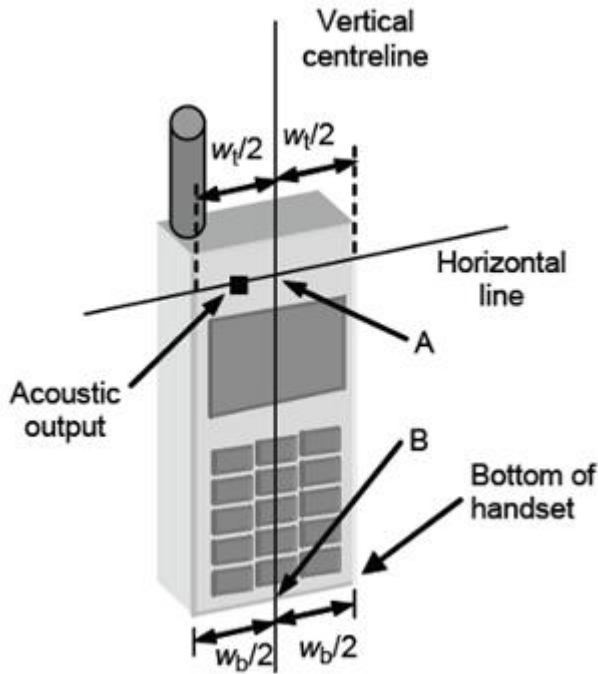

Fig 6.2.1 Handset vertical and horizontal reference lines—“fixed case”

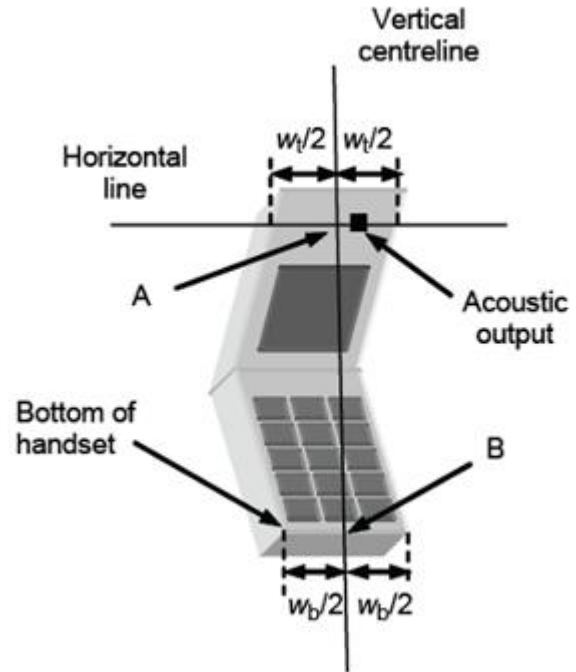

Fig 6.2.2 Handset vertical and horizontal reference lines—“clam-shell case”

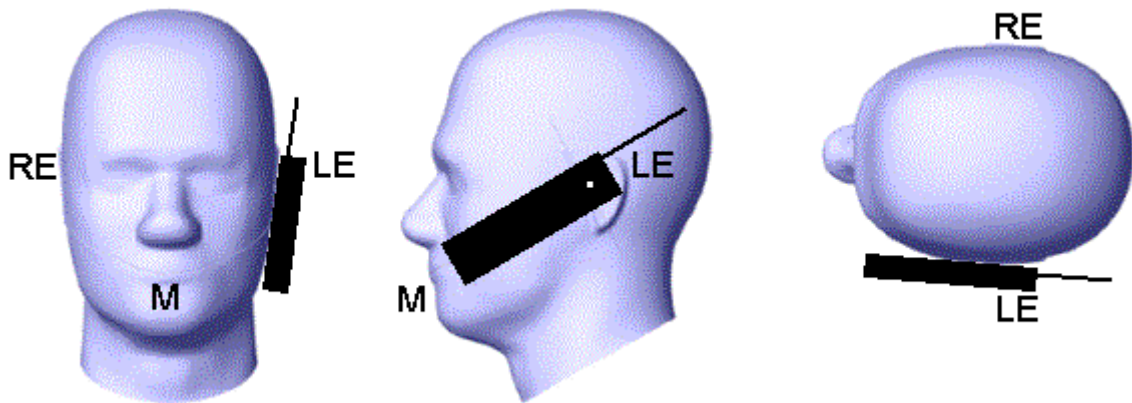

Fig 6.2.3 cheek or touch position. The reference points for the right ear (RE), left ear (LE), and mouth (M), which establish the Reference Plane for handset positioning, are indicated.

6.3. Definition of the tilt position

1. While maintaining the orientation of the handset, retract the handset parallel to the reference plane far enough away from the phantom to enable a rotation of the device by 15 degree.
2. Rotate the Handset around the horizontal line by 15 degree (see Figure 6.3.1).
3. While maintaining the orientation of the handset, move the handset towards the phantom on a line passing through RE and LE until any part of the handset touches the ear. The tilt position is obtained when the contact is on the pinna. If the contact is at any location other than the pinna, e.g., the antenna with the back of the phantom head, the angle of the handset shall be reduced. In this case, the tilt position is obtained if any part of the handset is in contact with the pinna as well as a second part of the handset is in contact with the phantom, e.g., the antenna with the back of the head.

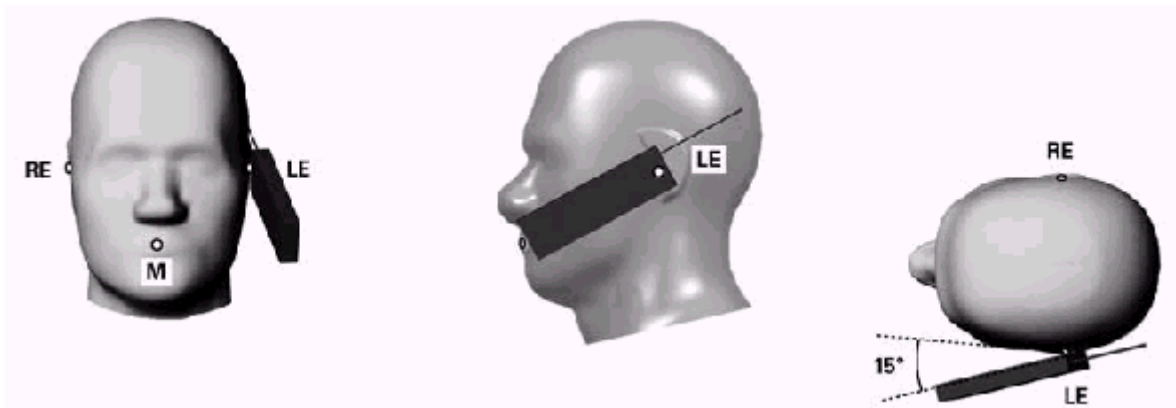

Figure 6.3.1 – Tilt position of the wireless device on the left side of SAM

6.4. Body Worn Accessory

1. Body-worn operating configurations are tested with the belt-clips and holsters attached to the device and positioned against a flat phantom in a normal use configuration (see Figure 6.4.1). Per KDB 648474 D04, body-worn accessory exposure is typically related to voice mode operations when handsets are carried in body-worn accessories. The body-worn accessory procedures in FCC KDB 447498 D01 should be used to test for body-worn accessory SAR compliance, without a headset connected to it. This enables the test results for such configuration to be compatible with that required for hotspot mode when the body-worn accessory test separation distance is greater than or equal to that required for hotspot mode, when applicable. When the reported SAR for body-worn accessory, measured without a headset connected to the handset is $< 1.2 \text{ W/kg}$, the highest reported SAR configuration for that wireless mode and frequency band should be repeated for that body-worn accessory with a handset attached to the handset.
2. Accessories for body-worn operation configurations are divided into two categories: those that do not contain metallic components and those that do contain metallic components and those that do contain metallic components. When multiple accessories that do not contain metallic components are supplied with the device, the device is tested with only the accessory that dictates the closest

spacing to the body. Then multiple accessories that contain metallic components are tested with the device with each accessory. If multiple accessories share an identical metallic component (i.e. the same metallic belt-clip used with different holsters with no other metallic components) only the accessory that dictates the closest spacing to the body is tested.

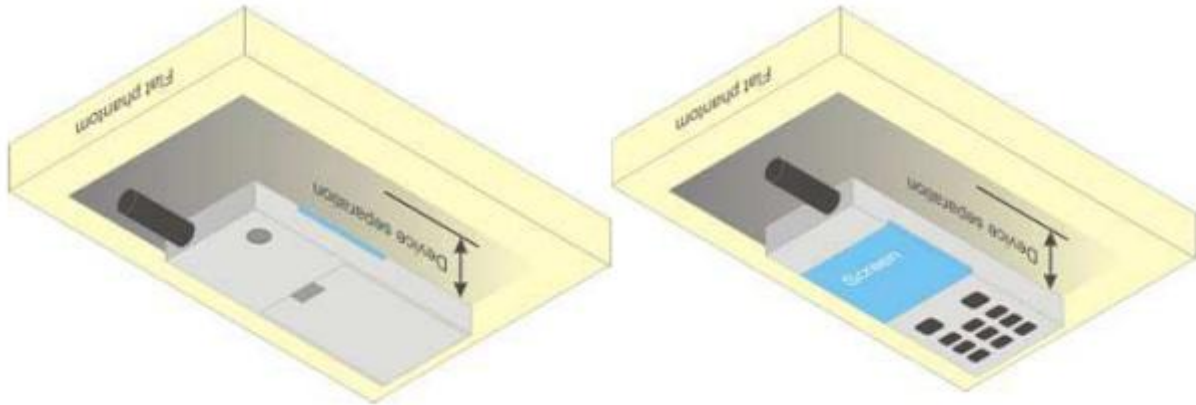

Figure 6.4.1 – Test positions for body-worn devices

6.5. Wireless Router Devices

Some battery-operated handsets have the capability to transmit and receive user through simultaneous transmission of WLAN simultaneously with a separate licensed transmitter. The FCC has provided guidance in FCC KDB Publication 941225 D06 where SAR test considerations for handsets ($L \times W \geq 9 \text{ cm} \times 5 \text{ cm}$) are based on a composite test separation distance of 10mm from the front, back and edges of the device containing transmitting antennas within 2.5cm of their edges, determined from general mixed use conditions for this type of devices. Since the hotspot SAR results may overlap with the body-worn accessory SAR requirements, the more conservative configurations can be considered, thus excluding some body-worn accessory SAR tests.

When the user enables the personal wireless router functions for the handset, actual operations include simultaneous transmission of both the WLAN transmitter and another licensed transmitter. Both transmitters often do not transmit at the same transmitting frequency and thus cannot be evaluated for SAR under actual use conditions due to the limitations of the SAR assessment probes. Therefore, SAR must be evaluated for each frequency transmission and mode separately and spatially summed with the WLAN transmitter according to FCC KDB Publication 447498 D01 publication procedures. The “Portable Hotspot” feature on the handset was NOT activated during SAR assessments, to ensure the SAR measurements were evaluated for a single transmission frequency RF signal at a time.

7. RF Output Power

7.1. GSM Conducted Power

Band GSM850	Burst-Averaged output Power (dBm)				Frame-Averaged output Power (dBm)			
Tx Channel	Tune-up	128	189	251	Tune-up	128	189	251
Frequency (MHz)	(dBm)	824.2	836.4	848.8	(dBm)	824.2	836.4	848.8
GSM (GMSK)	32.50	32.17	32.23	32.24	23.47	23.14	23.20	23.21
GPRS(GMSK,1 Tx slot)	32.50	31.98	32.07	32.04	23.47	22.95	23.04	23.01
GPRS(GMSK,2 Tx slot)	31.50	31.14	31.17	31.15	25.48	25.12	25.15	25.13
GPRS(GMSK,3 Tx slot)	29.50	29.24	29.29	29.38	25.24	24.98	25.03	25.12
GPRS(GMSK,4 Tx slot)	28.50	27.95	28.01	28.01	25.49	24.94	25.00	25.00
EGPRS(8PSK,1 Tx slot)	27.00	26.96	26.16	26.59	17.97	17.93	17.13	17.56
EGPRS(8PSK,2 Tx slot)	26.00	25.63	25.45	25.41	19.98	19.61	19.43	19.39
EGPRS(8PSK,3 Tx slot)	23.50	23.30	23.15	23.14	19.24	19.04	18.89	18.88
EGPRS(8PSK,4 Tx slot)	22.00	21.98	21.93	21.72	18.99	18.97	18.92	18.71
Band GSM1900	Burst-Averaged output Power (dBm)				Frame-Averaged output Power (dBm)			
Tx Channel	Tune-up	512	661	810	Tune-up	512	661	810
Frequency (MHz)	(dBm)	1850.2	1880	1909.8	(dBm)	1850.2	1880	1909.8
GSM (GMSK)	29.00	28.25	28.39	28.54	19.97	19.22	19.36	19.51
GPRS(GMSK,1 Tx slot)	29.00	28.29	28.47	28.54	19.97	19.26	19.44	19.51
GPRS(GMSK,2 Tx slot)	28.00	27.37	27.49	27.56	21.98	21.35	21.47	21.54
GPRS(GMSK,3 Tx slot)	26.00	25.59	25.53	25.64	21.74	21.33	21.27	21.38
GPRS(GMSK,4 Tx slot)	24.50	24.26	24.32	24.44	21.49	21.25	21.31	21.43
EGPRS(8PSK,1 Tx slot)	26.00	25.32	25.31	25.55	16.97	16.29	16.28	16.52
EGPRS(8PSK,2 Tx slot)	25.00	24.22	24.65	24.63	18.98	18.20	18.63	18.61
EGPRS(8PSK,3 Tx slot)	22.50	22.13	22.03	22.33	18.24	17.87	17.77	18.07
EGPRS(8PSK,4 Tx slot)	21.00	20.67	20.68	20.76	17.99	17.66	17.67	17.75

7.2. WCDMA Conducted Power

WCDMA Band 2	Burst-Averaged output Power (dBm)			
Tx Channel	Tune-up	9262	9400	9538
Frequency (MHz)	(dBm)	1852.4	1880	1907.6
RMC12.2K	23.00	22.58	22.55	22.51
HSDPA Sub 1	22.00	21.62	21.60	21.56
HSDPA Sub 2	21.50	21.10	21.14	21.17

HSDPA Sub 3	20.50	19.96	20.24	20.14
HSDPA Sub 4	20.50	19.70	20.18	19.76
HSUPA Sub 1	21.50	20.35	21.43	21.44
HSUPA Sub 2	22.00	21.52	21.46	21.44
HSUPA Sub 3	20.50	19.90	20.44	20.33
HSUPA Sub 4	22.00	21.58	21.60	21.57
HSUPA Sub 5	21.00	20.06	20.92	20.79
WCDMA Band 4	Burst-Averaged output Power (dBm)			
Tx Channel	Tune-up (dBm)	1312	1413	1513
Frequency (MHz)		1712.4	1732.6	1752.6
RMC12.2K	23.00	22.69	22.49	22.54
HSDPA Sub 1	22.00	21.75	21.57	21.57
HSDPA Sub 2	21.50	21.30	21.11	21.13
HSDPA Sub 3	20.50	20.39	20.02	19.64
HSDPA Sub 4	20.50	20.46	20.20	19.72
HSUPA Sub 1	21.50	20.66	21.35	21.34
HSUPA Sub 2	22.00	21.65	21.44	21.48
HSUPA Sub 3	20.50	19.93	20.17	20.11
HSUPA Sub 4	22.00	21.76	21.57	21.57
HSUPA Sub 5	21.00	20.23	20.89	20.84
WCDMA Band 5	Burst-Averaged output Power (dBm)			
Tx Channel	Tune-up (dBm)	4132	4182	4233
Frequency (MHz)		826.4	836.4	846.6
RMC12.2K	23.00	22.90	22.63	22.73
HSDPA Sub 1	22.00	21.93	21.67	21.77
HSDPA Sub 2	21.50	21.26	21.15	21.35
HSDPA Sub 3	21.00	20.60	20.28	20.05
HSDPA Sub 4	20.50	20.25	20.25	20.30
HSUPA Sub 1	22.00	20.74	21.44	21.51
HSUPA Sub 2	22.00	21.78	21.56	21.66
HSUPA Sub 3	21.00	20.22	20.34	20.51
HSUPA Sub 4	22.00	21.90	21.69	21.76
HSUPA Sub 5	21.00	20.44	20.95	20.93

7.3. LTE Conducted Power

Band	Band Width	Modulation	RB Configuration	Tune-up (dBm)	Channel/Frequency(MHz)
------	------------	------------	------------------	---------------	------------------------

2			1	24	23.50	22.77	22.88	23.12			
			12	0	22.50	21.81	21.86	22.12			
			12	6	22.50	21.85	21.94	22.22			
			12	11	22.50	21.82	21.93	22.18			
			25	0	22.50	21.81	21.93	22.17			
		16QAM	1	0	23.00	22.07	22.08	22.36			
			1	12	23.00	22.22	22.34	22.58			
			1	24	23.00	22.07	22.06	22.39			
			12	0	21.50	20.81	20.88	21.11			
			12	6	21.50	20.86	20.95	21.23			
			12	11	21.50	20.82	20.93	21.19			
			25	0	21.50	20.86	20.96	21.20			
			Band	Band Width	Modulation	RB Configuration		Tune-up (dBm)	Channel/Frequency(MHz)		
						RB Size	RB Offset		18650/1855	18900/1880	19150/1905
LTE Band 2	10MHz	QPSK	1	0	23.50	22.87	22.89	23.05			
			1	24	23.50	22.87	22.99	23.17			
			1	49	23.50	22.79	22.97	23.21			
			25	0	22.50	21.77	21.86	22.03			
			25	12	22.50	21.85	21.99	22.16			
			25	24	22.50	21.80	21.95	22.18			
			50	0	22.50	21.82	21.94	22.12			
		16QAM	1	0	23.00	22.13	22.14	22.42			
			1	24	23.00	22.21	22.26	22.38			
			1	49	23.00	22.01	22.19	22.50			
			25	0	21.50	20.81	20.90	21.06			
			25	12	21.50	20.88	21.01	21.18			
			25	24	21.50	20.84	20.99	21.21			
			50	0	21.50	20.82	20.94	21.14			
Band	Band Width	Modulation	RB Configuration		Tune-up (dBm)	Channel/Frequency(MHz)					
			RB Size	RB Offset		18675/1857.5	18900/1880	19125/1902.5			
LTE Band 2	15MHz	QPSK	1	0	23.50	22.81	22.79	22.93			
			1	37	23.50	22.88	22.99	23.16			
			1	74	23.50	22.66	22.86	23.15			
			36	0	22.50	21.75	21.85	21.99			
			36	18	22.50	21.78	21.96	22.10			
			36	37	22.50	21.75	21.93	22.16			

Band	Band Width	Modulation	RB Configuration		Tune-up (dBm)	Channel/Frequency(MHz)		
			RB Size	RB Offset		18700/1860	18900/1880	19100/1900
		16QAM	75	0	22.50	21.79	21.94	22.10
			1	0	22.50	22.13	22.12	22.21
			1	37	22.50	22.20	22.26	22.43
			1	74	22.50	21.94	22.21	22.47
			36	0	21.50	20.78	20.87	21.03
			36	18	21.50	20.79	20.98	21.10
			36	37	21.50	20.76	20.96	21.15
			75	0	21.50	20.81	20.95	21.10
LTE Band 2	20MHz	QPSK	1	0	23.50	22.76	22.69	22.83
			1	49	23.50	22.82	23.02	23.10
			1	99	23.50	22.62	22.77	23.08
			50	0	22.50	21.71	21.84	21.98
			50	24	22.50	21.79	22.02	22.10
			50	49	22.50	21.74	21.97	22.15
		16QAM	100	0	22.50	21.74	21.89	22.06
			1	0	22.50	22.06	21.97	22.01
			1	49	22.50	22.05	22.36	22.44
			1	99	22.50	21.96	22.10	22.40
			50	0	21.50	20.72	20.85	21.00
			50	24	21.50	20.80	21.02	21.10
			50	49	21.50	20.77	20.98	21.15
			100	0	21.50	20.70	20.87	21.05

Band	Band Width	Modulation	RB Configuration		Tune-up (dBm)	Channel/Frequency(MHz)		
			RB Size	RB Offset		19957/1710.7	20175/1732.5	20393/1754.3
LTE Band 4	1.4MHz	QPSK	1	0	23.00	22.68	22.42	22.31
			1	2	23.00	22.76	22.50	22.35
			1	5	23.00	22.68	22.41	22.31
			3	0	23.00	22.79	22.53	22.39
			3	1	23.00	22.82	22.55	22.40
			3	2	23.00	22.81	22.53	22.40
			6	0	22.00	21.88	21.65	21.51
		16QAM	1	0	22.00	21.91	21.71	21.50
			1	2	22.00	21.99	21.72	21.70

Band	Band Width	Modulation	RB Configuration		Tune-up (dBm)	Channel/Frequency(MHz)		
			RB Size	RB Offset		19965/1711.5	20175/1732.5	20385/1753.5
			1	5	22.00	21.90	21.62	21.46
			3	0	22.00	21.79	21.56	21.32
			3	1	22.00	21.82	21.55	21.47
			3	2	22.00	21.78	21.58	21.40
			6	0	21.50	21.04	20.75	20.64
LTE Band 4	3MHz	QPSK	1	0	23.00	22.59	22.36	22.19
			1	7	23.00	22.70	22.44	22.30
			1	14	23.00	22.57	22.30	22.18
			8	0	22.00	21.79	21.55	21.42
			8	4	22.00	21.85	21.61	21.46
			8	7	22.00	21.81	21.57	21.42
			15	0	22.00	21.79	21.56	21.40
		16QAM	1	0	22.50	21.87	21.62	21.39
			1	7	22.50	22.03	21.75	21.67
			1	14	22.50	21.90	21.65	21.54
			8	0	21.00	20.85	20.61	20.49
			8	4	21.00	20.92	20.65	20.56
			8	7	21.00	20.86	20.62	20.48
			15	0	21.00	20.82	20.55	20.43
Band	Band Width	Modulation	RB Configuration		Tune-up (dBm)	Channel/Frequency(MHz)		
			RB Size	RB Offset		19975/1712.5	20175/1732.5	20375/1752.5
LTE Band 4	5MHz	QPSK	1	0	23.00	22.82	22.53	22.31
			1	12	23.00	22.93	22.67	22.48
			1	24	23.00	22.76	22.54	22.36
			12	0	22.00	21.82	21.64	21.39
			12	6	22.00	21.91	21.68	21.44
			12	11	22.00	21.88	21.62	21.41
			25	0	22.00	21.86	21.63	21.40
		16QAM	1	0	22.50	22.12	21.88	21.55
			1	12	22.50	22.13	22.00	21.71
			1	24	22.50	21.97	21.90	21.62
			12	0	21.00	20.86	20.63	20.39
			12	6	21.00	20.92	20.68	20.44
			12	11	21.00	20.89	20.62	20.41

Band	Band Width	Modulation	RB Configuration		Tune-up (dBm)	Channel/Frequency(MHz)		
			RB Size	RB Offset		20000/1715	20175/1732.5	20350/1750
LTE Band 4	10MHz	QPSK	25	0	21.00	20.87	20.67	20.42
			1	0	23.00	22.89	22.62	22.44
			1	24	23.00	22.89	22.71	22.49
			1	49	23.00	22.71	22.65	22.43
			25	0	22.00	21.72	21.61	21.43
			25	12	22.00	21.83	21.68	21.48
			25	24	22.00	21.82	21.60	21.41
		16QAM	50	0	22.00	21.78	21.63	21.45
			1	0	22.50	22.20	21.88	21.74
			1	24	22.50	22.24	21.92	21.78
			1	49	22.50	21.94	21.86	21.71
			25	0	21.00	20.76	20.65	20.46
			25	12	21.00	20.89	20.71	20.49
			25	24	21.00	20.82	20.61	20.42
50	0	21.00	20.80	20.64	20.42			
Band	Band Width	Modulation	RB Configuration		Tune-up (dBm)	Channel/Frequency(MHz)		
			RB Size	RB Offset		20025/1717.5	20175/1732.5	20325/1747.5
LTE Band 4	15MHz	QPSK	1	0	23.00	22.85	22.60	22.42
			1	37	23.00	22.80	22.72	22.52
			1	74	23.00	22.58	22.63	22.41
			36	0	22.00	21.72	21.61	21.46
			36	18	22.00	21.76	21.67	21.48
			36	37	22.00	21.68	21.61	21.42
			75	0	22.00	21.74	21.63	21.47
		16QAM	1	0	22.50	22.20	21.90	21.71
			1	37	22.50	22.06	21.91	21.79
			1	74	22.50	21.90	21.87	21.74
			36	0	21.00	20.75	20.62	20.45
			36	18	21.00	20.78	20.67	20.48
			36	37	21.00	20.70	20.62	20.43
			75	0	21.00	20.73	20.65	20.47
Band	Band Width	Modulation	RB Configuration		Tune-up (dBm)	Channel/Frequency(MHz)		

			RB	RB		20050/1720	20175/1732.5	20300/1745
			Size	Offset				
LTE Band 4	20MHz	QPSK	1	0	23.00	22.73	22.52	22.35
			1	49	23.00	22.72	22.69	22.53
			1	99	23.00	22.46	22.54	22.31
			50	0	22.00	21.59	21.66	21.57
			50	24	22.00	21.72	21.72	21.55
			50	49	22.00	21.61	21.58	21.43
			100	0	22.00	21.60	21.60	21.49
		16QAM	1	0	22.00	21.92	21.82	21.63
			1	49	22.00	21.94	21.90	21.85
			1	99	22.00	21.77	21.85	21.61
			50	0	21.00	20.59	20.65	20.54
			50	24	21.00	20.71	20.71	20.53
			50	49	21.00	20.63	20.57	20.41
			100	0	21.00	20.61	20.60	20.47

Band	Band Width	Modulation	RB Configuration		Tune-up (dBm)	Channel/Frequency(MHz)		
			RB Size	RB Offset		20407/824.7	20525/836.5	20643/848.3
LTE Band 5	1.4MHz	QPSK	1	0	23.50	22.65	23.05	22.90
			1	2	23.50	22.75	23.12	22.93
			1	5	23.50	22.68	23.00	22.86
			3	0	23.50	22.78	23.11	22.99
			3	1	23.50	22.80	23.13	23.00
			3	2	23.50	22.80	23.13	22.98
			6	0	22.50	21.88	22.21	22.07
		16QAM	1	0	22.50	21.87	22.29	22.21
			1	2	22.50	22.10	22.38	22.20
			1	5	22.50	21.98	22.37	22.22
			3	0	22.50	21.70	22.20	21.97
			3	1	22.50	21.79	22.20	22.06
			3	2	22.50	21.75	22.14	21.98
			6	0	21.50	20.96	21.31	21.20
Band	Band Width	Modulation	RB Configuration		Tune-up (dBm)	Channel/Frequency(MHz)		
			RB Size	RB Offset		20415/825.5	20525/836.5	20635/847.5
LTE	3MHz	QPSK	1	0	23.00	22.60	22.89	22.80

Band 5			1	7	23.00	22.73	23.00	22.90
			1	14	23.00	22.64	22.92	22.75
			8	0	22.50	21.81	22.10	21.97
			8	4	22.50	21.86	22.20	22.06
			8	7	22.50	21.84	22.16	22.01
			15	0	22.50	21.81	22.14	22.00
		16QAM	1	0	22.50	21.78	22.16	22.05
			1	7	22.50	22.02	22.33	22.23
			1	14	22.50	21.89	22.24	21.96
			8	0	21.50	20.87	21.11	21.06
			8	4	21.50	20.93	21.24	21.13
			8	7	21.50	20.88	21.22	21.08
			15	0	21.50	20.82	21.14	21.01
Band	Band Width	Modulation	RB Configuration		Tune-up (dBm)	Channel/Frequency(MHz)		
			RB Size	RB Offset		20425/826.5	20525/836.5	20625/846.5
LTE Band 5	5MHz	QPSK	1	0	23.50	22.79	23.18	23.04
			1	12	23.50	23.00	23.30	23.12
			1	24	23.50	22.94	23.15	23.00
			12	0	22.50	21.95	22.13	22.13
			12	6	22.50	22.00	22.28	22.13
			12	11	22.50	21.91	22.25	22.13
			25	0	22.50	21.94	22.22	22.14
		16QAM	1	0	23.00	22.07	22.47	22.38
			1	12	23.00	22.19	22.50	22.33
			1	24	23.00	22.16	22.35	22.30
			12	0	21.50	20.95	21.15	21.15
			12	6	21.50	20.98	21.30	21.14
			12	11	21.50	20.90	21.27	21.16
Band <th rowspan="2">Band Width</th> <th rowspan="2">Modulation</th> <th colspan="2">RB Configuration</th> <th rowspan="2">Tune-up (dBm)</th> <th colspan="3">Channel/Frequency(MHz)</th>	Band Width	Modulation	RB Configuration		Tune-up (dBm)	Channel/Frequency(MHz)		
			RB Size	RB Offset		20450/829	20525/836.5	20600/844
LTE Band 5	10MHz	QPSK	1	0	23.50	22.88	23.21	23.25
			1	24	23.50	23.08	23.29	23.19
			1	49	23.50	23.21	23.20	23.10
			25	0	22.50	22.05	22.10	22.26
			25	12	22.50	22.09	22.29	22.16

			25	24	22.50	22.11	22.22	22.07
			50	0	22.50	22.11	22.19	22.20
		16QAM	1	0	23.00	22.21	22.54	22.54
			1	24	23.00	22.42	22.62	22.37
			1	49	23.00	22.38	22.46	22.30
			25	0	21.50	21.08	21.12	21.28
			25	12	21.50	21.10	21.32	21.21
			25	24	21.50	21.13	21.27	21.09
			50	0	21.50	21.09	21.18	21.21

Band	Band Width	Modulation	RB Configuration		Tune-up (dBm)	Channel/Frequency(MHz)		
			RB Size	RB Offset		20775/2502.5	21100/2535	21425/2567.5
LTE Band 7	5MHz	QPSK	1	0	24.00	23.30	23.13	23.37
			1	12	24.00	23.42	23.30	23.60
			1	24	24.00	23.25	23.19	23.57
			12	0	23.00	22.37	22.22	22.46
			12	6	23.00	22.41	22.27	22.65
			12	11	23.00	22.31	22.24	22.65
			25	0	23.00	22.35	22.24	22.57
		16QAM	1	0	23.00	22.64	22.49	22.66
			1	12	23.00	22.65	22.66	22.87
			1	24	23.00	22.59	22.45	22.81
			12	0	22.00	21.38	21.23	21.45
			12	6	22.00	21.42	21.31	21.61
			12	11	22.00	21.32	21.23	21.64
			25	0	22.00	21.40	21.27	21.60

Band	Band Width	Modulation	RB Configuration		Tune-up (dBm)	Channel/Frequency(MHz)		
			RB Size	RB Offset		20800/2505	21100/2535	21400/2565
LTE Band 7	10MHz	QPSK	1	0	24.00	23.38	23.23	23.27
			1	24	24.00	23.40	23.30	23.47
			1	49	24.00	23.44	23.32	23.65
			25	0	23.00	22.41	22.21	22.29
			25	12	23.00	22.38	22.29	22.54
			25	24	23.00	22.32	22.25	22.64
			50	0	23.00	22.41	22.26	22.52
		16QAM	1	0	23.00	22.68	22.57	22.56

Band	Band Width	Modulation	RB Configuration		Tune-up (dBm)	Channel/Frequency(MHz)		
			RB Size	RB Offset		20825/2507.5	21100/2535	21375/2562.5
			1	24	23.00	22.67	22.51	22.70
			1	49	23.00	22.57	22.61	22.85
			25	0	22.00	21.41	21.22	21.32
			25	12	22.00	21.42	21.31	21.54
			25	24	22.00	21.34	21.30	21.66
			50	0	22.00	21.39	21.27	21.51
LTE Band 7	15MHz	QPSK	1	0	24.00	23.35	23.22	23.21
			1	37	24.00	23.46	23.32	23.41
			1	74	24.00	23.46	23.35	23.57
			36	0	23.00	22.36	22.18	22.22
			36	18	23.00	22.37	22.25	22.36
			36	37	23.00	22.40	22.26	22.55
			75	0	22.50	22.38	22.26	22.39
		16QAM	1	0	23.00	22.71	22.50	22.45
			1	37	23.00	22.65	22.57	22.69
			1	74	23.00	22.65	22.56	22.79
			36	0	22.00	21.36	21.19	21.22
			36	18	22.00	21.38	21.25	21.38
			36	37	22.00	21.42	21.28	21.56
			75	0	21.50	21.36	21.25	21.39
			RB Configuration		Tune-up (dBm)	Channel/Frequency(MHz)		
			RB Size	RB Offset		20850/2510	21100/2535	21350/2560
LTE Band 7	20MHz	QPSK	1	0	23.50	23.23	23.21	23.22
			1	49	23.50	23.48	23.31	23.31
			1	99	23.50	23.37	23.31	23.48
			50	0	23.00	22.40	22.19	22.29
			50	24	23.00	22.46	22.32	22.38
			50	49	23.00	22.47	22.25	22.57
			100	0	22.50	22.42	22.19	22.43
		16QAM	1	0	23.00	22.57	22.53	22.48
			1	49	23.00	22.77	22.56	22.62
			1	99	23.00	22.68	22.53	22.76
			50	0	22.00	21.38	21.19	21.28
50	24	22.00	21.45	21.32	21.36			

			50	49	22.00	21.46	21.23	21.55
			100	0	21.50	21.40	21.17	21.42

Band	Band Width	Modulation	RB Configuration		Tune-up (dBm)	Channel/Frequency(MHz)		
			RB Size	RB Offset		23017/699.7	23095/707.5	23173/715.3
LTE Band 12	1.4MHz	QPSK	1	0	23.00	22.87	22.76	22.79
			1	2	23.00	22.93	22.79	22.86
			1	5	23.00	22.85	22.72	22.76
			3	0	23.00	22.98	22.83	22.88
			3	1	23.00	22.98	22.86	22.88
			3	2	23.00	23.00	22.81	22.89
		16QAM	6	0	22.50	22.06	21.92	21.97
			1	0	22.50	22.22	21.96	22.02
			1	2	22.50	22.26	22.14	22.02
			1	5	22.50	22.23	21.95	22.11
			3	0	22.00	21.97	21.81	21.87
			3	1	22.00	21.95	21.88	21.92
			3	2	22.00	21.94	21.83	21.91
			6	0	21.50	21.15	21.01	21.03

Band	Band Width	Modulation	RB Configuration		Tune-up (dBm)	Channel/Frequency(MHz)		
			RB Size	RB Offset		23025/700.5	23095/707.5	23165/714.5
LTE Band 12	3MHz	QPSK	1	0	23.00	22.76	22.65	22.64
			1	7	23.00	22.85	22.71	22.74
			1	14	23.00	22.71	22.58	22.67
			8	0	22.50	21.91	21.83	21.89
			8	4	22.50	22.02	21.90	21.92
			8	7	22.50	21.96	21.83	21.87
			15	0	22.00	21.96	21.82	21.87
		16QAM	1	0	22.50	22.09	21.88	21.90
			1	7	22.50	22.05	21.90	21.94
			1	14	22.50	22.03	21.90	21.94
			8	0	21.50	21.02	20.88	20.94
			8	4	21.50	21.09	20.94	20.97
			8	7	21.50	21.02	20.87	20.89
			15	0	21.00	20.95	20.83	20.88

Band	Band	Modulation	RB		Tune-up	Channel/Frequency(MHz)		
------	------	------------	----	--	---------	------------------------	--	--

	Width		Configuration		(dBm)			
			RB Size	RB Offset		23035/701.5	23095/707.5	23155/713.5
LTE Band 12	5MHz	QPSK	1	0	23.50	23.02	22.89	22.82
			1	12	23.50	23.10	22.99	23.00
			1	24	23.50	22.95	22.82	22.90
			12	0	22.50	21.97	21.86	21.93
			12	6	22.50	22.05	21.95	22.01
			12	11	22.50	21.92	21.93	21.83
		16QAM	25	0	22.00	21.92	21.93	21.90
			1	0	22.50	22.33	22.25	22.16
			1	12	22.50	22.43	22.27	22.28
			1	24	22.50	22.11	22.12	22.11
			12	0	21.50	20.94	20.87	20.92
			12	6	21.50	21.05	20.96	20.97
			12	11	21.50	20.90	20.91	20.81
25	0	21.00	20.94	20.95	20.90			

Band	Band Width	Modulation	RB Configuration		Tune-up (dBm)	Channel/Frequency(MHz)		
			RB Size	RB Offset		23060/704	23095/707.5	23130/711
LTE Band 12	10MHz	QPSK	1	0	23.50	23.10	23.06	22.98
			1	24	23.50	23.05	22.99	22.93
			1	49	23.50	22.89	22.93	22.96
			25	0	22.50	22.00	21.96	21.74
			25	12	22.50	22.00	21.97	21.93
			25	24	22.50	21.94	22.01	21.73
			50	0	22.50	22.00	22.03	21.76
		16QAM	1	0	22.50	22.33	22.34	22.21
			1	24	22.50	22.39	22.19	22.16
			1	49	22.50	22.18	22.19	22.28
			25	0	21.50	21.02	20.96	20.77
			25	12	21.50	21.02	21.03	20.95
			25	24	21.50	20.96	21.02	20.77
50	0	21.50	20.98	21.02	20.75			

Band	Band Width	Modulation	RB Configuration		Tune-up (dBm)	Channel/Frequency(MHz)		
			RB Size	RB Offset		23205/779.5	23230/782	23255/784.5

LTE Band 13	5MHz	QPSK	1	0	23.50	23.05	23.05	22.97
			1	12	23.50	23.20	23.10	23.08
			1	24	23.50	22.97	22.93	22.85
			12	0	22.50	22.09	22.05	22.03
			12	6	22.50	22.17	22.08	22.02
			12	11	22.50	22.07	22.00	21.99
			25	0	22.50	22.06	22.03	21.99
		16QAM	1	0	23.00	22.40	22.30	22.15
			1	12	23.00	22.53	22.31	22.24
			1	24	23.00	22.35	22.12	22.15
			12	0	21.50	21.10	21.07	21.01
			12	6	21.50	21.17	21.07	21.03
			12	11	21.50	21.06	20.99	20.99
			25	0	21.50	21.08	21.06	21.03
Band	Band Width	Modulation	RB Configuration		Tune-up (dBm)	Channel/Frequency(MHz)		
			RB Size	RB Offset		/	23230/782	/
LTE Band 13	10MHz	QPSK	1	0	23.50	/	23.18	/
			1	24	23.50	/	23.14	/
			1	49	23.50	/	23.00	/
			25	0	22.50	/	22.08	/
			25	12	22.50	/	22.10	/
			25	24	22.50	/	21.98	/
			50	0	22.50	/	22.04	/
		16QAM	1	0	22.50	/	22.48	/
			1	24	22.50	/	22.47	/
			1	49	22.50	/	22.27	/
			25	0	21.50	/	21.09	/
			25	12	21.50	/	21.10	/
			25	24	21.50	/	21.00	/
			50	0	21.50	/	21.04	/

Band	Band Width	Modulation	RB Configuration		Tune-up (dBm)	Channel/Frequency(MHz)		
			RB Size	RB Offset		23755/706.5	23790/710	23825/713.5
LTE Band 17	5MHz	QPSK	1	0	23.00	22.87	22.79	22.76
			1	12	23.00	22.90	22.87	22.87
			1	24	23.00	22.75	22.74	22.82

Band	Band Width	Modulation	RB Configuration		Tune-up (dBm)	Channel/Frequency(MHz)				
			RB Size	RB Offset		23780/709	23790/710	23800/711		
LTE Band 17	10MHz	16QAM	12	0	22.00	21.90	21.77	21.85		
			12	6	22.00	21.89	21.84	21.84		
			12	11	22.00	21.87	21.81	21.74		
			25	0	22.00	21.88	21.79	21.77		
			1	0	22.50	22.07	22.01	22.10		
			1	12	22.50	22.18	22.19	22.17		
			1	24	22.50	22.04	21.92	22.02		
			12	0	21.00	20.86	20.77	20.85		
		12	6	21.00	20.87	20.86	20.84			
		12	11	21.00	20.85	20.78	20.71			
		25	0	21.00	20.89	20.82	20.79			
		QPSK			1	0	23.00	22.98	22.94	22.87
					1	24	23.00	22.90	22.87	22.88
					1	49	23.00	22.82	22.85	22.88
25	0				22.00	21.75	21.68	21.68		
25	12				22.00	21.89	21.85	21.83		
25	24				22.00	21.80	21.69	21.62		
50	0				22.00	21.79	21.73	21.67		
1	0				22.50	22.30	22.19	22.20		
1	24				22.50	22.14	22.13	22.17		
1	49				22.50	22.15	22.13	22.14		
16QAM			25	0	21.00	20.76	20.72	20.71		
			25	12	21.00	20.89	20.88	20.87		
			25	24	21.00	20.82	20.71	20.64		
			50	0	21.00	20.83	20.71	20.64		

Band	Band Width	Modulation	RB Configuration		Tune-up (dBm)	Channel/Frequency(MHz)		
			RB Size	RB Offset		26047/1850.7	26365/1882.5	26683/1914.3
LTE Band 25	1.4MHz	QPSK	1	0	23.00	22.15	22.51	22.88
			1	2	23.00	22.91	22.52	22.87
			1	5	23.00	22.15	22.45	22.83
			3	0	23.00	22.37	22.46	22.60
			3	1	23.00	22.40	22.48	22.66
			3	2	23.00	22.28	22.41	22.60

Band	Band Width	Modulation	RB Configuration		Tune-up (dBm)	Channel/Frequency(MHz)		
			RB Size	RB Offset		26055/1851.5	26365/1882.5	26675/1913.5
		16QAM	6	0	21.50	21.31	21.36	21.49
			1	0	22.50	21.98	21.45	21.70
			1	2	22.50	21.89	21.47	21.72
			1	5	22.50	22.02	21.38	21.70
			3	0	22.00	21.57	21.57	21.82
			3	1	22.00	21.70	21.59	21.80
			3	2	22.00	21.70	21.54	21.86
			6	0	21.00	20.20	20.24	20.61
LTE Band 25	3MHz	QPSK	1	0	23.50	22.65	22.57	22.81
			1	7	23.50	22.76	22.60	22.92
			1	14	23.50	22.65	22.51	23.12
			8	0	22.00	21.36	21.41	21.62
			8	4	22.00	21.90	21.33	21.67
			8	7	22.00	21.83	21.32	21.53
			15	0	22.00	21.88	21.44	21.51
		16QAM	1	0	22.00	21.33	21.37	21.59
			1	7	22.00	21.53	21.52	21.69
			1	14	22.00	21.37	21.48	21.66
			8	0	21.00	20.57	20.51	20.78
			8	4	21.00	20.65	20.53	20.81
			8	7	21.00	20.48	20.51	20.81
			15	0	21.00	20.54	20.52	20.76
	Band Width	Modulation	RB Configuration		Tune-up (dBm)	Channel/Frequency(MHz)		
			RB Size	RB Offset		26065/1852.5	26365/1882.5	26665/1912.5
LTE Band 25	5MHz	QPSK	1	0	23.00	22.67	22.71	22.87
			1	12	23.00	22.54	22.67	22.87
			1	24	23.00	22.55	22.71	22.84
			12	0	22.00	21.39	21.48	21.50
			12	6	22.00	21.30	21.37	21.55
			12	11	22.00	21.30	21.38	21.62
			25	0	22.00	21.20	21.32	21.50
		16QAM	1	0	22.00	21.40	21.47	21.60
			1	12	22.00	21.36	21.41	21.66
			1	24	22.00	21.30	21.65	21.70

Band	Band Width	Modulation	RB Configuration		Tune-up (dBm)	Channel/Frequency(MHz)		
			RB Size	RB Offset		26090/1855	26365/1882.5	26640/1910
			12	0	21.00	20.59	20.61	20.68
			12	6	21.00	20.43	20.66	20.73
			12	11	21.00	20.39	20.48	20.70
			25	0	21.00	20.64	20.71	20.91
LTE Band 25	10MHz	QPSK	1	0	23.00	22.43	22.43	22.54
			1	24	23.00	22.30	22.49	22.58
			1	49	23.00	22.24	22.36	22.76
			25	0	22.00	21.36	21.44	21.57
			25	12	22.00	21.18	21.32	21.53
			25	24	22.00	21.18	21.34	21.50
			50	0	22.00	21.22	21.51	21.56
		16QAM	1	0	22.50	22.12	22.06	22.13
			1	24	22.50	21.91	22.08	22.22
			1	49	22.50	21.95	22.05	22.31
			25	0	21.00	20.42	20.57	20.65
			25	12	21.00	20.24	20.53	20.51
			25	24	21.00	20.24	20.43	20.67
			50	0	21.00	20.42	20.52	20.67
			RB Configuration		Tune-up (dBm)	Channel/Frequency(MHz)		
			RB Size	RB Offset		26115/1857.5	26365/1882.5	26615/1907.5
LTE Band 25	15MHz	QPSK	1	0	23.00	22.48	22.35	22.71
			1	37	23.00	22.32	22.40	22.75
			1	74	23.00	22.27	22.53	22.91
			36	0	22.00	21.16	21.38	21.51
			36	18	22.00	21.25	21.30	21.40
			36	37	22.00	21.19	21.39	21.66
			75	0	22.00	21.37	21.28	21.59
		16QAM	1	0	22.50	21.96	22.15	21.42
			1	37	22.50	21.94	21.91	21.51
			1	74	22.50	21.85	22.04	21.69
			36	0	21.00	20.34	20.45	20.58
			36	18	21.00	20.33	20.43	20.65
			36	37	21.00	20.28	20.45	20.79
			75	0	21.00	20.37	20.58	20.63

Band	Band Width	Modulation	RB Configuration		Tune-up (dBm)	Channel/Frequency(MHz)		
			RB Size	RB Offset		26140/1860	26365/1882.5	26590/1905
LTE Band 25	20MHz	QPSK	1	0	23.00	22.71	22.52	22.68
			1	49	23.00	22.52	22.70	22.75
			1	99	23.00	22.54	22.59	22.83
			50	0	21.50	21.28	21.32	21.47
			50	24	21.50	21.35	21.35	21.40
			50	49	21.50	21.13	21.46	21.47
			100	0	22.00	21.35	21.32	21.55
		16QAM	1	0	22.00	21.48	20.82	21.47
			1	49	22.00	21.23	20.89	21.40
			1	99	22.00	21.45	20.73	21.73
			50	0	21.00	20.38	20.54	20.56
			50	24	21.00	20.34	20.52	20.64
			50	49	21.00	20.36	20.53	20.66
			100	0	21.00	20.46	20.59	20.56

Band	Band Width	Modulation	RB Configuration		Tune-up (dBm)	Channel/Frequency(MHz)		
			RB Size	RB Offset		40065/2537.5	40640/2595	41215/2652.5
LTE Band 41	5MHz	QPSK	1	0	24.00	23.27	23.77	23.88
			1	12	24.00	23.54	23.96	23.96
			1	24	24.00	23.49	23.95	23.78
			12	0	23.00	22.32	22.82	22.89
			12	6	23.00	22.48	22.90	22.89
			12	11	23.00	22.48	22.91	22.80
			25	0	23.00	22.43	22.87	22.85
		16QAM	1	0	23.50	22.46	22.95	23.06
			1	12	23.50	22.73	23.16	23.15
			1	24	23.50	22.74	23.13	22.97
			12	0	22.00	21.36	21.84	21.92
			12	6	22.00	21.51	21.92	21.92
			12	11	22.00	21.53	21.94	21.83
			25	0	22.00	21.51	21.93	21.92
Band	Band Width	Modulation	RB Configuration		Tune-up (dBm)	Channel/Frequency(MHz)		
			RB	RB		40090/2540	40640/2595	41190/2650

Band	Band Width	Modulation	RB Configuration		Tune-up (dBm)	Channel/Frequency(MHz)		
			RB Size	RB Offset		40115/2542.5	40640/2595	41165/2647.5
LTE Band 41	10MHz	QPSK	1	0	24.50	23.40	23.88	24.08
			1	24	24.50	23.69	23.98	24.01
			1	49	24.50	23.78	24.11	23.87
			25	0	23.50	22.45	22.86	23.02
			25	12	23.50	22.64	22.93	22.96
			25	24	23.50	22.74	22.98	22.84
		16QAM	50	0	23.00	22.64	22.93	22.98
			1	0	23.50	22.59	23.06	23.27
			1	24	23.50	22.88	23.16	23.20
			1	49	23.50	22.98	23.32	23.05
			25	0	22.50	21.50	21.90	22.08
			25	12	22.50	21.69	21.98	22.01
			25	24	22.50	21.78	22.02	21.89
			50	0	22.50	21.66	21.98	22.02
LTE Band 41	15MHz	QPSK	1	0	24.50	23.36	23.81	24.05
			1	37	24.50	23.81	24.00	24.06
			1	74	24.50	23.63	24.18	23.82
			36	0	23.50	22.48	22.81	23.02
			36	18	23.50	22.70	22.92	22.99
			36	37	23.50	22.68	23.00	22.83
			75	0	23.00	22.61	22.93	22.97
		16QAM	1	0	23.50	22.54	22.99	23.26
			1	37	23.50	22.99	23.17	23.25
			1	74	23.50	22.83	23.37	23.00
			36	0	22.50	21.46	21.81	22.02
			36	18	22.50	21.70	21.93	22.00
			36	37	22.50	21.69	22.01	21.84
			75	0	22.00	21.65	21.94	21.99
LTE Band	20MHz	QPSK	1	0	24.50	23.29	23.81	24.04
			1	49	24.50	23.83	24.00	24.11

41		1	99	24.50	23.26	24.14	23.74
		50	0	23.50	22.52	22.87	23.07
		50	24	23.50	22.76	22.98	23.09
		50	49	23.50	22.61	23.05	22.88
		100	0	23.00	22.60	22.95	22.98
	16QAM	1	0	23.50	22.47	22.98	23.23
		1	49	23.50	23.04	23.19	23.32
		1	99	23.50	22.48	23.33	22.92
		50	0	22.50	21.55	21.90	22.11
		50	24	22.50	21.80	22.02	22.13
		50	49	22.50	21.66	22.09	21.94
		100	0	22.00	21.61	21.98	21.99

7.4. WLAN & Bluetooth Output Power

Mode	Channel	Frequency (MHz)	Tune-up (dBm)	Output Power (dBm)
802.11b	1	2412	16.00	15.77
	6	2437	16.00	15.40
	11	2462	16.00	15.54
802.11g	1	2412	13.50	12.52
	6	2437	13.50	13.03
	11	2462	13.50	12.80
802.11n HT20	1	2412	11.50	11.03
	6	2437	11.50	10.83
	11	2462	11.50	10.80
802.11n HT40	3	2422	10.00	9.95
	6	2437	10.00	9.86
	9	2452	10.00	9.68

NOTE: Power measurement results of WLAN 2.4G.

Mode	Channel	Frequency (MHz)	Tune-up (dBm)	Output Power (dBm)
802.11a	36	5180	10.500	10.254
	40	5200	10.500	9.851
	48	5240	10.500	9.882
802.11n HT20	36	5180	10.500	10.073
	40	5200	10.500	10.226
	48	5240	10.500	10.167

802.11n HT40	38	5190	10.500	9.957
	46	5230	10.500	10.129
802.11ac VHT20	36	5180	10.500	10.104
	40	5200	10.500	10.149
	48	5240	10.500	10.183
802.11ac VHT40	38	5190	10.000	9.868
	46	5230	10.000	9.791
802.11ac VHT80	42	5210	10.000	9.584

NOTE: Power measurement results of WLAN 5.2G.

Mode	Channel	Frequency (MHz)	Tune-up (dBm)	Output Power (dBm)
802.11a	149	5745	10.000	9.788
	157	5785	10.000	9.959
	165	5825	10.000	9.853
802.11n HT20	149	5745	10.000	9.788
	157	5785	10.000	9.838
	165	5825	10.000	9.265
802.11n HT40	151	5755	10.000	9.912
	159	5795	10.000	9.792
802.11ac VHT20	149	5745	10.500	10.289
	157	5785	10.500	10.454
	165	5825	10.500	9.889
802.11ac VHT40	151	5755	10.000	9.876
	159	5795	10.000	9.817
802.11ac VHT80	155	5775	11.000	10.658

NOTE: Power measurement results of WLAN 5.8G.

BR+EDR	Output Power (dBm)				
	Channel	Tune-up (dBm)	Data Rates		
			1M	2M	3M
	0CH	5.000	4.983	4.509	4.506
	39CH	5.500	5.340	4.710	4.552
	78CH	6.000	5.837	5.092	4.734

BLE	Channel	Tune-up (dBm)	Output Power (dBm)	
			1M	2M

	0CH	-5.000	-5.317	-5.259
	19CH	-5.000	-5.067	-5.271
	39CH	-5.000	-5.348	-5.344

NOTE: Power measurement results of Bluetooth.

8. Antenna Location

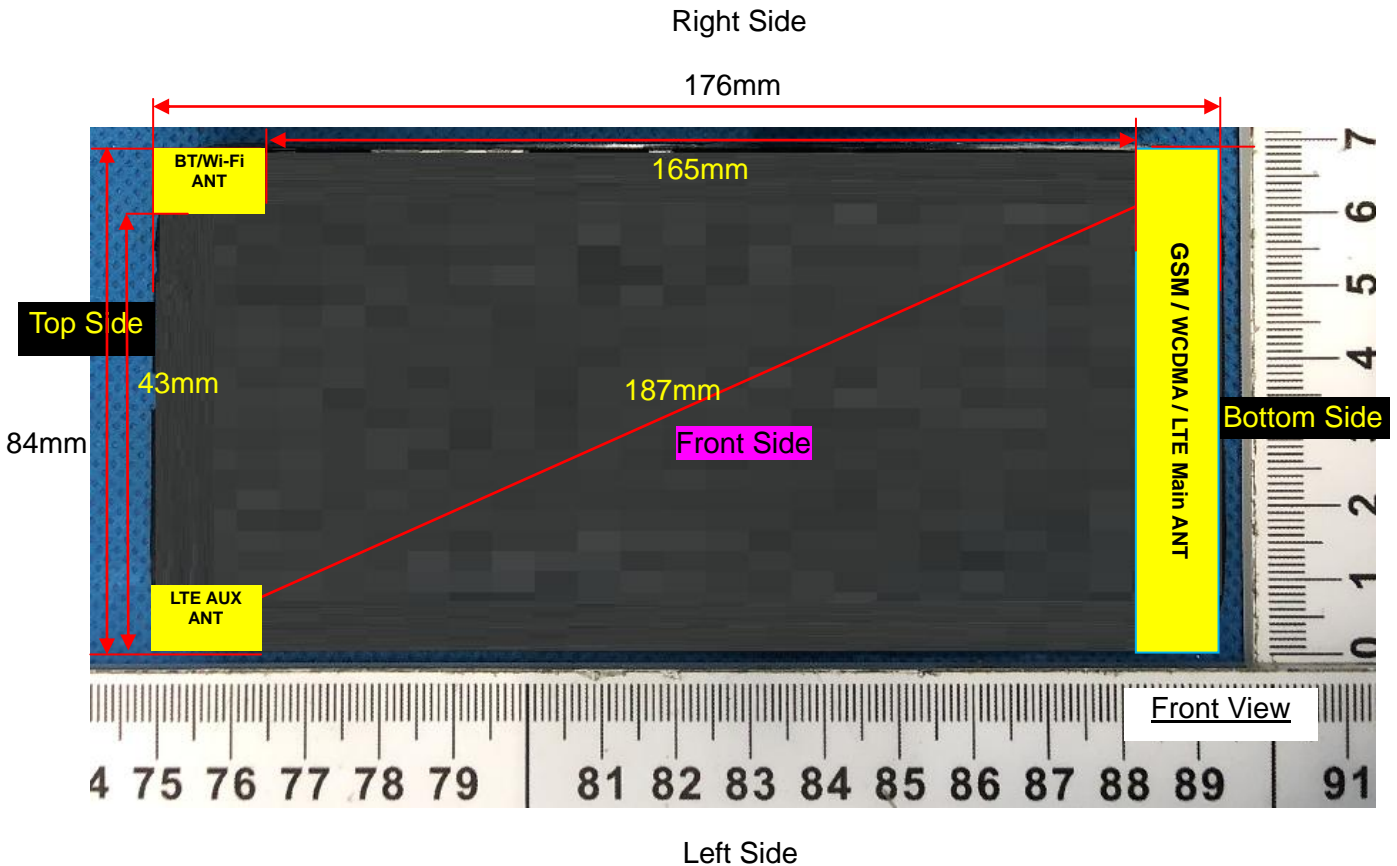

Note: Since the confidentiality request of EUT, the antenna location example diagram see as above.

Distance of the Antenna to the EUT surface/edge						
Antennas	Front Side	Back Side	Left Side	Right Side	Top Side	Bottom Side
WWAN Main ANT	≤ 25mm	≤ 25mm	≤ 25mm	≤ 25mm	> 25mm	≤ 25mm
WLAN & Bluetooth	≤ 25mm	≤ 25mm	> 25mm	≤ 25mm	≤ 25mm	>25mm
Positions for SAR tests						
Antennas	Front Side	Back Side	Left Side	Right Side	Top Side	Bottom Side
WWAN Main ANT	Yes	Yes	Yes	Yes	NO	Yes
WLAN & Bluetooth	Yes	Yes	NO	Yes	Yes	NO

9. Stand-alone SAR test exclusion

Refer to FCC KDB 447498D01, the 1-g SAR and 10-g SAR test exclusion thresholds for 100 MHz to 6 GHz at test separation distances ≤ 50 mm are determined by:

$$[(\text{max. power of channel, including tune-up tolerance, mW}) / (\text{min. test separation distance, mm})] \cdot [\sqrt{f_{\text{(GHZ)}}}] \leq 3.0 \text{ for 1-g SAR and } \leq 7.5 \text{ for 10-g extremity SAR, where:}$$

- $f_{\text{(GHZ)}}$ is the RF channel transmit frequency in GHz
- Power and distance are rounded to the nearest mW and mm before calculation
- The result is rounded to one decimal place for comparison

When the minimum test separation distance is < 5 mm, a distance of 5 mm is applied to determine SAR test exclusion.

Mode	P _{max} (dBm)	P _{max} (mW)	Distance (mm)	f (GHz)	Calculation Result	SAR Exclusion threshold	SAR test exclusion
Bluetooth	6.00	3.98	5	2.480	1.25	3.0	Yes

NOTE: Standalone SAR test exclusion for Bluetooth.

When standalone SAR test exclusion applies to an antenna that transmits simultaneously with other antennas, the standalone SAR must be estimated according to following to determine simultaneous transmission SAR test exclusion:

$[(\text{max. power of channel, including tune-up tolerance, mW}) / (\text{min. test separation distance, mm})] * [\sqrt{f_{\text{GHz}} / x}] \text{ W/kg}$ for test separation distances $\leq 50\text{mm}$, where $x = 7.5$ for 1-g SAR and $x = 18.75$ for 10-g SAR.

When the minimum test separation distance is < 5 mm, a distance of 5 mm is applied to determine SAR test exclusion.

Mode	Position	P _{max} (dBm)	P _{max} (mW)	Distance (mm)	f (GHz)	x	Estimated SAR (W/Kg)
Bluetooth	Head	6.00	3.98	5	2.48	7.5	0.167
Bluetooth	Body	6.00	3.98	10	2.48	7.5	0.084
Bluetooth	Hotspot	6.00	3.98	10	2.48	7.5	0.084

NOTE: Estimated SAR calculation for Bluetooth

10. SAR Results

10.1. SAR measurement Result

10.1.1. SAR measurement Result of GSM850

Test Position of Head	Test channel /Freq.	Mode	SAR Value (W/kg)		Power Drift(%)	Conducted Power (dBm)	Tune-up Power (dBm)	Scaled SAR 1-g (W/Kg)	Date	Plot
			1-g	10-g						
Left Cheek	189/836.4	GPRS(GMSK 4TS)	0.329	0.244	-3.12	28.01	28.50	0.368	2022/12/12	1#
Left Tilt 15 Degree	189/836.4	GPRS(GMSK 4TS)	0.174	0.129	-1.38	28.01	28.50	0.195	2022/12/12	
Right Cheek	189/836.4	GPRS(GMSK 4TS)	0.308	0.222	1.89	28.01	28.50	0.345	2022/12/12	
Right Tilt 15 Degree	189/836.4	GPRS(GMSK 4TS)	0.158	0.117	-3.59	28.01	28.50	0.177	2022/12/12	

NOTE: Head SAR test results of GSM850.

Test Position of Body-Worn with 10mm	Test channel /Freq.	Test Mode	SAR Value (W/kg)		Power Drift (±5%)	Conducted power (dBm)	Tune-up power (dBm)	Scaled SAR 1g (W/Kg)	Date	Plot
			1g	10g						
Front Side	189/836.4	GPRS(GMSK 4TS)	0.252	0.148	0.22	28.01	28.50	0.282	2022/12/12	
Back Side	189/836.4	GPRS(GMSK 4TS)	0.417	0.253	-2.81	28.01	28.50	0.467	2022/12/12	2#

NOTE: Body-Worn SAR test results of GSM850

Test Position of Hotspot with 10mm	Test channel /Freq.	Mode	SAR Value (W/kg)		Power Drift(%)	Conducted Power (dBm)	Tune-up Power (dBm)	Scaled SAR 1-g (W/Kg)	Date	Plot
			1-g	10-g						
Front Side	189/836.4	GPRS(GMSK 4TS)	0.252	0.148	0.22	28.01	28.50	0.282	2022/12/12	
Back Side	189/836.4	GPRS(GMSK 4TS)	0.417	0.253	-2.81	28.01	28.50	0.467	2022/12/12	2#
Left Side	189/836.4	GPRS(GMSK 4TS)	0.132	0.076	-2.45	28.01	28.50	0.148	2022/12/12	
Right Side	189/836.4	GPRS(GMSK 4TS)	0.135	0.079	-2.07	28.01	28.50	0.151	2022/12/12	
Bottom Side	189/836.4	GPRS(GMSK 4TS)	0.230	0.140	-2.27	28.01	28.50	0.257	2022/12/12	

NOTE: Hotspot SAR test results of GSM850

10.1.2. SAR measurement Result of GSM1900

Test Position of Head	Test channel /Freq.	Mode	SAR Value (W/kg)		Power Drift(%)	Conducted Power (dBm)	Tune-up Power (dBm)	Scaled SAR 1-g (W/Kg)	Date	Plot
			1-g	10-g						
Left Cheek	661/1880	GPRS(GMSK 2TS)	0.640	0.366	-0.90	27.49	28.00	0.720	2022/12/09	3#
Left Tilt 15 Degree	661/1880	GPRS(GMSK 2TS)	0.332	0.188	-1.23	27.49	28.00	0.373	2022/12/09	
Right Cheek	661/1880	GPRS(GMSK 2TS)	0.585	0.325	-1.93	27.49	28.00	0.658	2022/12/09	
Right Tilt 15	661/1880	GPRS(GMSK 2TS)	0.317	0.181	1.95	27.49	28.00	0.356	2022/12/09	

Degree		2TS)								
--------	--	------	--	--	--	--	--	--	--	--

NOTE: Head SAR test results of GSM1900

Test Position of Body-Worn with 10mm	Test channel /Freq.	Test Mode	SAR Value (W/kg)		Power Drift (±5%)	Conducted power (dBm)	Tune-up power (dBm)	Scaled SAR 1g (W/Kg)	Date	Plot
			1g	10g						
Front Side	661/1880	GPRS(GMSK 2TS)	0.312	0.165	1.83	27.49	28.00	0.351	2022/12/09	
Back Side	661/1880	GPRS(GMSK 2TS)	0.476	0.265	-1.94	27.49	28.00	0.535	2022/12/09	4#

NOTE: Body-Worn SAR test results of GSM1900

Test Position of Hotspot with 10mm	Test channel /Freq.	Mode	SAR Value (W/kg)		Power Drift(%)	Conducted Power (dBm)	Tune-up Power (dBm)	Scaled SAR 1-g (W/Kg)	Date	Plot
			1-g	10-g						
Front Side	661/1880	GPRS(GMSK 2TS)	0.312	0.165	1.83	27.49	28.00	0.351	2022/12/09	
Back Side	661/1880	GPRS(GMSK 2TS)	0.476	0.265	-1.94	27.49	28.00	0.535	2022/12/09	4#
Left Side	661/1880	GPRS(GMSK 2TS)	0.153	0.085	-1.02	27.49	28.00	0.172	2022/12/09	
Right Side	661/1880	GPRS(GMSK 2TS)	0.150	0.080	-0.43	27.49	28.00	0.169	2022/12/09	
Bottom Side	661/1880	GPRS(GMSK 2TS)	0.240	0.134	0.51	27.49	28.00	0.270	2022/12/09	

NOTE: Hotspot SAR test results of GSM1900

10.1.3. SAR measurement Result of WCDMA Band 2

Test Position of Head	Test channel /Freq	Mode	SAR Value (W/kg)		Power Drift(%)	Conducted Power (dBm)	Tune-up Power (dBm)	Scaled SAR 1-g (W/Kg)	Date	Plot
			1-g	10-g						
Left Cheek	9400/1880	RMC12.2K	0.915	0.521	0.21	22.55	23.00	1.015	2022/12/09	
Left Tilt 15 Degree	9400/1880	RMC12.2K	0.547	0.296	0.24	22.55	23.00	0.607	2022/12/09	
Right Cheek	9400/1880	RMC12.2K	0.784	0.442	0.82	22.55	23.00	0.870	2022/12/09	

Right Tilt 15 Degree	9400/1880	RMC12.2K	0.400	0.221	-1.85	22.55	23.00	0.444	2022/12/09	
Left Cheek	9262/1852.4	RMC12.2K	0.995	0.555	-1.45	22.58	23.00	1.096	2022/12/09	5#
Left Cheek repeated	9262/1852.4	RMC12.2K	0.990	0.551	0.34	22.58	23.00	1.091	2022/12/09	
Left Cheek	9538/1907.6	RMC12.2K	0.802	0.452	-1.11	22.51	23.00	0.898	2022/12/09	

NOTE: Head SAR test results of WCDMA Band 2

Test Position of Body-Worn with 10mm	Test channel /Freq.	Test Mode	SAR Value (W/kg)		Power Drift (±5%)	Conducted power (dBm)	Tune-up power (dBm)	Scaled SAR 1g (W/Kg)	Date	Plot
			1g	10g						
Front Side	9400/1880	RMC12.2K	0.396	0.230	-2.38	22.55	23.00	0.439	2022/12/09	
Back Side	9400/1880	RMC12.2K	0.622	0.365	-0.44	22.55	23.00	0.690	2022/12/09	6#

NOTE: Body-Worn SAR test results of WCDMA Band 2

Test Position of Hotspot with 10mm	Test channel /Freq.	Mode	SAR Value (W/kg)		Power Drift(%)	Conducted Power (dBm)	Tune-up Power (dBm)	Scaled SAR 1-g (W/Kg)	Date	Plot
			1-g	10-g						
Front Side	9400/1880	RMC12.2K	0.396	0.230	-2.38	22.55	23.00	0.439	2022/12/09	
Back Side	9400/1880	RMC12.2K	0.622	0.365	-0.44	22.55	23.00	0.690	2022/12/09	6#
Left Side	9400/1880	RMC12.2K	0.195	0.112	-0.46	22.55	23.00	0.216	2022/12/09	
Right Side	9400/1880	RMC12.2K	0.192	0.113	-3.60	22.55	23.00	0.213	2022/12/09	
Bottom Side	9400/1880	RMC12.2K	0.325	0.185	-3.50	22.55	23.00	0.360	2022/12/09	

NOTE: Hotspot SAR test results of WCDMA Band 2

10.1.4. SAR measurement Result of WCDMA Band 4

Test Position of Head	Test channel /Freq	Mode	SAR Value (W/kg)		Power Drift(%)	Conducted Power (dBm)	Tune-up Power (dBm)	Scaled SAR 1-g (W/Kg)	Date	Plot
			1-g	10-g						
Left Cheek	1413/1732.6	RMC12.2K	0.880	0.530	-3.73	22.49	23.00	0.990	2022/12/06	
Left Tilt 15 Degree	1413/1732.6	RMC12.2K	0.604	0.356	-2.69	22.49	23.00	0.679	2022/12/06	
Right Cheek	1413/1732.6	RMC12.2K	0.974	0.599	-0.41	22.49	23.00	1.095	2022/12/06	
Right Tilt 15 Degree	1413/1732.6	RMC12.2K	0.524	0.312	-0.60	22.49	23.00	0.589	2022/12/06	

Left Cheek	1312/1712.4	RMC12.2K	0.952	0.568	2.33	22.69	23.00	1.022	2022/12/06	
Left Cheek	1513/1752.6	RMC12.2K	1.075	0.673	-1.35	22.54	23.00	1.195	2022/12/06	7#
Left Cheek Repeated	1513/1752.6	RMC12.2K	1.068	0.669	0.32	22.54	23.00	1.187	2022/12/06	

NOTE: Head SAR test results of WCDMA Band 4

Test Position of Body-Worn with 10mm	Test channel /Freq	Mode	SAR Value (W/kg)		Power Drift(%)	Conducted Power (dBm)	Tune-up Power (dBm)	Scaled SAR 1-g (W/Kg)	Date	Plot
			1-g	10-g						
Front Side	1413/1732.6	RMC12.2K	0.372	0.212	-1.41	22.49	23.00	0.418	2022/12/06	
Back Side	1413/1732.6	RMC12.2K	0.612	0.360	-4.09	22.49	23.00	0.688	2022/12/06	8#

NOTE: Body-Worn SAR test results of WCDMA Band 4

Test Position of Hotspot with 10mm	Test channel /Freq	Mode	SAR Value (W/kg)		Power Drift(%)	Conducted Power (dBm)	Tune-up Power (dBm)	Scaled SAR 1-g (W/Kg)	Date	Plot
			1-g	10-g						
Front Side	1413/1732.6	RMC12.2K	0.372	0.212	-1.41	22.49	23.00	0.418	2022/12/06	
Back Side	1413/1732.6	RMC12.2K	0.612	0.360	-4.09	22.49	23.00	0.688	2022/12/06	8#
Left Side	1413/1732.6	RMC12.2K	0.186	0.108	1.61	22.49	23.00	0.209	2022/12/06	
Right Side	1413/1732.6	RMC12.2K	0.198	0.113	1.43	22.49	23.00	0.223	2022/12/06	
Bottom Side	1413/1732.6	RMC12.2K	0.325	0.182	2.51	22.49	23.00	0.365	2022/12/06	

NOTE: Hotspot SAR test results of WCDMA Band 4

10.1.5. SAR measurement Result of WCDMA Band 5

Test Position of Head	Test channel /Freq	Mode	SAR Value (W/kg)		Power Drift(%)	Conducted Power (dBm)	Tune-up Power (dBm)	Scaled SAR 1-g (W/Kg)	Date	Plot
			1-g	10-g						
Left Cheek	4182/836.4	RMC12.2K	0.278	0.208	-4.82	22.63	23.00	0.303	2022/12/12	9#
Left Tilt 15 Degree	4182/836.4	RMC12.2K	0.152	0.110	-3.88	22.63	23.00	0.166	2022/12/12	
Right Cheek	4182/836.4	RMC12.2K	0.256	0.192	-2.27	22.63	23.00	0.279	2022/12/12	
Right Tilt 15 Degree	4182/836.4	RMC12.2K	0.126	0.090	-1.47	22.63	23.00	0.137	2022/12/12	

NOTE: Head SAR test results of WCDMA Band 5

Test Position of Body-Worn with 10mm	Test channel /Freq.	Test Mode	SAR Value (W/kg)		Power Drift (±5%)	Conducted power (dBm)	Tune-up power (dBm)	Scaled SAR 1g (W/Kg)	Date	Plot
			1g	10g						
Front Side	4182/836.4	RMC12.2K	0.210	0.129	3.29	22.63	23.00	0.229	2022/12/12	
Back Side	4182/836.4	RMC12.2K	0.322	0.198	-0.71	22.63	23.00	0.351	2022/12/12	10#

NOTE: Body-Worn SAR test results of WCDMA Band 5

Test Position of Hotspot with 10mm	Test channel /Freq.	Mode	SAR Value (W/kg)		Power Drift(%)	Conducted Power (dBm)	Tune-up Power (dBm)	Scaled SAR 1-g (W/Kg)	Date	Plot
			1-g	10-g						
Front Side	4182/836.4	RMC12.2K	0.210	0.129	3.29	22.63	23.00	0.229	2022/12/12	
Back Side	4182/836.4	RMC12.2K	0.322	0.198	-0.71	22.63	23.00	0.351	2022/12/12	10#
Left Side	4182/836.4	RMC12.2K	0.099	0.060	2.02	22.63	23.00	0.108	2022/12/12	
Right Side	4182/836.4	RMC12.2K	0.102	0.061	-1.02	22.63	23.00	0.111	2022/12/12	
Bottom Side	4182/836.4	RMC12.2K	0.165	0.101	1.94	22.63	23.00	0.180	2022/12/12	

NOTE: Hotspot SAR test results of WCDMA Band 5

10.1.6. SAR measurement Result of LTE Band 2

Test Position of Head	Test channel /Freq.	Mode	SAR Value (W/kg)		Power Drift(%)	Conducted Power (dBm)	Tune-up Power (dBm)	Scaled SAR 1-g (W/Kg)	Date	Plot
			1-g	10-g						
1RB										
Left Cheek	18900/1880	20M QPSK(1,49)	0.854	0.485	-1.87	23.02	23.50	0.954	2022/12/09	
Left Tilt 15 Degree	18900/1880	20M QPSK(1,49)	0.497	0.274	-0.20	23.02	23.50	0.555	2022/12/09	
Right Cheek	18900/1880	20M QPSK(1,49)	0.710	0.422	-3.52	23.02	23.50	0.793	2022/12/09	
Right Tilt 15 Degree	18900/1880	20M QPSK(1,49)	0.410	0.228	2.17	23.02	23.50	0.458	2022/12/09	
Left Cheek	18700/1860	20M QPSK(1,49)	0.906	0.519	-1.10	22.82	23.50	1.060	2022/12/09	17#
Left Cheek Repeated	18700/1860	20M QPSK(1,49)	0.897	0.512	0.30	22.82	23.50	1.049	2022/12/09	
Left Cheek	19100/1900	20M	0.765	0.431	-0.76	23.10	23.50	0.839	2022/12/09	

		QPSK(1,49)								
50%RB										
Left Cheek	18900/1880	20M QPSK(50,49)	0.448	0.252	-2.99	21.97	22.50	0.506	2022/12/09	
Left Tilt 15 Degree	18900/1880	20M QPSK(50,49)	0.270	0.148	-2.71	21.97	22.50	0.305	2022/12/09	
Right Cheek	18900/1880	20M QPSK(50,49)	0.362	0.237	-1.05	21.97	22.50	0.409	2022/12/09	
Right Tilt 15 Degree	18900/1880	20M QPSK(50,49)	0.216	0.117	3.66	21.97	22.50	0.244	2022/12/09	
100%RB										
Left Cheek	18900/1880	20M QPSK(100,0)	0.420	0.240	1.30	21.89	22.50	0.483	2022/12/09	

NOTE: Head SAR test results of LTE Band 2

Test Position of Body-Worn with 10mm	Test channel /Freq.	Test Mode	SAR Value (W/kg)		Power Drift (±5%)	Conducted power (dBm)	Tune-up power (dBm)	Scaled SAR 1g (W/Kg)	Date	Plot
			1g	10g						
1RB										
Front Side	18900/1880	20M QPSK(1,49)	0.360	0.203	-0.24	23.02	23.50	0.402	2022/12/09	
Back Side	18900/1880	20M QPSK(1,49)	0.553	0.321	0.92	23.02	23.50	0.618	2022/12/09	18#
50%RB										
Front Side	18900/1880	20M QPSK(50,49)	0.194	0.103	-1.56	21.97	22.50	0.219	2022/12/09	
Back Side	18900/1880	20M QPSK(50,49)	0.294	0.174	2.06	21.97	22.50	0.332	2022/12/09	

NOTE: Body-Worn SAR test results of LTE Band 2

Test Position of Hotspot with 10mm	Test channel /Freq.	Mode	SAR Value (W/kg)		Power Drift(%)	Conducted Power (dBm)	Tune-up Power (dBm)	Scaled SAR 1-g (W/Kg)	Date	Plot
			1-g	10-g						
1RB										
Front Side	18900/1880	20M QPSK(1,49)	0.360	0.203	-0.24	23.02	23.50	0.402	2022/12/09	
Back Side	18900/1880	20M QPSK(1,49)	0.553	0.321	0.92	23.02	23.50	0.618	2022/12/09	18#

Left Side	18900/1880	20M QPSK(1,49)	0.171	0.094	-0.08	23.02	23.50	0.191	2022/12/09	
Right Side	18900/1880	20M QPSK(1,49)	0.174	0.101	2.80	23.02	23.50	0.194	2022/12/09	
Bottom Side	18900/1880	20M QPSK(1,49)	0.290	0.162	-1.85	23.02	23.50	0.324	2022/12/09	
50%RB										
Front Side	18900/1880	20M QPSK(50,49)	0.194	0.103	-1.56	21.97	22.50	0.219	2022/12/09	
Back Side	18900/1880	20M QPSK(50,49)	0.294	0.174	2.06	21.97	22.50	0.332	2022/12/09	
Left Side	18900/1880	20M QPSK(50,49)	0.092	0.056	-0.45	21.97	22.50	0.104	2022/12/09	
Right Side	18900/1880	20M QPSK(50,49)	0.095	0.056	0.39	21.97	22.50	0.107	2022/12/09	
Bottom Side	18900/1880	20M QPSK(50,49)	0.169	0.093	1.48	21.97	22.50	0.191	2022/12/09	

NOTE: Hotspot SAR test results of LTE Band 2

10.1.7. SAR measurement Result of LTE Band 4

Test Position of Head	Test channel /Freq.	Mode	SAR Value (W/kg)		Power Drift(%)	Conducted Power (dBm)	Tune-up Power (dBm)	Scaled SAR 1-g (W/Kg)	Date	Plot
			1-g	10-g						
1RB										
Left Cheek	20175/1732.5	20M QPSK(1,0)	1.017	0.618	-1.99	22.52	23.00	1.136	2022/12/06	
Left Tilt 15 Degree	20175/1732.5	20M QPSK(1,0)	0.566	0.334	3.40	22.52	23.00	0.632	2022/12/06	
Right Cheek	20175/1732.5	20M QPSK(1,0)	0.886	0.538	-0.87	22.52	23.00	0.990	2022/12/06	
Right Tilt 15 Degree	20175/1732.5	20M QPSK(1,0)	0.449	0.259	-3.52	22.52	23.00	0.501	2022/12/06	
Left Cheek	20050/1720	20M QPSK(1,0)	0.923	0.561	-1.97	22.73	23.00	0.982	2022/12/06	
Left	20300/1745	20M	1.030	0.654	-0.94	22.35	23.00	1.196	2022/12/06	19#

Cheek		QPSK(1,0)								
Left Cheek Repeated	20300/1745	20M QPSK(1,0)	1.025	0.650	1.30	22.35	23.00	1.190	2022/12/06	
50%RB										
Left Cheek	20175/1732.5	20M QPSK(50,24)	0.602	0.329	-4.56	21.72	22.00	0.642	2022/12/06	
Left Tilt 15 Degree	20175/1732.5	20M QPSK(50,24)	0.339	0.173	0.74	21.72	22.00	0.362	2022/12/06	
Right Cheek	20175/1732.5	20M QPSK(50,24)	0.483	0.290	-0.57	21.72	22.00	0.515	2022/12/06	
Right Tilt 15 Degree	20175/1732.5	20M QPSK(50,24)	0.255	0.154	-3.44	21.72	22.00	0.272	2022/12/06	
100%RB										
Left Cheek	20175/1732.5	20M QPSK(100,0)	0.563	0.304	1.20	21.60	22.00	0.617	2022/12/06	

NOTE: Head SAR test results of LTE Band 4

Test Position of Body- Worn with 10mm	Test channel /Freq.	Test Mode	SAR Value (W/kg)		Power Drift (±5%)	Conducted power (dBm)	Tune-up power (dBm)	Scaled SAR 1g (W/Kg)	Date	Plot
			1g	10g						
1RB										
Front Side	20175/1732.5	20M QPSK(1,0)	0.288	0.151	-1.74	22.52	23.00	0.322	2022/12/06	
Back Side	20175/1732.5	20M QPSK(1,0)	0.462	0.245	-2.42	22.52	23.00	0.516	2022/12/06	20#
50%RB										
Front Side	20175/1732.5	20M QPSK(50,24)	0.170	0.081	2.91	21.72	22.00	0.181	2022/12/06	
Back Side	20175/1732.5	20M QPSK(50,24)	0.270	0.140	-1.14	21.72	22.00	0.288	2022/12/06	

NOTE: Body-Worn SAR test results of LTE Band 4

Test Position	Test channel /Freq.	Mode	SAR Value (W/kg)	Power Drift(%)	Conducted Power	Tune-up Power	Scaled SAR	Date	Plot
------------------	------------------------	------	---------------------	-------------------	--------------------	------------------	---------------	------	------

of Hotspot with 10mm			1-g	10-g		(dBm)	(dBm)	1-g (W/Kg)		
1RB										
Front Side	20175/1732.5	20M QPSK(1,0)	0.288	0.151	-1.74	22.52	23.00	0.322	2022/12/06	
Back Side	20175/1732.5	20M QPSK(1,0)	0.462	0.245	-2.42	22.52	23.00	0.516	2022/12/06	20#
Left Side	20175/1732.5	20M QPSK(1,0)	0.141	0.071	-2.19	22.52	23.00	0.157	2022/12/06	
Right Side	20175/1732.5	20M QPSK(1,0)	0.153	0.079	-2.01	22.52	23.00	0.171	2022/12/06	
Bottom Side	20175/1732.5	20M QPSK(1,0)	0.245	0.129	-1.22	22.52	23.00	0.274	2022/12/06	
50%RB										
Front Side	20175/1732.5	20M QPSK(50,24)	0.170	0.081	2.91	21.72	22.00	0.181	2022/12/06	
Back Side	20175/1732.5	20M QPSK(50,24)	0.270	0.140	-1.14	21.72	22.00	0.288	2022/12/06	
Left Side	20175/1732.5	20M QPSK(50,24)	0.071	0.036	1.40	21.72	22.00	0.076	2022/12/06	
Right Side	20175/1732.5	20M QPSK(50,24)	0.087	0.040	-1.95	21.72	22.00	0.093	2022/12/06	
Bottom Side	20175/1732.5	20M QPSK(50,24)	0.139	0.066	-1.72	21.72	22.00	0.148	2022/12/06	

NOTE: Hotspot SAR test results of LTE Band 4

10.1.8. SAR measurement Result of LTE Band 5

Test Position of Head	Test channel /Freq.	Mode	SAR Value (W/kg)		Power Drift(%)	Conducted Power (dBm)	Tune-up Power (dBm)	Scaled SAR 1-g (W/Kg)	Date	Plot
			1-g	10-g						
1RB										
Left Cheek	20525/836.5	10M QPSK(1,24)	0.277	0.212	0.47	23.29	23.50	0.291	2022/12/12	21#
Left Tilt 15 Degree	20525/836.5	10M QPSK(1,24)	0.152	0.115	-0.47	23.29	23.50	0.160	2022/12/12	

Right Cheek	20525/836.5	10M QPSK(1,24)	0.241	0.184	-2.04	23.29	23.50	0.253	2022/12/12	
Right Tilt 15 Degree	20525/836.5	10M QPSK(1,24)	0.125	0.091	-2.06	23.29	23.50	0.131	2022/12/12	
50%RB										
Left Cheek	20525/836.5	10M QPSK(25,12)	0.152	0.120	-4.64	22.29	22.50	0.160	2022/12/12	
Left Tilt 15 Degree	20525/836.5	10M QPSK(25,12)	0.082	0.066	-3.16	22.29	22.50	0.086	2022/12/12	
Right Cheek	20525/836.5	10M QPSK(25,12)	0.121	0.099	-4.16	22.29	22.50	0.127	2022/12/12	
Right Tilt 15 Degree	20525/836.5	10M QPSK(25,12)	0.074	0.046	0.29	22.29	22.50	0.078	2022/12/12	

NOTE: Head SAR test results of LTE Band 5

Test Position of Body-Worn with 10mm	Test channel /Freq.	Test Mode	SAR Value (W/kg)		Power Drift (±5%)	Conducted power (dBm)	Tune-up power (dBm)	Scaled SAR 1g (W/Kg)	Date	Plot
			1g	10g						
1RB										
Front Side	20525/836.5	10M QPSK(1,24)	0.222	0.137	-1.25	23.29	23.50	0.233	2022/12/12	
Back Side	20525/836.5	10M QPSK(1,24)	0.323	0.199	-0.10	23.29	23.50	0.339	2022/12/12	22#
50%RB										
Front Side	20525/836.5	10M QPSK(25,12)	0.131	0.072	3.62	22.29	22.50	0.137	2022/12/12	
Back Side	20525/836.5	10M QPSK(25,12)	0.187	0.100	-0.56	22.29	22.50	0.196	2022/12/12	

NOTE: Body-Worn SAR test results of LTE Band 5

Test Position of Hotspot with 10mm	Test channel /Freq.	Mode	SAR Value (W/kg)		Power Drift(%)	Conducted Power (dBm)	Tune-up Power (dBm)	Scaled SAR 1-g (W/Kg)	Date	Plot
			1-g	10-g						
1RB										

Front Side	20525/836.5	10M QPSK(1,24)	0.222	0.137	-1.25	23.29	23.50	0.233	2022/12/12	
Back Side	20525/836.5	10M QPSK(1,24)	0.323	0.199	-0.10	23.29	23.50	0.339	2022/12/12	22#
Left Side	20525/836.5	10M QPSK(1,24)	0.099	0.058	0.23	23.29	23.50	0.104	2022/12/12	
Right Side	20525/836.5	10M QPSK(1,24)	0.111	0.068	1.37	23.29	23.50	0.116	2022/12/12	
Bottom Side	20525/836.5	10M QPSK(1,24)	0.175	0.106	1.73	23.29	23.50	0.184	2022/12/12	
50%RB										
Front Side	20525/836.5	10M QPSK(25,12)	0.131	0.072	3.62	22.29	22.50	0.137	2022/12/12	
Back Side	20525/836.5	10M QPSK(25,12)	0.187	0.100	-0.56	22.29	22.50	0.196	2022/12/12	
Left Side	20525/836.5	10M QPSK(25,12)	0.050	0.035	2.70	22.29	22.50	0.052	2022/12/12	
Right Side	20525/836.5	10M QPSK(25,12)	0.059	0.037	-2.66	22.29	22.50	0.062	2022/12/12	
Bottom Side	20525/836.5	10M QPSK(25,12)	0.100	0.061	2.10	22.29	22.50	0.105	2022/12/12	

NOTE: Hotspot SAR test results of LTE Band 5

10.1.9. SAR measurement Result of LTE Band 7

Test Position of Head	Test channel /Freq.	Mode	SAR Value (W/kg)		Power Drift(%)	Conducted Power (dBm)	Tune-up Power (dBm)	Scaled SAR 1-g (W/Kg)	Date	Plot
			1-g	10-g						
1RB										
Left Cheek	21100/2535	20M QPSK(1,99)	0.137	0.080	-2.25	23.31	23.50	0.143	2022/12/08	23#
Left Tilt 15 Degree	21100/2535	20M QPSK(1,99)	0.071	0.041	0.92	23.31	23.50	0.074	2022/12/08	
Right Cheek	21100/2535	20M QPSK(1,99)	0.128	0.073	0.65	23.31	23.50	0.134	2022/12/08	
Right Tilt 15 Degree	21100/2535	20M QPSK(1,99)	0.060	0.034	-2.52	23.31	23.50	0.063	2022/12/08	
50%RB										

Left Cheek	21100/2535	20M QPSK(50,49)	0.079	0.044	-1.48	22.25	23.00	0.094	2022/12/08	
Left Tilt 15 Degree	21100/2535	20M QPSK(50,49)	0.042	0.021	3.09	22.25	23.00	0.050	2022/12/08	
Right Cheek	21100/2535	20M QPSK(50,49)	0.064	0.038	-4.47	22.25	23.00	0.076	2022/12/08	
Right Tilt 15 Degree	21100/2535	20M QPSK(50,49)	0.035	0.019	3.75	22.25	23.00	0.042	2022/12/08	

NOTE: Head SAR test results of LTE Band 7

Test Position of Body-Worn with 10mm	Test channel /Freq.	Mode	SAR Value (W/kg)		Power Drift(%)	Conducted Power (dBm)	Tune-up Power (dBm)	Scaled SAR 1-g (W/Kg)	Date	Plot
			1-g	10-g						
1RB										
Front Side	21100/2535	20M QPSK(1,99)	0.540	0.250	0.41	23.31	23.50	0.564	2022/12/08	
Back Side	21100/2535	20M QPSK(1,99)	0.876	0.405	0.04	23.31	23.50	0.915	2022/12/08	
Back Side	20850/2510	20M QPSK(1,99)	0.812	0.383	0.63	23.37	23.50	0.837	2022/12/08	
Back Side	21350/2560	20M QPSK(1,99)	1.060	0.481	-0.22	23.48	23.50	1.065	2022/12/08	24#
Back Side Repeated	21350/2560	20M QPSK(1,99)	1.057	0.477	1.23	23.48	23.50	1.062	2022/12/08	
50%RB										
Front Side	21100/2535	20M QPSK(50,49)	0.292	0.136	2.38	22.25	23.00	0.347	2022/12/08	
Back Side	21100/2535	20M QPSK(50,49)	0.459	0.232	2.77	22.25	23.00	0.546	2022/12/08	
100%RB										
Back Side	21100/2535	20M QPSK(100,0)	0.442	0.217	4.65	22.19	22.50	0.475	2022/12/08	

NOTE: Body-Worn SAR test results of LTE Band 7

Test Position of Hotspot with 10mm	Test channel /Freq.	Mode	SAR Value (W/kg)		Power Drift(%)	Conducted Power (dBm)	Tune-up Power (dBm)	Scaled SAR 1-g (W/Kg)	Date	Plot
			1-g	10-g						
1RB										

Front Side	21100/2535	20M QPSK(1,99)	0.540	0.250	0.41	23.31	23.50	0.564	2022/12/08	
Back Side	21100/2535	20M QPSK(1,99)	0.876	0.405	0.04	23.31	23.50	0.915	2022/12/08	
Left Side	21100/2535	20M QPSK(1,99)	0.273	0.126	-0.14	23.31	23.50	0.285	2022/12/08	
Right Side	21100/2535	20M QPSK(1,99)	0.267	0.123	-1.28	23.31	23.50	0.279	2022/12/08	
Bottom Side	21100/2535	20M QPSK(1,99)	0.440	0.197	-1.15	23.31	23.50	0.460	2022/12/08	
Back Side	20850/2510	20M QPSK(1,99)	0.812	0.383	0.63	23.37	23.50	0.837	2022/12/08	
Back Side	21350/2560	20M QPSK(1,99)	1.060	0.481	-0.22	23.48	23.50	1.065	2022/12/08	24#
Back Side Repeated	21350/2560	20M QPSK(1,99)	1.057	0.477	1.23	23.48	23.50	1.062	2022/12/08	
50%RB										
Front Side	21100/2535	20M QPSK(50,49)	0.292	0.136	2.38	22.25	23.00	0.347	2022/12/08	
Back Side	21100/2535	20M QPSK(50,49)	0.459	0.232	2.77	22.25	23.00	0.546	2022/12/08	
Left Side	21100/2535	20M QPSK(50,49)	0.143	0.072	-4.54	22.25	23.00	0.170	2022/12/08	
Right Side	21100/2535	20M QPSK(50,49)	0.157	0.069	1.66	22.25	23.00	0.187	2022/12/08	
Bottom Side	21100/2535	20M QPSK(50,49)	0.260	0.113	0.98	22.25	23.00	0.309	2022/12/08	
100%RB										
Back Side	21100/2535	20M QPSK(100,0)	0.442	0.217	4.65	22.19	22.50	0.475	2022/12/08	

NOTE: Hotspot SAR test results of LTE Band 7

10.1.10. SAR measurement Result of LTE Band 12

Test Position of Head	Test channel /Freq.	Mode	SAR Value (W/kg)		Power Drift(%)	Conducted Power (dBm)	Tune-up Power (dBm)	Scaled SAR 1-g (W/Kg)	Date	Plot
			1-g	10-g						
1RB										
Left	23095/707.5	10M	0.192	0.156	-0.71	23.06	23.50	0.212	2022/12/13	25#

Cheek		QPSK(1,0)								
Left Tilt 15 Degree	23095/707.5	10M QPSK(1,0)	0.113	0.090	-2.10	23.06	23.50	0.125	2022/12/13	
Right Cheek	23095/707.5	10M QPSK(1,0)	0.172	0.136	-2.19	23.06	23.50	0.190	2022/12/13	
Right Tilt 15 Degree	23095/707.5	10M QPSK(1,0)	0.081	0.063	-3.55	23.06	23.50	0.090	2022/12/13	
50%RB										
Left Cheek	23095/707.5	10M QPSK(25,24)	0.099	0.080	2.75	22.01	22.50	0.111	2022/12/13	
Left Tilt 15 Degree	23095/707.5	10M QPSK(25,24)	0.067	0.053	-4.26	22.01	22.50	0.075	2022/12/13	
Right Cheek	23095/707.5	10M QPSK(25,24)	0.101	0.075	-0.08	22.01	22.50	0.113	2022/12/13	
Right Tilt 15 Degree	23095/707.5	10M QPSK(25,24)	0.048	0.036	-3.47	22.01	22.50	0.054	2022/12/13	

NOTE: Head SAR test results of LTE Band 12

Test Position of Body-Worn with 10mm	Test channel /Freq.	Mode	SAR Value (W/kg)		Power Drift(%)	Conducted Power (dBm)	Tune-up Power (dBm)	Scaled SAR 1-g (W/Kg)	Date	Plot
			1-g	10-g						
1RB										
Front Side	23095/707.5	10M QPSK(1,0)	0.174	0.135	1.15	23.06	23.50	0.193	2022/12/13	
Back Side	23095/707.5	10M QPSK(1,0)	0.250	0.200	-0.10	23.06	23.50	0.277	2022/12/13	26#
50%RB										
Front Side	23095/707.5	10M QPSK(25,24)	0.099	0.073	0.43	22.01	22.50	0.111	2022/12/13	
Back Side	23095/707.5	10M QPSK(25,24)	0.132	0.106	1.95	22.01	22.50	0.148	2022/12/13	

NOTE: Body-Worn SAR test results of LTE Band 12

Test Position of Hotspot with 10mm	Test channel /Freq.	Mode	SAR Value (W/kg)		Power Drift(%)	Conducted Power (dBm)	Tune-up Power (dBm)	Scaled SAR 1-g (W/Kg)	Date	Plot
			1-g	10-g						
1RB										

Front Side	23095/707.5	10M QPSK(1,0)	0.174	0.135	1.15	23.06	23.50	0.193	2022/12/13	
Back Side	23095/707.5	10M QPSK(1,0)	0.250	0.200	-0.10	23.06	23.50	0.277	2022/12/13	26#
Left Side	23095/707.5	10M QPSK(1,0)	0.081	0.062	0.91	23.06	23.50	0.090	2022/12/13	
Right Side	23095/707.5	10M QPSK(1,0)	0.090	0.071	1.70	23.06	23.50	0.100	2022/12/13	
Bottom Side	23095/707.5	10M QPSK(1,0)	0.140	0.111	2.60	23.06	23.50	0.155	2022/12/13	
50%RB										
Front Side	23095/707.5	10M QPSK(25,24)	0.099	0.073	0.43	22.01	22.50	0.111	2022/12/13	
Back Side	23095/707.5	10M QPSK(25,24)	0.132	0.106	1.95	22.01	22.50	0.148	2022/12/13	
Left Side	23095/707.5	10M QPSK(25,24)	0.042	0.034	-3.48	22.01	22.50	0.047	2022/12/13	
Right Side	23095/707.5	10M QPSK(25,24)	0.049	0.036	-3.95	22.01	22.50	0.055	2022/12/13	
Bottom Side	23095/707.5	10M QPSK(25,24)	0.073	0.057	-0.93	22.01	22.50	0.082	2022/12/13	

NOTE: Hotspot SAR test results of LTE Band 12

10.1.11. SAR measurement Result of LTE Band 13

Test Position of Head	Test channel /Freq.	Mode	SAR Value (W/kg)		Power Drift(%)	Conducted Power (dBm)	Tune-up Power (dBm)	Scaled SAR 1-g (W/Kg)	Date	Plot
			1-g	10-g						
1RB										
Left Cheek	23230/782	10M QPSK(1,0)	0.158	0.124	-2.11	23.18	23.50	0.170	2022/12/13	27#
Left Tilt 15 Degree	23230/782	10M QPSK(1,0)	0.088	0.066	2.11	23.18	23.50	0.095	2022/12/13	
Right Cheek	23230/782	10M QPSK(1,0)	0.136	0.107	-3.61	23.18	23.50	0.146	2022/12/13	
Right Tilt 15 Degree	23230/782	10M QPSK(1,0)	0.065	0.049	2.07	23.18	23.50	0.070	2022/12/13	
50%RB										

Left Cheek	23230/782	10M QPSK(25,12)	0.085	0.073	-0.60	22.10	22.50	0.093	2022/12/13	
Left Tilt 15 Degree	23230/782	10M QPSK(25,12)	0.044	0.035	-1.36	22.10	22.50	0.048	2022/12/13	
Right Cheek	23230/782	10M QPSK(25,12)	0.072	0.055	3.01	22.10	22.50	0.079	2022/12/13	
Right Tilt 15 Degree	23230/782	10M QPSK(25,12)	0.033	0.025	-2.46	22.10	22.50	0.036	2022/12/13	

NOTE: Head SAR test results of LTE Band 13

Test Position of Body-Worn with 10mm	Test channel /Freq.	Mode	SAR Value (W/kg)		Power Drift(%)	Conducted Power (dBm)	Tune-up Power (dBm)	Scaled SAR 1-g (W/Kg)	Date	Plot
			1-g	10-g						
1RB										
Front Side	23230/782	10M QPSK(1,0)	0.144	0.085	-2.05	23.18	23.50	0.155	2022/12/13	
Back Side	23230/782	10M QPSK(1,0)	0.191	0.115	-0.01	23.18	23.50	0.206	2022/12/13	28#
50%RB										
Front Side	23230/782	10M QPSK(25,12)	0.082	0.043	1.40	22.10	22.50	0.090	2022/12/13	
Back Side	23230/782	10M QPSK(25,12)	0.104	0.061	-2.17	22.10	22.50	0.114	2022/12/13	

NOTE: Body-Worn SAR test results of LTE Band 13

Test Position of Hotspot with 10mm	Test channel /Freq.	Mode	SAR Value (W/kg)		Power Drift(%)	Conducted Power (dBm)	Tune-up Power (dBm)	Scaled SAR 1-g (W/Kg)	Date	Plot
			1-g	10-g						
1RB										
Front Side	23230/782	10M QPSK(1,0)	0.144	0.085	-2.05	23.18	23.50	0.155	2022/12/13	
Back Side	23230/782	10M QPSK(1,0)	0.191	0.115	-0.01	23.18	23.50	0.206	2022/12/13	28#
Left Side	23230/782	10M QPSK(1,0)	0.066	0.039	0.56	23.18	23.50	0.071	2022/12/13	
Right Side	23230/782	10M QPSK(1,0)	0.063	0.037	-2.13	23.18	23.50	0.068	2022/12/13	
Bottom Side	23230/782	10M	0.105	0.062	-1.30	23.18	23.50	0.113	2022/12/13	

		QPSK(1,0)	50%RB							
Front Side	23230/782	10M QPSK(25,12)	0.082	0.043	1.40	22.10	22.50	0.090	2022/12/13	
Back Side	23230/782	10M QPSK(25,12)	0.104	0.061	-2.17	22.10	22.50	0.114	2022/12/13	
Left Side	23230/782	10M QPSK(25,12)	0.034	0.022	-2.97	22.10	22.50	0.037	2022/12/13	
Right Side	23230/782	10M QPSK(25,12)	0.032	0.019	0.78	22.10	22.50	0.035	2022/12/13	
Bottom Side	23230/782	10M QPSK(25,12)	0.054	0.036	-4.35	22.10	22.50	0.059	2022/12/13	

NOTE: Hotspot SAR test results of LTE Band 13

10.1.12. SAR measurement Result of LTE Band 17

Test Position of Head	Test channel /Freq.	Mode	SAR Value (W/kg)		Power Drift(%)	Conducted Power (dBm)	Tune-up Power (dBm)	Scaled SAR 1-g (W/Kg)	Date	Plot
			1-g	10-g						
1RB										
Left Cheek	23790/710	10M QPSK(1,0)	0.196	0.160	-3.51	22.94	23.00	0.199	2022/12/13	29#
Left Tilt 15 Degree	23790/710	10M QPSK(1,0)	0.115	0.093	-1.37	22.94	23.00	0.117	2022/12/13	
Right Cheek	23790/710	10M QPSK(1,0)	0.182	0.144	3.30	22.94	23.00	0.185	2022/12/13	
Right Tilt 15 Degree	23790/710	10M QPSK(1,0)	0.088	0.072	-2.36	22.94	23.00	0.089	2022/12/13	
50%RB										
Left Cheek	23790/710	10M QPSK(25,12)	0.111	0.095	3.52	21.85	22.00	0.115	2022/12/13	
Left Tilt 15 Degree	23790/710	10M QPSK(25,12)	0.065	0.050	-1.68	21.85	22.00	0.067	2022/12/13	
Right Cheek	23790/710	10M QPSK(25,12)	0.097	0.077	-4.66	21.85	22.00	0.100	2022/12/13	
Right Tilt 15 Degree	23790/710	10M QPSK(25,12)	0.046	0.039	-2.44	21.85	22.00	0.048	2022/12/13	

NOTE: Head SAR test results of LTE Band17

Test Position of Body-Worn with 10mm	Test channel /Freq.	Mode	SAR Value (W/kg)		Power Drift(%)	Conducted Power (dBm)	Tune-up Power (dBm)	Scaled SAR 1-g (W/Kg)	Date	Plot
			1-g	10-g						
1RB										
Front Side	23790/710	10M QPSK(1,0)	0.174	0.126	-1.81	22.94	23.00	0.176	2022/12/13	
Back Side	23790/710	10M QPSK(1,0)	0.284	0.215	0.11	22.94	23.00	0.288	2022/12/13	30#
50%RB										
Front Side	23790/710	10M QPSK(25,12)	0.089	0.067	4.56	21.85	22.00	0.092	2022/12/13	
Back Side	23790/710	10M QPSK(25,12)	0.149	0.110	-2.44	21.85	22.00	0.154	2022/12/13	

NOTE: Body-Worn SAR test results of LTE Band 17

Test Position of Hotspot with 10mm	Test channel /Freq.	Mode	SAR Value (W/kg)		Power Drift(%)	Conducted Power (dBm)	Tune-up Power (dBm)	Scaled SAR 1-g (W/Kg)	Date	Plot
			1-g	10-g						
1RB										
Front Side	23790/710	10M QPSK(1,0)	0.174	0.126	-1.81	22.94	23.00	0.176	2022/12/13	
Back Side	23790/710	10M QPSK(1,0)	0.284	0.215	0.11	22.94	23.00	0.288	2022/12/13	30#
Left Side	23790/710	10M QPSK(1,0)	0.087	0.063	-0.23	22.94	23.00	0.088	2022/12/13	
Right Side	23790/710	10M QPSK(1,0)	0.099	0.074	2.98	22.94	23.00	0.100	2022/12/13	
Bottom Side	23790/710	10M QPSK(1,0)	0.155	0.114	3.08	22.94	23.00	0.157	2022/12/13	
50%RB										
Front Side	23790/710	10M QPSK(25,12)	0.089	0.067	4.56	21.85	22.00	0.092	2022/12/13	
Back Side	23790/710	10M QPSK(25,12)	0.149	0.110	-2.44	21.85	22.00	0.154	2022/12/13	
Left Side	23790/710	10M QPSK(25,12)	0.046	0.036	3.13	21.85	22.00	0.048	2022/12/13	
Right Side	23790/710	10M QPSK(25,12)	0.059	0.044	-2.50	21.85	22.00	0.061	2022/12/13	

Bottom Side	23790/710	10M QPSK(25,12)	0.083	0.060	-0.85	21.85	22.00	0.086	2022/12/13	
-------------	-----------	--------------------	-------	-------	-------	-------	-------	-------	------------	--

NOTE: Hotspot SAR test results of LTE Band 17

10.1.13. SAR measurement Result of LTE Band 25

Test Position of Head	Test channel /Freq.	Mode	SAR Value (W/kg)		Power Drift(%)	Conducted Power (dBm)	Tune-up Power (dBm)	Scaled SAR 1-g (W/Kg)	Date	Plot
			1-g	10-g						
1RB										
Left Cheek	26365/1882.5	20M QPSK(1,99)	0.540	0.271	0.17	22.59	23.00	0.593	2022/12/09	31#
Left Tilt 15 Degree	26365/1882.5	20M QPSK(1,99)	0.296	0.147	-0.71	22.59	23.00	0.325	2022/12/09	
Right Cheek	26365/1882.5	20M QPSK(1,99)	0.459	0.226	-1.37	22.59	23.00	0.504	2022/12/09	
Right Tilt 15 Degree	26365/1882.5	20M QPSK(1,99)	0.229	0.109	0.02	22.59	23.00	0.252	2022/12/09	
50%RB										
Left Cheek	26365/1882.5	20M QPSK(50,49)	0.305	0.141	-0.51	21.46	21.50	0.308	2022/12/09	
Left Tilt 15 Degree	26365/1882.5	20M QPSK(50,49)	0.151	0.087	-3.21	21.46	21.50	0.152	2022/12/09	
Right Cheek	26365/1882.5	20M QPSK(50,49)	0.250	0.114	-2.99	21.46	21.50	0.252	2022/12/09	
Right Tilt 15 Degree	26365/1882.5	20M QPSK(50,49)	0.128	0.064	1.36	21.46	21.50	0.129	2022/12/09	

NOTE: Head SAR test results of LTE Band 25

Test Position of Body-Worn with 10mm	Test channel /Freq.	Mode	SAR Value (W/kg)		Power Drift(%)	Conducted Power (dBm)	Tune-up Power (dBm)	Scaled SAR 1-g (W/Kg)	Date	Plot
			1-g	10-g						
1RB										

Front Side	26365/1882.5	20M QPSK(1,99)	0.252	0.120	0.11	22.59	23.00	0.277	2022/12/09	
Back Side	26365/1882.5	20M QPSK(1,99)	0.408	0.202	-4.71	22.59	23.00	0.448	2022/12/09	32#
50%RB										
Front Side	26365/1882.5	20M QPSK(50,49)	0.133	0.065	1.54	21.46	21.50	0.134	2022/12/09	
Back Side	26365/1882.5	20M QPSK(50,49)	0.208	0.114	-4.50	21.46	21.50	0.210	2022/12/09	

NOTE: Body-Worn SAR test results of LTE Band 25

Test Position of Hotspot with 10mm	Test channel /Freq.	Mode	SAR Value (W/kg)		Power Drift(%)	Conducted Power (dBm)	Tune-up Power (dBm)	Scaled SAR 1-g (W/Kg)	Date	Plot
			1-g	10-g						
1RB										
Front Side	26365/1882.5	20M QPSK(1,99)	0.252	0.120	0.11	22.59	23.00	0.277	2022/12/09	
Back Side	26365/1882.5	20M QPSK(1,99)	0.408	0.202	-4.71	22.59	23.00	0.448	2022/12/09	32#
Left Side	26365/1882.5	20M QPSK(1,99)	0.135	0.067	-1.55	22.59	23.00	0.148	2022/12/09	
Right Side	26365/1882.5	20M QPSK(1,99)	0.135	0.066	0.45	22.59	23.00	0.148	2022/12/09	
Bottom Side	26365/1882.5	20M QPSK(1,99)	0.210	0.100	2.62	22.59	23.00	0.231	2022/12/09	
50%RB										
Front Side	26365/1882.5	20M QPSK(50,49)	0.133	0.065	1.54	21.46	21.50	0.134	2022/12/09	
Back Side	26365/1882.5	20M QPSK(50,49)	0.208	0.114	-4.50	21.46	21.50	0.210	2022/12/09	
Left Side	26365/1882.5	20M QPSK(50,49)	0.073	0.036	4.94	21.46	21.50	0.074	2022/12/09	
Right Side	26365/1882.5	20M QPSK(50,49)	0.072	0.038	-2.06	21.46	21.50	0.073	2022/12/09	
Bottom Side	26365/1882.5	20M QPSK(50,49)	0.124	0.054	-2.80	21.46	21.50	0.125	2022/12/09	

NOTE: Hotspot SAR test results of LTE Band 25

10.1.14. SAR measurement Result of LTE Band 41

Test Position of Head	Test channel /Freq.	Mode	SAR Value (W/kg)		Power Drift(%)	Conducted Power (dBm)	Tune-up Power (dBm)	Scaled SAR 1-g (W/Kg)	Date	Plot
			1-g	10-g						
1RB										
Left Cheek	40640/2595	20M QPSK(1,99)	0.045	0.030	-4.69	24.14	24.50	0.049	2022/12/08	33#
Left Tilt 15 Degree	40640/2595	20M QPSK(1,99)	0.026	0.017	0.79	24.14	24.50	0.028	2022/12/08	
Right Cheek	40640/2595	20M QPSK(1,99)	0.042	0.028	2.37	24.14	24.50	0.046	2022/12/08	
Right Tilt 15 Degree	40640/2595	20M QPSK(1,99)	0.022	0.014	-2.53	24.14	24.50	0.024	2022/12/08	
50%RB										
Left Cheek	40640/2595	20M QPSK(50,24)	0.026	0.016	-3.33	22.98	23.50	0.029	2022/12/08	
Left Tilt 15 Degree	40640/2595	20M QPSK(50,24)	0.014	0.010	0.91	22.98	23.50	0.016	2022/12/08	
Right Cheek	40640/2595	20M QPSK(50,24)	0.024	0.016	-2.32	22.98	23.50	0.027	2022/12/08	
Right Tilt 15 Degree	40640/2595	20M QPSK(50,24)	0.012	0.008	-3.45	22.98	23.50	0.014	2022/12/08	

NOTE: Head SAR test results of LTE Band 41

Test Position of Body-Worn with 10mm	Test channel /Freq.	Mode	SAR Value (W/kg)		Power Drift(%)	Conducted Power (dBm)	Tune-up Power (dBm)	Scaled SAR 1-g (W/Kg)	Date	Plot
			1-g	10-g						
1RB										
Front Side	40640/2595	20M QPSK(1,99)	0.366	0.159	2.87	24.14	24.50	0.398	2022/12/08	
Back Side	40640/2595	20M QPSK(1,99)	0.562	0.257	-0.78	24.14	24.50	0.611	2022/12/08	34#
50%RB										
Front Side	40640/2595	20M QPSK(50,24)	0.197	0.095	-4.95	22.98	23.50	0.222	2022/12/08	
Back Side	40640/2595	20M	0.312	0.137	0.83	22.98	23.50	0.352	2022/12/08	

		QPSK(50,24)								
--	--	-------------	--	--	--	--	--	--	--	--

NOTE: Body-Worn SAR test results of LTE Band 25

Test Position of Hotspot with 0mm	Test channel /Freq.	Mode	SAR Value (W/kg)		Power Drift(%)	Conducted Power (dBm)	Tune-up Power (dBm)	Scaled SAR 1-g (W/Kg)	Date	Plot
			1-g	10-g						
1RB										
Front Side	40640/2595	20M QPSK(1,99)	0.366	0.159	2.87	24.14	24.50	0.398	2022/12/08	
Back Side	40640/2595	20M QPSK(1,99)	0.562	0.257	-0.78	24.14	24.50	0.611	2022/12/08	34#
Left Side	40640/2595	20M QPSK(1,99)	0.171	0.076	-0.17	24.14	24.50	0.186	2022/12/08	
Right Side	40640/2595	20M QPSK(1,99)	0.177	0.079	-2.57	24.14	24.50	0.192	2022/12/08	
Bottom Side	40640/2595	20M QPSK(1,99)	0.295	0.135	-3.94	24.14	24.50	0.320	2022/12/08	
50%RB										
Front Side	40640/2595	20M QPSK(50,24)	0.197	0.095	-4.95	22.98	23.50	0.222	2022/12/08	
Back Side	40640/2595	20M QPSK(50,24)	0.312	0.137	0.83	22.98	23.50	0.352	2022/12/08	
Left Side	40640/2595	20M QPSK(50,24)	0.091	0.038	0.29	22.98	23.50	0.103	2022/12/08	
Right Side	40640/2595	20M QPSK(50,24)	0.095	0.046	-0.52	22.98	23.50	0.107	2022/12/08	
Bottom Side	40640/2595	20M QPSK(50,24)	0.165	0.069	-0.11	22.98	23.50	0.186	2022/12/08	

NOTE: Hotspot SAR test results of LTE Band 25

10.1.15. SAR measurement Result of WLAN 2.4G

Test Position of Head	Test channel /Freq	Mode	SAR Value (W/kg)		Power Drift(%)	Conducted Power (dBm)	Tune-up Power (dBm)	Scaled SAR 1-g (W/Kg)	Date	Plot
			1-g	10-g						
Left Cheek	1/2412	802.11b	0.359	0.179	-0.35	15.77	16.00	0.379	2022/12/02	15#
Left Tilt 15 Degree	1/2412	802.11b	0.195	0.097	-0.39	15.77	16.00	0.206	2022/12/02	

Right Cheek	1/2412	802.11b	0.327	0.160	-1.66	15.77	16.00	0.345	2022/12/02	
Right Tilt 15 Degree	1/2412	802.11b	0.159	0.075	-1.84	15.77	16.00	0.168	2022/12/02	

NOTE: Head SAR test results of WLAN 2.4G

Test Position of Body-Worn with 10mm	Test channel /Freq.	Mode	SAR Value (W/kg)		Power Drift(%)	Conducted Power (dBm)	Tune-up Power (dBm)	Scaled SAR 1-g (W/Kg)	Date	Plot
			1-g	10-g						
Front Side	1/2412	802.11b	0.072	0.043	-2.33	15.77	16.00	0.076	2022/12/02	
Back Side	1/2412	802.11b	0.087	0.052	-1.25	15.77	16.00	0.092	2022/12/02	16#

NOTE: Body-Worn SAR test results of WLAN 2.4G

Test Position of Hotspot with 10mm	Test channel /Freq.	Mode	SAR Value (W/kg)		Power Drift(%)	Conducted Power (dBm)	Tune-up Power (dBm)	Scaled SAR 1-g (W/Kg)	Date	Plot
			1-g	10-g						
Front Side	1/2412	802.11b	0.072	0.043	-2.33	15.77	16.00	0.076	2022/12/02	
Back Side	1/2412	802.11b	0.087	0.052	-1.25	15.77	16.00	0.092	2022/12/02	16#
Right Side	1/2412	802.11b	0.036	0.021	1.65	15.77	16.00	0.038	2022/12/02	
Top Side	1/2412	802.11b	0.027	0.016	-0.99	15.77	16.00	0.028	2022/12/02	

NOTE: Hotspot SAR test results of WLAN 2.4G

10.1.16. SAR measurement Result of WLAN 5.2G

Test Position of Head	Test channel /Freq	Mode	SAR Value (W/kg)		Power Drift(%)	Conducted Power (dBm)	Tune-up Power (dBm)	Scaled SAR 1-g (W/Kg)	Date	Plot
			1-g	10-g						
Left Cheek	36/5180	802.11a	0.376	0.169	-1.08	10.254	10.500	0.398	2022/12/07	11#
Left Tilt 15 Degree	36/5180	802.11a	0.250	0.094	-2.35	10.254	10.500	0.265	2022/12/07	
Right Cheek	36/5180	802.11a	0.340	0.147	0.00	10.254	10.500	0.360	2022/12/07	
Right Tilt 15 Degree	36/5180	802.11a	0.213	0.081	1.75	10.254	10.500	0.225	2022/12/07	

NOTE: Head SAR test results of WLAN 5.2G

Test Position of Body-Worn with 10mm	Test channel /Freq.	Mode	SAR Value (W/kg)		Power Drift(%)	Conducted Power (dBm)	Tune-up Power (dBm)	Scaled SAR 1-g (W/Kg)	Date	Plot
			1-g	10-g						

Front Side	36/5180	802.11a	0.168	0.080	-2.45	10.254	10.500	0.178	2022/12/07	
Back Side	36/5180	802.11a	0.257	0.125	3.76	10.254	10.500	0.272	2022/12/07	13#

NOTE: Body-Worn SAR test results of WLAN 5.2G

Test Position of Hotspot with 10mm	Test channel /Freq.	Mode	SAR Value (W/kg)		Power Drift(%)	Conducted Power (dBm)	Tune-up Power (dBm)	Scaled SAR 1-g (W/Kg)	Date	Plot
			1-g	10-g						
Front Side	36/5180	802.11a	0.168	0.080	-2.45	10.254	10.500	0.178	2022/12/07	
Back Side	36/5180	802.11a	0.257	0.125	3.76	10.254	10.500	0.272	2022/12/07	13#
Right Side	36/5180	802.11a	0.081	0.039	2.04	10.254	10.500	0.086	2022/12/07	
Top Side	36/5180	802.11a	0.078	0.037	-1.08	10.254	10.500	0.083	2022/12/07	

NOTE: Hotspot SAR test results of WLAN 5.2G

10.1.17. SAR measurement Result of WLAN 5.8G

Test Position of Head	Test channel /Freq	Mode	SAR Value (W/kg)		Power Drift(%)	Conducted Power (dBm)	Tune-up Power (dBm)	Scaled SAR 1-g (W/Kg)	Date	Plot
			1-g	10-g						
Left Cheek	155/5775	802.11ac VHT80	0.323	0.126	-2.20	10.658	11.000	0.349	2022/12/06	12#
Left Tilt 15 Degree	155/5775	802.11ac VHT80	0.185	0.071	-0.86	10.658	11.000	0.200	2022/12/06	
Right Cheek	155/5775	802.11ac VHT80	0.301	0.115	-1.23	10.658	11.000	0.326	2022/12/06	
Right Tilt 15 Degree	155/5775	802.11ac VHT80	0.142	0.055	0.17	10.658	11.000	0.154	2022/12/06	

NOTE: Head SAR test results of WLAN 5.8G

Test Position of Body-Worn with 10mm	Test channel /Freq.	Mode	SAR Value (W/kg)		Power Drift(%)	Conducted Power (dBm)	Tune-up Power (dBm)	Scaled SAR 1-g (W/Kg)	Date	Plot
			1-g	10-g						
Front Side	155/5775	802.11ac VHT80	0.168	0.082	-3.27	10.658	11.000	0.182	2022/12/06	
Back Side	155/5775	802.11ac VHT80	0.248	0.122	-2.27	10.658	11.000	0.268	2022/12/06	14#

NOTE: Body-Worn SAR test results of WLAN 5.8G

Test Position of Hotspot with 10mm	Test channel /Freq.	Mode	SAR Value (W/kg)		Power Drift(%)	Conducted Power (dBm)	Tune-up Power (dBm)	Scaled SAR 1-g (W/Kg)	Date	Plot
			1-g	10-g						
Front Side	155/5775	802.11ac VHT80	0.168	0.082	-3.27	10.658	11.000	0.182	2022/12/06	
Back Side	155/5775	802.11ac VHT80	0.248	0.122	-2.27	10.658	11.000	0.268	2022/12/06	14#
Right Side	155/5775	802.11ac VHT80	0.084	0.040	-0.32	10.658	11.000	0.091	2022/12/06	
Top Side	155/5775	802.11ac VHT80	0.075	0.035	3.32	10.658	11.000	0.081	2022/12/06	

NOTE: Hotspot SAR test results of WLAN 5.8G

10.2. Simultaneous Transmission Analysis

Per KDB 447498 D01, simultaneous transmission SAR is compliant if,

- 1) Scalar SAR summation < 1.6W/kg.
- 2) $SPLSR = (SAR_1 + SAR_2)^{1.5} / (\text{min. separation distance, mm})$, and the peak separation distance is determined from the square root of $[(x_1-x_2)^2 + (y_1-y_2)^2 + (z_1-z_2)^2]$, where (x_1, y_1, z_1) and (x_2, y_2, z_2) are the coordinates of the extrapolated peak SAR locations in the zoom scan. If $SPLSR \leq 0.04$, simultaneously transmission SAR measurement is not necessary.

Test Position		Scaled SAR _{MAX}		Σ 1-g SAR (W/Kg)	SPLSR	Remark
		WWAN	DTS			
Head	Left Cheek	1.196	0.379	1.575	N/A	N/A
	Left Tilt 15 Degree	0.679	0.206	0.885	N/A	N/A
	Right Cheek	1.095	0.345	1.440	N/A	N/A
	Right Tilt 15 Degree	0.589	0.168	0.757	N/A	N/A
Body-Worn	Front Side	0.564	0.076	0.640	N/A	N/A
	Back Side	1.065	0.092	1.157	N/A	N/A
Hotspot	Front Side	0.564	0.076	0.640	N/A	N/A
	Back Side	1.065	0.092	1.157	N/A	N/A
	Left Side	0.285	N/A	0.285	N/A	N/A
	Right Side	0.279	0.038	0.317	N/A	N/A
	Top Side	N/A	0.028	0.028	N/A	N/A

	Bottom Side	0.460	N/A	0.460	N/A	N/A
--	-------------	-------	-----	-------	-----	-----

Test Position		Scaled SAR _{MAX}		Σ 1-g SAR (W/Kg)	SPLSR	Remark
		WWAN	NII			
Head	Left Cheek	1.196	0.398	1.594	N/A	N/A
	Left Tilt 15 Degree	0.679	0.265	0.944	N/A	N/A
	Right Cheek	1.095	0.360	1.455	N/A	N/A
	Right Tilt 15 Degree	0.589	0.225	0.814	N/A	N/A
Body-Worn	Front Side	0.564	0.182	0.746	N/A	N/A
	Back Side	1.065	0.272	1.337	N/A	N/A
Hotspot	Front Side	0.564	0.182	0.746	N/A	N/A
	Back Side	1.065	0.272	1.337	N/A	N/A
	Left Side	0.285	N/A	0.285	N/A	N/A
	Right Side	0.279	0.091	0.370	N/A	N/A
	Top Side	N/A	0.083	0.083	N/A	N/A
	Bottom Side	0.460	N/A	0.460	N/A	N/A

Test Position		Scaled SAR _{MAX}		Σ 1-g SAR (W/Kg)	SPLSR	Remark
		WWAN	DSS			
Head	Left Cheek	1.196	0.167	1.363	N/A	N/A
	Left Tilt 15 Degree	0.679	0.167	0.846	N/A	N/A
	Right Cheek	1.095	0.167	1.262	N/A	N/A
	Right Tilt 15 Degree	0.589	0.167	0.756	N/A	N/A
Body-Worn	Front Side	0.564	0.084	0.648	N/A	N/A
	Back Side	1.065	0.084	1.149	N/A	N/A
Hotspot	Front Side	0.564	0.084	0.648	N/A	N/A
	Back Side	1.065	0.084	1.149	N/A	N/A
	Left Side	0.285	N/A	0.285	N/A	N/A
	Right Side	0.279	0.084	0.363	N/A	N/A
	Top Side	N/A	0.084	0.084	N/A	N/A

	Bottom Side	0.460	N/A	0.460	N/A	N/A
--	----------------	-------	-----	-------	-----	-----

11. Appendix A. Photo documentation

Refer to appendix Test Setup photo---SAR

12. Appendix B. System Check Plots

Table of contents
MEASUREMENT 1 System Performance Check - 750MHz
MEASUREMENT 2 System Performance Check - 835MHz
MEASUREMENT 3 System Performance Check - 1800MHz
MEASUREMENT 4 System Performance Check - 1900MHz
MEASUREMENT 5 System Performance Check - 2450MHz
MEASUREMENT 6 System Performance Check - 2600MHz
MEASUREMENT 7 System Performance Check - 5200MHz
MEASUREMENT 8 System Performance Check - 5800MHz

MEASUREMENT 1

Date of measurement: 13/12/2022

A. Experimental conditions.

Area Scan	<u>dx=15mm dy=15mm, h= 5.00 mm</u>
ZoomScan	<u>5x5x7, dx=8mm dy=8mm dz=5mm</u>
Phantom	<u>Validation plane</u>
Device Position	<u>Dipole</u>
Band	<u>CW750</u>
Channels	<u>Middle</u>
Signal	<u>CW (Crest factor: 1.0)</u>
ConvF	<u>1.49</u>

B. SAR Measurement Results

Frequency (MHz)	750.000000
Relative permittivity (real part)	40.638519
Relative permittivity (imaginary part)	21.482917
Conductivity (S/m)	0.895122
Variation (%)	2.730000

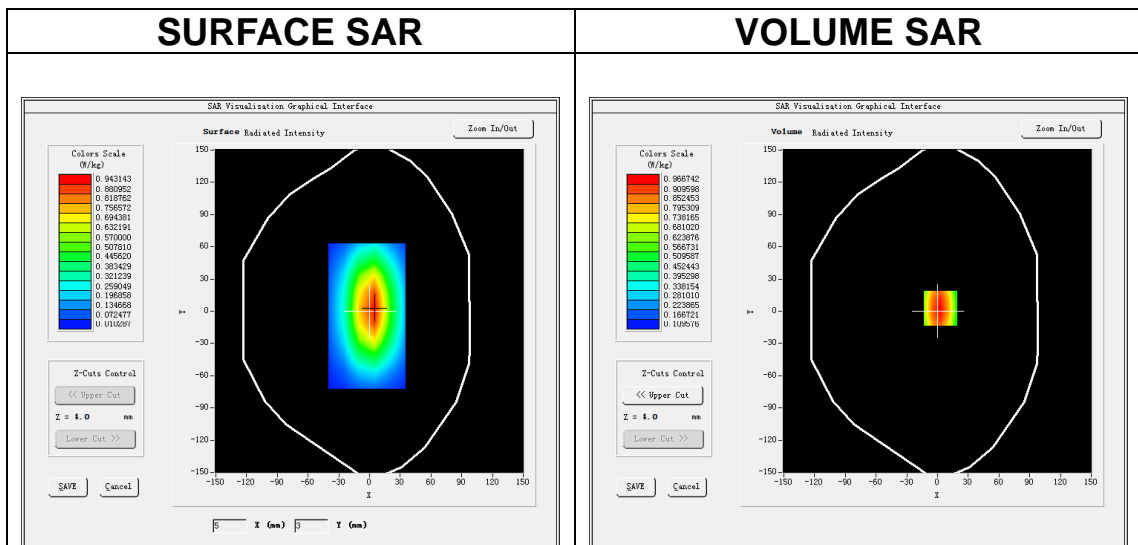

Maximum location: X=3.00, Y=3.00
SAR Peak: 1.30 W/kg

SAR 10g (W/Kg)	0.510332
SAR 1g (W/Kg)	0.892321

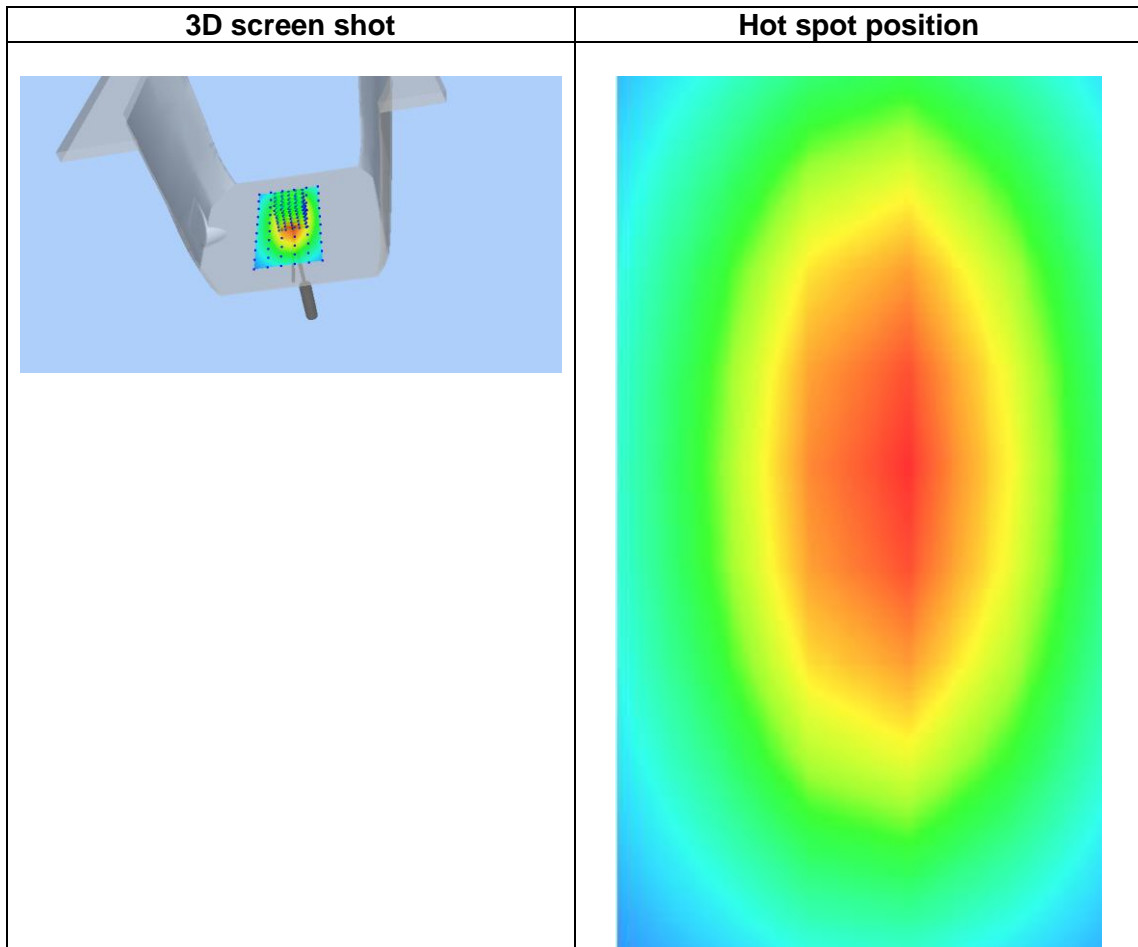
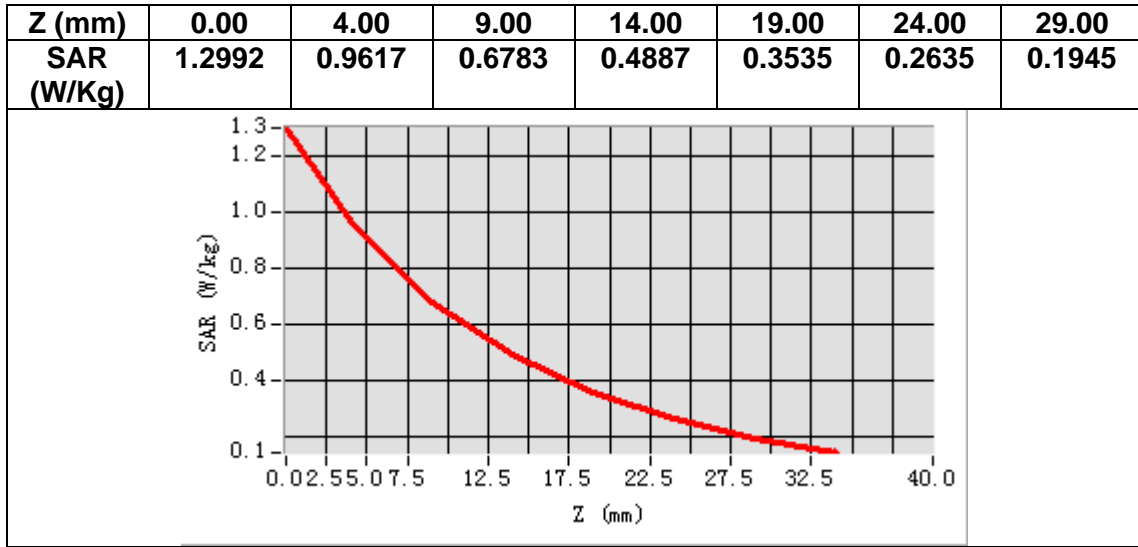

MEASUREMENT 2

Date of measurement: 12/12/2022

A. Experimental conditions.

Area Scan	<u>dx=15mm dy=15mm, h= 5.00 mm</u>
ZoomScan	<u>5x5x7, dx=8mm dy=8mm dz=5mm</u>
Phantom	<u>Validation plane</u>
Device Position	<u>Dipole</u>
Band	<u>CW835</u>
Channels	<u>Middle</u>
Signal	<u>CW (Crest factor: 1.0)</u>
ConvF	<u>1.50</u>

B. SAR Measurement Results

Frequency (MHz)	835.000000
Relative permittivity (real part)	41.375076
Relative permittivity (imaginary part)	20.103582
Conductivity (S/m)	0.932583
Variation (%)	-2.720000

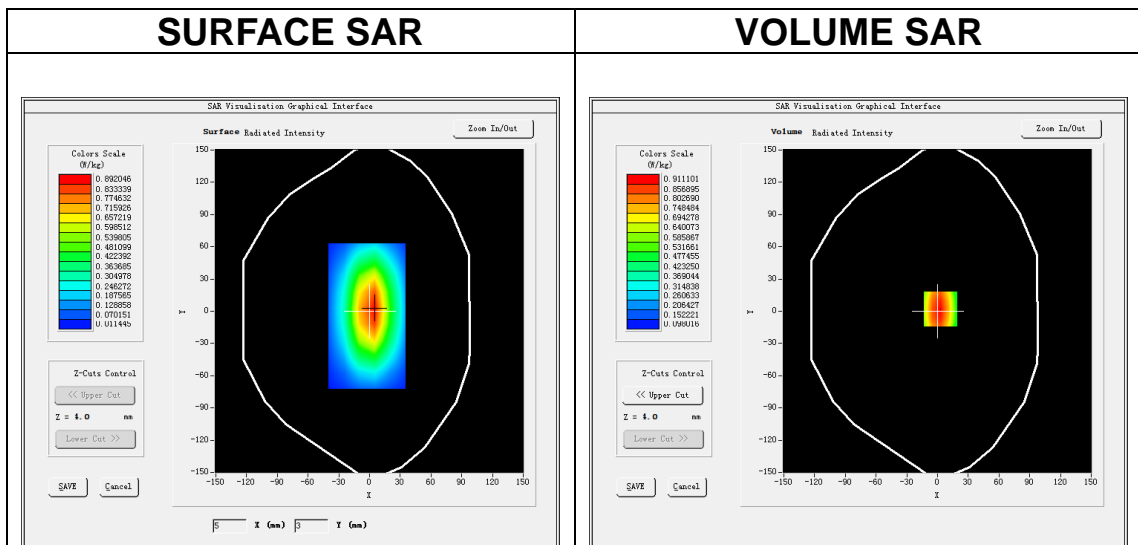

Maximum location: X=3.00, Y=2.00
SAR Peak: 1.23 W/kg

SAR 10g (W/Kg)	0.664333
SAR 1g (W/Kg)	1.001172

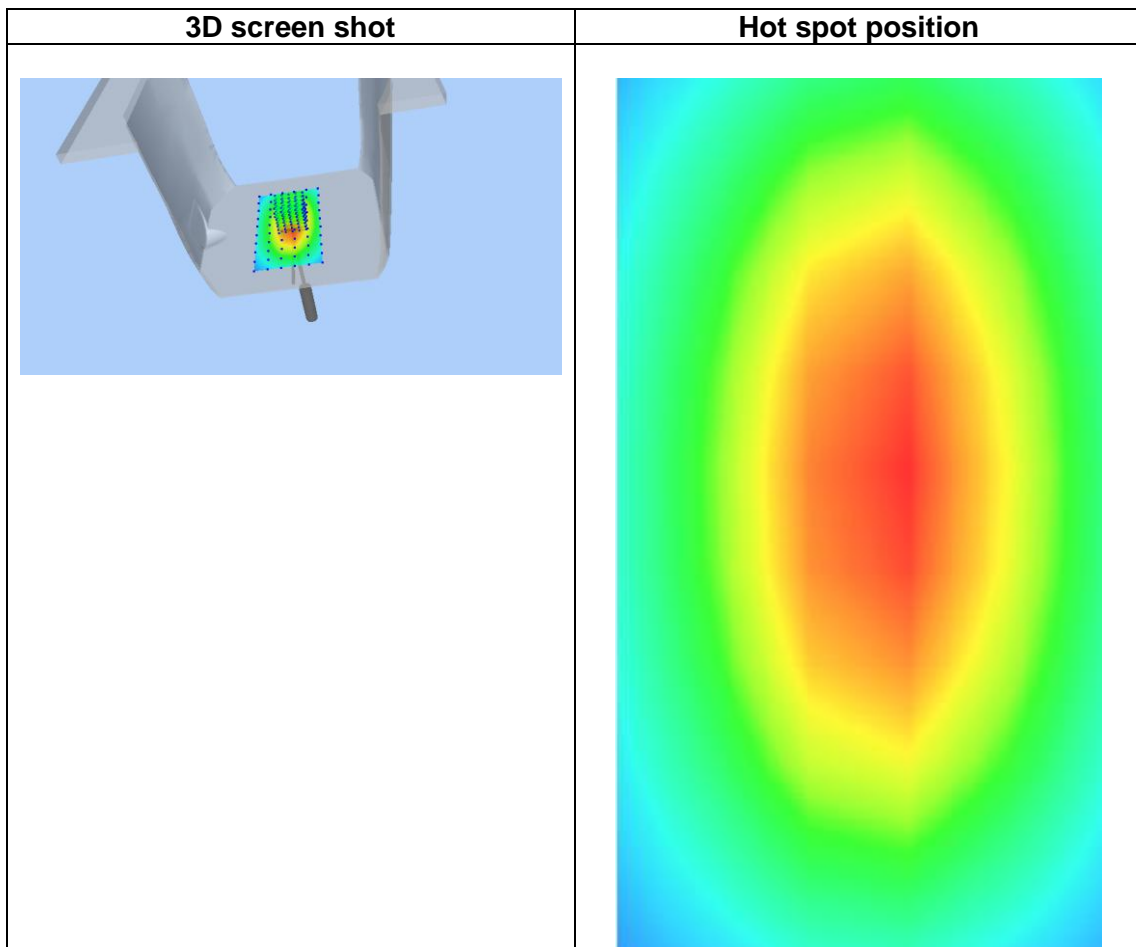
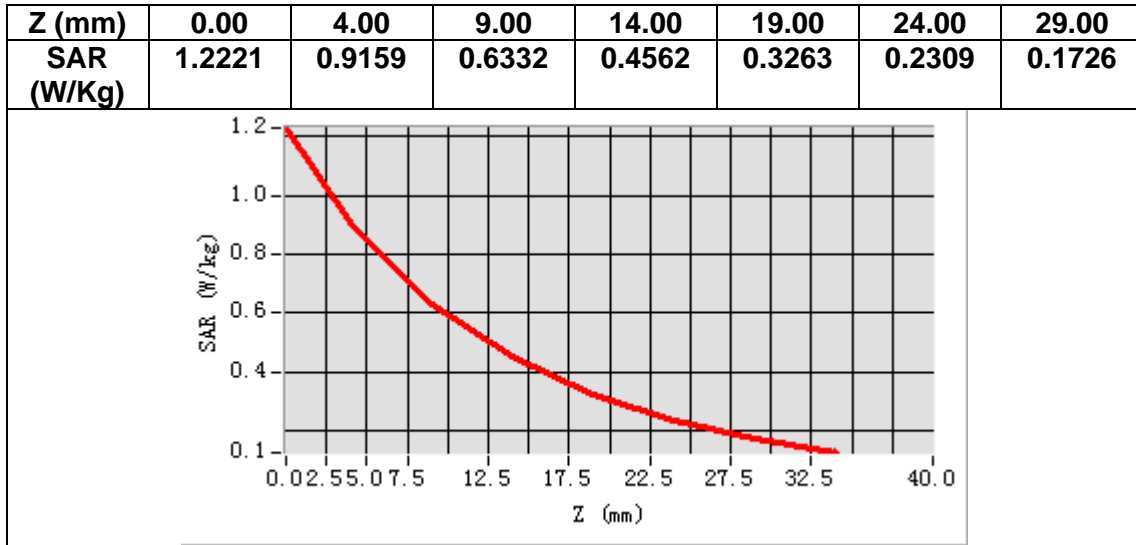

MEASUREMENT 3

Date of measurement: 6/12/2022

A. Experimental conditions.

Area Scan	<u>dx=15mm dy=15mm, h= 5.00 mm</u>
ZoomScan	<u>5x5x7, dx=8mm dy=8mm dz=5mm</u>
Phantom	<u>Validation plane</u>
Device Position	<u>Dipole</u>
Band	<u>CW1800</u>
Channels	<u>Middle</u>
Signal	<u>CW (Crest factor: 1.0)</u>
ConvF	<u>1.73</u>

B. SAR Measurement Results

Frequency (MHz)	1800.000000
Relative permittivity (real part)	38.921625
Relative permittivity (imaginary part)	13.904764
Conductivity (S/m)	1.390476
Variation (%)	2.980000

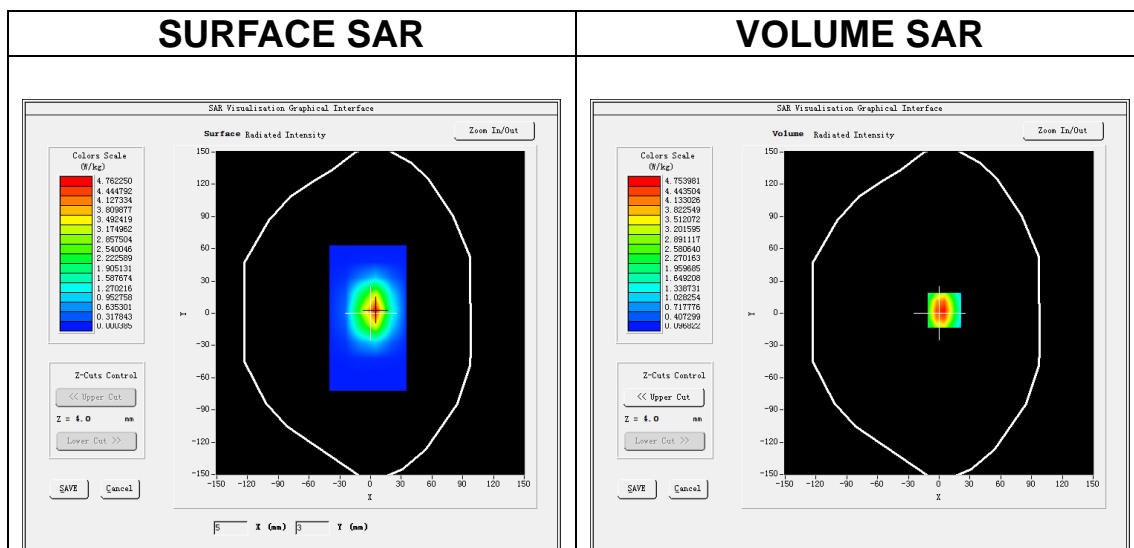

Maximum location: X=5.00, Y=3.00
SAR Peak: 7.59 W/kg

SAR 10g (W/Kg)	1.849307
SAR 1g (W/Kg)	4.069066

Z (mm)	0.00	4.00	9.00	14.00	19.00	24.00	29.00
SAR (W/Kg)	7.3874	4.7511	2.7029	1.6103	0.9672	0.5831	0.3534

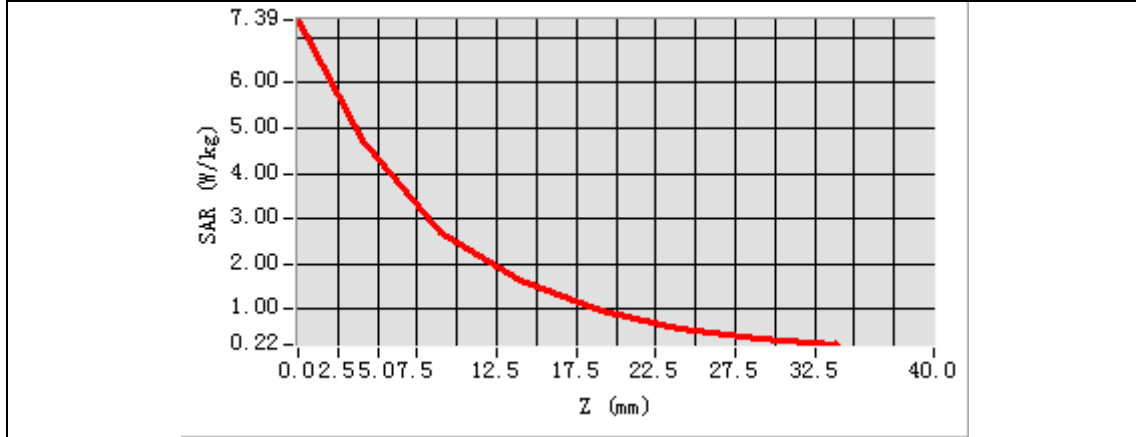

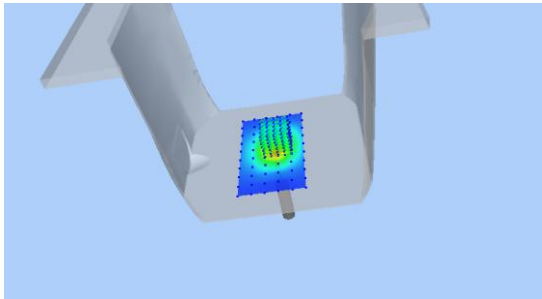
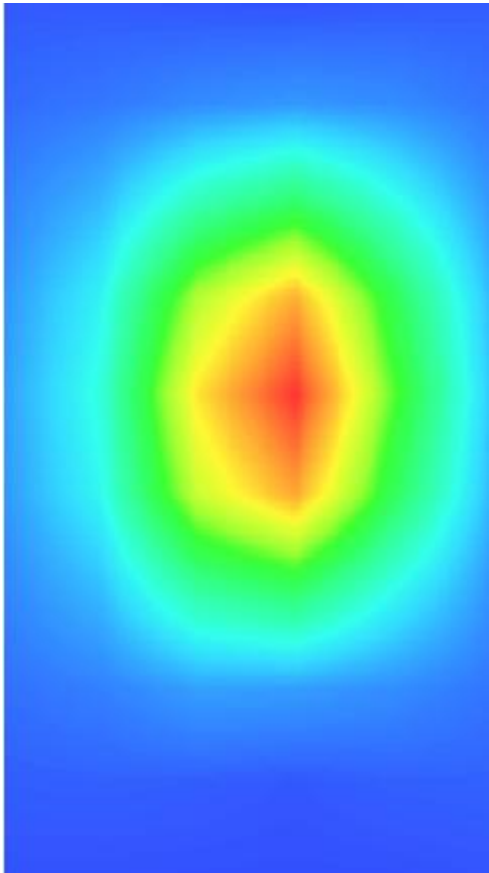
3D screen shot	Hot spot position
	

MEASUREMENT 4

Date of measurement: 9/12/2022

A. Experimental conditions.

Area Scan	<u>dx=15mm dy=15mm, h= 5.00 mm</u>
ZoomScan	<u>5x5x7, dx=8mm dy=8mm dz=5mm</u>
Phantom	<u>Validation plane</u>
Device Position	<u>Dipole</u>
Band	<u>CW1900</u>
Channels	<u>Middle</u>
Signal	<u>CW (Crest factor: 1.0)</u>
ConvF	<u>1.91</u>

B. SAR Measurement Results

Frequency (MHz)	1900.000000
Relative permittivity (real part)	38.779690
Relative permittivity (imaginary part)	13.744798
Conductivity (S/m)	1.450840
Variation (%)	2.220000

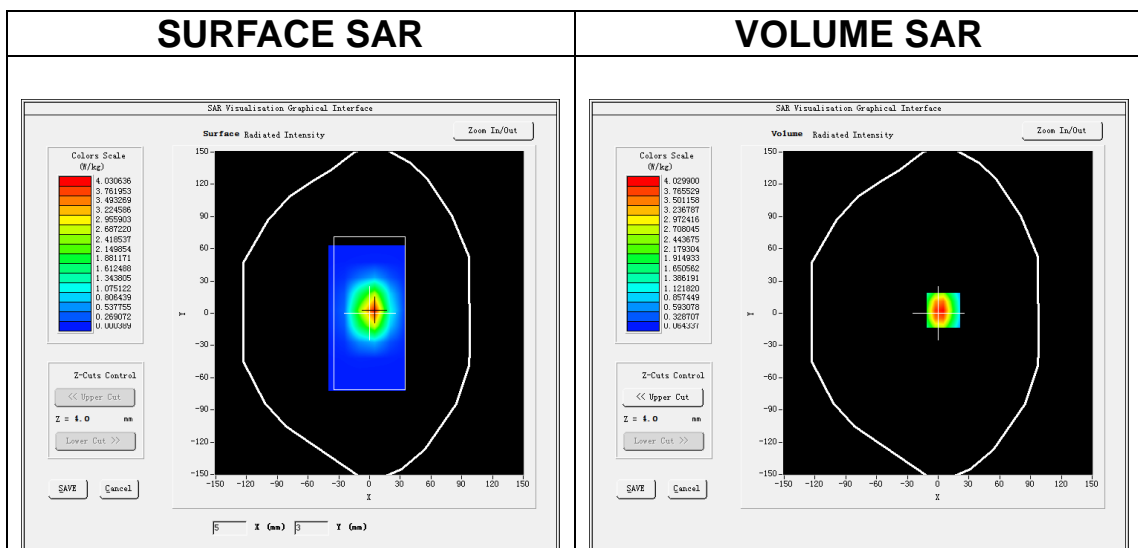

Maximum location: X=5.00, Y=3.00
SAR Peak: 6.57 W/kg

SAR 10g (W/Kg)	2.126347
SAR 1g (W/Kg)	3.909221

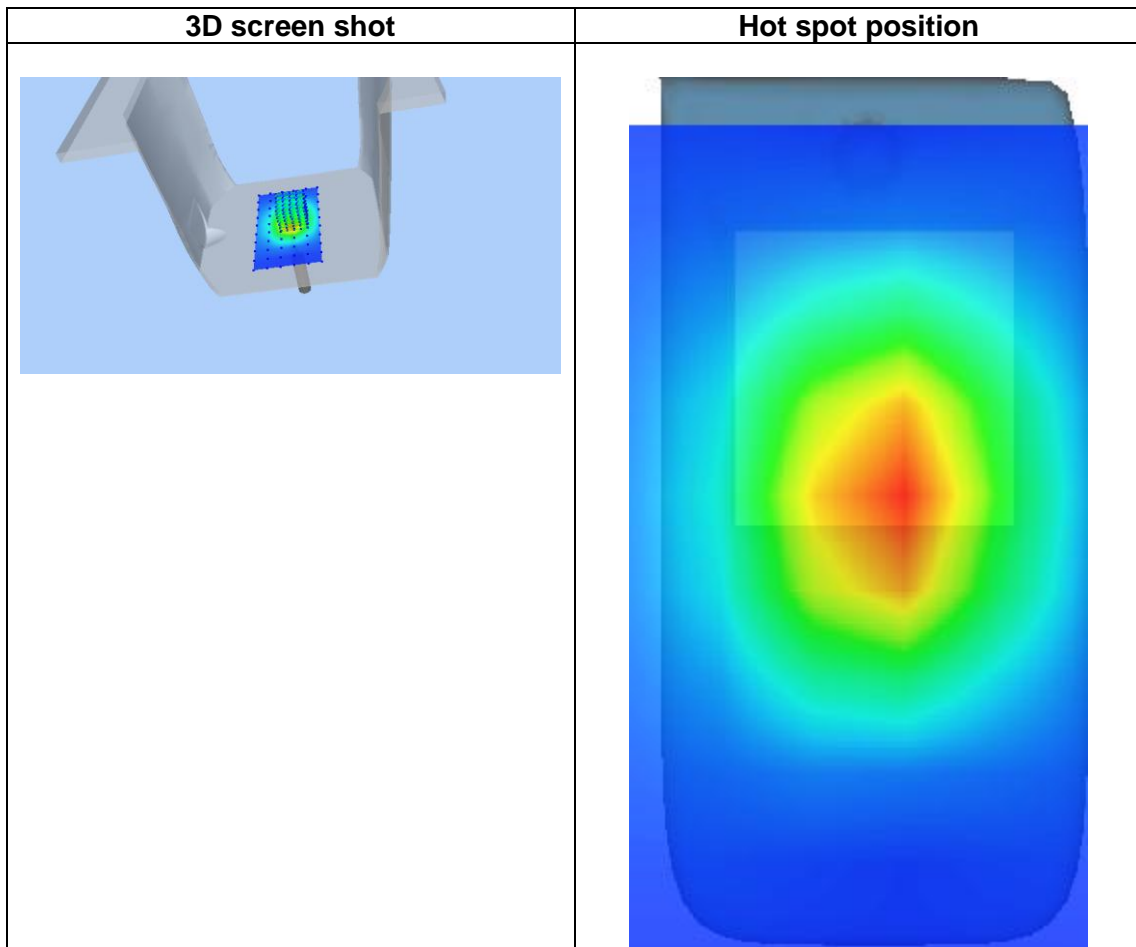
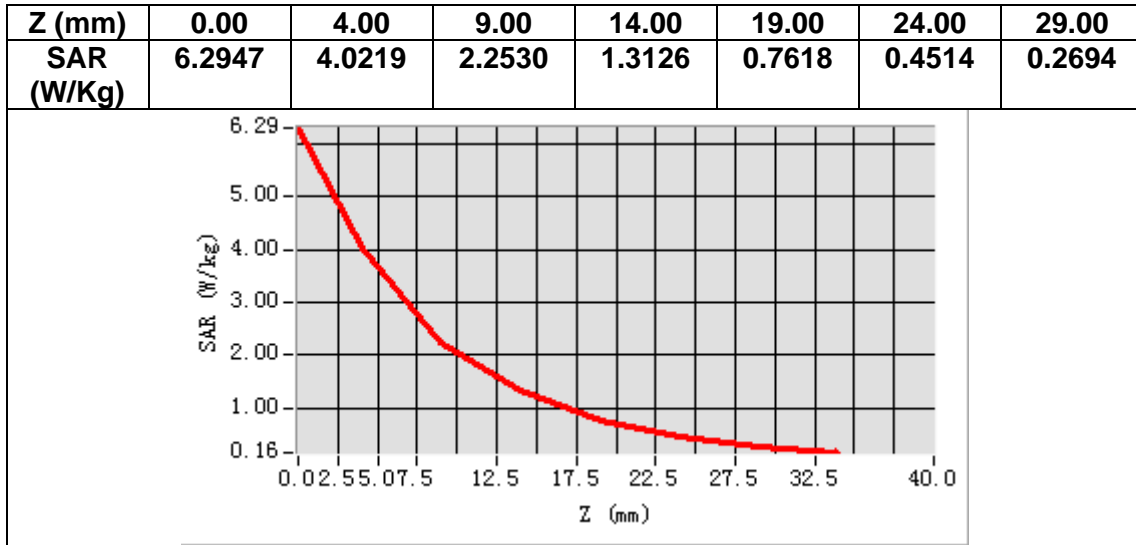

MEASUREMENT 5

Date of measurement: 2/12/2022

A. Experimental conditions.

Area Scan	<u>dx=12mm dy=12mm, h= 5.00 mm</u>
ZoomScan	<u>7x7x7, dx=5mm dy=5mm dz=5mm</u>
Phantom	<u>Validation plane</u>
Device Position	<u>Dipole</u>
Band	<u>CW2450</u>
Channels	<u>Middle</u>
Signal	<u>CW (Crest factor: 1.0)</u>
ConvF	<u>1.98</u>

B. SAR Measurement Results

Frequency (MHz)	2450.000000
Relative permittivity (real part)	37.999996
Relative permittivity (imaginary part)	13.429765
Conductivity (S/m)	1.827940
Variation (%)	1.290000

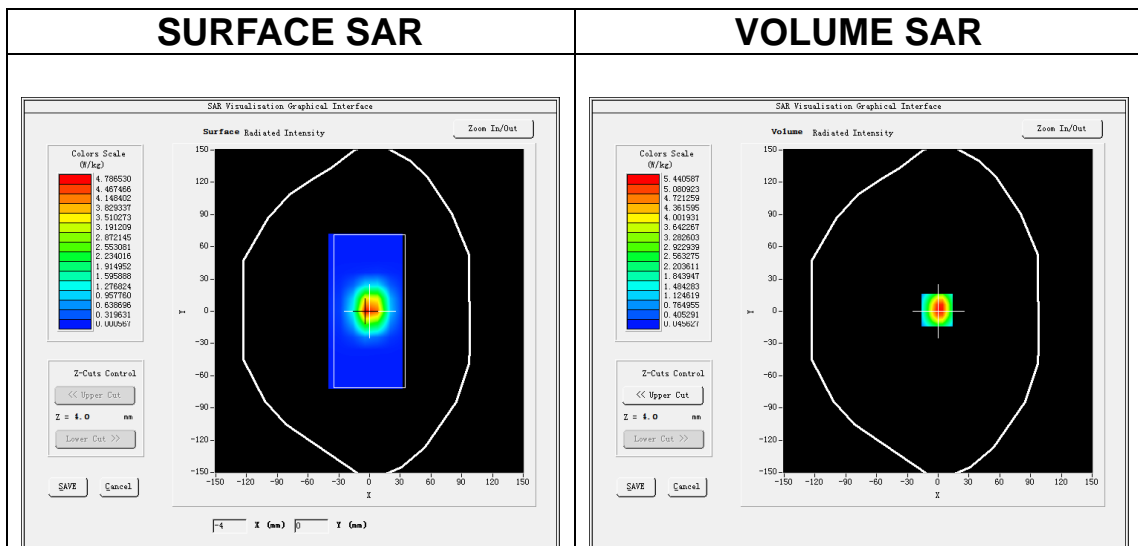

Maximum location: X=-1.00, Y=1.00

SAR Peak: 8.94 W/kg

SAR 10g (W/Kg)	2.219106
SAR 1g (W/Kg)	5.828340

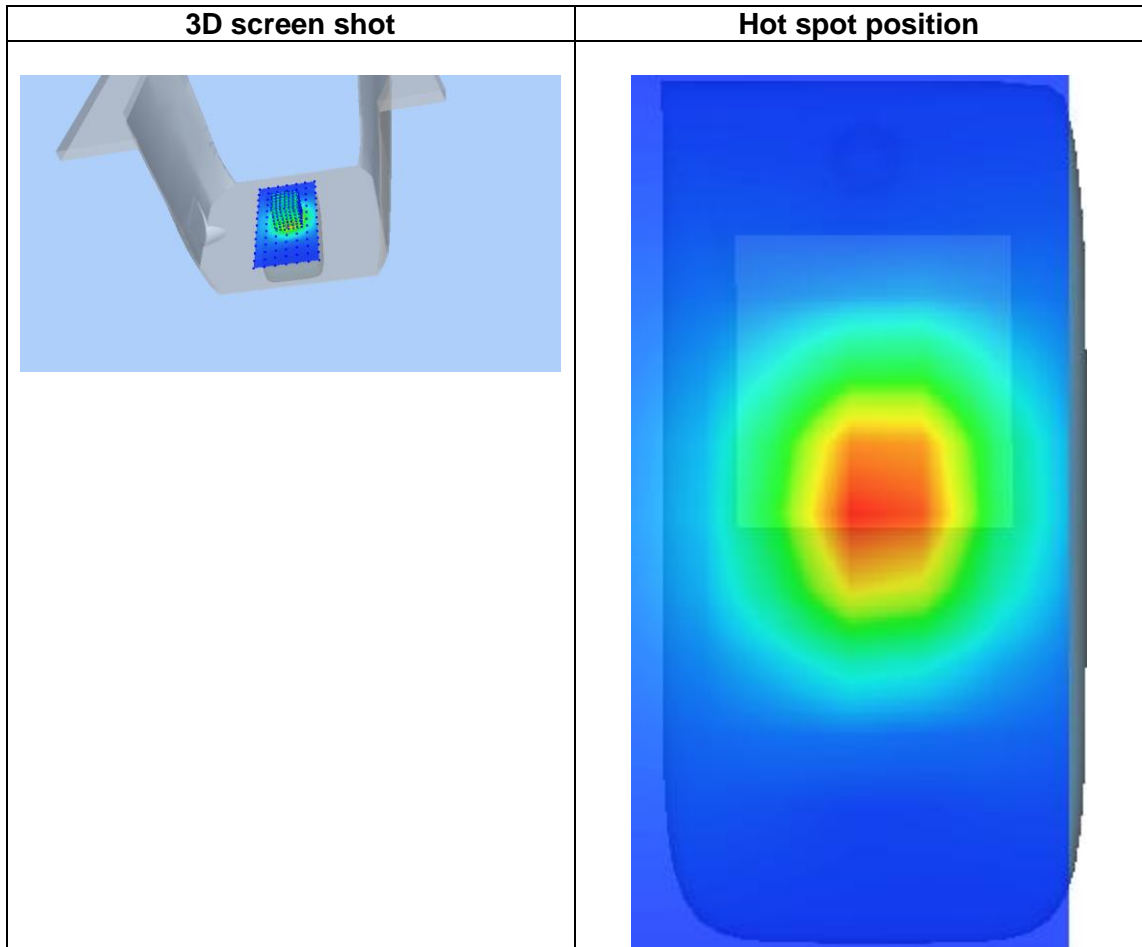
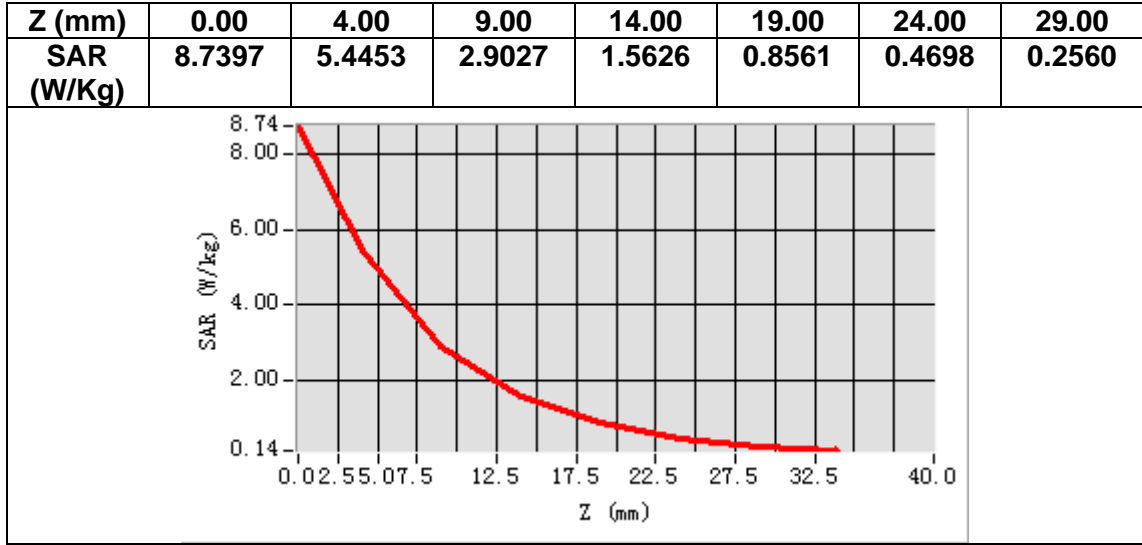

MEASUREMENT 6

Date of measurement: 8/12/2022

A. Experimental conditions.

Area Scan	<u>dx=12mm dy=12mm, h= 5.00 mm</u>
ZoomScan	<u>7x7x7, dx=5mm dy=5mm dz=5mm</u>
Phantom	<u>Validation plane</u>
Device Position	<u>Dipole</u>
Band	<u>CW2600</u>
Channels	<u>Middle</u>
Signal	<u>CW (Crest factor: 1.0)</u>
ConvF	<u>1.87</u>

B. SAR Measurement Results

Frequency (MHz)	2600.000000
Relative permittivity (real part)	38.081805
Relative permittivity (imaginary part)	13.711922
Conductivity (S/m)	1.980611
Variation (%)	0.250000

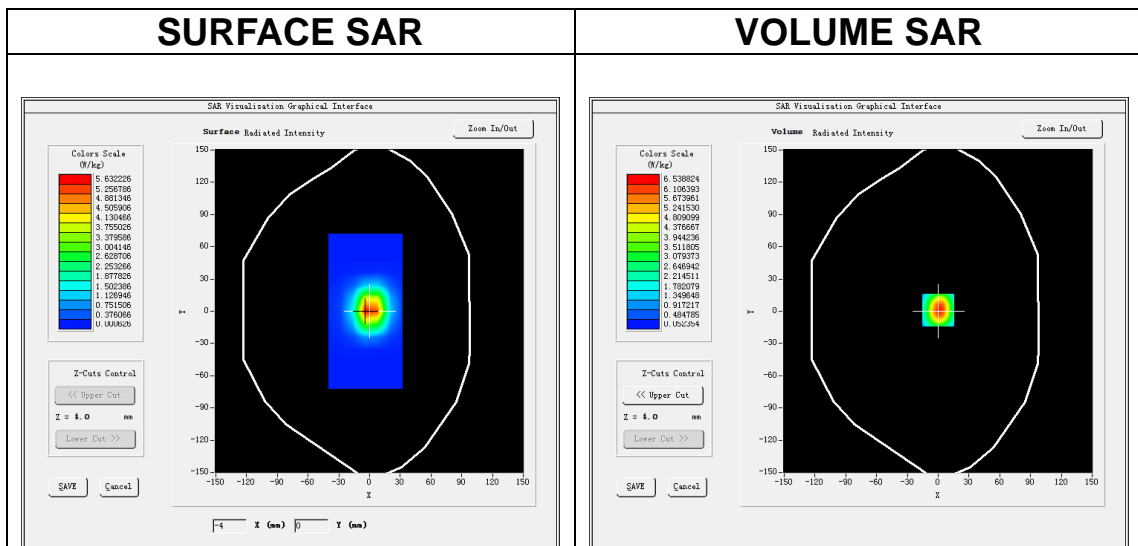

Maximum location: X=0.00, Y=1.00

SAR Peak: 10.67 W/kg

SAR 10g (W/Kg)	2.492037
SAR 1g (W/Kg)	5.510199

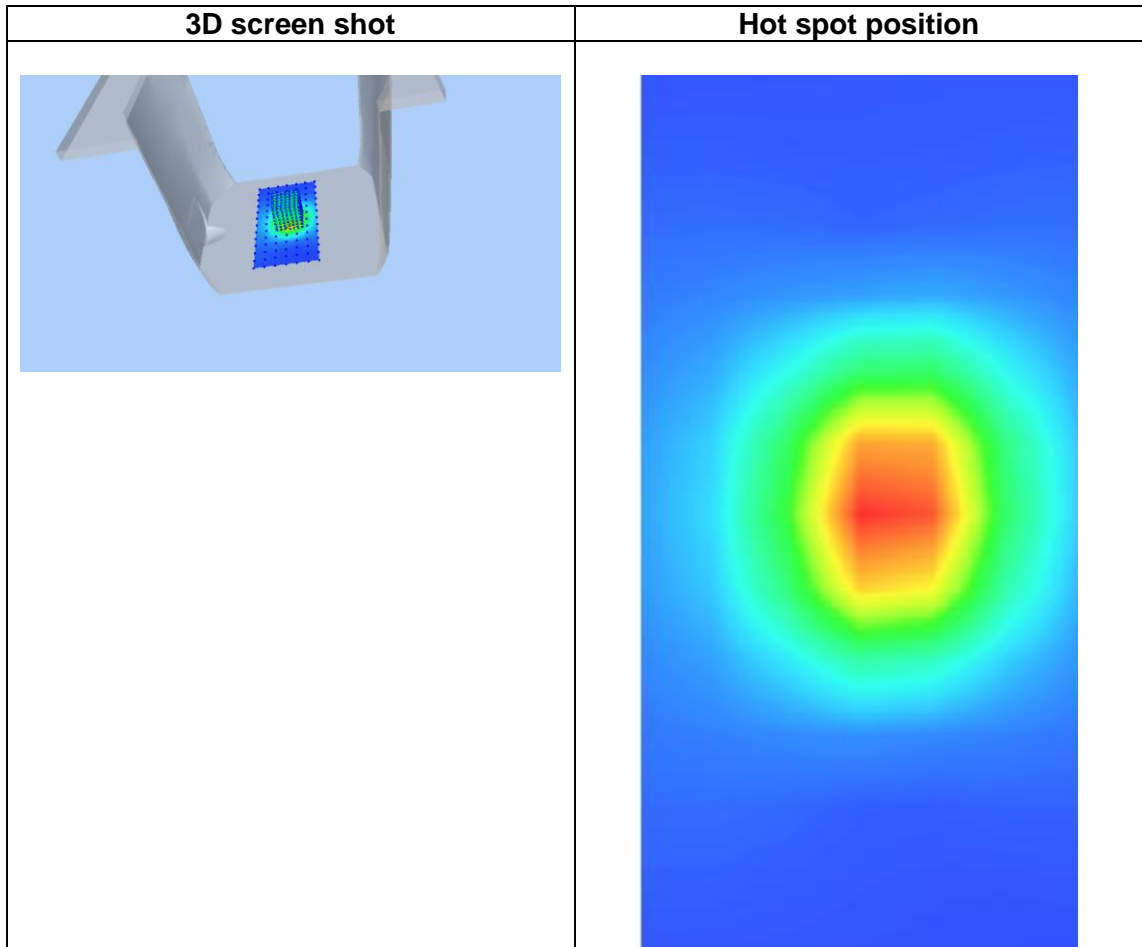
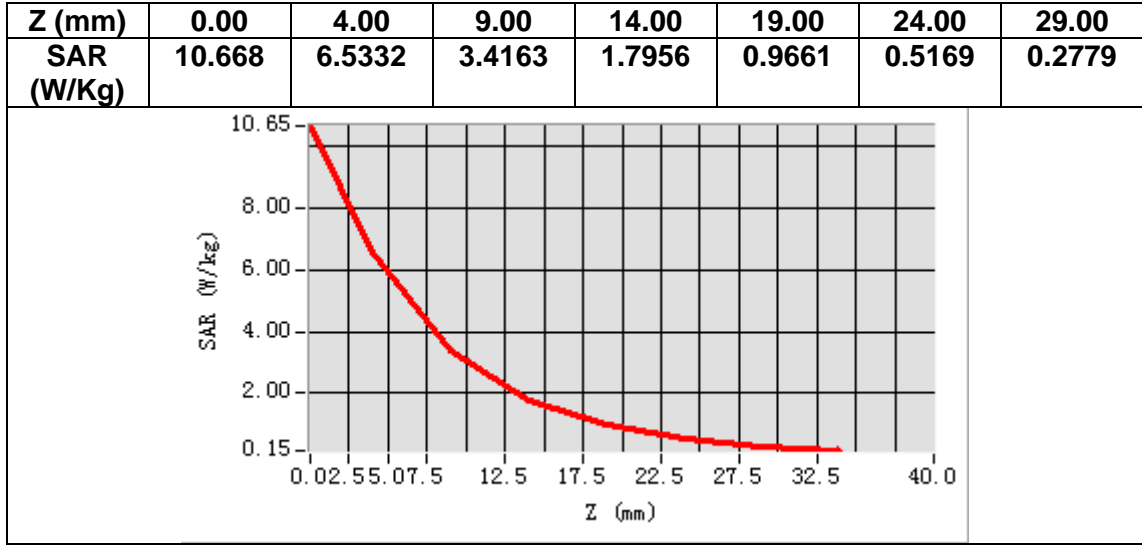

MEASUREMENT 7

Date of measurement: 7/12/2022

A. Experimental conditions.

Area Scan	<u>dx=10mm dy=10mm, h= 2.00 mm</u>
ZoomScan	<u>7x7x12,dx=4mm dy=4mm dz=2mm</u>
Phantom	<u>Validation plane</u>
Device Position	<u>Dipole</u>
Band	<u>CW5200</u>
Channels	<u>Middle</u>
Signal	<u>CW (Crest factor: 1.0)</u>
ConvF	<u>1.80</u>

B. SAR Measurement Results

Frequency (MHz)	5200.000000
Relative permittivity (real part)	35.929973
Relative permittivity (imaginary part)	16.578381
Conductivity (S/m)	4.789310
Variation (%)	2.800000

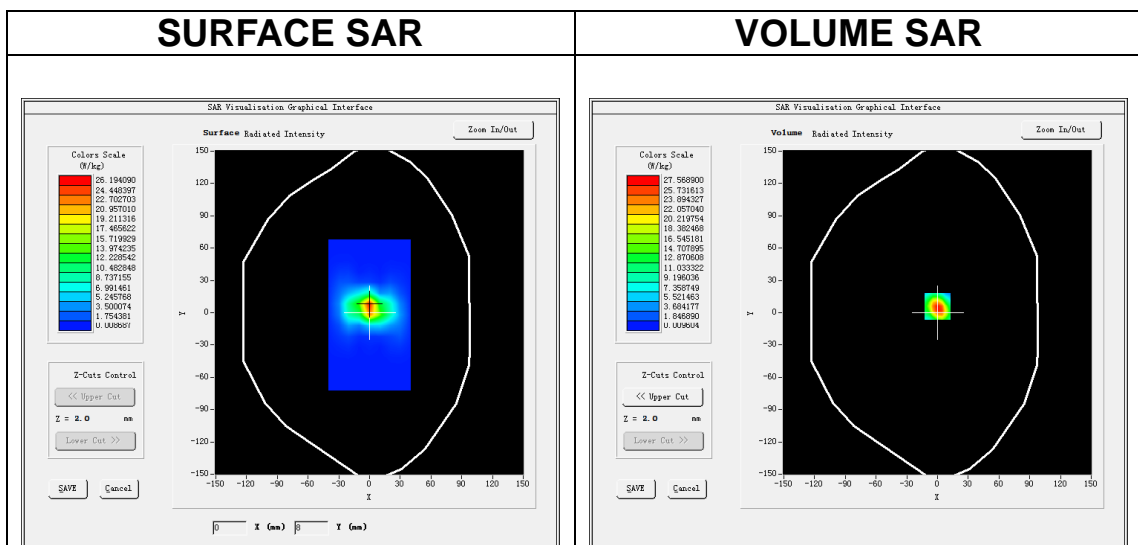

Maximum location: X=0.00, Y=6.00

SAR Peak: 49.61 W/kg

SAR 10g (W/Kg)	6.008162
SAR 1g (W/Kg)	16.027032

Z (m)	0.00	2.00	4.00	6.00	8.00	10.00	12.00	14.00	16.00	18.00	20.00	22.00
SAR (W/Kg)	46.691	27.591	14.077	7.0594	3.5991	1.7843	0.8950	0.4637	0.2402	0.1308	0.0627	0.0497

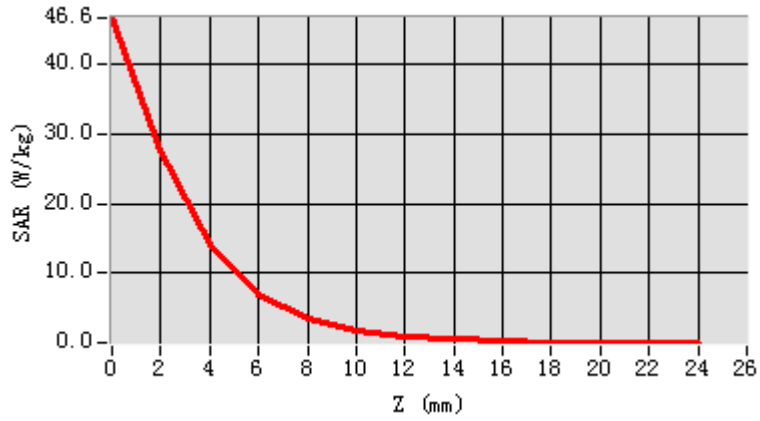

3D screen shot

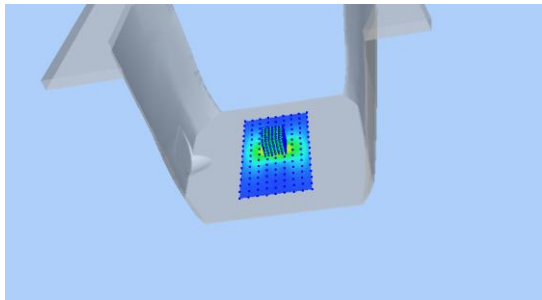

Hot spot position

