

# TEST REPORT

**Applicant:** SHENZHEN 8BITDO TECH CO., LTD.  
**Address:** Room 210, Building 1, Nanhai Ecool, No.6 Xinghua Road, Shekou, Nanshan District, Shenzhen, Guangdong, P.R. China  
**Equipment Type:** 8BitDo Ultimate Wired Controller for Xbox  
**Model Name:** 82CE (refer section 2.4)  
**Brand Name:** 8BITDO  
**FCC ID:** 2AOWF-ULTIMATEX  
**Test Standard:** 47 CFR Part 15 Subpart C (refer section 3.1)  
**Test Date:** Apr. 11, 2022 - Jun. 24, 2022  
**Date of Issue:** Jul. 19, 2022

**ISSUED BY:**

Shenzhen BALUN Technology Co., Ltd.

**Tested by:** Julie Zhu

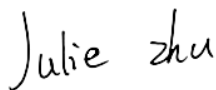

**Checked by:** Ye Hongji



**Approved by:** Liao Jianming

(Technical Director)



### Revision History

Version	Issue Date	Revisions
<u>Rev. 01</u>	<u>Jul. 14, 2022</u>	<u>Initial Issue</u>
<u>Rev. 02</u>	<u>Jul. 19, 2022</u>	<u>Corrected the applicant address in Section 2.1, manufacturer address in Section 2.2, factory address in Section 2.3, product type in Section 2.5, and low channel power in Section A.1, and added serial number in Section 2.4.</u>

## TABLE OF CONTENTS

1	GENERAL INFORMATION .....	4
1.1	Identification of the Testing Laboratory .....	4
1.2	Identification of the Responsible Testing Location .....	4
2	PRODUCT INFORMATION .....	5
2.1	Applicant Information.....	5
2.2	Manufacturer Information .....	5
2.3	Factory Information .....	5
2.4	General Description for Equipment under Test (EUT) .....	5
2.5	Technical Information .....	6
2.6	Additional Instructions .....	7
3	SUMMARY OF TEST RESULTS.....	8
3.1	Test Standards .....	8
3.2	Test Verdict .....	8
4	GENERAL TEST CONFIGURATIONS.....	9
4.1	Test Environments .....	9
4.2	Test Equipment List.....	9
4.3	Test Software List.....	9
4.4	Measurement Uncertainty .....	10
4.5	Description of Test Setup .....	10
4.6	Measurement Results Explanation Example.....	13
5	TEST ITEMS.....	14

5.1	Antenna Requirements.....	14
5.2	Output Power .....	15
5.3	Occupied Bandwidth .....	17
5.4	Conducted Spurious Emission .....	18
5.5	Band Edge (Authorized-band band-edge).....	20
5.6	Conducted Emission .....	22
5.7	Radiated Spurious Emission .....	23
5.8	Band Edge (Restricted-band band-edge).....	28
5.9	Power Spectral density (PSD).....	29
ANNEX A	TEST RESULT .....	30
A.1	Output Power, Duty Cycle .....	30
A.2	Occupied Bandwidth .....	33
A.3	Conducted Spurious Emissions .....	36
A.4	Band Edge (Authorized-band band-edge).....	40
A.5	Conducted Emissions.....	43
A.6	Radiated Spurious Emission .....	45
A.7	Band Edge (Restricted-band band-edge).....	53
A.8	Power Spectral Density (PSD) .....	55
ANNEX B	TEST SETUP PHOTOS .....	56
ANNEX C	EUT EXTERNAL PHOTOS .....	56
ANNEX D	EUT INTERNAL PHOTOS .....	56

# 1 GENERAL INFORMATION

## 1.1 Identification of the Testing Laboratory

Company Name	Shenzhen BALUN Technology Co., Ltd.
Address	Block B, 1/F, Baisha Science and Technology Park, Shahe West Road, Nanshan District, ShenZhen, GuangDong Province, China
Phone Number	+86 755 6685 0100

## 1.2 Identification of the Responsible Testing Location

Test Location	Shenzhen BALUN Technology Co., Ltd.
Address	Block B, 1/F, Baisha Science and Technology Park, Shahe West Road, Nanshan District, ShenZhen, GuangDong Province, China
Accreditation Certificate	The laboratory is a testing organization accredited by FCC as a accredited testing laboratory. The designation number is CN1196.
Description	All measurement facilities used to collect the measurement data are located at Block B, 1/F, Baisha Science and Technology Park, Shahe West Road, Nanshan District, ShenZhen, GuangDong Province, China

## 2 PRODUCT INFORMATION

### 2.1 Applicant Information

Applicant	SHENZHEN 8BITDO TECH CO., LTD.
Address	Room 210, Building 1, Nanhai Ecool, No.6 Xinghua Road, Shekou, Nanshan District, Shenzhen, Guangdong, P.R. China

### 2.2 Manufacturer Information

Manufacturer	SHENZHEN ONEBITDO TECH CO., LTD.
Address	Room 203, Building 1, Huajian Building, Xinghua Road, Shekou, Shuiwan Community, Zhaoshang Street, Nanshan District, Shenzhen, Guangdong, P.R. China

### 2.3 Factory Information

Factory	Shenzhen Zhongxingda Electronic Co., Ltd.
Address	3-4/F, Bldg 10, Tongfuyu Industrial Zone, Lezhujiao Village, Xixiang, Baoan District, Shenzhen, Guangdong, P.R. China

### 2.4 General Description for Equipment under Test (EUT)

EUT Name	8BitDo Ultimate Wired Controller for Xbox
Model Name Under Test	82CE
Series Model Name	82CE01, 82CE02, 82CE03, 82CE01D, 82CE02D, 82CE03D
Description of Model name differentiation	All models are same with electrical parameters and internal circuit structure, but only differ in Appearance color and screen printing.
Serial Number	82CE22426000033
Hardware Version	10.4
Software Version	1.0.0.25
Dimensions (Approx.)	N/A
Weight (Approx.)	N/A

## 2.5 Technical Information

Network and Wireless connectivity	Bluetooth BLE
-----------------------------------	---------------

The requirement for the following technical information of the EUT was tested in this report:

Modulation Technology	DTS
Modulation Type	GFSK
Product Type	<input type="checkbox"/> Mobile <input checked="" type="checkbox"/> Portable <input type="checkbox"/> Fix Location
Transfer Rate	1 Mbps
Frequency Range	The frequency range used is 2400 MHz to 2483.5 MHz.
Number of Channel	40 (at intervals of 2 MHz)
Tested Channel	0 (2402 MHz), 19 (2440 MHz), 39 (2480 MHz)
Antenna Type	PCB Antenna
Antenna Gain	0.84 dBi (In test items related to antenna gain, the final results reflect this figure. This value is provided by the applicant.)
Antenna Impedance	50Ω
Antenna System (MIMO Smart Antenna)	N/A

## 2.6 Additional Instructions

EUT Software Settings:

Mode	<input checked="" type="checkbox"/> Special software is used. The software provided by client to enable the EUT under transmission condition continuously at specific channel frequencies individually.
------	------------------------------------------------------------------------------------------------------------------------------------------------------------------------------------------------------------

During testing, Channel and Power Controlling Software provided by the customer was used to control the operating channel as well as the output power level. The RF output power selection is for the setting of RF output power expected by the customer and is going to be fixed on the firmware of the final end product.

Power level setup in software			
Test Software Version	EMI_TEST_v2.0		
Support Units (Software installation media)	Description	Manufacturer	Model
	Notebook	HP	N/A
Mode	Channel	Frequency (MHz)	Soft Set
GFSK (1 Mbps)	CH0	2402	Power parameter Settings is -1.4
	CH19	2440	
	CH39	2480	

Run Software:

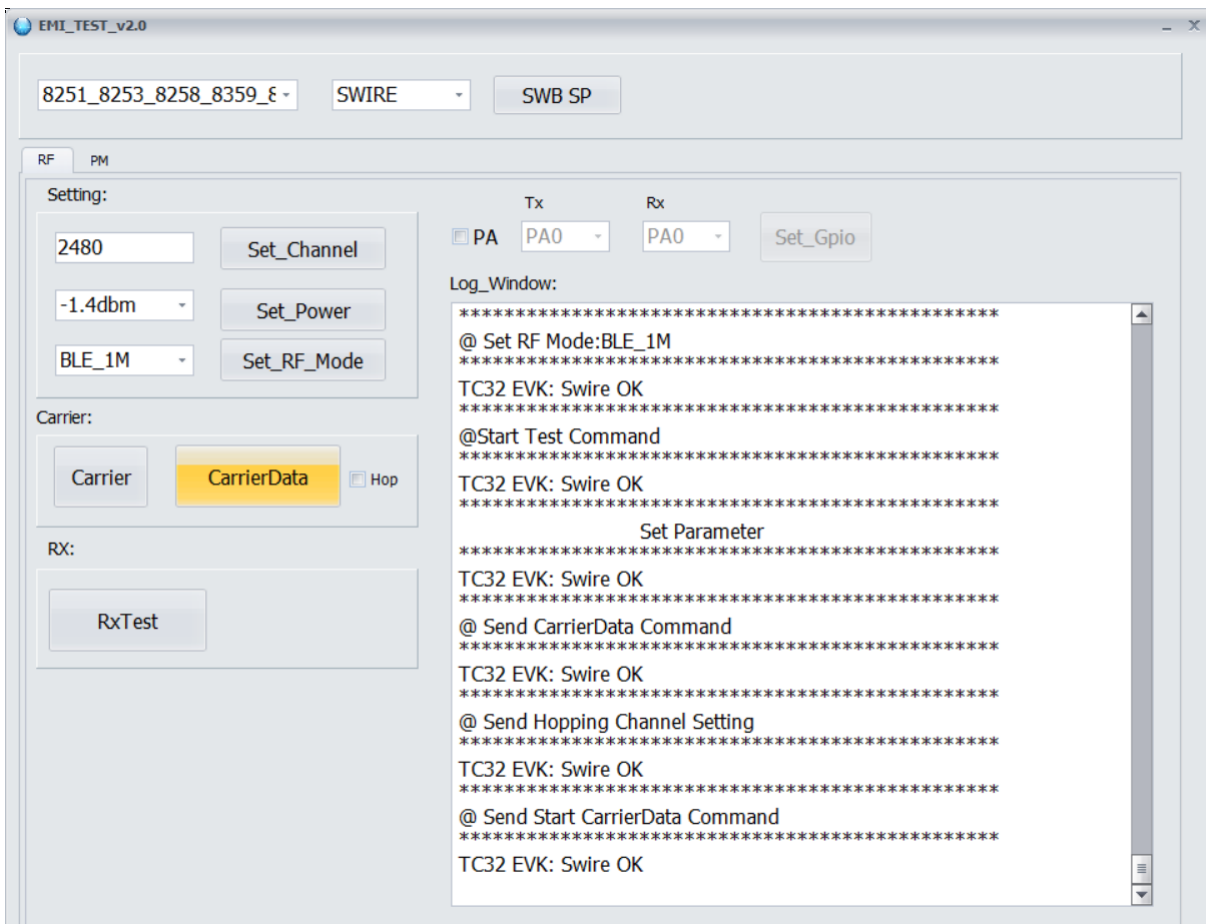

### 3 SUMMARY OF TEST RESULTS

#### 3.1 Test Standards

No.	Identity	Document Title
1	47 CFR Part 15, Subpart C	Miscellaneous Wireless Communications Services
2	ANSI C63.10-2013	American National Standard for Testing Unlicensed Wireless Devices
3	KDB 558074 D01 15.247 Meas Guidance v05r02	Guidance for compliance measurements on digital transmission system, frequency hopping spread spectrum system, and hybrid system devices operating under section 15.247 of the FCC rules

#### 3.2 Test Verdict

No.	Description	FCC Part No.	Channel	Test Result	Verdict
1	Antenna Requirement	15.203	N/A	--	Pass <sup>Note1</sup>
2	Output Power	15.247(b)	Low/Middle/High	ANNEX A.1	Pass
3	Occupied Bandwidth	15.247(a)	Low/Middle/High	ANNEX A.2	Pass
4	Conducted Spurious Emission	15.247(d)	Low/Middle/High	ANNEX A.3	Pass
5	Band Edge(Authorized-band band-edge)	15.247(d)	Low/ High	ANNEX A.4	Pass
6	Conducted Emission	15.207	Low/Middle/High	ANNEX A.5	Pass
7	Radiated Spurious Emission	15.209 15.247(d)	Low/Middle/High	ANNEX A.6	Pass
8	Band Edge(Restricted-band band-edge)	15.209 15.247(d)	Low/Middle/High	ANNEX A.7	Pass
9	Power spectral density (PSD)	15.247(e)	Low/Middle/High	ANNEX A.8	Pass
10	Receiver Spurious Emissions	--	--	N/A	N/A <sup>Note2</sup>

Note <sup>1</sup>: The EUT has a permanently and irreplaceable attached antenna, which complies with the requirement FCC 15.203.

Note <sup>2</sup>: Only radio communication receivers operating in stand-alone mode within the band 30-960 MHz, as well as scanner receivers, are subject to Industry Canada requirements, so this test is not applicable.



## 4 GENERAL TEST CONFIGURATIONS

### 4.1 Test Environments

During the measurement, the normal environmental conditions were within the listed ranges:

Relative Humidity	40% to 70%	
Atmospheric Pressure	100 kPa to 102 kPa	
Temperature	NT (Normal Temperature)	+20°C to +23.5°C
Working Voltage of the EUT	NV (Normal Voltage)	5 V

### 4.2 Test Equipment List

Description	Manufacturer	Model	Serial No.	Cal. Date	Cal. Due
Spectrum Analyzer	ROHDE&SCHWARZ	FSV-40	101544	2022.01.04	2023.01.03
Spectrum Analyzer	KEYSIGHT	N9020A	MY50330200	2021.06.01	2022.05.31
Spectrum Analyzer	KEYSIGHT	N9020A	MY50330200	2022.05.19	2023.05.18
Signaling Unit	ROHDE&SCHWARZ	CMW500	142028	2021.06.01	2022.05.31
Signaling Unit	ROHDE&SCHWARZ	CMW500	142028	2022.05.19	2023.05.18
EMI Receiver	KEYSIGHT	N9038A	MY53220118	2021.09.13	2022.09.12
EMI Receiver	ROHDE&SCHWARZ	ESRP	101036	2021.10.10	2022.10.09
LISN	SCHWARZBECK	NSLK 8127	8127-687	2021.06.08	2022.06.07
LISN	SCHWARZBECK	NSLK 8127	8127-687	2022.06.01	2023.05.31
Test Antenna- Loop(9 kHz-30 MHz)	SCHWARZBECK	FMZB 1519	1519-037	2021.04.16	2024.04.15
Test Antenna- Bi-Log(30 MHz-3 GHz)	SCHWARZBECK	VULB 9163	9163-624	2021.08.20	2024.08.19
Test Antenna- Horn(1-18 GHz)	SCHWARZBECK	BBHA 9120D	9120D-1917	2019.07.02	2022.07.01
Test Antenna- Horn (18-40 GHz)	A-INFO	LB- 180400KF	J211060273	2021.07.02	2024.07.01
Anechoic Chamber	RAINFORD	9m*6m*6m	N/A	2021.09.04	2024.09.09
Anechoic Chamber	EMC Electronic Co., Ltd	20.10*11.60 *7.35m	N/A	2021.08.15	2024.08.14
Shielded Enclosure	ChangNing	CN-130701	130703	--	--

### 4.3 Test Software List

Description	Manufacturer	Software Version	Serial No.	Applicable test Setup
BL410R	BALUN	V2.1.1.488	N/A	The section 4.5.1
BL410E	BALUN	V19.8.28.435	N/A	The section 4.5.2&4.5.3&4.5.4&4.5.5

### 4.4 Measurement Uncertainty

The following measurement uncertainty levels have been estimated for tests performed on the EUT as specified in CISPR 16-4-2.

This uncertainty represents an expanded uncertainty expressed at approximately the 95% confidence level using a coverage factor of k=2.

Parameters	Uncertainty
Occupied Channel Bandwidth	2.8%
RF output power, conducted	1.28 dB
Power Spectral Density, conducted	1.30 dB
Unwanted Emissions, conducted	1.84 dB
All emissions, radiated	5.36 dB
Temperature	0.82°C
Humidity	4.1%

### 4.5 Description of Test Setup

#### 4.5.1 For Antenna Port Test

Conducted value (dBm) = Measurement value (dBm) + cable loss (dB)

For example: the measurement value is 10 dBm and the cable 0.5dBm used, then the final result of EUT:

Conducted value (dBm) = 10 dBm + 0.5 dB = 10.5 dBm

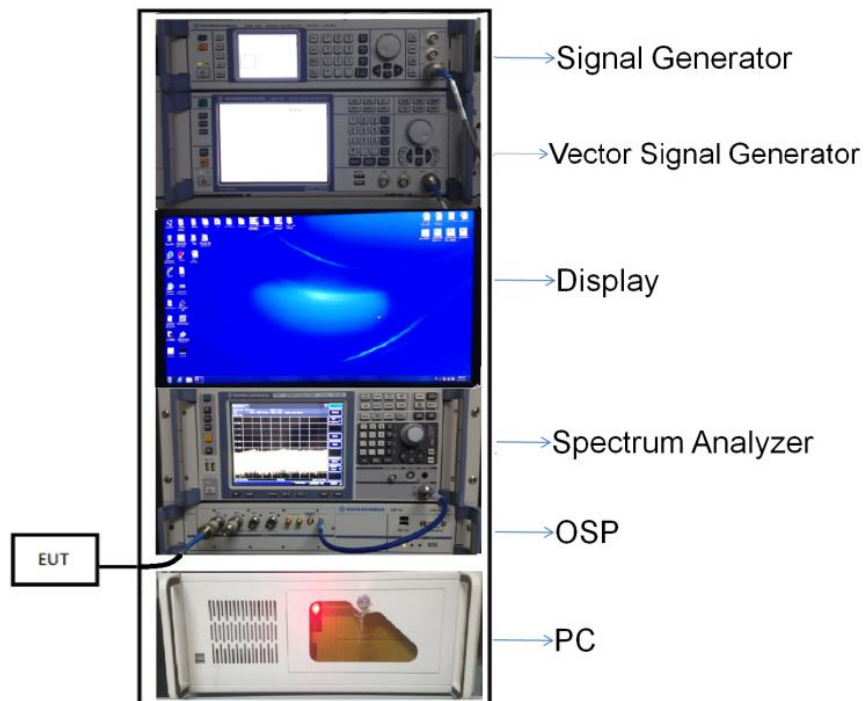

(Diagram 1)

4.5.2 For AC Power Supply Port Test



(Diagram 2)

4.5.3 For Radiated Test (Below 30 MHz)

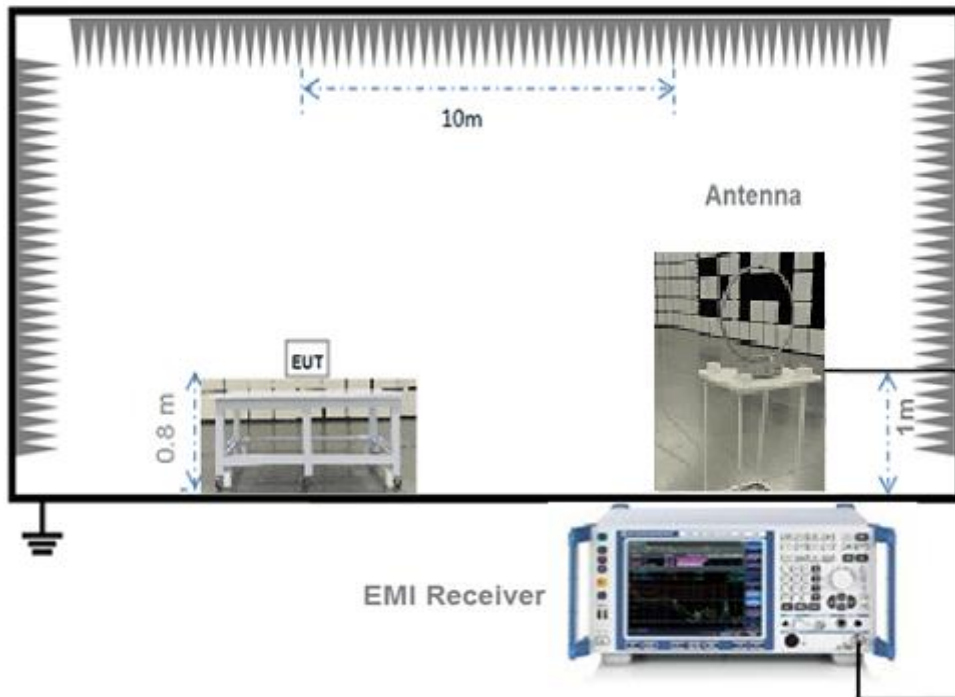

(Diagram 3)

#### 4.5.4 For Radiated Test (30 MHz-1 GHz)

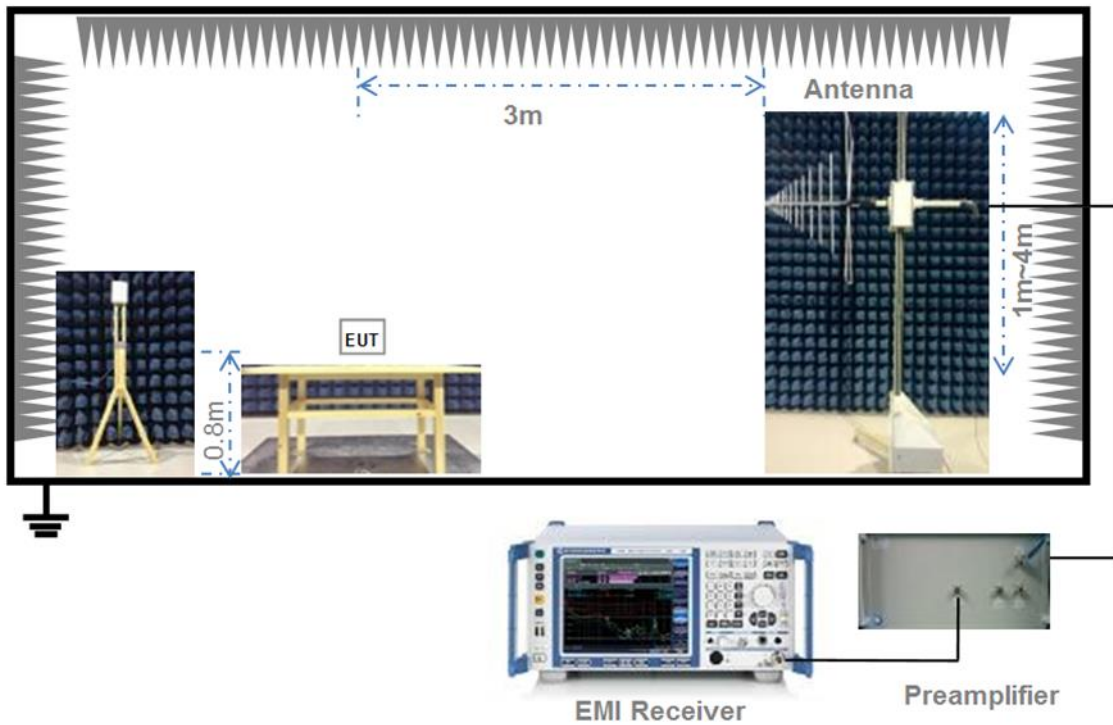

(Diagram 4)

#### 4.5.5 For Radiated Test (Above 1 GHz)

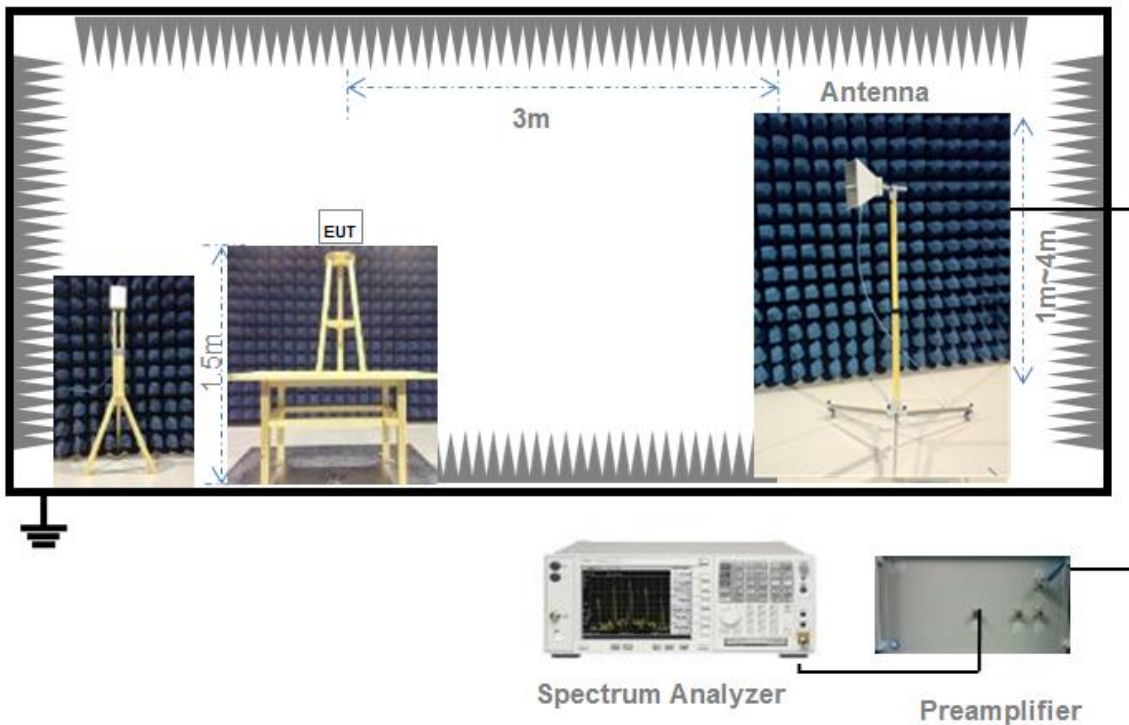

(Diagram 5)

## 4.6 Measurement Results Explanation Example

### 4.6.1 For conducted test items:

The offset level is set in the spectrum analyzer to compensate the RF cable loss and attenuator between EUT conducted output port and spectrum analyzer. With the offset compensation, the spectrum analyzer reading level is exactly the EUT RF output level.

The spectrum analyzer offset is derived from RF cable loss and attenuator factor.

Offset = RF cable loss + attenuator factor.

### 4.6.2 For radiated band edges and spurious emission test:

$$E = \text{EIRP} - 20\log D + 104.8$$

where:

E = electric field strength in dB $\mu$ V/m,

EIRP = equivalent isotropic radiated power in dBm

D = specified measurement distance in meters.

## 5 TEST ITEMS

### 5.1 Antenna Requirements

#### 5.1.1 Relevant Standards

FCC §15.203 & 15.247(b)

An intentional radiator shall be designed to ensure that no antenna other than that furnished by the responsible party shall be used with the device. The use of a permanently attached antenna or of an antenna that uses a unique coupling to the intentional radiator shall be considered sufficient to comply with the provisions of this section. The manufacturer may design the unit so that a broken antenna can be replaced by the user, but the use of a standard antenna jack or electrical connector is prohibited. This requirement does not apply to carrier current devices or to devices operated under the provisions of § 15.211, § 15.213, § 15.217, § 15.219, or § 15.221. Further, this requirement does not apply to intentional radiators that must be professionally installed, such as perimeter protection systems and some field disturbance sensors, or to other intentional radiators which, in accordance with § 15.31(d), must be measured at the installation site. However, the installer shall be responsible for ensuring that the proper antenna is employed so that the limits in this part are not exceeded.

If directional gain of transmitting antennas is greater than 6 dBi, the power shall be reduced by the same level in dB comparing to gain minus 6 dBi. For the fixed point-to-point operation, the power shall be reduced by one dB for every 3 dB that the directional gain of the antenna exceeds 6 dBi. The use of a permanently attached antenna or of an antenna that uses a unique coupling to the intentional radiator shall be considered sufficient to comply with the FCC rule.

#### 5.1.2 Antenna Anti-Replacement Construction

The Antenna Anti-Replacement as following method:

Protected Method	Description
The antenna is embedded in the product.	An embedded-in antenna design is used.

Reference Documents	Item
Photo	Please refer to the EUT Photo documents.

#### 5.1.3 Antenna Gain

The antenna peak gain of EUT is less than 6 dBi. Therefore, it is not necessary to reduce maximum peak output power limit.

## 5.2 Output Power

### 5.2.1 Test Limit

#### FCC § 15.247(b)

For systems using digital modulation in the 902-928 MHz, 2400-2483.5 MHz, and 5725-5850 MHz bands: 1 Watt. As an alternative to a peak power measurement, compliance with the one Watt limit can be based on a measurement of the maximum conducted output power. Maximum Conducted Output Power is defined as the total transmit power delivered to all antennas and antenna elements averaged across all symbols in the signaling alphabet when the transmitter is operating at its maximum power control level. Power must be summed across all antennas and antenna elements.

### 5.2.2 Test Setup

See section 4.5.1 for test setup description for the antenna port. The photo of test setup please refer to ANNEX B.

### 5.2.3 Test Procedure

#### a) Maximum peak conducted output power

This procedure shall be used when the measurement instrument has available a resolution bandwidth that is greater than the DTS bandwidth.

Set the  $RBW \geq DTS$  bandwidth.

Set  $VBW \geq 3 \times RBW$ .

Set span  $\geq 3 \times RBW$

Sweep time = auto couple.

Detector = peak.

Trace mode = max hold.

Allow trace to fully stabilize.

Use peak marker function to determine the peak amplitude level.

#### b) Measurements of duty cycle

The zero-span mode on a spectrum analyzer or EMI receiver if the response time and spacing between bins on the sweep are sufficient to permit accurate measurements of the on and off times of the transmitted signal.

Set the center frequency of the instrument to the center frequency of the transmission.

Set  $RBW \geq OBW$  if possible; otherwise, set  $RBW$  to the largest available value.

Set  $VBW \geq RBW$ . Set detector = peak or average.

The zero-span measurement method shall not be used unless both  $RBW$  and  $VBW$  are  $> 50/T$  and the number of sweep points across duration  $T$  exceeds 100. (For example, if  $VBW$  and/or  $RBW$  are limited to 3 MHz, then the zero-span method of measuring duty cycle shall not be used if  $T \leq 16.7$  microseconds.)

## 5.2.4 Test Result

Please refer to ANNEX A.1.



## 5.3 Occupied Bandwidth

### 5.3.1 Limit

FCC §15.247(a)

Make the measurement with the spectrum analyzer's resolution bandwidth (RBW) = 100 kHz. In order to make an accurate measurement, set the span greater than RBW. The 6 dB bandwidth must be greater than 500 kHz.

### 5.3.2 Test Setup

See section 4.5.1 for test setup description for the antenna port. The photo of test setup please refer to ANNEX B.

### 5.3.3 Test Procedure

Use the following spectrum analyzer settings:

Set RBW = 100 kHz.

Set the video bandwidth (VBW)  $\geq 3$  RBW.

Detector = Peak.

Trace mode = max hold.

Sweep = auto couple.

Allow the trace to stabilize.

Measure the maximum width of the emission that is constrained by the frequencies associated with the two outermost amplitude points (upper and lower frequencies) that are attenuated by 6 dB relative to the maximum level measured in the fundamental emission.

### 5.3.4 Test Result

Please refer to ANNEX A.2.

## 5.4 Conducted Spurious Emission

### 5.4.1 Limit

#### FCC §15.247(d)

In any 100 kHz bandwidth outside the frequency band in which the spread spectrum or digitally modulated intentional radiator is operating, the radio frequency power that is produced by the intentional radiator shall be at least 20 dB below that in the 100 kHz bandwidth within the band that contains the highest level of the desired power, based on either an RF conducted or a radiated measurement.

### 5.4.2 Test Setup

See section 4.5.1 for test setup description for the antenna port. The photo of test setup please refer to ANNEX B.

### 5.4.3 Test Procedure

The DTS rules specify that in any 100 kHz bandwidth outside of the authorized frequency band, the power shall be attenuated according to the following conditions:

- a) If the maximum peak conducted output power procedure was used to demonstrate compliance as described in 9.1, then the peak output power measured in any 100 kHz bandwidth outside of the authorized frequency band shall be attenuated by at least 20 dB relative to the maximum in-band peak PSD level in 100 kHz (i.e., 20 dBc).
- b) If maximum conducted (average) output power was used to demonstrate compliance as described in 9.2, then the peak power in any 100 kHz bandwidth outside of the authorized frequency band shall be attenuated by at least 30 dB relative to the maximum in-band peak PSD level in 100 kHz (i.e., 30 dBc).
- c) In either case, attenuation to levels below the 15.209 general radiated emissions limits is not required.

The following procedures shall be used to demonstrate compliance to these limits. Note that these procedures can be used in either an antenna-port conducted or radiated test set-up. Radiated tests must conform to the test site requirements and utilize maximization procedures defined herein.

Reference level measurement:

Establish a reference level by using the following procedure:

Set instrument center frequency to DTS channel center frequency.

Set the span to  $\geq 1.5$  times the DTS bandwidth.

Set the RBW = 100 kHz.

Set the VBW  $\geq 3 \times$  RBW.

Detector = peak.

Sweep time = auto couple.

Trace mode = max hold.

Allow trace to fully stabilize.

Use the peak marker function to determine the maximum PSD level.

Emission level measurement:

Use the following spectrum analyzer settings:

Span = wide enough to capture the peak level of the in-band emission and all spurious emissions (e.g., harmonics) from the lowest frequency generated in the EUT up through the 10th harmonic. Typically, several plots are required to cover this entire span.

Set the RBW = 100 kHz.

Set the VBW  $\geq 3 \times$  RBW.

Detector = peak.

Sweep time = auto couple.

Trace mode = max hold.

Allow trace to fully stabilize.

Use the peak marker function to determine the maximum amplitude level.

Ensure that the amplitude of all unwanted emissions outside of the authorized frequency band (excluding restricted frequency bands) are attenuated by at least the minimum requirements specified in 11.1 a) or 11.1 b). Report the three highest emissions relative to the limit.

#### 5.4.4 Test Result

Please refer to ANNEX A.3.

## 5.5 Band Edge (Authorized-band band-edge)

### 5.5.1 Limit

#### FCC §15.247(d)

In any 100 kHz bandwidth outside the frequency band in which the spread spectrum or digitally modulated intentional radiator is operating, the radio frequency power that is produced by the intentional radiator shall be at least 20 dB below that in the 100 kHz bandwidth within the band that contains the highest level of the desired power, based on either an RF conducted or a radiated measurement.

### 5.5.2 Test Setup

See section 4.5.1 for test setup description for the antenna port. The photo of test setup please refer to ANNEX B.

### 5.5.3 Test Procedure

The following procedures may be used to determine the peak or average field strength or power of an unwanted emission that is within 2 MHz of the authorized band edge. If a peak detector is utilized, use the procedure described in 13.2.1. Use the procedure described in 13.2.2 when using an average detector and the EUT can be configured to transmit continuously (i.e., duty cycle  $\geq 98\%$ ). Use the procedure described in 13.2.3 when using an average detector and the EUT cannot be configured to transmit continuously but the duty cycle is constant (i.e., duty cycle variations are less than  $\pm 2$  percent). Use the procedure described in 13.2.4 when using an average detector for those cases where the EUT cannot be configured to transmit continuously and the duty cycle is not constant (duty cycle variations equal or exceed 2 percent).

When using a peak detector to measure unwanted emissions at or near the band edge (within 2 MHz of the authorized band), the following integration procedure can be used.

Set instrument center frequency to the frequency of the emission to be measured (must be within 2 MHz of the authorized band edge).

Set span to 2 MHz

RBW = 100 kHz.

VBW  $\geq 3 \times$  RBW.

Detector = peak.

Sweep time = auto.

Trace mode = max hold.

Allow sweep to continue until the trace stabilizes (required measurement time may increase for low duty cycle applications)

Compute the power by integrating the spectrum over 1 MHz using the analyzer's band power measurement function with band limits set equal to the emission frequency (femission)  $\pm 0.5$  MHz. If the instrument does not have a band power function, then sum the amplitude levels (in power units) at 100 kHz intervals extending across the 1 MHz spectrum defined by femission  $\pm 0.5$  MHz.

#### 5.5.4 Test Result

Please refer to ANNEX A.4.

## 5.6 Conducted Emission

### 5.6.1 Limit

FCC §15.207

For an intentional radiator that is designed to be connected to the public utility (AC) power line, the radio frequency voltage that is conducted back onto the AC power line on any frequency within the band 150 kHz to 30 MHz shall not exceed the limits in the following table, as measured using a 50 $\mu$ H/50 $\Omega$  line impedance stabilization network (LISN).

Frequency range (MHz)	Conducted Limit (dB $\mu$ V)	
	Quai-peak	Average
0.15 - 0.50	66 to 56	56 to 46
0.50 - 5	56	46
0.50 - 30	60	50

### 5.6.2 Test Setup

See section 4.5.2 for test setup description for the AC power supply port. The photo of test setup please refer to ANNEX B.

### 5.6.3 Test Procedure

The maximum conducted interference is searched using Peak (PK), if the emission levels more than the AV and QP limits, and that have narrow margins from the AV and QP limits will be re-measured with AV and QP detectors. Tests for both L phase and N phase lines of the power mains connected to the EUT are performed. Refer to recorded points and plots below.

Devices subject to Part 15 must be tested for all available U.S. voltages and frequencies (such as a nominal 120 VAC, 50/60 Hz and 240 VAC, 50/60 Hz) for which the device is capable of operation. A device rated for 50/60 Hz operation need not be tested at both frequencies provided the radiated and line conducted emissions are the same at both frequencies.

### 5.6.4 Test Result

Please refer to ANNEX A.5.

## 5.7 Radiated Spurious Emission

### 5.7.1 Limit

FCC §15.209&15.247(d)

Radiated emission outside the frequency band attenuation below the general limits specified in FCC section 15.209(a) is not required. In addition, radiated emissions which fall in the restricted bands, as defined in FCC section 15.205(a), must also comply with the radiated emission limits specified in FCC section 15.209(a).

According to FCC section 15.209 (a), except as provided elsewhere in this subpart, the emissions from an intentional radiator shall not exceed the field strength levels specified in the following table:

Frequency (MHz)	Field Strength ( $\mu\text{V}/\text{m}$ )	Measurement Distance (m)
0.009 - 0.490	2400/F(kHz)	300
0.490 - 1.705	24000/F(kHz)	30
1.705 - 30.0	30	30
30 - 88	100	3
88 - 216	150	3
216 - 960	200	3
Above 960	500	3

Note:

1. Field Strength (dB $\mu\text{V}/\text{m}$ ) =  $20 \cdot \log[\text{Field Strength } (\mu\text{V}/\text{m})]$ .
2. In the emission tables above, the tighter limit applies at the band edges.
3. For Above 1000 MHz, the emission limit in this paragraph is based on measurement instrumentation employing an average detector, measurement using instrumentation with a peak detector function, corresponding to 20dB above the maximum permitted average limit.
4. For above 1000 MHz, limit field strength of harmonics: 54dB $\mu\text{V}/\text{m}$ @3m (AV) and 74dB $\mu\text{V}/\text{m}$ @3m (PK).

### 5.7.2 Test Setup

See section 4.5.3 to 4.5.5 for test setup description for the antenna port. The photo of test setup please refer to ANNEX B.

### 5.7.3 Test Procedure

Since the emission limits are specified in terms of radiated field strength levels, measurements performed to demonstrate compliance have traditionally relied on a radiated test configuration. Radiated measurements remain the principal method for demonstrating compliance to the specified limits; however antenna-port conducted measurements are also now acceptable to demonstrate compliance (see below for details). When radiated measurements are utilized, test site requirements and procedures for maximizing and measuring radiated emissions that are described in ANSI C63.10 shall be followed.

Antenna-port conducted measurements may also be used as an alternative to radiated measurements

for demonstrating compliance in the restricted frequency bands. If conducted measurements are performed, then proper impedance matching must be ensured and an additional radiated test for cabinet/case spurious emissions is required.

General Procedure for conducted measurements in restricted bands:

- a) Measure the conducted output power (in dBm) using the detector specified (see guidance regarding measurement procedures for determining quasi-peak, peak, and average conducted output power, respectively).
- b) Add the maximum transmit antenna gain (in dBi) to the measured output power level to determine the EIRP level (see guidance on determining the applicable antenna gain)
- c) Add the appropriate maximum ground reflection factor to the EIRP level (6 dB for frequencies  $\leq$  30 MHz, 4.7 dB for frequencies between 30 MHz and 1000 MHz, inclusive and 0 dB for frequencies  $>$  1000 MHz).
- d) For devices with multiple antenna-ports, measure the power of each individual chain and sum the EIRP of all chains in linear terms (e.g., Watts, mW).
- e) Convert the resultant EIRP level to an equivalent electric field strength using the following relationship:

$$E = \text{EIRP} - 20\log D + 104.8$$

where:

E = electric field strength in dB $\mu$ V/m,

EIRP = equivalent isotropic radiated power in dBm

D = specified measurement distance in meters.

- f) Compare the resultant electric field strength level to the applicable limit.
- g) Perform radiated spurious emission test.

#### Quasi-Peak measurement procedure

The specifications for measurements using the CISPR quasi-peak detector can be found in Publication 16 of the International Special Committee on Radio Frequency Interference (CISPR) of the International Electrotechnical Commission.

As an alternative to CISPR quasi-peak measurement, compliance can be demonstrated to the applicable emission limits using a peak detector.

Peak power measurement procedure:

Peak emission levels are measured by setting the instrument as follows:

- a) RBW = as specified in Table 1.
- b) VBW  $\geq$  3 x RBW.



- c) Detector = Peak.
- d) Sweep time = auto.
- e) Trace mode = max hold.
- f) Allow sweeps to continue until the trace stabilizes. (Note that the required measurement time may be longer for low duty cycle applications).

Table 1—RBW as a function of frequency

Frequency	RBW
9-150 kHz	200-300 Hz
0.15-30 MHz	9-10 kHz
30-1000 MHz	100-120 kHz
> 1000 MHz	1 MHz

If the peak-detected amplitude can be shown to comply with the average limit, then it is not necessary to perform a separate average measurement.

Trace averaging across on and off times of the EUT transmissions followed by duty cycle correction:

If continuous transmission of the EUT (i.e., duty cycle  $\geq 98$  percent) cannot be achieved and the duty cycle is constant (i.e., duty cycle variations are less than  $\pm 2$  percent), then the following procedure shall be used:

- a) The EUT shall be configured to operate at the maximum achievable duty cycle.
- b) Measure the duty cycle,  $x$ , of the transmitter output signal as described in section 6.0.
- c) RBW = 1 MHz (unless otherwise specified).
- d) VBW  $\geq 3 \times$  RBW.
- e) Detector = RMS, if  $\text{span}/(\# \text{ of points in sweep}) \leq (\text{RBW}/2)$ . Satisfying this condition may require increasing the number of points in the sweep or reducing the span. If this condition cannot be satisfied, then the detector mode shall be set to peak.
- f) Averaging type = power (i.e., RMS).
  - 1) As an alternative, the detector and averaging type may be set for linear voltage averaging.
  - 2) Some instruments require linear display mode in order to use linear voltage averaging. Log or dB averaging shall not be used.
- g) Sweep time = auto.
- h) Perform a trace average of at least 100 traces.
- i) A correction factor shall be added to the measurement results prior to comparing to the emission limit in order to compute the emission level that would have been measured had the test been performed at 100 percent duty cycle. The correction factor is computed as follows:

- 1) If power averaging (RMS) mode was used in step f), then the applicable correction factor is  $10 \log(1/x)$ , where  $x$  is the duty cycle.
- 2) If linear voltage averaging mode was used in step f), then the applicable correction factor is  $20 \log(1/x)$ , where  $x$  is the duty cycle.
- 3) If a specific emission is demonstrated to be continuous ( $\geq 98$  percent duty cycle) rather than turning on and off with the transmit cycle, then no duty cycle correction is required for that emission.

NOTE: Reduction of the measured emission amplitude levels to account for operational duty factor is not permitted. Compliance is based on emission levels occurring during transmission - not on an average across on and off times of the transmitter.

Determining the applicable transmit antenna gain:

A conducted power measurement will determine the maximum output power associated with a restricted band emission; however, in order to determine the associated EIRP level, the gain of the transmitting antenna (in dBi) must be added to the measured output power (in dBm).

Since the out-of-band characteristics of the EUT transmit antenna will often be unknown, the use of a conservative antenna gain value is necessary. Thus, when determining the EIRP based on the measured conducted power, the upper bound on antenna gain for a device with a single RF output shall be selected as the maximum in-band gain of the antenna across all operating bands, or 2 dBi, whichever is greater. However, for devices that operate in multiple frequency bands while using the same transmit antenna, the highest gain of the antenna within the operating band nearest in frequency to the restricted band emission being measured may be used in lieu of the overall highest gain when the emission is at a frequency that is within 20 percent of the nearest band edge frequency, but in no case shall a value less than 2 dBi be used.

See KDB 662911 for guidance on calculating the additional array gain term when determining the effective antenna gain for a EUT with multiple outputs occupying the same or overlapping frequency ranges in the same band.

Radiated spurious emission test:

An additional consideration when performing conducted measurements of restricted band emissions is that unwanted emissions radiating from the EUT cabinet, control circuits, power leads, or intermediate circuit elements will likely go undetected in a conducted measurement configuration. To address this concern, a radiated test shall be performed to ensure that emissions emanating from the EUT cabinet (rather than the antenna port) also comply with the applicable limits.

For these cabinet radiated spurious emission measurements the EUT transmit antenna may be replaced with a termination matching the nominal impedance of the antenna. Procedures for performing radiated measurements are specified in ANSI C63.10. All detected emissions shall comply with the applicable limits.

The measurement frequency range is from 30MHz to the 10th harmonic of the fundamental frequency. The Turn Table is actuated to turn from  $0^\circ$  to  $360^\circ$ , and both horizontal and vertical polarizations of the

Test Antenna are used to find the maximum radiated power. Mid channels on all channel bandwidth verified. Only the worst RB size/offset presented.

The power of the EUT transmitting frequency should be ignored.

All Spurious Emission tests were performed in X, Y, Z axis direction. And only the worst axis test condition was recorded in this test report.

Use the following spectrum analyzer settings:

Span = wide enough to fully capture the emission being measured

RBW = 1 MHz for  $f \geq 1$  GHz, 100 kHz for  $f < 1$  GHz

VBW  $\geq$  RBW

Sweep = auto

Detector function = peak

Trace = max hold

#### 5.7.4 Test Result

Please refer to ANNEX A.6.

## 5.8 Band Edge (Restricted-band band-edge)

### 5.8.1 Limit

FCC §15.209&15.247(d)

Radiated emission outside the frequency band attenuation below the general limits specified in FCC section 15.209(a) is not required. In addition, radiated emissions which fall in the restricted bands, as defined in FCC section 15.205(a), must also comply with the radiated emission limits specified in FCC section 15.209(a).

### 5.8.2 Test Setup

See section 4.5.3 to 4.5.5 for test setup description for the antenna port. The photo of test setup please refer to ANNEX B.

### 5.8.3 Test Procedure

The measurement frequency range is from 9 kHz to the 10th harmonic of the fundamental frequency. The Turn Table is actuated to turn from 0° to 360°, and both horizontal and vertical polarizations of the Test Antenna are used to find the maximum radiated power. Mid channels on all channel bandwidth verified. Only the worst RB size/offset presented.

The power of the EUT transmitting frequency should be ignored.

All Spurious Emission tests were performed in X, Y, Z axis direction. And only the worst axis test condition was recorded in this test report.

Use the following spectrum analyzer settings:

Span = wide enough to fully capture the emission being measured

RBW = 1 MHz for  $f \geq 1$  GHz, 100 kHz for  $f < 1$  GHz

VBW  $\geq$  RBW

Sweep = auto

Detector function = peak

Trace = max hold

For measurement below 1GHz, If the emission level of the EUT measured by the peak detector is 3 dB lower than the applicable limit, the peak emission level will be reported, Otherwise, the emission measurement will be repeated using the quasi-peak detector and reported.

For transmitters operating above 1 GHz repeat the measurement with an average detector.

### 5.8.4 Test Result

Please refer to ANNEX A.7.

## 5.9 Power Spectral density (PSD)

### 5.9.1 Limit

#### FCC §15.247(e)

The same method of determining the conducted output power shall be used to determine the power spectral density. If a peak output power is measured, then a peak power spectral density measurement is required. If an average output power is measured, then an average power spectral density measurement should be used.

The transmitter power spectral density conducted from the transmitter to the antenna shall not be greater than 8 dBm in any 3 kHz band during any time interval of continuous transmission. This power spectral density shall be determined in accordance with the provisions of Section 5.4(4), (i.e. the power spectral density shall be determined using the same method as is used to determine the conducted output power).

### 5.9.2 Test Setup

See section 4.5.1 (Diagram 1) for test setup description for the antenna port. The photo of test setup please refer to ANNEX B.

### 5.9.3 Test Procedure

Set analyzer center frequency to DTS channel center frequency.

Set the span to 1.5 times the DTS bandwidth.

Set the RBW to:  $3 \text{ kHz} \leq \text{RBW} \leq 100 \text{ kHz}$ .

Set the VBW  $\geq 3$  RBW.

Detector = peak.

Sweep time = auto couple.

Trace mode = max hold.

Allow trace to fully stabilize.

Use the peak marker function to determine the maximum amplitude level within the RBW.

If measured value exceeds limit, reduce RBW (no less than 3 kHz) and repeat.

### 5.9.4 Test Result

Please refer to ANNEX A.8.

## ANNEX A TEST RESULT

### A.1 Output Power, Duty Cycle

#### Peak Power Test Data

Channel	Measured Output Peak Power		Limit		Verdict
	GFSK (BLE 1Mbps)		dBm	mW	
	dBm	mW			
Low Channel	-10.80	0.08	30	1000	Pass
Middle Channel	-9.85	0.10			Pass
High Channel	-13.42	0.05			Pass

Test Plots

GFSK (BLE 1Mbps) LOW CHANNEL

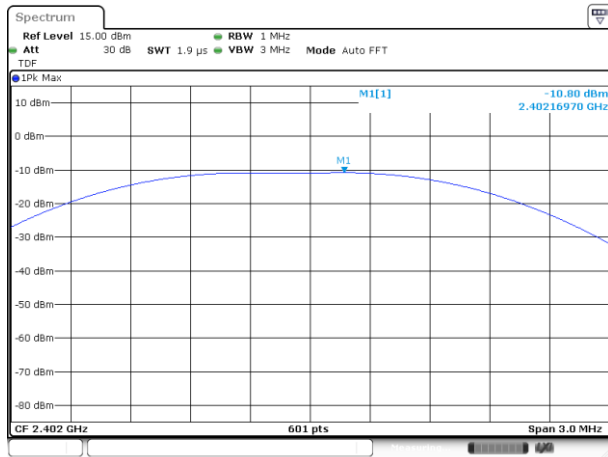

Date: 24 JUN 2022 08:52:27

GFSK (BLE 1Mbps) MIDDLE CHANNEL

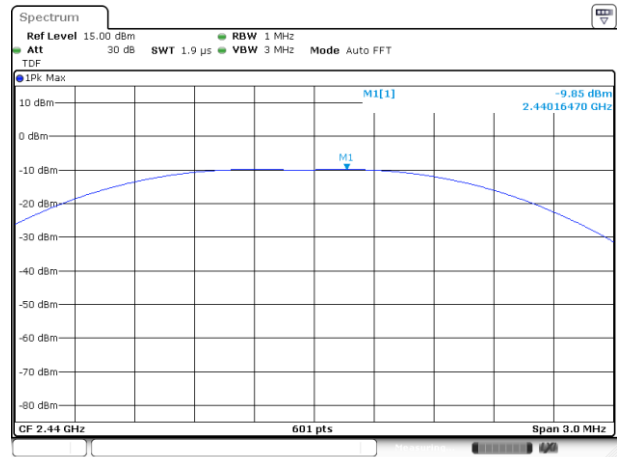

Date: 24 JUN 2022 09:04:55

GFSK (BLE 1Mbps) HIGH CHANNEL

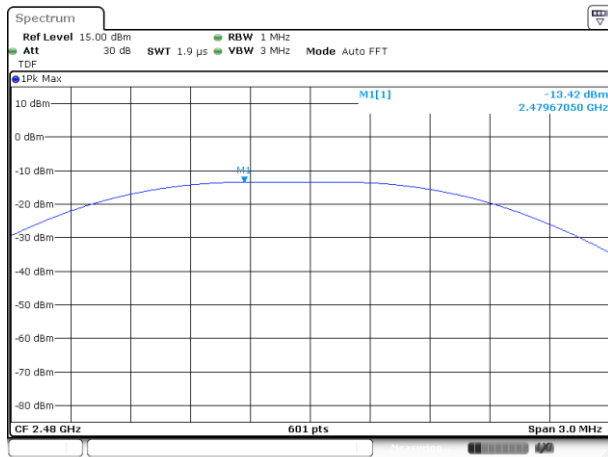

Date: 24 JUN 2022 09:07:27

**Duty Cycle Test Data**

Band	On Time (ms)	On+Off Time (ms)	Duty Cycle (%)
GFSK (BLE 1Mbps)	10	10	100%

**Test Plots**

**GFSK (BLE 1Mbps)**

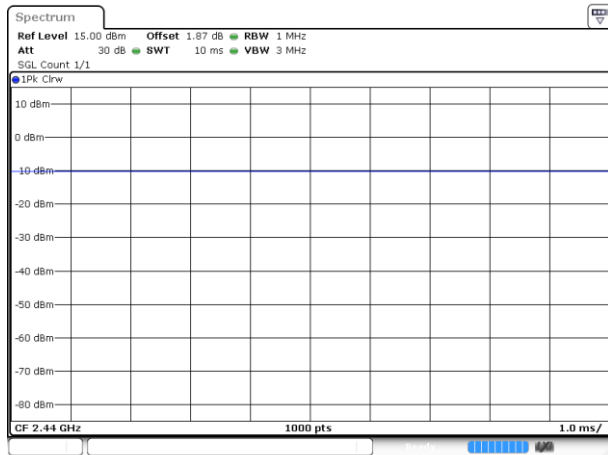

Date: 24 JUN 2022 09:06:40



## A.2 Occupied Bandwidth

### Test Data

Test Mode	GFSK (BLE 1Mbps)		
Channel	6 dB Bandwidth (kHz)	99% Bandwidth (kHz)	6 dB Bandwidth Limits (kHz)
Low Channel	713.130	1002.894	≥500
Middle Channel	669.680	1020.260	≥500
High Channel	673.830	1024.602	≥500

Test Plots

6 dB Bandwidth

GFSK (BLE 1Mbps) LOW CHANNEL

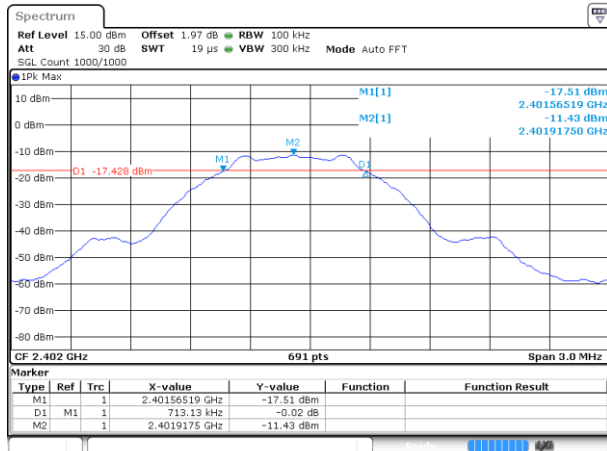

Date: 24 JUN 2022 08:52:31

GFSK (BLE 1Mbps) MIDDLE CHANNEL

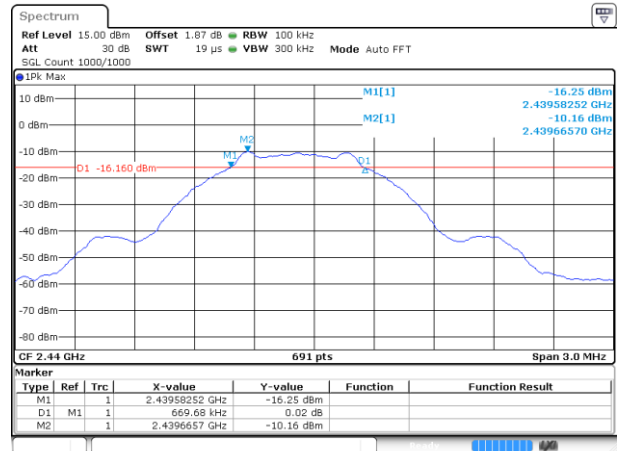

Date: 24 JUN 2022 09:04:59

GFSK (BLE 1Mbps) HIGH CHANNEL

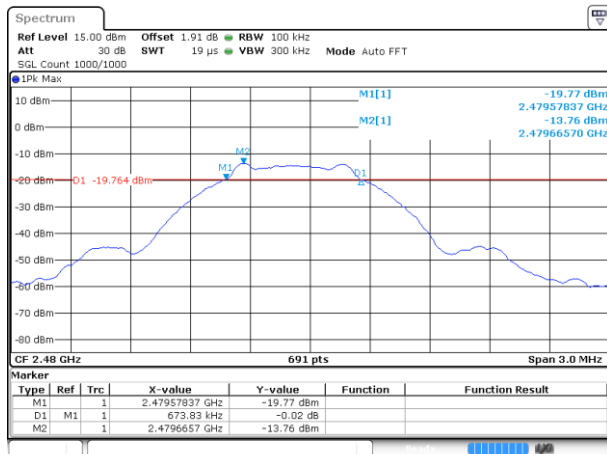

Date: 24 JUN 2022 09:07:31

99% Bandwidth

GFSK (BLE 1Mbps) LOW CHANNEL

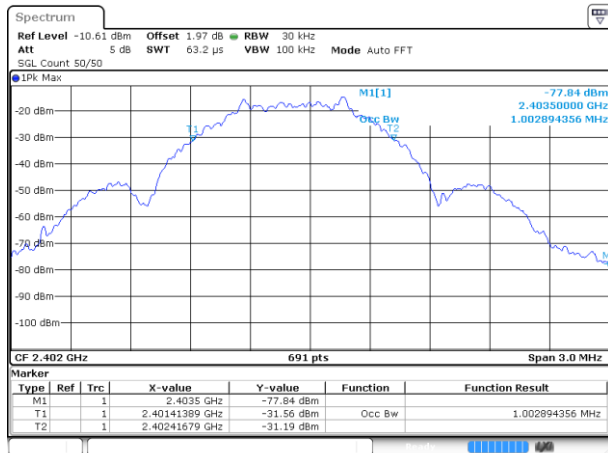

Date: 24 JUN 2022 08:52:36

GFSK (BLE 1Mbps) MIDDLE CHANNEL

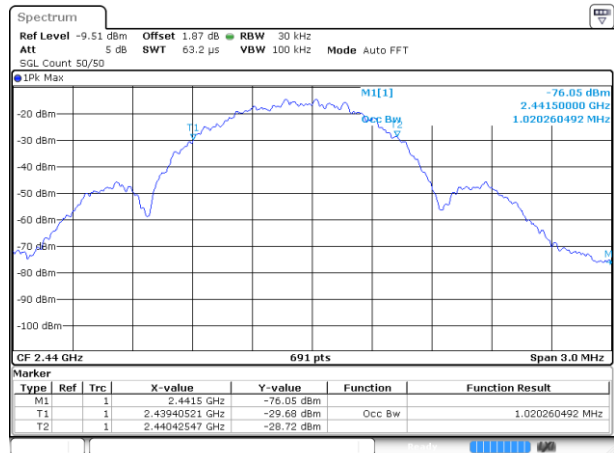

Date: 24 JUN 2022 09:05:03

GFSK (BLE 1Mbps) HIGH CHANNEL

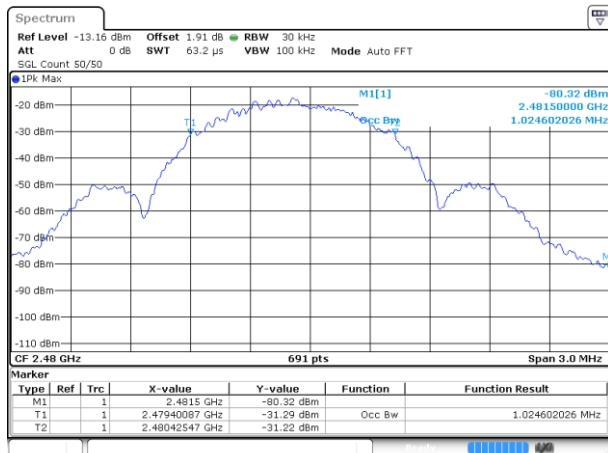

Date: 24 JUN 2022 09:07:35

### A.3 Conducted Spurious Emissions

#### Test Data

GFSK (BLE 1Mbps)				
Channel	Measured Max. Out of Band Emission (dBm)	Limit (dBm)		Verdict
		Carrier Level	Calculated 20 dBc Limit	
Low Channel	-46.21	-12.49	-32.49	Pass
Middle Channel	-47.18	-10.18	-30.18	Pass
High Channel	-47.42	-13.50	-33.50	Pass

Test Plots

GFSK (BLE 1Mbps) LOW CHANNEL, CARRIER LEVEL

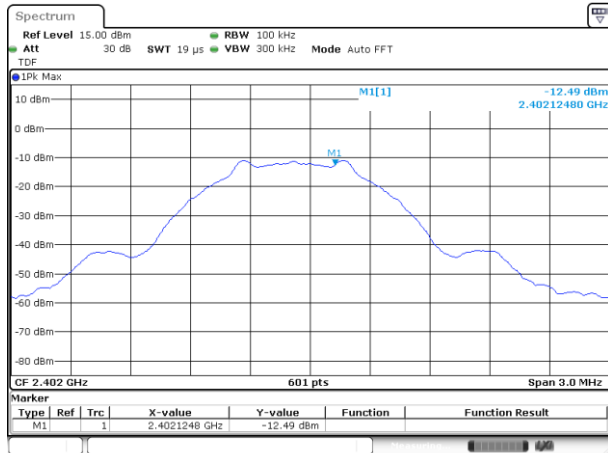

Date: 24 JUN 2022 09:01:34

GFSK (BLE 1Mbps) LOW CHANNEL, SPURIOUS 30 MHz ~ 3 GHz

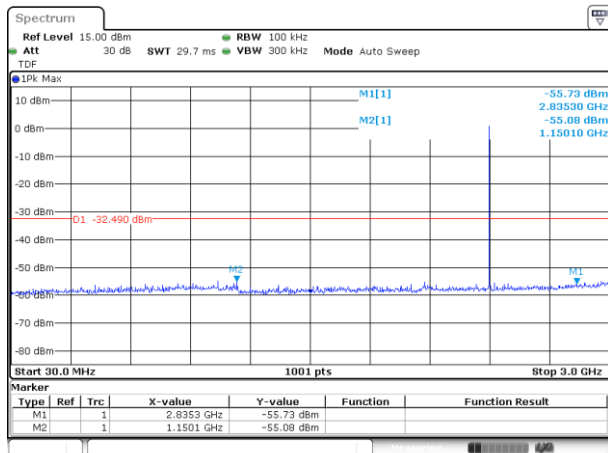

Date: 24 JUN 2022 09:02:49

GFSK (BLE 1Mbps) LOW CHANNEL, SPURIOUS 2 GHz ~ 25 GHz

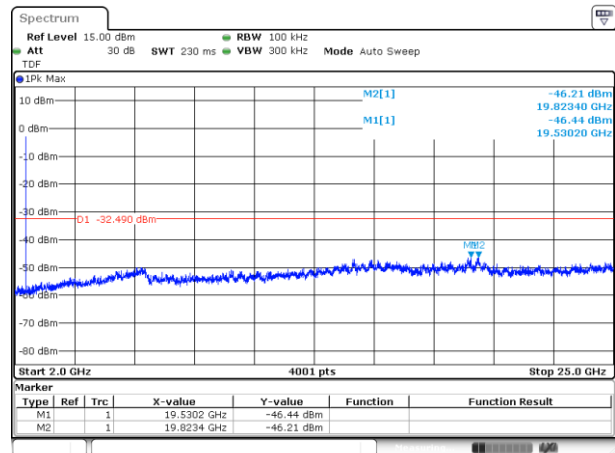

Date: 24 JUN 2022 09:03:06

### GFSK (BLE 1Mbps) MIDDLE CHANNEL, CARRIER LEVEL

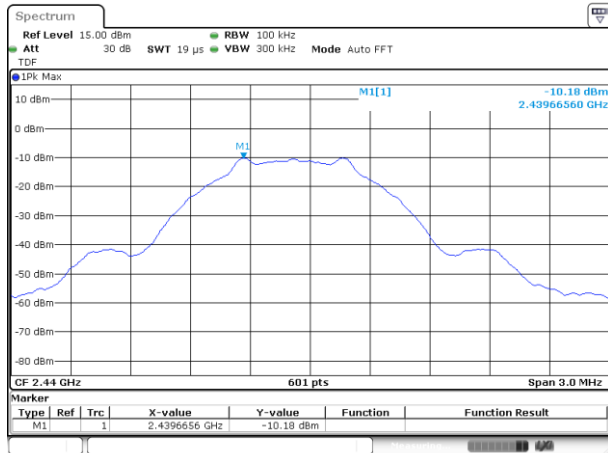

Date: 24 JUN 2022 09:05:15

### GFSK (BLE 1Mbps) MIDDLE CHANNEL, SPURIOUS 30 MHz ~ 3 GHz

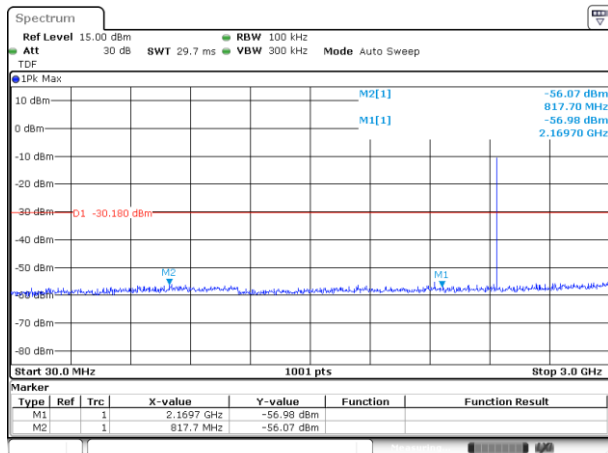

Date: 24 JUN 2022 09:05:52

### GFSK (BLE 1Mbps) MIDDLE CHANNEL, SPURIOUS 2 GHz ~ 25 GHz

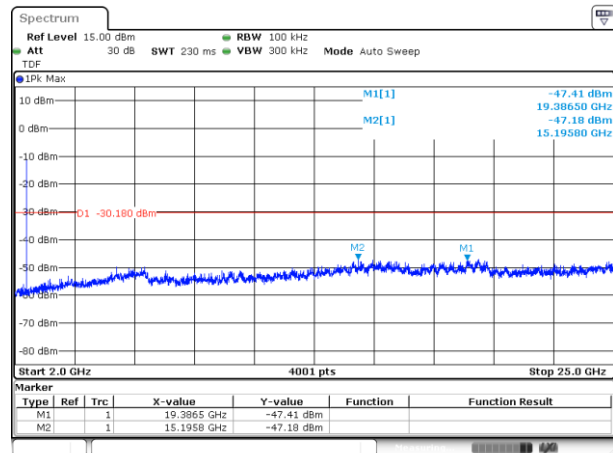

Date: 24 JUN 2022 09:06:06

### GFSK (BLE 1Mbps) HIGH CHANNEL, CARRIER LEVEL

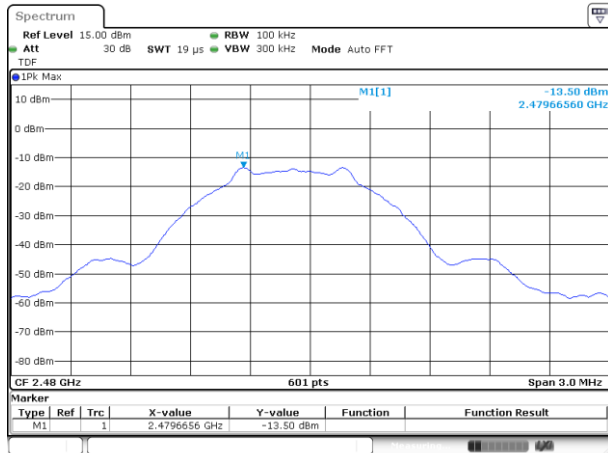

Date: 24 JUN 2022 09:07:47

### GFSK (BLE 1Mbps) HIGH CHANNEL, SPURIOUS 30 MHz ~ 3 GHz

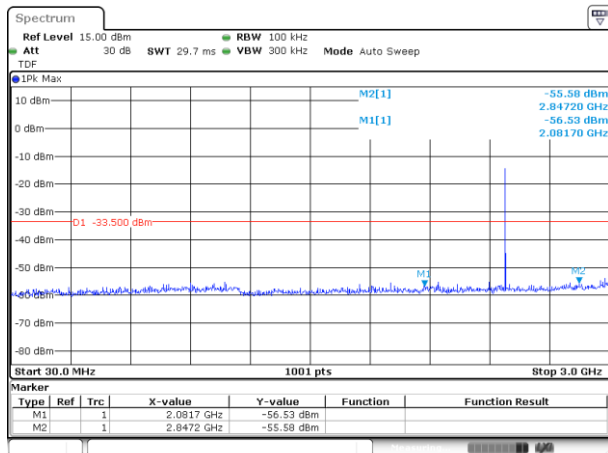

Date: 24 JUN 2022 09:08:36

### GFSK (BLE 1Mbps) HIGH CHANNEL, SPURIOUS 2 GHz ~ 25 GHz

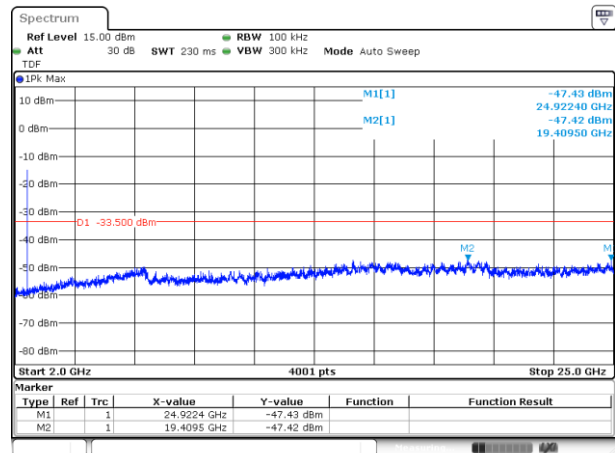

Date: 24 JUN 2022 09:08:48

## A.4 Band Edge (Authorized-band band-edge)

Note: The lowest and highest channels are tested to verify the band edge emissions. Please refer to the following the plots for emissions values.

### Test Data

GFSK (BLE 1Mbps)				
Channel	Measured Max. Band Edge Emission (dBm)	Limit (dBm)		Verdict
		Carrier Level	Calculated 20 dBc Limit	
Low Channel	-61.03	-12.49	-32.49	Pass
High Channel	-60.28	-13.50	-33.50	Pass



Test Plots

GFSK (BLE 1Mbps) LOW CHANNEL, CARRIER LEVEL

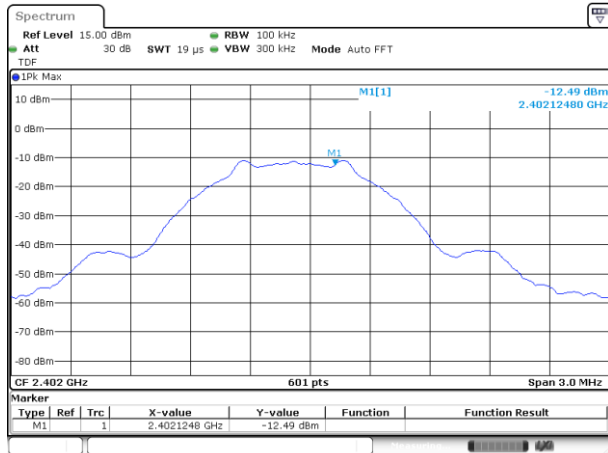

Date: 24 JUN 2022 09:01:34

GFSK (BLE 1Mbps) LOW CHANNEL, REFERENCE LEVEL

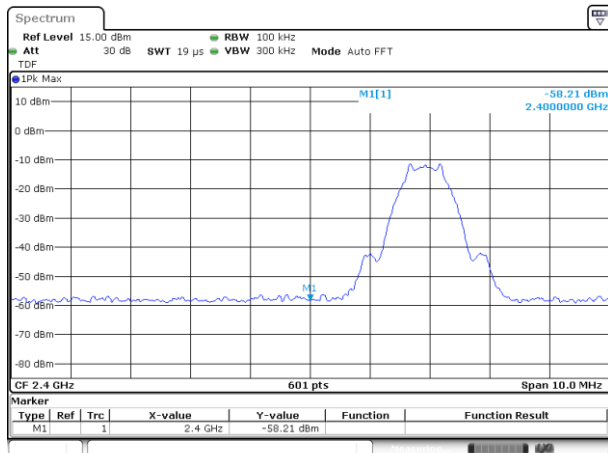

Date: 24 JUN 2022 09:03:47

GFSK (BLE 1Mbps) LOW CHANNEL, BAND EDGE

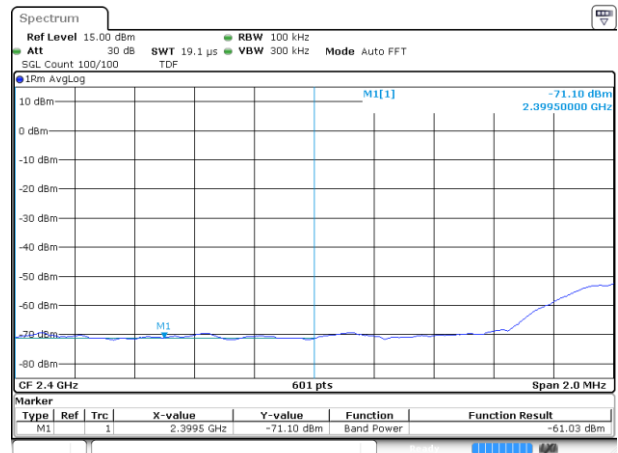

Date: 24 JUN 2022 09:04:03

### GFSK (BLE 1Mbps) HIGH CHANNEL, CARRIER LEVEL

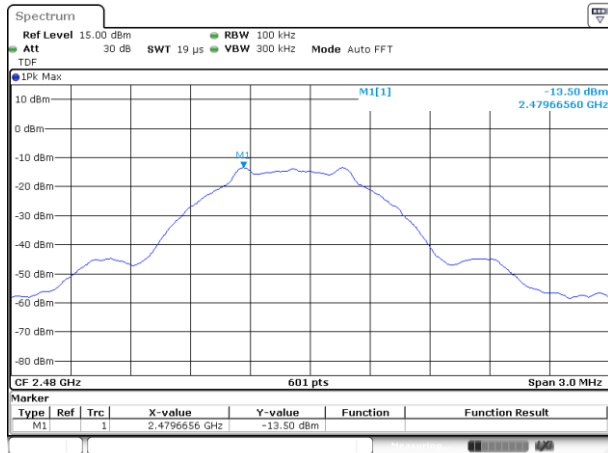

Date: 24 JUN 2022 09:07:47

### GFSK (BLE 1Mbps) HIGH CHANNEL, REFERENCE LEVEL

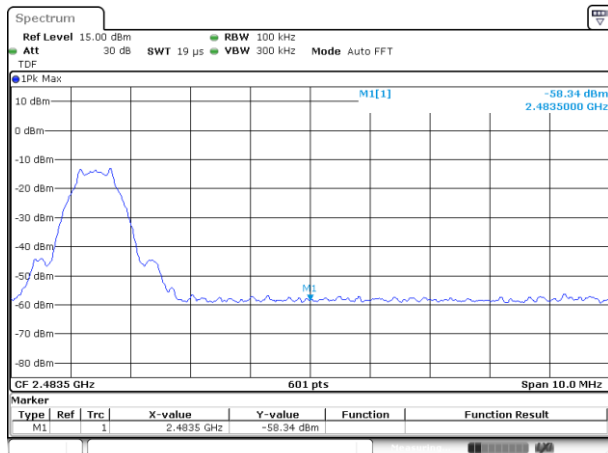

Date: 24 JUN 2022 09:08:59

### GFSK (BLE 1Mbps) HIGH CHANNEL, BAND EDGE

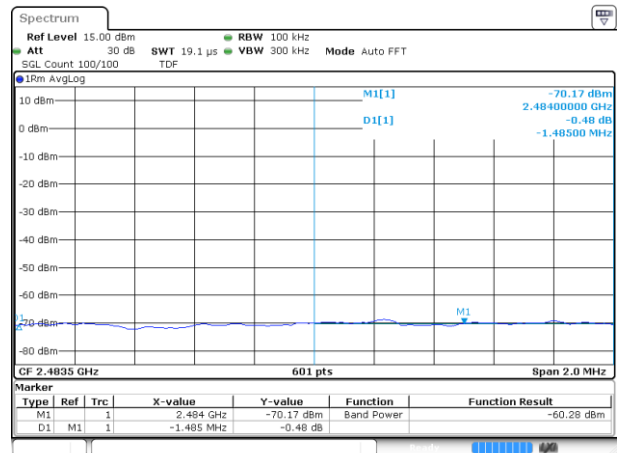

Date: 24 JUN 2022 09:09:17

## A.5 Conducted Emissions

Note 1: The EUT is working in the Normal link mode. All modes have been tested and normal link mode is worst.

Note 2: Results (dBuV) = Original reading level of Spectrum Analyzer (dBuV) + Factor (dB)

### Test Data and Plots

#### PHASE L

CE Test case\_FCC\_CE\_FCC PART 15B\_Class B

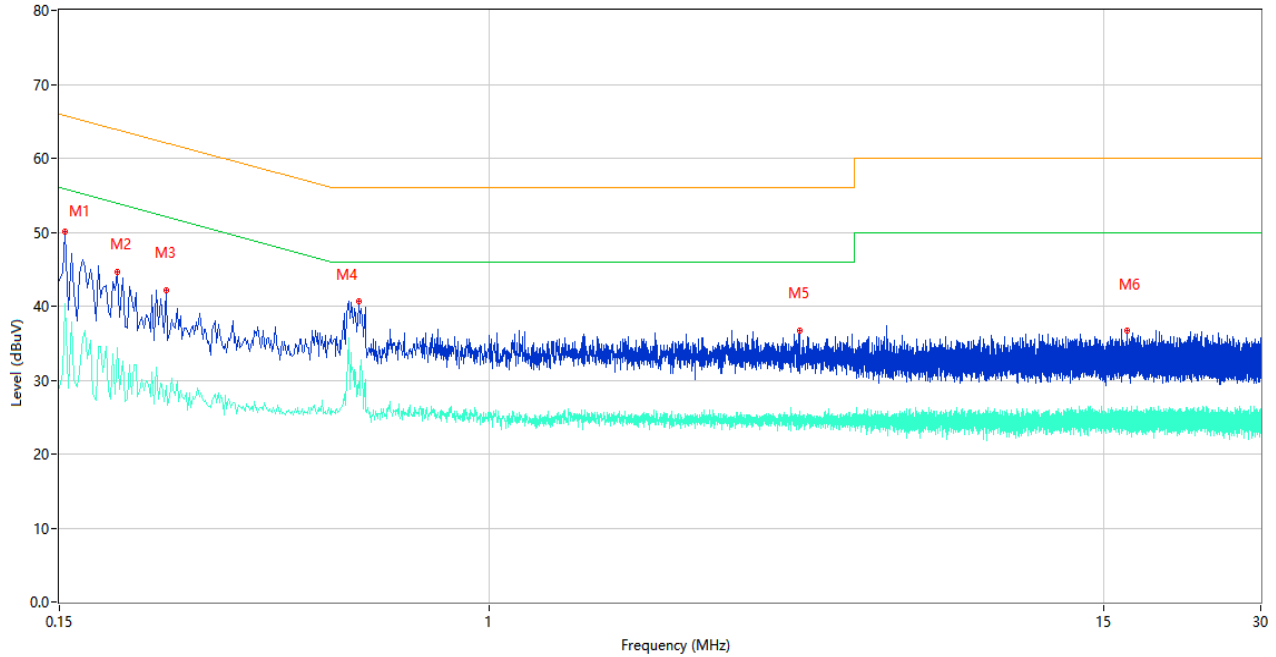

No.	Frequency (MHz)	Results (dBuV)	Factor (dB)	Limit (dBuV)	Over Limit (dB)	Detector	Line	Verdict
1	0.154	50.08	10.99	65.78	-15.70	Peak	L	Pass
1**	0.154	40.40	10.99	55.78	-15.38	AV	L	Pass
2	0.194	44.61	10.96	63.86	-19.25	Peak	L	Pass
2**	0.194	34.35	10.96	53.86	-19.51	AV	L	Pass
3	0.240	42.20	10.93	62.10	-19.90	Peak	L	Pass
3**	0.240	29.22	10.93	52.10	-22.88	AV	L	Pass
4	0.562	40.61	10.89	56.00	-15.39	Peak	L	Pass
4**	0.562	29.68	10.89	46.00	-16.32	AV	L	Pass
5	3.920	36.64	10.72	56.00	-19.36	Peak	L	Pass
5**	3.920	25.72	10.72	46.00	-20.28	AV	L	Pass
6	16.602	36.67	10.65	60.00	-23.33	Peak	L	Pass
6**	16.602	24.76	10.65	50.00	-25.24	AV	L	Pass

PHASE N

CE Test case\_FCC\_CE\_FCC PART 15B\_Class B

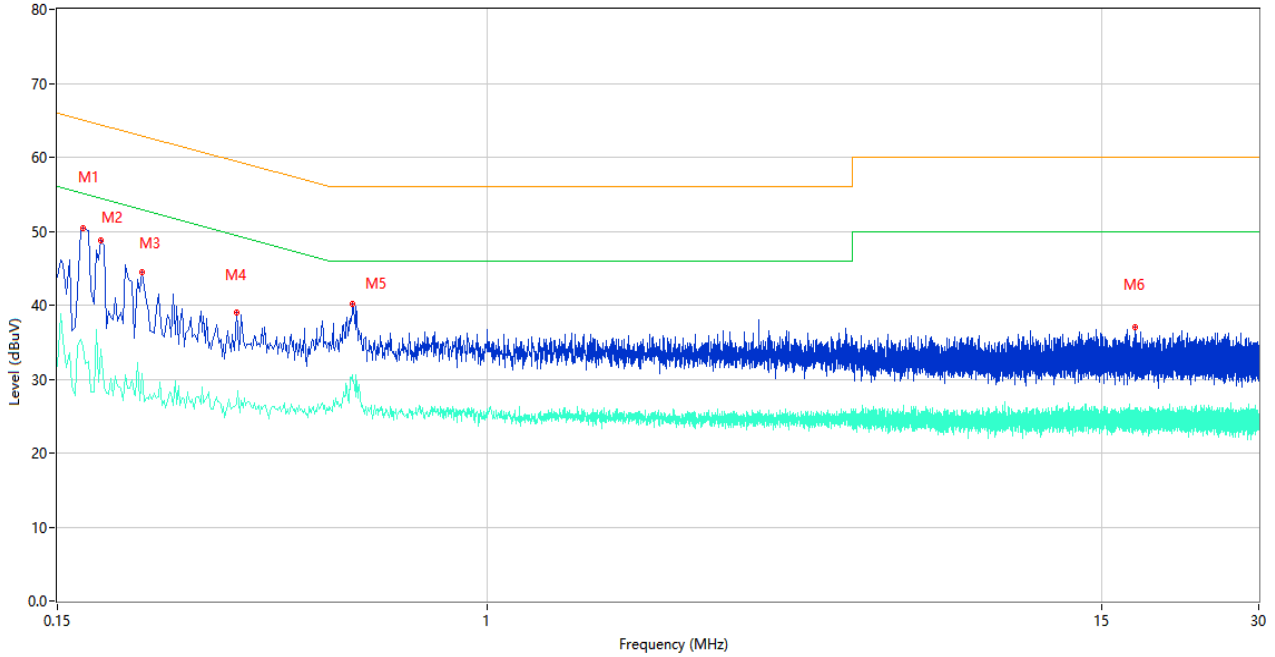

No.	Frequency (MHz)	Results (dBuV)	Factor (dB)	Limit (dBuV)	Over Limit (dB)	Detector	Line	Verdict
1	0.168	50.36	10.98	65.06	-14.70	Peak	N	Pass
1**	0.168	34.31	10.98	55.06	-20.75	AV	N	Pass
2	0.182	48.68	10.97	64.39	-15.71	Peak	N	Pass
2**	0.182	34.06	10.97	54.39	-20.33	AV	N	Pass
3	0.218	44.46	10.94	62.89	-18.43	Peak	N	Pass
3**	0.218	30.73	10.94	52.89	-22.16	AV	N	Pass
4	0.330	39.09	10.89	59.45	-20.36	Peak	N	Pass
4**	0.330	26.56	10.89	49.45	-22.89	AV	N	Pass
5	0.552	40.08	10.90	56.00	-15.92	Peak	N	Pass
5**	0.552	29.68	10.90	46.00	-16.32	AV	N	Pass
6	17.356	37.01	10.67	60.00	-22.99	Peak	N	Pass
6**	17.356	25.95	10.67	50.00	-24.05	AV	N	Pass

## A.6 Radiated Spurious Emission

Note <sup>1</sup>: The symbol of "--" in the table which means not application.

Note <sup>2</sup>: For the test data above 1 GHz, according to the ANSI C63.4-2014, where limits are specified for both average and peak (or quasi-peak) detector functions, if the peak (or quasi-peak) measured value complies with the average limit, it is unnecessary to perform an average measurement.

Note <sup>3</sup>: The low frequency, which started from 9 kHz to 30 MHz, was pre-scanned and the result which was 20 dB lower than the limit line per 15.31(o) was not reported.

Note <sup>4</sup>: The EUT is working in the Normal link mode below 1 GHz. All modes have been tested and BLE 1M-Middle channel mode is the worst.

Note <sup>5</sup>: Results (dBuV/m) = Original reading level of Spectrum Analyzer (dBuV/m) + Factor (dB)

### Test Data and Plots

#### 30 MHz to 1 GHz, ANT H

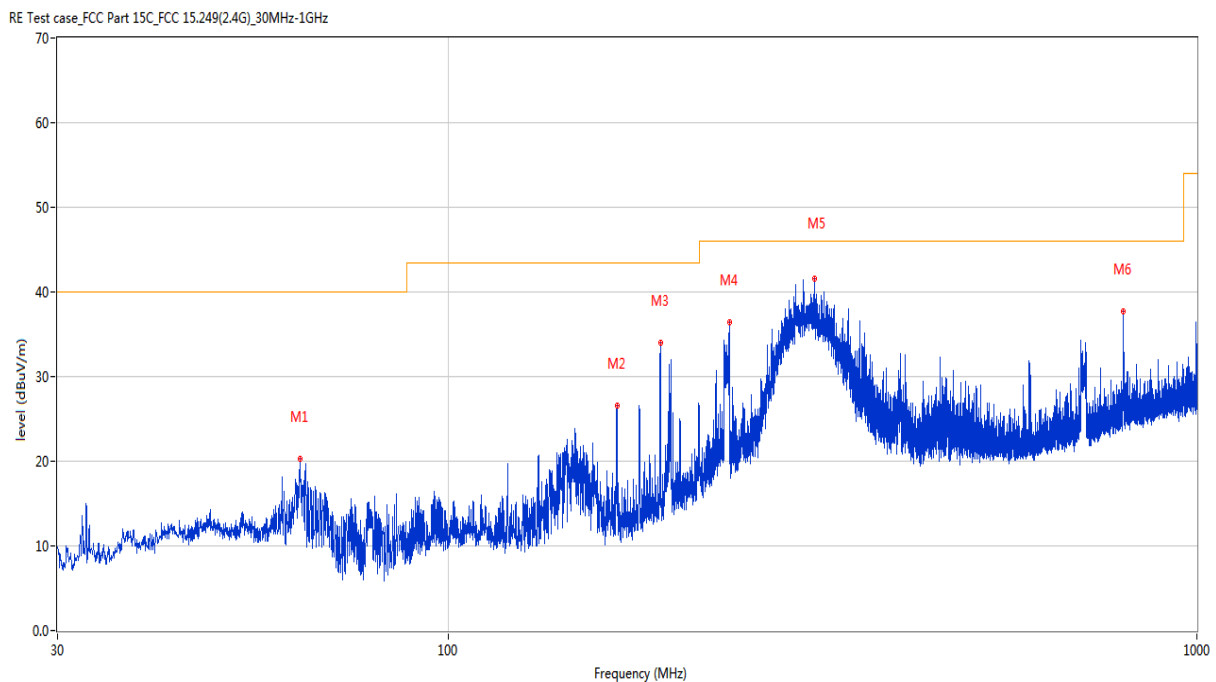

No.	Frequency (MHz)	Results (dBuV/m)	Factor (dB)	Limit (dBuV/m)	Over Limit (dB)	Detector	Table (Degree)	Height (cm)	Antenna	Verdict
1	63.222	20.29	-24.80	40.0	-19.71	Peak	360.50	200	Horizontal	Pass
2	167.788	26.53	-27.13	43.5	-16.97	Peak	47.80	200	Horizontal	Pass
3	191.748	33.99	-25.11	43.5	-9.51	Peak	80.10	100	Horizontal	Pass
4	237.095	36.42	-23.07	46.0	-9.58	Peak	118.00	100	Horizontal	Pass
5	308.196	41.61	-21.58	46.0	-4.39	Peak	118.00	100	Horizontal	Pass
6	798.337	37.65	-11.57	46.0	-8.35	Peak	147.20	100	Horizontal	Pass

30 MHz to 1 GHz, ANT V

RE Test case\_FCC Part 15C\_FCC 15.249(2.4G)\_30MHz-1GHz

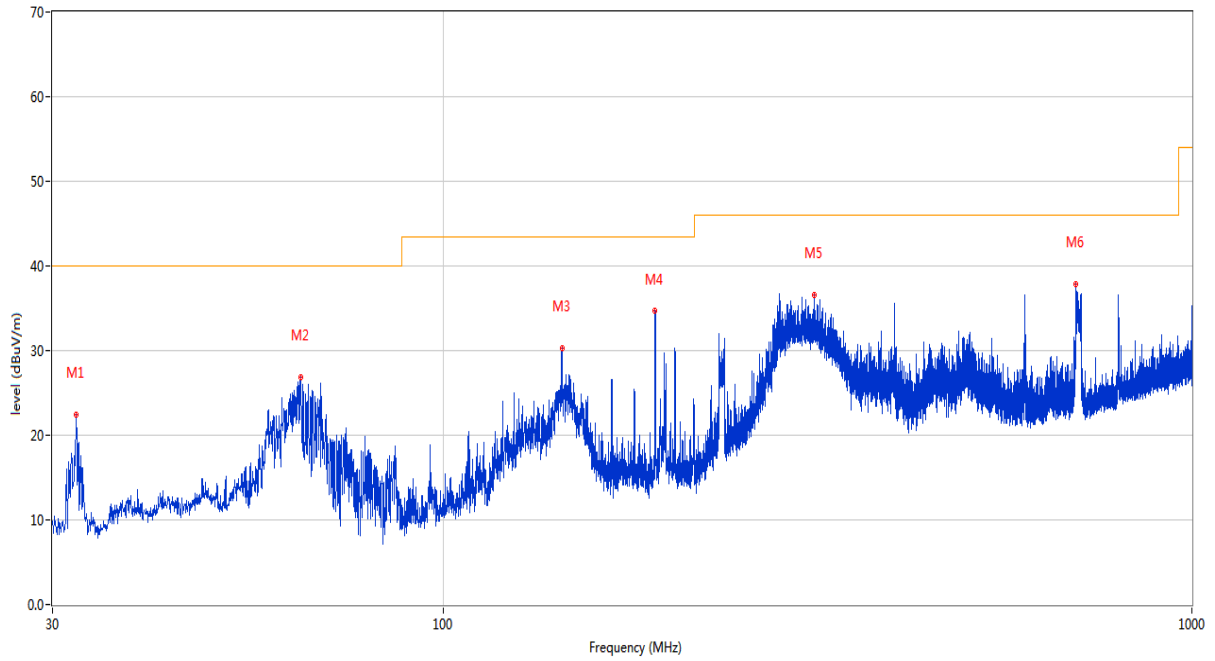

No.	Frequency (MHz)	Results (dBuV/m)	Factor (dB)	Limit (dBuV/m)	Over Limit (dB)	Detector	Table (Degree)	Height (cm)	Antenna	Verdict
1	32.231	22.39	-26.65	40.0	-17.61	Peak	143.30	100	Vertical	Pass
2	64.386	26.91	-24.98	40.0	-13.09	Peak	109.30	100	Vertical	Pass
3	143.830	30.34	-27.72	43.5	-13.16	Peak	3.90	100	Vertical	Pass
4	191.699	34.66	-25.11	43.5	-8.84	Peak	0.00	100	Vertical	Pass
5	313.289	36.54	-21.27	46.0	-9.46	Peak	164.60	100	Vertical	Pass
6	699.882	37.86	-13.69	46.0	-8.14	Peak	360.00	200	Vertical	Pass

Note 1: The marked spikes near 2400 MHz with circle should be ignored because they are Fundamental signal.

Note 2: The spurious from 18GHz-25GHz is noise only, do not show on the report.

**GFSK (BLE 1Mbps) LOW CHANNEL 1 GHz to 18 GHz, ANT H**

RSE (SRD)\_FCC Part 15C\_FCC 15.247(2.4G)\_1GHz-18GHz

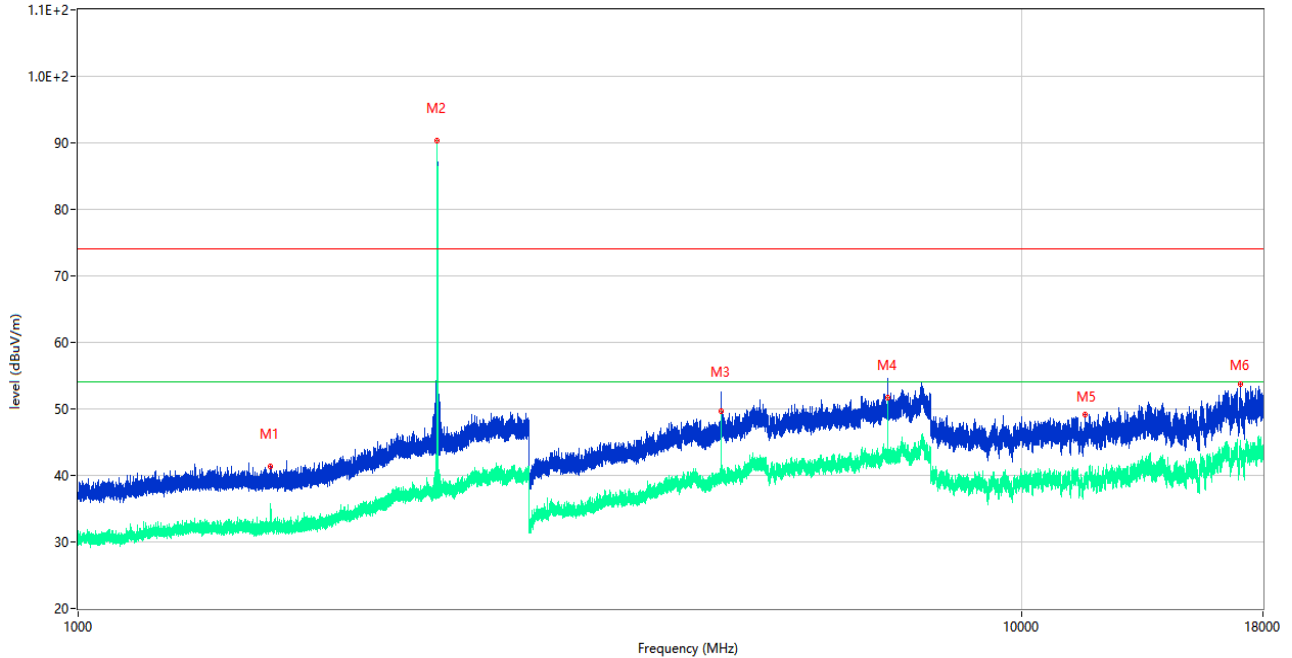

No.	Frequency (MHz)	Results (dBuV/m)	Factor (dB)	Limit (dBuV/m)	Over Limit (dB)	Detector	Table (Degree)	Height (cm)	Antenna	Verdict
1	1599.800	41.32	-17.74	74.0	-32.68	Peak	279.00	150	Horizontal	Pass
1**	1599.800	34.71	-17.74	54.0	-19.29	AV	279.00	150	Horizontal	Pass
2	2401.700	90.44	-13.35	74.0	16.44	Peak	338.00	150	Horizontal	N/A
2**	2401.700	90.14	-13.35	54.0	36.14	AV	338.00	150	Horizontal	N/A
3	4803.750	51.98	-4.15	74.0	-22.02	Peak	309.00	150	Horizontal	Pass
3**	4803.750	49.72	-4.15	54.0	-4.28	AV	309.00	150	Horizontal	Pass
4	7205.500	53.77	-1.03	74.0	-20.23	Peak	292.00	150	Horizontal	Pass
4**	7205.500	51.70	-1.03	54.0	-2.30	AV	292.00	150	Horizontal	Pass
5	11676.026	49.21	-4.33	74.0	-24.79	Peak	43.00	150	Horizontal	Pass
5**	11676.026	38.86	-4.33	54.0	-15.14	AV	43.00	150	Horizontal	Pass
6	17022.450	53.73	0.71	74.0	-20.27	Peak	282.00	150	Horizontal	Pass
6**	17022.450	42.73	0.71	54.0	-11.27	AV	282.00	150	Horizontal	Pass

GFSK (BLE 1Mbps) LOW CHANNEL 1 GHz to 18 GHz, ANT V

RSE (SRD)\_FCC Part 15C\_FCC 15.247(2.4G)\_1GHz-18GHz

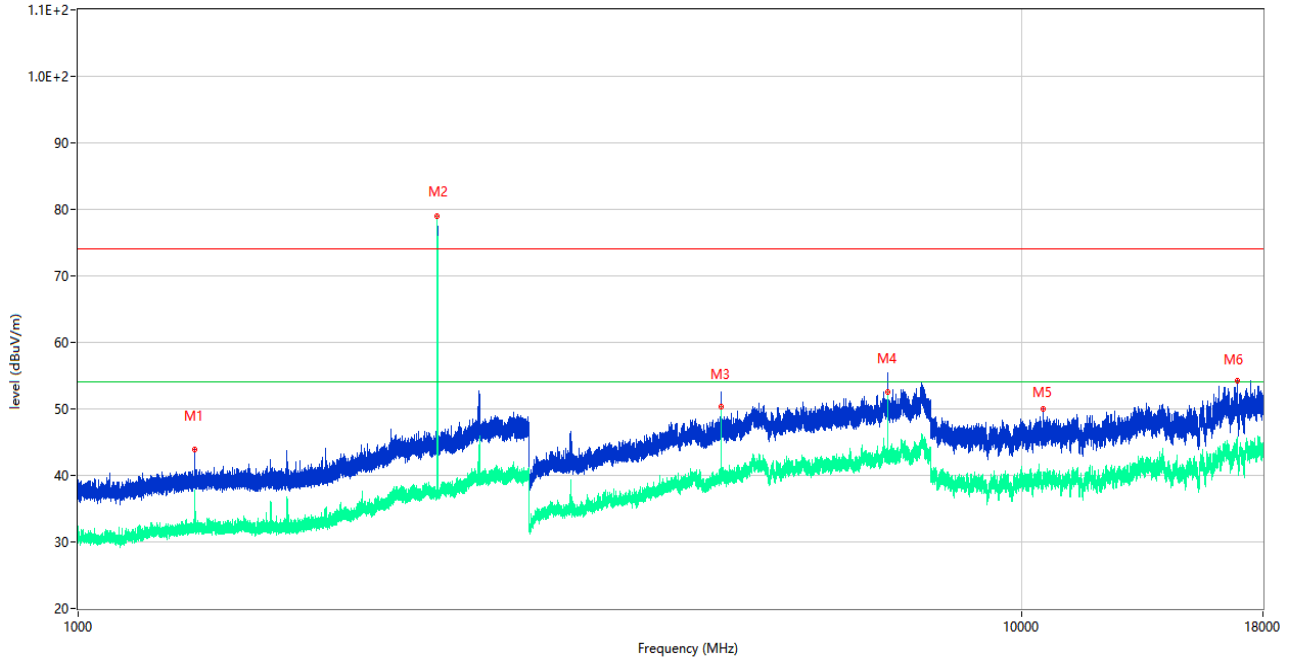

No.	Frequency (MHz)	Results (dBuV/m)	Factor (dB)	Limit (dBuV/m)	Over Limit (dB)	Detector	Table (Degree)	Height (cm)	Antenna	Verdict
1	1330.100	43.91	-17.33	74.0	-30.09	Peak	225.00	150	Vertical	Pass
1**	1330.100	34.04	-17.33	54.0	-19.96	AV	225.00	150	Vertical	Pass
2	2401.900	78.84	-13.34	74.0	4.84	Peak	127.00	150	Vertical	N/A
2**	2401.900	78.91	-13.34	54.0	24.91	AV	127.00	150	Vertical	N/A
3	4803.750	52.58	-4.15	74.0	-21.42	Peak	292.00	150	Vertical	Pass
3**	4803.750	50.33	-4.15	54.0	-3.67	AV	292.00	150	Vertical	Pass
4	7205.250	54.84	-1.02	74.0	-19.16	Peak	341.00	150	Vertical	Pass
4**	7205.250	52.54	-1.02	54.0	-1.46	AV	341.00	150	Vertical	Pass
5	10538.875	50.01	-4.55	74.0	-23.99	Peak	86.00	150	Vertical	Pass
5**	10538.875	39.32	-4.55	54.0	-14.68	AV	86.00	150	Vertical	Pass
6	16896.713	54.18	1.49	74.0	-19.82	Peak	163.00	150	Vertical	Pass
6**	16896.713	44.13	1.49	54.0	-9.87	AV	163.00	150	Vertical	Pass



GFSK (BLE 1Mbps) MIDDLE CHANNEL 1 GHz to 18 GHz, ANT H

RSE (SRD)\_FCC Part 15C\_FCC 15.247(2.4G)\_1GHz-18GHz

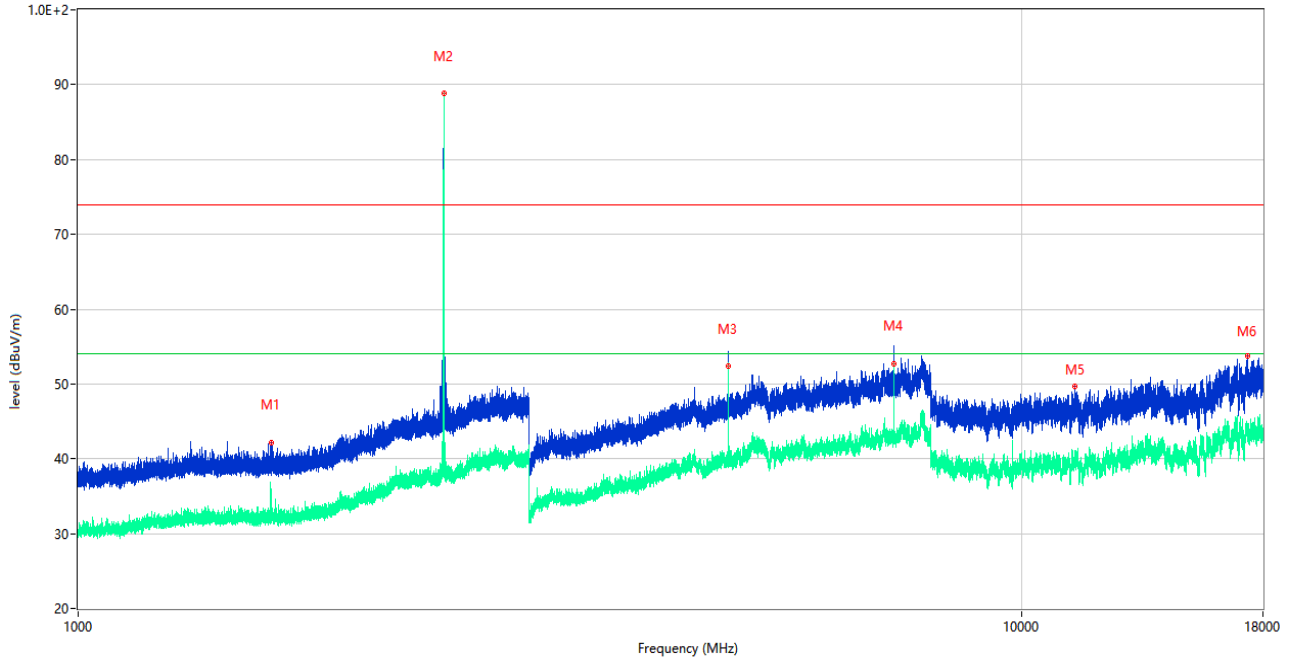

No.	Frequency (MHz)	Results (dBuV/m)	Factor (dB)	Limit (dBuV/m)	Over Limit (dB)	Detector	Table (Degree)	Height (cm)	Antenna	Verdict
1	1600.400	42.22	-17.78	74.0	-31.78	Peak	360.00	150	Horizontal	Pass
1**	1600.400	35.10	-17.78	54.0	-18.90	AV	360.00	150	Horizontal	Pass
2	2439.800	89.00	-12.40	74.0	15.00	Peak	342.00	150	Horizontal	N/A
2**	2439.800	88.84	-12.40	54.0	34.84	AV	342.00	150	Horizontal	N/A
3	4880.000	52.98	-3.68	74.0	-21.02	Peak	210.00	150	Horizontal	Pass
3**	4880.000	52.36	-3.68	54.0	-1.64	AV	210.00	150	Horizontal	Pass
4	7319.500	54.01	-0.72	74.0	-19.99	Peak	53.00	150	Horizontal	Pass
4**	7319.500	52.63	-0.72	54.0	-1.37	AV	53.00	150	Horizontal	Pass
5	11367.276	49.65	-4.39	74.0	-24.35	Peak	273.00	150	Horizontal	Pass
5**	11367.276	40.81	-4.39	54.0	-13.19	AV	273.00	150	Horizontal	Pass
6	17321.175	53.71	1.96	74.0	-20.29	Peak	136.00	150	Horizontal	Pass
6**	17321.175	43.71	1.96	54.0	-10.29	AV	136.00	150	Horizontal	Pass

GFSK (BLE 1Mbps) MIDDLE CHANNEL 1 GHz to 18 GHz, ANT V

RSE (SRD)\_FCC Part 15C\_FCC 15.247(2.4G)\_1GHz-18GHz

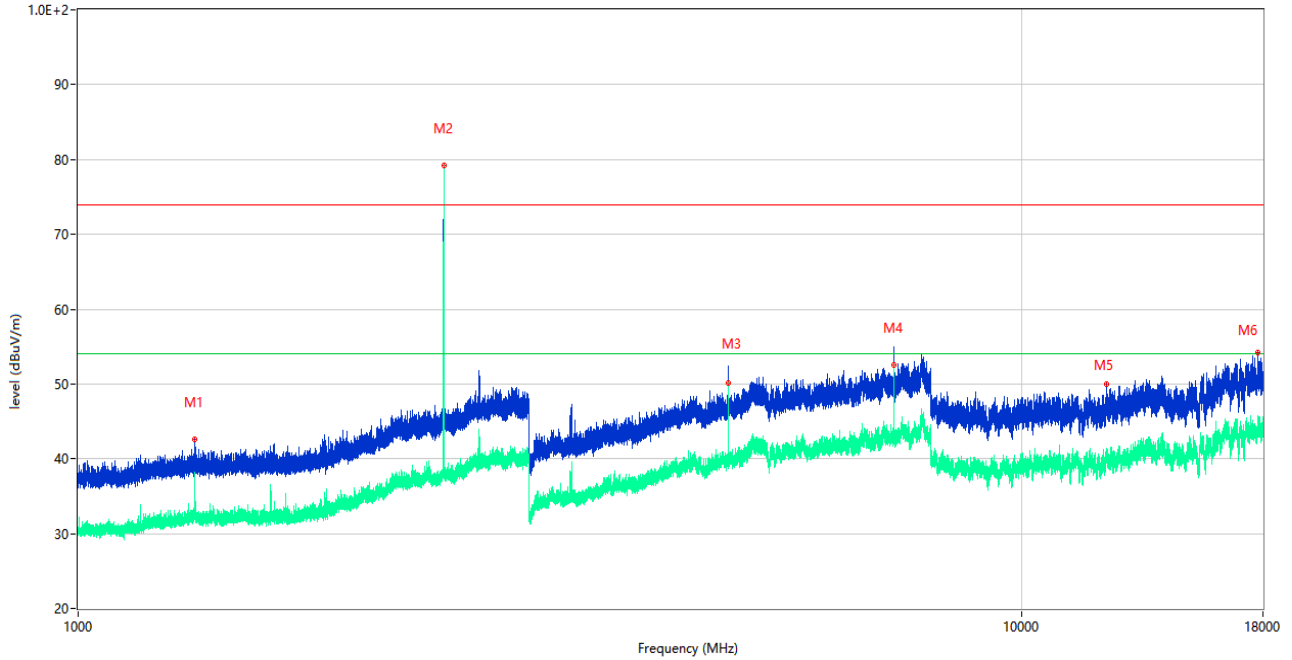

No.	Frequency (MHz)	Results (dBuV/m)	Factor (dB)	Limit (dBuV/m)	Over Limit (dB)	Detector	Table (Degree)	Height (cm)	Antenna	Verdict
1	1327.800	42.54	-17.16	74.0	-31.46	Peak	232.00	150	Vertical	Pass
1**	1327.800	32.10	-17.16	54.0	-21.90	AV	232.00	150	Vertical	Pass
2	2439.800	79.31	-12.40	74.0	5.31	Peak	127.00	150	Vertical	N/A
2**	2439.800	79.20	-12.40	54.0	25.20	AV	127.00	150	Vertical	N/A
3	4879.750	52.09	-3.70	74.0	-21.91	Peak	235.00	150	Vertical	Pass
3**	4879.750	50.19	-3.70	54.0	-3.81	AV	235.00	150	Vertical	Pass
4	7319.500	54.72	-0.72	74.0	-19.28	Peak	39.00	150	Vertical	Pass
4**	7319.500	52.54	-0.72	54.0	-1.46	AV	39.00	150	Vertical	Pass
5	12296.138	50.06	-2.47	74.0	-23.94	Peak	331.00	150	Vertical	Pass
5**	12296.138	39.27	-2.47	54.0	-14.73	AV	331.00	150	Vertical	Pass
6	17796.825	54.18	3.18	74.0	-19.82	Peak	161.00	150	Vertical	Pass
6**	17796.825	44.31	3.18	54.0	-9.69	AV	161.00	150	Vertical	Pass

GFSK (BLE 1Mbps) HIGH CHANNEL 1 GHz to 18 GHz, ANT H

RSE (SRD)\_FCC Part 15C\_FCC 15.247(2.4G)\_1GHz-18GHz

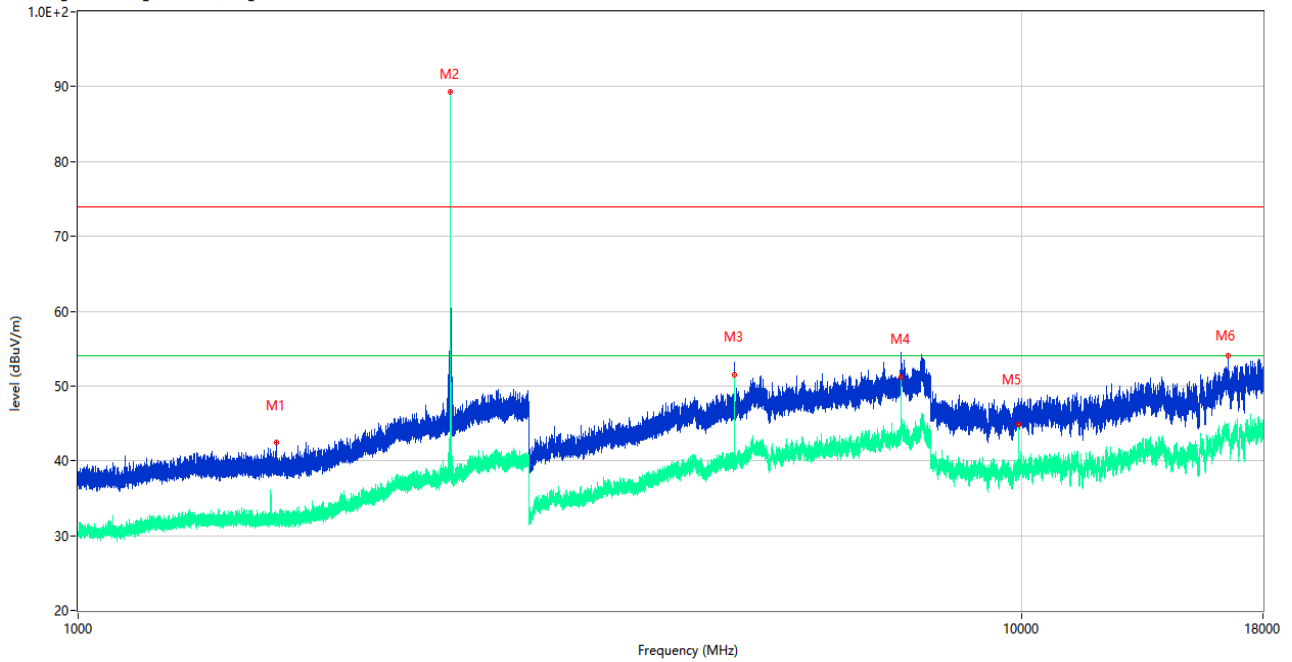

No.	Frequency (MHz)	Results (dBuV/m)	Factor (dB)	Limit (dBuV/m)	Over Limit (dB)	Detector	Table (Degree)	Height (cm)	Antenna	Verdict
1	1621.500	42.41	-17.38	74.0	-31.59	Peak	110.00	150	Horizontal	Pass
1**	1621.500	32.61	-17.38	54.0	-21.39	AV	110.00	150	Horizontal	Pass
2	2480.000	89.27	-13.08	74.0	15.27	Peak	342.00	150	Horizontal	N/A
2**	2480.000	87.59	-13.08	54.0	33.59	AV	342.00	150	Horizontal	N/A
3	4959.750	52.96	-4.17	74.0	-21.04	Peak	226.00	150	Horizontal	Pass
3**	4959.750	51.47	-4.17	54.0	-2.53	AV	226.00	150	Horizontal	Pass
4	7439.500	54.44	0.29	74.0	-19.56	Peak	251.00	150	Horizontal	Pass
4**	7439.500	51.20	0.29	54.0	-2.80	AV	251.00	150	Horizontal	Pass
5	9919.000	48.30	-5.14	74.0	-25.70	Peak	305.00	150	Horizontal	Pass
5**	9919.000	44.80	-5.14	54.0	-9.20	AV	305.00	150	Horizontal	Pass
6	16538.401	54.02	0.02	74.0	-19.98	Peak	265.00	150	Horizontal	Pass
6**	16538.401	43.81	0.02	54.0	-10.19	AV	265.00	150	Horizontal	Pass

GFSK (BLE 1Mbps) HIGH CHANNEL 1 GHz to 18 GHz, ANT V

RSE (SRD)\_FCC Part 15C\_FCC 15.247(2.4G)\_1GHz-18GHz

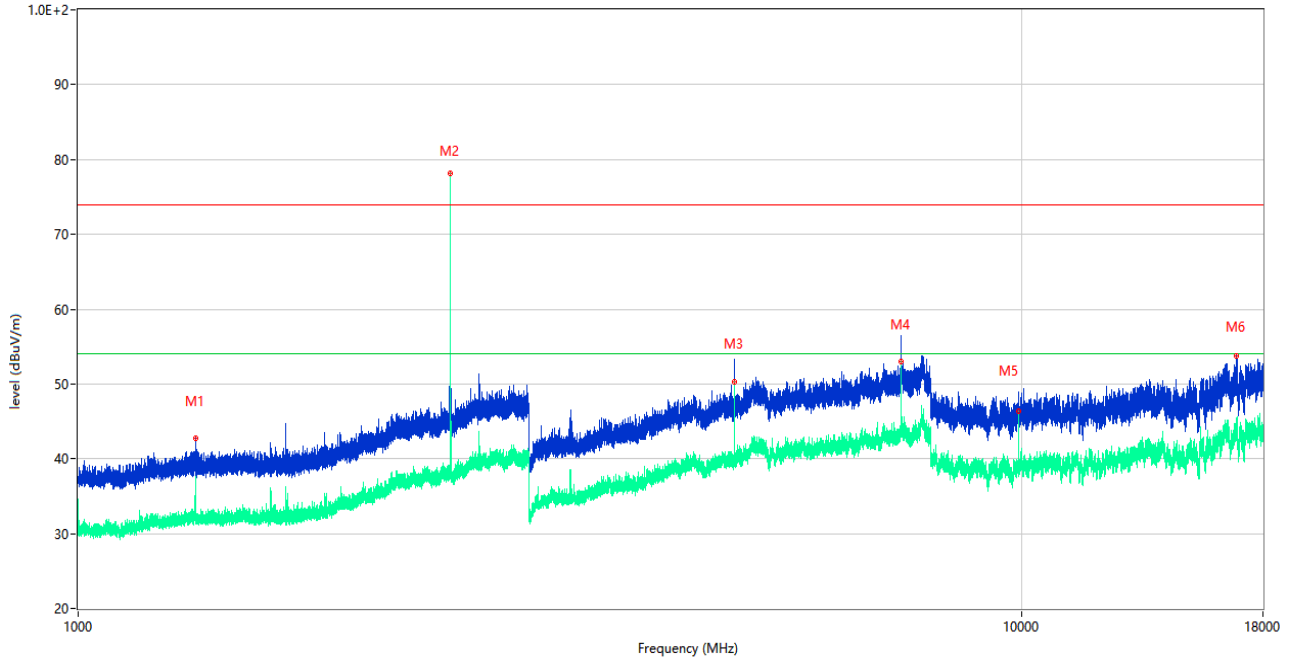

No.	Frequency (MHz)	Results (dBuV/m)	Factor (dB)	Limit (dBuV/m)	Over Limit (dB)	Detector	Table (Degree)	Height (cm)	Antenna	Verdict
1	1333.200	42.73	-17.53	74.0	-31.27	Peak	232.00	150	Vertical	Pass
1**	1333.200	32.26	-17.53	54.0	-21.74	AV	232.00	150	Vertical	Pass
2	2479.700	78.44	-13.05	74.0	4.44	Peak	205.00	150	Vertical	N/A
2**	2479.700	77.45	-13.05	54.0	23.45	AV	205.00	150	Vertical	N/A
3	4960.000	50.71	-4.17	74.0	-23.29	Peak	280.00	150	Vertical	Pass
3**	4960.000	50.24	-4.17	54.0	-3.76	AV	280.00	150	Vertical	Pass
4	7439.500	55.24	0.29	74.0	-18.76	Peak	53.00	150	Vertical	Pass
4**	7439.500	52.97	0.29	54.0	-1.03	AV	53.00	150	Vertical	Pass
5	9919.237	48.79	-5.14	74.0	-25.21	Peak	205.00	150	Vertical	Pass
5**	9919.237	46.40	-5.14	54.0	-7.60	AV	205.00	150	Vertical	Pass
6	16890.937	53.76	1.44	74.0	-20.24	Peak	102.00	150	Vertical	Pass
6**	16890.937	45.43	1.44	54.0	-8.57	AV	102.00	150	Vertical	Pass

## A.7 Band Edge (Restricted-band band-edge)

Note <sup>1</sup>: The lowest and highest channels are tested to verify the band edge emissions. Please refer to the following the plots for emissions values.

Note <sup>2</sup>: The test data all are tested in the vertical and horizontal antenna which the trace is max hold. So these plots have shown the worst case.

Note <sup>3</sup>: According the ANSI C63.10-2013, where limits are specified for both average and peak (or quasi-peak) detector functions, if the peak (or quasi-peak) measured value complies with the average limit, it is unnecessary to perform an average measurement.

Note <sup>4</sup>: The Level (dBuV/m) has been corrected by factor.

### Test Data and Plots

#### GFSK (BLE 1Mbps) LOW CHANNEL

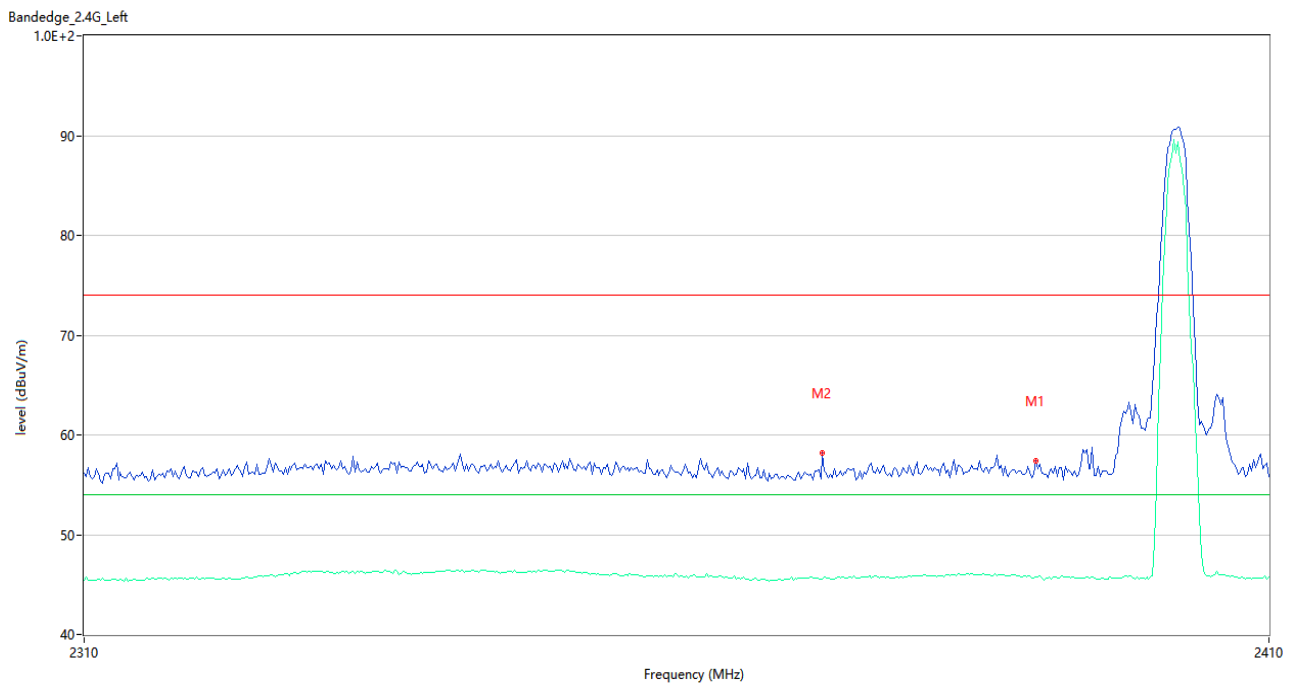

No.	Frequency (MHz)	Results (dBuV/m)	Factor (dB)	Limit (dBuV/m)	Over Limit (dB)	Detector	Table (Degree)	Height (cm)	Antenna	Verdict
1	2390.000	57.44	1.62	74.0	-16.56	Peak	59.00	150	Horizontal	Pass
1**	2390.000	45.67	1.62	54.0	-8.33	AV	59.00	150	Horizontal	Pass
2	2371.833	58.20	1.40	74.0	-15.80	Peak	104.00	150	Horizontal	Pass
2**	2371.833	45.49	1.40	54.0	-8.51	AV	104.00	150	Horizontal	Pass

**GFSK (BLE 1Mbps) HIGH CHANNEL**

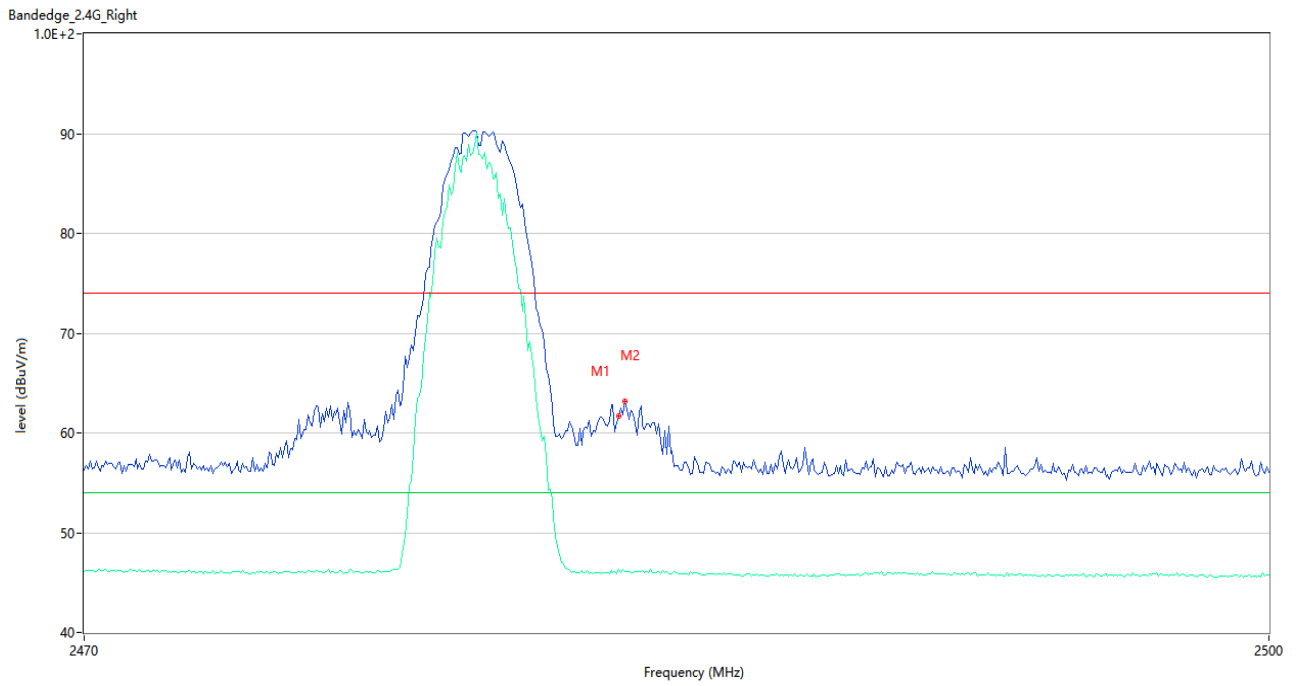

No.	Frequency (MHz)	Results (dBuV/m)	Factor (dB)	Limit (dBuV/m)	Over Limit (dB)	Detector	Table (Degree)	Height (cm)	Antenna	Verdict
1	2483.500	61.72	1.98	74.0	-12.28	Peak	340.00	150	Horizontal	Pass
1**	2483.500	46.30	1.98	54.0	-7.70	AV	340.00	150	Horizontal	Pass
2	2483.650	63.13	1.99	74.0	-10.87	Peak	342.00	150	Horizontal	Pass
2**	2483.650	46.09	1.99	54.0	-7.91	AV	342.00	150	Horizontal	Pass

## A.8 Power Spectral Density (PSD)

### Test Data

GFSK (BLE 1Mbps)			
Channel	Spectral power density (dBm/3kHz)	Limit (dBm/3kHz)	Verdict
Low Channel	-20.02	8	Pass
Middle Channel	-18.52	8	Pass
High Channel	-20.95	8	Pass

### Test Plots

GFSK (BLE 1Mbps) LOW CHANNEL

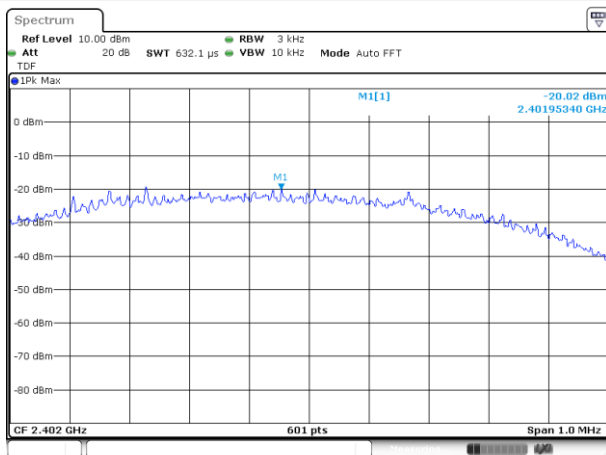

Date: 24 JUN 2022 09:04:17

GFSK (BLE 1Mbps) MIDDLE CHANNEL

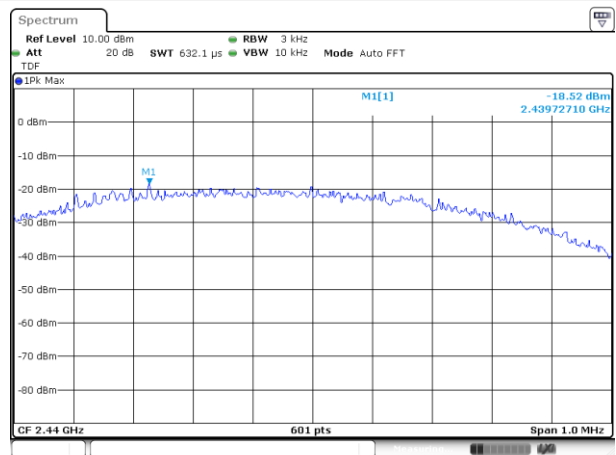

Date: 24 JUN 2022 09:06:18

GFSK (BLE 1Mbps) HIGH CHANNEL

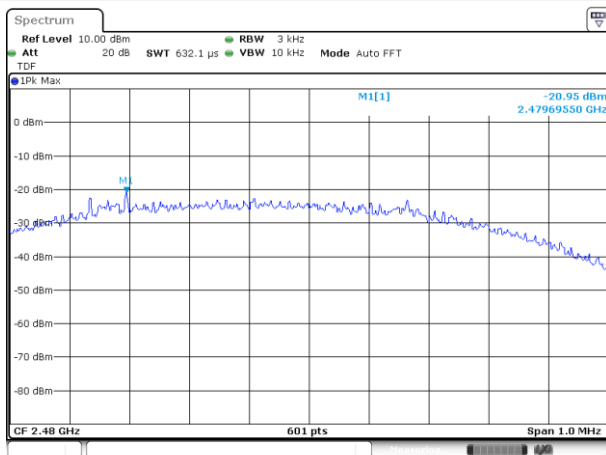

Date: 24 JUN 2022 09:09:32

## **ANNEX B TEST SETUP PHOTOS**

Please refer the document “BL-SZ2240235-AR.PDF”.

## **ANNEX C EUT EXTERNAL PHOTOS**

Please refer the document “BL-SZ2240235-AW.PDF”.

## **ANNEX D EUT INTERNAL PHOTOS**

Please refer the document “BL-SZ2240235-AI.PDF”.



## Statement

1. The laboratory guarantees the scientificity, accuracy and impartiality of the test, and is responsible for all the information in the report, except the information provided by the customer. The customer is responsible for the impact of the information provided on the validity of the results.
2. The report without China inspection body and laboratory Mandatory Approval (CMA) mark has no effect of proving to the society.
3. For the report with CNAS mark or A2LA mark, the items marked with "☆" are not within the accredited scope.
4. This report is invalid if it is altered, without the signature of the testing and approval personnel, or without the "inspection and testing dedicated stamp" or test report stamp.
5. The test data and results are only valid for the tested samples provided by the customer.
6. This report shall not be partially reproduced without the written permission of the laboratory.
7. Any objection shall be raised to the laboratory within 30 days after receiving the report.

--END OF REPORT--