

GRILL INSERT ACCENT LIGHT KIT



P/N 2890566

MISSING OR DAMAGED PARTS

Before beginning assembly, inspect the kit and its component(s) to be sure all parts and tools are accounted for and not damaged. If missing parts or parts are damaged, please contact your Selling Dealer for assistance.

If your accessory was purchased online, please contact POLARIS® customer service at **1-800-POLARIS** (US & Canada only).

APPLICATION

Verify accessory fitment at www.polaris.com.

KIT CONTENTS

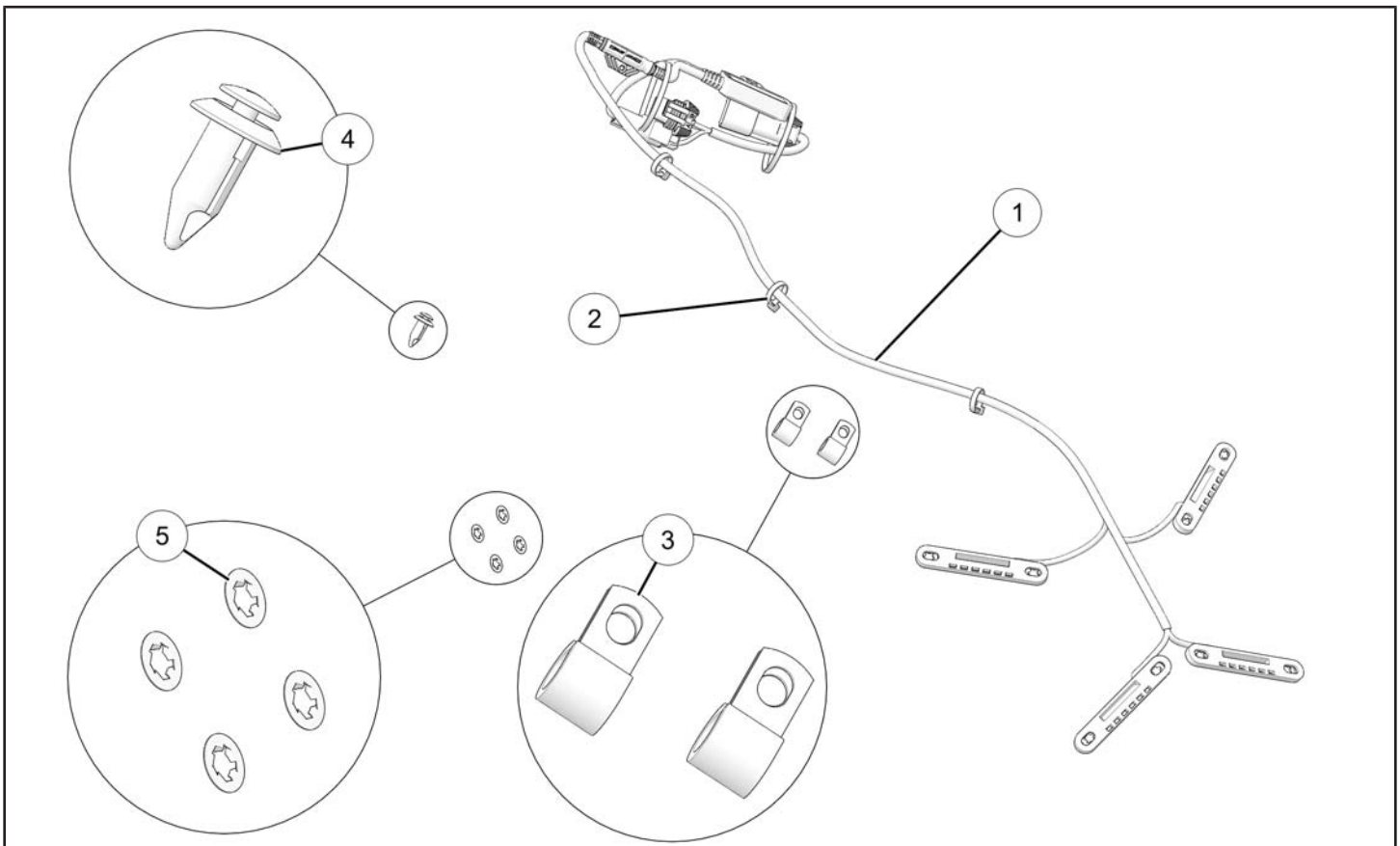

REF	QTY	PART DESCRIPTION	P/N AVAILABLE SEPARATELY
1	1	Grill Insert Accent Light	n/a
2	5	Cable Tie	7080138
3	2	Hose Clamp, Coated	7081472
4	1	Push-Pin Rivet	7661855
5	20	Retainer, Bolt, 1/4 -20 in	7670154

TOOLS REQUIRED

- Safety Glasses
- Drill
- Drill Bit:
 - 5/16 in (8 mm)
- Pliers, Side Cutting
- Socket Set, Metric
- Torque Wrench

IMPORTANT

Your Grill Insert Accent Light Kit is exclusively designed for your vehicle. Please read the installation instructions thoroughly before beginning. Installation is easier if the vehicle is clean and free of debris. For your safety, and to ensure a satisfactory installation, perform all installation steps correctly in the sequence shown.

INSTALLATION INSTRUCTIONS

VEHICLE PREPARATION

GENERAL

1. Park vehicle on a flat surface.
2. Push engine stop switch to OFF position.
3. Turn key to OFF position and remove key.

REMOVE SIDE PANEL

1. Turn three side panel latches toward rear of snowmobile to release, then remove side panel.

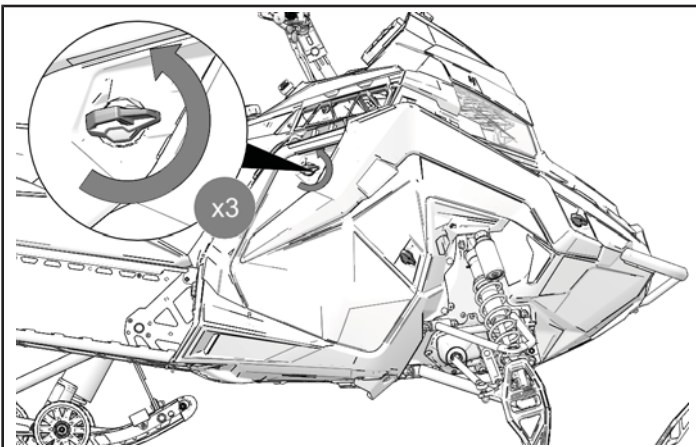

REMOVE HOOD

1. Turn hood fasteners counter-clockwise to release hood.

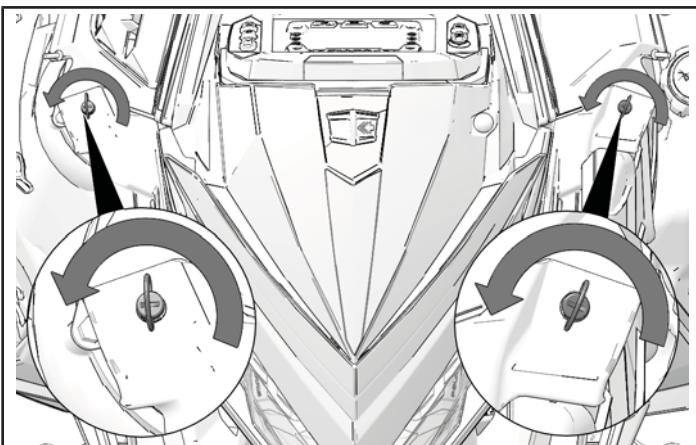

2. Pull sides of hood out away from side panel fasteners.

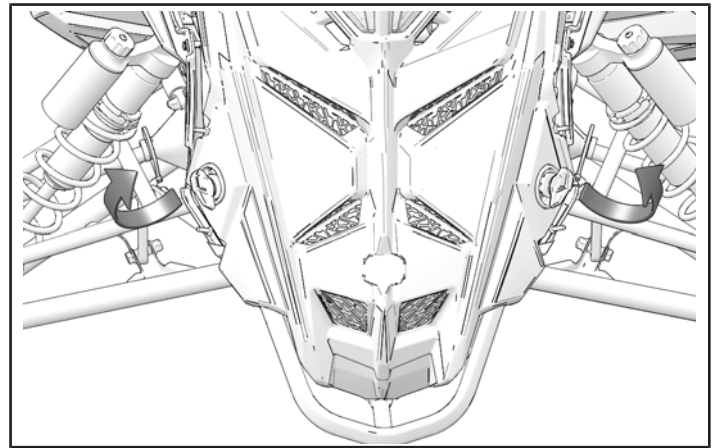

3. Lift hood up and away from snowmobile.

NOTICE

Disconnect wiring when removing hood.

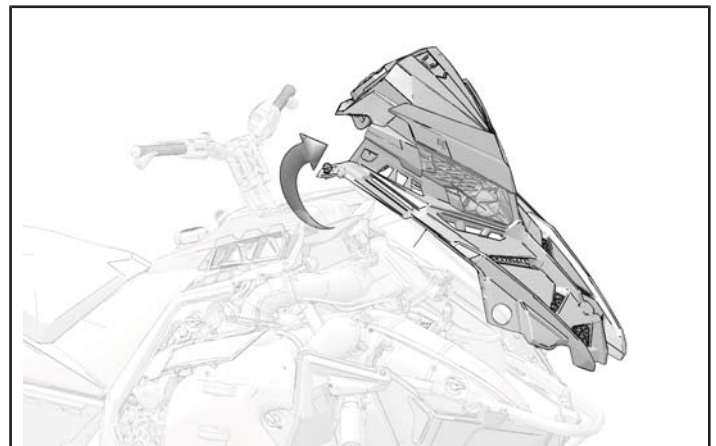

ACCESSORY INSTALLATION

GRILL INSERT ACCENT LIGHT INSTALLATION

1. Disconnect grill lights lead from module.

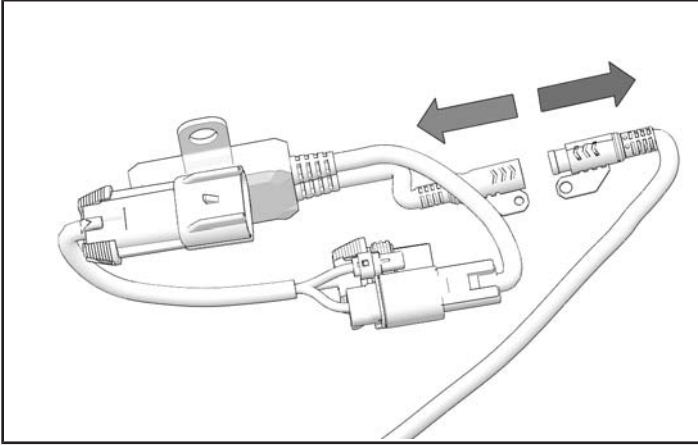

2. Disconnect grill lights adapter pigtail from module.

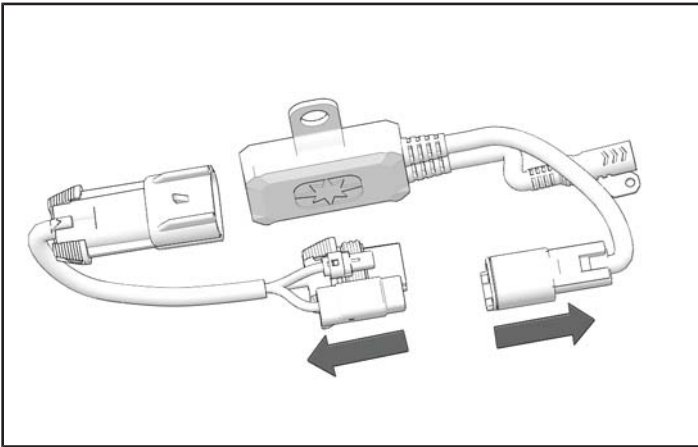

3. Remove 16 retainers from grill inserts. Use a side cutter to remove retainers.

IMPORTANT

Take care not to damage or break mounting standoffs on hood.

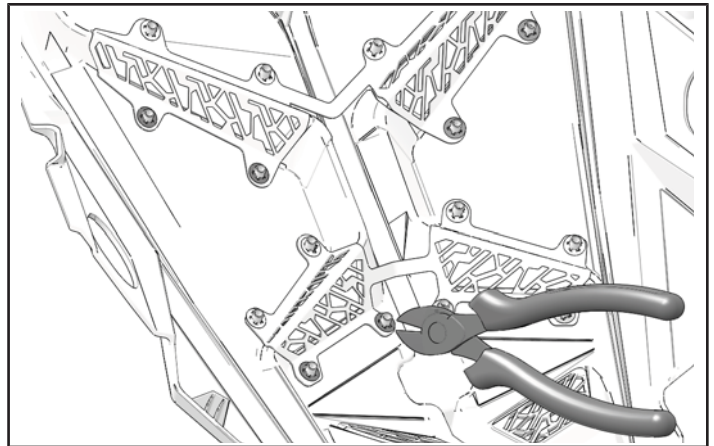
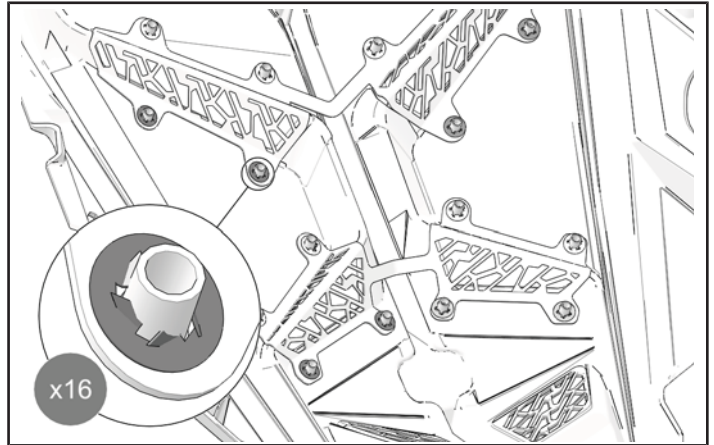

4. Remove and keep two grill inserts.

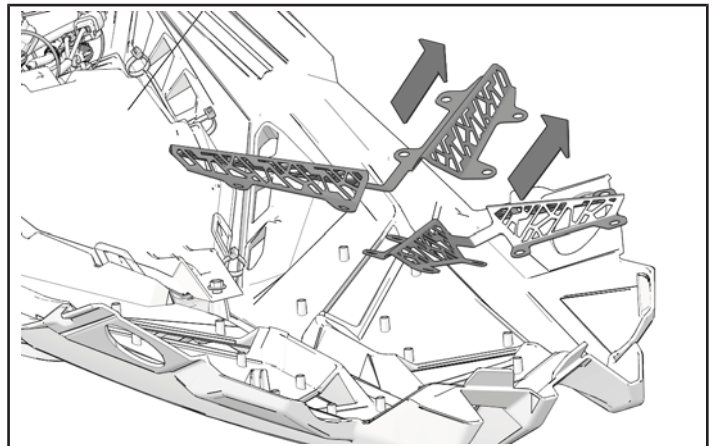

- Put grill insert accent lights ① on hood. Make sure wiring is placed in center rib on hood.

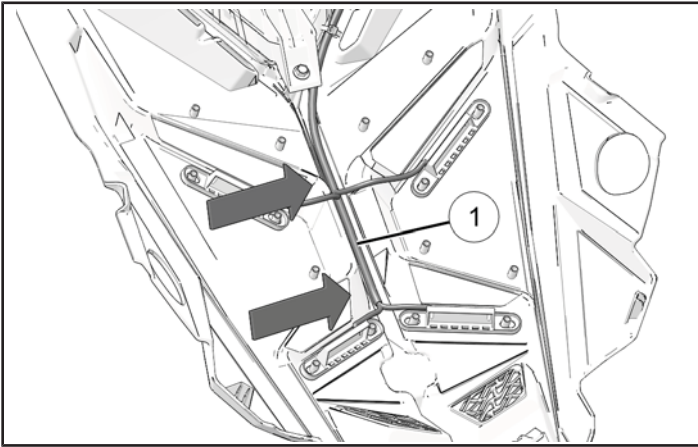

- Attach grill inserts using eight clips ⑤. Make sure grill insert accent light ① wiring is not pinched.

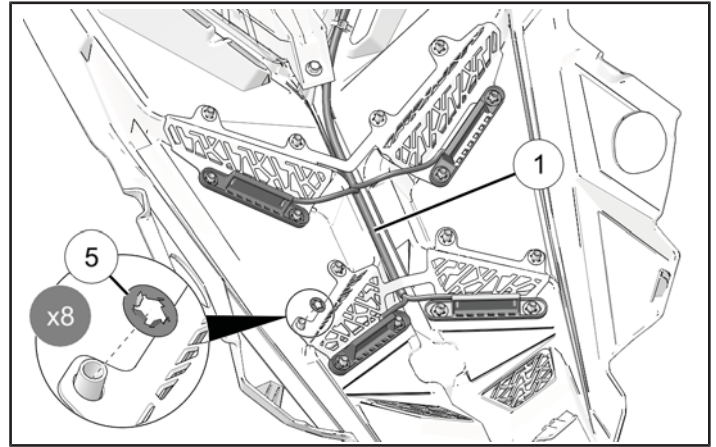

- Install kept grill inserts on mounting standoffs. Make sure grill insert accent light ① wiring is placed under grill inserts.

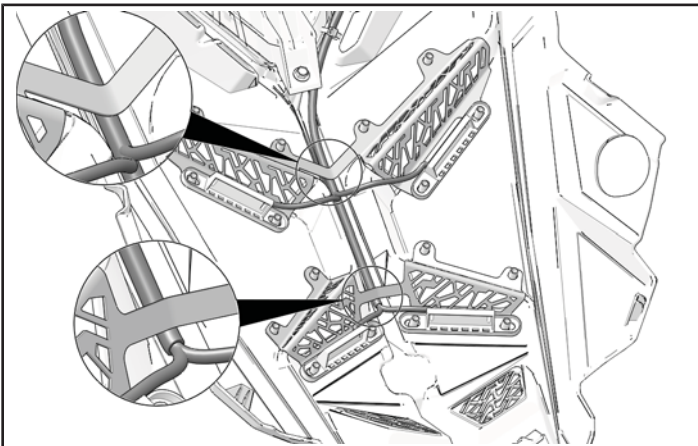

- Install grill insert accent light ① onto grill standoffs using eight clips ⑤. Install lights on front side of grill openings.

TIP

Use a 10mm socket to install retainers.

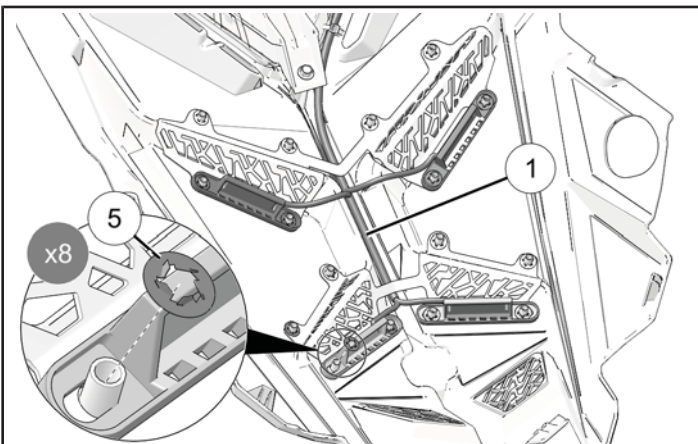

IDENTIFY HEADLIGHT

- Identify type of headlight. Routing will be different depending on type of headlight installed on snowmobile.

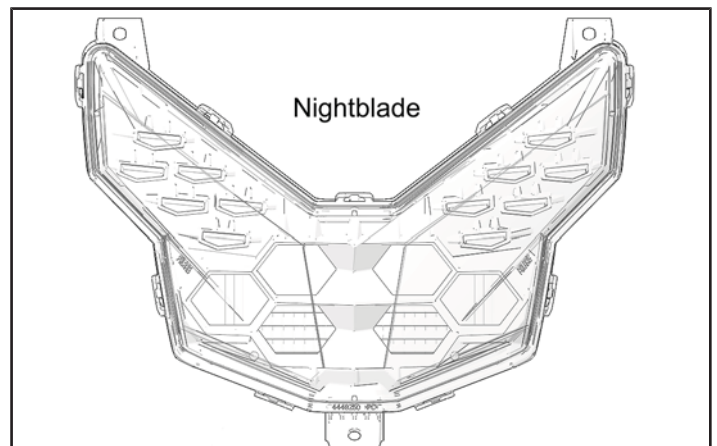
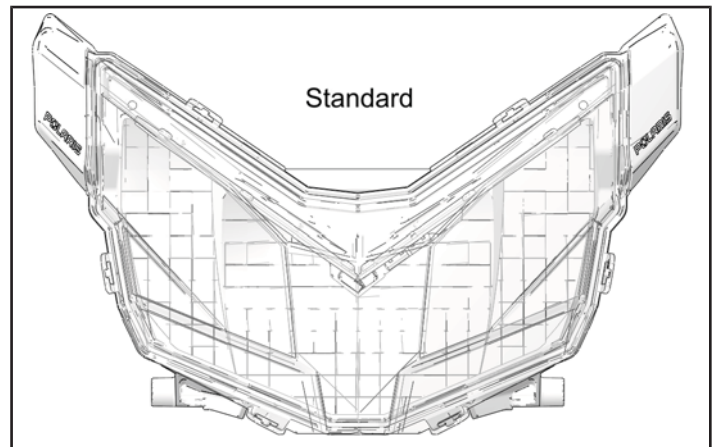

INSTALLATION WITH STANDARD HEADLIGHT

1. Route wiring along left side of headlight assembly. Attach using cable ties ②.

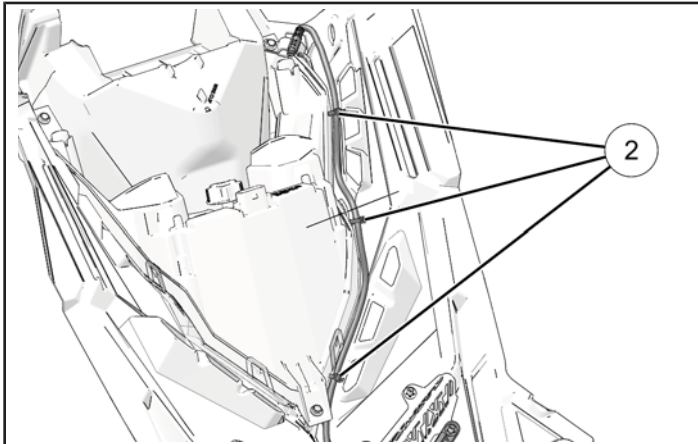

INSTALLATION WITH NIGHTBLADE HEADLIGHT

NOTICE

Installation on models equipped with Nightblade headlight will not use cable ties to attach wiring.

1. Attach grill insert accent light ① wiring to hood using hose clamp ③ and existing headlight mounting screw ④.

TORQUE

Headlight Mounting Screw:
22 in-lbs (2.5 N·m)

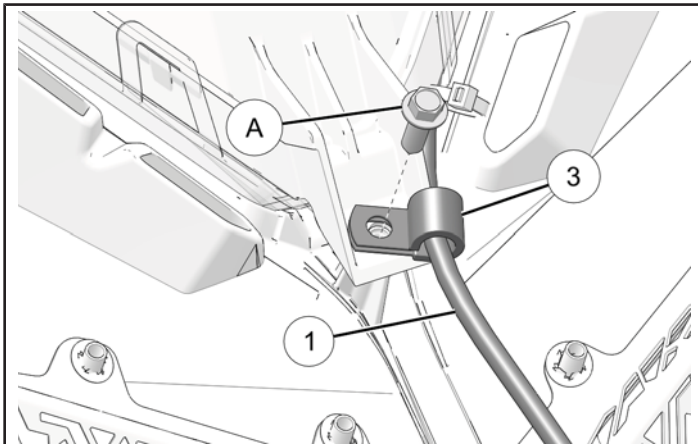

CONTROLLER INSTALLATION

1. Mark drill location in position shown.

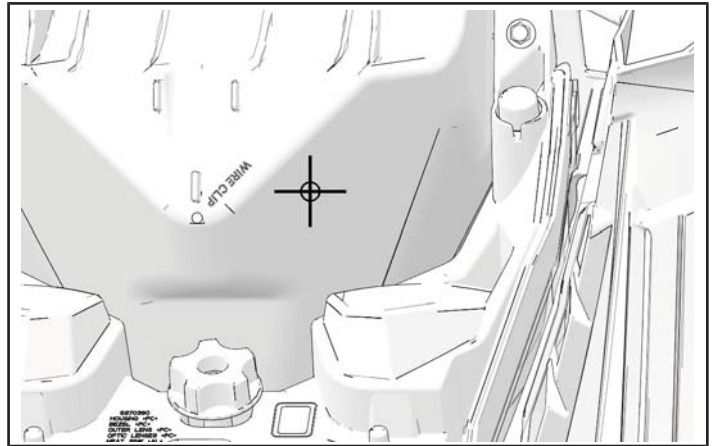

2. Drill hole at marked location.

IMPORTANT

Make sure storage compartment is empty before drilling. Remove any objects or storage bags. Control drill depth.

MEASUREMENT

Drill Bit Size:
5/16 in (8 mm)

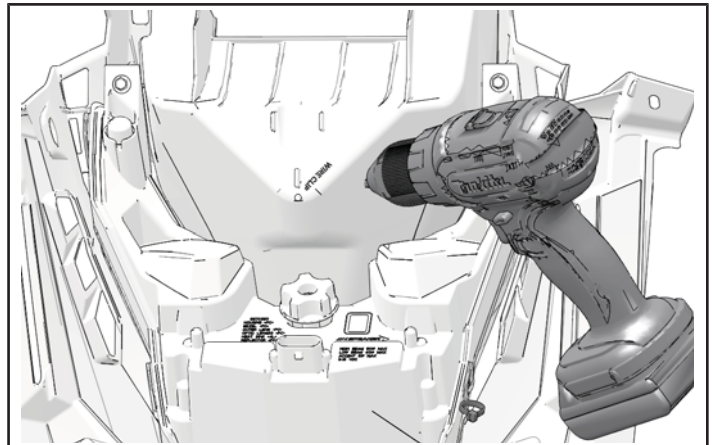

3. Install controller using push-pin rivet ④.

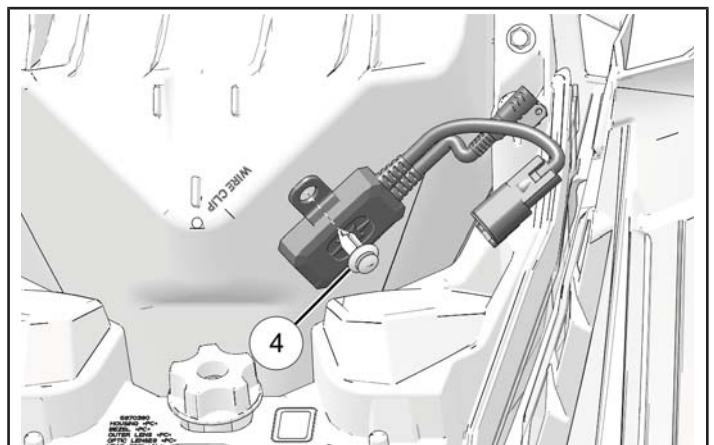

4. Connect grill insert accent light lead to control module.

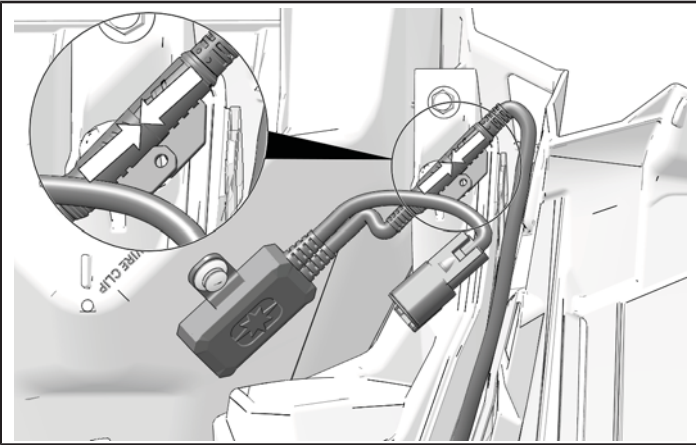

6. Install cable ties (2) around wiring.

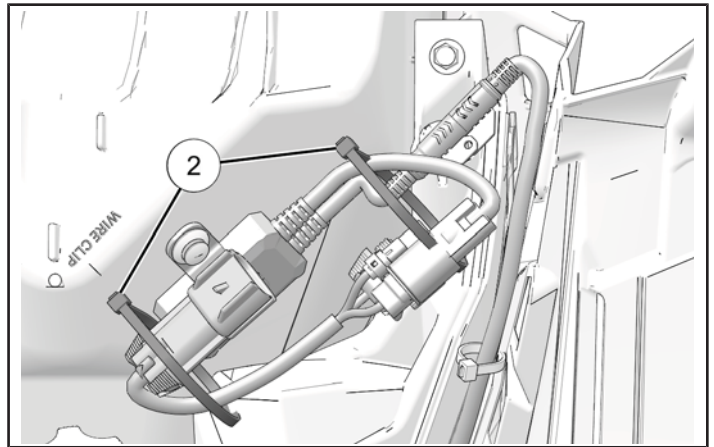

5. Connect pigtail adapter to module.

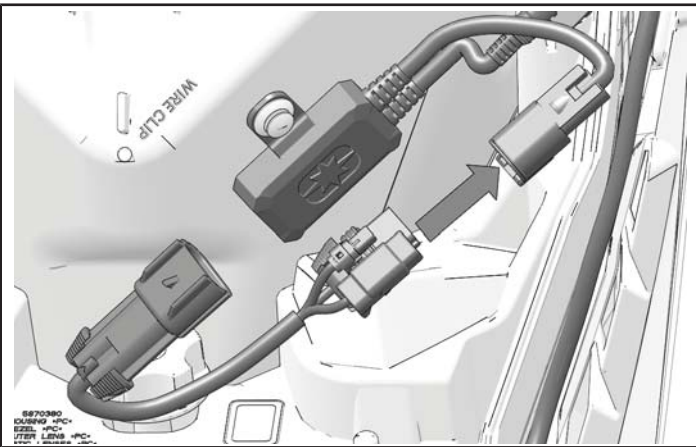

7. Attach grill insert accent light (1) pigtail adapter to snowmobile accessory plug.

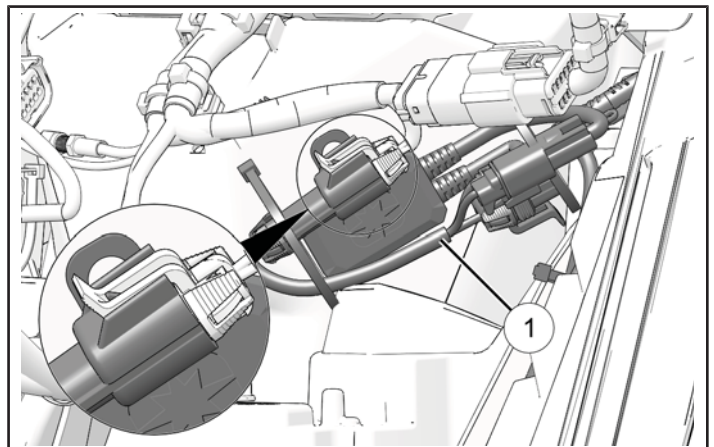

VEHICLE REASSEMBLY

INSTALL HOOD

1. Install hood on snowmobile. Make sure tabs fit inside front pan.

NOTICE

Make sure to connect hood wiring when installing hood.

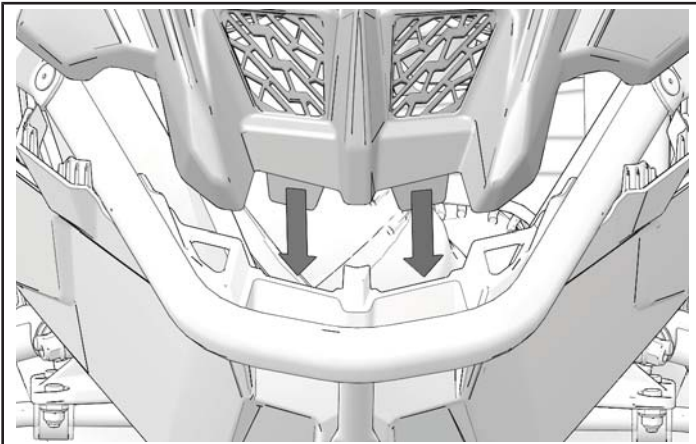
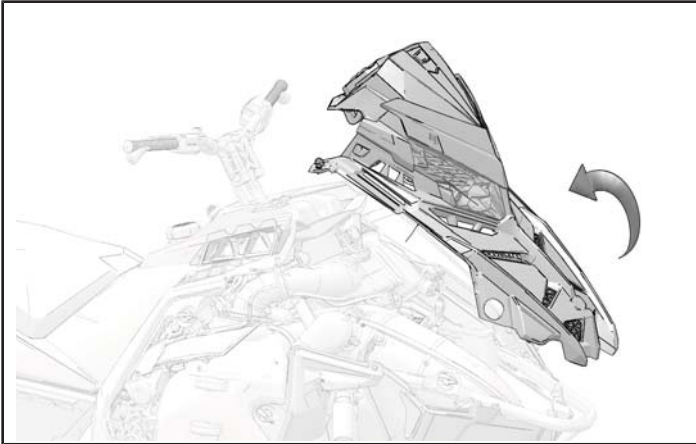

2. Pull sides of hood out and install over side panel fasteners.

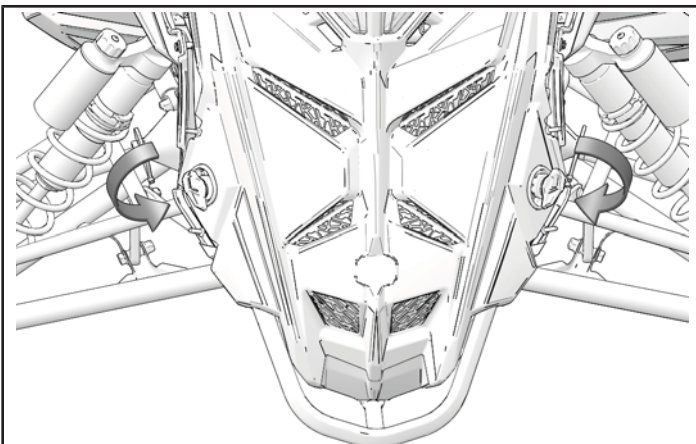

3. Turn hood fasteners clockwise to lock hood.

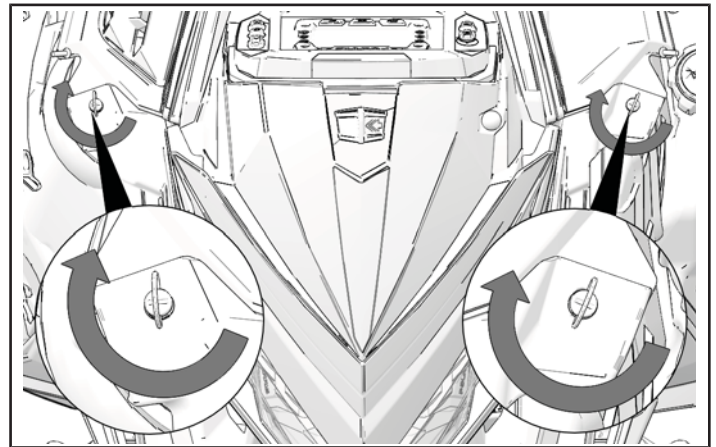

INSTALL RIGHT SIDE PANEL

1. Install side panel on snowmobile. Turn fasteners toward front of snowmobile to lock in place.

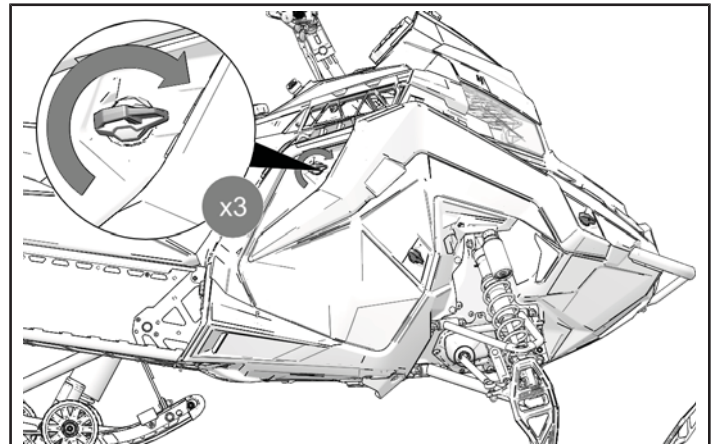

OPERATION

1. Download the XK Glow app, "XKchrome."



2. In the phone's device settings, pair the controller to the app on the phone. When the controller is paired, it will appear at the top of the phone's device list.
3. The XKchrome app will guide the user through the app's features and how to control the lights.

FCC Statement

Changes or modifications not expressly approved by the party responsible for compliance could void the user's authority to operate the equipment.

This device complies with part 15 of the FCC rules. Operation is subject to the following two conditions: (1) this device may not cause harmful interference, and (2) this device must accept any interference received, including interference that may cause undesired operation.

NOTE: This equipment has been tested and found to comply with the limits for a Class B digital device, pursuant to part 15 of the FCC Rules. These limits are designed to provide reasonable protection against harmful interference in a residential installation. This equipment generates uses and can radiate radio frequency energy and, if not installed and used in accordance with the instructions, may cause harmful interference to radio communications. However, there is no guarantee that interference will not occur in a particular installation. If this equipment does cause harmful interference to radio or television reception, which can be determined by turning the equipment off and on, the user is encouraged to try to correct the interference by one or more of the following measures:

- Reorient or relocate the receiving antenna.
- Increase the separation between the equipment and receiver.
- Connect the equipment into an outlet on a circuit different from that to which the receiver is connected.
- Consult the dealer or an experienced radio/TV technician for help important announcement

Radiation Exposure Statement

This equipment complies with FCC radiation exposure limits set forth for an uncontrolled environment. This equipment should be installed and operated with minimum distance 20cm between the radiator and your body.

This transmitter must not be co-located or operating in conjunction with any other antenna or transmitter.

IC Statement

This device contains licence-exempt transmitter(s)/receiver(s) that comply with Innovation, Science and Economic Development Canada's licence-exempt RSS(s). Operation is subject to the following two conditions: (1) This device may not cause interference. (2) This device must accept any interference, including interference that may cause undesired operation of the device.

L'émetteur/récepteur exempt de licence contenu dans le présent appareil est conforme aux CNR d'Innovation, Sciences et Développement économique Canada applicables aux appareils radio exempts

de licence. L'exploitation est autorisée aux deux conditions suivantes : 1) L'appareil ne doit pas produire de brouillage; 2) L'appareil doit accepter tout brouillage radioélectrique subi, même si le brouillage est susceptible d'en compromettre le fonctionnement.

This equipment complies with Industry Canada radiation exposure limits set forth for an uncontrolled environment.

Cet équipement est conforme à l'exposition aux rayonnements Industry Canada limites établies pour un environnement non contrôlé.

Radiation Exposure Statement

This equipment complies with Canada radiation exposure limits set forth for an uncontrolled environment. This equipment should be installed and operated with minimum distance 20cm between the radiator & your body.

Cet équipement est conforme Canada limites d'exposition aux radiations dans un environnement non contrôlé. Cet équipement doit être installé et utilisé à distance minimum de 20cm entre le radiateur et votre corps.