

HANDGUARD ACCENT LIGHT KIT



P/N 2890509

MISSING OR DAMAGED PARTS

Before beginning assembly, inspect the kit and its component(s) to be sure all parts and tools are accounted for and not damaged. If missing parts or parts are damaged, please contact your Selling Dealer for assistance.

If your accessory was purchased online, please contact POLARIS® customer service at **1-800-POLARIS** (US & Canada only).

APPLICATION

Verify accessory fitment at www.polaris.com.

REQUIRED SOLD SEPARATELY

Only parts for installation of the Handguard Accent Light Kit are included. For complete installation, the following additional kit is required (sold separately):

- *Defend Handguards*, P/N 2884616-XXX

NOTICE

XXX = Product Family® color code (For example: 266 = Black)

KIT CONTENTS

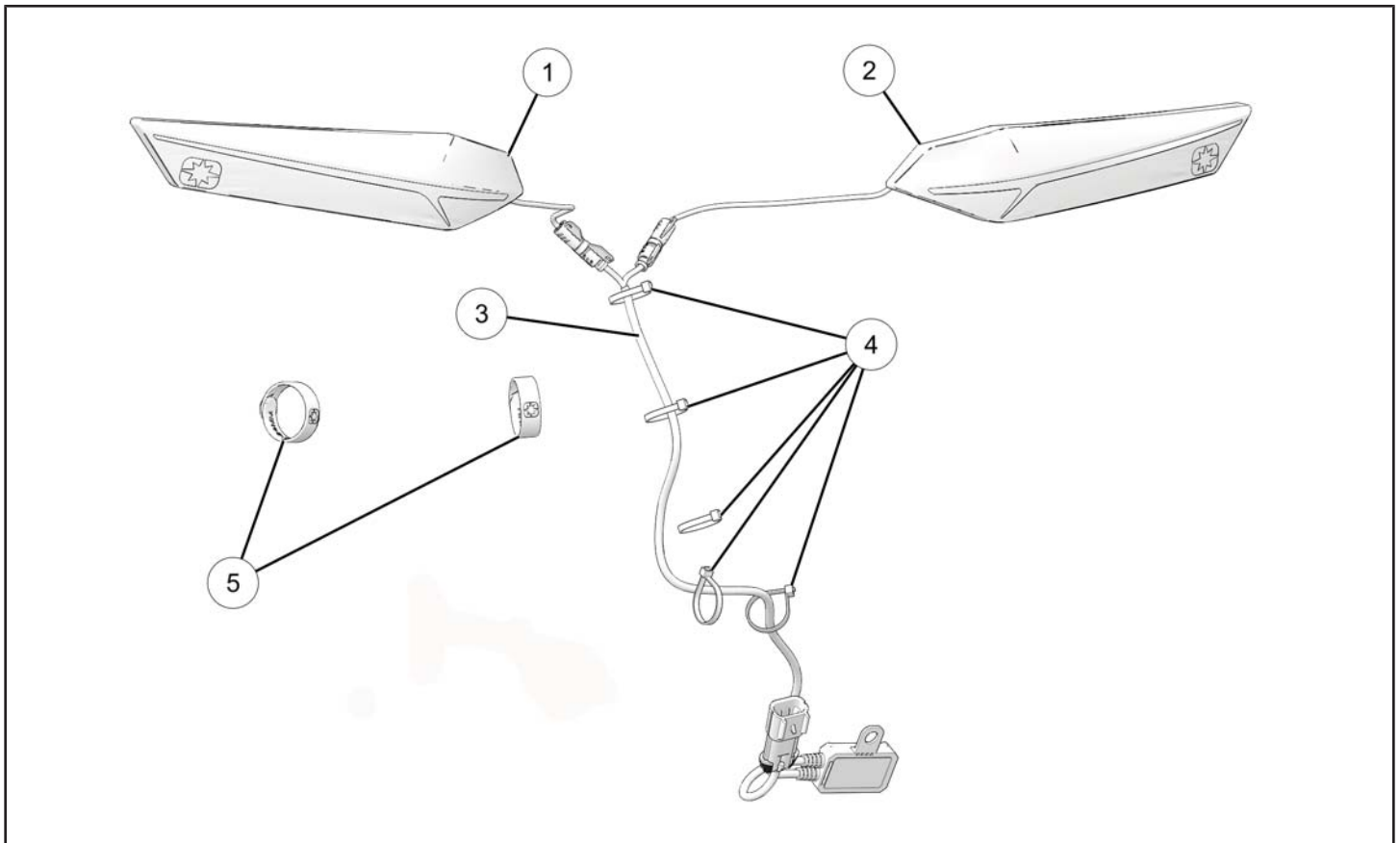

REF	QTY	PART DESCRIPTION	P/N AVAILABLE SEPARATELY
1	1	RGB Handguard Accent Light, Right	n/a
2	1	RGB Handguard Accent Light, Left	n/a
3	1	RGB Handguard Accent Light Controller Harness	n/a
4	5	Cable Tie	7080138
5	2	Rubber Clamp	5417510

TOOLS REQUIRED

- Safety Glasses
- Cutting Tool
- Drill
- Drill Bit:
 - 5/16 in (11 mm)
- Pliers, Side Cutting
- Screwdriver, Phillips
- Socket Set, Metric
- Socket Set, Torx® Bit
- Torque Wrench

IMPORTANT

Your Handguard Accent Light Kit is exclusively designed for your vehicle. Please read the installation instructions thoroughly before beginning. Installation is easier if the vehicle is clean and free of debris. For your safety, and to ensure a satisfactory installation, perform all installation steps correctly in the sequence shown.

INSTALLATION INSTRUCTIONS

VEHICLE PREPARATION

GENERAL

1. Park vehicle on a flat surface.
2. Push engine stop switch to OFF position.
3. Turn key to OFF position and remove key.

REMOVE SIDE PANEL

1. Turn three side panel latches toward rear of snowmobile to release, then remove side panel.

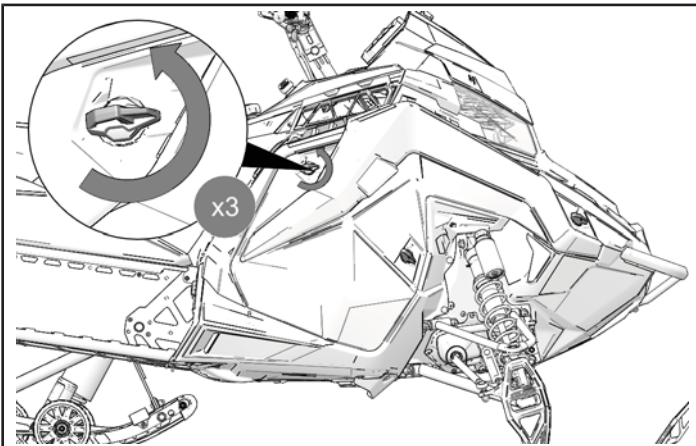

REMOVE HOOD

1. Turn hood fasteners counter-clockwise to release hood.

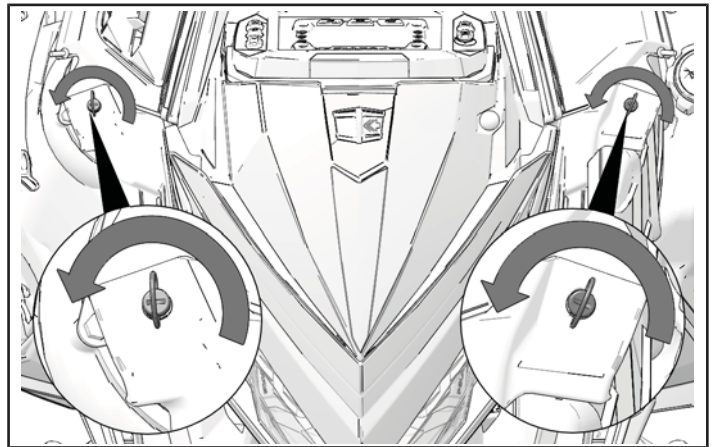

2. Pull sides of hood out away from side panel fasteners.

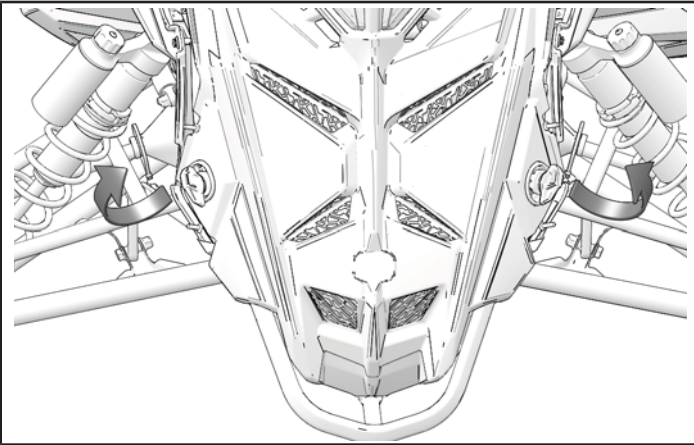

3. Lift hood up and away from snowmobile.

NOTICE

Disconnect wiring when removing hood.

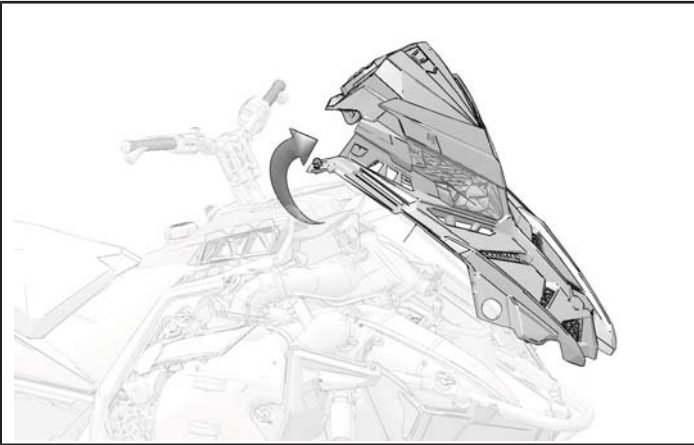

SEAT REMOVAL

1. Turn latch clockwise to unlock seat.

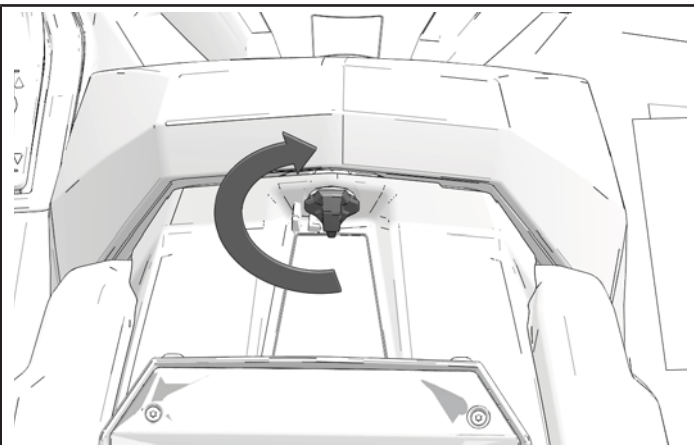

2. Lift up rear of seat.

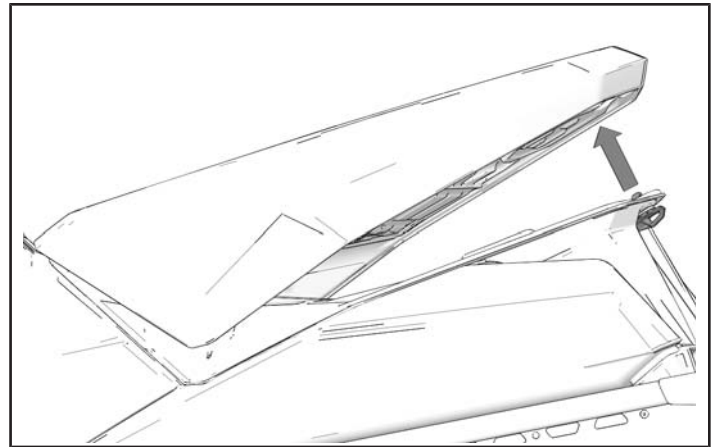

3. Move seat back to remove from snowmobile.

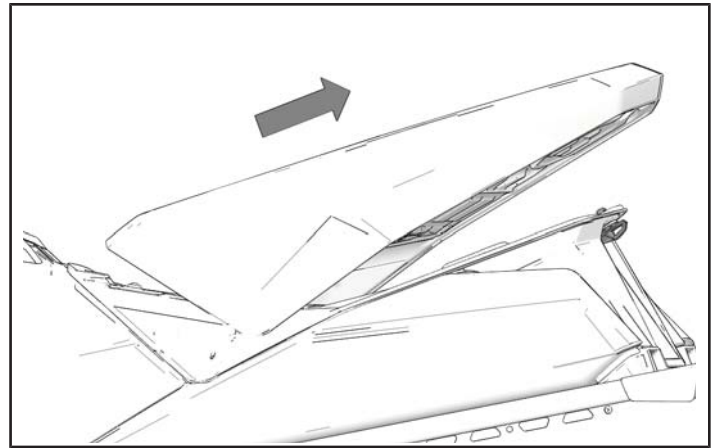

REMOVE CONSOLE

1. Remove and keep two push pin rivets.

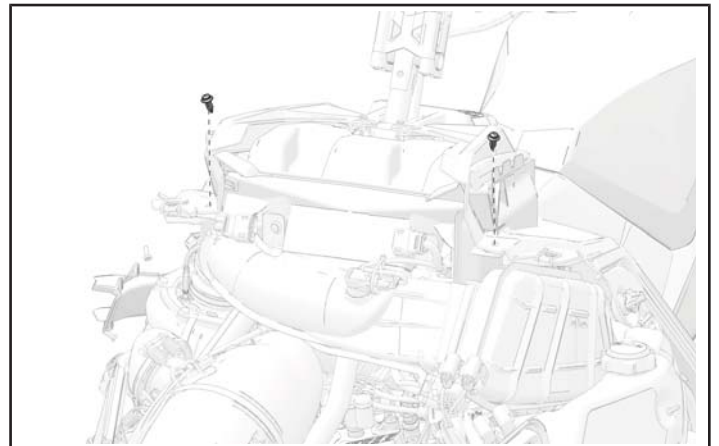

2. Remove and keep two screws.

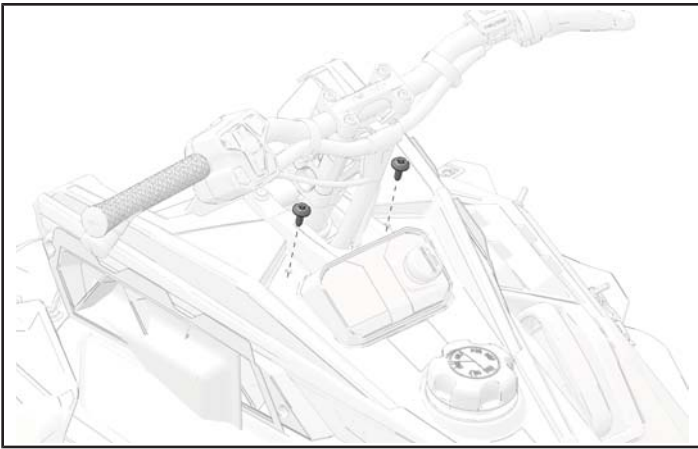

3. Remove and keep two screws and one push pin rivet.

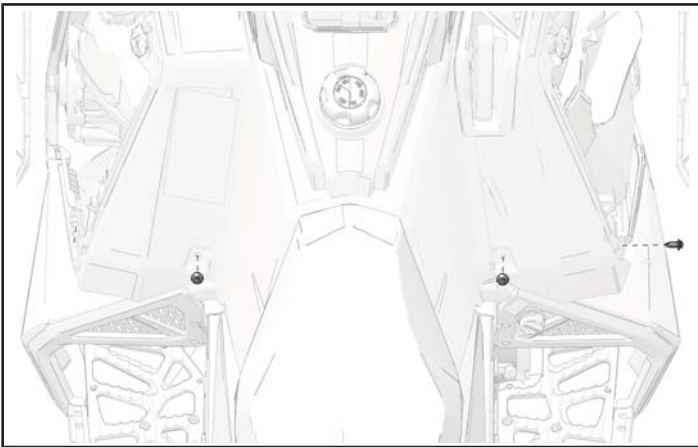

4. Remove and keep secondary clutch tool.

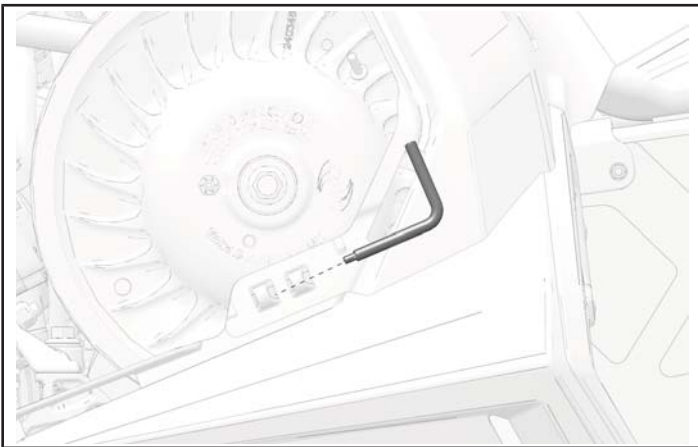

5. Remove fuel cap and fuel tank retainer nut.

TIP

Use a large adjustable pliers to remove fuel tank retainer nut.

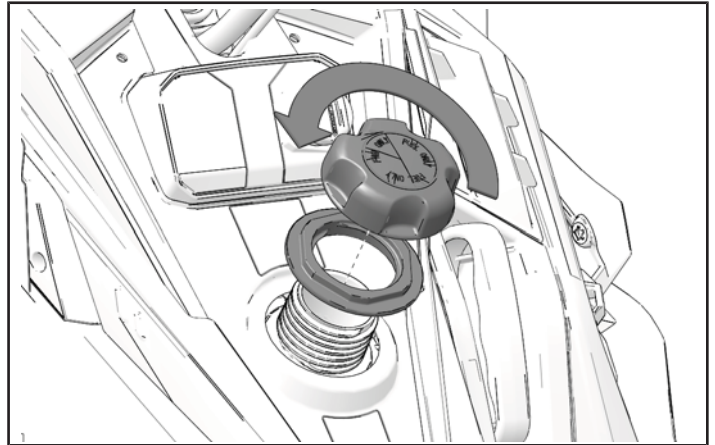

6. Lift cowl slightly and disconnect ignition switch. Disconnect other switches if equipped.

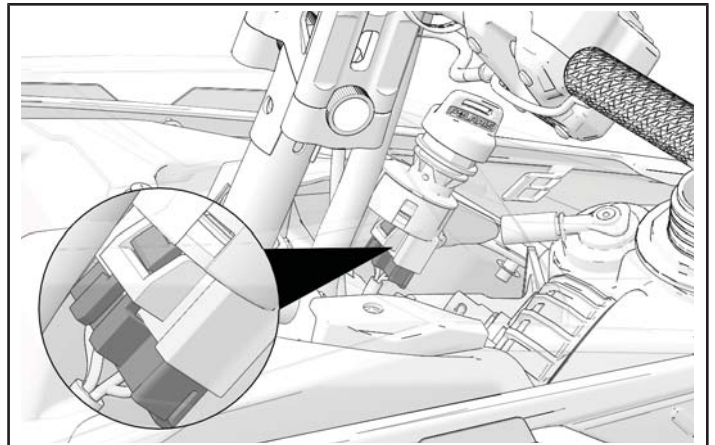

7. Remove two clips and disconnect switch panel from cowl. Move switch panel away from cowl. Lift cowl away from snowmobile and set to right side. Leave starter pull handle attached.

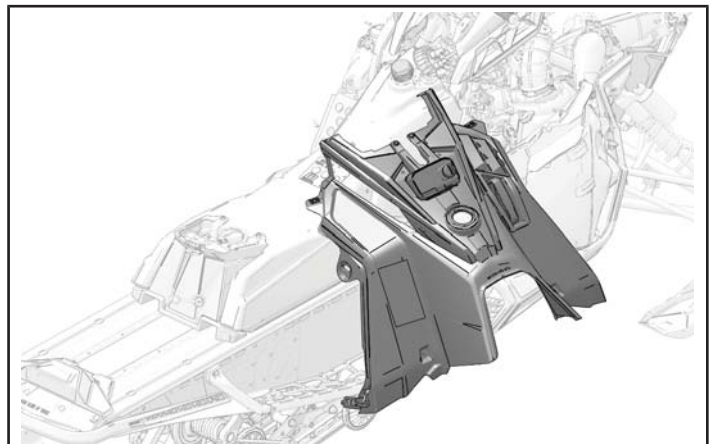

8. Install fuel cap

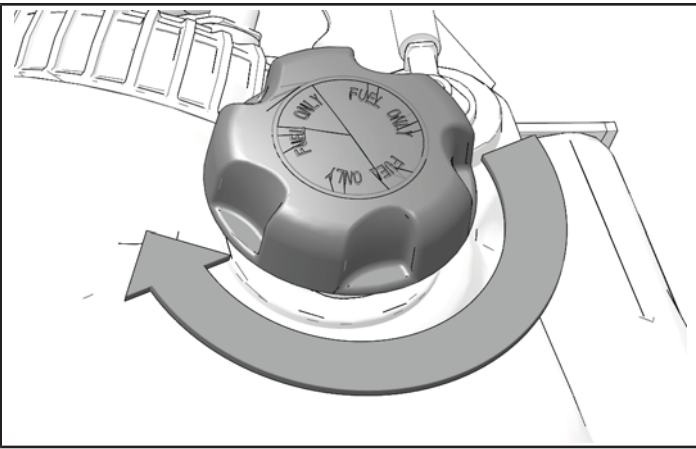

3. Put handguard accent light ① on handguard mount.

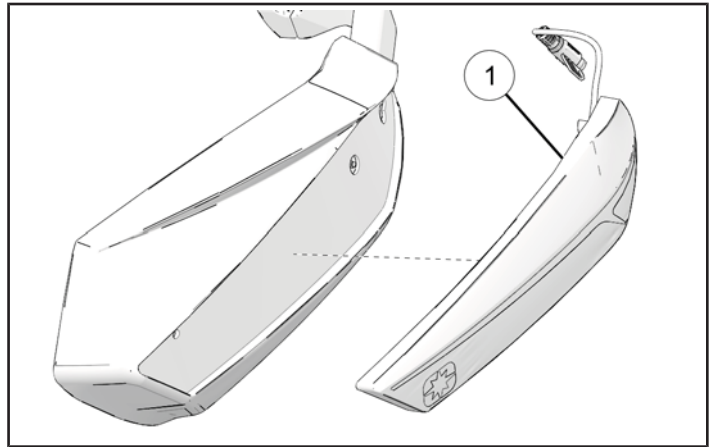

ACCESSORY INSTALLATION

1. Remove and keep two screws.

NOTICE

Right side shown; left side similar.

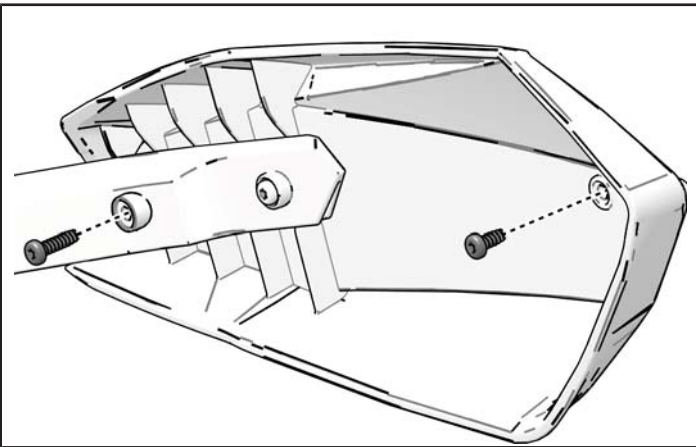

2. Remove handguard trim.

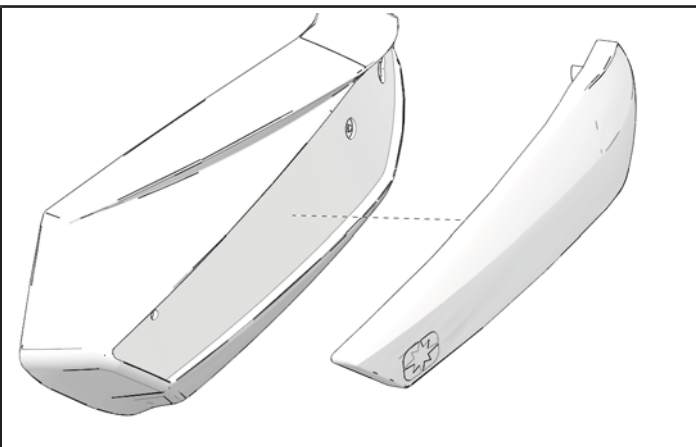

4. Route wiring through slot in handguard. Route through opening in handguard mount.

IMPORTANT

Some Defend Handguard mounts may not have cutout. If handguard mount does not have cutout, installation of handguard accent lights will require installer to cut a slot in the mount as shown.

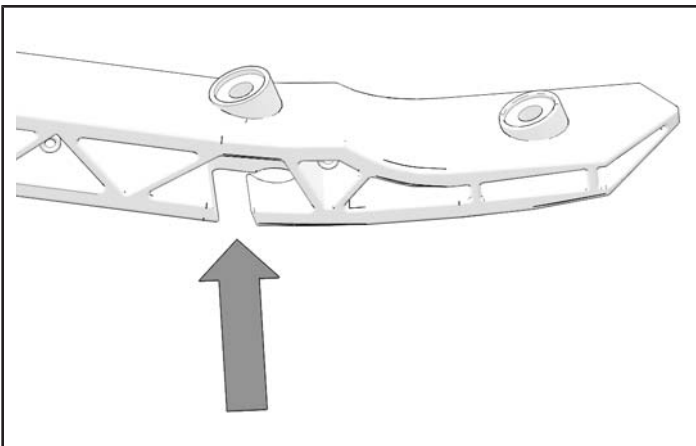
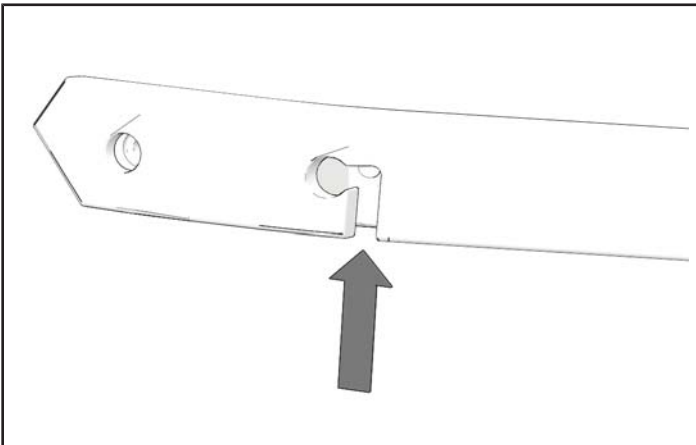
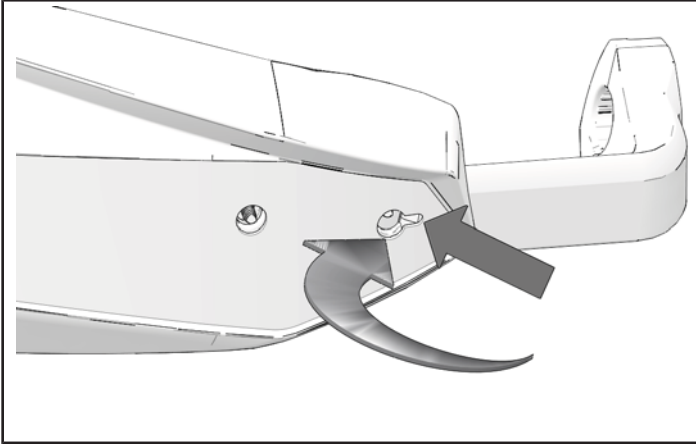

5. Attach handguard accent light using two kept screws. Tighten until fully-seated.

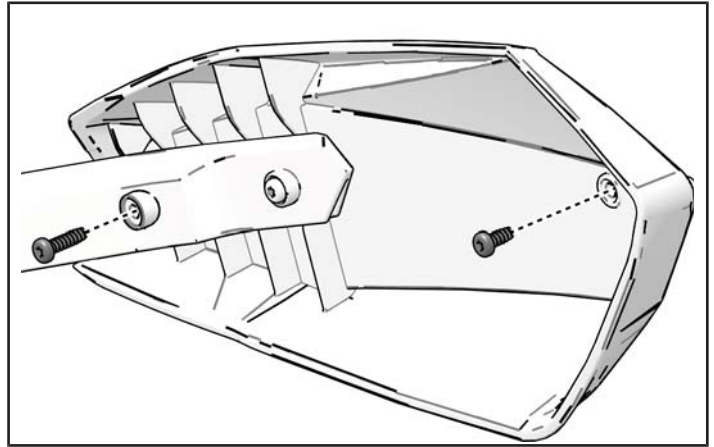

6. Attach wiring to handguard mount using strap ⑤.

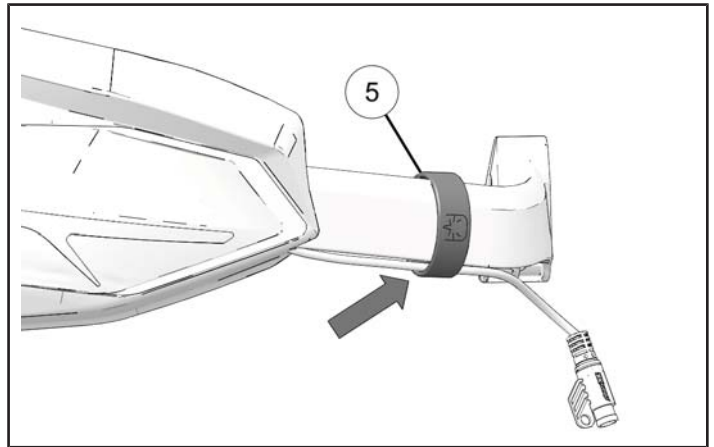

7. Install handguards onto handlebars. Put handguards next to handlebar riser. Torque screws to specification.

TORQUE

Handguard Mount Screws:
18 in-lbs (2 N·m)

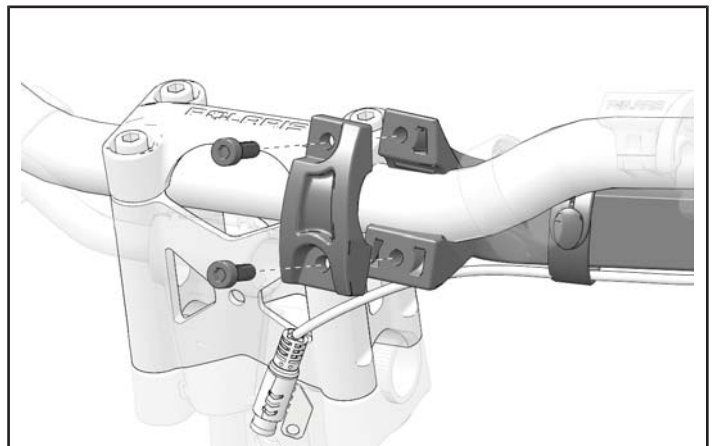

8. Route handguard accent light wiring along steering post. Connect to harness ③.

IMPORTANT

Route wiring behind throttle cable and brake hose.

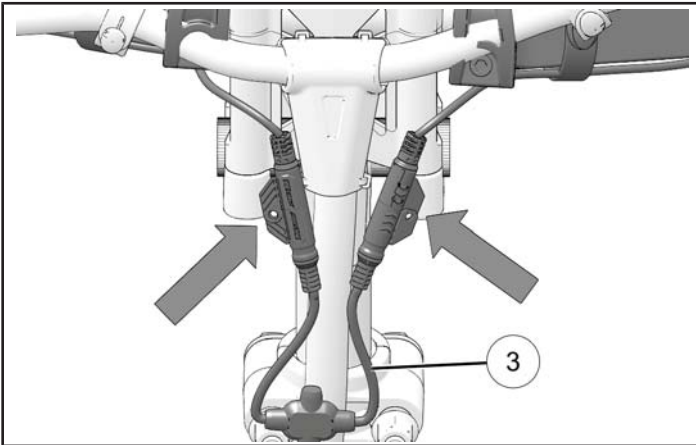

9. Route harness ③ down toward left side of snowmobile.

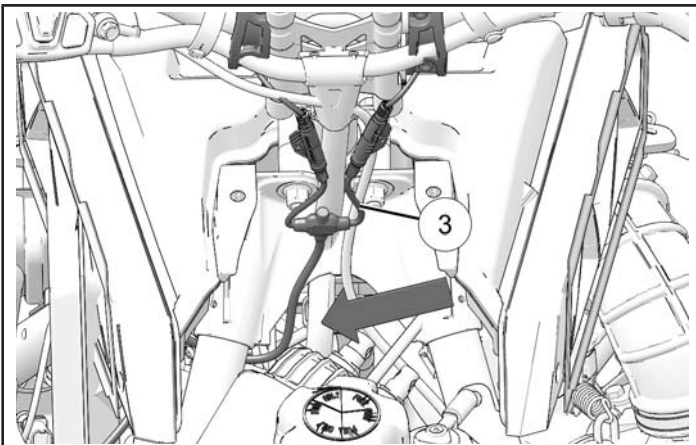

10. Route harness ③ to top of clutch guard.

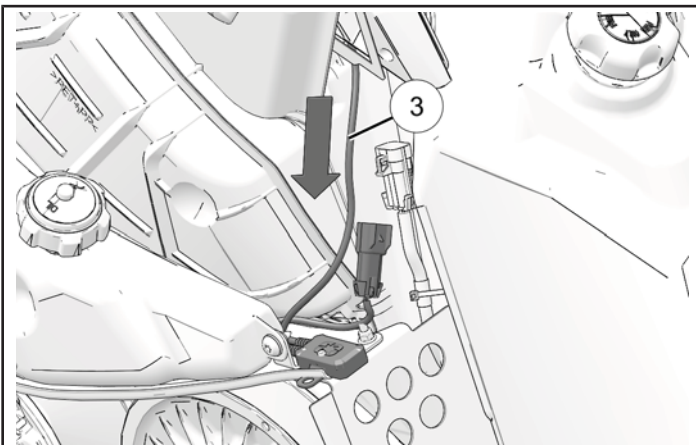

11. Remove existing nut from top of clutch guard. Attach controller using existing nut. Tighten until fully seated.

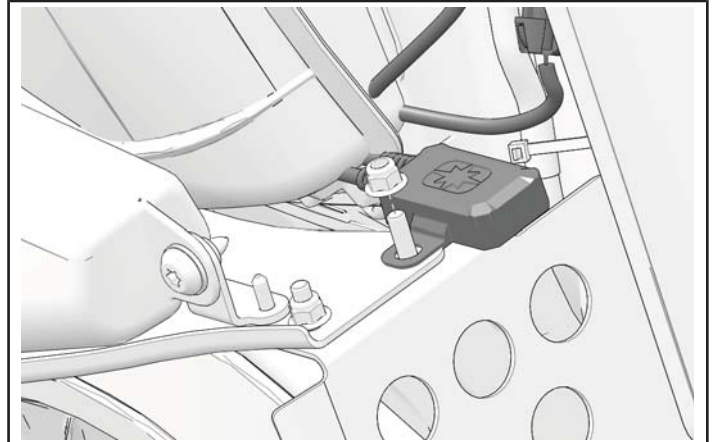

12. Remove plug from chassis connector. Connect harness

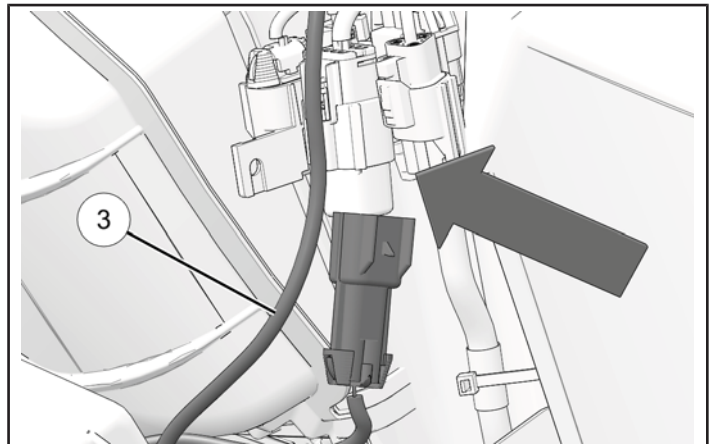

13. Attach wiring using cable ties ④.

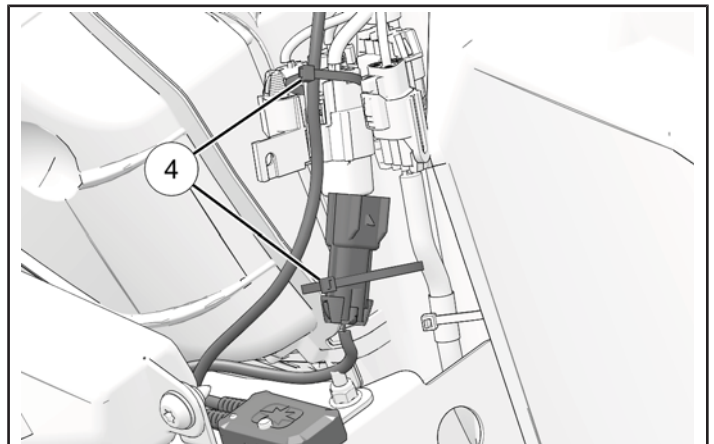

14. Attach harness to chassis tube using cable tie ④.

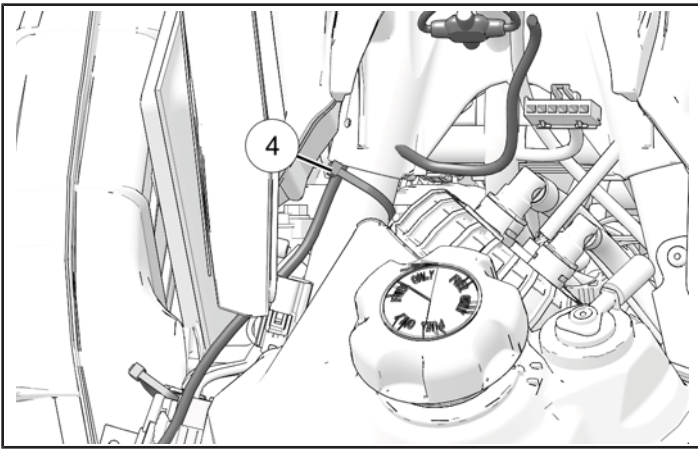

2. Place cowl on snowmobile. Install switch panel using clips. Connect switch wiring.

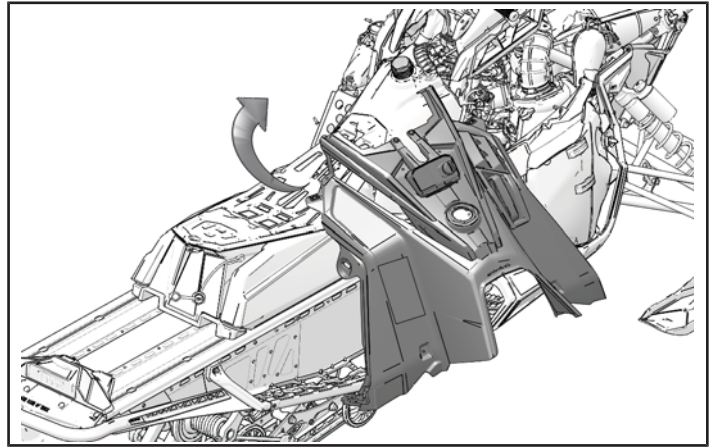

15. Attach wiring to steering post using cable ties ④.

IMPORTANT

Do not attach wiring to throttle cable or brake hose.

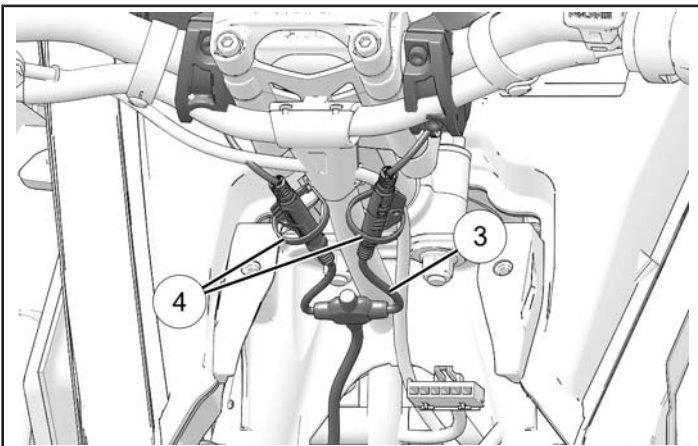

3. Connect ignition switch wiring. Also connect other switch wiring if equipped.

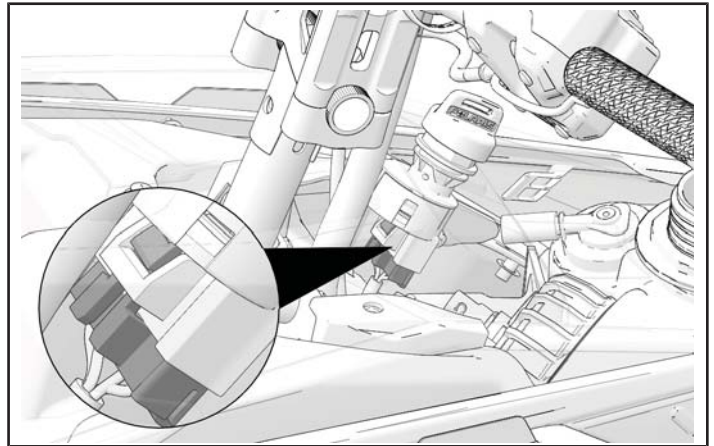

VEHICLE REASSEMBLY

INSTALL CONSOLE

1. Remove fuel cap.

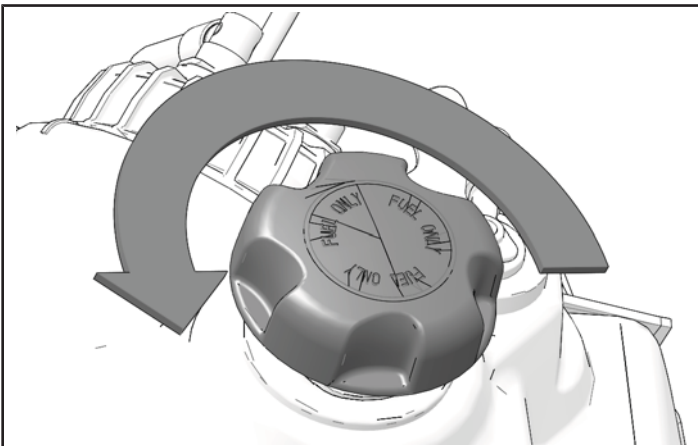

4. Install fuel cap and fuel tank retainer nut.

TIP

Use a large adjustable pliers to install fuel tank retainer nut.

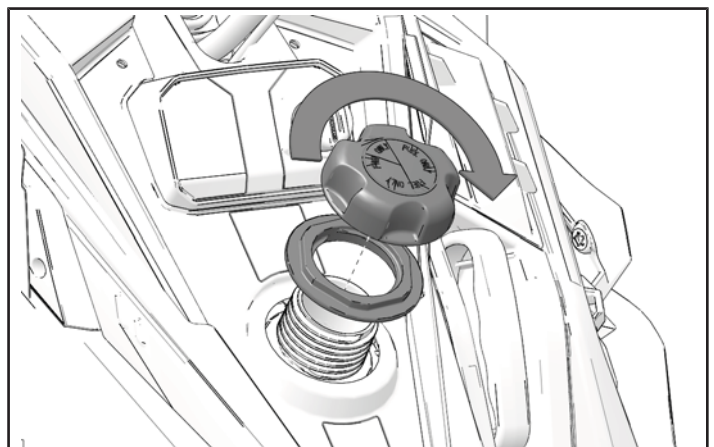

5. Install two screws. Torque to specification.

TORQUE

Console Screws:
70 in-lbs (8 N·m)

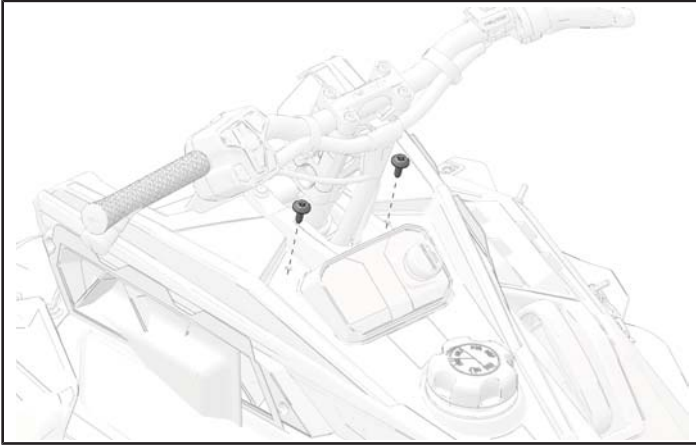

6. Install two screws and one push pin rivet. Torque screws to specification.

TORQUE

Console Screws:
70 in-lbs (8 N·m)

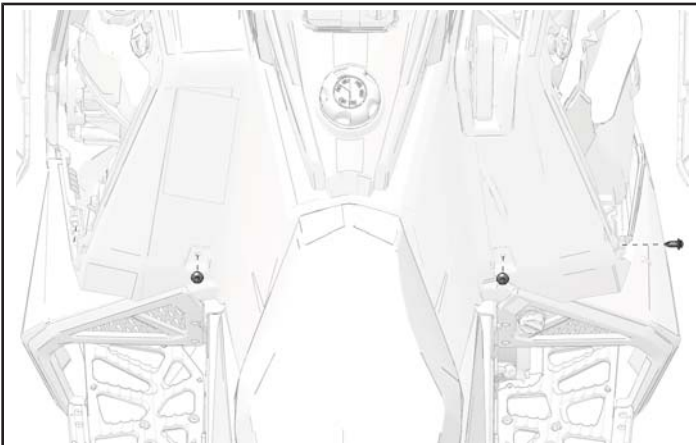

7. Install secondary clutch tool.

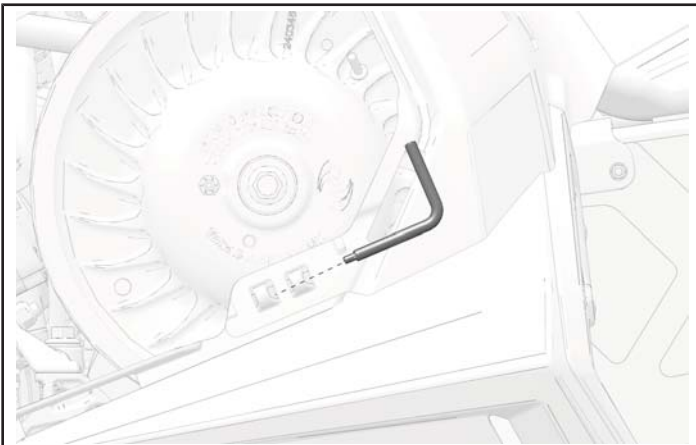

8. Install two push pin rivets.

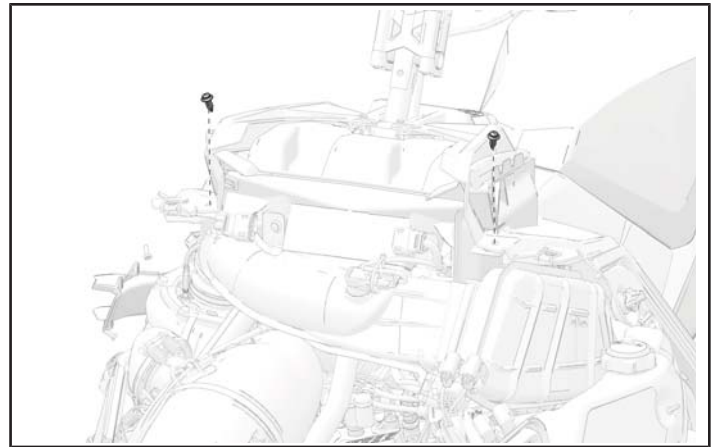

SEAT INSTALLATION

1. Hook front of seat into position.

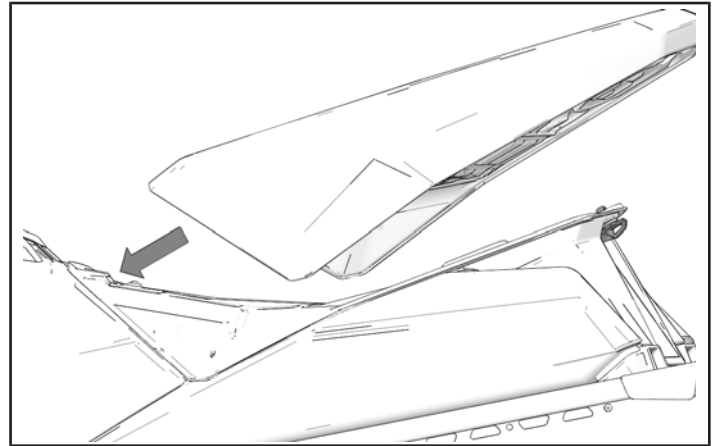

2. Put rear of seat into latch.

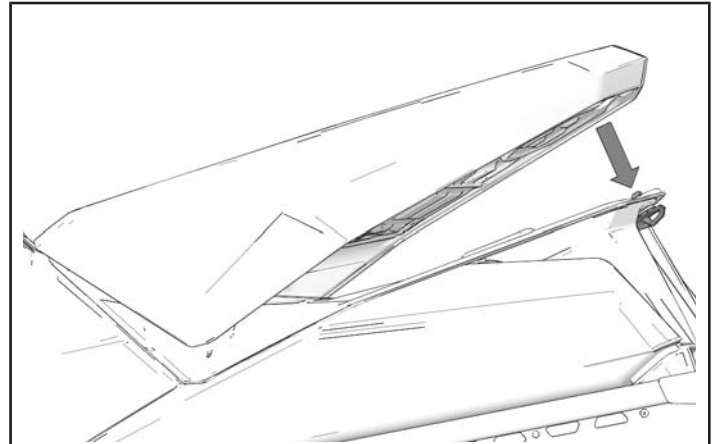

3. Turn latch clockwise to lock seat.

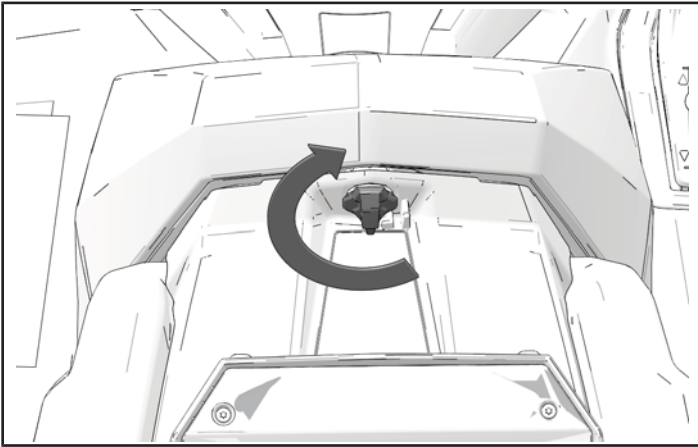

2. Pull sides of hood out and install over side panel fasteners.

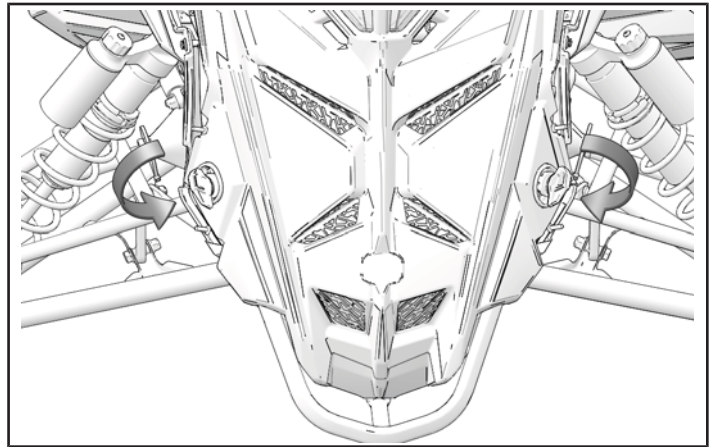

INSTALL HOOD

1. Install hood on snowmobile. Make sure tabs fit inside front pan.

NOTICE

Make sure to connect hood wiring when installing hood.

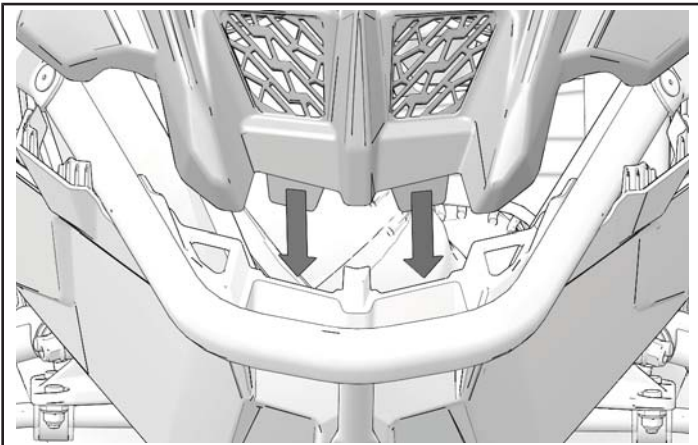
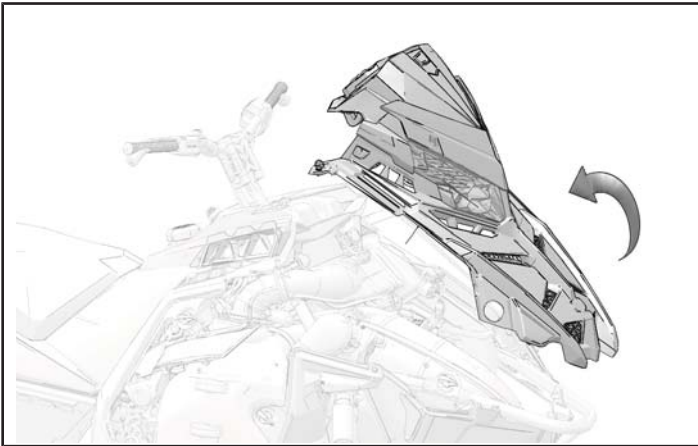

3. Turn hood fasteners clockwise to lock hood.

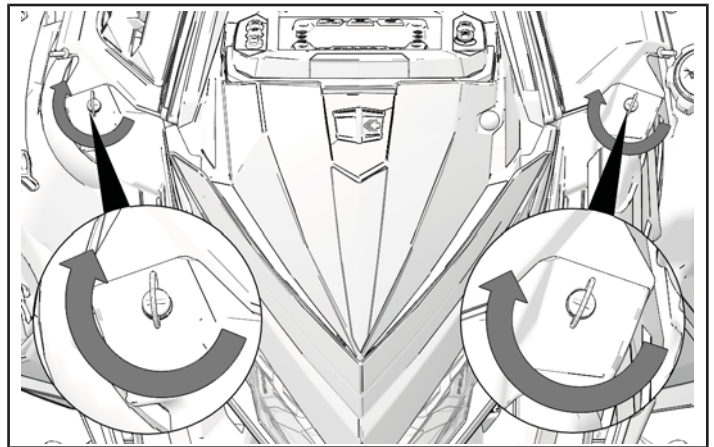

INSTALL RIGHT SIDE PANEL

1. Install side panel on snowmobile. Turn fasteners toward front of snowmobile to lock in place.

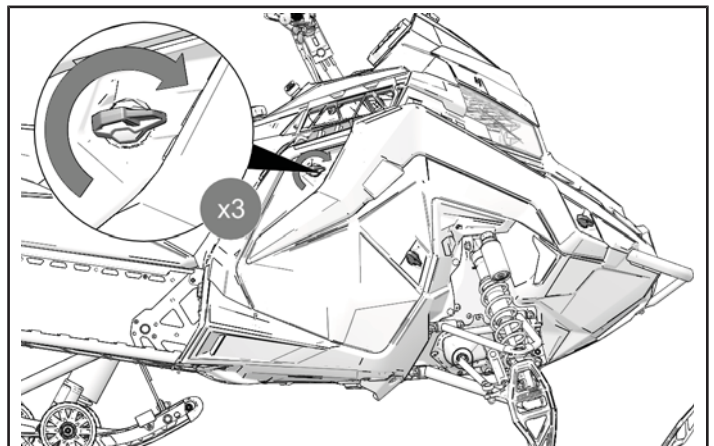

OPERATION

1. Download the XK Glow app, "XKchrome."



2. In the phone's device settings, pair the controller to the app on the phone. When the controller is paired, it will appear at the top of the phone's device list.
3. The XKchrome app will guide the user through the app's features and how to control the lights.

FCC Statement

Changes or modifications not expressly approved by the party responsible for compliance could void the user's authority to operate the equipment.

This device complies with part 15 of the FCC rules. Operation is subject to the following two conditions: (1) this device may not cause harmful interference, and (2) this device must accept any interference received, including interference that may cause undesired operation.

NOTE: This equipment has been tested and found to comply with the limits for a Class B digital device, pursuant to part 15 of the FCC Rules. These limits are designed to provide reasonable protection against harmful interference in a residential installation. This equipment generates uses and can radiate radio frequency energy and, if not installed and used in accordance with the instructions, may cause harmful interference to radio communications. However, there is no guarantee that interference will not occur in a particular installation. If this equipment does cause harmful interference to radio or television reception, which can be determined by turning the equipment off and on, the user is encouraged to try to correct the interference by one or more of the following measures:

- Reorient or relocate the receiving antenna.
- Increase the separation between the equipment and receiver.
- Connect the equipment into an outlet on a circuit different from that to which the receiver is connected.
- Consult the dealer or an experienced radio/TV technician for help important announcement

Radiation Exposure Statement

This equipment complies with FCC radiation exposure limits set forth for an uncontrolled environment. This equipment should be installed and operated with minimum distance 20cm between the radiator and your body.

This transmitter must not be co-located or operating in conjunction with any other antenna or transmitter.

IC Statement

This device contains licence-exempt transmitter(s)/receiver(s) that comply with Innovation, Science and Economic Development Canada's licence-exempt RSS(s). Operation is subject to the following two conditions: (1) This device may not cause interference. (2) This device must accept any interference, including interference that may cause undesired operation of the device.

L'émetteur/récepteur exempt de licence contenu dans le présent appareil est conforme aux CNR d'Innovation, Sciences et Développement économique Canada applicables aux appareils radio exempts

de licence. L'exploitation est autorisée aux deux conditions suivantes : 1) L'appareil ne doit pas produire de brouillage; 2) L'appareil doit accepter tout brouillage radioélectrique subi, même si le brouillage est susceptible d'en compromettre le fonctionnement.

This equipment complies with Industry Canada radiation exposure limits set forth for an uncontrolled environment.

Cet équipement est conforme à l'exposition aux rayonnements Industry Canada limites établies pour un environnement non contrôlé.

Radiation Exposure Statement

This equipment complies with Canada radiation exposure limits set forth for an uncontrolled environment. This equipment should be installed and operated with minimum distance 20cm between the radiator & your body.

Cet équipement est conforme Canada limites d'exposition aux radiations dans un environnement non contrôlé. Cet équipement doit être installé et utilisé à distance minimum de 20cm entre le radiateur et votre corps.