



# TEST REPORT

## FCC PART 15 SUBPART C 15.247

Test report  
On Behalf of  
Shantou Xinyu Industry Co., Ltd  
For  
Bluetooth Headphone

Model No.: XY523, NE-974, NE-975, NE-970, NE-922A, NE-965,  
XY-963, XY-513, XY-895

FCC ID: 2AOW6-XY523

Prepared for : Shantou Xinyu Industry Co., Ltd  
HepingZhongzai Industry Zone, Chaoyang District, Shantou, Guangdong,  
China

Prepared By : Shenzhen HUAK Testing Technology Co., Ltd.  
1-2/F, Building 19, Junfeng Industrial Park, Chongqing Road, Heping Community, F  
uhai Street, Bao'an District, Shenzhen, Guangdong, China

Date of Test: Jan. 13, 2019 to Jan. 19, 2019

Date of Report: Jan. 19, 2019

Report Number: HK1901210160E



### TEST RESULT CERTIFICATION

**Applicant's name**..... Shantou Xinyu Industry Co., Ltd  
 Address ..... HepingZhongzai Industry Zone, Chaoyang District, Shantou, Guangdong, China  
**Manufacture's Name** ..... Shantou Xinyu Industry Co., Ltd  
 Address ..... HepingZhongzai Industry Zone, Chaoyang District, Shantou, Guangdong, China  
**Factory** ..... Shantou Xinyu Industry Co., Ltd  
 Address ..... HepingZhongzai Industry Zone, Chaoyang District, Shantou, Guangdong, China

**Product description**

Trade Mark: Naxa  
 Product name..... Bluetooth Headphone  
 Model and/or type reference ... XY523, NE-974, NE-975, NE-970, NE-922A, NE-965, XY-963, XY-513, XY-895  
 Difference description All the same except for the model name

**Standards**..... **47 CFR FCC Part 15 Subpart C 15.247**

This publication may be reproduced in whole or in part for non-commercial purposes as long as the Shenzhen HUAKE Testing Technology Co., Ltd. is acknowledged as copyright owner and source of the material. Shenzhen HUAKE Testing Technology Co., Ltd. takes no responsibility for and will not assume liability for damages resulting from the reader's interpretation of the reproduced material due to its placement and context.

**Date of Test**..... :  
 Date (s) of performance of tests ..... : Jan. 13, 2019 ~ Jan. 19, 2019  
 Date of Issue ..... : Jan. 19, 2019  
 Test Result ..... : **Pass**

Testing Engineer :   
 \_\_\_\_\_  
 (Gary Qian)

Technical Manager :   
 \_\_\_\_\_  
 (Eden Hu)

Authorized Signatory :   
 \_\_\_\_\_  
 (Jason Zhou)

**TABLE OF CONTENTS**

<b>1. SUMMARY</b> .....	<b>4</b>
1.1. TEST STANDARDS.....	4
1.2. TEST DESCRIPTION .....	4
TEST FACILITY .....	5
1.3. STATEMENT OF THE MEASUREMENT UNCERTAINTY .....	5
<b>2. GENERAL INFORMATION</b> .....	<b>6</b>
2.1. ENVIRONMENTAL CONDITIONS .....	6
2.2. GENERAL DESCRIPTION OF EUT .....	6
2.3. DESCRIPTION OF TEST MODES AND TEST FREQUENCY .....	6
2.4. RELATED SUBMITTAL(S) / GRANT (S).....	8
2.5. MODIFICATIONS .....	8
2.6. RECEIVER INPUT BANDWIDTH.....	8
2.7. EXAMPLE OF A HOPPING SEQUENCE IN DATA MODE .....	8
2.8. EQUALLY AVERAGE USE OF FREQUENCIES AND BEHAVIOUR .....	8
2.9. EQUIPMENT USED .....	9
<b>3. PEAK OUTPUT POWER</b> .....	<b>10</b>
3.1. MEASUREMENT PROCEDURE.....	10
3.2. TEST SET-UP (BLOCK DIAGRAM OF CONFIGURATION).....	10
3.3. LIMITS AND MEASUREMENT RESULT.....	11
<b>4. 20DB BANDWIDTH</b> .....	<b>15</b>
4.1. MEASUREMENT PROCEDURE.....	15
4.2. TEST SET-UP (BLOCK DIAGRAM OF CONFIGURATION).....	15
4.3. LIMITS AND MEASUREMENT RESULTS.....	16
<b>5. CONDUCTED SPURIOUS EMISSION</b> .....	<b>20</b>
5.1. MEASUREMENT PROCEDURE.....	20
5.2. TEST SET-UP (BLOCK DIAGRAM OF CONFIGURATION).....	20
5.3. LIMITS AND MEASUREMENT RESULT.....	20
<b>6. RADIATED EMISSION</b> .....	<b>28</b>
6.1. MEASUREMENT PROCEDURE.....	28
6.2. TEST SETUP.....	30
6.3. LIMITS AND MEASUREMENT RESULT.....	31
<b>7. FCC LINE CONDUCTED EMISSION TEST</b> .....	<b>41</b>
7.1. LIMITS OF LINE CONDUCTED EMISSION TEST .....	41
7.2. BLOCK DIAGRAM OF LINE CONDUCTED EMISSION TEST .....	41
7.3. PRELIMINARY PROCEDURE OF LINE CONDUCTED EMISSION TEST .....	42
7.4. FINAL PROCEDURE OF LINE CONDUCTED EMISSION TEST .....	42
7.5. TEST RESULT OF LINE CONDUCTED EMISSION TEST .....	43
<b>8. NUMBER OF HOPPING FREQUENCY</b> .....	<b>45</b>
8.1. MEASUREMENT PROCEDURE.....	45
8.2. TEST SETUP (BLOCK DIAGRAM OF CONFIGURATION) .....	45
8.3. LIMITS AND MEASUREMENT RESULT.....	45
<b>9. TIME OF OCCUPANCY (DWELL TIME)</b> .....	<b>46</b>
9.1. MEASUREMENT PROCEDURE.....	46
9.2. TEST SETUP (BLOCK DIAGRAM OF CONFIGURATION) .....	46
9.3. LIMITS AND MEASUREMENT RESULT.....	46
<b>10. FREQUENCY SEPARATION</b> .....	<b>50</b>
10.1. MEASUREMENT PROCEDURE.....	50
10.2. TEST SETUP (BLOCK DIAGRAM OF CONFIGURATION) .....	50
10.3. LIMITS AND MEASUREMENT RESULT.....	50
<b>11. TEST SETUP PHOTOS OF THE EUT</b> .....	<b>51</b>
<b>12. PHOTOGRAPH OF EUT</b> .....	<b>53</b>



## 1.SUMMARY

### 1.1. TEST STANDARDS

The tests were performed according to following standards:

[FCC Rules Part 15.247](#): Frequency Hopping, Direct Spread Spectrum and Hybrid Systems that are in operation within the bands of 902-928 MHz, 2400-2483.5 MHz, and 5725-5850 MHz

[ANSI C63.10:2013](#) : American National Standard for Testing Unlicensed Wireless Devices

### 1.2. Test Description

FCC PART 15.247		
FCC Part 15.207	AC Power Conducted Emission	PASS
FCC Part 15.247(a)(1)(i)	20dB Bandwidth	PASS
FCC Part 15.247(d)	Spurious RF Conducted Emission	PASS
FCC Part 15.247(b)	Maximum Peak Output Power	PASS
FCC Part 15.247(b)	Pseudorandom Frequency Hopping Sequence	PASS
FCC Part 15.247(a)(1)(iii)	Number of hopping frequency& Time of Occupancy	PASS
FCC Part 15.247(a)(1)	Frequency Separation	PASS
FCC Part 15.205/15.209	Radiated Emissions	PASS
FCC Part 15.247(d)	Band Edge Compliance of RF Emission	PASS



## Test Facility

### 1.3.1 Address of the test laboratory

Shenzhen HUAKE Testing Technology Co., Ltd.

Address: 1F, B2 Building, Junfeng Zhongcheng Zhizao Innovation Park, Heping Community, Fuhai Street, Bao'an District, Shenzhen, China

There is one 3m semi-anechoic chamber and two line conducted labs for final test. The Test Sites meet the requirements in documents ANSI C63.4 and CISPR 32/EN 55032 requirements.

### 1.3.2 Laboratory accreditation

The test facility is recognized, certified, or accredited by the following organizations:

#### IC Registration No.: 21210

The 3m alternate test site of Shenzhen HUAKE Testing Technology Co., Ltd. EMC Laboratory has been registered by Certification and Engineer Bureau of Industry Canada for the performance of with Registration No.: 21210 on May 24, 2016.

#### FCC Registration No.: CN1229

Test Firm Registration Number : 616276

## 1.3. Statement of the measurement uncertainty

The data and results referenced in this document are true and accurate. The reader is cautioned that there may be errors within the calibration limits of the equipment and facilities. The measurement uncertainty was calculated for all measurements listed in this test report acc. to CISPR 16 - 4 "Specification for radio disturbance and immunity measuring apparatus and methods – Part 4: Uncertainty in EMC Measurements" and is documented in the Shenzhen HUAKE Testing Technology Co., Ltd. quality system acc. to DIN EN ISO/IEC 17025. Furthermore, component and process variability of devices similar to that tested may result in additional deviation. The manufacturer has the sole responsibility of continued compliance of the device.

Hereafter the best measurement capability for HUAKE laboratory is reported:

Test	Measurement Uncertainty	Notes
Transmitter power conducted	±0.57 dB	(1)
Transmitter power Radiated	±2.20 dB	(1)
Conducted spurious emission 9KHz-40 GHz	±2.20 dB	(1)
Occupied Bandwidth	±0.01ppm	(1)
Radiated Emission 30~1000MHz	±4.10dB	(1)
Radiated Emission Above 1GHz	±4.32dB	(1)
Conducted Disturbance 0.15~30MHz	±3.20dB	(1)

(1) This uncertainty represents an expanded uncertainty expressed at approximately the 95% confidence level using a coverage factor of k=2.



## 2. GENERAL INFORMATION

### 2.1. Environmental conditions

During the measurement the environmental conditions were within the listed ranges:

Normal Temperature:	25°C
Relative Humidity:	55 %
Air Pressure:	101 kPa

### 2.2. General Description of EUT

Product Name:	Bluetooth Headphone
Model/Type reference:	XY523
Power supply:	DC 3.7V by battery
Version:	V5.0
Modulation:	GFSK, π/4DQPSK
Operation frequency:	2402MHz~2480MHz
Channel number:	79
Channel separation:	1MHz
Antenna type:	PCB Antenna
Antenna gain:	-0.58dBi
Hardware Version:	2.0
Software Version:	1.0

Note: For more details, refer to the user's manual of the EUT.

### 2.3. Description of Test Modes and Test Frequency

The Applicant provides communication tools software to control the EUT for staying in continuous transmitting and receiving mode for testing.

There are 79 channels provided to the EUT and Channel 00/39/78 was selected for testing.

#### Operation Frequency :

Channel	Frequency (MHz)
00	2402
01	2403
:	:
38	2440
39	2441
40	2442
:	:
77	2479
78	2480

Note: The line display in grey were the channel selected for testing



NO.	TEST MODE DESCRIPTION
1	Low channel TX
2	Middle channel TX
3	High channel TX
4	Normal Operating (BT)

Note:

1. Only the result of the worst case was recorded in the report, if no other cases.
2. For Radiated Emission, 3axis were chosen for testing for each applicable mode.
3. For Conducted Test method, a temporary antenna connector is provided by the manufacture.

Conducted Emission Configure :



Radiated Emission Configure :

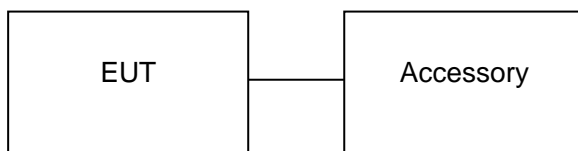

Item	Equipment	Model No.	ID or Specification	Remark
1	Adapter	NTR-S01	DC 5V	Support



## 2.4. Related Submittal(s) / Grant (s)

This submittal(s) (test report) is intended to comply with Section 15.247 of the FCC Part 15, Subpart C Rules.

## 2.5. Modifications

No modifications were implemented to meet testing criteria.

## 2.6. Receiver Input Bandwidth

The input bandwidth of the receiver is 1.3MHz. In every connection one Bluetooth device is the master and the other one is slave. The master determines the hopping sequence. The slave follows this sequence. Both devices shift between RX and TX time slot according to the clock of the master. Additionally the type of connection (e.g. single or multislot packet) is set up at the beginning of the connection. The master adapts its hopping frequency and its TX/RX timing according to the packet type of the connection. Also the slave of the connection will use these settings.

Repeating of a packet has no influence on the hopping sequence. The hopping sequence generated by the master of the connection will be followed in any case. That means, a repeated packet will not be sent on the same frequency, it is sent on the next frequency of the hopping sequence.

## 2.7. Example of a Hopping Sequence in Data Mode

Example of a 79 hopping sequence in data mode:

40,21,44,23,42,53,46,55,48,33,52,35,50,65,54,67  
56,37,60,39,58,69,62,71,64,25,68,27,66,57,70,59  
72,29,76,31,74,61,78,63,01,41,05,43,03,73,07,75  
09,45,13,47,11,77,15,00,64,49,66,53,68,02,70,06  
01,51,03,55,05,04

## 2.8. Equally Average Use of Frequencies and Behaviour

The generation of the hopping sequence in connection mode depends essentially on two input values:

1. LAP/UAP of the master of the connection.
2. Internal master clock

The LAP (lower address part) are the 24 LSB's of the 48 BD\_ADDRESS. The BD\_ADDRESS is an unambiguous number of every Bluetooth unit. The UAP (upper address part) are the 24 MSB's of the 48 BD\_ADDRESS

The internal clock of a Bluetooth unit is derived from a free running clock which is never adjusted and is never turned off. For synchronization with other units only offset are used. It has no relation to the time of the day. Its resolution is at least half the RX/TX slot length of 312.5us. The clock has a cycle of about one day (23h30). In most cases it is implemented as 28 bit counter. For the deriving of the hopping sequence the entire LAP (24 bits), 4 LSB's (4 bits) (Input 1) and the 27 MSB's of the clock (Input 2) are used. With this input values different mathematical procedures (permutations, additions, XOR-operations) are performed to generate the sequence. This will be done at the beginning of every new transmission.

Regarding short transmissions the Bluetooth system has the following behavior:

The first connection between the two devices is established, a hopping sequence was generated. For transmitting the wanted data the complete hopping sequence was not used. The connection ended.

The second connection will be established. A new hopping sequence is generated. Due to the fact the Bluetooth clock has a different value, because the period between the two transmissions is longer (and it cannot be shorter) than the minimum resolution of the clock (312.5us). The hopping sequence will always differ from the first one.





## 2.9. Equipment Used

Item	Equipment	Manufacturer	Model No.	Serial No.	Last Cal.	Cal. Interval
1.	L.I.S.N. Artificial Mains Network	R&S	ENV216	HKE-002	Dec. 27, 2018	1 Year
2.	Receiver	R&S	ESCI 7	HKE-010	Dec. 27, 2018	1 Year
3.	RF automatic control unit	Tonscend	JS0806-2	HKE-060	Dec. 27, 2018	1 Year
4.	Horn Antenna	Schwarzbeck	BBHA 9170	HKE-090	Dec. 27, 2018	1 Year
5.	Spectrum analyzer	Agilent	N9020A	HKE-048	Dec. 27, 2018	1 Year
6.	Preamplifier	Schwarzbeck	BBV 9743	HKE-006	Dec. 27, 2018	1 Year
7.	EMI Test Receiver	Rohde & Schwarz	ESCI 7	HKE-010	Dec. 27, 2018	1 Year
8.	Bilog Broadband Antenna	Schwarzbeck	VULB9163	HKE-012	Dec. 27, 2018	1 Year
9.	Loop Antenna	Schwarzbeck	FMZB 1519 B	HKE-014	Dec. 27, 2018	1 Year
10.	Horn Antenna	Schwarzbeck	9120D	HKE-013	Dec. 27, 2018	1 Year
11.	Pre-amplifier	EMCI	EMC051845 SE	HKE-015	Dec. 27, 2018	1 Year
12.	Pre-amplifier	Agilent	83051A	HKE-016	Dec. 27, 2018	1 Year
13.	EMI Test Software EZ-EMC	Tonscend	JS1120-B Version	HKE-083	Dec. 27, 2018	N/A
14.	Shielded room	Shiel Hong	4*3*3	HKE-039	Dec. 27, 2018	3 Year

The calibration interval was one year

### 3. Peak Output Power

#### 3.1. Measurement Procedure

For peak power test:

1. Connect EUT RF output port to the Spectrum Analyzer through an RF attenuator
2. Span: Approximately five times the 20 dB bandwidth, centered on a hopping channel.
3. RBW > 20 dB bandwidth of the emission being measured.
4. VBW  $\geq$  RBW.
5. Sweep: Auto.
6. Detector function: Peak.
7. Trace: Max hold.

Allow trace to stabilize. Use the marker-to-peak function to set the marker to the peak of the emission. The indicated level is the peak output power, after any corrections for external attenuators and cables.

#### 3.2. Test Set-Up (Block Diagram of Configuration)

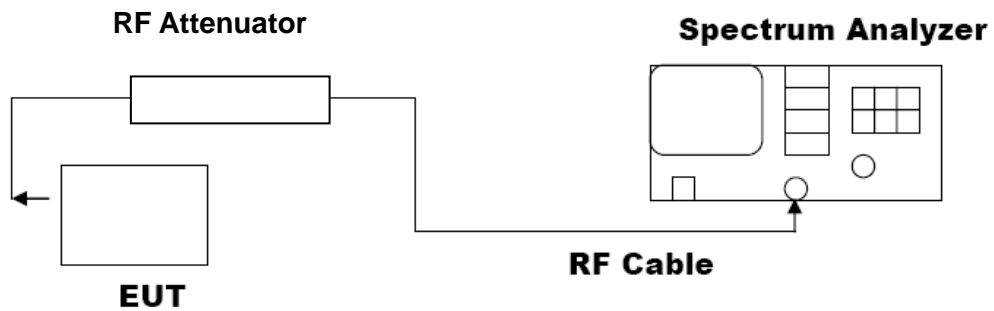



### 3.3. Limits and Measurement Result

PEAK OUTPUT POWER MEASUREMENT RESULT FOR GFSK MOUDULATION			
Frequency (GHz)	Peak Power (dBm)	Applicable Limits (dBm)	Pass or Fail
2.402	1.685	30	Pass
2.441	2.340	30	Pass
2.480	2.495	30	Pass

CH0

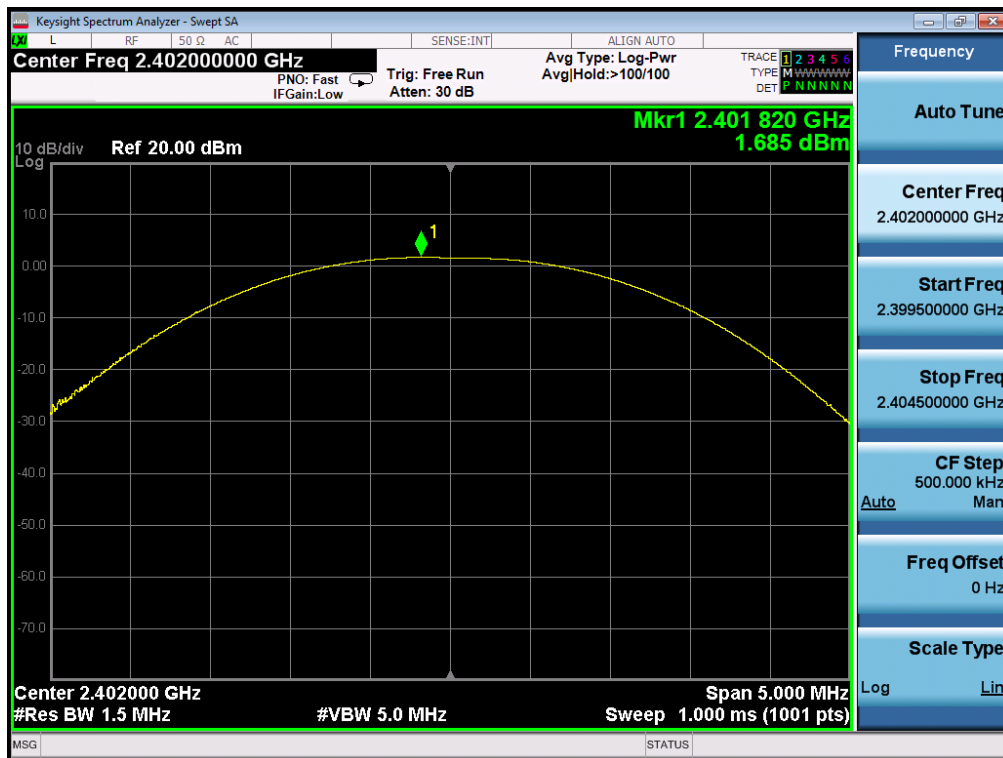



CH39

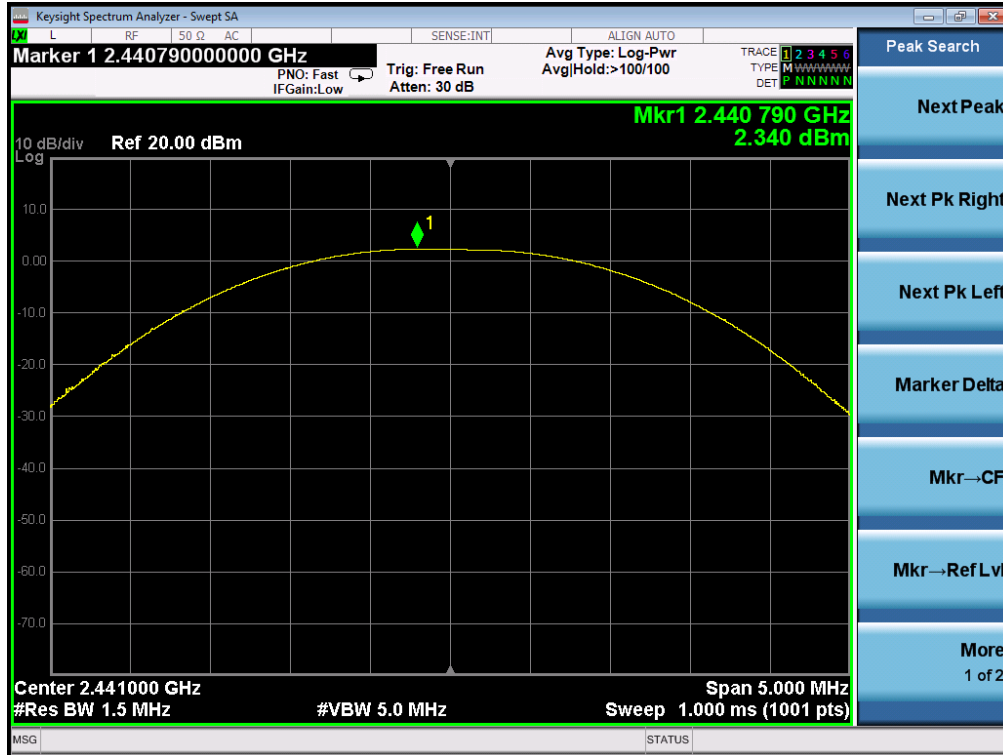

CH78

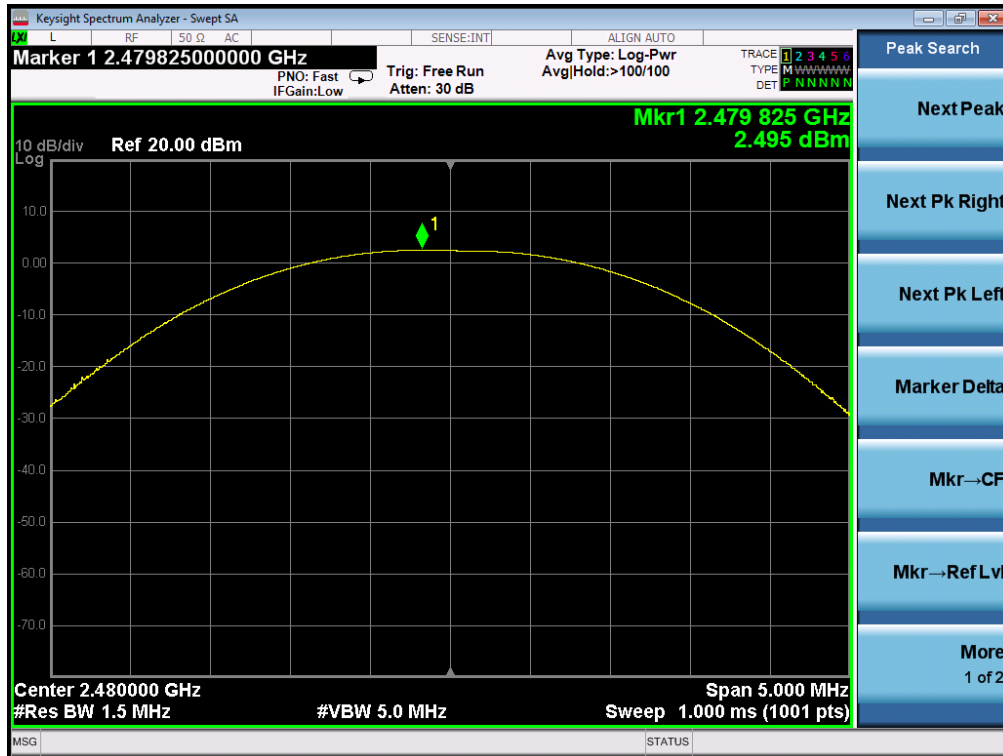



PEAK OUTPUT POWER MEASUREMENT RESULT FOR $\Pi/4$ -DQPSK MODULATION			
Frequency (GHz)	Peak Power (dBm)	Applicable Limits (dBm)	Pass or Fail
2.402	2.346	30	Pass
2.441	2.998	30	Pass
2.480	3.162	30	Pass

CH0





CH39

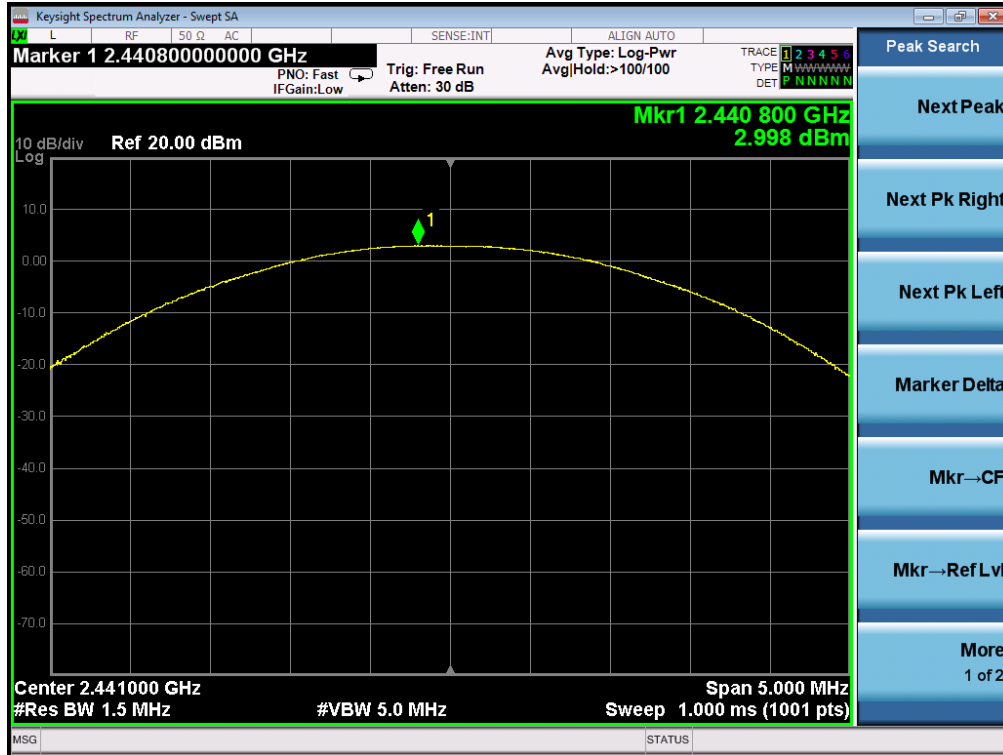

CH78

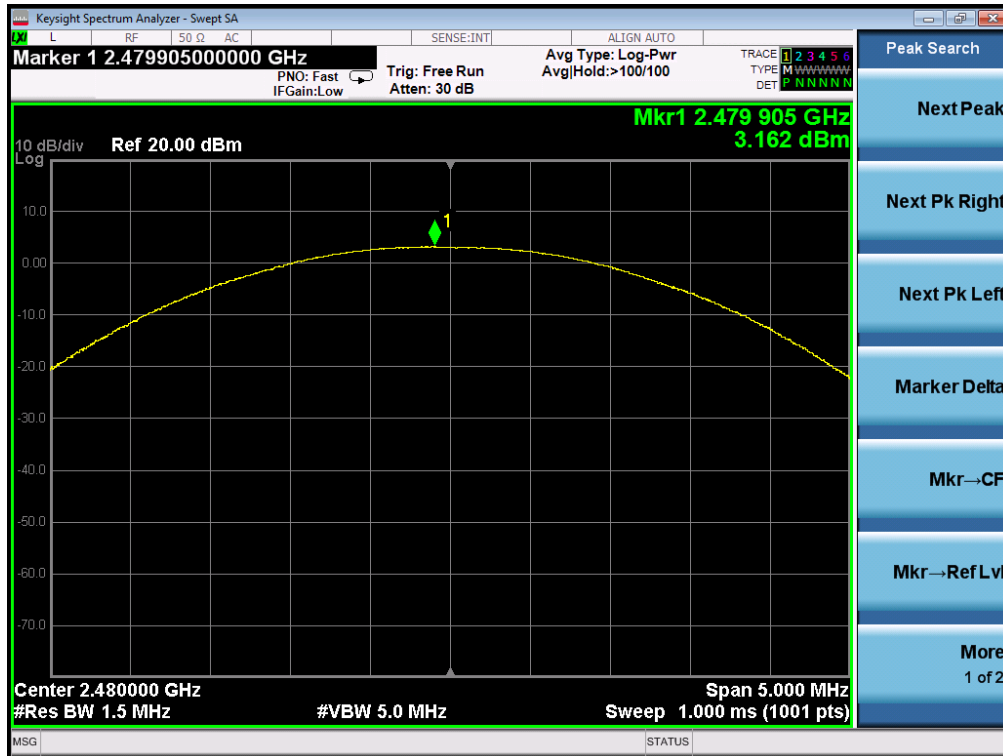



## 4. 20dB Bandwidth

### 4.1. Measurement Procedure

1. Connect EUT RF output port to the Spectrum Analyzer through an RF attenuator
2. Set the EUT Work on the top, the middle and the bottom operation frequency individually.
3. Set Span = approximately 2 to 5 times the 20 dB bandwidth, centered on a hopping channel  
The nominal IF filter bandwidth (3 dB RBW) shall be in the range of 1% to 5% of the OBW and video bandwidth (VBW) shall be approximately three times RBW; Sweep = auto; Detector function = peak
4. Set SPA Trace 1 Max hold, then View.

### 4.2. Test Set-Up (Block Diagram of Configuration)

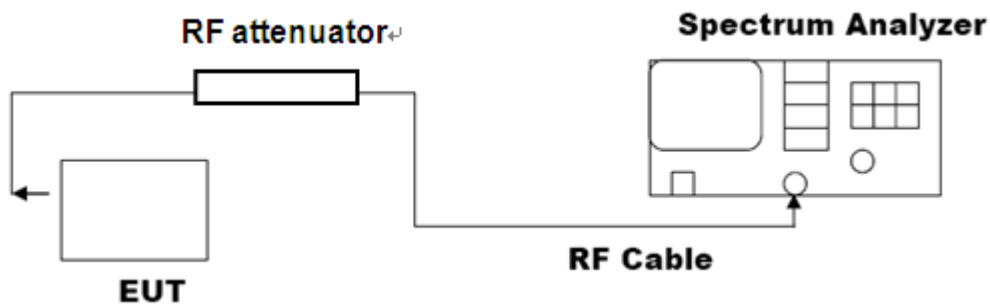



### 4.3. Limits and Measurement Results

MEASUREMENT RESULT FOR GFSK MODULATION			
Applicable Limits	Measurement Result		
	Test Data (MHz)		Criteria
N/A	Low Channel	0.9478	PASS
	Middle Channel	0.9478	PASS
	High Channel	0.9467	PASS

TEST PLOT OF BANDWIDTH FOR LOW CHANNEL

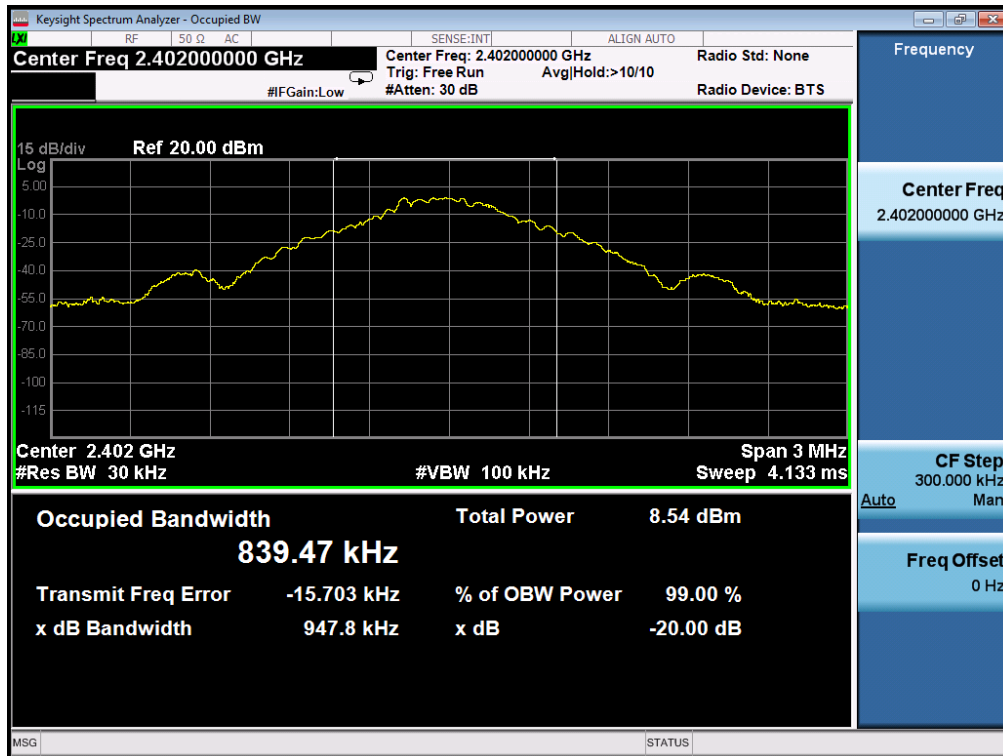





### TEST PLOT OF BANDWIDTH FOR MIDDLE CHANNEL

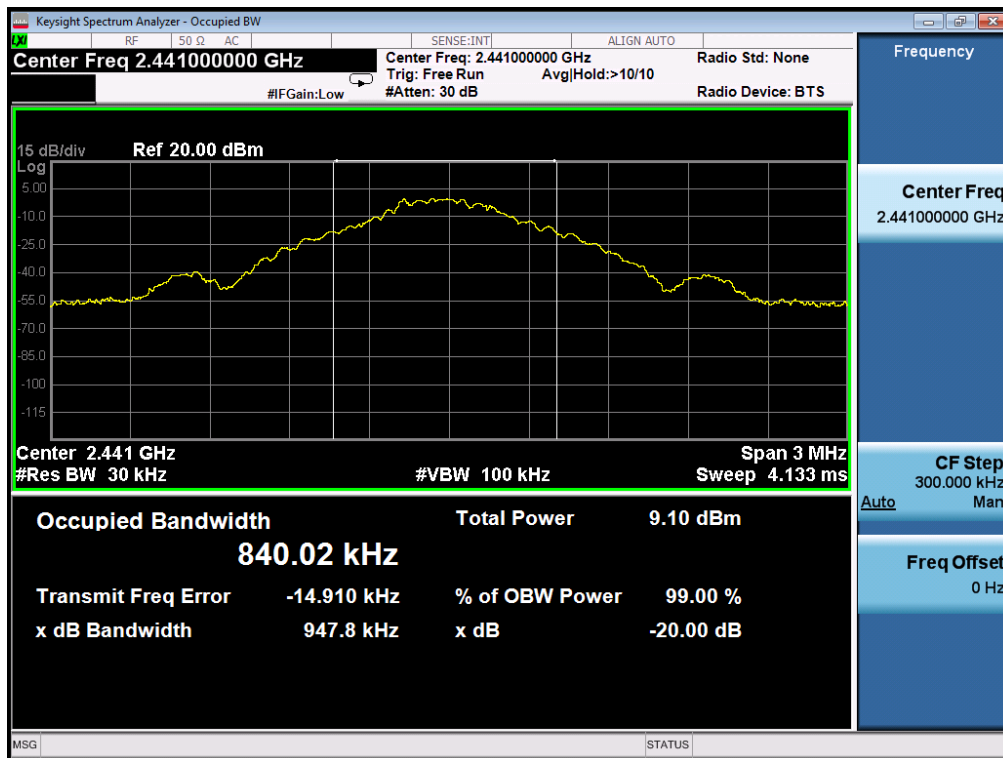

### TEST PLOT OF BANDWIDTH FOR HIGH CHANNEL





MEASUREMENT RESULT FOR $\Pi/4$ -DQPSK MODULATION			
Applicable Limits	Measurement Result		
	Test Data (MHz)		Criteria
N/A	Low Channel	1.307	PASS
	Middle Channel	1.305	PASS
	High Channel	1.314	PASS

TEST PLOT OF BANDWIDTH FOR LOW CHANNEL

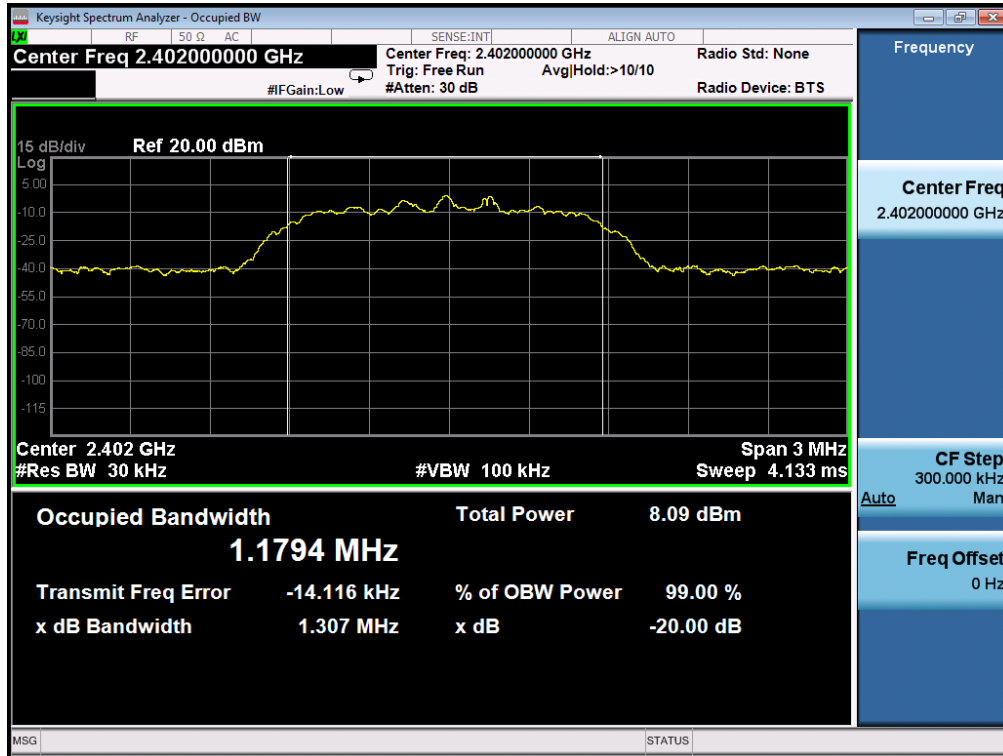



### TEST PLOT OF BANDWIDTH FOR MIDDLE CHANNEL

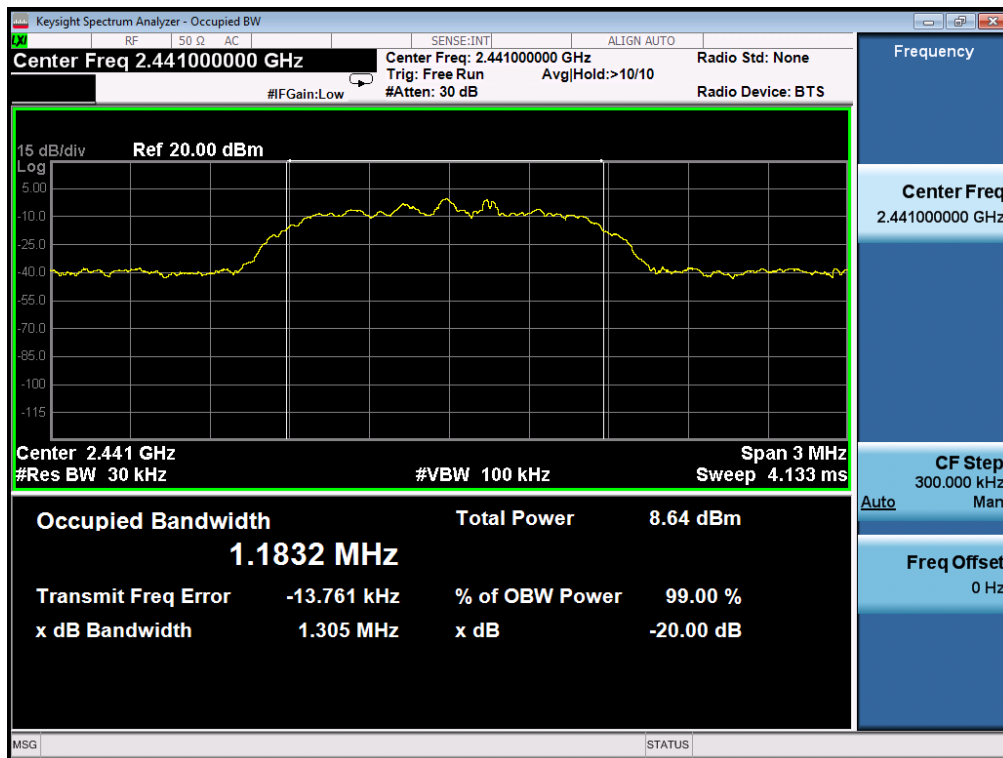

### TEST PLOT OF BANDWIDTH FOR HIGH CHANNEL

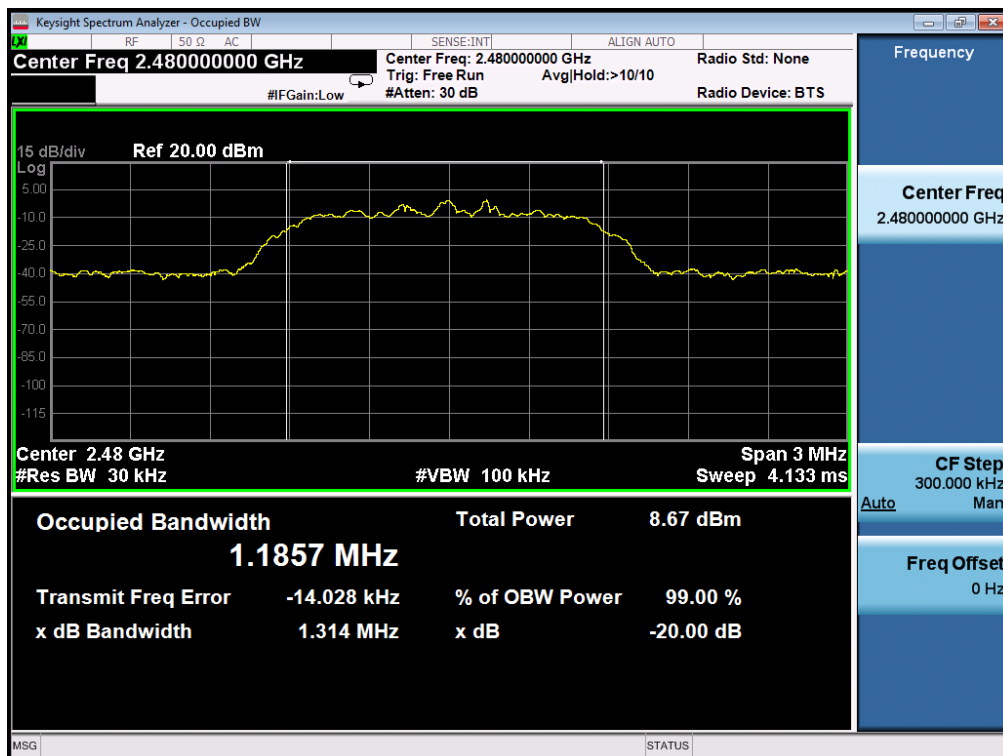



## 5. Conducted Spurious Emission

### 5.1. Measurement Procedure

1. Connect EUT RF output port to the Spectrum Analyzer through an RF attenuator
2. Set the EUT Work on the top, the Middle and the bottom operation frequency individually.
3. Set the Span = wide enough to capture the peak level of the in-band emission and all spurious emissions from the lowest frequency generated in the EUT up through the 10th harmonic.  
RBW = 100 kHz; VBW= 300 kHz; Sweep = auto; Detector function = peak.
4. Set SPA Trace 1 Max hold, then View.

### 5.2. Test Set-Up (Block Diagram of Configuration)

The same as described in section 4.2

### 5.3. Limits and Measurement Result

LIMITS AND MEASUREMENT RESULT		
Applicable Limits	Measurement Result	
	Test Data	Criteria
In any 100 KHz Bandwidth Outside the frequency band in which the spread spectrum intentional radiator is operating, the radio frequency power that is produce by the intentional radiator shall be at least 20 dB below that in 100KHz bandwidth within the band that contains the highest level of the desired power. In addition, radiation emissions which fall in the restricted bands, as defined in §15.205(a), must also comply with the radiated emission limits specified in§15.209(a)	At least -20dBc than the limit Specified on the BOTTOM Channel	PASS
	At least -20dBc than the limit Specified on the TOP Channel	PASS







### TEST PLOT OF OUT OF BAND EMISSIONS OF GFSK MODULATION IN HIGH CHANNEL



Note: The peak emissions without marker on the above plots are fundamental wave and need not to compare with the limit. The GFSK modulation is the worst case and only those data recorded in the report.



### TEST RESULT FOR BAND EDGE GFSK MODULATION IN LOW CHANNEL Hopping off

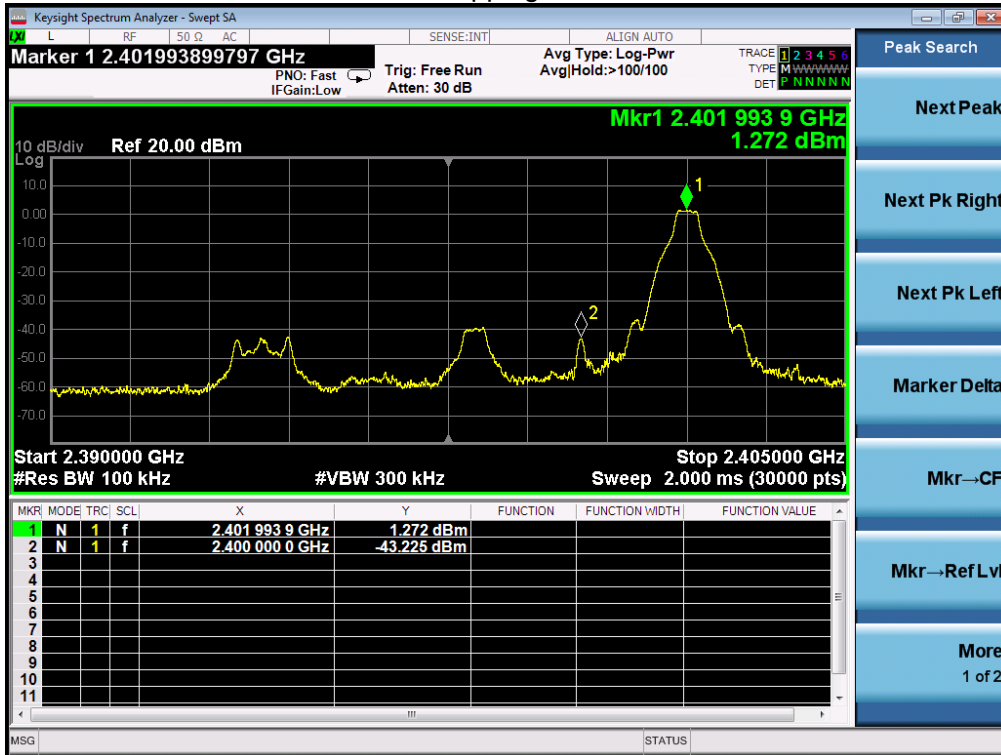

### Hopping on

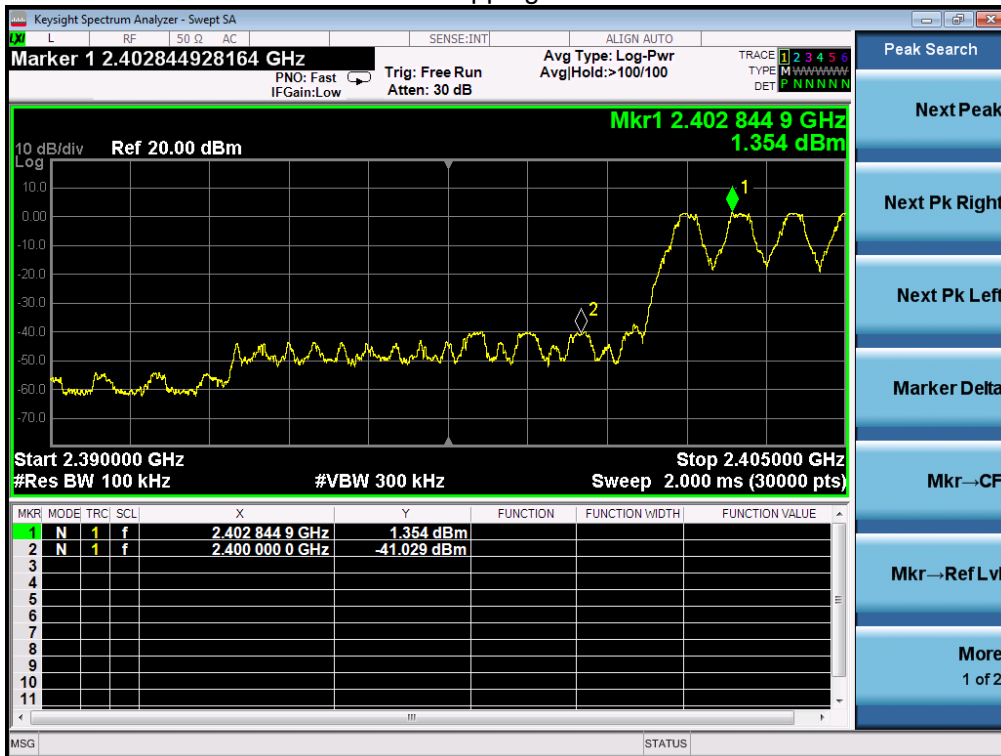











## 6. Radiated Emission

### 6.1. Measurement Procedure

1. The EUT was placed on the top of the turntable 0.8 or 1.5 meter above ground. The phase center of the receiving antenna mounted on the top of a height-variable antenna tower was placed 3 meters far away from the turntable.
2. Power on the EUT and all the supporting units. The turntable was rotated by 360 degrees to determine the position of the highest radiation.
3. The height of the broadband receiving antenna was varied between one meter and four meters above ground to find the maximum emissions field strength of both horizontal and vertical polarization.
4. For each suspected emissions, the antenna tower was scan (from 1 M to 4 M) and then the turntable was rotated (from 0 degree to 360 degrees) to find the maximum reading.
5. Set the test-receiver system to Peak or CISPR quasi-peak Detect Function with specified bandwidth under Maximum Hold Mode.
6. For emissions above 1GHz, use 1MHz RBW and 3MHz VBW for peak reading. Place the measurement antenna away from each area of the EUT determined to be a source of emissions at the specified measurement distance, while keeping the measurement antenna aimed at the source of emissions at each frequency of significant emissions, with polarization oriented for maximum response. The measurement antenna may have to be higher or lower than the EUT, depending on the radiation pattern of the emission and staying aimed at the emission source for receiving the maximum signal. The final measurement antenna elevation shall be that which maximizes the emissions. The measurement antenna elevation for maximum emissions shall be restricted to a range of heights of from 1 m to 4 m above the ground or reference ground plane.
7. When the radiated emissions limits are expressed in terms of the average value of the emissions, and pulsed operation is employed, the measurement field strength shall be determined by averaging over one complete pulse train, including blanking intervals, as long as the pulse train does not exceed 0.1 seconds. As an alternative (provided the transmitter operates for longer than 0.1 seconds) or in cases where the pulse train exceeds 0.1 seconds, the measured field strength shall be determined from the average absolute voltage during a 0.1 second interval during which the field strength is at its maximum values.
8. If the emissions level of the EUT in peak mode was 3 dB lower than the average limit specified, then testing will be stopped and peak values of EUT will be reported, otherwise, the emissions which do not have 3 dB margin will be repeated one by one using the quasi-peak method for below 1GHz.
9. For testing above 1GHz, the emissions level of the EUT in peak mode was lower than average limit (that means the emissions level in peak mode also complies with the limit in average mode), then testing will be stopped and peak values of EUT will be reported, otherwise, the emissions will be measured in average mode again and reported.
10. In case the emission is lower than 30MHz, loop antenna has to be used for measurement and the recorded data should be QP measured by receiver. High - Low scan is not required in this case.



The following table is the setting of spectrum analyzer and receiver.

<b>Spectrum Parameter</b>	<b>Setting</b>
Start ~Stop Frequency	9KHz~150KHz/RB 200Hz for QP
Start ~Stop Frequency	150KHz~30MHz/RB 9KHz for QP
Start ~Stop Frequency	30MHz~1000MHz/RB 120KHz for QP
Start ~Stop Frequency	1GHz~26.5GHz 1MHz/3MHz for Peak, 1MHz/10Hz for Average

<b>Receiver Parameter</b>	<b>Setting</b>
Start ~Stop Frequency	9KHz~150KHz/RB 200Hz for QP
Start ~Stop Frequency	150KHz~30MHz/RB 9KHz for QP
Start ~Stop Frequency	30MHz~1000MHz/RB 120KHz for QP

### 6.2. Test Setup

Radiated Emission Test-Setup Frequency Below 30MHz

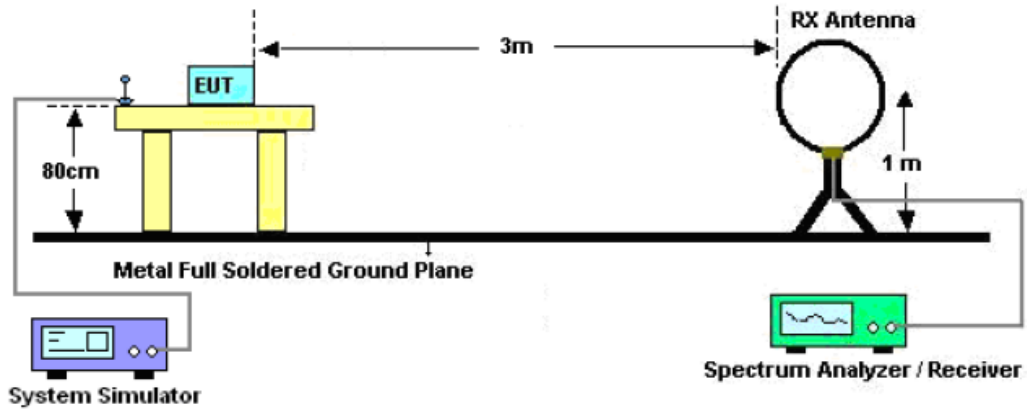

RADIATED EMISSION TEST SETUP 30MHz-1000MHz

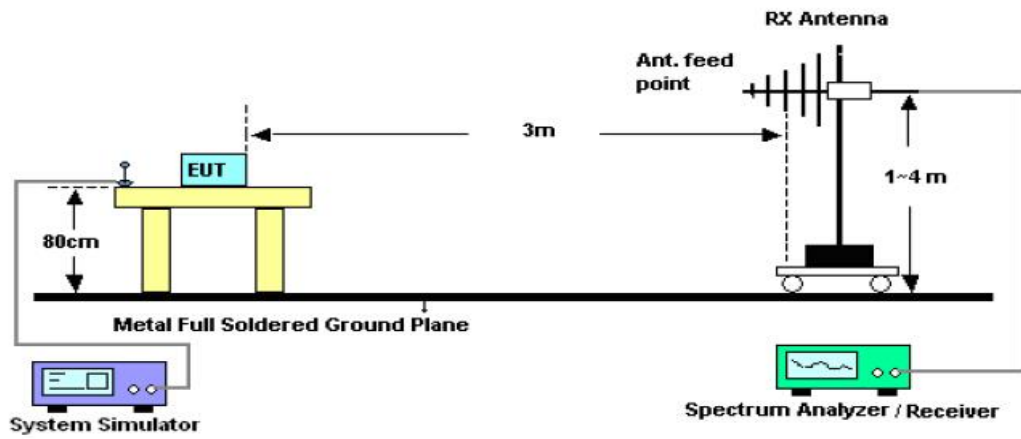

RADIATED EMISSION TEST SETUP ABOVE 1000MHz

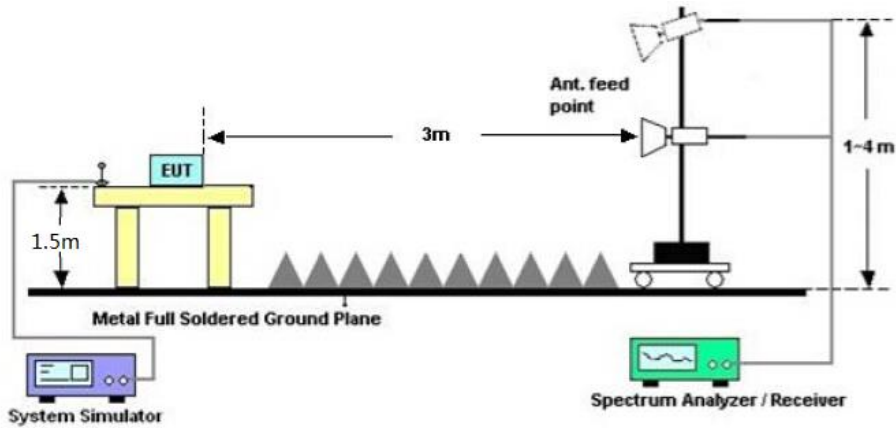



### 6.3. Limits and Measurement Result

15.209&RSS-GEN Limit in the below table has to be followed

<b>Frequencies (MHz)</b>	<b>Field Strength (micровolts/meter)</b>	<b>Measurement Distance (meters)</b>
0.009~0.490	2400/F(KHz)	300
0.490~1.705	24000/F(KHz)	30
1.705~30.0	30	30
30~88	100	3
88~216	150	3
216~960	200	3
Above 960	500	3

Note: All modes were tested For restricted band radiated emission,  
the test records reported below are the worst result compared to other modes.



**RADIATED EMISSION BELOW 30MHZ**

No emission found between lowest internal used/generated frequencies to 30MHz.

**RADIATED EMISSION BELOW 1GHZ**

<b>EUT</b>	Bluetooth Headphone	<b>Model Name</b>	XY523
<b>Temperature</b>	25°C	<b>Relative Humidity</b>	55.4%
<b>Pressure</b>	960hPa	<b>Test Voltage</b>	Normal Voltage
<b>Test Mode</b>	Mode 4	<b>Antenna</b>	Horizontal

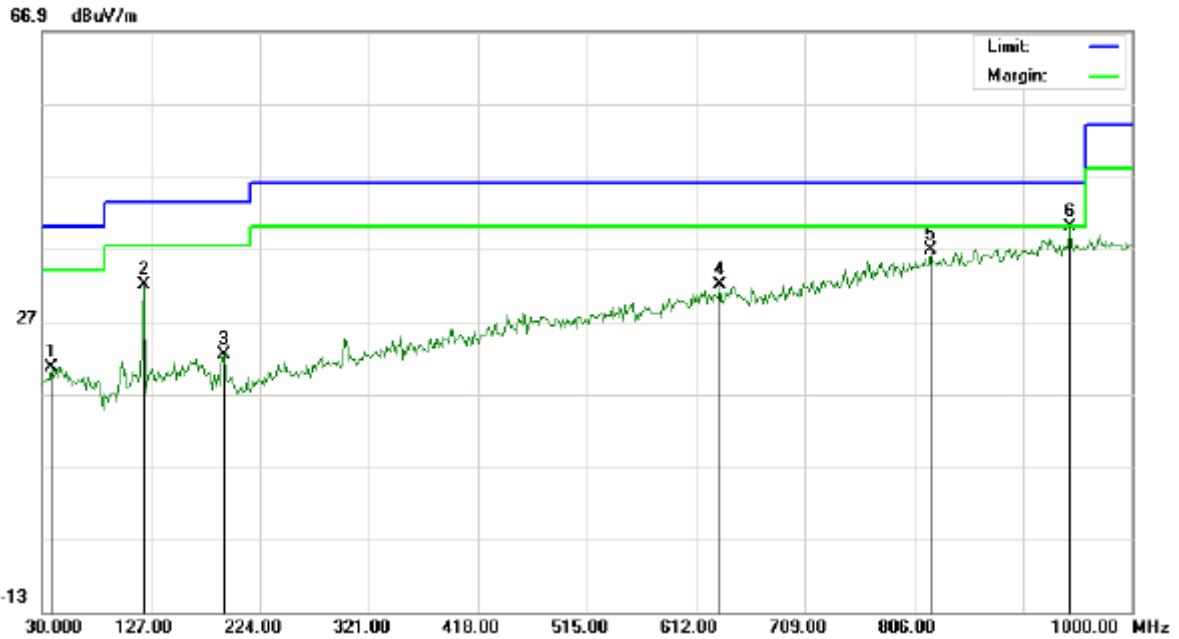

No.	Mk	Freq.	Reading	Factor	Measurement	Limit	Over	Detector	Antenna Height	Table Degree	Comment
		MHz	dBuV	dB/m	dBuV/m	dBuV/m	dB		cm	degree	
1		38.0833	0.39	20.25	20.64	40.00	-19.36	peak			
2		120.5333	12.84	19.16	32.00	43.50	-11.50	peak			
3		191.6667	4.47	17.96	22.43	43.50	-21.07	peak			
4		633.0167	1.60	30.34	31.94	46.00	-14.06	peak			
5		820.5500	2.25	34.50	36.75	46.00	-9.25	peak			
6	*	945.0333	3.51	36.47	39.98	46.00	-6.02	peak			

**RESULT: PASS**





<b>EUT</b>	Bluetooth Headphone	<b>Model Name</b>	XY523
<b>Temperature</b>	25°C	<b>Relative Humidity</b>	55.4%
<b>Pressure</b>	960hPa	<b>Test Voltage</b>	Normal Voltage
<b>Test Mode</b>	Mode 4	<b>Antenna</b>	Vertical

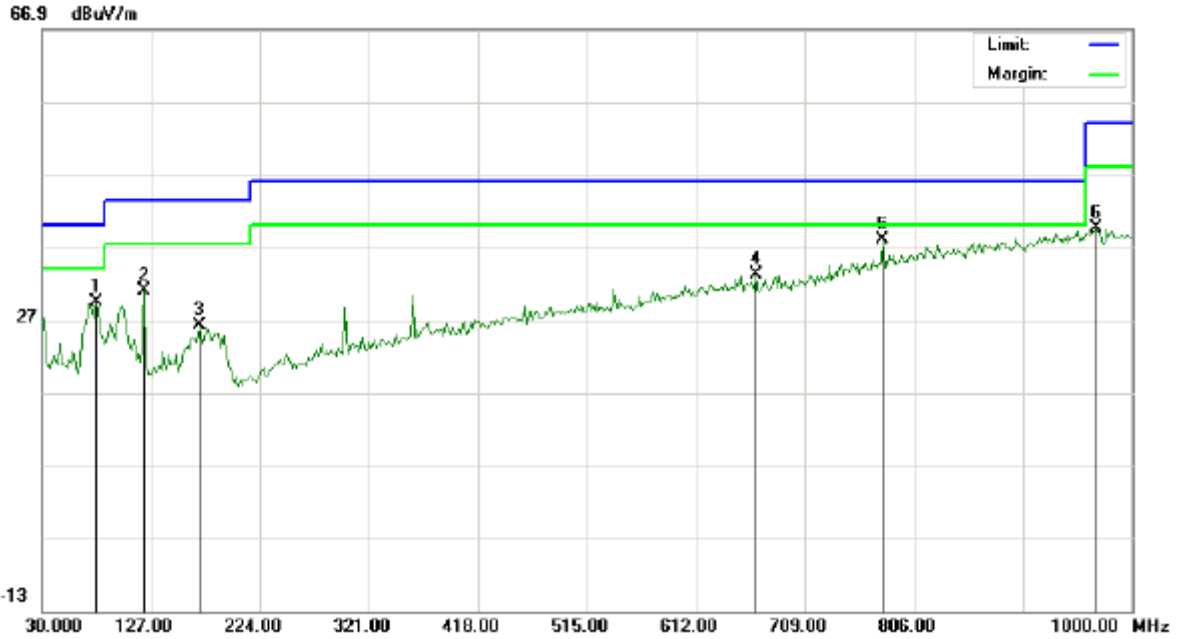

No.	Mk	Freq.	Reading	Factor	Measurement	Limit	Over	Detector	Antenna Height	Table Degree	Comment
		MHz	dBuV	dB/m	dBuV/m	dBuV/m	dB		cm	degree	
1		78.5000	13.18	16.14	29.32	40.00	-10.68	peak			
2		120.5333	11.77	19.16	30.93	43.50	-12.57	peak			
3		170.6500	6.74	19.37	26.11	43.50	-17.39	peak			
4		665.3500	2.30	30.84	33.14	46.00	-12.86	peak			
5	*	778.5167	4.40	33.54	37.94	46.00	-8.06	peak			
6		967.6667	2.79	36.75	39.54	54.00	-14.46	peak			

**RESULT: PASS**

**Note:** 1. Factor=Antenna Factor+ Cable loss, Margin=Measurement-Limit.

2. All test modes had been pre-tested. The mode 4 is the worst case and recorded in the report.

**RADIATED EMISSION ABOVE 1GHZ**

<b>EUT</b>	Bluetooth Headphone	<b>Model Name</b>	XY523
<b>Temperature</b>	25°C	<b>Relative Humidity</b>	55.4%
<b>Pressure</b>	960hPa	<b>Test Voltage</b>	Normal Voltage
<b>Test Mode</b>	Mode 1	<b>Antenna</b>	Horizontal

Frequency	Meter Reading	Factor	Emission Level	Limits	Margin	Value Type
(MHz)	(dBμV)	(dB)	(dBμV/m)	(dBμV/m)	(dB)	
4804.062	46.47	3.76	50.23	74.00	-23.77	peak
4804.062	44.36	3.76	48.12	54.00	-5.88	AVG
7206.093	35.98	8.17	44.15	74.00	-29.85	peak
7206.093	32.61	8.17	40.78	54.00	-13.22	AVG

Remark:

Factor = Antenna Factor + Cable Loss – Pre-amplifier.

<b>EUT</b>	Bluetooth Headphone	<b>Model Name</b>	XY523
<b>Temperature</b>	25°C	<b>Relative Humidity</b>	55.4%
<b>Pressure</b>	960hPa	<b>Test Voltage</b>	Normal Voltage
<b>Test Mode</b>	Mode 1	<b>Antenna</b>	Vertical

Frequency	Meter Reading	Factor	Emission Level	Limits	Margin	Value Type
(MHz)	(dBμV)	(dB)	(dBμV/m)	(dBμV/m)	(dB)	
4804.062	50.02	3.76	53.78	74.00	-20.22	peak
4804.062	44.12	3.76	47.88	54.00	-6.12	AVG
7206.093	38.17	8.17	46.34	74.00	-27.66	peak
7206.093	36.74	8.17	44.91	54.00	-9.09	AVG

Remark:

Factor = Antenna Factor + Cable Loss – Pre-amplifier.



<b>EUT</b>	Bluetooth Headphone	<b>Model Name</b>	XY523
<b>Temperature</b>	25°C	<b>Relative Humidity</b>	55.4%
<b>Pressure</b>	960hPa	<b>Test Voltage</b>	Normal Voltage
<b>Test Mode</b>	Mode 2	<b>Antenna</b>	Horizontal

Frequency	Meter Reading	Factor	Emission Level	Limits	Margin	Value Type
(MHz)	(dB $\mu$ V)	(dB)	(dB $\mu$ V/m)	(dB $\mu$ V/m)	(dB)	
4882.062	47.19	3.78	50.97	74.00	-23.03	peak
4882.062	42.85	3.78	46.63	54.00	-7.37	AVG
7323.093	40.88	8.23	49.11	74.00	-24.89	peak
7323.093	37.38	8.23	45.61	54.00	-8.39	AVG

Remark:

Factor = Antenna Factor + Cable Loss – Pre-amplifier.

<b>EUT</b>	Bluetooth Headphone	<b>Model Name</b>	XY523
<b>Temperature</b>	25°C	<b>Relative Humidity</b>	55.4%
<b>Pressure</b>	960hPa	<b>Test Voltage</b>	Normal Voltage
<b>Test Mode</b>	Mode 2	<b>Antenna</b>	Vertical

Frequency	Meter Reading	Factor	Emission Level	Limits	Margin	Value Type
(MHz)	(dB $\mu$ V)	(dB)	(dB $\mu$ V/m)	(dB $\mu$ V/m)	(dB)	
4882.062	47.78	3.78	51.56	74.00	-22.44	peak
4882.062	44.67	3.78	48.45	54.00	-5.55	AVG
7323.093	40.41	8.23	48.64	74.00	-25.36	peak
7323.093	36.89	8.23	45.12	54.00	-8.88	AVG

Remark:

Factor = Antenna Factor + Cable Loss – Pre-amplifier.



<b>EUT</b>	Bluetooth Headphone	<b>Model Name</b>	XY523
<b>Temperature</b>	25°C	<b>Relative Humidity</b>	55.4%
<b>Pressure</b>	960hPa	<b>Test Voltage</b>	Normal Voltage
<b>Test Mode</b>	Mode 3	<b>Antenna</b>	Horizontal

Frequency	Meter Reading	Factor	Emission Level	Limits	Margin	Value Type
(MHz)	(dBμV)	(dB)	(dBμV/m)	(dBμV/m)	(dB)	
4960.062	46.31	3.81	50.12	74.00	-23.88	peak
4960.062	44.97	3.81	48.78	54.00	-5.22	AVG
7440.093	39.33	8.27	47.60	74.00	-26.40	peak
7440.093	37.28	8.27	45.55	54.00	-8.45	AVG
Remark:						
Factor = Antenna Factor + Cable Loss – Pre-amplifier.						

<b>EUT</b>	Bluetooth Headphone	<b>Model Name</b>	XY523
<b>Temperature</b>	25°C	<b>Relative Humidity</b>	55.4%
<b>Pressure</b>	960hPa	<b>Test Voltage</b>	Normal Voltage
<b>Test Mode</b>	Mode 3	<b>Antenna</b>	Vertical

Frequency	Meter Reading	Factor	Emission Level	Limits	Margin	Value Type
(MHz)	(dBμV)	(dB)	(dBμV/m)	(dBμV/m)	(dB)	
4960.062	46.42	3.81	50.23	74.00	-23.77	peak
4960.062	44.64	3.81	48.45	54.00	-5.55	AVG
7440.093	39.28	8.27	47.55	74.00	-26.45	peak
7440.093	37.34	8.27	45.61	54.00	-8.39	AVG
Remark:						
Factor = Antenna Factor + Cable Loss – Pre-amplifier.						

**RESULT: PASS**

**Note:**

Other emissions from 1G to 25 GHz are considered as ambient noise. No recording in the test report.

Factor=Antenna Factor+ Cable loss-Amplifier gain, Over=Measure-Limit.

The "Factor" value can be calculated automatically by software of measurement system.

All test modes had been tested. The GFSK modulation is the worst case and recorded in the report.



**TEST RESULT FOR RESTRICTED BANDS REQUIREMENTS**

EUT	Bluetooth Headphone	Model Name	XY523
Temperature	25°C	Relative Humidity	55.4%
Pressure	960hPa	Test Voltage	Normal Voltage
Test Mode	Mode 1	Antenna	Horizontal

PK

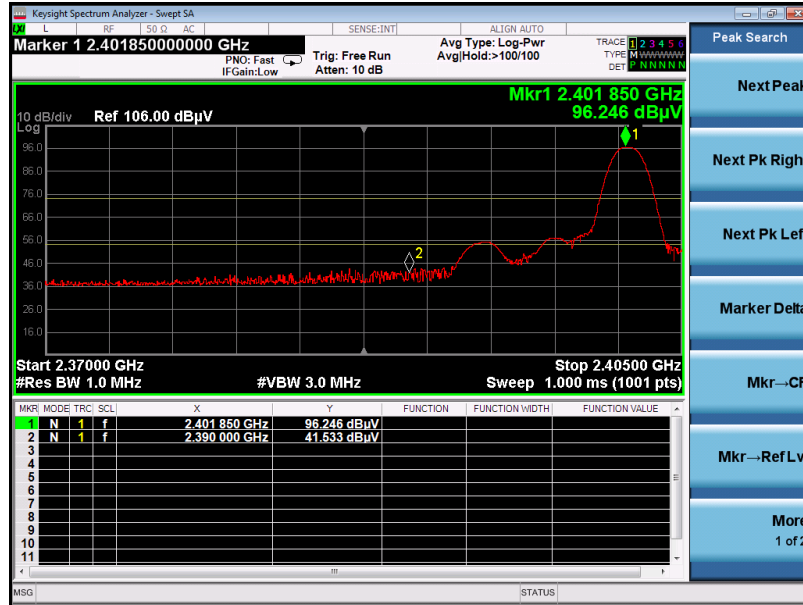

AV

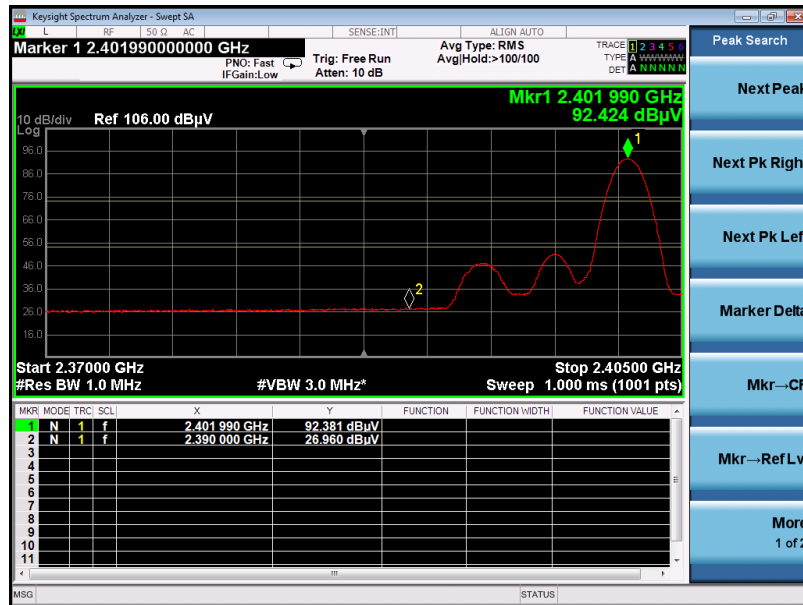

RESULT: PASS



EUT	Bluetooth Headphone	Model Name	XY523
Temperature	25°C	Relative Humidity	55.4%
Pressure	960hPa	Test Voltage	Normal Voltage
Test Mode	Mode 1	Antenna	Vertical

PK

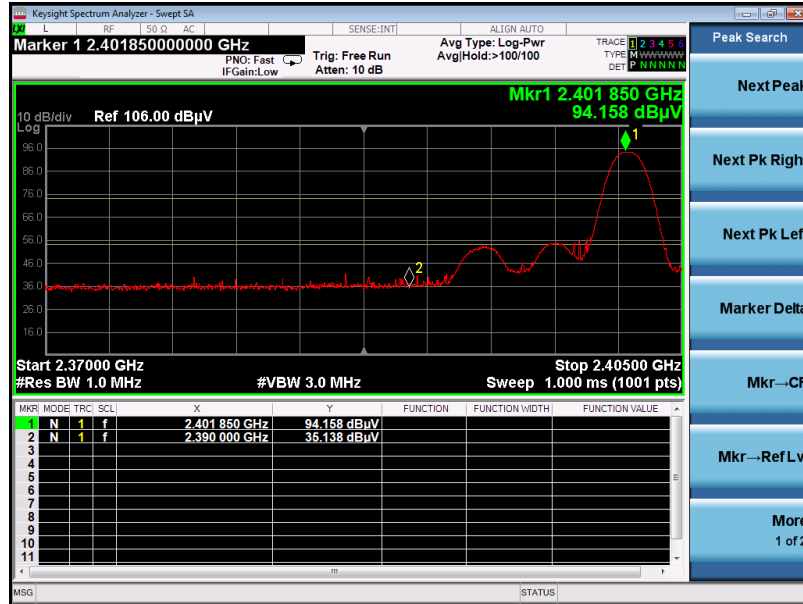

AV

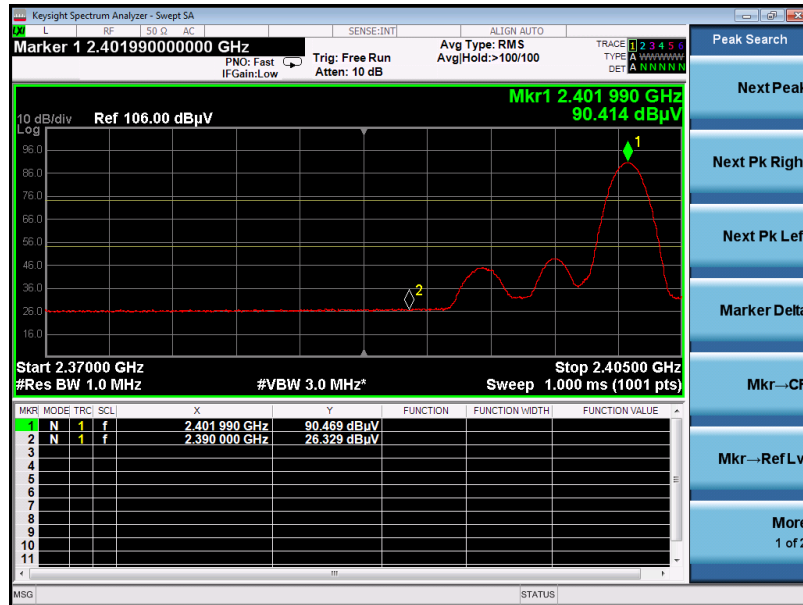

RESULT: PASS



EUT	Bluetooth Headphone	Model Name	XY523
Temperature	25°C	Relative Humidity	55.4%
Pressure	960hPa	Test Voltage	Normal Voltage
Test Mode	Mode 3	Antenna	Horizontal

PK

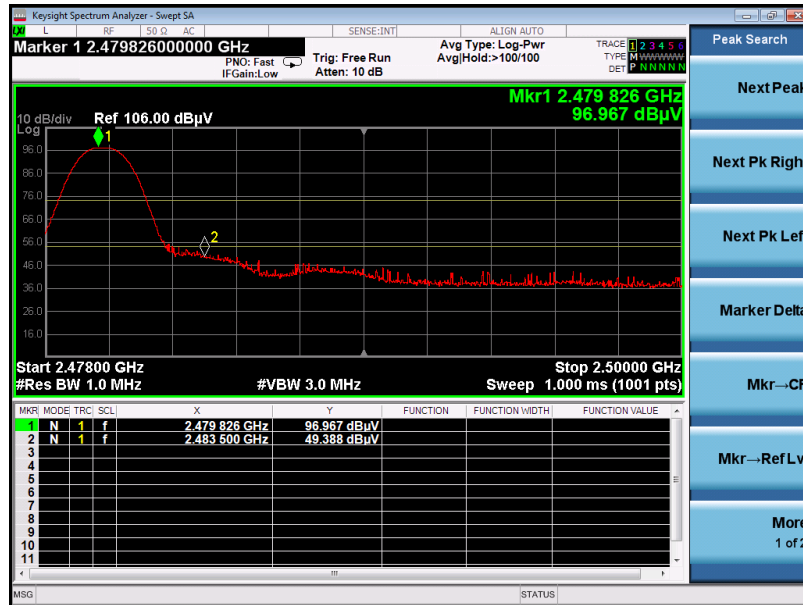

AV



RESULT: PASS



EUT	Bluetooth Headphone	Model Name	XY523
Temperature	25°C	Relative Humidity	55.4%
Pressure	960hPa	Test Voltage	Normal Voltage
Test Mode	Mode 3	Antenna	Vertical

PK

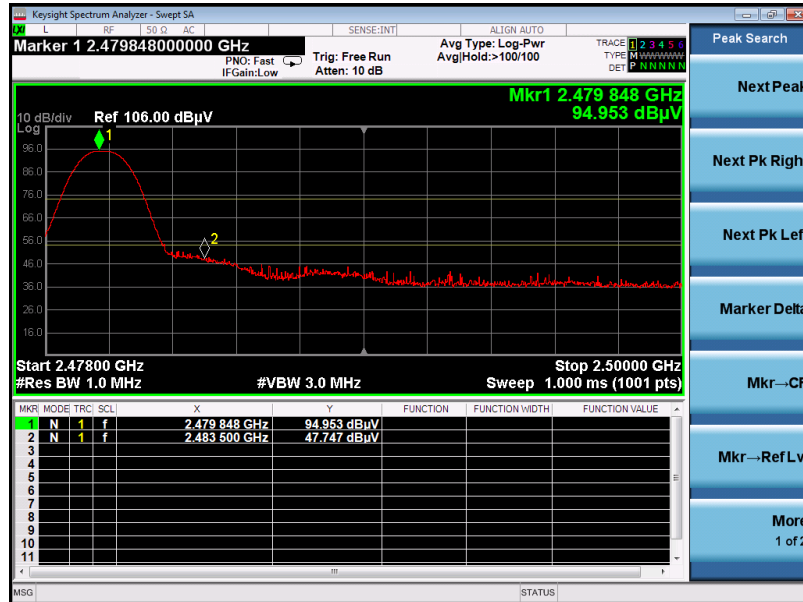

AV



RESULT: PASS

**Note:**The factor had been edited in the “Input Correction” of the Spectrum Analyzer. So the Amplitude of test plots is equal to Reading level plus the Factor in dB. Use the A dB(μV) to represent the Amplitude. Use the F dB(μV/m) to represent the Field Strength. So A=F. All test modes had been pre-tested. The GFSK modulation is the worst case and recorded in the report.



## 7. FCC LINE CONDUCTED EMISSION TEST

### 7.1. LIMITS OF LINE CONDUCTED EMISSION TEST

Frequency	Maximum RF Line Voltage	
	Q.P.( dBuV)	Average( dBuV)
150kHz~500kHz	66-56	56-46
500kHz~5MHz	56	46
5MHz~30MHz	60	50

Note:

1. The lower limit shall apply at the transition frequency.
2. The limit decreases linearly with the logarithm of the frequency in the range 0.15 MHz to 0.50 MHz.

### 7.2. BLOCK DIAGRAM OF LINE CONDUCTED EMISSION TEST

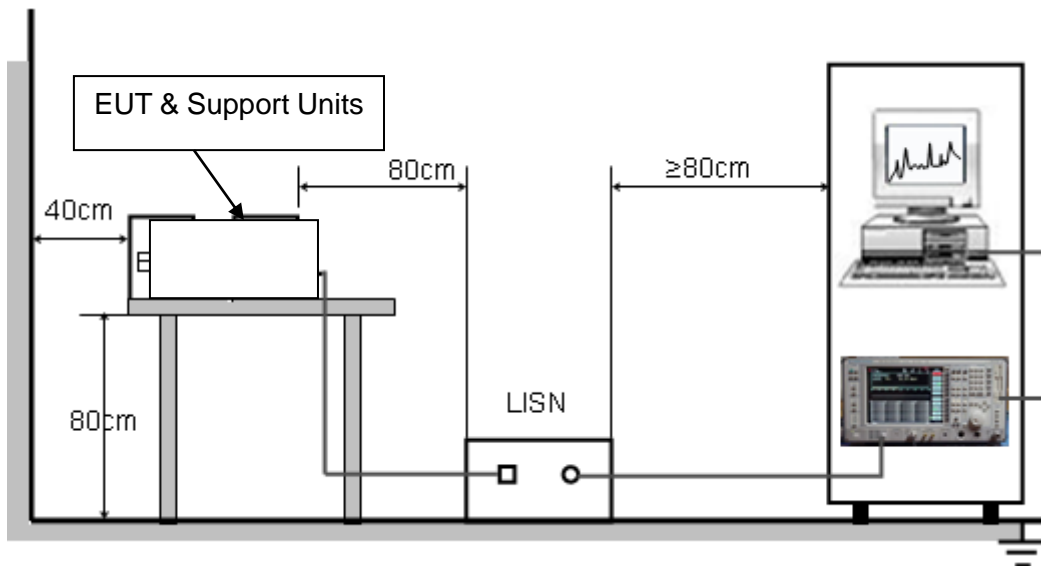



### 7.3. PRELIMINARY PROCEDURE OF LINE CONDUCTED EMISSION TEST

1. The equipment was set up as per the test configuration to simulate typical actual usage per the user's manual. When the EUT is a tabletop system, a wooden table with a height of 0.8 meters is used and is placed on the ground plane as per ANSI C63.10 (see Test Facility for the dimensions of the ground plane used). When the EUT is a floor-standing equipment, it is placed on the ground plane which has a 3-12 mm non-conductive covering to insulate the EUT from the ground plane.
2. Support equipment, if needed, was placed as per ANSI C63.10.
3. All I/O cables were positioned to simulate typical actual usage as per ANSI C63.10.
4. All support equipments received AC120V/60Hz power from a LISN, if any.
5. The EUT received DC 5V power from adapter which received AC120V/60Hz power from a LISN.
6. The test program was started. Emissions were measured on each current carrying line of the EUT using a spectrum Analyzer / Receiver connected to the LISN powering the EUT. The LISN has two monitoring points: Line 1 (Hot Side) and Line 2 (Neutral Side). Two scans were taken: one with Line 1 connected to Analyzer / Receiver and Line 2 connected to a 50 ohm load; the second scan had Line 1 connected to a 50 ohm load and Line 2 connected to the Analyzer / Receiver.
7. Analyzer / Receiver scanned from 150 kHz to 30MHz for emissions in each of the test modes.
8. During the above scans, the emissions were maximized by cable manipulation.
9. The test mode(s) were scanned during the preliminary test.

Then, the EUT configuration and cable configuration of the above highest emission level were recorded for reference of final testing.

### 7.4. FINAL PROCEDURE OF LINE CONDUCTED EMISSION TEST

1. EUT and support equipment was set up on the test bench as per step 2 of the preliminary test.
2. A scan was taken on both power lines, Line 1 and Line 2, recording at least the six highest emissions. Emission frequency and amplitude were recorded into a computer in which correction factors were used to calculate the emission level and compare reading to the applicable limit. If EUT emission level was less  $-2\text{dB}$  to the A.V. limit in Peak mode, then the emission signal was re-checked using Q.P and Average detector.
3. The test data of the worst case condition(s) was reported on the Summary Data page.



### 7.5. TEST RESULT OF LINE CONDUCTED EMISSION TEST

Line Conducted Emission Test Line 1-L

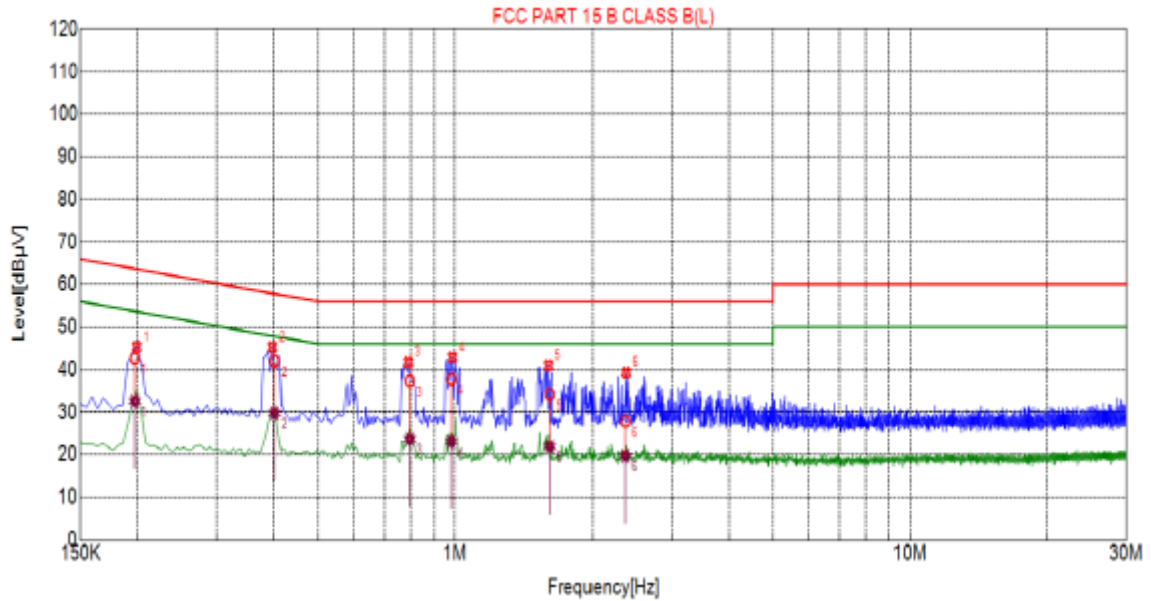

Suspected List						
NO.	Freq. [MHz]	Level [dBµV]	Factor [dB]	Limit [dBµV]	Margin [dB]	Detector
1	0.1995	45.34	10.03	63.63	18.29	PK
2	0.3975	45.26	10.04	57.91	12.65	PK
3	0.7890	41.72	10.05	56.00	14.28	PK
4	0.9870	42.88	10.06	56.00	13.12	PK
5	1.6080	40.98	10.11	56.00	15.02	PK
6	2.3730	39.32	10.18	56.00	16.68	PK

Final Data List								
NO.	Freq. [MHz]	Factor [dB]	QP Value [dBµV]	QP Limit [dBµV]	QP Margin [dB]	AV Value [dBµV]	AV Limit [dBµV]	AV Margin [dB]
1	0.1975	10.03	42.61	63.71	21.10	32.62	53.71	21.09
2	0.4015	10.04	42.02	57.82	15.80	29.77	47.82	18.05
3	0.7948	10.05	37.38	56.00	18.62	23.69	46.00	22.31
4	0.9818	10.06	37.77	56.00	18.23	23.10	46.00	22.90
5	1.6183	10.11	34.14	56.00	21.86	21.94	46.00	24.06
6	2.3841	10.18	27.85	56.00	28.15	19.71	46.00	26.29



Line Conducted Emission Test Line 2-N

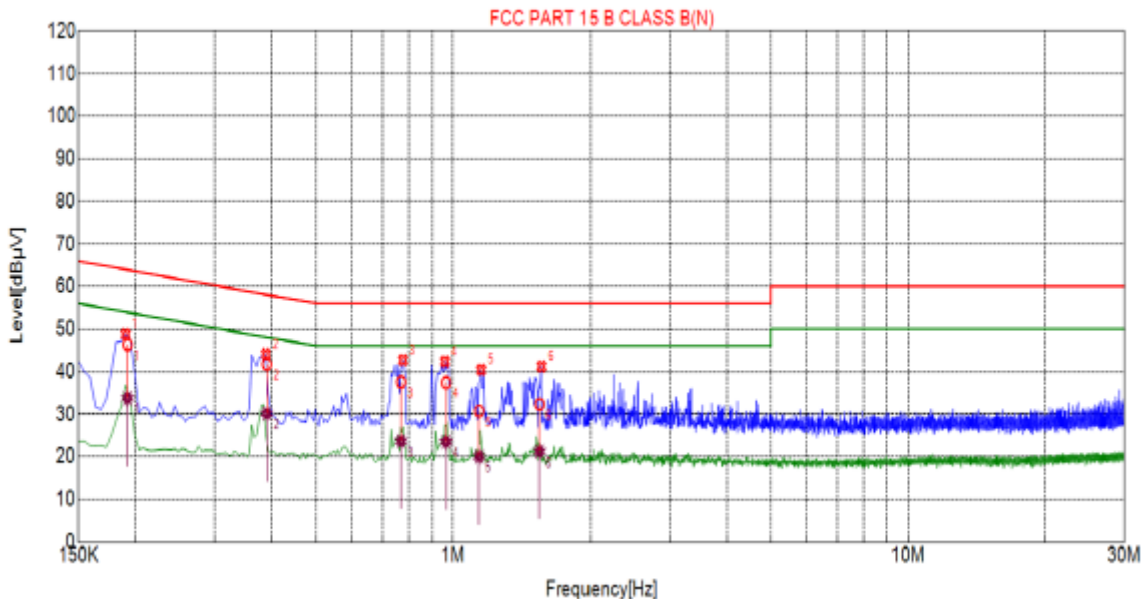

Suspected List						
NO.	Freq. [MHz]	Level [dBµV]	Factor [dB]	Limit [dBµV]	Margin [dB]	Detector
1	0.1905	48.81	10.04	64.02	15.21	PK
2	0.3885	44.06	10.04	58.10	14.04	PK
3	0.7755	42.67	10.05	56.00	13.33	PK
4	0.9600	42.34	10.06	56.00	13.66	PK
5	1.1535	40.38	10.09	56.00	15.62	PK
6	1.5675	41.21	10.11	56.00	14.79	PK

Final Data List								
NO.	Freq. [MHz]	Factor [dB]	QP Value [dBµV]	QP Limit [dBµV]	QP Margin [dB]	AV Value [dBµV]	AV Limit [dBµV]	AV Margin [dB]
1	0.1924	10.04	46.31	63.93	17.62	33.75	53.93	20.18
2	0.3902	10.04	41.75	58.08	16.31	30.16	48.06	17.90
3	0.7878	10.05	37.56	56.00	18.44	23.65	46.00	22.35
4	0.9654	10.06	37.43	56.00	18.57	23.47	46.00	22.53
5	1.1420	10.09	30.76	56.00	25.24	20.05	46.00	25.95
6	1.5518	10.11	32.32	56.00	23.68	21.26	46.00	24.74

**RESULT: PASS**

Note: All the test modes had been tested, the mode 1 was the worst case. Only the data of the worst case would be record in this test report.



## 8. Number of Hopping Frequency

### 8.1. Measurement Procedure

The EUT shall have its hopping function enabled. Use the following spectrum analyzer settings:

1. Span: The frequency band of operation. Depending on the number of channels the device supports, it may be necessary to divide the frequency range of operation across multiple spans, to allow the individual channels to be clearly seen.
2. RBW: To identify clearly the individual channels, set the RBW to less than 30% of the channel spacing or the 20 dB bandwidth, whichever is smaller.
3. VBW  $\geq$  RBW. Sweep: Auto. Detector function: Peak. Trace: Max hold.
4. Allow the trace to stabilize.

### 8.2. Test Setup (Block Diagram of Configuration)

Same as described in section 4.2

### 8.3. Limits and Measurement Result

TOTAL NO. OF HOPPING CHANNEL	LIMIT (NO. OF CH)	MEASUREMENT (NO. OF CH)	RESULT
	$\geq 15$	79	PASS

TEST PLOT FOR NO. OF TOTAL CHANNELS

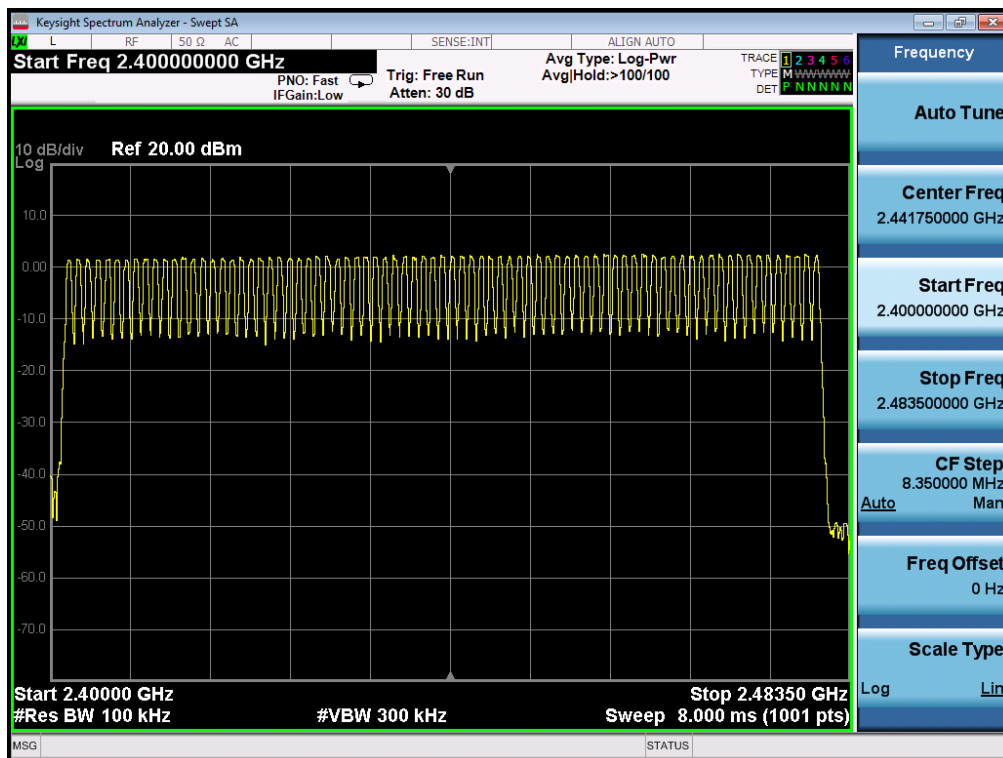

Note: The  $\Pi/4$ -DQPSK modulation is the worst case and recorded in the report.



## 9. Time Of Occupancy (Dwell Time)

### 9.1. Measurement Procedure

The EUT shall have its hopping function enabled. Use the following spectrum analyzer settings:

1. Span: Zero span, centered on a hopping channel.
2. RBW shall be  $\leq$  channel spacing and where possible RBW should be set  $\gg 1 / T$ , where T is the expected dwell time per channel.
3. Sweep: As necessary to capture the entire dwell time per hopping channel; where possible use a video trigger and trigger delay so that the transmitted signal starts a little to the right of the start of the plot. The trigger level might need slight adjustment to prevent triggering when the system hops on an adjacent channel; a second plot might be needed with a longer sweep time to show two successive hops on a channel.
4. Detector function: Peak. Trace: Max hold.
5. Use the marker-delta function to determine the transmit time per hop.
6. Repeat the measurement using a longer sweep time to determine the number of hops over the period specified in the requirements. The sweep time shall be equal to, or less than, the period specified in the requirements. Determine the number of hops over the sweep time and calculate the total number of hops in the period specified in the requirements, using the following equation:  
 (Number of hops in the period specified in the requirements) = (number of hops on spectrum analyzer)  $\times$  (period specified in the requirements / analyzer sweep time)
7. The average time of occupancy is calculated from the transmit time per hop multiplied by the number of hops in the period specified in the requirements.

### 9.2. Test Setup (Block Diagram of Configuration)

Same as described in section 4.2

### 9.3. Limits and Measurement Result

Channel	Time of Pulse for DH5 (ms)	Number of hops in the period specified in the requirements	Sweep Time (ms)	Limit (ms)
Low	2.823	24*4	271.008	400
Middle	2.805	24*4	269.280	400
High	2.872	24*4	275.712	400

Note: The  $\Pi/4$ -DQPSK modulation is the worst case and recorded in the report.



### TEST PLOT OF LOW CHANNEL

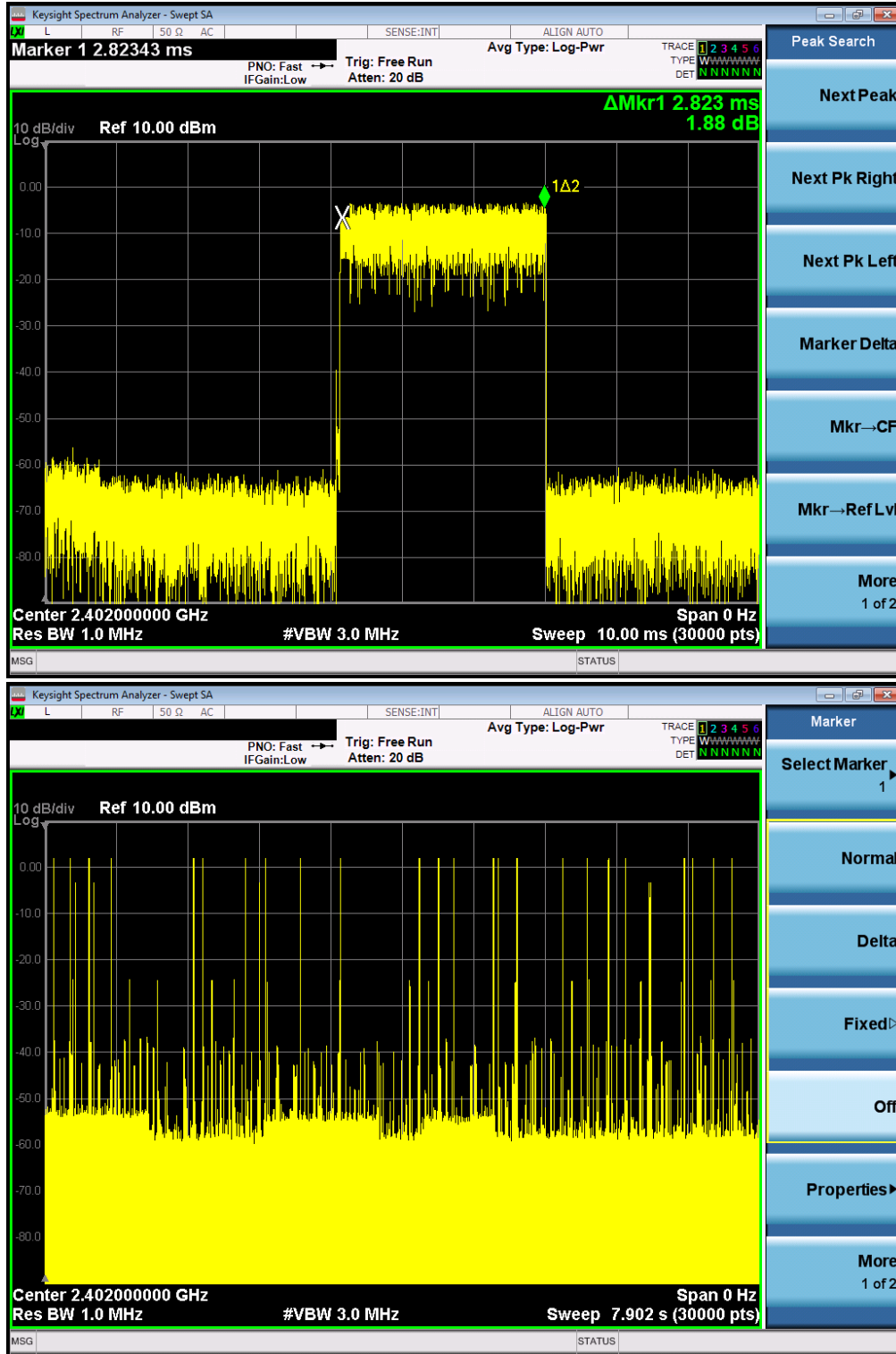



### TEST PLOT OF MIDDLE CHANNEL

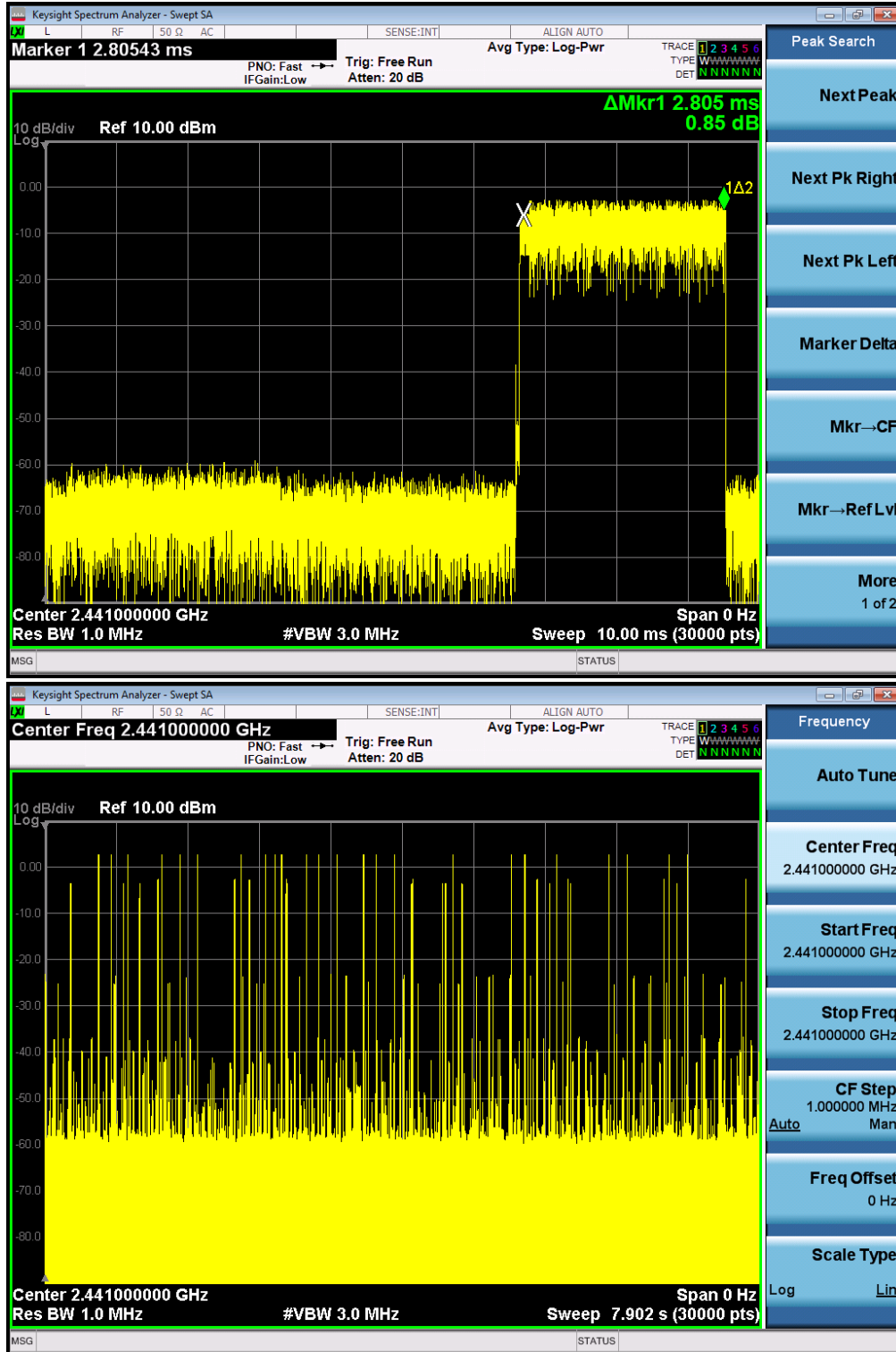





### TEST PLOT OF HIGH CHANNEL

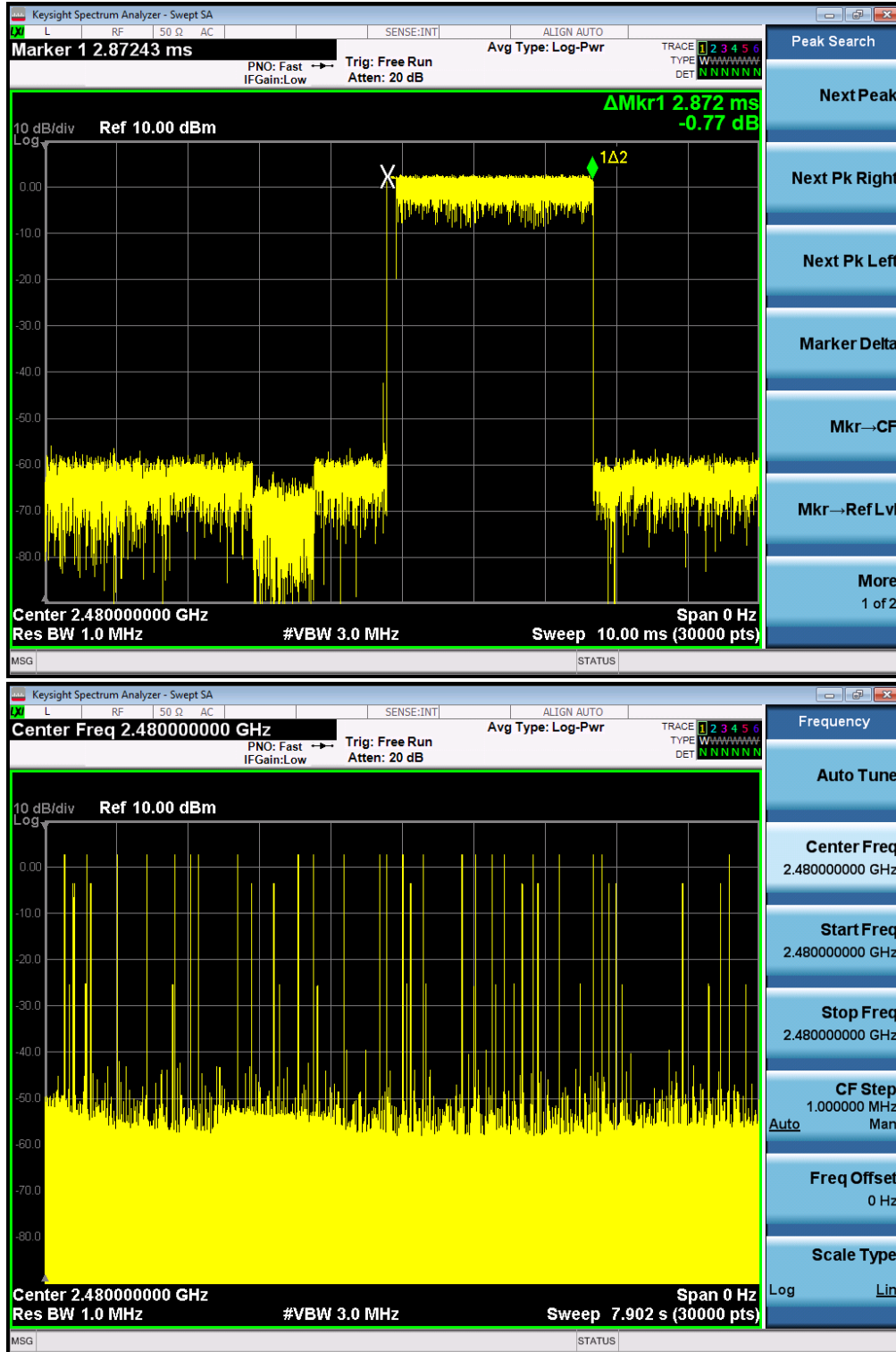



## 10. Frequency Separation

### 10.1. Measurement Procedure

The EUT shall have its hopping function enabled. Use the following spectrum analyzer settings:

1. Span: Wide enough to capture the peaks of two adjacent channels.
2. RBW: Start with the RBW set to approximately 30% of the channel spacing; adjust as necessary to best identify the center of each individual channel.
3. Video (or average) bandwidth (VBW)  $\geq$  RBW.
4. Sweep: Auto. e) Detector function: Peak. f) Trace: Max hold. g) Allow the trace to stabilize.

Use the marker-delta function to determine the separation between the peaks of the adjacent channels.

### 10.2. Test Setup (Block Diagram of Configuration)

Same as described in section 4.2

### 10.3. Limits and Measurement Result

CHANNEL	CHANNEL SEPARATION	LIMIT	RESULT
	KHz	KHz	
CH01-CH02	1000	$\geq 25$ KHz or 2/3 20 dB BW	Pass

TEST PLOT FOR FREQUENCY SEPARATION

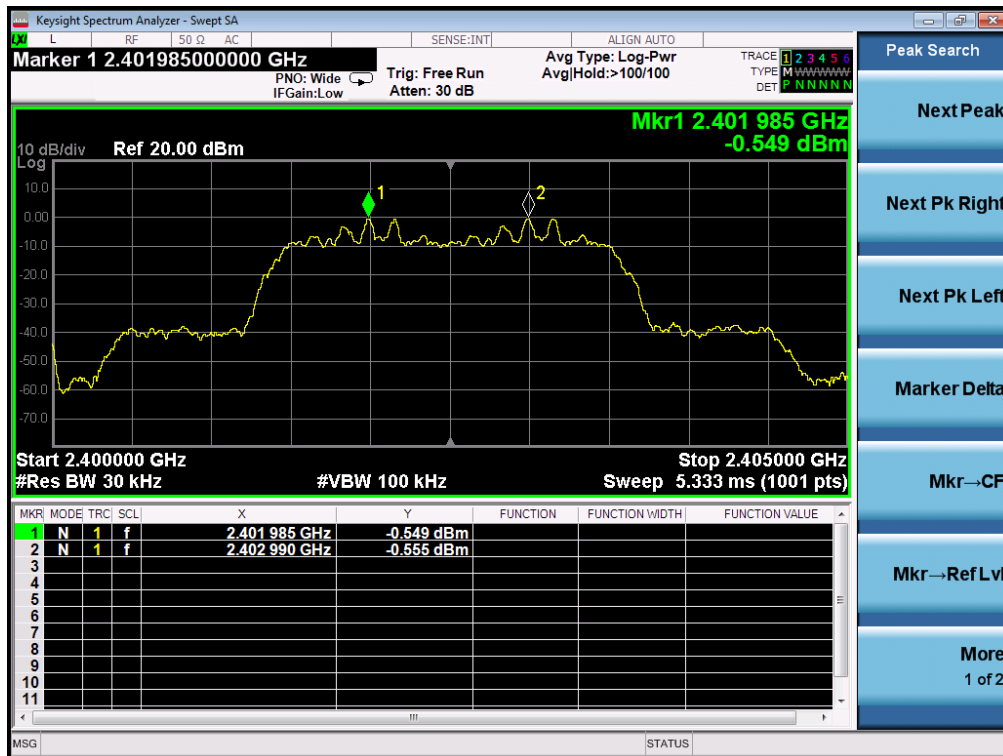

Note: The  $\Pi/4$ -DQPSK modulation is the worst case and recorded in the report.

# 11. Test Setup Photos of the EUT

Radiated Emission



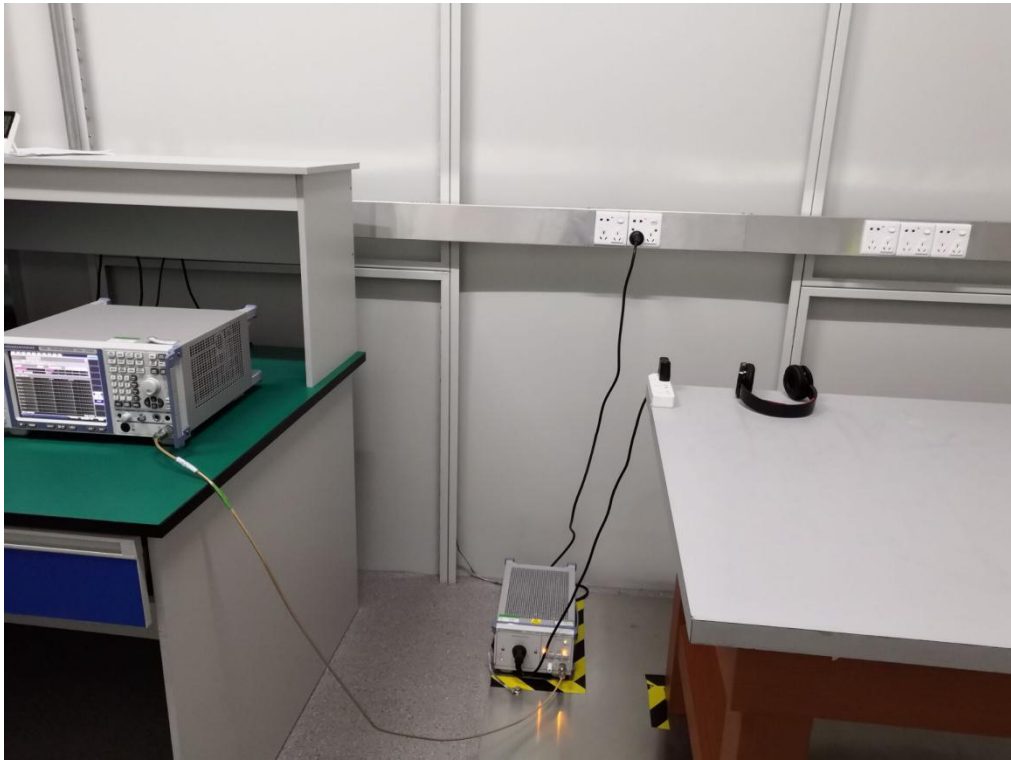

## 12. Photograph of EUT

TOP VIEW OF EUT



BOTTOM VIEW OF EUT





FRONT VIEW OF EUT



BACK VIEW OF EUT





LEFT VIEW OF EUT



RIGHT VIEW OF EUT





OPEN VIEW OF EUT



VIEW OF BATTERY

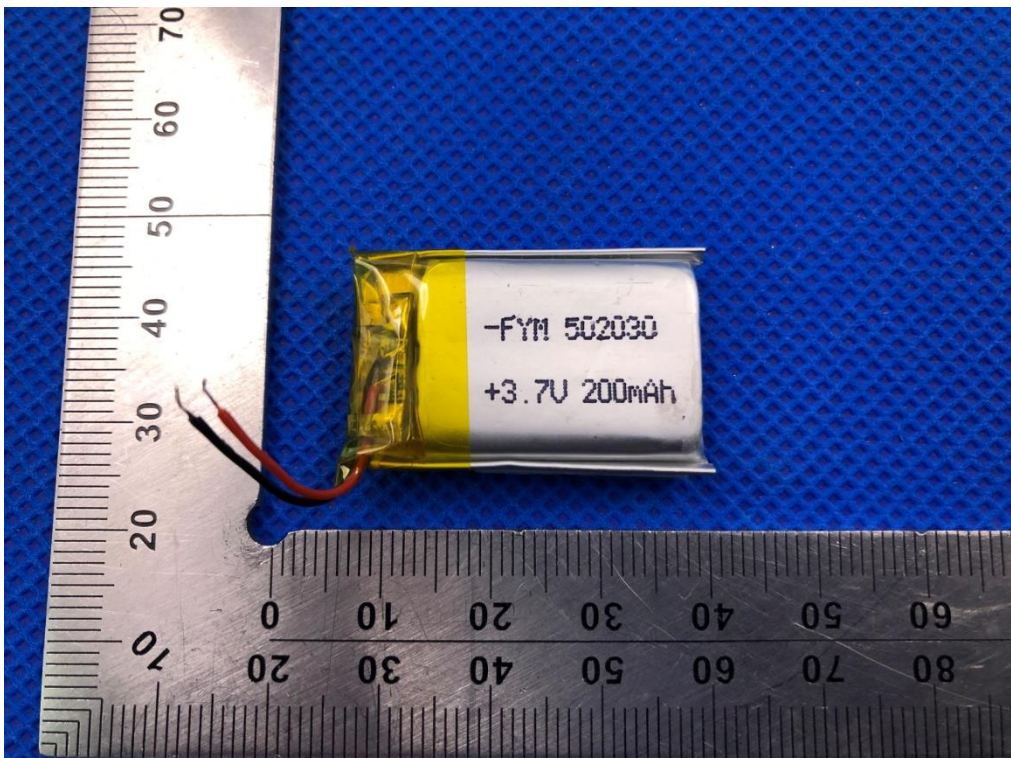



INTERNAL VIEW-1 OF EUT

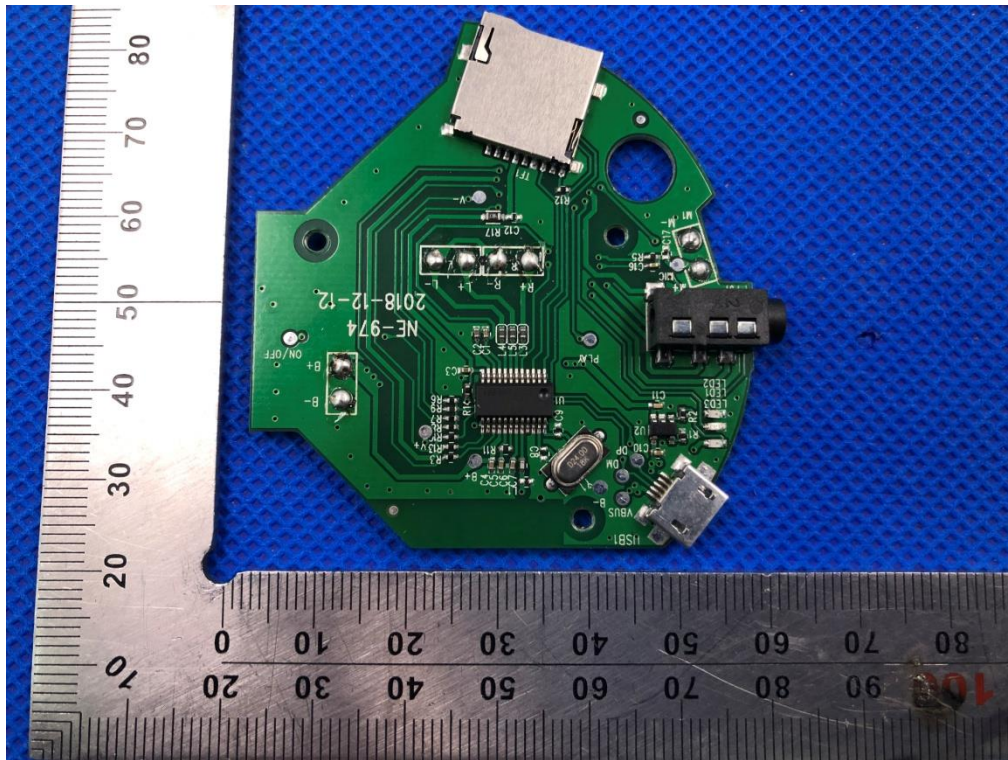

INTERNAL VIEW-2 OF EUT

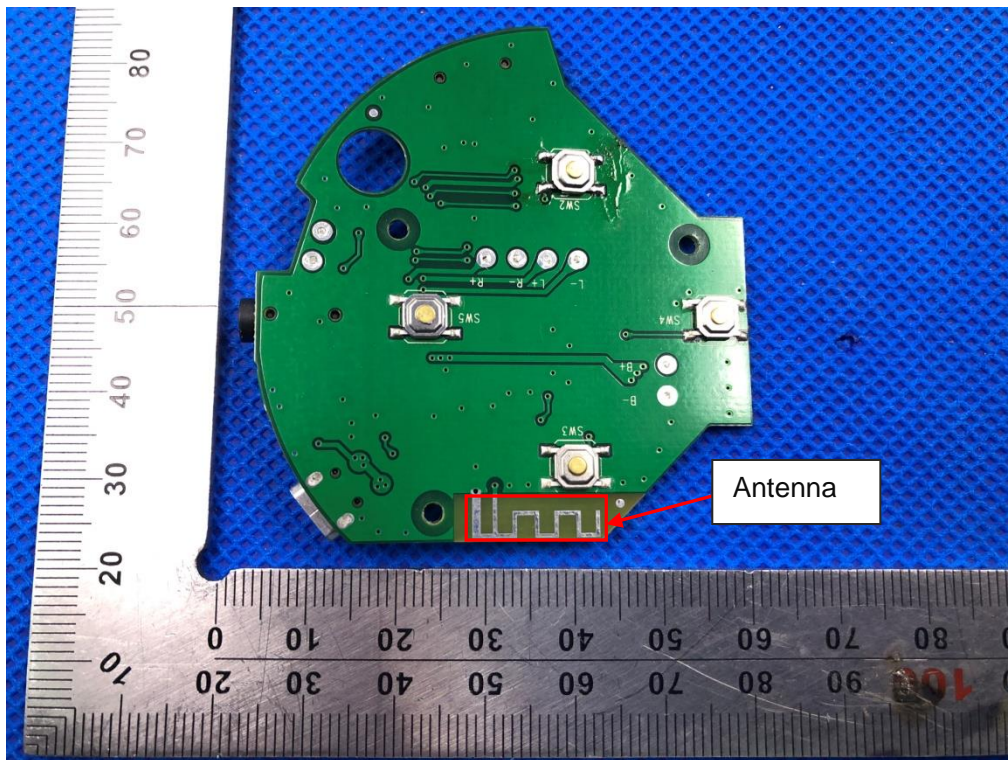

INTERNAL VIEW-3 OF EUT

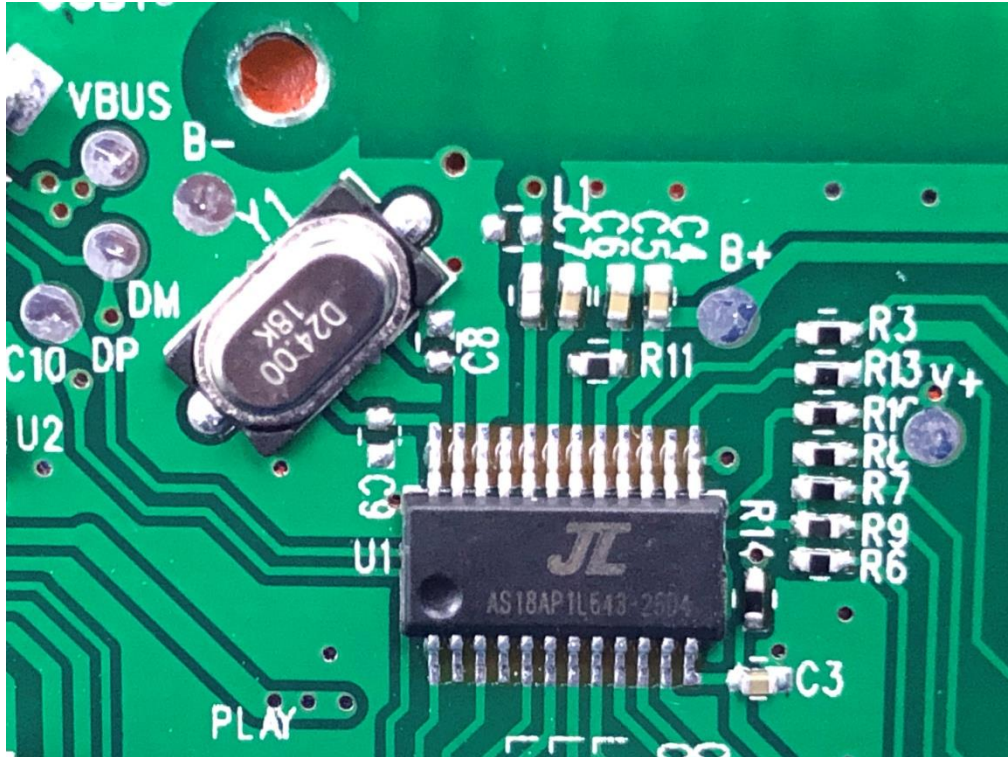

FRONT VIEW OF EUT





BACK VIEW OF EUT



----END OF REPORT----