



Shenzhen CTL Testing Technology Co., Ltd.  
Tel: +86-755-89486194 E-mail: ctl@ctl-lab.com

# TEST REPORT

## FCC PART 15 SUBPART C 15.249

Report Reference No.....: CTL2206162073-WF

Compiled by:  
( position+printed name+signature)

Happy Guo  
(File administrators)

Tested by:  
( position+printed name+signature)

Gary Gao  
(Test Engineer)

Approved by:  
( position+printed name+signature)

Ivan Xie  
(Manager)



Product Name.....: 900MHz Transceiver with USB interface

Model/Type reference.....: KTX900

List Model(s).....: KTX900-USB

Trade Mark.....: KINGLORD

FCC ID.....: 2AOW4-KTX900USB

Applicant's name.....: CM GLOBAL

Address of applicant.....: 1201 N. 4TH STREET, WATERTOWN, WI 53098, USA

Test Firm.....: Shenzhen CTL Testing Technology Co., Ltd.

Address of Test Firm.....: Floor 1-A, Baisha Technology Park, No.3011, Shahehexi Road, Nanshan District, Shenzhen, China 518055

Test specification.....:

Standard.....: FCC Part 15.249:Operation within the bands 902-928 MHz, 2400-2483.5 MHz, 5725-5850 MHz and 24.0 - 24.25 GHz.

TRF Originator.....: Shenzhen CTL Testing Technology Co., Ltd.

Master TRF.....: Dated 2011-01

Date of sampling.....: Jun. 16, 2022

Date of Test Date.....: Jun. 16, 2022 –Jul. 27, 2022

Date of Issue.....: Jul. 27, 2022

Result.....: Pass

Shenzhen CTL Testing Technology Co., Ltd. All rights reserved.

This publication may be reproduced in whole or in part for non-commercial purposes as long as the Shenzhen CTL Testing Technology Co., Ltd. is acknowledged as copyright owner and source of the material. Shenzhen CTL Testing Technology Co., Ltd. takes no responsibility for and will not assume liability for damages resulting from the reader's interpretation of the reproduced material due to its placement and context.

# TEST REPORT

<b>Test Report No. :</b>	<b>CTL2206162073-WF</b>	Jul. 27, 2022 Date of issue
--------------------------	-------------------------	--------------------------------

Equipment under Test : 900MHz Transceiver with USB interface

Sample No. CTL220616207-1-S003

Model /Type : KTX900

Listed Models : KTX900-USB

**Applicant : CM GLOBAL**

Address : 1201 N. 4TH STREET, WATERTOWN, WI 53098, USA

**Manufacturer : KINGLORD ELECTRONICS (HK) LTD**

Address : FLAT 8, 14/F., WAH YIU INDUSTRIAL CENTRE, 30-32 AU  
PUI WAN STREET, FO TAN, N.T., HONG KONG

<b>Test result</b>	<b>Pass *</b>
--------------------	---------------

\* In the configuration tested, the EUT complied with the standards specified page 5.

The test results presented in this report relate only to the object tested.

This report shall not be reproduced, except in full, without the written approval of the issuing testing laboratory.



**Table of Contents**

**Page**

**1. SUMMARY .....5**

1.1. TEST STANDARDS ..... 5

1.2. TEST DESCRIPTION ..... 5

1.3. TEST FACILITY ..... 6

1.4. STATEMENT OF THE MEASUREMENT UNCERTAINTY ..... 6

**2. GENERAL INFORMATION ..... 8**

2.1. ENVIRONMENTAL CONDITIONS ..... 8

2.2. GENERAL DESCRIPTION OF EUT ..... 8

2.3. DESCRIPTION OF TEST MODES AND TEST FREQUENCY ..... 8

2.4. EQUIPMENTS USED DURING THE TEST ..... 8

2.5. RELATED SUBMITTAL(S) / GRANT(S) ..... 9

2.6. MODIFICATIONS ..... 9

**3. TEST CONDITIONS AND RESULTS ..... 10**

3.1. CONDUCTED EMISSIONS TEST ..... 10

3.2. RADIATED EMISSIONS ..... 13

3.3. OCCUPIED BANDWIDTH MEASUREMENT ..... 21

3.4. ANTENNA REQUIREMENT ..... 23

**4. TEST SETUP PHOTOS OF THE EUT ..... 24**

**5. EXTERNAL AND INTERNAL PHOTOS OF THE EUT ..... 25**

# 1. SUMMARY

## 1.1. TEST STANDARDS

The tests were performed according to following standards:

[FCC Rules Part 15.249](#): Operation within the bands 902 - 928 MHz, 2400 - 2483.5 MHz, 5725 - 5875 MHz, and 24.0 -24.25 GHz.

[ANSI C63.10:2013](#): American National Standard for Testing Unlicensed Wireless Devices.

## 1.2. Test Description

FCC PART 15.249		
FCC Part 15.249(a)	Field Strength of Fundamental	PASS
FCC Part 15.209	Spurious Emission	PASS
FCC Part 15.215(c)	20dB bandwidth	PASS
FCC Part 15.207	Conducted Emission	PASS
FCC Part 15.203	Antenna Requirement	PASS

### 1.3. Test Facility

#### 1.3.1 Address of the test laboratory

Shenzhen CTL Testing Technology Co., Ltd.

Floor 1-A, Baisha Technology Park, No. 3011, Shahexi Road, Nanshan, Shenzhen 518055 China

There is one 3m semi-anechoic chamber and two line conducted labs for final test. The Test Sites meet the requirements in documents ANSI C63.10 and CISPR 32/EN 55032 requirements.

#### 1.3.2 Laboratory accreditation

The test facility is recognized, certified, or accredited by the following organizations:

##### **CNAS-Lab Code: L7497**

Shenzhen CTL Testing Technology Co., Ltd. has been assessed and proved to be in compliance with CNAS-CL01 Accreditation Criteria for Testing and Calibration Laboratories (identical to ISO/IEC 17025: 2005 General Requirements) for the Competence of Testing and Calibration Laboratories.

##### **A2LA-Lab Cert. No. 4343.01**

Shenzhen CTL Testing Technology Co., Ltd, EMC Laboratory has been accredited by A2LA for technical competence in the field of electrical testing, and proved to be in compliance with ISO/IEC 17025: 2005 General Requirements for the Competence of Testing and Calibration Laboratories and any additional program requirements in the identified field of testing.

##### **IC Registration No.: 9618B**

##### **CAB identifier: CN0041**

The 3m alternate test site of Shenzhen CTL Testing Technology Co., Ltd. EMC Laboratory has been registered by Innovation, Science and Economic Development Canada to test to Canadian radio equipment requirements with Registration No.: 9618B on Jan. 22, 2019.

##### **FCC-Registration No.: 399832**

##### **Designation No.: CN1216**

Shenzhen CTL Testing Technology Co., Ltd. EMC Laboratory has been registered and fully described in a report filed with the (FCC) Federal Communications Commission. The acceptance letter from the FCC is maintained in our files. Registration 399832, December 08, 2017.

### 1.4. Statement of the measurement uncertainty

The data and results referenced in this document are true and accurate. The reader is cautioned that there may be errors within the calibration limits of the equipment and facilities. The measurement uncertainty was calculated for all measurements listed in this test report acc. to CISPR 16 - 4 "Specification for radio disturbance and immunity measuring apparatus and methods – Part 4: Uncertainty in EMC Measurements" and is documented in the Shenzhen CTL Testing Technology Co., Ltd. quality system acc. to DIN EN ISO/IEC 17025. Furthermore, component and process variability of devices similar to that tested may result in additional deviation. The manufacturer has the sole responsibility of continued compliance of the device.

Hereafter the best measurement capability for CTL laboratory is reported:

Test	Measurement Uncertainty	Notes
Transmitter power conducted	±0.57 dB	(1)
Transmitter power Radiated	±2.20 dB	(1)
Conducted spurious emission 9KHz-40 GHz	±2.20 dB	(1)
Occupied Bandwidth	±0.01ppm	(1)

Radiated Emission 30~1000MHz	$\pm 4.10\text{dB}$	(1)
Radiated Emission Above 1GHz	$\pm 4.32\text{dB}$	(1)
Conducted Disturbance 0.15~30MHz	$\pm 3.20\text{dB}$	(1)

- (1) This uncertainty represents an expanded uncertainty expressed at approximately the 95% confidence level using a coverage factor of  $k=2$ .

## 2. GENERAL INFORMATION

### 2.1. Environmental conditions

During the measurement the environmental conditions were within the listed ranges:

Normal Temperature:	25°C
Relative Humidity:	55 %
Air Pressure:	101 kPa

### 2.2. General Description of EUT

Product Name:	900MHz Transceiver with USB interface
Model/Type reference:	KTX900
Power supply:	DC 5.0V
Hardware version:	01
Software version:	01
<b>SRD:</b>	
Operation frequency:	903.125MHz-910.125MHz
Modulation:	GFSK
Channel number:	8
Channel separation:	1 MHz
Antenna type:	External Antenna
Antenna gain:	3.0dBi

Note1: For more details, please refer to the user's manual of the EUT.

### 2.3. Description of Test Modes and Test Frequency

The Applicant provides communication tools software to control the EUT for staying in continuous transmitting (Duty Cycle more than 98%) and receiving mode for testing.

#### Operation Frequency

Channel	Frequency (MHz)
00	903.125
01	904.125
02	905.125
03	906.125
04	907.125
05	908.125
06	909.125
07	910.125

### 2.4. Equipments Used during the Test

Test Equipment	Manufacturer	Model No.	Serial No.	Calibration Date	Calibration Due Date
LISN	R&S	ENV216	3560.6550.12	2022/05/06	2023/05/05
LISN	R&S	ESH2-Z5	860014/010	2022/05/06	2023/05/05
Double Cone logarithmic antenna	Schwarzbeck	VULB 9168	824	2020/04/07	2023/04/06



Active Loop Antenna	Da Ze	ZN30900A	/	2021/05/13	2024/05/12
Horn Antenna	Sunol Sciences Corp.	DRH-118	A062013	2021/12/23	2024/12/22
Horn Antenna	Ocean Microwave	OBH100400	26999002	2019/11/28	2022/11/27
EMI Test Receiver	R&S	ESCI	1166.5950.03	2022/05/06	2023/05/05
Spectrum Analyzer	Agilent	N9020	US46220290	2022/05/07	2023/05/06
Spectrum Analyzer	RS	FSP	1164.4391.38	2022/05/07	2023/05/06
Controller	EM Electronics	EM 1000	060859	2022/05/20	2023/05/19
Amplifier	Agilent	8449B	3008A02306	2022/05/07	2023/05/06
Amplifier	Agilent	8447D	2944A10176	2022/05/06	2023/05/05
Amplifier	Brief&Smart	LNA-4018	2104197	2022/05/07	2023/05/06
Temperature/Humidity Meter	Ji Yu	MC501	/	2022/05/07	2023/05/06
Power Sensor	Agilent	U2021XA	MY55130004	2022/05/07	2023/05/06
Power Sensor	Agilent	U2021XA	MY55130006	2022/05/07	2023/05/06
Power Sensor	Agilent	U2021XA	MY54510008	2022/05/07	2023/05/06
Power Sensor	Agilent	U2021XA	MY55060003	2022/05/07	2023/05/06
High-Pass Filter	micro-tranics	HPM50108	G174	2022/05/07	2023/05/06
High-Pass Filter	micro-tranics	HPM50111	G142	2022/05/07	2023/05/06
Coaxial Cables	HUBER+SUHNER	SUCOFLEX 104PEA-10M	10m	2022/05/07	2023/05/06
Coaxial Cables	HUBER+SUHNER	SUCOFLEX 104PEA-3M	3m	2022/05/07	2023/05/06
Coaxial Cables	HUBER+SUHNER	SUCOFLEX 104PEA-3M	3m	2022/05/07	2023/05/06
RF Cable	Megalon	RF-A303	N/A	2022/05/07	2023/05/06
RF Control Unit	Tonsecnd	JS0806-2	20J8060323	2022/05/07	2023/05/06
Test Software	Tonsecnd	JS1120-3	2.6.880341	N/A	N/A
Test software	EZ	EZ_EMCC	1.1.4.2	N/A	N/A

The calibration interval was one year

## 2.5. Related Submittal(s) / Grant(s)

This submittal(s) (test report) is intended to comply with Section 15.249 of the FCC Part 15, Subpart C Rules.

## 2.6. Modifications

No modifications were implemented to meet testing criteria.

### 3. TEST CONDITIONS AND RESULTS

#### 3.1. Conducted Emissions Test

##### LIMIT

FCC CFR Title 47 Part 15 Subpart C Section 15.207

Frequency range (MHz)	Limit (dBuV)	
	Quasi-peak	Average
0.15-0.5	66 to 56*	56 to 46*
0.5-5	56	46
5-30	60	50

\* Decreases with the logarithm of the frequency.

##### TEST CONFIGURATION

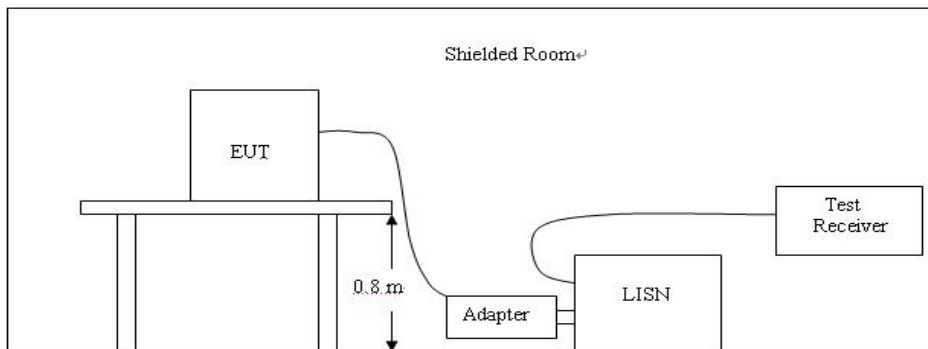

##### TEST PROCEDURE

1. The equipment was set up as per the test configuration to simulate typical actual usage per the user's manual. The EUT is a tabletop system; a wooden table with a height of 0.8 meters is used and is placed on the ground plane as per ANSI C63.10:2013.
2. Support equipment, if needed, was placed as per ANSI C63.10:2013.
3. All I/O cables were positioned to simulate typical actual usage as per ANSI C63.10:2013.
4. If a EUT received DC power from the USB Port of Notebook PC, the PC's adapter received AC120V/60Hz power through a Line Impedance Stabilization Network (LISN) which supplied power source and was grounded to the ground plane.
5. All support equipments received AC power from a second LISN, if any.
6. The EUT test program was started. Emissions were measured on each current carrying line of the EUT using a spectrum Analyzer / Receiver connected to the LISN powering the EUT. The LISN has two monitoring points: Line 1 (Hot Side) and Line 2 (Neutral Side). Two scans were taken: one with Line 1 connected to Analyzer / Receiver and Line 2 connected to a 50 ohm load; the second scan had Line 1 connected to a 50 ohm load and Line 2 connected to the Analyzer / Receiver.
7. Analyzer / Receiver scanned from 150 KHz to 30MHz for emissions in each of the test modes.
8. During the above scans, the emissions were maximized by cable manipulation.

**TEST RESULTS**

Line:	L
-------	---

**SCAN TABLE: "Voltage (9K-30M) FIN"**  
 Short Description: 150K-30M Voltage

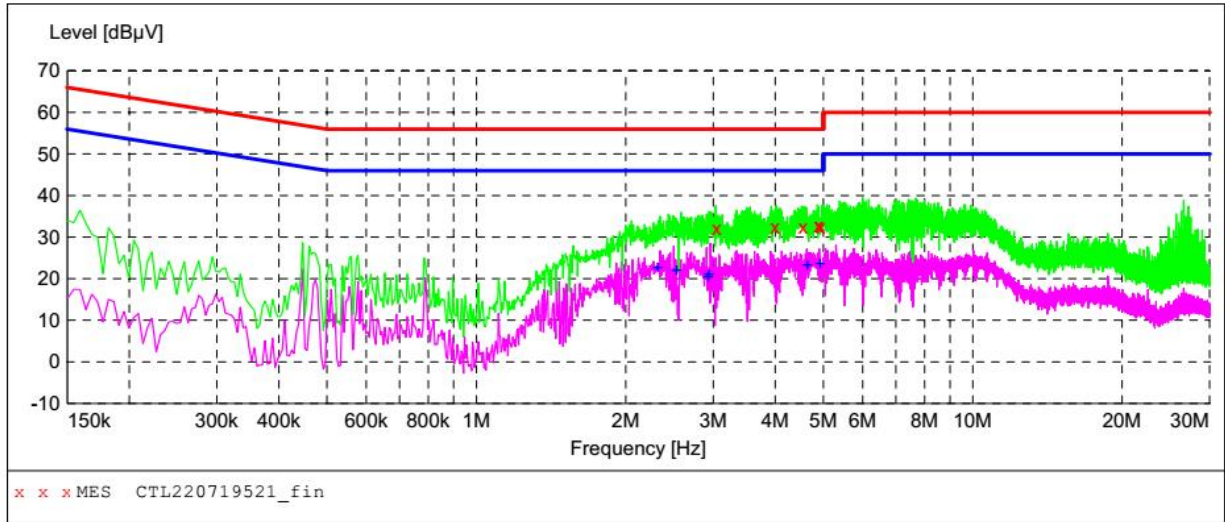

**MEASUREMENT RESULT: "CTL220719521\_fin"**

7/19/2022 9:04AM

Frequency MHz	Level dBµV	Transd dB	Limit dBµV	Margin dB	Detector	Line	PE
3.048000	32.20	10.3	56	23.8	QP	L1	GND
3.997500	32.50	10.3	56	23.5	QP	L1	GND
4.555500	32.50	10.3	56	23.5	QP	L1	GND
4.888500	32.60	10.4	56	23.4	QP	L1	GND
4.906500	32.80	10.4	56	23.2	QP	L1	GND
4.938000	32.50	10.4	56	23.5	QP	L1	GND

**MEASUREMENT RESULT: "CTL220719521\_fin2"**

7/19/2022 9:04AM

Frequency MHz	Level dBµV	Transd dB	Limit dBµV	Margin dB	Detector	Line	PE
2.319000	22.70	10.3	46	23.3	AV	L1	GND
2.530500	21.90	10.3	46	24.1	AV	L1	GND
2.931000	20.50	10.3	46	25.5	AV	L1	GND
2.944500	21.00	10.3	46	25.0	AV	L1	GND
4.645500	23.10	10.3	46	22.9	AV	L1	GND
4.933500	23.40	10.4	46	22.6	AV	L1	GND

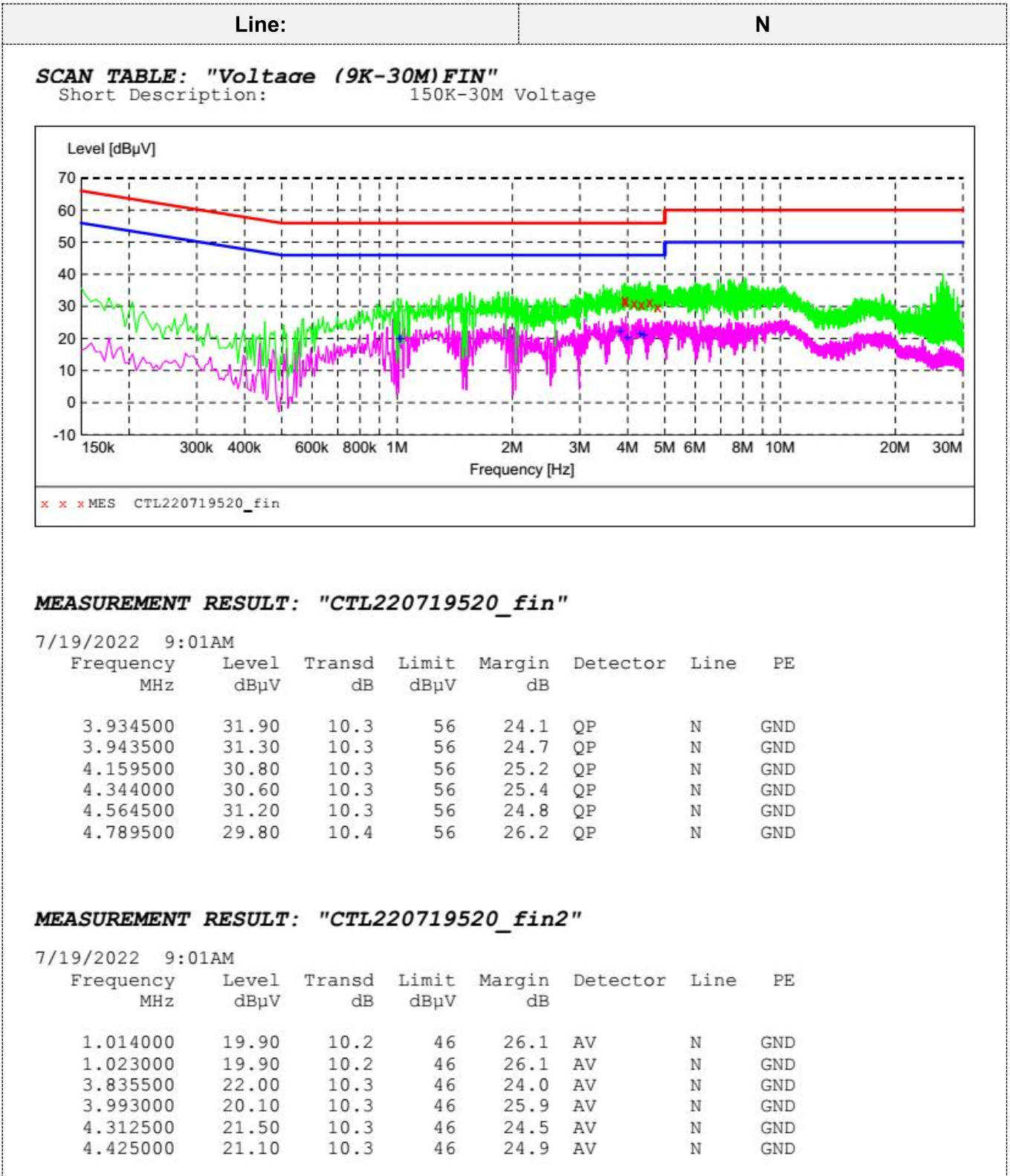

Remark: Level(dBuV)=Reading(dBuV) + Factor(dB)  
 Margin=Limit(dBuV/m)-Level(dBuV/m)

## 3.2. Radiated Emissions

### Limit

According 15.249, the field strength of emissions from intentional radiators operated within 5725-5875 MHz shall not exceed 94dB $\mu$ V/m (50mV/m):

FCC PART 15.249(d) Emissions radiated outside of the specified frequency bands, except for harmonics, shall be attenuated by at least 50 dB below the level of the fundamental or to the general radiated emission limits in §15.209, whichever is the lesser attenuation.

In addition, radiated emissions which fall in the restricted bands, as defined in §15.205(a), must also comply with the radiated emission limits specified in §15.209(a)

Radiated emission limits

Frequency (MHz)	Distance (Meters)	Radiated (dB $\mu$ V/m)	Radiated ( $\mu$ V/m)
0.009-0.49	3	$20\log(2400/F(\text{KHz}))+40\log(300/3)$	$2400/F(\text{KHz})$
0.49-1.705	3	$20\log(24000/F(\text{KHz}))+40\log(30/3)$	$24000/F(\text{KHz})$
1.705-30	3	$20\log(30)+40\log(30/3)$	30
30-88	3	40.0	100
88-216	3	43.5	150
216-960	3	46.0	200
Above 960	3	54.0	500

### TEST CONFIGURATION

(A) Radiated Emission Test Set-Up, Frequency Below 30MHz

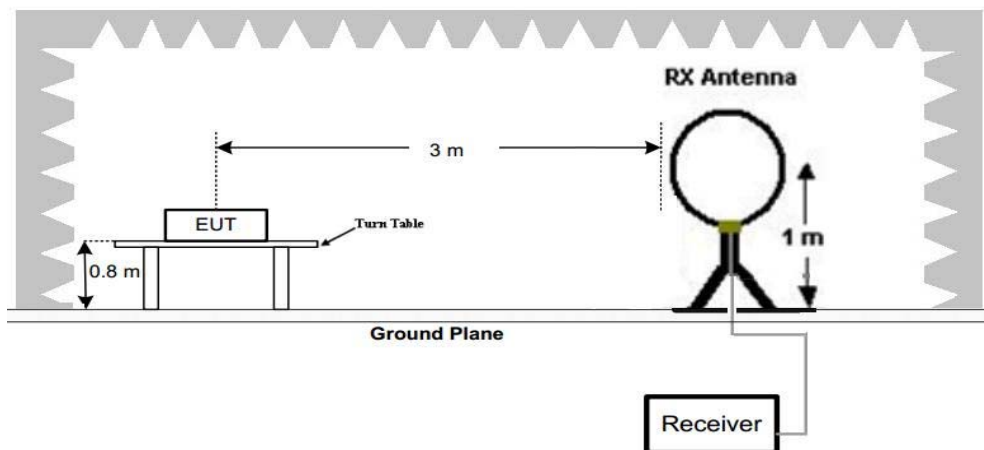

(B) Radiated Emission Test Set-Up, Frequency below 1000MHz

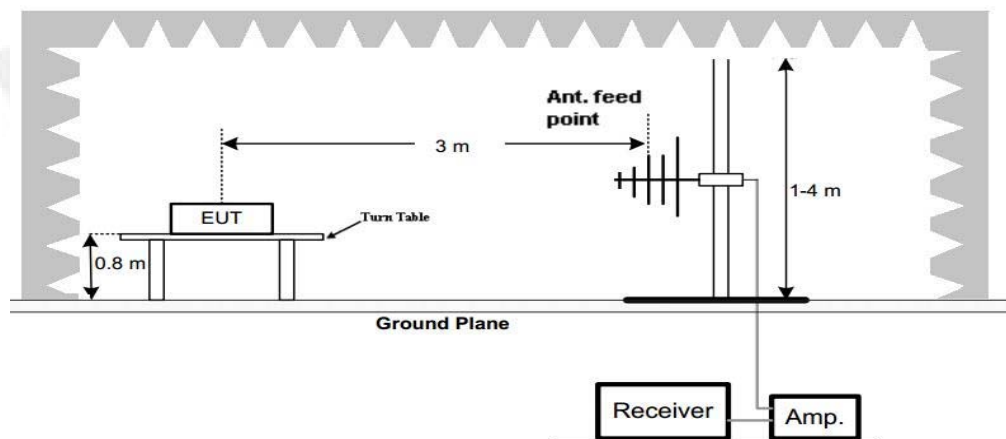

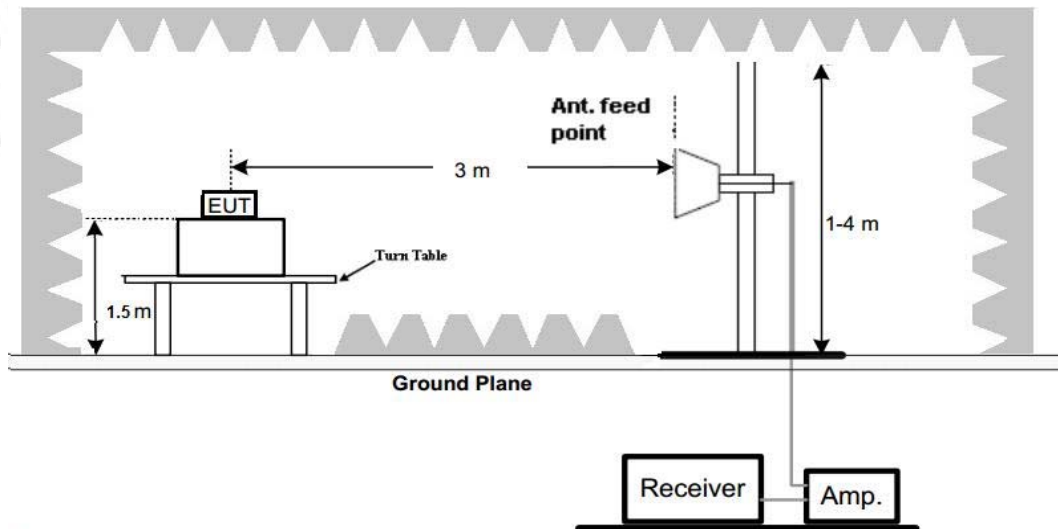

## (C) Radiated Emission Test Set-Up, Frequency above 1000MHz

**Test Procedure**

1. Below 1GHz measurement the EUT is placed on a turntable which is 0.8m above ground plane, and above 1GHz measurement EUT was placed on a low permittivity and low loss tangent turn table which is 1.5m above ground plane.
2. Maximum procedure was performed by raising the receiving antenna from 1m to 4m and rotating the turn table from 0°C to 360°C to acquire the highest emissions from EUT
3. And also, each emission was to be maximized by changing the polarization of receiving antenna both horizontal and vertical.
4. Repeat above procedures until all frequency measurements have been completed.
5. Radiated emission test frequency band from 9KHz to 10GHz.
6. The distance between test antenna and EUT as following table states:

Test Frequency range	Test Antenna Type	Test Distance
9KHz-30MHz	Active Loop Antenna	3
30MHz-1GHz	Bilog Antenna	3
1GHz-18GHz	Horn Antenna	3
18GHz-40GHz	Horn Antenna	1

7. Setting test receiver/spectrum as following table states:

Test Frequency range	Test Receiver/Spectrum Setting	Detector
9KHz-150KHz	RBW=200Hz/VBW=3KHz, Sweep time=Auto	QP
150KHz-30MHz	RBW=9KHz/VBW=100KHz, Sweep time=Auto	QP
30MHz-1GHz	RBW=120KHz/VBW=1000KHz, Sweep time=Auto	QP
1GHz-40GHz	Peak Value: RBW=1MHz/VBW=3MHz, Sweep time=Auto Average Value: RBW=1MHz/VBW=10Hz, Sweep time=Auto	Peak

**TEST RESULTS****Field Strength of Fundamental:**

Remark: This test was performed with EUT in X, Y, Z position and the worst case was found when EUT in X position.

Frequency (MHz)	Emission Level (dBuV/m)		Limit (dBuV/m)	Margin (dB)	Reading (dBuV)	Factor (dB/m)	Polarization
903.125	94.15	PK	114.00	19.85	97.75	-3.60	Horizontal
	81.62	AV	94.00	12.38	85.22	-3.60	Horizontal
	101.26	PK	114.00	12.74	104.86	-3.60	Vertical
	89.17	AV	94.00	4.83	92.77	-3.60	Vertical
907.125	96.75	PK	114.00	17.25	100.12	-3.37	Horizontal
	83.62	AV	94.00	10.38	86.99	-3.37	Horizontal
	101.28	PK	114.00	12.72	104.65	-3.37	Vertical
	88.46	AV	94.00	5.54	91.83	-3.37	Vertical
910.125	97.48	PK	114.00	16.52	100.67	-3.19	Horizontal
	87.46	AV	94.00	6.54	90.65	-3.19	Horizontal
	103.61	PK	114.00	10.39	106.8	-3.19	Vertical
	88.11	AV	94.00	5.89	91.3	-3.19	Vertical

**REMARKS:**

1. Emission level (dBuV/m) = Reading (dBuV)+ Factor (dB/m)
2. Factor (dB/m) = Antenna Factor (dB/m)+Cable Factor (dB)-Pre-amplifier Factor
3. Margin value = Limit value- Emission level.

**Emissions radiated outside of the specified frequency bands:**

Remark:

1. This test was performed with EUT in X, Y, Z position and the worst case was found when EUT in Z position.
2. For below 1GHz testing recorded worst at low channel.
3. Radiated emission test from 9 KHz to 10th harmonic of fundamental was verified, and the emission levels from 9kHz to 30MHz are attenuated 20dB below the limit and not recorded in report.

**For 30MHz-1GHz**

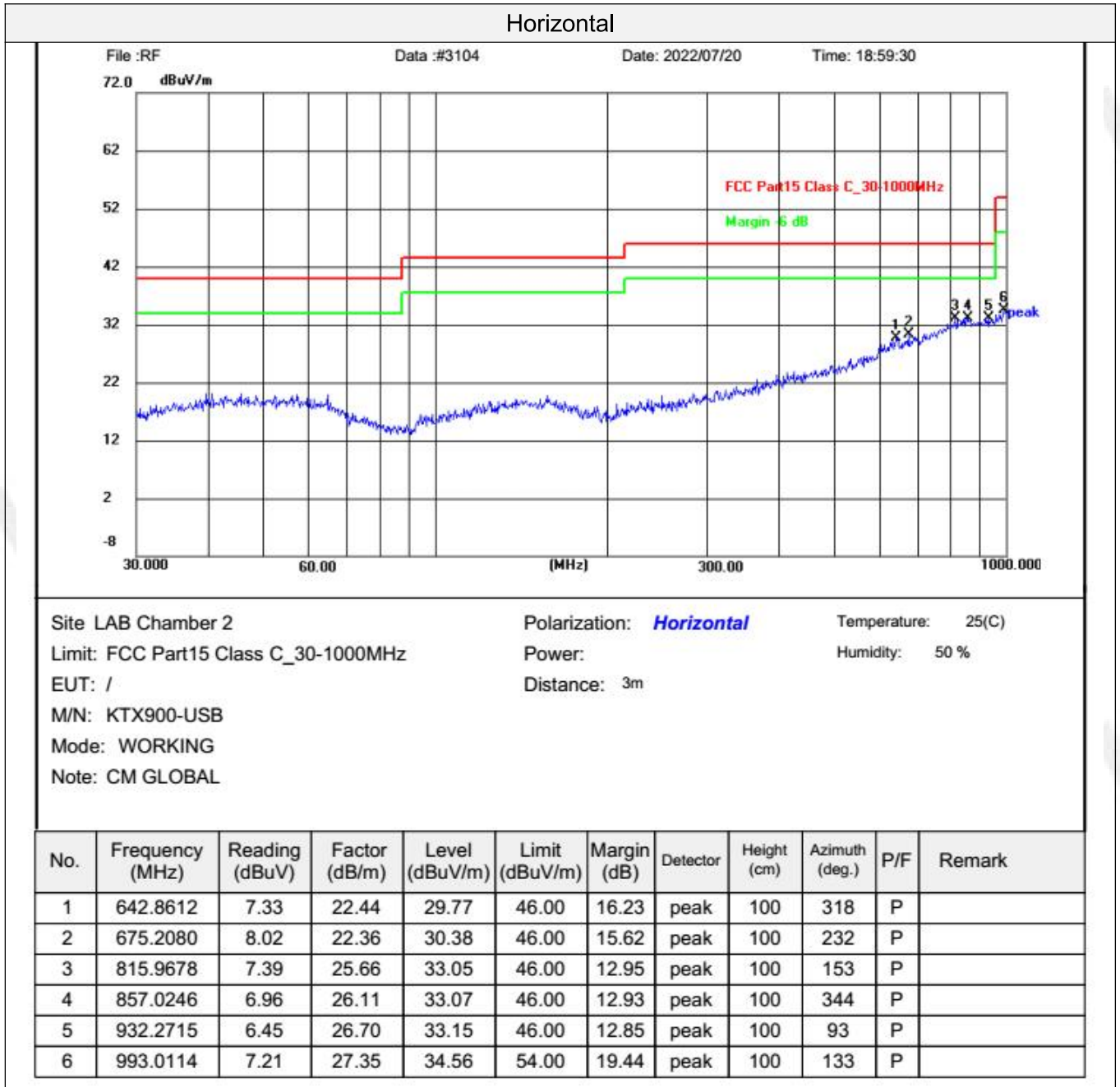



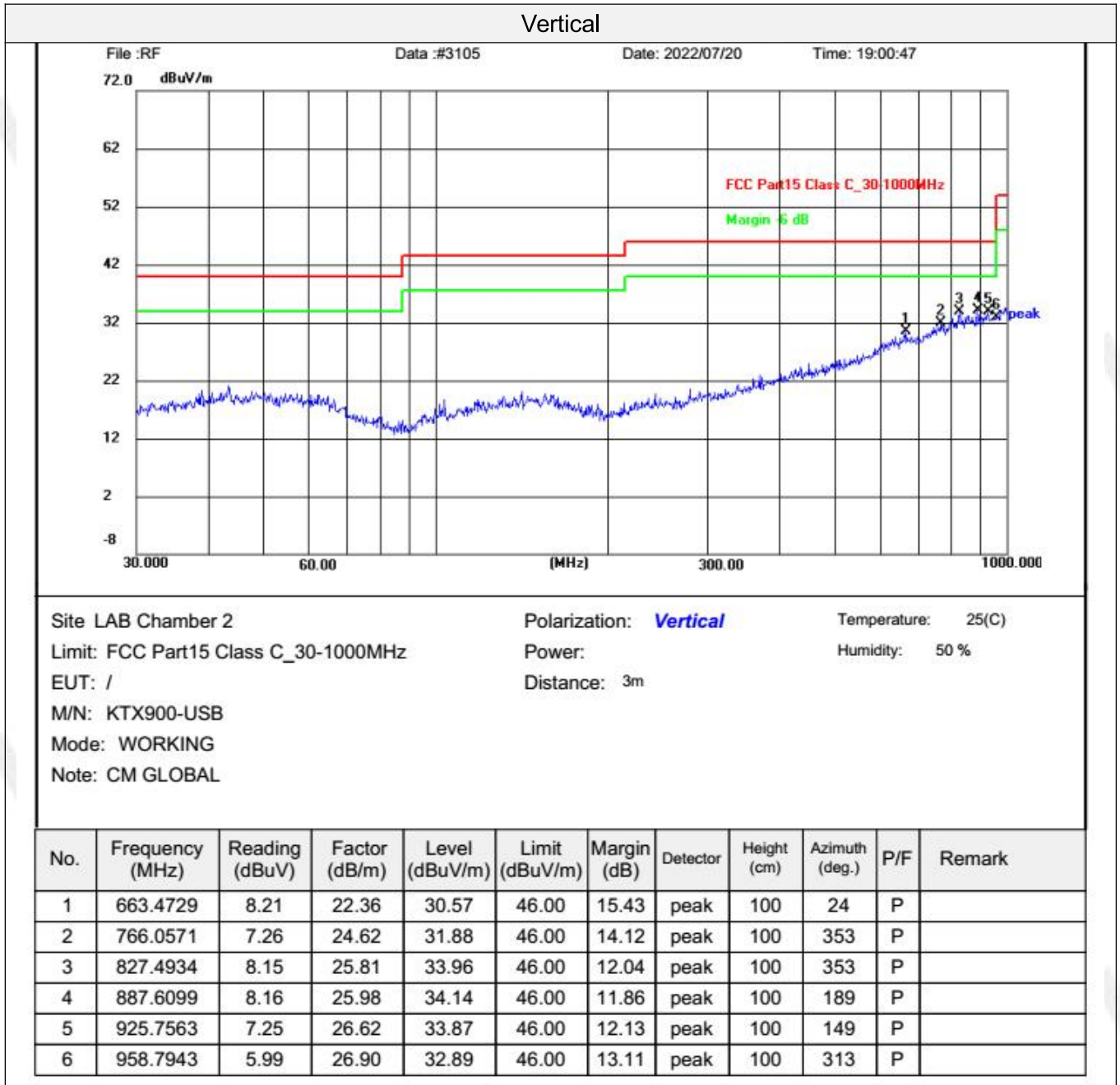

Remark: Level(dBuV/m)=Reading(dBuV)+Factor(dB/m)

Margin= Level(dBuV/m)-Limit(dBuV/m)

**For 1GHz to 10GHz**

Frequency (MHz):		903.125			Polarity:	HORIZONTAL	
No.	Frequency (MHz)	Emission Level (dBuV/m)		Limit (dBuV/m)	Margin (dB)	Reading (dBuV)	Factor (dB/m)
1	1806.25	51.42	PK	74	22.58	76.50	-25.08
1	--	--	AV	54	--	--	--
2	2709.38	53.46	PK	74	20.54	73.11	-19.65
2	--	--	AV	54	--	--	--
3	3612.50	54.75	PK	74	19.25	72.26	-17.51
3	--	--	AV	54	--	--	--

Frequency (MHz):		903.125			Polarity:	Vertical	
No.	Frequency (MHz)	Emission Level (dBuV/m)		Limit (dBuV/m)	Margin (dB)	Reading (dBuV)	Factor (dB/m)
1	1806.25	52.06	PK	74	21.94	77.14	-25.08
1	--	--	AV	54	--	--	--
2	2709.38	52.77	PK	74	21.23	72.42	-19.65
2	--	--	AV	54	--	--	--
3	3612.50	54.68	PK	74	19.32	72.19	-17.51
3	--	--	AV	54	--	--	--

**REMARKS:**

1. Emission level (dBuV/m) = Reading (dBuV)+ Factor (dB/m)
2. Factor (dB/m) = Antenna Factor (dB/m)+Cable Factor (dB)-Pre-amplifier Factor
3. Margin value = Limit value- Emission level.
4. -- Mean the PK detector measured value is below average limit.
5. The other emission levels lower -6dB than the limit was not reported.
6. RBW1MHz VBW3MHz Peak detector is for PK value; RBW 1MHz VBW10Hz Peak detector is for AV value.

Frequency (MHz):		907.125			Polarity:	HORIZONTAL	
No.	Frequency (MHz)	Emission Level (dBuV/m)		Limit (dBuV/m)	Margin (dB)	Reading (dBuV)	Factor (dB/m)
1	1814.25	48.67	PK	74	25.33	73.75	-25.08
1	--	--	AV	54	--	--	--
2	2721.38	51.84	PK	74	22.16	71.49	-19.65
2	--	--	AV	54	--	--	--
3	3628.50	53.77	PK	74	20.23	71.28	-17.51
3	--	--	AV	54	--	--	--

Frequency (MHz):		907.125			Polarity:	Vertical	
No.	Frequency (MHz)	Emission Level (dBuV/m)		Limit (dBuV/m)	Margin (dB)	Reading (dBuV)	Factor (dB/m)
1	1814.25	48.62	PK	74	25.38	73.70	-25.08
1	--	--	AV	54	--	--	--
2	2721.38	52.44	PK	74	21.56	72.09	-19.65
2	--	--	AV	54	--	--	--
3	3628.50	54.28	PK	74	19.72	71.79	-17.51
3	--	--	AV	54	--	--	--

## REMARKS:

1. Emission level (dBuV/m) = Reading (dBuV)+ Factor (dB/m)
2. Factor (dB/m) = Antenna Factor (dB/m)+Cable Factor (dB)-Pre-amplifier Factor
3. Margin value = Limit value- Emission level.
4. -- Mean the PK detector measured value is below average limit.
5. The other emission levels lower -6dB than the limit was not reported.
6. RBW1MHz VBW3MHz Peak detector is for PK value; RBW 1MHz VBW10Hz Peak detector is for AV value.

Frequency (MHz):		910.125			Polarity:	HORIZONTAL	
No.	Frequency (MHz)	Emission Level (dBuV/m)		Limit (dBuV/m)	Margin (dB)	Reading (dBuV)	Factor (dB/m)
1	1820.25	51.62	PK	74	22.38	76.38	-24.76
1	--	--	AV	54	--	--	--
2	2730.38	53.45	PK	74	20.55	72.93	-19.48
2	--	--	AV	54	--	--	--
3	3640.50	54.79	PK	74	19.21	69.57	-14.78
3	--	--	AV	54	--	--	--

Frequency (MHz):		910.125			Polarity:	Vertical	
No.	Frequency (MHz)	Emission Level (dBuV/m)		Limit (dBuV/m)	Margin (dB)	Reading (dBuV)	Factor (dB/m)
1	1820.25	50.48	PK	74	23.52	75.24	-24.76
1	--	--	AV	54	--	--	--
2	2730.38	52.76	PK	74	21.24	72.24	-19.48
2	--	--	AV	54	--	--	--
3	3640.50	55.17	PK	74	18.83	69.95	-14.78
3	--	--	AV	54	--	--	--

## REMARKS:

1. Emission level (dBuV/m) = Reading (dBuV)+ Factor (dB/m)
2. Factor (dB/m) = Antenna Factor (dB/m)+Cable Factor (dB)-Pre-amplifier Factor
3. Margin value = Limit value- Emission level.
4. -- Mean the PK detector measured value is below average limit.
5. The other emission levels lower -6dB than the limit was not reported.
6. RBW1MHz VBW3MHz Peak detector is for PK value; RBW 1MHz VBW10Hz Peak detector is for AV value.

### 3.3. Occupied Bandwidth Measurement

#### Limit

N/A

#### Test Configuration

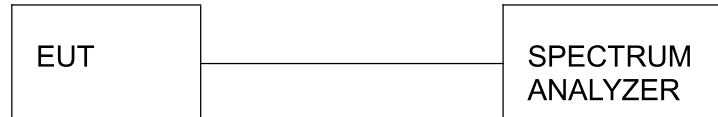

#### Test Procedure

The transmitter output was connected to the spectrum analyzer through an attenuator. The bandwidth of the fundamental frequency was measured by spectrum analyzer with 10KHz RBW and 30KHz VBW. The 20dB bandwidth is defined as the total spectrum the power of which is higher than peak power minus 20dB.

#### Test Results

Modulation	Test Frequency (MHz)	99% OBW (MHz)	20dB bandwidth (MHz)	Result
GFSK	903.125	504.68	516.10	Pass
	907.125	510.80	519.50	
	910.125	502.66	510.20	

Test plot as follows:

GFSK Modulation



903.125MHz



907.125MHz



910.125MHz

### 3.4. Antenna Requirement

#### **Standard Applicable**

For intentional device, according to FCC 47 CFR Section 15.203, an intentional radiator shall be designed to ensure that no antenna other than that furnished by the responsible party shall be used with the device.

#### **Refer to statement below for compliance.**

The manufacturer may design the unit so that the user can replace a broken antenna, but the use of a standard antenna jack or electrical connector is prohibited. Further, this requirement does not apply to intentional radiators that must be professionally installed.

#### **Antenna Connected Construction**

The antenna used in this product is an integral antenna, The directional gains of antenna used for transmitting is 3.0dBi.

### 4. Test Setup Photos of the EUT





# 5. External and Internal Photos of the EUT

## External Photos of EUT







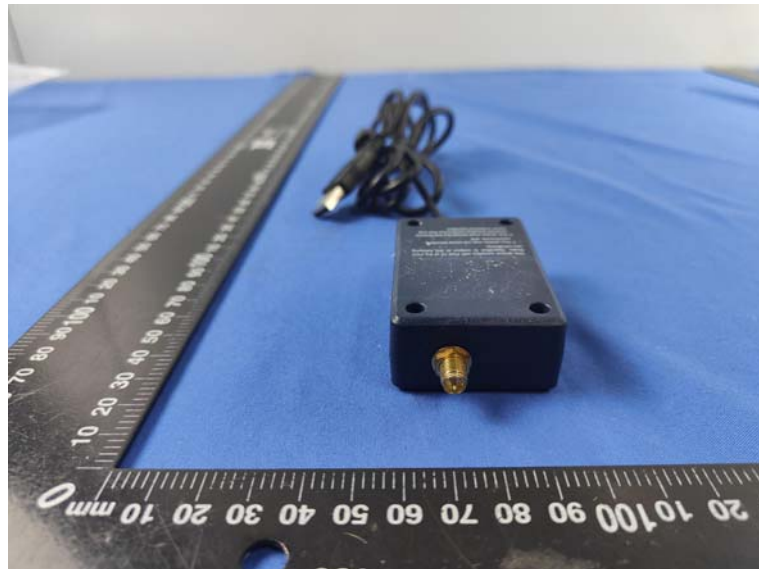

**Internal Photos of EUT**

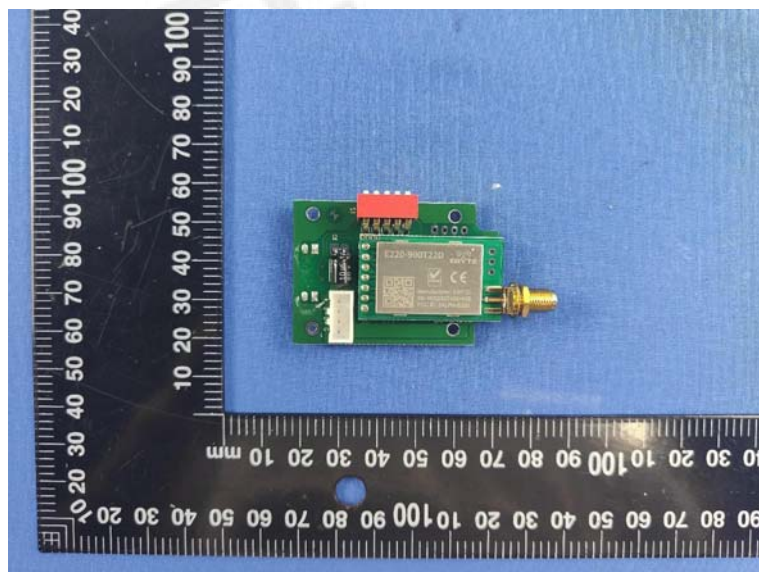

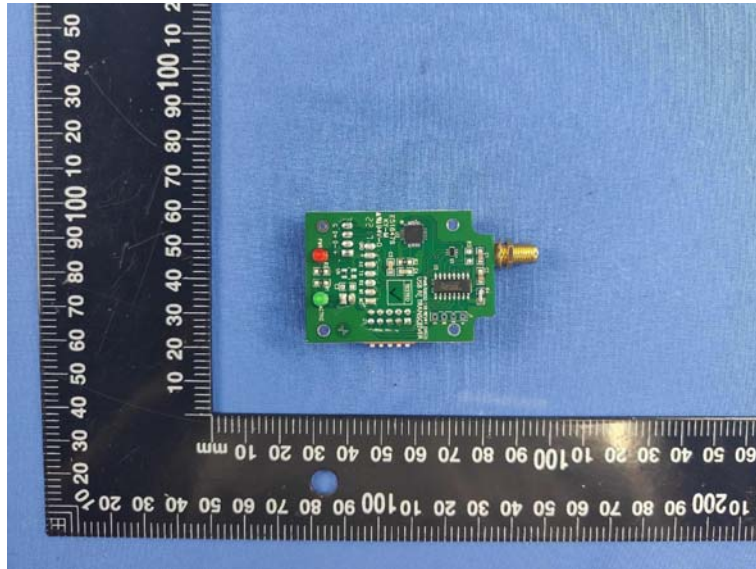
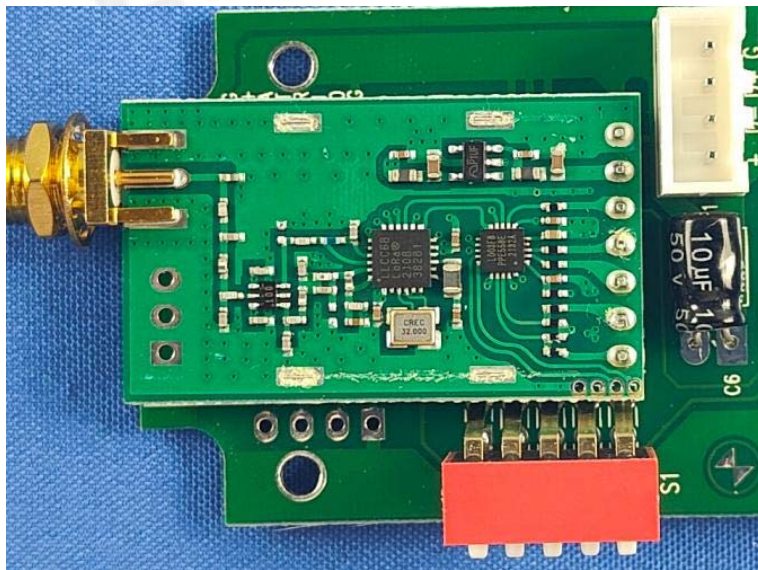
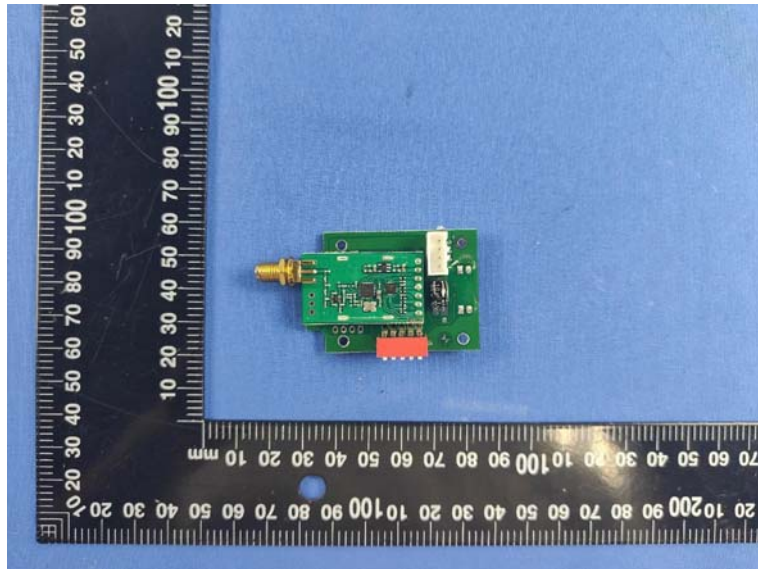

\*\*\*\*\* End of Report \*\*\*\*\*