

# TEST REPORT

**Applicant:** Shenzhen SEI Robotics Co., Ltd.  
**Address:** 4th Floor, Productivity Building D, #5 Hi-Tech Middle 2nd Road, Shenzhen Hi-Tech Industrial Park, Nanshan District, Shenzhen, China  
**Equipment Type:** Pocket TV  
**Model Name:** SEI700GHM (refer to section 2.3)  
**Brand Name:** SEI  
**FCC ID:** 2AOVU-SEI700GHM  
**Test Standard:** 47 CFR Part 15 Subpart C (refer to section 3.1)  
**Sample Arrival Date:** Jan. 08, 2024  
**Test Date:** Jan. 16, 2024 - Jan. 26, 2024  
**Date of Issue:** Mar. 26, 2024

**ISSUED BY:**

Shenzhen BALUN Technology Co., Ltd.

**Tested by:** Julie Zhu

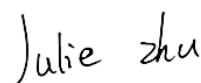

**Checked by:** Ye Hongji



**Approved by:** Liao Jianming  
(Technical Director)



<b>Revision History</b>		
Version	Issue Date	Revisions
<u>Rev. 01</u>	<u>Mar. 26, 2024</u>	<u>Initial Issue</u>

## TABLE OF CONTENTS

1	GENERAL INFORMATION.....	4
1.1	Test Laboratory .....	4
1.2	Test Location .....	4
2	PRODUCT INFORMATION .....	5
2.1	Applicant Information .....	5
2.2	Manufacturer Information.....	5
2.3	General Description for Equipment under Test (EUT).....	5
2.4	Technical Information .....	6
3	SUMMARY OF TEST RESULTS .....	9
3.1	Test Standards .....	9
3.2	Test Verdict .....	9
4	GENERAL TEST CONFIGURATIONS .....	10
4.1	Test Environments.....	10
4.2	Test Equipment List.....	10
4.3	Test Software List.....	10
4.4	Measurement Uncertainty.....	11
4.5	Description of Test Setup .....	11
4.6	Measurement Results Explanation Example.....	14
5	TEST ITEMS .....	15
5.1	Antenna Requirements .....	15
5.2	Output Power .....	16
5.3	Occupied Bandwidth.....	18
5.4	Conducted Spurious Emission.....	19
5.5	Band Edge (Authorized-band band-edge).....	21

5.6	Conducted Emission.....	23
5.7	Radiated Spurious Emission.....	24
5.8	Band Edge (Restricted-band band-edge).....	29
5.9	Power Spectral density (PSD) .....	30
ANNEX A	TEST RESULT .....	31
A.1	Output Power .....	31
A.2	Occupied Bandwidth.....	51
A.3	Conducted Spurious Emissions .....	61
A.4	Band Edge (Authorized-band band-edge).....	97
A.5	Conducted Emissions .....	113
A.6	Radiated Emission.....	115
A.7	Band Edge (Restricted-band band-edge).....	159
A.8	Power Spectral Density (PSD).....	189
ANNEX B	TEST SETUP PHOTOS .....	215
ANNEX C	EUT EXTERNAL PHOTOS.....	215
ANNEX D	EUT INTERNAL PHOTOS.....	215

# 1 GENERAL INFORMATION

## 1.1 Test Laboratory

Name	Shenzhen BALUN Technology Co., Ltd.
Address	Block B, 1/F, Baisha Science and Technology Park, Shahe Xi Road, Nanshan District, Shenzhen, Guangdong Province, P. R. China
Phone Number	+86 755 6685 0100

## 1.2 Test Location

Name	Shenzhen BALUN Technology Co., Ltd.
Location	<input checked="" type="checkbox"/> Block B, 1/F, Baisha Science and Technology Park, Shahe Xi Road, Nanshan District, Shenzhen, Guangdong Province, P. R. China
	<input type="checkbox"/> 1/F, Building B, Ganghongji High-tech Intelligent Industrial Park, No. 1008, Songbai Road, Yangguang Community, Xili Sub-district, Nanshan District, Shenzhen, Guangdong Province, P. R. China
Accreditation Certificate	The laboratory is a testing organization accredited by FCC as a accredited testing laboratory. The designation number is CN1196.

## 2 PRODUCT INFORMATION

### 2.1 Applicant Information

Applicant	Shenzhen SEI Robotics Co., Ltd.
Address	4th Floor, Productivity Building D, #5 Hi-Tech Middle 2nd Road, Shenzhen Hi-Tech Industrial Park, Nanshan District, Shenzhen, China

### 2.2 Manufacturer Information

Manufacturer	N/A
Address	N/A

### 2.3 General Description for Equipment under Test (EUT)

EUT Name	Pocket TV
Model Name Under Test	SEI700GHM
Series Model Name	SN9BKAF, SN9BKAx(x=A-Z)
Description of Model name differentiation	All models are same with electrical parameters and internal circuit structure, but only differ in appearance color. (this information provided by the applicant)
Hardware Version	SMB.403.06
Software Version	N/A
Dimensions (Approx.)	N/A
Weight (Approx.)	N/A

## 2.4 Technical Information

Network and Wireless connectivity	Bluetooth (BR+EDR+BLE) WIFI 802.11a, 802.11b, 802.11g, 802.11n, 802.11ac and 802.11ax U-NII-1/3
-----------------------------------	---

The requirement for the following technical information of the EUT was tested in this report:

Frequency Range	802.11b/g/n/ax(20 MHz): 2.412 GHz - 2.462 GHz $f_c = 2412 \text{ MHz} + (N-1)*5 \text{ MHz}$ , where - $f_c$ = "Operating Frequency" in MHz, - N = "Channel Number" with the range from 1 to 11.	
Modulation Type	DSSS, OFDM, OFDMA	
Product Type	<input type="checkbox"/> Mobile <input checked="" type="checkbox"/> Portable <input type="checkbox"/> Fix Location	
Antenna System (eg., MIMO, Smart Antenna)	Cyclic Delay Diversity (CDD) for 802.11b/g Multi Input Multi Output (MIMO) for 802.11n/ax	
Categorization as Correlated or Completely Uncorrelated	Categorization as Correlated for 802.11b/g Categorization as Uncorrelated for 802.11n/ax	
Antenna Type	SISO-Antenna 1 SISO-Antenna 2	PCB Antenna
Antenna Gain	SISO-Antenna 1 SISO-Antenna 2	1.12 dBi 0.43 dBi
Total directional gain	For power spectral density (PSD) measurements	Correlated: 3.79 dBi Formulas: Directional gain = $10 \log[(10^{G1/20} + 10^{G2/20} + \dots + 10^{GN/20})^2 / \text{NANT}] \text{ dBi}$ Uncorrelated: 0.79 dBi Formulas: Directional gain = $10 \log[(10^{G1/10} + 10^{G2/10} + \dots + 10^{GN/10}) / \text{NANT}] \text{ dBi}$
	For power measurements	Correlated: 3.79 dBi Formulas: Directional gain = $10 \log[(10^{G1/20} + 10^{G2/20} + \dots + 10^{GN/20})^2 / \text{NANT}] \text{ dBi}$ Uncorrelated: 0.79 dBi Formulas: Directional gain = $10 \log[(10^{G1/10} + 10^{G2/10} + \dots + 10^{GN/10}) / \text{NANT}] \text{ dBi}$
	For	Correlated:

Conducted Out-of-Band and Spurious Measurements	3.79 dBi Formulas: Directional gain = $10 \log[(10^{G1/20} + 10^{G2/20} + \dots + 10^{GN/20})^2 / \text{NANT}]$ dBi Uncorrelated: 0.79 dBi Formulas: Directional gain = $10 \log[(10^{G1/10} + 10^{G2/10} + \dots + 10^{GN/10}) / \text{NANT}]$ dBi
About the Product	Only the WIFI 802.11b, 802.11g, 802.11n(HT20) and 802.11ax(HE20) was tested in this report.

Mode	Antenna		
	SISO-Antenna 1	SISO-Antenna 2	MIMO
802.11b	√	√	√
802.11g	√	√	√
802.11n20	√	√	√
802.11ax20	√	√	√

Note: All the configurations were tested, but only the worst data was shown in this report.

802.11ax RU configuration table				
Mode	Full RU (SU)	RU_26	RU_52	RU_106
802.11ax20	√	√	√	√

Modulation technology	Modulation Type	Transfer Rate (Mbps)(Single RF path)
DSSS (802.11b)	DBPSK	1
	DQPSK	2
	CCK	5.5/11
OFDM (802.11g)	BPSK	6/9
	QPSK	12/18
	16QAM	24/36
	64QAM	48/54
OFDM (802.11n-20 MHz)	BPSK	6.5/7.2
	QPSK	13/19.5/14.4/21.7
	16QAM	26/39/28.9/43.3
	64QAM	52/58.5/65/57.8/65/72.2
OFDMA (802.11ax-20 MHz)	BPSK	4
	QPSK	16/24/17/26
	16QAM	33/49/34/52
	64QAM	65/73/81/69/77/86
	256QAM	98/108/103/115
	1024QAM	122/135/129/143

Note: Preliminary tests were performed in different data rate in above table to find the worst radiated emission. The data rate shown in the table below is the worst-case rate with respect to the specific test item. Investigation has been done on all the possible configurations for searching the worst cases. The following table is a list of the test modes shown in this test report.

Test Items	Mode	Data Rate	Channel
Output Power	11b/11g/11n20/ax20	1/6/6.5/4 Mbps	1/6/11
Occupied Bandwidth	11b/11g/11n20/ax20	1/6/6.5/4 Mbps	1/6/11
Conducted Spurious Emission	11b/11g/11n20/ax20	1/6/6.5/4 Mbps	1/6/11
Conducted Emission	11b/11g/11n20/ax20	1/6/6.5/4 Mbps	1/6/11
Radiated Spurious Emission	11b/11g/11n20/ax20	1/6/6.5/4 Mbps	1/6/11
Band Edge	11b/11g/11n20/ax20	1/6/6.5/4 Mbps	1/6/11
Power spectral density (PSD)	11b/11g/11n20/ax20	1/6/6.5/4 Mbps	1/6/11

Note: The above EUT information in section 2.4 was declared by manufacturer and for more detailed features description, please refer to the manufacturer's specifications or user's manual.



### 3 SUMMARY OF TEST RESULTS

#### 3.1 Test Standards

No.	Identity	Document Title
1	47 CFR Part 15, Subpart C	Intentional radiators of radio frequency equipment
2	KDB Publication 662911 D01v02r01	Emissions Testing of Transmitters with Multiple Outputs in the Same Band (e.g., MIMO, Smart Antenna, etc)
3	ANSI C63.10-2013	American National Standard of Procedures for Compliance Testing of Unlicensed Wireless Devices
4	KDB Publication 558074 D01v05r02	GUIDANCE FOR COMPLIANCE MEASUREMENTS ON DIGITAL TRANSMISSION SYSTEM, FREQUENCY HOPPING SPREAD SPECTRUM SYSTEM, AND HYBRID SYSTEM DEVICES OPERATING UNDER SECTION 15.247 OF THE FCC RULES

#### 3.2 Test Verdict

No.	Description	FCC PART No.	Test Result	Verdict
1	Antenna Requirement	15.203	N/A	Pass <sup>Note 1</sup>
2	Output Power	15.247 (b)	ANNEX A.1	Pass
3	Occupied Bandwidth	15.247 (a)	ANNEX A.2	Pass
4	Conducted Spurious Emission	15.247 (d)	ANNEX A.3	Pass
5	Band Edge(Authorized-band band-edge)	15.247 (d)	ANNEX A.4	Pass
6	Conducted Emission	15.207	ANNEX A.5	Pass
7	Radiated Spurious Emission	15.209; 15.247 (d)	ANNEX A.6	Pass
8	Band Edge(Restricted-band band-edge)	15.209; 15.247 (d)	ANNEX A.7	Pass
9	Power spectral density (PSD)	15.247 (e)	ANNEX A.8	Pass

Note 1: The EUT has a permanently and irreplaceable attached antenna, which complies with the requirement FCC 15.203.

## 4 GENERAL TEST CONFIGURATIONS

### 4.1 Test Environments

During the measurement, the normal environmental conditions were within the listed ranges:

Relative Humidity	31% to 69%	
Atmospheric Pressure	100 kPa to 102 kPa	
Temperature	NT (Normal Temperature)	+17.1°C to +23.6°C
Working Voltage of the EUT	NV (Normal Voltage)	3.8 V

### 4.2 Test Equipment List

Description	Manufacturer	Model	Serial No.	Cal. Date	Cal. Due
Spectrum Analyzer	KEYSIGHT	N9020A	MY50330200	2023.05.16	2024.05.15
Power Sensor	KEYSIGHT	U2063XA	MY58000251	2023.07.12	2024.07.11
Spectrum Analyzer	KEYSIGHT	N9020A	MY52510065	2023.09.05	2024.09.04
Test Antenna-Horn	SCHWARZBECK	BBHA 9120D	01631	2022.02.23	2025.02.22
Test Antenna-Horn	A-INFO	LB-180400KF	J211060273	2021.07.02	2024.07.01
Anechoic Chamber	RAINFORD	9m*6m*6m	144	2022.02.19	2024.09.03
Amplifier	COM-MV	LSCX_LNA1-12G-01	180602	2023.09.05	2024.09.04
Amplifier	COM-MV	XKu_LNA7-18G-01	180601	2023.09.05	2024.09.04
EMI Receiver	ROHDE&SCHWARZ	ESRP	101036	2023.09.05	2024.09.04
Test Antenna-Bi-Log	SCHWARZBECK	VULB 9168	9168-01162	2023.08.04	2024.08.03
Test Antenna-Loop	SCHWARZBECK	FMZB 1519	1519-037	2021.04.16	2024.04.15
Amplifier	COM-MV	ZT30-1000M	B2018054558	2023.12.05	2024.12.04
Anechoic Chamber	EMC Electronic Co., Ltd	20.10*11.60*7.35m	130	2021.08.15	2024.08.14
EMI Receiver	KEYSIGHT	N9010B	MY57110309	2023.09.05	2024.09.04
LISN	SCHWARZBECK	NSLK 8127	8127-687	2023.05.16	2024.05.15
Shielded Enclosure	YiHeng Electronic Co., Ltd	3.5m*3.1m*2.8m	112	2022.02.19	2025.02.18

### 4.3 Test Software List

Description	Manufacturer	Software Version	Serial No.	Applicable test Setup
BL410R	BALUN	V2.1.1.488	N/A	The section 4.5.1
BL410E	BALUN	V22.930	N/A	The section 4.5.2&4.5.3&4.5.4&4.5.5

### 4.4 Measurement Uncertainty

The following measurement uncertainty levels have been estimated for tests performed on the EUT as specified in CISPR 16-4-2.

This uncertainty represents an expanded uncertainty expressed at approximately the 95% confidence level using a coverage factor of k=2.

Parameters	Uncertainty
Occupied Channel Bandwidth	2.8%
RF output power, conducted	1.28 dB
Power Spectral Density, conducted	1.30 dB
Unwanted Emissions, conducted	1.84 dB
All emissions, radiated	5.36 dB
Temperature	0.8°C
Humidity	4%

### 4.5 Description of Test Setup

#### 4.5.1 For Antenna Port Test

$$\text{Conducted value (dBm)} = \text{Measurement value (dBm)} + \text{cable loss (dB)}$$

For example: the measurement value is 10 dBm and the cable 0.5dBm used, then the final result of EUT:

$$\text{Conducted value (dBm)} = 10 \text{ dBm} + 0.5 \text{ dB} = 10.5 \text{ dBm}$$

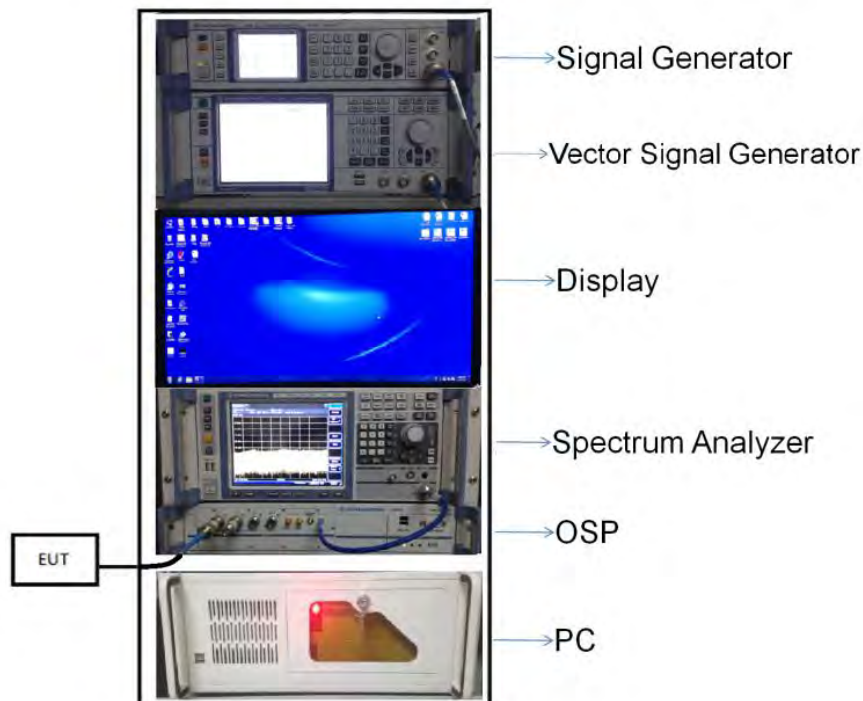

(Diagram 1)

4.5.2 For AC Power Supply Port Test

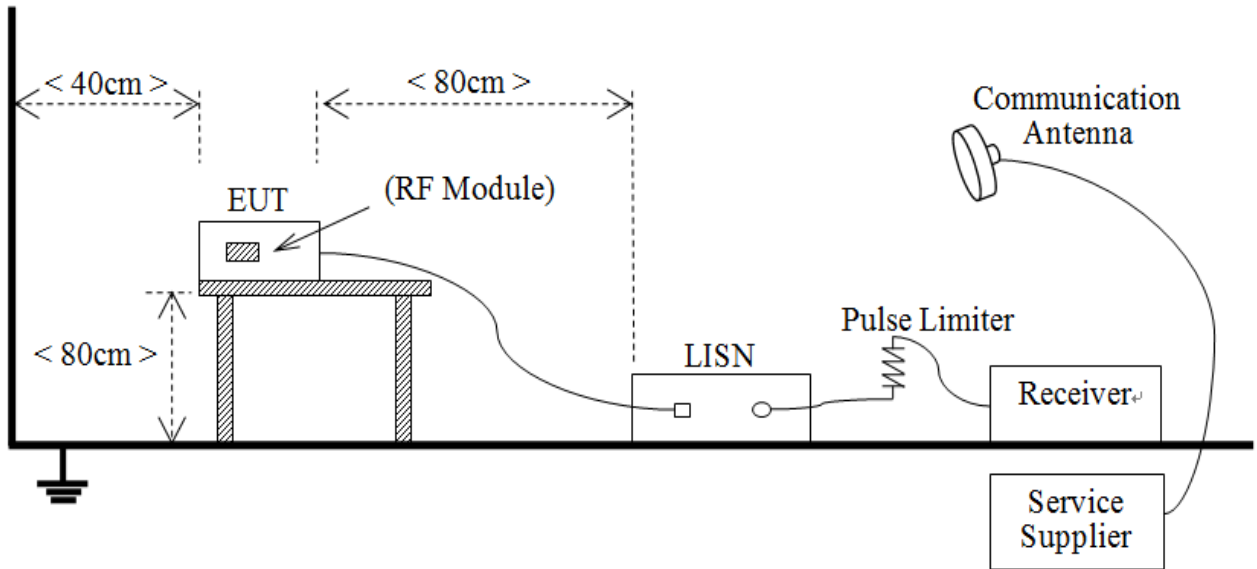

(Diagram 2)

4.5.3 For Radiated Test (Below 30 MHz)

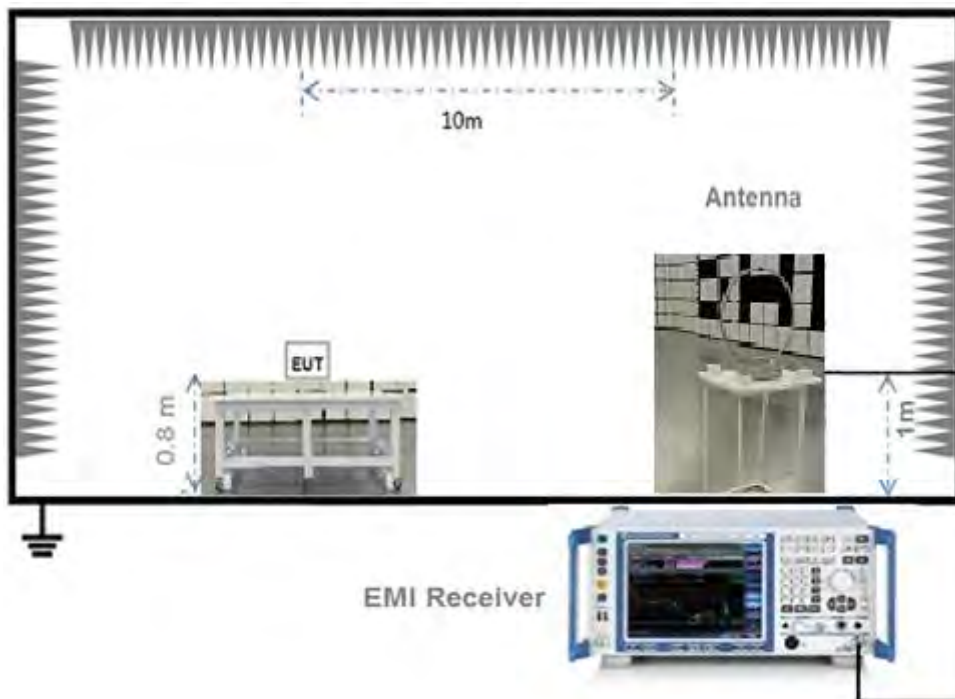

(Diagram 3)

#### 4.5.4 For Radiated Test (30 MHz-1 GHz)

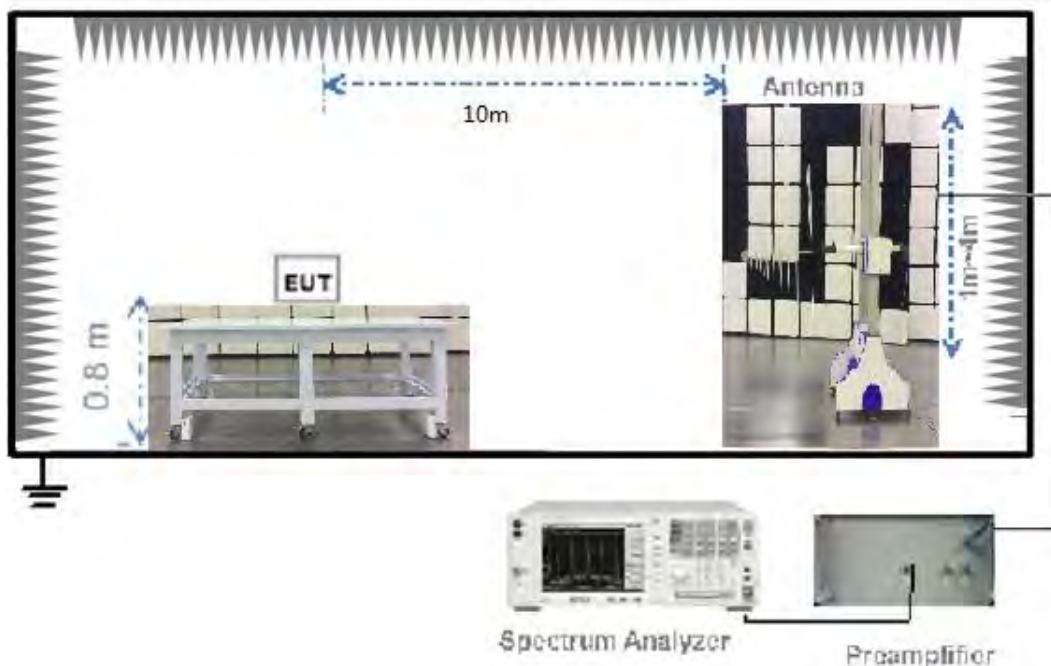

(Diagram 4)

#### 4.5.5 For Radiated Test (Above 1 GHz)

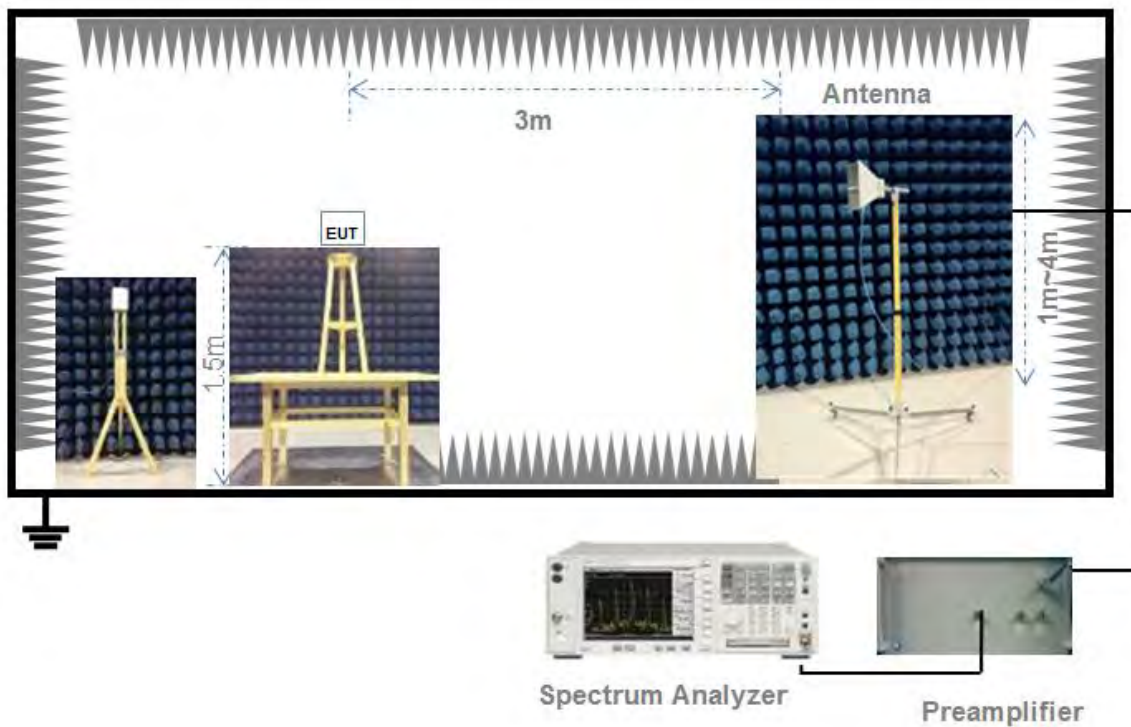

(Diagram 5)

## 4.6 Measurement Results Explanation Example

### 4.6.1 For conducted test items:

The offset level is set in the spectrum analyzer to compensate the RF cable loss and attenuator between EUT conducted output port and spectrum analyzer. With the offset compensation, the spectrum analyzer reading level is exactly the EUT RF output level.

The spectrum analyzer offset is derived from RF cable loss and attenuator factor.

Offset = RF cable loss + attenuator factor.

### 4.6.2 For radiated band edges and spurious emission test:

$$E = \text{EIRP} - 20 \log D + 104.8$$

where:

E = electric field strength in dB $\mu$ V/m,

EIRP = equivalent isotropic radiated power in dBm

D = specified measurement distance in meters.

EIRP = Measure Conducted output power Value (dBm) + Maximum transmit antenna gain (dBi) + the appropriate maximum ground reflection factor (dB)

## 5 TEST ITEMS

### 5.1 Antenna Requirements

#### 5.1.1 Relevant Standards

##### FCC §15.203

An intentional radiator shall be designed to ensure that no antenna other than that furnished by the responsible party shall be used with the device. The use of a permanently attached antenna or of an antenna that uses a unique coupling to the intentional radiator shall be considered sufficient to comply with the provisions of this section. The manufacturer may design the unit so that a broken antenna can be replaced by the user, but the use of a standard antenna jack or electrical connector is prohibited. This requirement does not apply to carrier current devices or to devices operated under the provisions of § 15.211, § 15.213, § 15.217, § 15.219, or § 15.221. Further, this requirement does not apply to intentional radiators that must be professionally installed, such as perimeter protection systems and some field disturbance sensors, or to other intentional radiators which, in accordance with § 15.31(d), must be measured at the installation site. However, the installer shall be responsible for ensuring that the proper antenna is employed so that the limits in this part are not exceeded.

If directional gain of transmitting antennas is greater than 6 dBi, the power shall be reduced by the same level in dB comparing to gain minus 6 dBi. For the fixed point-to-point operation, the power shall be reduced by one dB for every 3 dB that the directional gain of the antenna exceeds 6 dBi. The use of a permanently attached antenna or of an antenna that uses a unique coupling to the intentional radiator shall be considered sufficient to comply with the FCC rule.

#### 5.1.2 Antenna Anti-Replacement Construction

The Antenna Anti-Replacement as following method:

Protected Method	Description
The antenna is embedded in the product.	An embedded-in antenna design is used.

Reference Documents	Item
Photo	Please refer to the EUT Photo documents.

#### 5.1.3 Antenna Gain

The antenna peak gain of EUT is less than 6 dBi. Therefore, it is not necessary to reduce maximum peak output power limit.

## 5.2 Output Power

### 5.2.1 Test Limit

#### FCC § 15.247(b)

For systems using digital modulation in the 902-928 MHz, 2400-2483.5 MHz, and 5725-5850 MHz bands: 1 Watt. As an alternative to a peak power measurement, compliance with the one Watt limit can be based on a measurement of the maximum conducted output power. Maximum Conducted Output Power is defined as the total transmit power delivered to all antennas and antenna elements averaged across all symbols in the signaling alphabet when the transmitter is operating at its maximum power control level. Power must be summed across all antennas and antenna elements.

### 5.2.2 Test Setup

See section 4.5.1 for test setup description for the antenna port. The photo of test setup please refer to ANNEX B.

### 5.2.3 Test Procedure

#### Maximum peak conducted output power

The maximum peak conducted output power may be measured using a broadband peak RF power meter. The power meter shall have a video bandwidth that is greater than or equal to the DTS bandwidth and shall utilize a fast-responding diode detector.

The EUT shall be transmitted at its maximum power control level.

#### Maximum conducted (average) output power (Reporting Only)

a) As an alternative to spectrum analyzer or EMI receiver measurements, measurements may be performed using a wideband RF power meter with a thermocouple detector or equivalent if all of the conditions listed below are satisfied.

- 1) The EUT is configured to transmit continuously, or to transmit with a constant duty factor.
- 2) At all times when the EUT is transmitting, it shall be transmitting at its maximum power control level.
- 3) The integration period of the power meter exceeds the repetition period of the transmitted signal by at least a factor of five.

b) If the transmitter does not transmit continuously, measure the duty cycle (x) of the transmitter output signal.

c) Measure the average power of the transmitter. This measurement is an average over both the on and off periods of the transmitter.

d) Adjust the measurement in dBm by adding  $10\log(1/x)$ , where x is the duty cycle.

#### Measurements of duty cycle

The zero-span mode on a spectrum analyzer or EMI receiver if the response time and spacing between



bins on the sweep are sufficient to permit accurate measurements of the on and off times of the transmitted signal.

Set the center frequency of the instrument to the center frequency of the transmission.

Set  $RBW \geq OBW$  if possible; otherwise, set RBW to the largest available value.

Set  $VBW \geq RBW$ . Set detector = peak or average.

The zero-span measurement method shall not be used unless both RBW and VBW are  $> 50/T$  and the number of sweep points across duration T exceeds 100. (For example, if VBW and/or RBW are limited to 3 MHz, then the zero-span method of measuring duty cycle shall not be used if  $T \leq 16.7$  microseconds.)

#### 5.2.4 Test Result

Please refer to ANNEX A.1.

## 5.3 Occupied Bandwidth

### 5.3.1 Limit

FCC §15.247(a)

Make the measurement with the spectrum analyzer's resolution bandwidth (RBW) = 100 kHz. In order to make an accurate measurement, set the span greater than RBW. The 6 dB bandwidth must be greater than 500 kHz.

### 5.3.2 Test Setup

See section 4.5.1 for test setup description for the antenna port. The photo of test setup please refer to ANNEX B.

### 5.3.3 Test Procedure

Use the following spectrum analyzer settings:

Set RBW = 100 kHz.

Set the video bandwidth (VBW)  $\geq$  3 RBW.

Detector = Peak.

Trace mode = max hold.

Sweep = auto couple.

Allow the trace to stabilize.

Measure the maximum width of the emission that is constrained by the frequencies associated with the two outermost amplitude points (upper and lower frequencies) that are attenuated by 6 dB relative to the maximum level measured in the fundamental emission.

### 5.3.4 Test Result

Please refer to ANNEX A.2.

## 5.4 Conducted Spurious Emission

### 5.4.1 Limit

FCC §15.247(d)

In any 100 kHz bandwidth outside the frequency band in which the spread spectrum or digitally modulated intentional radiator is operating, the radio frequency power that is produced by the intentional radiator shall be at least 20 dB below that in the 100 kHz bandwidth within the band that contains the highest level of the desired power, based on either an RF conducted or a radiated measurement.

### 5.4.2 Test Setup

See section 4.5.1 for test setup description for the antenna port. The photo of test setup please refer to ANNEX B.

### 5.4.3 Test Procedure

The DTS rules specify that in any 100 kHz bandwidth outside of the authorized frequency band, the power shall be attenuated according to the following conditions:

- a) If the maximum peak conducted output power procedure was used to demonstrate compliance as described in 9.1, then the peak output power measured in any 100 kHz bandwidth outside of the authorized frequency band shall be attenuated by at least 20 dB relative to the maximum in-band peak PSD level in 100 kHz (i.e., 20 dBc).
- b) If maximum conducted (average) output power was used to demonstrate compliance as described in 9.2, then the peak power in any 100 kHz bandwidth outside of the authorized frequency band shall be attenuated by at least 30 dB relative to the maximum in-band peak PSD level in 100 kHz (i.e., 30 dBc).
- c) In either case, attenuation to levels below the 15.209 general radiated emissions limits is not required.

The following procedures shall be used to demonstrate compliance to these limits. Note that these procedures can be used in either an antenna-port conducted or radiated test set-up. Radiated tests must conform to the test site requirements and utilize maximization procedures defined herein.

#### Reference level measurement

Establish a reference level by using the following procedure:

Set instrument center frequency to DTS channel center frequency.

Set the span to  $\geq 1.5$  times the DTS bandwidth.

Set the RBW = 100 kHz.

Set the VBW  $\geq 3 \times$  RBW.

Detector = peak.

Sweep time = auto couple.

Trace mode = max hold.

Allow trace to fully stabilize.

Use the peak marker function to determine the maximum PSD level.

#### Emission level measurement

Use the following spectrum analyzer settings:

Span = wide enough to capture the peak level of the in-band emission and all spurious emissions (e.g., harmonics) from the lowest frequency generated in the EUT up through the 10th harmonic. Typically, several plots are required to cover this entire span.

Set the RBW = 100 kHz.

Set the VBW  $\geq 3 \times$  RBW.

Detector = peak.

Sweep time = auto couple.

Trace mode = max hold.

Allow trace to fully stabilize.

Use the peak marker function to determine the maximum amplitude level.

Ensure that the amplitude of all unwanted emissions outside of the authorized frequency band (excluding restricted frequency bands) are attenuated by at least the minimum requirements specified in 11.1 a) or 11.1 b). Report the three highest emissions relative to the limit.

#### 5.4.4 Test Result

Please refer to ANNEX A.3.

## 5.5 Band Edge (Authorized-band band-edge)

### 5.5.1 Limit

#### FCC §15.247(d)

In any 100 kHz bandwidth outside the frequency band in which the spread spectrum or digitally modulated intentional radiator is operating, the radio frequency power that is produced by the intentional radiator shall be at least 20 dB below that in the 100 kHz bandwidth within the band that contains the highest level of the desired power, based on either an RF conducted or a radiated measurement.

### 5.5.2 Test Setup

See section 4.5.1 for test setup description for the antenna port. The photo of test setup please refer to ANNEX B.

### 5.5.3 Test Procedure

The following procedures may be used to determine the peak or average field strength or power of an unwanted emission that is within 2 MHz of the authorized band edge. If a peak detector is utilized, use the procedure described in 13.2.1. Use the procedure described in 13.2.2 when using an average detector and the EUT can be configured to transmit continuously (i.e., duty cycle  $\geq 98\%$ ). Use the procedure described in 13.2.3 when using an average detector and the EUT cannot be configured to transmit continuously but the duty cycle is constant (i.e., duty cycle variations are less than  $\pm 2$  percent). Use the procedure described in 13.2.4 when using an average detector for those cases where the EUT cannot be configured to transmit continuously and the duty cycle is not constant (duty cycle variations equal or exceed 2 percent).

When using a peak detector to measure unwanted emissions at or near the band edge (within 2 MHz of the authorized band), the following integration procedure can be used.

Set instrument center frequency to the frequency of the emission to be measured (must be within 2 MHz of the authorized band edge).

Set span to 2 MHz

RBW = 100 kHz.

VBW  $\geq 3 \times$  RBW.

Detector = peak.

Sweep time = auto.

Trace mode = max hold.

Allow sweep to continue until the trace stabilizes (required measurement time may increase for low duty cycle applications)

Compute the power by integrating the spectrum over 1 MHz using the analyzer's band power measurement function with band limits set equal to the emission frequency (femission)  $\pm 0.5$  MHz. If the instrument does not have a band power function, then sum the amplitude levels (in power units) at 100 kHz intervals extending across the 1 MHz spectrum defined by femission  $\pm 0.5$  MHz.

Standard method(The 99% OBW of the fundamental emission is without 2 MHz of the authorized band):

Span: Wide enough to capture the peak level of the emission operating on the channel closest to the band edge, as well as any modulation products that fall outside of the authorized band of operation.

Reference level: As required to keep the signal from exceeding the maximum instrument input mixer level for linear operation. In general, the peak of the spectral envelope shall be more than [10 log (OBW/RBW)] below the reference level. Specific guidance is given in 4.1.5.2.

Attenuation: Auto (at least 10 dB preferred).

Sweep time: Coupled.

Resolution bandwidth: 100 kHz.

Video bandwidth: 300 kHz.

Detector: Peak.

Trace: Max hold.

#### 5.5.4 Test Result

Please refer to ANNEX A.4.

## 5.6 Conducted Emission

### 5.6.1 Limit

FCC §15.207

For an intentional radiator that is designed to be connected to the public utility (AC) power line, the radio frequency voltage that is conducted back onto the AC power line on any frequency within the band 150 kHz to 30 MHz shall not exceed the limits in the following table, as measured using a 50 $\mu$ H/50 $\Omega$  line impedance stabilization network (LISN).

Frequency range (MHz)	Conducted Limit (dB $\mu$ V)	
	Quai-peak	Average
0.15 - 0.50	66 to 56	56 to 46
0.50 - 5	56	46
0.50 - 30	60	50

### 5.6.2 Test Setup

See section 4.5.2 for test setup description for the AC power supply port. The photo of test setup please refer to ANNEX B.

### 5.6.3 Test Procedure

The maximum conducted interference is searched using Peak (PK), if the emission levels more than the AV and QP limits, and that have narrow margins from the AV and QP limits will be re-measured with AV and QP detectors. Tests for both L phase and N phase lines of the power mains connected to the EUT are performed. Refer to recorded points and plots below.

Devices subject to Part 15 must be tested for all available U.S. voltages and frequencies (such as a nominal 120 VAC, 50/60 Hz and 240 VAC, 50/60 Hz) for which the device is capable of operation. A device rated for 50/60 Hz operation need not be tested at both frequencies provided the radiated and line conducted emissions are the same at both frequencies.

### 5.6.4 Test Result

Please refer to ANNEX A.5.

## 5.7 Radiated Spurious Emission

### 5.7.1 Limit

FCC §15.209&15.247(d)

Radiated emission outside the frequency band attenuation below the general limits specified in FCC section 15.209(a) is not required. In addition, radiated emissions which fall in the restricted bands, as defined in FCC section 15.205(a), must also comply with the radiated emission limits specified in FCC section 15.209(a).

According to FCC section 15.209 (a), except as provided elsewhere in this subpart, the emissions from an intentional radiator shall not exceed the field strength levels specified in the following table:

Frequency (MHz)	Field Strength ( $\mu\text{V}/\text{m}$ )	Measurement Distance (m)
0.009 - 0.490	2400/F(kHz)	300
0.490 - 1.705	24000/F(kHz)	30
1.705 - 30.0	30	30
30 - 88	100	3
88 - 216	150	3
216 - 960	200	3
Above 960	500	3

Note:

- For Above 1000 MHz, the emission limit in this paragraph is based on measurement instrumentation employing an average detector, measurement using instrumentation with a peak detector function, corresponding to 20dB above the maximum permitted average limit.
- For above 1000 MHz, limit field strength of harmonics: 54dBuV/m@3m (AV) and 74dBuV/m@3m (PK).

### 5.7.2 Test Setup

See section 4.5.3 to 4.5.5 for test setup description for the antenna port. The photo of test setup please refer to ANNEX B.

### 5.7.3 Test Procedure

Since the emission limits are specified in terms of radiated field strength levels, measurements performed to demonstrate compliance have traditionally relied on a radiated test configuration. Radiated measurements remain the principal method for demonstrating compliance to the specified limits; however antenna-port conducted measurements are also now acceptable to demonstrate compliance (see below for details). When radiated measurements are utilized, test site requirements and procedures for maximizing and measuring radiated emissions that are described in ANSI C63.10 shall be followed.

Antenna-port conducted measurements may also be used as an alternative to radiated measurements for demonstrating compliance in the restricted frequency bands. If conducted measurements are performed, then proper impedance matching must be ensured and an additional radiated test for cabinet/case spurious emissions is required.



### General Procedure for conducted measurements in restricted bands

- a) Measure the conducted output power (in dBm) using the detector specified (see guidance regarding measurement procedures for determining quasi-peak, peak, and average conducted output power, respectively).
- b) Add the maximum transmit antenna gain (in dBi) to the measured output power level to determine the EIRP level (see guidance on determining the applicable antenna gain)
- c) Add the appropriate maximum ground reflection factor to the EIRP level (6 dB for frequencies  $\leq 30$  MHz, 4.7 dB for frequencies between 30 MHz and 1000 MHz, inclusive and 0 dB for frequencies  $> 1000$  MHz).
- d) For devices with multiple antenna-ports, measure the power of each individual chain and sum the EIRP of all chains in linear terms (e.g., Watts, mW).
- e) Convert the resultant EIRP level to an equivalent electric field strength using the following relationship:

$$E = \text{EIRP} - 20\log D + 104.8$$

where:

E = electric field strength in dB $\mu$ V/m,

EIRP = equivalent isotropic radiated power in dBm

D = specified measurement distance in meters.

- f) Compare the resultant electric field strength level to the applicable limit.
- g) Perform radiated spurious emission test.

### Quasi-Peak measurement procedure

The specifications for measurements using the CISPR quasi-peak detector can be found in Publication 16 of the International Special Committee on Radio Frequency Interference (CISPR) of the International Electrotechnical Commission.

As an alternative to CISPR quasi-peak measurement, compliance can be demonstrated to the applicable emission limits using a peak detector.

### Peak power measurement procedure

Peak emission levels are measured by setting the instrument as follows:

- a) RBW = as specified in Table 1.
- b) VBW  $\geq 3 \times$  RBW.
- c) Detector = Peak.
- d) Sweep time = auto.
- e) Trace mode = max hold.
- f) Allow sweeps to continue until the trace stabilizes. (Note that the required measurement time may be

longer for low duty cycle applications).

Table 1—RBW as a function of frequency

Frequency	RBW
9-150 kHz	200-300 Hz
0.15-30 MHz	9-10 kHz
30-1000 MHz	100-120 kHz
> 1000 MHz	1 MHz

If the peak-detected amplitude can be shown to comply with the average limit, then it is not necessary to perform a separate average measurement.

Trace averaging across on and off times of the EUT transmissions followed by duty cycle correction

If continuous transmission of the EUT (i.e., duty cycle  $\geq 98$  percent) cannot be achieved and the duty cycle is constant (i.e., duty cycle variations are less than  $\pm 2$  percent), then the following procedure shall be used:

- a) The EUT shall be configured to operate at the maximum achievable duty cycle.
- b) Measure the duty cycle,  $x$ , of the transmitter output signal as described in section 6.0.
- c) RBW = 1 MHz (unless otherwise specified).
- d) VBW  $\geq 3 \times$  RBW.
- e) Detector = RMS, if  $\text{span}/(\# \text{ of points in sweep}) \leq (\text{RBW}/2)$ . Satisfying this condition may require increasing the number of points in the sweep or reducing the span. If this condition cannot be satisfied, then the detector mode shall be set to peak.
- f) Averaging type = power (i.e., RMS).
  - 1) As an alternative, the detector and averaging type may be set for linear voltage averaging.
  - 2) Some instruments require linear display mode in order to use linear voltage averaging. Log or dB averaging shall not be used.
- g) Sweep time = auto.
- h) Perform a trace average of at least 100 traces.
- i) A correction factor shall be added to the measurement results prior to comparing to the emission limit in order to compute the emission level that would have been measured had the test been performed at 100 percent duty cycle. The correction factor is computed as follows:
  - 1) If power averaging (RMS) mode was used in step f), then the applicable correction factor is  $10 \log(1/x)$ , where  $x$  is the duty cycle.
  - 2) If linear voltage averaging mode was used in step f), then the applicable correction factor is  $20 \log(1/x)$ , where  $x$  is the duty cycle.
  - 3) If a specific emission is demonstrated to be continuous ( $\geq 98$  percent duty cycle) rather than turning on and off with the transmit cycle, then no duty cycle correction is required for that emission.

NOTE: Reduction of the measured emission amplitude levels to account for operational duty factor is not permitted. Compliance is based on emission levels occurring during transmission - not on an average across on and off times of the transmitter.

#### Determining the applicable transmit antenna gain

A conducted power measurement will determine the maximum output power associated with a restricted band emission; however, in order to determine the associated EIRP level, the gain of the transmitting antenna (in dBi) must be added to the measured output power (in dBm).

Since the out-of-band characteristics of the EUT transmit antenna will often be unknown, the use of a conservative antenna gain value is necessary. Thus, when determining the EIRP based on the measured conducted power, the upper bound on antenna gain for a device with a single RF output shall be selected as the maximum in-band gain of the antenna across all operating bands, or 2 dBi, whichever is greater. However, for devices that operate in multiple frequency bands while using the same transmit antenna, the highest gain of the antenna within the operating band nearest in frequency to the restricted band emission being measured may be used in lieu of the overall highest gain when the emission is at a frequency that is within 20 percent of the nearest band edge frequency, but in no case shall a value less than 2 dBi be used.

See KDB 662911 for guidance on calculating the additional array gain term when determining the effective antenna gain for a EUT with multiple outputs occupying the same or overlapping frequency ranges in the same band.

#### Radiated spurious emission test

An additional consideration when performing conducted measurements of restricted band emissions is that unwanted emissions radiating from the EUT cabinet, control circuits, power leads, or intermediate circuit elements will likely go undetected in a conducted measurement configuration. To address this concern, a radiated test shall be performed to ensure that emissions emanating from the EUT cabinet (rather than the antenna port) also comply with the applicable limits.

For these cabinet radiated spurious emission measurements the EUT transmit antenna may be replaced with a termination matching the nominal impedance of the antenna. Procedures for performing radiated measurements are specified in ANSI C63.10. All detected emissions shall comply with the applicable limits.

The measurement frequency range is from 30 MHz to the 10th harmonic of the fundamental frequency. The Turn Table is actuated to turn from 0° to 360°, and both horizontal and vertical polarizations of the Test Antenna are used to find the maximum radiated power. Mid channels on all channel bandwidth verified. Only the worst RB size/offset presented.

The power of the EUT transmitting frequency should be ignored.

All Spurious Emission tests were performed in X, Y, Z axis direction. And only the worst axis test condition was recorded in this test report.

Use the following spectrum analyzer settings:

Span = wide enough to fully capture the emission being measured

RBW = 1 MHz for  $f \geq 1$  GHz, 100 kHz for  $f < 1$  GHz

VBW  $\geq$  RBW

Sweep = auto

Detector function = peak

Trace = max hold

#### 5.7.4 Test Result

Please refer to ANNEX A.6.

## 5.8 Band Edge (Restricted-band band-edge)

### 5.8.1 Limit

FCC §15.209&15.247(d)

Radiated emission outside the frequency band attenuation below the general limits specified in FCC section 15.209(a) is not required. In addition, radiated emissions which fall in the restricted bands, as defined in FCC section 15.205(a), must also comply with the radiated emission limits specified in FCC section 15.209(a).

### 5.8.2 Test Setup

See section 4.5.1 for test setup description for the antenna port. The photo of test setup please refer to ANNEX B.

### 5.8.3 Test Procedure

The measurement frequency range is from 9 kHz to the 10th harmonic of the fundamental frequency. The Turn Table is actuated to turn from 0° to 360°, and both horizontal and vertical polarizations of the Test Antenna are used to find the maximum radiated power. Mid channels on all channel bandwidth verified. Only the worst RB size/offset presented.

The power of the EUT transmitting frequency should be ignored.

All Spurious Emission tests were performed in X, Y, Z axis direction. And only the worst axis test condition was recorded in this test report.

Use the following spectrum analyzer settings:

Span = wide enough to fully capture the emission being measured

RBW = 1 MHz for  $f \geq 1$  GHz, 100 kHz for  $f < 1$  GHz

VBW  $\geq$  RBW

Sweep = auto

Detector function = peak

Trace = max hold

For measurement below 1GHz, If the emission level of the EUT measured by the peak detector is 3 dB lower than the applicable limit, the peak emission level will be reported, Otherwise, the emission measurement will be repeated using the quasi-peak detector and reported.

For transmitters operating above 1 GHz repeat the measurement with an average detector.

### 5.8.4 Test Result

Please refer to ANNEX A.7.

## 5.9 Power Spectral density (PSD)

### 5.9.1 Limit

#### FCC §15.247(e)

The same method of determining the conducted output power shall be used to determine the power spectral density. If a peak output power is measured, then a peak power spectral density measurement is required. If an average output power is measured, then an average power spectral density measurement should be used.

### 5.9.2 Test Setup

See section 4.5.1 for test setup description for the antenna port. The photo of test setup please refer to ANNEX B.

### 5.9.3 Test Procedure

Set analyzer center frequency to DTS channel center frequency.

Set the span to 1.5 times the DTS bandwidth.

Set the RBW to:  $3 \text{ kHz} \leq \text{RBW} \leq 100 \text{ kHz}$ .

Set the VBW  $\geq 3 \text{ RBW}$ .

Detector = peak.

Sweep time = auto couple.

Trace mode = max hold.

Allow trace to fully stabilize.

Use the peak marker function to determine the maximum amplitude level within the RBW.

If measured value exceeds limit, reduce RBW (no less than 3 kHz) and repeat.

### 5.9.4 Test Result

Please refer to ANNEX A.8.

## ANNEX A TEST RESULT

### A.1 Output Power

#### Duty Cycle

Test Mode	On Time (ms)	On+Off time (ms)	Duty Cycle	Duty Factor
802.11b	8.402	8.504	98.80%	0.05
802.11g	2.061	2.093	98.47%	0.07
802.11n-20 MHz	1.307	1.407	92.89%	0.32
802.11ax-20 MHz	1.018	1.121	90.81%	0.42

#### Peak Power Test Data

##### SISO-Antenna 1

##### 802.11b Mode:

Channel	Measured Output Peak Power		Limit		Verdict
	dBm	mW	dBm	mW	
Low	17.26	53.21	30	1000	Pass
Middle	15.51	35.56			Pass
High	14.62	28.97			Pass

##### 802.11g Mode:

Channel	Measured Output Peak Power		Limit		Verdict
	dBm	mW	dBm	mW	
Low	23.24	210.86	30	1000	Pass
Middle	22.56	180.30			Pass
High	22.08	161.44			Pass

##### 802.11n-20 MHz Mode:

Channel	Measured Output Peak Power		Limit		Verdict
	dBm	mW	dBm	mW	
Low	22.47	176.60	30	1000	Pass
Middle	22.18	165.20			Pass
High	21.25	133.35			Pass

##### 802.11ax-20 MHz(SU) Mode:

Channel	Measured Output Peak Power		Limit		Verdict
	dBm	mW	dBm	mW	
Low	23.06	202.30	30	1000	Pass
Middle	21.67	146.89			Pass
High	21.82	152.05			Pass

## 802.11ax-20 MHz(RU) Mode:

Channel	RU Config	Measured Output Peak Power		Limit		Verdict
		dBm	mW	dBm	mW	
Low	26	24.91	309.74	30	1000	Pass
	52	24.48	280.54			Pass
	106	20.63	115.61			Pass

## 802.11ax-20 MHz(RU) Mode:

Channel	RU Config	Measured Output Peak Power		Limit		Verdict
		dBm	mW	dBm	mW	
Middle	26	24.48	280.54	30	1000	Pass
	52	24.49	281.19			Pass
	106	23.94	247.74			Pass

## 802.11ax-20 MHz(RU) Mode:

Channel	RU Config	Measured Output Peak Power		Limit		Verdict
		dBm	mW	dBm	mW	
High	26	20.63	115.61	30	1000	Pass
	52	20.22	105.20			Pass
	106	19.63	91.83			Pass



SISO-Antenna 2

## 802.11b Mode:

Channel	Measured Output Peak Power		Limit		Verdict
	dBm	mW	dBm	mW	
Low	20.86	121.90	30	1000	Pass
Middle	20.77	119.40			Pass
High	20.66	116.41			Pass

## 802.11g Mode:

Channel	Measured Output Peak Power		Limit		Verdict
	dBm	mW	dBm	mW	
Low	23.71	234.96	30	1000	Pass
Middle	24.16	260.62			Pass
High	22.67	184.93			Pass

## 802.11n-20 MHz Mode:

Channel	Measured Output Peak Power		Limit		Verdict
	dBm	mW	dBm	mW	
Low	23.79	239.33	30	1000	Pass
Middle	24.06	254.68			Pass
High	21.86	153.46			Pass

## 802.11ax-20 MHz(SU) Mode:

Channel	Measured Output Peak Power		Limit		Verdict
	dBm	mW	dBm	mW	
Low	23.83	241.55	30	1000	Pass
Middle	24.40	275.42			Pass
High	21.94	156.31			Pass

## 802.11ax-20 MHz(RU) Mode:

Channel	RU Config	Measured Output Peak Power		Limit		Verdict
		dBm	mW	dBm	mW	
Low	26	25.74	374.97	30	1000	Pass
	52	25.45	350.75			Pass
	106	24.58	287.08			Pass

## 802.11ax-20 MHz(RU) Mode:

Channel	RU Config	Measured Output Peak Power		Limit		Verdict
		dBm	mW	dBm	mW	
Middle	26	25.19	330.37	30	1000	Pass
	52	25.72	373.25			Pass
	106	24.37	273.53			Pass

## 802.11ax-20 MHz(RU) Mode:

Channel	RU Config	Measured Output Peak Power		Limit		Verdict
		dBm	mW	dBm	mW	
High	26	24.16	260.62	30	1000	Pass
	52	24.53	283.79			Pass
	106	23.47	222.33			Pass

**MIMO-Antenna 1****802.11b Mode:**

Channel	Measured Output Peak Power		Limit		Verdict
	dBm	mW	dBm	mW	
Low	16.43	43.95	30	1000	Pass
Middle	15.68	36.98			Pass
High	14.45	27.86			Pass

**802.11g Mode:**

Channel	Measured Output Peak Power		Limit		Verdict
	dBm	mW	dBm	mW	
Low	23.06	202.30	30	1000	Pass
Middle	24.31	269.77			Pass
High	23.31	214.29			Pass

**802.11n-20 MHz Mode:**

Channel	Measured Output Peak Power		Limit		Verdict
	dBm	mW	dBm	mW	
Low	23.65	231.74	30	1000	Pass
Middle	23.51	224.39			Pass
High	23.75	237.14			Pass

**802.11ax-20 MHz(SU) Mode:**

Channel	Measured Output Peak Power		Limit		Verdict
	dBm	mW	dBm	mW	
Low	23.89	244.91	30	1000	Pass
Middle	24.31	269.77			Pass
High	23.45	221.31			Pass

**802.11ax-20 MHz(RU) Mode:**

Channel	RU Config	Measured Output Peak Power		Limit		Verdict
		dBm	mW	dBm	mW	
Low	26	22.75	188.36	30	1000	Pass
	52	23.71	234.96			Pass
	106	22.34	171.40			Pass

**802.11ax-20 MHz(RU) Mode:**

Channel	RU Config	Measured Output Peak Power		Limit		Verdict
		dBm	mW	dBm	mW	
Middle	26	22.96	197.70	30	1000	Pass
	52	22.80	190.55			Pass
	106	21.86	153.46			Pass

## 802.11ax-20 MHz(RU) Mode:

Channel	RU Config	Measured Output Peak Power		Limit		Verdict
		dBm	mW	dBm	mW	
High	26	18.02	63.39	30	1000	Pass
	52	17.85	60.95			Pass
	106	17.09	51.17			Pass

MIMO-Antenna 2

## 802.11b Mode:

Channel	Measured Output Peak Power		Limit		Verdict
	dBm	mW	dBm	mW	
Low	15.09	32.28	30	1000	Pass
Middle	14.13	25.88			Pass
High	13.01	20.00			Pass

## 802.11g Mode:

Channel	Measured Output Peak Power		Limit		Verdict
	dBm	mW	dBm	mW	
Low	21.86	153.46	30	1000	Pass
Middle	23.84	242.10			Pass
High	21.95	156.68			Pass

## 802.11n-20 MHz Mode:

Channel	Measured Output Peak Power		Limit		Verdict
	dBm	mW	dBm	mW	
Low	23.08	203.24	30	1000	Pass
Middle	23.18	207.97			Pass
High	21.51	141.58			Pass

## 802.11ax-20 MHz(SU) Mode:

Channel	Measured Output Peak Power		Limit		Verdict
	dBm	mW	dBm	mW	
Low	21.89	154.53	30	1000	Pass
Middle	22.75	188.36			Pass
High	21.67	146.89			Pass

## 802.11ax-20 MHz(RU) Mode:

Channel	RU Config	Measured Output Peak Power		Limit		Verdict
		dBm	mW	dBm	mW	
Low	26	21.31	135.21	30	1000	Pass
	52	22.22	166.72			Pass
	106	21.38	137.40			Pass

## 802.11ax-20 MHz(RU) Mode:

Channel	RU Config	Measured Output Peak Power		Limit		Verdict
		dBm	mW	dBm	mW	
Middle	26	20.61	115.08	30	1000	Pass
	52	22.20	165.96			Pass
	106	21.50	141.25			Pass

## 802.11ax-20 MHz(RU) Mode:

Channel	RU Config	Measured Output Peak Power		Limit		Verdict
		dBm	mW	dBm	mW	
High	26	17.48	55.98	30	1000	Pass
	52	17.68	58.61			Pass
	106	15.40	34.67			Pass

**MIMO****802.11b Mode:**

Channel	Measured Output Peak Power		Limit		Verdict
	dBm	mW	dBm	mW	
Low	18.82	76.24	30	1000	Pass
Middle	17.98	62.86			Pass
High	16.80	47.86			Pass

**802.11g Mode:**

Channel	Measured Output Peak Power		Limit		Verdict
	dBm	mW	dBm	mW	
Low	25.51	355.76	30	1000	Pass
Middle	27.09	511.88			Pass
High	25.69	370.96			Pass

**802.11n-20 MHz Mode:**

Channel	Measured Output Peak Power		Limit		Verdict
	dBm	mW	dBm	mW	
Low	26.38	434.98	30	1000	Pass
Middle	26.36	432.36			Pass
High	25.78	378.72			Pass

**802.11ax-20 MHz(SU) Mode:**

Channel	Measured Output Peak Power		Limit		Verdict
	dBm	mW	dBm	mW	
Low	26.01	399.43	30	1000	Pass
Middle	26.61	458.14			Pass
High	25.66	368.20			Pass

**802.11ax-20 MHz(RU) Mode:**

Channel	RU Config	Measured Output Peak Power		Limit		Verdict
		dBm	mW	dBm	mW	
Low	26	25.10	323.57	30	1000	Pass
	52	26.04	401.69			Pass
	106	24.90	308.80			Pass

**802.11ax-20 MHz(RU) Mode:**

Channel	RU Config	Measured Output Peak Power		Limit		Verdict
		dBm	mW	dBm	mW	
Middle	26	24.95	312.78	30	1000	Pass
	52	25.52	356.50			Pass
	106	24.69	294.72			Pass

## 802.11ax-20 MHz(RU) Mode:

Channel	RU Config	Measured Output Peak Power		Limit		Verdict
		dBm	mW	dBm	mW	
High	26	20.77	119.36	30	1000	Pass
	52	20.78	119.57			Pass
	106	19.34	85.84			Pass



## Average Power Test Data

SISO-Antenna 1

## 802.11b Mode:

Channel	Measured Output Average Power		Limit		Verdict
	dBm	mW	dBm	mW	
Low	14.39	27.48	30	1000	Pass
Middle	12.55	17.99			Pass
High	11.81	15.17			Pass

## 802.11g Mode:

Channel	Measured Output Average Power		Limit		Verdict
	dBm	mW	dBm	mW	
Low	14.92	31.05	30	1000	Pass
Middle	13.65	23.17			Pass
High	12.95	19.72			Pass

## 802.11n-20 MHz Mode:

Channel	Measured Output Average Power		Limit		Verdict
	dBm	mW	dBm	mW	
Low	14.92	31.05	30	1000	Pass
Middle	14.01	25.18			Pass
High	12.78	18.97			Pass

## 802.11ax-20 MHz(SU) Mode:

Channel	Measured Output Average Power		Limit		Verdict
	dBm	mW	dBm	mW	
Low	14.59	28.77	30	1000	Pass
Middle	13.14	20.61			Pass
High	13.15	20.65			Pass

## 802.11ax-20 MHz(RU) Mode:

Channel	RU Config	Measured Output Average Power		Limit		Verdict
		dBm	mW	dBm	mW	
Low	26	13.66	23.23	30	1000	Pass
	52	13.80	23.99			Pass
	106	12.20	16.60			Pass

## 802.11ax-20 MHz(RU) Mode:

Channel	RU Config	Measured Output Average Power		Limit		Verdict
		dBm	mW	dBm	mW	
Middle	26	13.30	21.38	30	1000	Pass
	52	13.37	21.73			Pass
	106	11.88	15.42			Pass

## 802.11ax-20 MHz(RU) Mode:

Channel	RU Config	Measured Output Average Power		Limit		Verdict
		dBm	mW	dBm	mW	
High	26	9.52	8.95	30	1000	Pass
	52	9.54	8.99			Pass
	106	7.78	6.00			Pass

SISO-Antenna 2

## 802.11b Mode:

Channel	Measured Output Average Power		Limit		Verdict
	dBm	mW	dBm	mW	
Low	17.53	56.62	30	1000	Pass
Middle	17.98	62.81			Pass
High	17.58	57.28			Pass

## 802.11g Mode:

Channel	Measured Output Average Power		Limit		Verdict
	dBm	mW	dBm	mW	
Low	16.61	45.81	30	1000	Pass
Middle	18.47	70.31			Pass
High	14.67	29.31			Pass

## 802.11n-20 MHz Mode:

Channel	Measured Output Average Power		Limit		Verdict
	dBm	mW	dBm	mW	
Low	16.41	43.75	30	1000	Pass
Middle	17.80	60.26			Pass
High	14.01	25.18			Pass

## 802.11ax-20 MHz(SU) Mode:

Channel	Measured Output Average Power		Limit		Verdict
	dBm	mW	dBm	mW	
Low	15.57	36.06	30	1000	Pass
Middle	17.84	60.81			Pass
High	14.04	25.35			Pass

## 802.11ax-20 MHz(RU) Mode:

Channel	RU Config	Measured Output Average Power		Limit		Verdict
		dBm	mW	dBm	mW	
Low	26	15.39	34.59	30	1000	Pass
	52	14.75	29.85			Pass
	106	13.00	19.95			Pass

## 802.11ax-20 MHz(RU) Mode:

Channel	RU Config	Measured Output Average Power		Limit		Verdict
		dBm	mW	dBm	mW	
Middle	26	14.63	29.04	30	1000	Pass
	52	14.33	27.10			Pass
	106	12.81	19.10			Pass

## 802.11ax-20 MHz(RU) Mode:

Channel	RU Config	Measured Output Average Power		Limit		Verdict
		dBm	mW	dBm	mW	
High	26	13.58	22.80	30	1000	Pass
	52	13.50	22.39			Pass
	106	11.63	14.55			Pass

## MIMO-Antenna 1

## 802.11b Mode:

Channel	Measured Output Average Power		Limit		Verdict
	dBm	mW	dBm	mW	
Low	13.29	21.33	30	1000	Pass
Middle	12.21	16.63			Pass
High	11.58	14.39			Pass

## 802.11g Mode:

Channel	Measured Output Average Power		Limit		Verdict
	dBm	mW	dBm	mW	
Low	13.79	23.93	30	1000	Pass
Middle	15.83	38.28			Pass
High	13.95	24.83			Pass

## 802.11n-20 MHz Mode:

Channel	Measured Output Average Power		Limit		Verdict
	dBm	mW	dBm	mW	
Low	14.93	31.12	30	1000	Pass
Middle	14.52	28.31			Pass
High	14.35	27.23			Pass

## 802.11ax-20 MHz(SU) Mode:

Channel	Measured Output Average Power		Limit		Verdict
	dBm	mW	dBm	mW	
Low	14.87	30.69	30	1000	Pass
Middle	14.90	30.90			Pass
High	14.48	28.05			Pass

## 802.11ax-20 MHz(RU) Mode:

Channel	RU Config	Measured Output Average Power		Limit		Verdict
		dBm	mW	dBm	mW	
Low	26	12.06	16.07	30	1000	Pass
	52	12.21	16.63			Pass
	106	10.53	11.30			Pass

## 802.11ax-20 MHz(RU) Mode:

Channel	RU Config	Measured Output Average Power		Limit		Verdict
		dBm	mW	dBm	mW	
Middle	26	11.62	14.52	30	1000	Pass
	52	11.75	14.96			Pass
	106	10.04	10.09			Pass

## 802.11ax-20 MHz(RU) Mode:

Channel	RU Config	Measured Output Average Power		Limit		Verdict
		dBm	mW	dBm	mW	
High	26	6.99	5.00	30	1000	Pass
	52	6.96	4.97			Pass
	106	5.26	3.36			Pass

MIMO-Antenna 2

## 802.11b Mode:

Channel	Measured Output Average Power		Limit		Verdict
	dBm	mW	dBm	mW	
Low	12.72	18.71	30	1000	Pass
Middle	11.29	13.46			Pass
High	10.10	10.23			Pass

## 802.11g Mode:

Channel	Measured Output Average Power		Limit		Verdict
	dBm	mW	dBm	mW	
Low	13.16	20.70	30	1000	Pass
Middle	15.76	37.67			Pass
High	13.11	20.46			Pass

## 802.11n-20 MHz Mode:

Channel	Measured Output Average Power		Limit		Verdict
	dBm	mW	dBm	mW	
Low	14.89	30.83	30	1000	Pass
Middle	14.95	31.26			Pass
High	13.98	25.00			Pass

## 802.11ax-20 MHz(SU) Mode:

Channel	Measured Output Average Power		Limit		Verdict
	dBm	mW	dBm	mW	
Low	13.27	21.23	30	1000	Pass
Middle	14.57	28.64			Pass
High	12.94	19.68			Pass

## 802.11ax-20 MHz(RU) Mode:

Channel	RU Config	Measured Output Average Power		Limit		Verdict
		dBm	mW	dBm	mW	
Low	26	12.30	16.98	30	1000	Pass
	52	12.29	16.94			Pass
	106	10.18	10.42			Pass

## 802.11ax-20 MHz(RU) Mode:

Channel	RU Config	Measured Output Average Power		Limit		Verdict
		dBm	mW	dBm	mW	
Middle	26	12.01	15.89	30	1000	Pass
	52	12.09	16.18			Pass
	106	10.25	10.59			Pass

## 802.11ax-20 MHz(RU) Mode:

Channel	RU Config	Measured Output Average Power		Limit		Verdict
		dBm	mW	dBm	mW	
High	26	7.54	5.68	30	1000	Pass
	52	7.29	5.36			Pass
	106	4.14	2.59			Pass



**MIMO****802.11b Mode:**

Channel	Measured Output Average Power		Limit		Verdict
	dBm	mW	dBm	mW	
Low	16.02	40.04	30	1000	Pass
Middle	14.78	30.09			Pass
High	13.91	24.62			Pass

**802.11g Mode:**

Channel	Measured Output Average Power		Limit		Verdict
	dBm	mW	dBm	mW	
Low	16.50	44.63	30	1000	Pass
Middle	18.81	75.95			Pass
High	16.56	45.30			Pass

**802.11n-20 MHz Mode:**

Channel	Measured Output Average Power		Limit		Verdict
	dBm	mW	dBm	mW	
Low	17.92	61.95	30	1000	Pass
Middle	17.75	59.57			Pass
High	17.18	52.23			Pass

**802.11ax-20 MHz(SU) Mode:**

Channel	Measured Output Average Power		Limit		Verdict
	dBm	mW	dBm	mW	
Low	17.15	51.92	30	1000	Pass
Middle	17.75	59.54			Pass
High	16.79	47.73			Pass

**802.11ax-20 MHz(RU) Mode:**

Channel	RU Config	Measured Output Average Power		Limit		Verdict
		dBm	mW	dBm	mW	
Low	26	15.19	33.05	30	1000	Pass
	52	15.26	33.58			Pass
	106	13.37	21.72			Pass

**802.11ax-20 MHz(RU) Mode:**

Channel	RU Config	Measured Output Average Power		Limit		Verdict
		dBm	mW	dBm	mW	
Middle	26	14.83	30.41	30	1000	Pass
	52	14.93	31.14			Pass
	106	13.16	20.69			Pass

## 802.11ax-20 MHz(RU) Mode:

Channel	RU Config	Measured Output Average Power		Limit		Verdict
		dBm	mW	dBm	mW	
High	26	10.28	10.68	30	1000	Pass
	52	10.14	10.32			Pass
	106	7.75	5.95			Pass

## A.2 Occupied Bandwidth

Note: All the configurations were pre tested, only the worst configuration has been reported in this report.

### Test Data

#### SISO-Antenna 1

##### 802.11b Mode:

Channel	6 dB Bandwidth (MHz)	99% Bandwidth (MHz)	6 dB Bandwidth Limits (kHz)
Low	7.650000	11.253000	≥500
Middle	7.600000	11.243000	≥500
High	7.100000	11.171000	≥500

##### 802.11g Mode:

Channel	6 dB Bandwidth (MHz)	99% Bandwidth (MHz)	6 dB Bandwidth Limits (kHz)
Low	16.400000	17.572000	≥500
Middle	16.400000	17.676000	≥500
High	16.400000	17.547000	≥500

##### 802.11n-20MHz Mode:

Channel	6 dB Bandwidth (MHz)	99% Bandwidth (MHz)	6 dB Bandwidth Limits (kHz)
Low	17.650000	18.494000	≥500
Middle	17.650000	18.545000	≥500
High	17.650000	18.465000	≥500

##### 802.11ax-20 MHz(SU) Mode:

Channel	6 dB Bandwidth (MHz)	99% Bandwidth (MHz)	6 dB Bandwidth Limits (kHz)
Low	18.700000	19.053000	≥500
Middle	18.600000	19.077000	≥500
High	18.850000	19.017000	≥500

SISO-Antenna 2

## 802.11b Mode:

Channel	6 dB Bandwidth (MHz)	99% Bandwidth (MHz)	6 dB Bandwidth Limits (kHz)
Low	7.650000	11.535000	≥500
Middle	7.600000	12.077000	≥500
High	8.150000	12.485000	≥500

## 802.11g Mode:

Channel	6 dB Bandwidth (MHz)	99% Bandwidth (MHz)	6 dB Bandwidth Limits (kHz)
Low	16.400000	17.946000	≥500
Middle	16.450000	19.750000	≥500
High	16.400000	18.202000	≥500

## 802.11n-20MHz Mode:

Channel	6 dB Bandwidth (MHz)	99% Bandwidth (MHz)	6 dB Bandwidth Limits (kHz)
Low	17.650000	18.974000	≥500
Middle	17.600000	19.354000	≥500
High	17.600000	18.766000	≥500

## 802.11ax-20 MHz(SU) Mode:

Channel	6 dB Bandwidth (MHz)	99% Bandwidth (MHz)	6 dB Bandwidth Limits (kHz)
Low	17.900000	19.217000	≥500
Middle	18.550000	19.324000	≥500
High	18.850000	19.160000	≥500

Test Plots

SISO-Antenna 1

6 dB Bandwidth

802.11b LOW CHANNEL



802.11b MIDDLE CHANNEL



802.11b HIGH CHANNEL

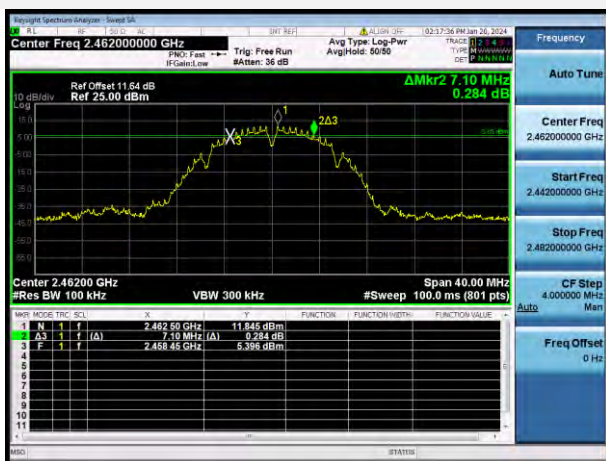

802.11g LOW CHANNEL

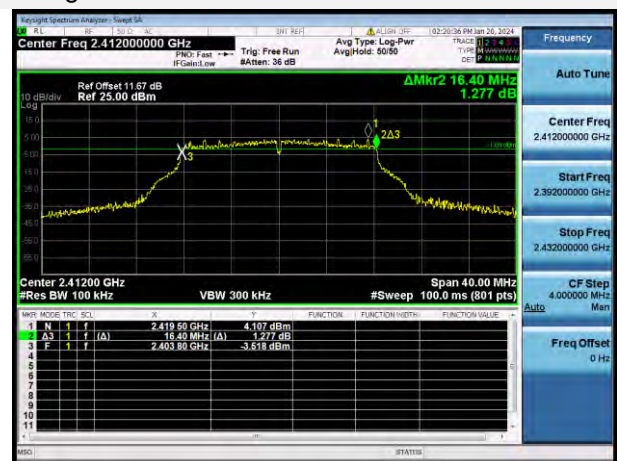

802.11g MIDDLE CHANNEL



802.11g HIGH CHANNEL



802.11n-20 MHz LOW CHANNEL



802.11n-20 MHz MIDDLE CHANNEL



802.11n-20 MHz HIGH CHANNEL



802.11ax-20 MHz(SU) LOW CHANNEL



802.11ax-20 MHz(SU) MIDDLE CHANNEL



802.11ax-20 MHz(SU) HIGH CHANNEL

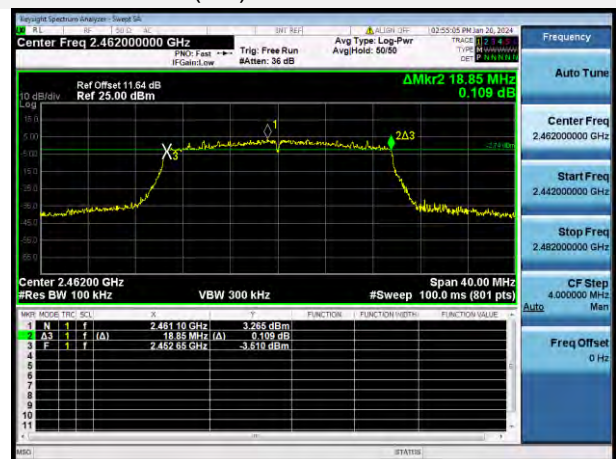

99% Bandwidth

802.11b LOW CHANNEL

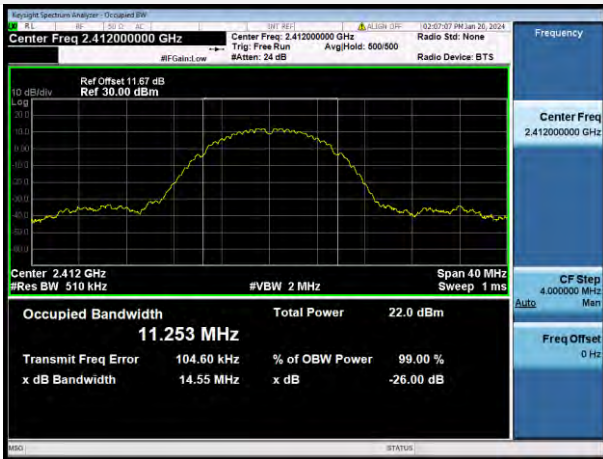

802.11b MIDDLE CHANNEL

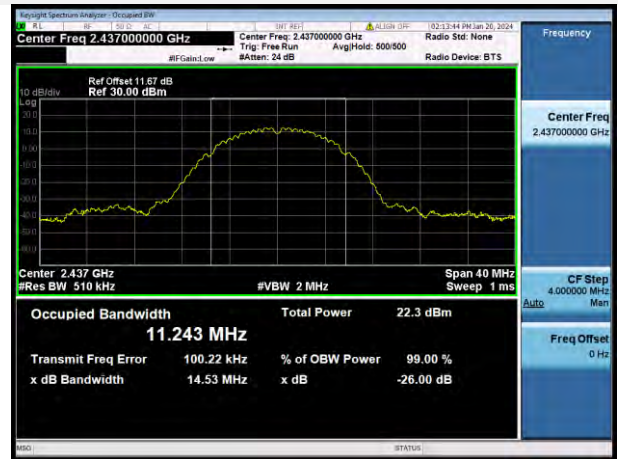

802.11b HIGH CHANNEL

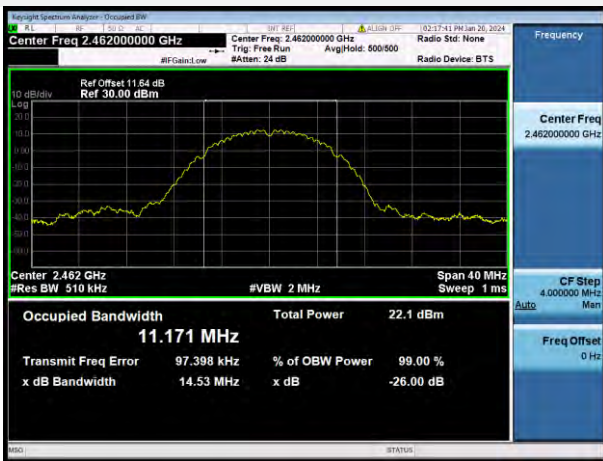

802.11g LOW CHANNEL

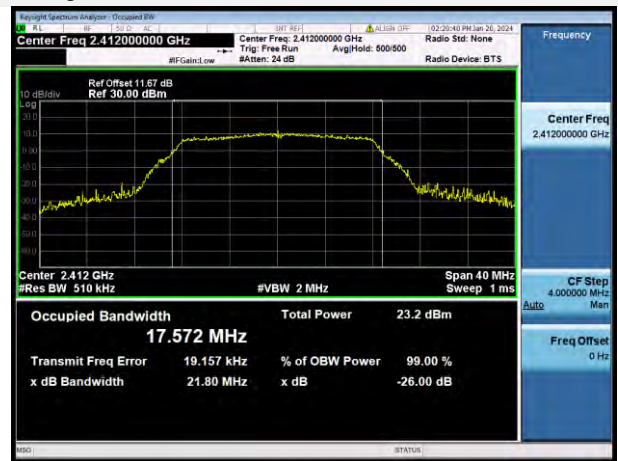

802.11g MIDDLE CHANNEL

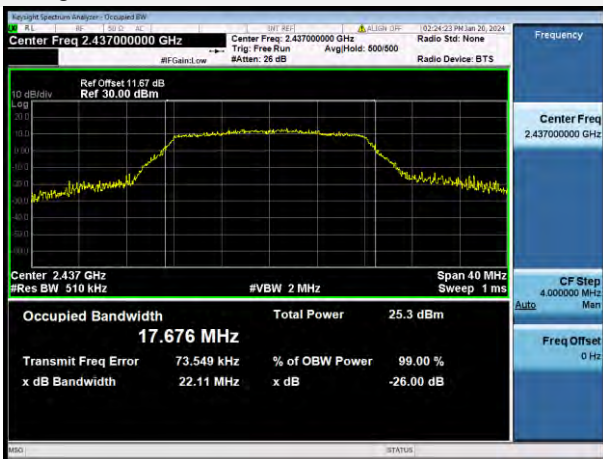

802.11g HIGH CHANNEL

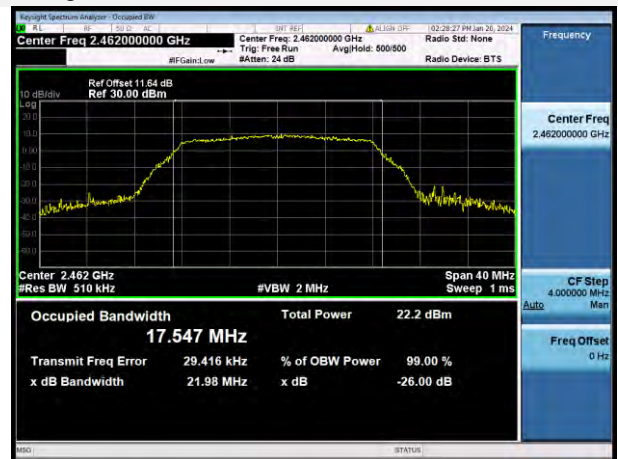

802.11n-20 MHz LOW CHANNEL

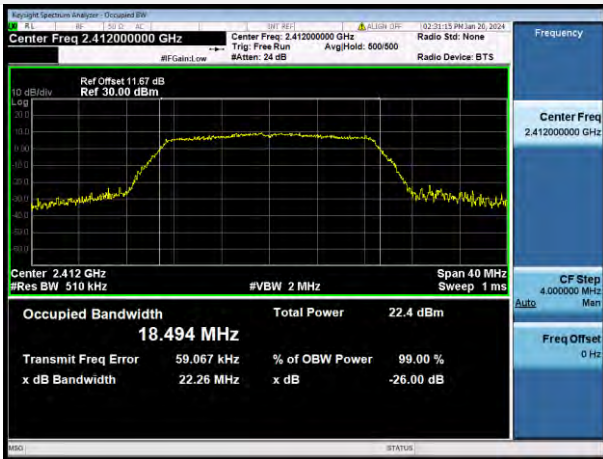

802.11n-20 MHz MIDDLE CHANNEL

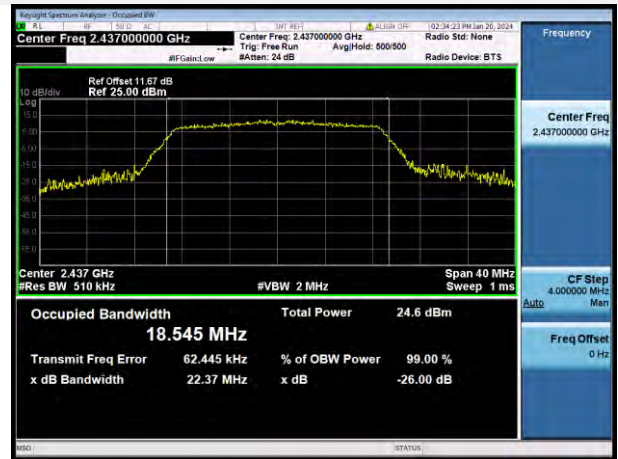

802.11n-20 MHz HIGH CHANNEL

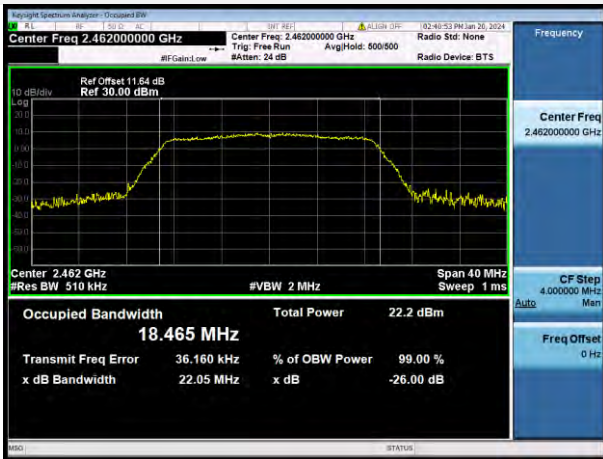

802.11ax-20 MHz(SU) LOW CHANNEL

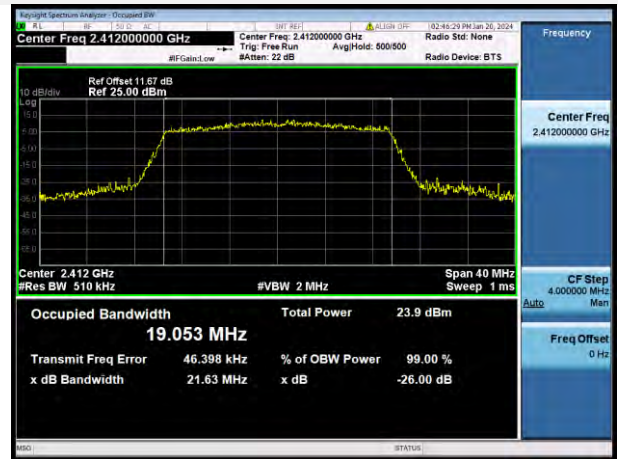

802.11ax-20 MHz(SU) MIDDLE CHANNEL

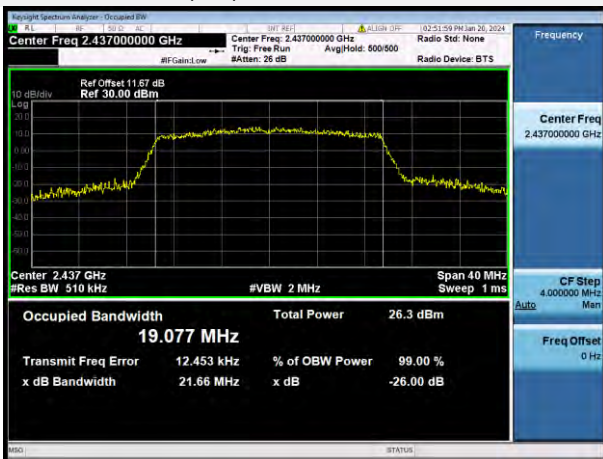

802.11ax-20 MHz(SU) HIGH CHANNEL

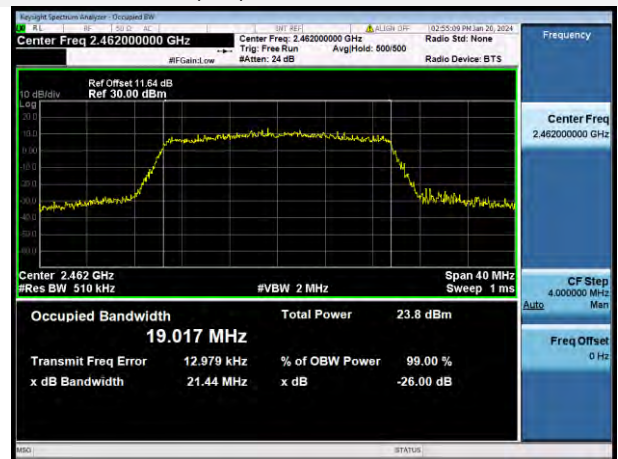



SISO-Antenna 2  
6 dB Bandwidth

802.11b LOW CHANNEL



802.11b MIDDLE CHANNEL



802.11b HIGH CHANNEL



802.11g LOW CHANNEL



802.11g MIDDLE CHANNEL



802.11g HIGH CHANNEL



802.11n-20 MHz LOW CHANNEL



802.11n-20 MHz MIDDLE CHANNEL

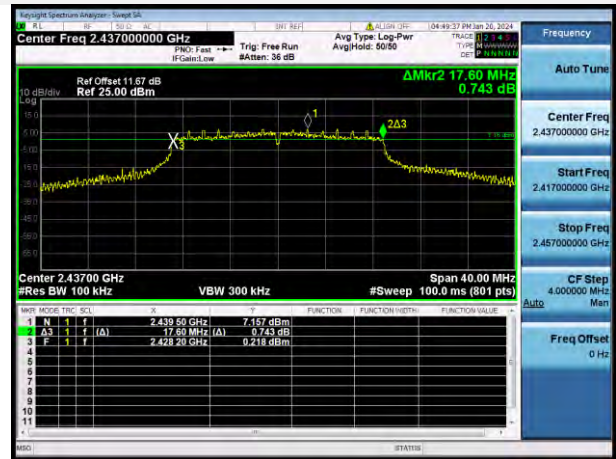

802.11n-20 MHz HIGH CHANNEL



802.11ax-20 MHz(SU) LOW CHANNEL



802.11ax-20 MHz(SU) MIDDLE CHANNEL



802.11ax-20 MHz(SU) HIGH CHANNEL



99% Bandwidth

802.11b LOW CHANNEL

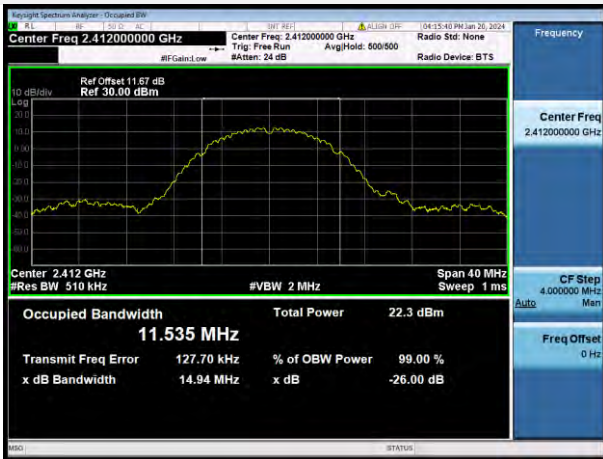

802.11b MIDDLE CHANNEL

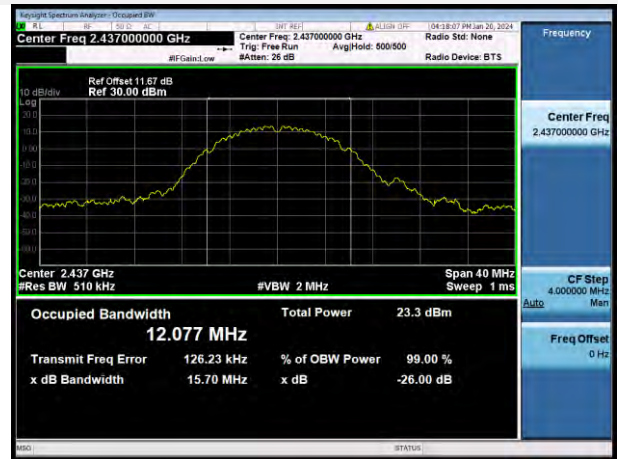

802.11b HIGH CHANNEL



802.11g LOW CHANNEL

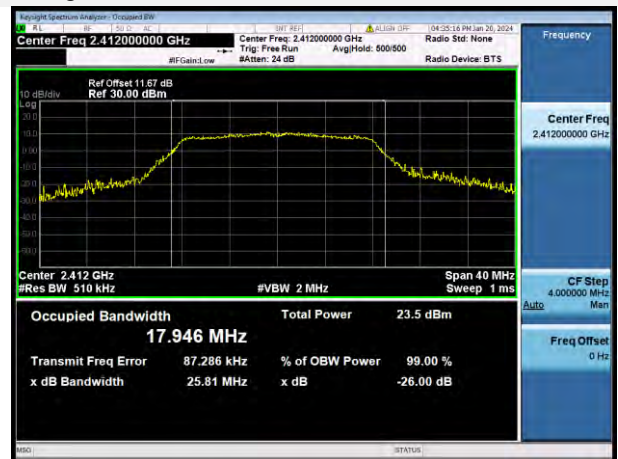

802.11g MIDDLE CHANNEL

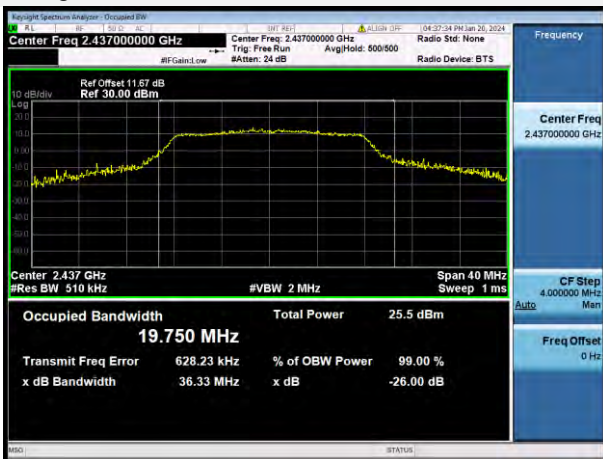

802.11g HIGH CHANNEL



802.11n-20 MHz LOW CHANNEL

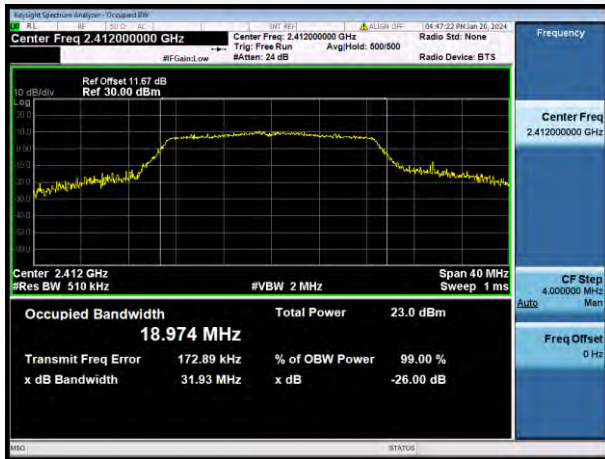

802.11n-20 MHz MIDDLE CHANNEL



802.11n-20 MHz HIGH CHANNEL



802.11ax-20 MHz(SU) LOW CHANNEL



802.11ax-20 MHz(SU) MIDDLE CHANNEL

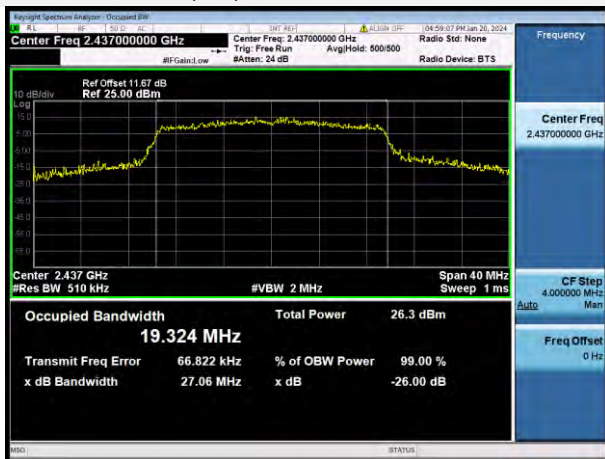

802.11ax-20 MHz(SU) HIGH CHANNEL



### A.3 Conducted Spurious Emissions

Note: All the configurations were pre tested, only the worst configuration has been reported in this report.

#### Test Data

##### SISO-Antenna 1

##### 802.11b Mode:

Channel	Measured Max. Out of Band Emission (dBm)	Limit (dBm)		Verdict
		Carrier Level	Calculated 20 dBc Limit	
Low	-36.35	6.95	-13.05	Pass
Middle	-37.24	5.12	-14.88	Pass
High	-34.64	4.16	-15.84	Pass

##### 802.11g Mode:

Channel	Measured Max. Out of Band Emission (dBm)	Limit (dBm)		Verdict
		Carrier Level	Calculated 20 dBc Limit	
Low	-36.90	3.45	-16.55	Pass
Middle	-36.31	1.98	-18.02	Pass
High	-36.54	1.40	-18.60	Pass

##### 802.11n-20MHz Mode:

Channel	Measured Max. Out of Band Emission (dBm)	Limit (dBm)		Verdict
		Carrier Level	Calculated 20 dBc Limit	
Low	-36.49	3.64	-16.36	Pass
Middle	-37.07	2.53	-17.47	Pass
High	-36.44	1.29	-18.71	Pass

##### 802.11ax-20 MHz(SU) Mode:

Channel	Measured Max. Out of Band Emission (dBm)	Limit (dBm)		Verdict
		Carrier Level	Calculated 20 dBc Limit	
Low	-37.03	3.36	-16.64	Pass
Middle	-34.89	1.77	-18.23	Pass
High	-36.94	1.89	-18.12	Pass

SISO-Antenna 2

## 802.11b Mode:

Channel	Measured Max. Out of Band Emission (dBm)	Limit (dBm)		Verdict
		Carrier Level	Calculated 20 dBc Limit	
Low	-37.22	10.12	-9.88	Pass
Middle	-36.92	10.54	-9.46	Pass
High	-36.93	10.63	-9.38	Pass

## 802.11g Mode:

Channel	Measured Max. Out of Band Emission (dBm)	Limit (dBm)		Verdict
		Carrier Level	Calculated 20 dBc Limit	
Low	-35.61	7.66	-12.34	Pass
Middle	-35.51	7.74	-12.26	Pass
High	-35.81	3.25	-16.75	Pass

## 802.11n-20MHz Mode:

Channel	Measured Max. Out of Band Emission (dBm)	Limit (dBm)		Verdict
		Carrier Level	Calculated 20 dBc Limit	
Low	-36.32	5.02	-14.99	Pass
Middle	-36.34	7.18	-12.82	Pass
High	-36.50	2.62	-17.38	Pass

## 802.11ax-20 MHz(SU) Mode:

Channel	Measured Max. Out of Band Emission (dBm)	Limit (dBm)		Verdict
		Carrier Level	Calculated 20 dBc Limit	
Low	-35.98	4.46	-15.54	Pass
Middle	-36.68	6.59	-13.41	Pass
High	-36.90	2.43	-17.57	Pass

MIMO-Antenna 1

## 802.11b Mode:

Channel	Measured Max. Out of Band Emission (dBm)	Limit (dBm)		Verdict
		Carrier Level	Calculated 20 dBc Limit	
Low	-36.15	5.86	-14.14	Pass
Middle	-36.09	4.32	-15.68	Pass
High	-35.90	3.60	-16.40	Pass

## 802.11g Mode:

Channel	Measured Max. Out of Band Emission (dBm)	Limit (dBm)		Verdict
		Carrier Level	Calculated 20 dBc Limit	
Low	-35.19	2.34	-17.66	Pass
Middle	-36.19	3.78	-16.22	Pass
High	-35.61	2.20	-17.80	Pass

## 802.11n-20MHz Mode:

Channel	Measured Max. Out of Band Emission (dBm)	Limit (dBm)		Verdict
		Carrier Level	Calculated 20 dBc Limit	
Low	-37.22	3.26	-16.75	Pass
Middle	-34.73	2.95	-17.05	Pass
High	-37.64	2.71	-17.29	Pass

## 802.11ax-20 MHz(SU) Mode:

Channel	Measured Max. Out of Band Emission (dBm)	Limit (dBm)		Verdict
		Carrier Level	Calculated 20 dBc Limit	
Low	-36.75	3.74	-16.26	Pass
Middle	-36.30	4.18	-15.82	Pass
High	-36.97	2.87	-17.13	Pass

MIMO-Antenna 2

## 802.11b Mode:

Channel	Measured Max. Out of Band Emission (dBm)	Limit (dBm)		Verdict
		Carrier Level	Calculated 20 dBc Limit	
Low	-34.94	4.65	-15.35	Pass
Middle	-35.73	3.57	-16.43	Pass
High	-35.60	2.34	-17.66	Pass

## 802.11g Mode:

Channel	Measured Max. Out of Band Emission (dBm)	Limit (dBm)		Verdict
		Carrier Level	Calculated 20 dBc Limit	
Low	-36.93	1.17	-18.83	Pass
Middle	-36.11	4.54	-15.46	Pass
High	-36.79	2.04	-17.96	Pass

## 802.11n-20MHz Mode:

Channel	Measured Max. Out of Band Emission (dBm)	Limit (dBm)		Verdict
		Carrier Level	Calculated 20 dBc Limit	
Low	-36.54	4.66	-15.34	Pass
Middle	-36.72	4.41	-15.59	Pass
High	-35.63	2.78	-17.22	Pass

## 802.11ax-20 MHz(SU) Mode:

Channel	Measured Max. Out of Band Emission (dBm)	Limit (dBm)		Verdict
		Carrier Level	Calculated 20 dBc Limit	
Low	-36.54	0.14	-19.86	Pass
Middle	-36.92	3.93	-16.07	Pass
High	-36.17	1.45	-18.55	Pass



Test Plots

SISO-Antenna 1

802.11b LOW CHANNEL CARRIER LEVEL



802.11b LOW CHANNEL, SPURIOUS 30 MHz ~ 3 GHz

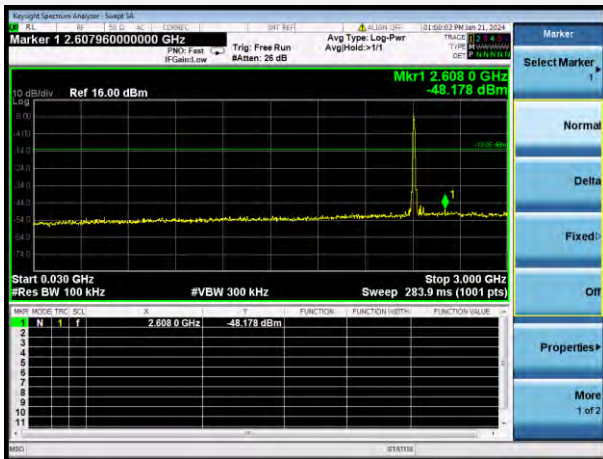

802.11b LOW CHANNEL, SPURIOUS 2 GHz ~ 25 GHz



802.11b MIDDLE CHANNEL CARRIER LEVEL



802.11b MIDDLE CHANNEL, SPURIOUS  
30 MHz ~ 3 GHz

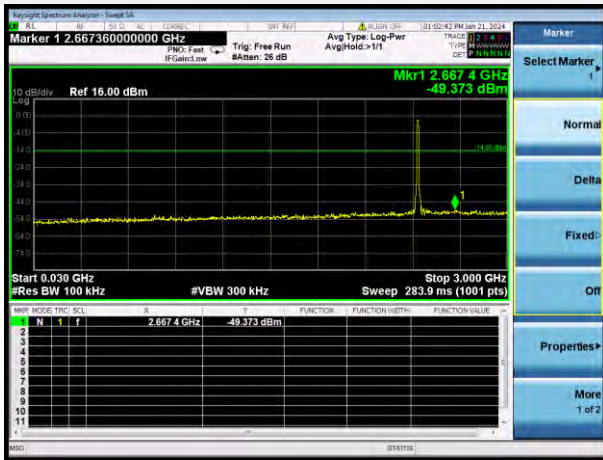

802.11b MIDDLE CHANNEL, SPURIOUS  
2 GHz ~ 25 GHz



802.11b HIGH CHANNEL CARRIER LEVEL



802.11b HIGH CHANNEL, SPURIOUS  
30 MHz ~ 3 GHz

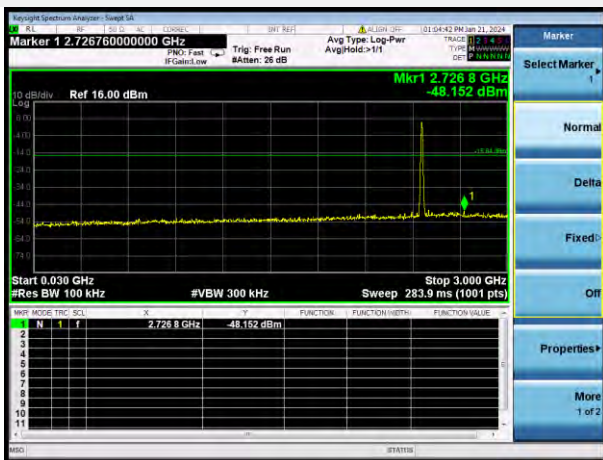

802.11b HIGH CHANNEL, SPURIOUS  
2 GHz ~ 25 GHz



802.11g LOW CHANNEL CARRIER LEVEL

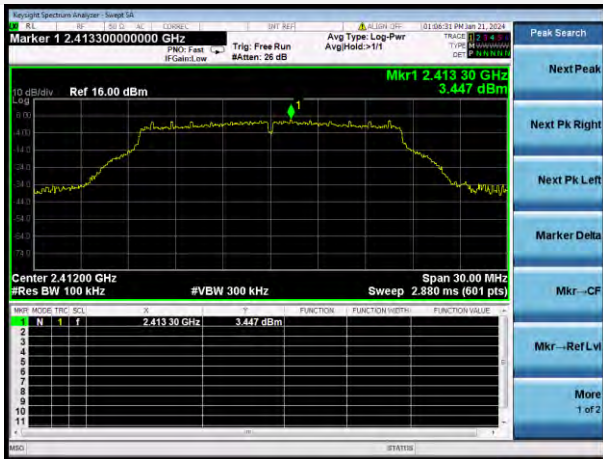

802.11g LOW CHANNEL, SPURIOUS 30 MHz ~ 3 GHz      802.11g LOW CHANNEL, SPURIOUS 2 GHz ~ 25 GHz

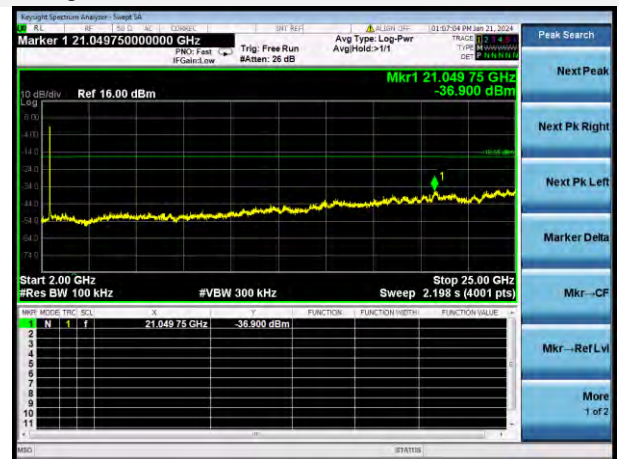
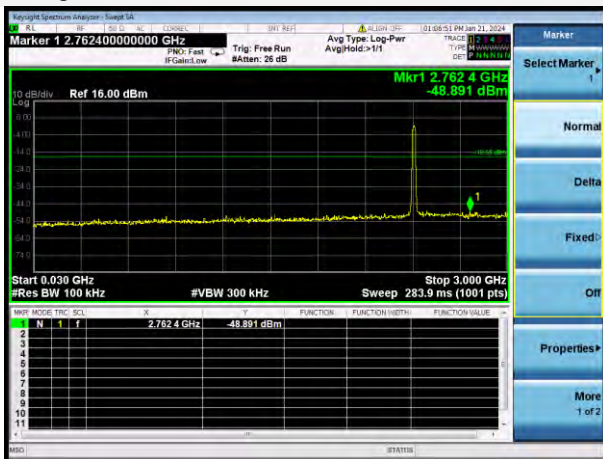

802.11g MIDDLE CHANNEL CARRIER LEVEL

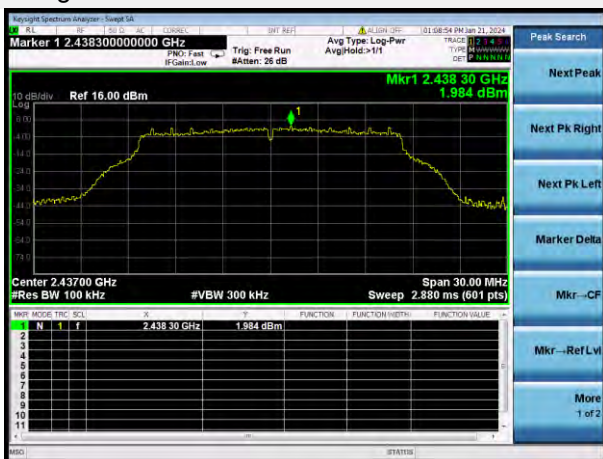

802.11g MIDDLE CHANNEL, SPURIOUS  
30 MHz ~ 3 GHz

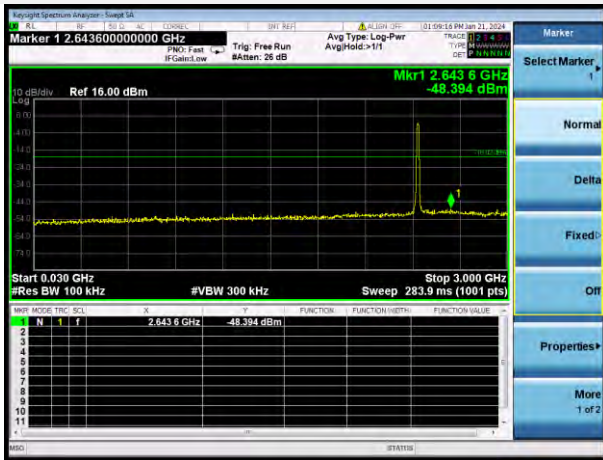

802.11g MIDDLE CHANNEL, SPURIOUS  
2 GHz ~ 25 GHz



802.11g HIGH CHANNEL CARRIER LEVEL



802.11g HIGH CHANNEL, SPURIOUS  
30 MHz ~ 3 GHz

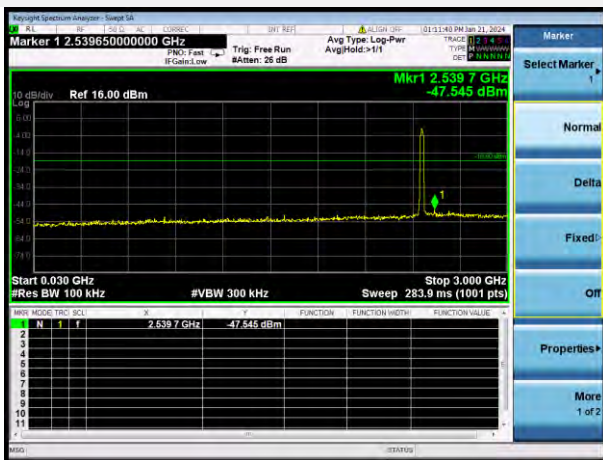

802.11g HIGH CHANNEL, SPURIOUS  
2 GHz ~ 25 GHz



802.11n-20 MHz LOW CHANNEL CARRIER LEVEL

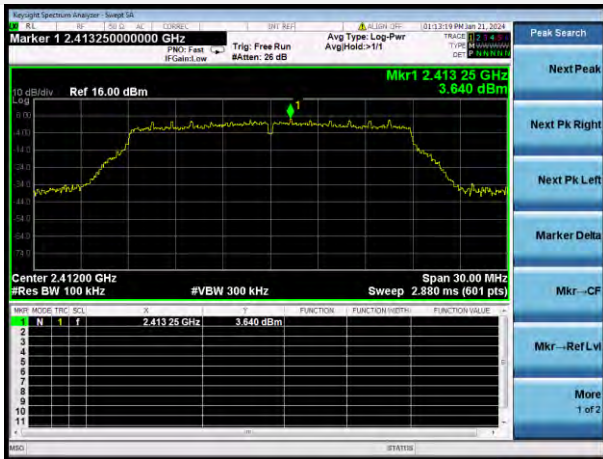

802.11n-20 MHz LOW CHANNEL, SPURIOUS  
30 MHz ~ 3 GHz

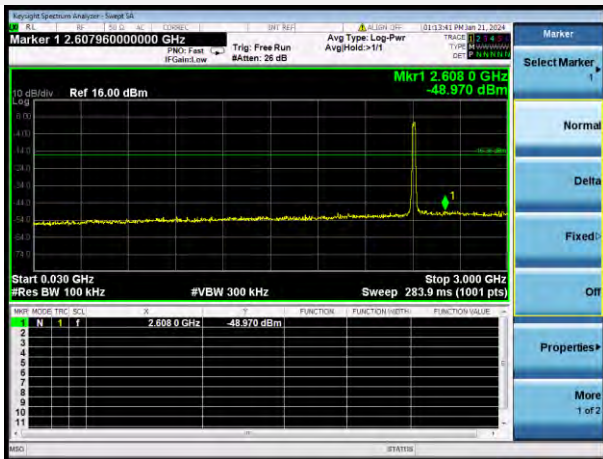

802.11n-20 MHz LOW CHANNEL, SPURIOUS  
2 GHz ~ 25 GHz



802.11n-20 MHz MIDDLE CHANNEL CARRIER LEVEL

