

FCC TEST REPORT

For

Shenzhen Minsuo Industrial Co.,Ltd.
Car Air Vent Wireless Charging Holder

Model No.: CS-194

Prepared For : Shenzhen Minsuo Industrial Co.,Ltd.
Room 532-533, Block B, Baoyuan Huafeng Headquarter Economy
Address : Building, No.288 Xixiang Road, Baoan District, Shenzhen, Guangdong,
China

Prepared By : Shenzhen Anbotek Compliance Laboratory Limited
Address : 1/F, Building D, Sogood Science and Technology Park, Sanwei
community, Hangcheng Street, Bao'an District, Shenzhen, Guangdong,
China.518102
Tel: (86) 755-26066365 Fax: (86) 755-26014772

Report Number : SZAWW180206003-01
Date of Test : Feb. 06~Mar. 15, 2018
Date of Report : Mar. 15, 2018

Contents

| | |
|---------------------------------------------------|----|
| 1. General Information..... | 4 |
| 1.1. Client Information..... | 4 |
| 1.2. Description of Device (EUT)..... | 4 |
| 1.3. Auxiliary Equipment Used During Test..... | 4 |
| 1.4. Description of Test Modes..... | 5 |
| 1.5. List of channels..... | 5 |
| 1.6. Description Of Test Setup..... | 6 |
| 1.7. Test Equipment List..... | 7 |
| 1.8. Measurement Uncertainty..... | 8 |
| 1.9. Description of Test Facility..... | 8 |
| 2. Summary of Test Results..... | 9 |
| 3. Conducted Emission Test..... | 10 |
| 3.1. Test Standard and Limit..... | 10 |
| 3.2. Test Setup..... | 10 |
| 3.3. Test Procedure..... | 10 |
| 3.4. Test Data..... | 10 |
| 4. Radiation Spurious Emission and Band Edge..... | 15 |
| 4.1. Test Standard and Limit..... | 15 |
| 4.2. Test Setup..... | 15 |
| 4.3. Test Procedure..... | 16 |
| 4.4. Test Data..... | 17 |
| APPENDIX I -- TEST SETUP PHOTOGRAPH..... | 21 |
| APPENDIX II -- EXTERNAL PHOTOGRAPH..... | 23 |
| APPENDIX III -- INTERNAL PHOTOGRAPH..... | 27 |

TEST REPORT

Applicant : Shenzhen Minsuo Industrial Co.,Ltd.
Manufacturer : Shenzhen Minsuo Industrial Co.,Ltd.
Product Name : Car Air Vent Wireless Charging Holder
Model No. : CS-194
Trade Mark : N/A
Rating(s) : Input: DC 5V, 2A
 : Output: DC 5V, 1A

Test Standard(s) : FCC Part15 Subpart C 2017, Paragraph 15.209

Test Method(s) : ANSI C63.10: 2013

The device described above is tested by Shenzhen Anbotek Compliance Laboratory Limited to determine the maximum emission levels emanating from the device and the severe levels of the device can endure and its performance criterion. The measurement results are contained in this test report and Shenzhen Anbotek Compliance Laboratory Limited is assumed full of responsibility for the accuracy and completeness of these measurements. Also, this report shows that the EUT (Equipment Under Test) is technically compliant with the FCC Part 15 Subpart C requirements.

This report applies to above tested sample only and shall not be reproduced in part without written approval of Shenzhen Anbotek Compliance Laboratory Limited.

Date of Test : Feb. 06~Mar. 15, 2018

Prepared by :



Winkey Wang

(Tested Engineer / Winkey Wang)

Reviewer :

Tangcy. T.

(Project Manager / Tangcy. T)

Approved & Authorized Signer :

Tom Chen

(Manager / Tom Chen)

1. General Information

1.1. Client Information

| | | |
|--------------|---|-----------------------------------------------------------------------------------------------------------------------------------------|
| Applicant | : | Shenzhen Minsuo Industrial Co.,Ltd. |
| Address | : | Room 532-533, Block B, Baoyuan Huafeng Headquarter Economy Building, No.288 Xixiang Road, Baoan District, Shenzhen, Guangdong, China |
| Manufacturer | : | Shenzhen Minsuo Industrial Co.,Ltd. |
| Address | : | Room 532-533, Block B, Baoyuan Huafeng Headquarter Economy Building, No.288 Xixiang Road, Baoan District, Shenzhen, Guangdong, China |

1.2. Description of Device (EUT)

| | | | |
|------------------------------------------------------------------------------------------------------------------------------|---|-----------------------------------------------------|--------------|
| Product Name | : | Car Air Vent Wireless Charging Holder | |
| Model No. | : | CS-194 | |
| Trade Mark | : | N/A | |
| Test Power Supply | : | AC 120V, 60Hz for adapter/AC 240V, 60Hz for adapter | |
| Product Description | : | Operation Frequency: | 110-205KHz |
| | : | Number of Channel: | 20 Channels |
| | : | Modulation Type: | MSK |
| | : | Antenna Type: | Loop Antenna |
| | : | Antenna Gain(Peak): | 0 dBi |
| Remark: 1) For a more detailed features description, please refer to the manufacturer's specifications or the User's Manual. | | | |

1.3. Auxiliary Equipment Used During Test

| | | |
|--------------|---|-------------------------------------------------------------------------------------------------|
| Mobile Phone | : | Manufacturer: NOKIA |
| | : | M/N: N920 S/N: 356355051634804 CE , FCC, DOC |
| Adapter | : | Manufacturer: SAMSUNG |
| | : | M/N: ETA-U90CBC S/N: RT6FB17ZS/B-E Input: 100-240V~50/60Hz 0.35A Output: DC 5V, 2000mA |

1.4. Description of Test Modes

To investigate the maximum EMI emission characteristics generated from EUT, the test system was pre-scanning tested based on the consideration of following EUT operation mode or test configuration mode which possibly have effect on EMI emission level. Each of these EUT operation mode(s) or test configuration mode(s) mentioned above was evaluated respectively.

| Pretest Mode | Description |
|--------------|--------------------------|
| Mode 1 | CH01 |
| Mode 2 | CH10 |
| Mode 3 | CH20 |
| Mode 4 | Keeping TX+Charging mode |

| For Conducted Emission | |
|------------------------|--------------------------|
| Final Test Mode | Description |
| Mode 4 | Keeping TX+Charging mode |

| For Radiated Emission | |
|-----------------------|-------------|
| Final Test Mode | Description |
| Mode 1 | CH01 |
| Mode 2 | CH10 |
| Mode 3 | CH20 |

1.5. List of channels

| Channel | Freq. (MHz) | Channel | Freq. (MHz) | Channel | Freq. (MHz) | Channel | Freq. (MHz) |
|---------|----------------|---------|----------------|---------|----------------|---------|----------------|
| 1 | 0.110 | 6 | 0.135 | 11 | 0.160 | 16 | 0.185 |
| 2 | 0.115 | 7 | 0.140 | 12 | 0.165 | 17 | 0.190 |
| 3 | 0.120 | 8 | 0.145 | 13 | 0.170 | 18 | 0.195 |
| 4 | 0.125 | 9 | 0.150 | 14 | 0.175 | 19 | 0.200 |
| 5 | 0.130 | 10 | 0.155 | 15 | 0.180 | 20 | 0.205 |

1.6. Description Of Test Setup

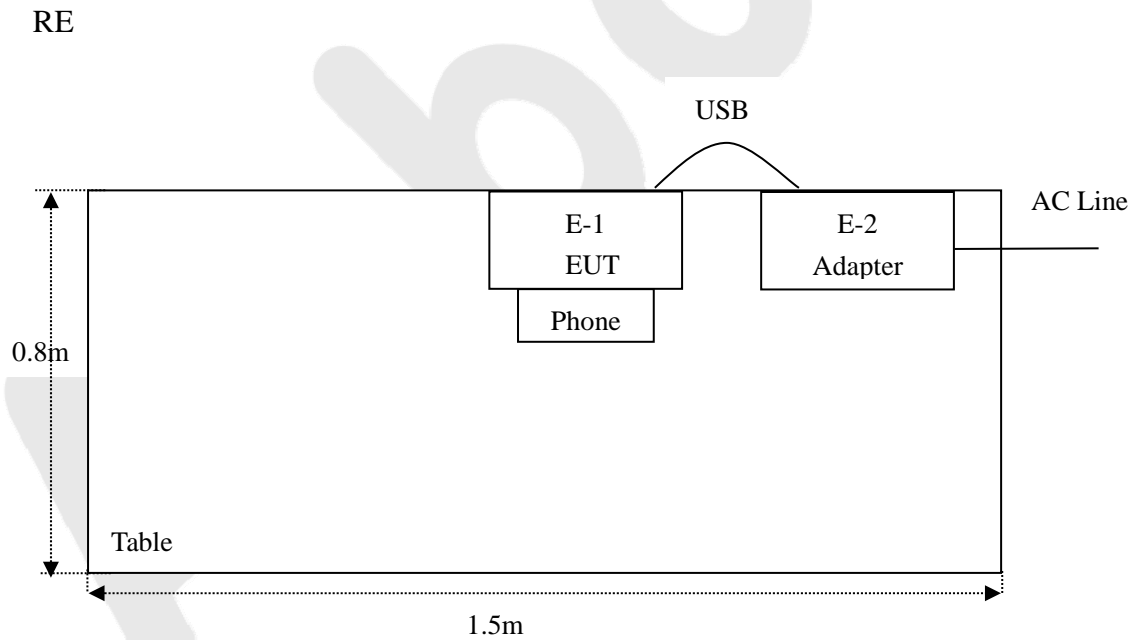
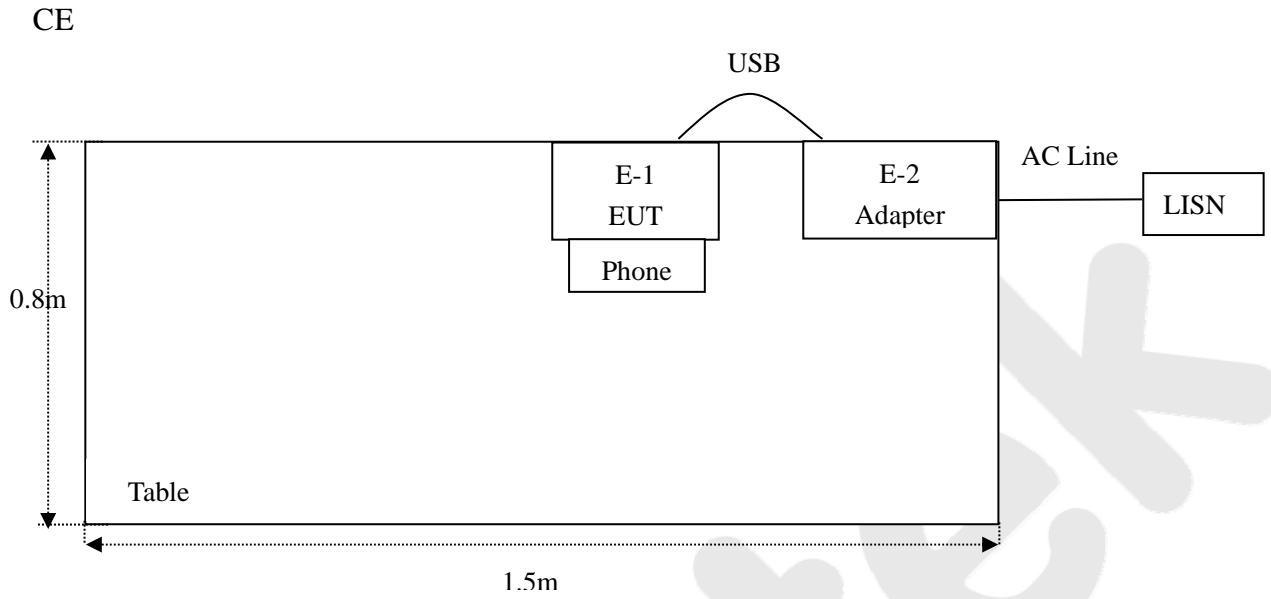

1.7. Test Equipment List

| Item | Equipment | Manufacturer | Model No. | Serial No. | Last Cal. | Cal. Interval |
|------|------------------------------------------|----------------------------|----------------|---------------|---------------|---------------|
| 1. | L.I.S.N. Artificial Mains Network | Rohde & Schwarz | ENV216 | 100055 | Nov. 17, 2017 | 1 Year |
| 2. | EMI Test Receiver | Rohde & Schwarz | ESCI | 100627 | Nov. 17, 2017 | 1 Year |
| 3. | RF Switching Unit | Compliance Direction | RSU-M2 | 38303 | Nov. 17, 2017 | 1 Year |
| 4. | Spectrum Analysis | Agilent | E4407B | US39390582 | Nov. 17, 2017 | 1 Year |
| 5. | Spectrum Analysis | Agilent | N9038A | MY53227295 | Nov. 17, 2017 | 1 Year |
| 6. | Preamplifier | SKET Electronic | BK1G18G30 D | KD17503 | Nov. 17, 2017 | 1 Year |
| 7. | EMI Test Receiver | Rohde & Schwarz | ESPI | 101604 | Nov. 17, 2017 | 1 Year |
| 8. | Double Ridged Horn Antenna | Instruments corporation | GTH-0118 | 351600 | Nov. 20, 2017 | 1 Year |
| 9. | Bilog Broadband Antenna | Schwarzbeck | VULB9163 | VULB 9163-289 | Nov. 20, 2017 | 1 Year |
| 10. | Loop Antenna | Schwarzbeck | HFH2-Z2 | 100047 | Nov. 17, 2017 | 1 Year |
| 11. | Horn Antenna | Schwarzbeck | BBHA9170 | 9170-375 | Nov. 17, 2017 | 1 Year |
| 12. | Pre-amplifier | SONOMA | 310N | 186860 | Nov. 17, 2017 | 1 Year |
| 13. | EMI Test Software EZ-EMC | SHURPLE | N/A | N/A | N/A | N/A |
| 14. | RF Test Control System | YIHENG | YH3000 | 2017430 | Nov. 18, 2017 | 1 Year |
| 15. | Power Sensor | DAER | RPR3006W | 15I00041SN045 | Nov. 17, 2017 | 1 Year |
| 16. | Power Sensor | DAER | RPR3006W | 15I00041SN046 | Nov. 17, 2017 | 1 Year |
| 17. | MXA Spectrum Analysis | Agilent | N9020A | MY51170037 | Nov. 18, 2017 | 1 Year |
| 18. | MXG RF Vector Signal Generator | Agilent | N5182A | MY48180656 | Nov. 18, 2017 | 1 Year |
| 19. | Signal Generator | Agilent | E4421B | MY41000743 | Nov. 18, 2017 | 1 Year |
| 20. | DC Power Supply | LW | TPR-6410D | 349315 | Nov. 01, 2017 | 1 Year |
| 21. | Constant Temperature Humidity Chamber | Sertep | ZJ-HWHS80 B | ZJ-17042804 | Nov. 01, 2017 | 1 Year |

1.8. Measurement Uncertainty

| | | |
|------------------------|---|--------------------------|
| Radiation Uncertainty | : | Ur = 4.1 dB (Horizontal) |
| | | Ur = 4.3 dB (Vertical) |
| | | |
| Conduction Uncertainty | : | Uc = 3.4dB |

1.9. Description of Test Facility

The test facility is recognized, certified, or accredited by the following organizations:

FCC-Registration No.: 184111

Shenzhen Anbotek Compliance Laboratory Limited, EMC Laboratory has been registered and fully described in a report filed with the (FCC) Federal Communications Commission. The acceptance letter from the FCC is maintained in our files. Registration No. 184111, July 31, 2017.

ISED-Registration No.: 8058A-1

Shenzhen Anbotek Compliance Laboratory Limited, EMC Laboratory has been registered and fully described in a report filed with the (ISED) Innovation, Science and Economic Development Canada. The acceptance letter from the ISED is maintained in our files. Registration 8058A-1, June 13, 2016.

Test Location

All Emissions tests were performed at Shenzhen Anbotek Compliance Laboratory Limited. at 1/F, Building D, Sogood Science and Technology Park, Sanwei community, Hangcheng Street, Bao'an District, Shenzhen, Guangdong, China.518102

2. Summary of Test Results

| Standard Section | Test Item | Result |
|-------------------------------------|-------------------------|--------|
| FCC Part 15, Paragraph 15.207 | Conducted Emission Test | PASS |
| FCC Part 15, Paragraph 15.209(a)(f) | Spurious Emission | PASS |

Anbotek

3. Conducted Emission Test

3.1. Test Standard and Limit

| Test Standard | FCC Part15 Section 15.207 | | |
|---------------|---------------------------|--------------------------------|---------------|
| Test Limit | Frequency | Maximum RF Line Voltage (dBuV) | |
| | | Quasi-peak Level | Average Level |
| | 150kHz~500kHz | 66 ~ 56 * | 56 ~ 46 * |
| | 500kHz~5MHz | 56 | 46 |
| 5MHz~30MHz | 60 | 50 | |

Remark: (1) *Decreasing linearly with logarithm of the frequency.
(2) The lower limit shall apply at the transition frequency.

3.2. Test Setup

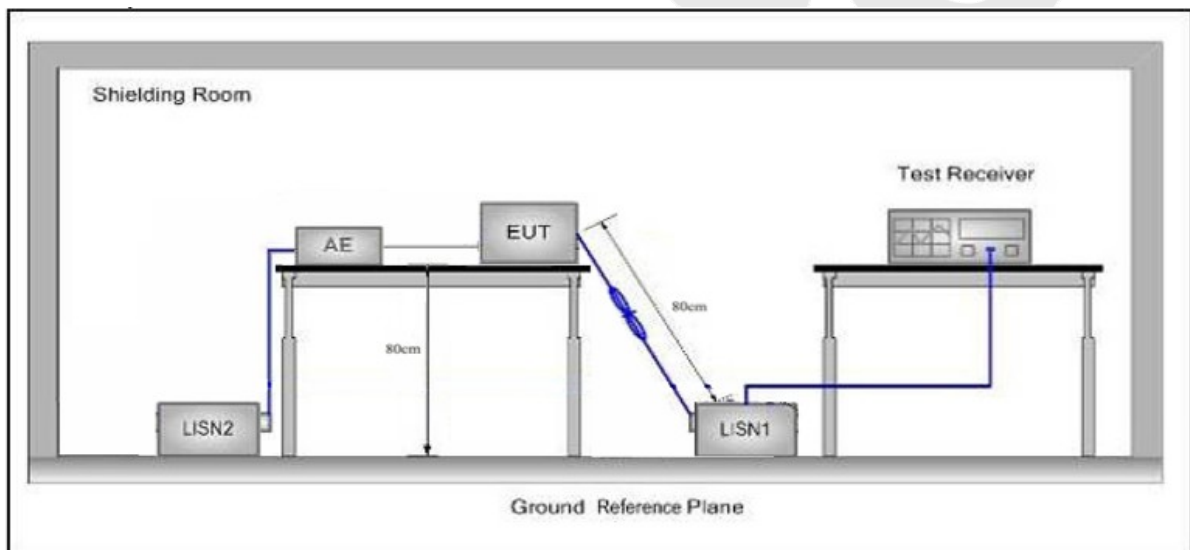

3.3. Test Procedure

The EUT system is connected to the power mains through a line impedance stabilization network (L.I.S.N.). This provides a 50ohm coupling impedance for the EUT system. Please refer the block diagram of the test setup and photographs. Both sides of AC line are checked to find out the maximum conducted emission. In order to find the maximum emission levels, the relative positions of equipment and all of the interface cables shall be changed according to FCC ANSI C63.10-2013 on Conducted Emission Measurement.

The bandwidth of test receiver (ESCI) set at 9kHz.

The frequency range from 150kHz to 30MHz is checked.

3.4. Test Data

Please to see the following pages

Conducted Emission Test Data

Test Site: 1# Shielded Room
 Operating Condition: Keeping TX+Charging mode
 Test Specification: AC 120V, 60Hz for adapter
 Comment: Live Line
 Tem.:25.4°C Hum.:54%

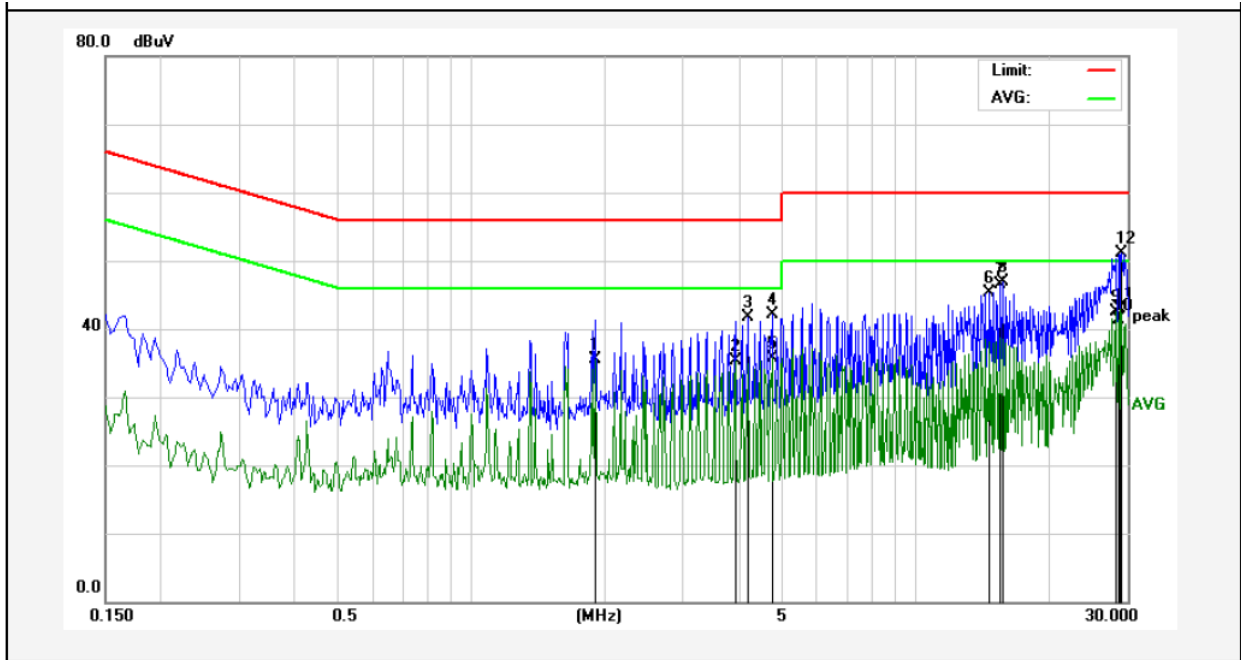

| No. | Freq. (MHz) | Reading (dBuV) | Factor (dB) | Result (dBuV) | Limit dBuV | Over Limit (dB) | Detector | Remark |
|-----|-------------|----------------|-------------|---------------|------------|-----------------|----------|--------|
| 1 | 1.9020 | 15.41 | 20.14 | 35.55 | 46.00 | -10.45 | AVG | |
| 2 | 3.9380 | 15.10 | 20.18 | 35.28 | 46.00 | -10.72 | AVG | |
| 3 | 4.2100 | 21.51 | 20.19 | 41.70 | 56.00 | -14.30 | QP | |
| 4 | 4.7540 | 21.82 | 20.20 | 42.02 | 56.00 | -13.98 | QP | |
| 5 | 4.7540 | 15.56 | 20.20 | 35.76 | 46.00 | -10.24 | AVG | |
| 6 | 14.6780 | 25.06 | 20.27 | 45.33 | 60.00 | -14.67 | QP | |
| 7 | 15.4900 | 26.23 | 20.27 | 46.50 | 60.00 | -13.50 | QP | |
| 8 | 15.7620 | 26.55 | 20.27 | 46.82 | 60.00 | -13.18 | QP | |
| 9 | 28.3900 | 22.25 | 20.27 | 42.52 | 50.00 | -7.48 | AVG | |
| 10 | 28.6620 | 21.01 | 20.27 | 41.28 | 50.00 | -8.72 | AVG | |
| 11 | 28.9340 | 22.69 | 20.27 | 42.96 | 50.00 | -7.04 | AVG | |
| 12 | 29.2020 | 30.91 | 20.27 | 51.18 | 60.00 | -8.82 | QP | |

Conducted Emission Test Data

Test Site: 1# Shielded Room
 Operating Condition: Keeping TX+Charging mode
 Test Specification: AC 120V, 60Hz for adapter
 Comment: Neutral Line
 Tem.:25.4°C Hum.:54%

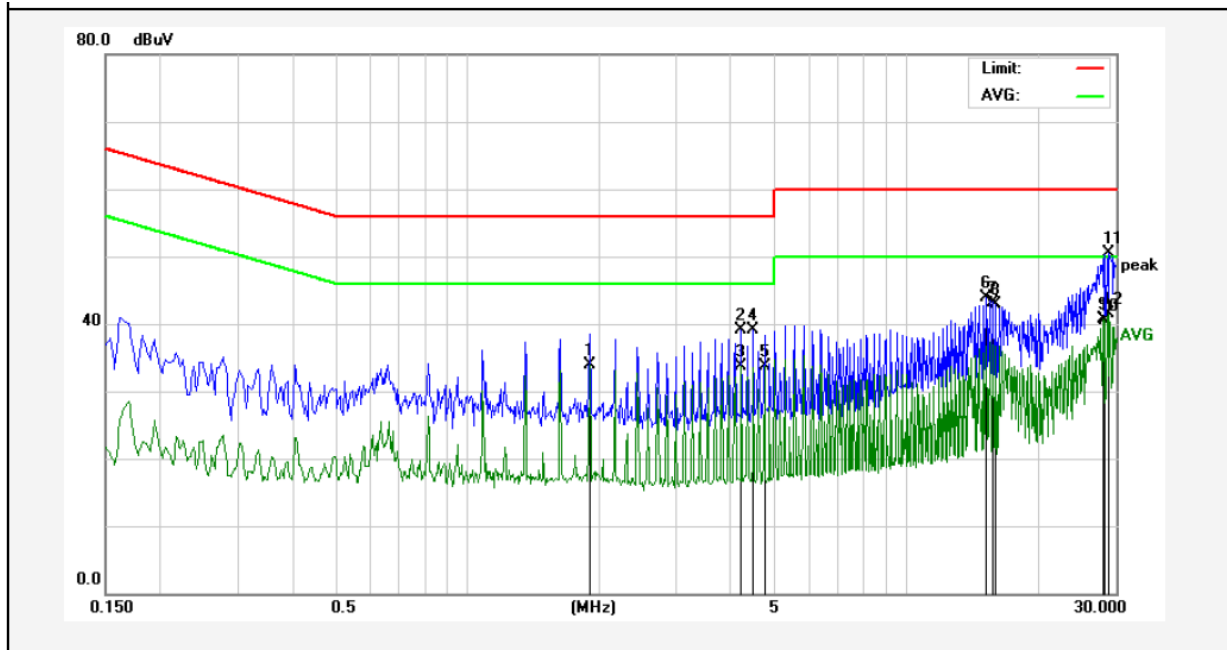

| No. | Freq. (MHz) | Reading (dBuV) | Factor (dB) | Result (dBuV) | Limit dBuV | Over Limit (dB) | Detector | Remark |
|-----|-------------|----------------|-------------|---------------|------------|-----------------|----------|--------|
| 1 | 1.9020 | 13.67 | 20.14 | 33.81 | 46.00 | -12.19 | AVG | |
| 2 | 4.2100 | 18.87 | 20.19 | 39.06 | 56.00 | -16.94 | QP | |
| 3 | 4.2100 | 13.56 | 20.19 | 33.75 | 46.00 | -12.25 | AVG | |
| 4 | 4.4820 | 18.83 | 20.19 | 39.02 | 56.00 | -16.98 | QP | |
| 5 | 4.7540 | 13.55 | 20.20 | 33.75 | 46.00 | -12.25 | AVG | |
| 6 | 15.2100 | 23.62 | 20.26 | 43.88 | 60.00 | -16.12 | QP | |
| 7 | 15.7540 | 22.93 | 20.27 | 43.20 | 60.00 | -16.80 | QP | |
| 8 | 16.0220 | 22.53 | 20.28 | 42.81 | 60.00 | -17.19 | QP | |
| 9 | 28.1020 | 20.34 | 20.27 | 40.61 | 50.00 | -9.39 | AVG | |
| 10 | 28.3740 | 20.29 | 20.27 | 40.56 | 50.00 | -9.44 | AVG | |
| 11 | 28.9140 | 30.29 | 20.27 | 50.56 | 60.00 | -9.44 | QP | |
| 12 | 28.9140 | 21.32 | 20.27 | 41.59 | 50.00 | -8.41 | AVG | |

Conducted Emission Test Data

Test Site: 1# Shielded Room
 Operating Condition: Keeping TX+Charging mode
 Test Specification: AC 240V, 60Hz for adapter
 Comment: Live Line
 Tem.:25.4°C Hum.:54%

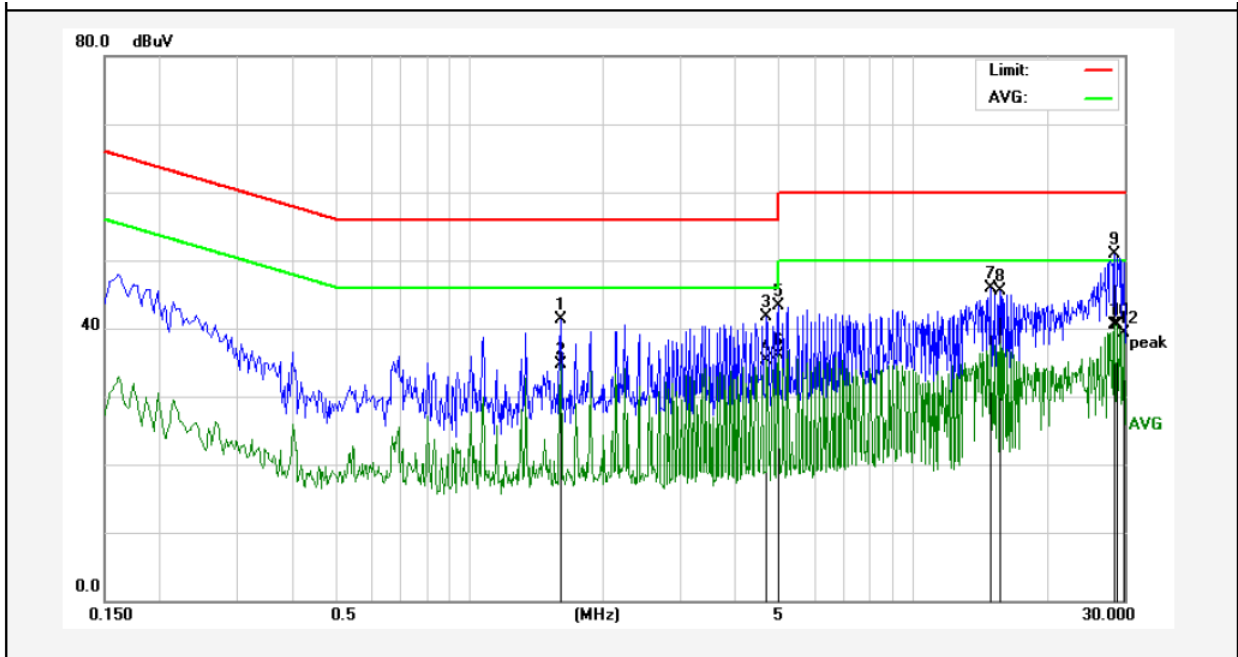

| No. | Freq. (MHz) | Reading (dBuV) | Factor (dB) | Result (dBuV) | Limit dBuV | Over Limit (dB) | Detector | Remark |
|-----|-------------|----------------|-------------|---------------|------------|-----------------|----------|--------|
| 1 | 1.6060 | 21.21 | 20.13 | 41.34 | 56.00 | -14.66 | QP | |
| 2 | 1.6060 | 14.57 | 20.13 | 34.70 | 46.00 | -11.30 | AVG | |
| 3 | 4.6859 | 21.58 | 20.20 | 41.78 | 56.00 | -14.22 | QP | |
| 4 | 4.6859 | 15.13 | 20.20 | 35.33 | 46.00 | -10.67 | AVG | |
| 5 | 4.9539 | 23.03 | 20.21 | 43.24 | 56.00 | -12.76 | QP | |
| 6 | 4.9539 | 15.81 | 20.21 | 36.02 | 46.00 | -9.98 | AVG | |
| 7 | 14.9739 | 25.58 | 20.26 | 45.84 | 60.00 | -14.16 | QP | |
| 8 | 15.7819 | 25.17 | 20.27 | 45.44 | 60.00 | -14.56 | QP | |
| 9 | 28.5180 | 30.69 | 20.27 | 50.96 | 60.00 | -9.04 | QP | |
| 10 | 28.5180 | 20.16 | 20.27 | 40.43 | 50.00 | -9.57 | AVG | |
| 11 | 28.7860 | 20.26 | 20.27 | 40.53 | 50.00 | -9.47 | AVG | |
| 12 | 29.8540 | 19.00 | 20.27 | 39.27 | 50.00 | -10.73 | AVG | |

Conducted Emission Test Data

Test Site: 1# Shielded Room
 Operating Condition: Keeping TX+Charging mode
 Test Specification: AC 240V, 60Hz for adapter
 Comment: Neutral Line
 Tem.:25.4°C Hum.:54%

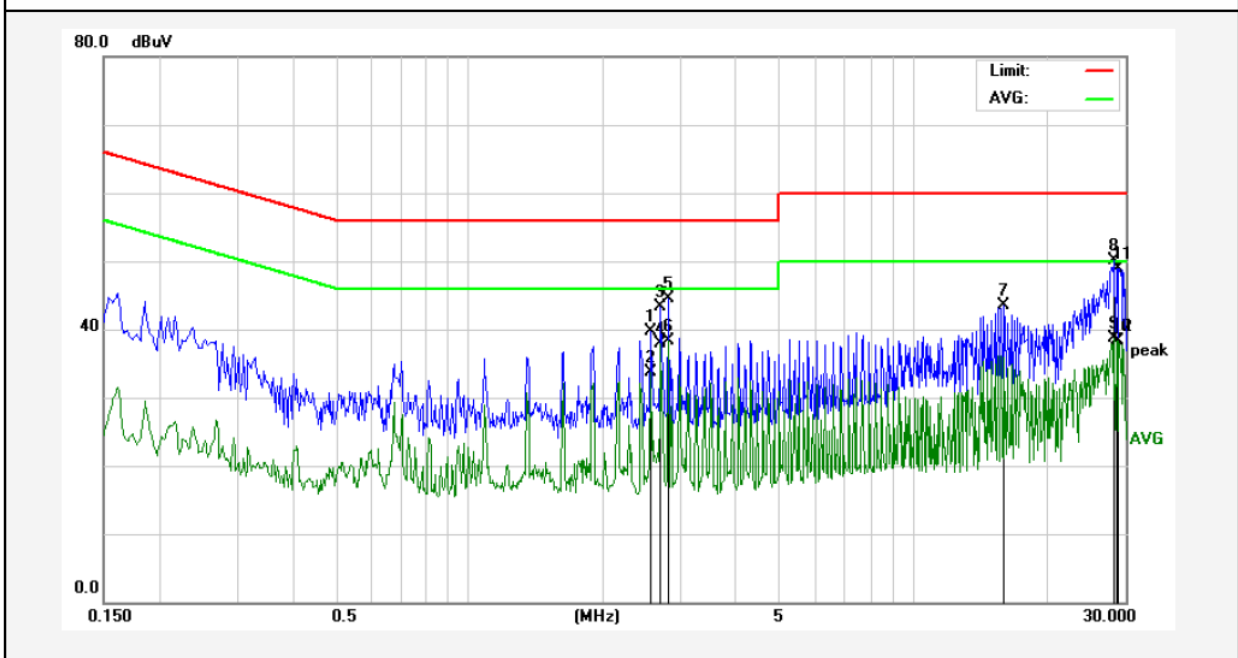

| No. | Freq. (MHz) | Reading (dBuV) | Factor (dB) | Result (dBuV) | Limit dBuV | Over Limit (dB) | Detector | Remark |
|-----|-------------|----------------|-------------|---------------|------------|-----------------|----------|--------|
| 1 | 2.5620 | 19.63 | 20.15 | 39.78 | 56.00 | -16.22 | QP | |
| 2 | 2.5620 | 13.52 | 20.15 | 33.67 | 46.00 | -12.33 | AVG | |
| 3 | 2.6980 | 23.11 | 20.15 | 43.26 | 56.00 | -12.74 | QP | |
| 4 | 2.6980 | 17.80 | 20.15 | 37.95 | 46.00 | -8.05 | AVG | |
| 5 | 2.8060 | 24.34 | 20.16 | 44.50 | 56.00 | -11.50 | QP | |
| 6 | 2.8100 | 18.11 | 20.16 | 38.27 | 46.00 | -7.73 | AVG | |
| 7 | 16.0380 | 23.22 | 20.28 | 43.50 | 60.00 | -16.50 | QP | |
| 8 | 28.4020 | 29.75 | 20.27 | 50.02 | 60.00 | -9.98 | QP | |
| 9 | 28.4020 | 18.36 | 20.27 | 38.63 | 50.00 | -11.37 | AVG | |
| 10 | 28.6700 | 18.10 | 20.27 | 38.37 | 50.00 | -11.63 | AVG | |
| 11 | 28.9420 | 28.71 | 20.27 | 48.98 | 60.00 | -11.02 | QP | |
| 12 | 28.9420 | 17.99 | 20.27 | 38.26 | 50.00 | -11.74 | AVG | |

4. Radiation Spurious Emission and Band Edge

4.1. Test Standard and Limit

| Test Standard | FCC Part15 C Section 15.209 and 15.205 | | | | |
|---------------|----------------------------------------|----------------------------------|----------------|------------|--------------------------|
| Test Limit | Frequency (MHz) | Field strength (microvolt/meter) | Limit (dBuV/m) | Remark | Measurement distance (m) |
| | 0.009MHz~0.490MHz | 2400/F(kHz) | - | - | 300 |
| | 0.490MHz-1.705MHz | 24000/F(kHz) | - | - | 30 |
| | 1.705MHz-30MHz | 30 | - | - | 30 |
| | 30MHz~88MHz | 100 | 40.0 | Quasi-peak | 3 |
| | 88MHz~216MHz | 150 | 43.5 | Quasi-peak | 3 |
| | 216MHz~960MHz | 200 | 46.0 | Quasi-peak | 3 |
| | 960MHz~1000MHz | 500 | 54.0 | Quasi-peak | 3 |
| | | | 54.0 | Average | 3 |
| Above 1000MHz | - | 74.0 | Peak | 3 | |

Remark:

(1)The lower limit shall apply at the transition frequency.

(2) 15.35(b), Unless otherwise specified, the limit on peak radio frequency emissions is 20dB above the maximum permitted average emission limit applicable to the equipment under test. This peak limit applies to the total peak emission level radiated by the device.

4.2. Test Setup

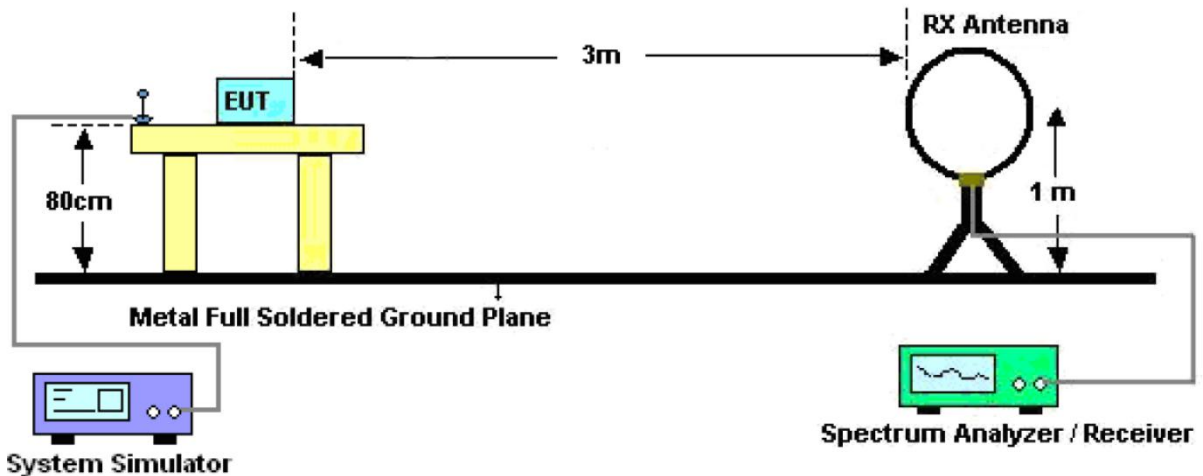

Figure 1. Below 30MHz

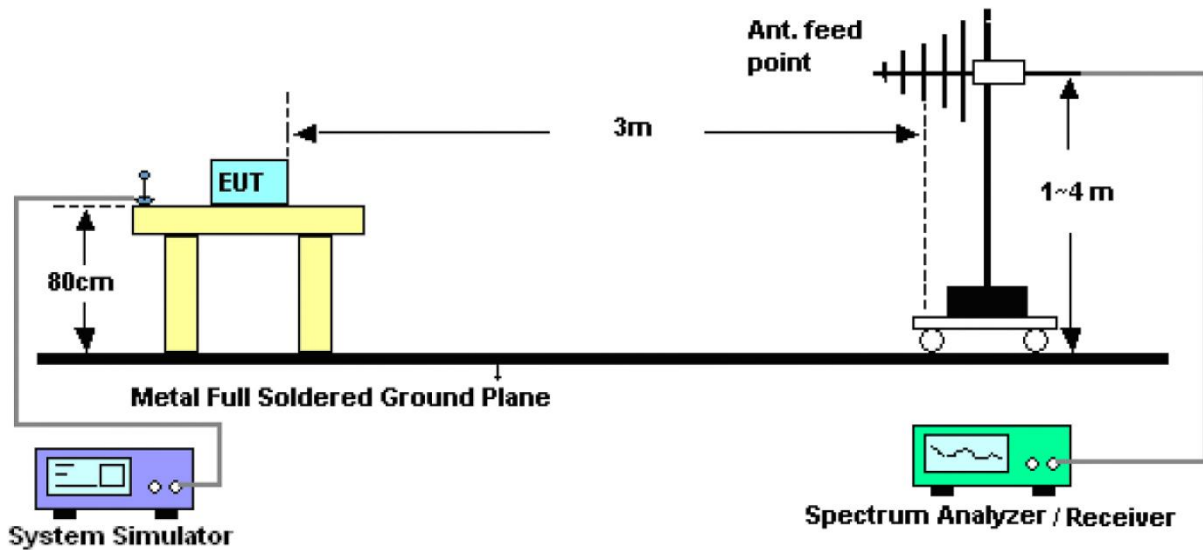

Figure 2. 30MHz to 1GHz

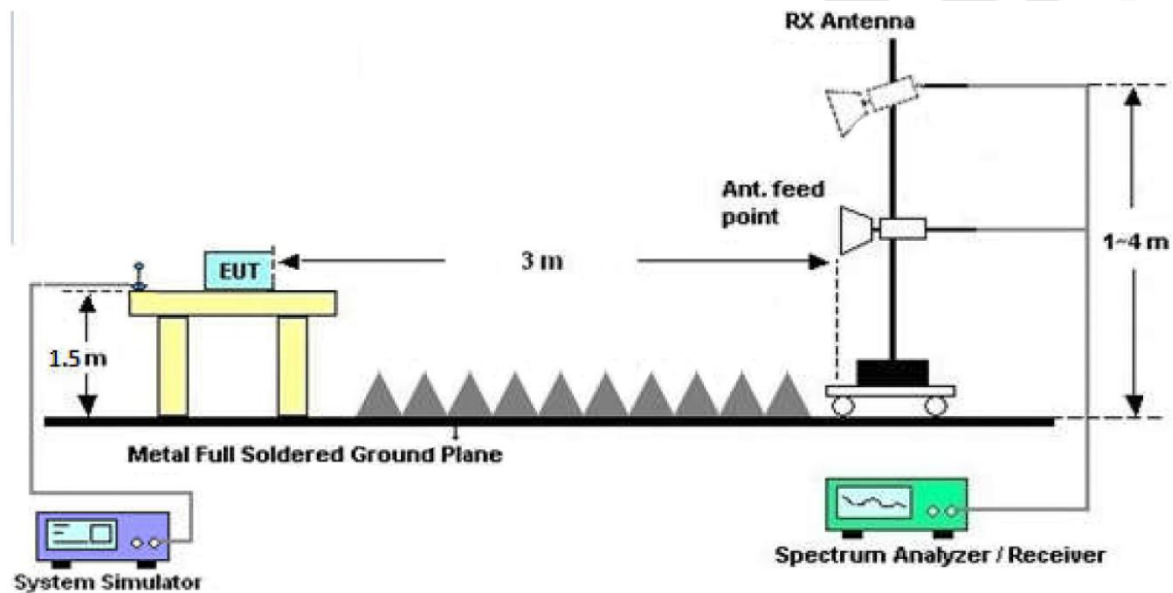

Figure 3. Above 1 GHz

4.3. Test Procedure

For below 1GHz: The EUT is placed on a turntable, which is 0.8m above the ground plane.

For above 1GHz: The EUT is placed on a turntable, which is 1.5m above the ground plane.

The turn table can rotate 360 degrees to determine the position of the maximum emission level. The EUT is set 3 meters away from the receiving antenna which is mounted on a antenna tower. The antenna can be moved up and down from 1 to 4 meters to find out the maximum emission level. Rotated the EUT through three orthogonal axes to determine the maximum emissions, both horizontal and vertical polarization of the antenna are set on test. The EUT is tested in 9*6*6 Chamber. The device is evaluated in xyz orientation.

For 9kHz to 150kHz, Set the spectrum analyzer as:

RBW = 200Hz, VBW =1kHz, Detector= Quasi-Peak, Trace mode= Max hold, Sweep- auto couple.

For 150kHz to 30MHz, Set the spectrum analyzer as:

RBW = 9KHz, VBW =30kHz, Detector= Quasi-Peak, Trace mode= Max hold, Sweep- auto couple.

For 30MHz to 1000MHz, Set the spectrum analyzer as:

RBW = 100kHz, VBW =300kHz, Detector= Quasi-Peak, Trace mode= Max hold, Sweep- auto couple.

4.4. Test Data

PASS

Anbotek

Test Results

(Between 9KHz – 30MHz)

| | | | |
|-------------------|--------------------------|----------------------------|----------------------------------|
| Job No.: | SZAWW180206003-01 | | |
| Standard: | FCC PART15 C _3m | Power Source: | AC 120V, 60Hz for adapter |
| Test item: | Radiation Test | Temp.(C)/Hum.(%RH): | 24.4(C)/50%RH |
| Test Mode: | Mode 4 | Distance: | 3m |

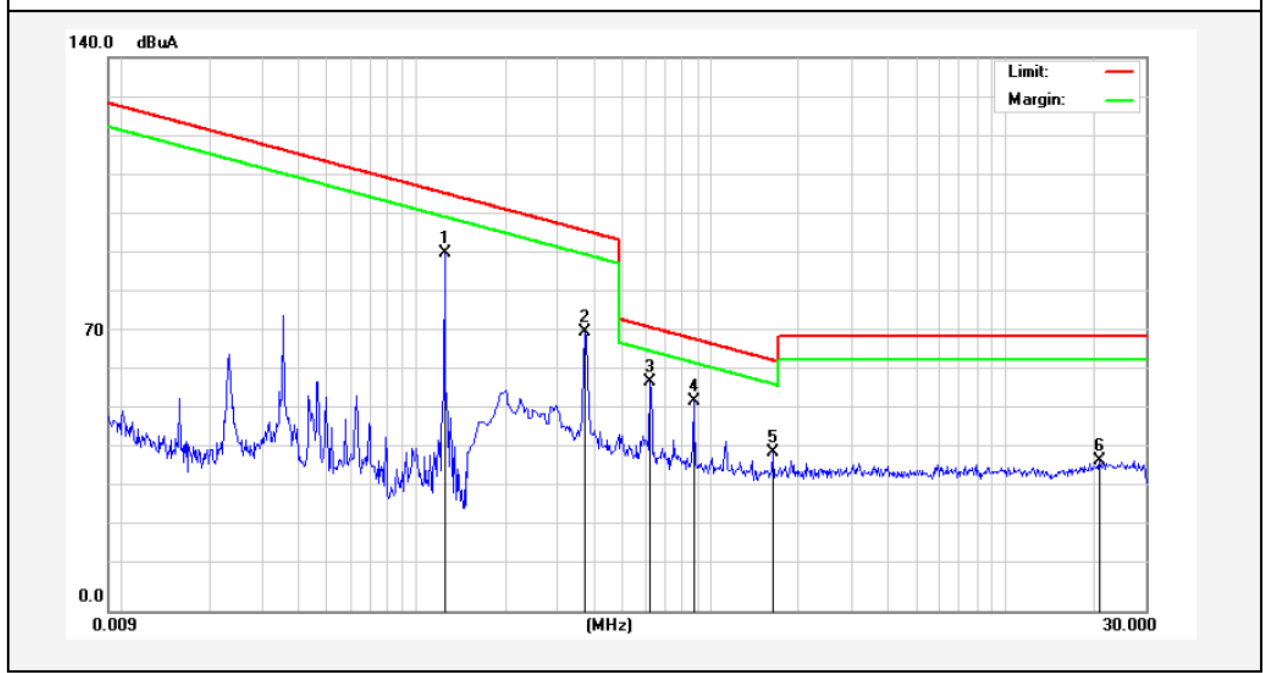

| Frequency (MHz) | Read Level (dBuV) | Antenna Factor (dB/m) | Cable Loss (dB) | Preamp Factor (dB) | Level (dBuV/m) | Limit (dBuV/m) | Over Limit (dB) | Detector | degree |
|-----------------|-------------------|-----------------------|-----------------|--------------------|----------------|----------------|-----------------|----------|--------|
| | | | | | | | | | (dgc) |
| 0.1253 | 73.84 | 19.30 | 2.54 | 0 | 95.68 | 125.61 | -29.93 | Peak | 41 |
| 0.1253 | 68.60 | 19.30 | 2.54 | 0 | 90.44 | 105.61 | -15.17 | AV | 41 |
| 0.3740 | 57.62 | 19.53 | 2.59 | 0 | 79.74 | 116.14 | -36.40 | Peak | 53 |
| 0.3740 | 49.47 | 19.53 | 2.59 | 0 | 71.59 | 96.14 | -24.55 | AV | 53 |
| 0.6260 | 35.04 | 20.35 | 2.62 | 0 | 58.01 | 71.67 | -13.66 | Peak | 144 |
| 0.8780 | 29.82 | 20.55 | 2.71 | 0 | 53.08 | 68.73 | -15.65 | Peak | 144 |
| 1.6300 | 16.23 | 21.03 | 2.90 | 0 | 40.16 | 63.36 | -23.20 | Peak | 321 |
| 20.8860 | 11.94 | 21.34 | 4.68 | 0 | 37.96 | 69.54 | -31.58 | Peak | 222 |

Remark: According to FCC PART 15.209 (d), the emission limits for the frequency bands 9–90 kHz, 110–490 kHz and above 1000 MHz, Radiated emission limits in these three bands are based on measurements employing an average detector.

(Between 30MHz –1000 MHz)

| | | | |
|-------------------|--------------------------|----------------------------|----------------------------------|
| Job No.: | SZAWW180206003-01 | Polarization: | Horizontal |
| Standard: | FCC PART15 C _3m | Power Source: | AC 120V, 60Hz for adapter |
| Test item: | Radiation Test | Temp.(C)/Hum.(%RH): | 24.4(C)/50%RH |
| Test Mode: | Mode 4 | Distance: | 3m |

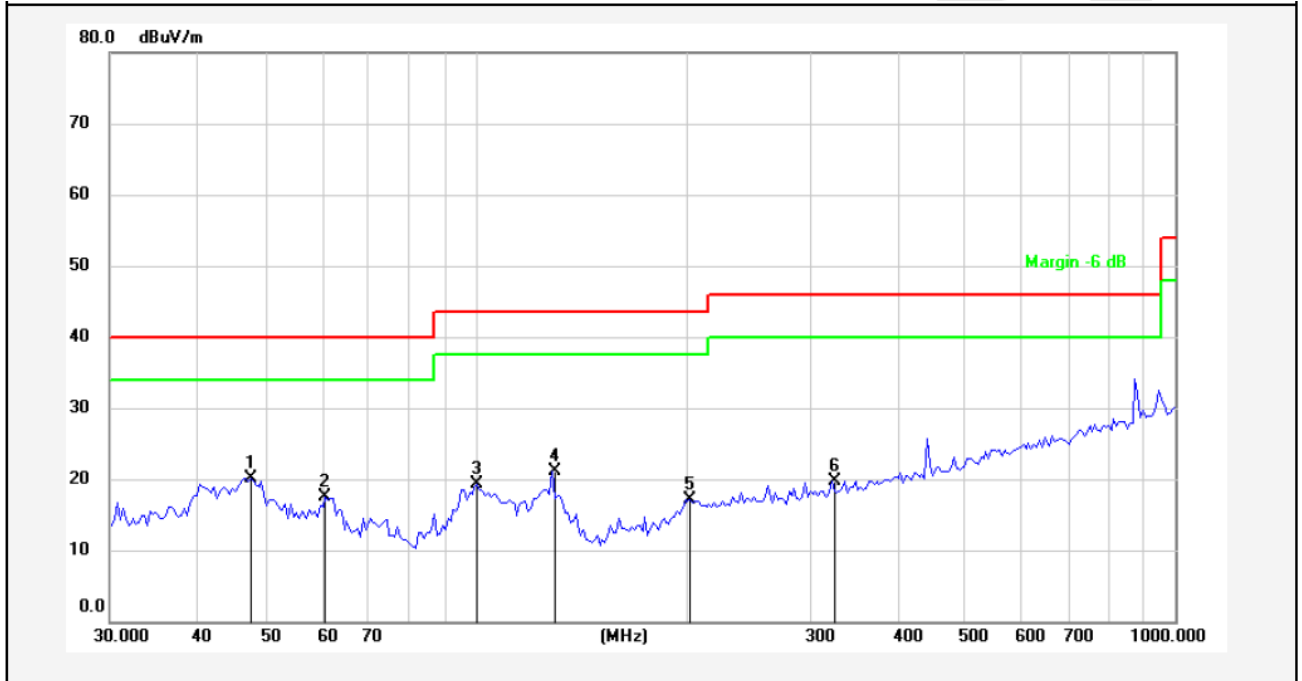

| No. | Freq. (MHz) | Reading (dBuV/m) | Factor () | Result (dBuV/m) | Limit (dBuV/) | Over Limit (dB) | Detector | Height (cm) | degree (deg) | Remark |
|-----|-------------|------------------|------------|-----------------|---------------|-----------------|----------|-------------|--------------|--------|
| 1 | 47.7422 | 35.12 | -14.92 | 20.20 | 40.00 | -19.80 | QP | 300 | 66 | |
| 2 | 61.0245 | 33.99 | -16.57 | 17.42 | 40.00 | -22.58 | QP | 300 | 97 | |
| 3 | 100.5806 | 36.11 | -16.72 | 19.39 | 43.50 | -24.11 | QP | 300 | 115 | |
| 4 | 128.5630 | 40.63 | -19.55 | 21.08 | 43.50 | -22.42 | QP | 300 | 213 | |
| 5 | 202.8103 | 33.29 | -16.13 | 17.16 | 43.50 | -26.34 | QP | 300 | 265 | |
| 6 | 322.7540 | 32.81 | -13.11 | 19.70 | 46.00 | -26.30 | QP | 300 | 297 | |

| | | | |
|-------------------|--------------------------|----------------------------|----------------------------------|
| Job No.: | SZAWW180206003-01 | Plarization: | Vertical |
| Standard: | FCC PART15 C _3m | Power Source: | AC 120V, 60Hz for adapter |
| Test item: | Radiation Test | Temp.(C)/Hum.(%RH): | 24.4(C)/50%RH |
| Test Mode: | Mode 4 | Distance: | 3m |

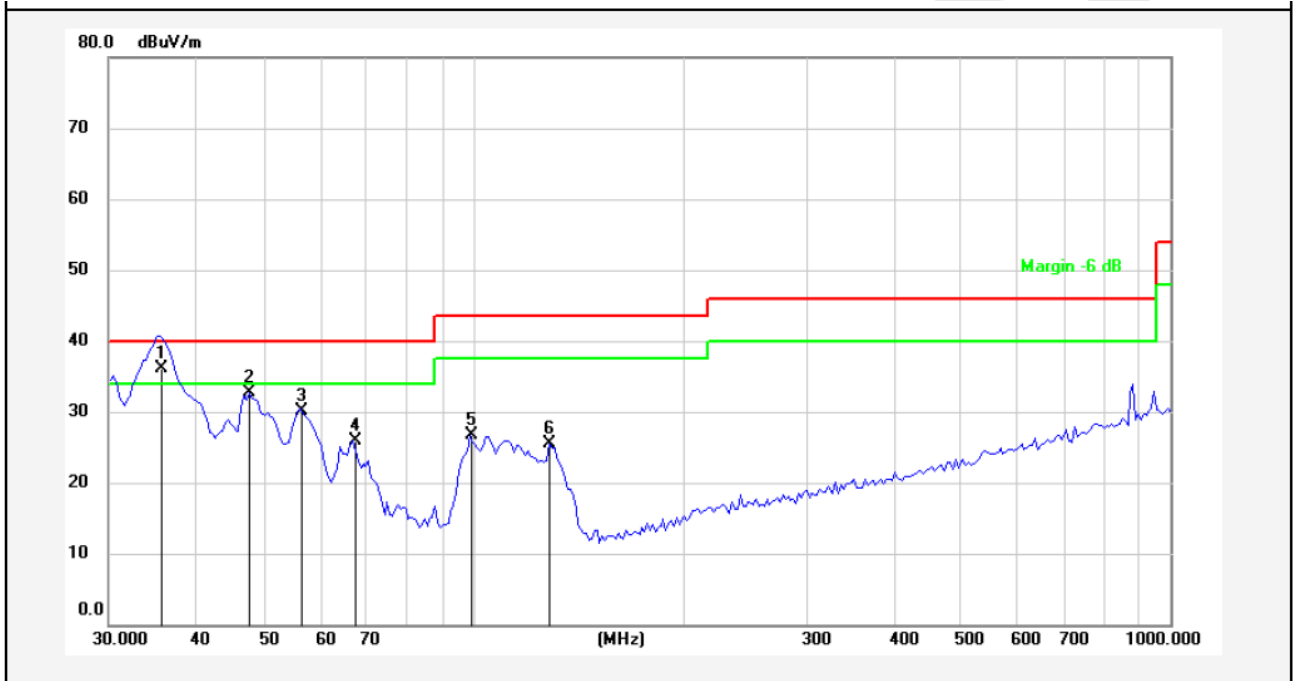

| No. | Freq. (MHz) | Reading (dBuV/m) | Factor () | Result (dBuV/m) | Limit (dBuV/) | Over Limit (dB) | Detector | Height (cm) | degree (deg) | Remark |
|-----|-------------|------------------|------------|-----------------|---------------|-----------------|----------|-------------|--------------|--------|
| 1 | 35.6371 | 53.49 | -17.33 | 36.16 | 40.00 | -3.84 | QP | 300 | 16 | |
| 2 | 47.7422 | 47.71 | -14.92 | 32.79 | 40.00 | -7.21 | QP | 300 | 77 | |
| 3 | 56.8913 | 46.02 | -15.87 | 30.15 | 40.00 | -9.85 | QP | 300 | 114 | |
| 4 | 67.2022 | 43.96 | -18.03 | 25.93 | 40.00 | -14.07 | QP | 300 | 152 | |
| 5 | 98.8326 | 43.50 | -16.86 | 26.64 | 43.50 | -16.86 | QP | 300 | 210 | |
| 6 | 128.5629 | 45.04 | -19.55 | 25.49 | 43.50 | -18.01 | QP | 300 | 263 | |

APPENDIX I -- TEST SETUP PHOTOGRAPH

Photo of Conducted Emission Measurement



Photo of Radiation Emission Test

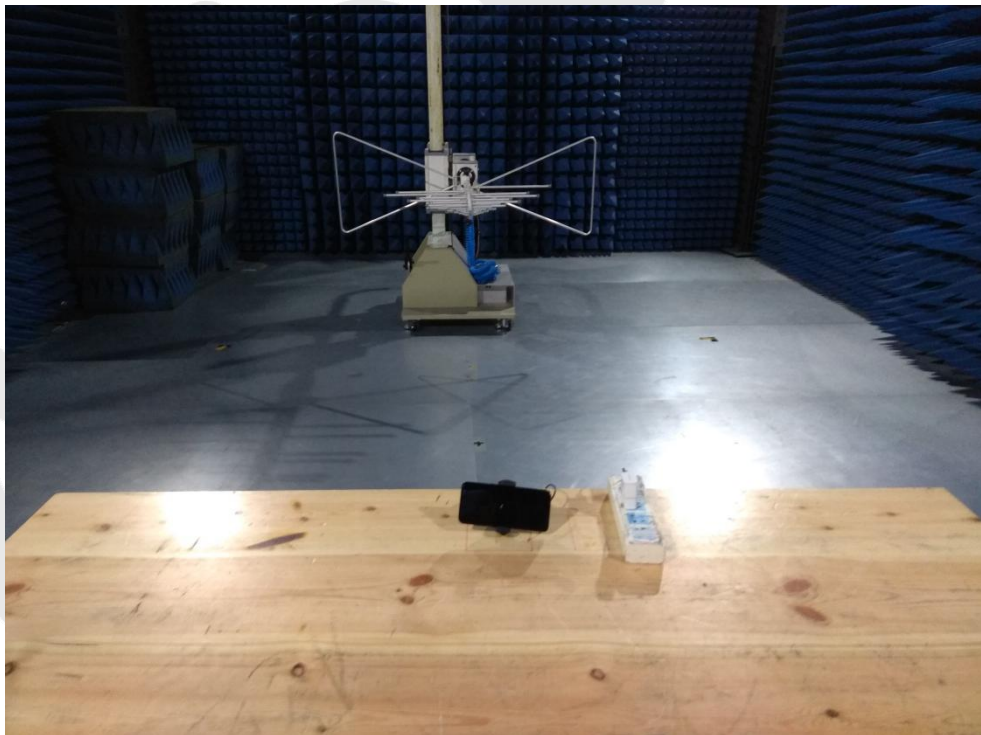

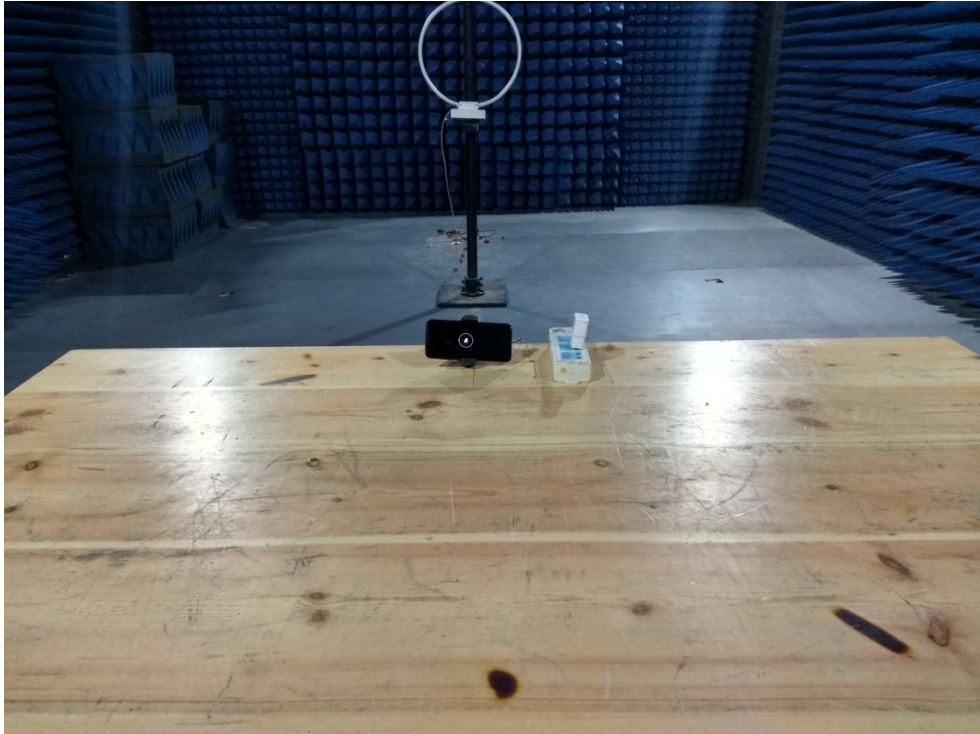

APPENDIX II -- EXTERNAL PHOTOGRAPH



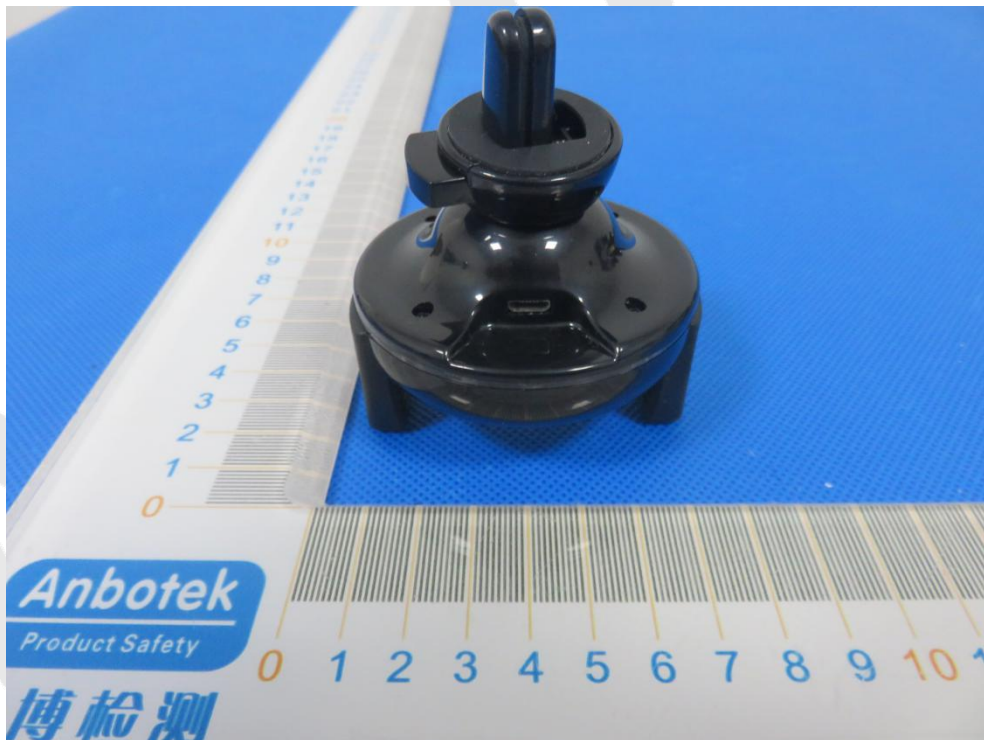
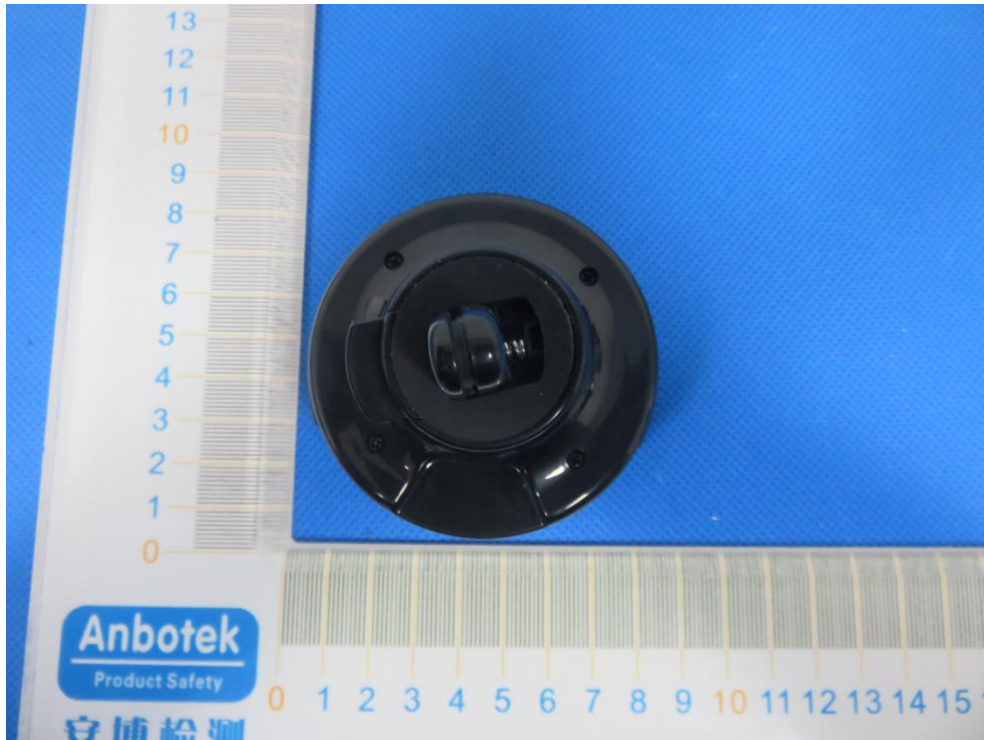





Anbotek

APPENDIX III -- INTERNAL PHOTOGRAPH

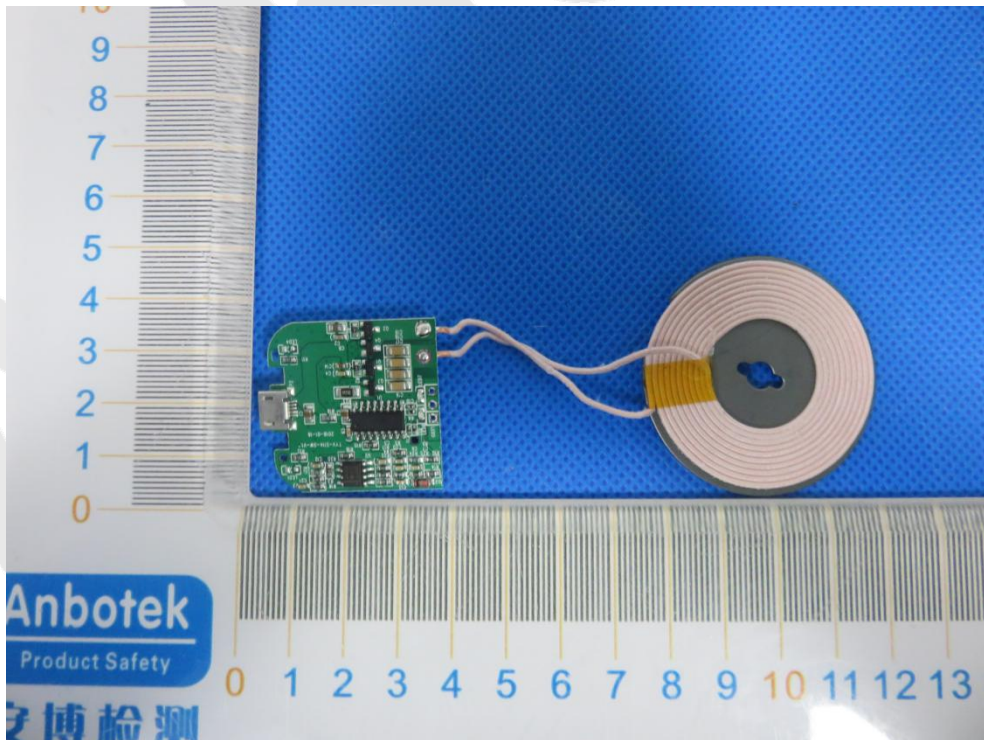

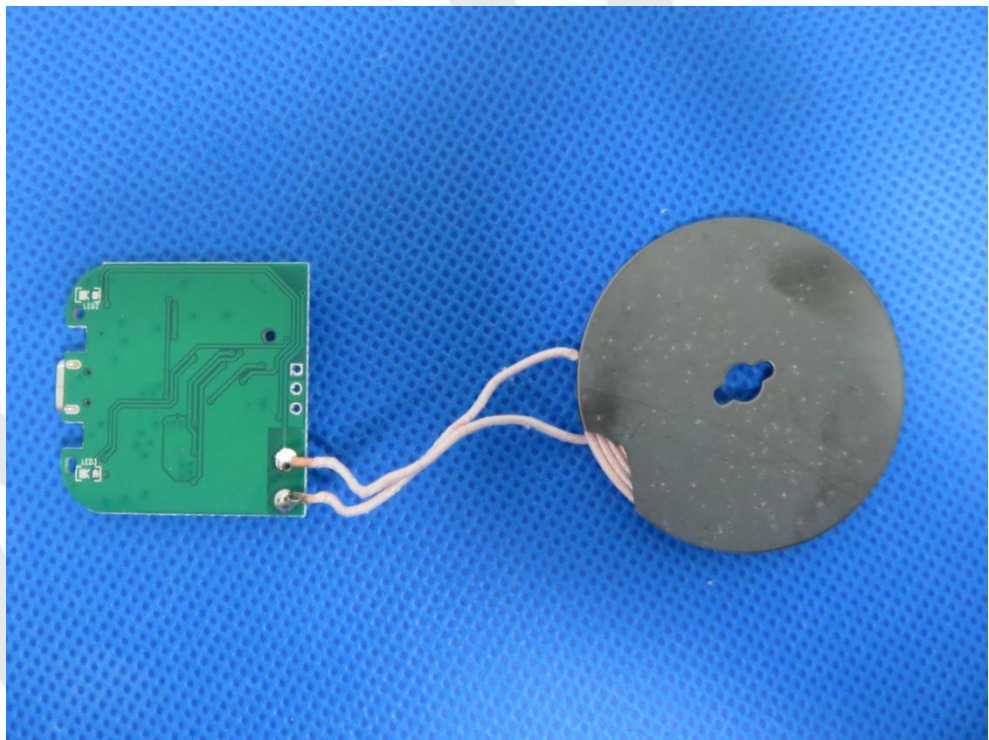
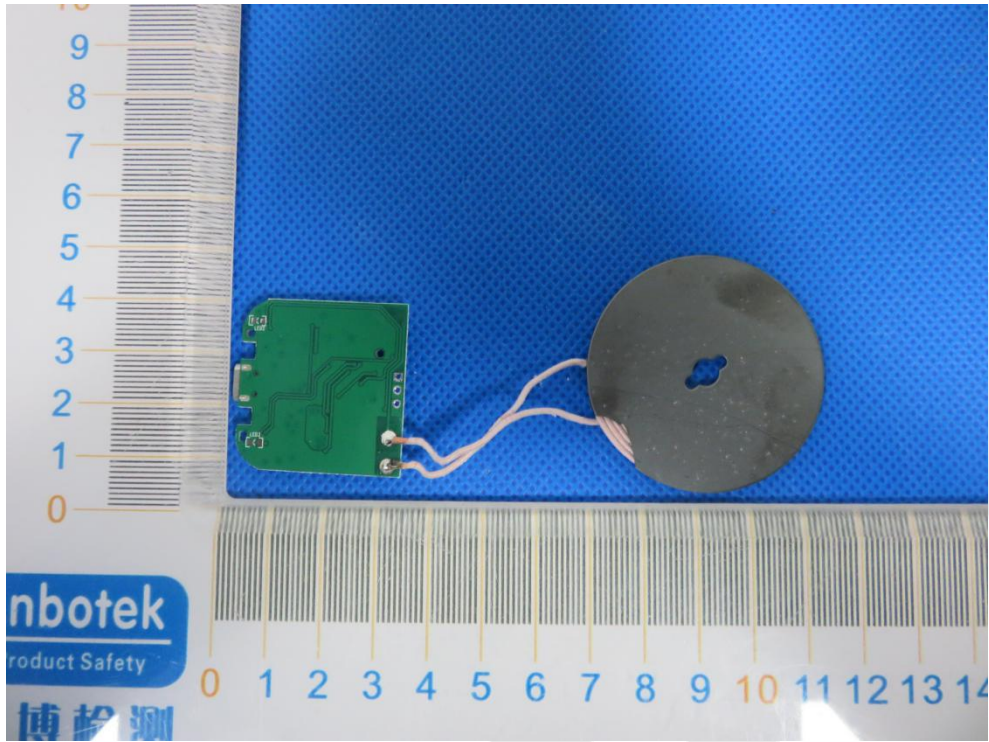

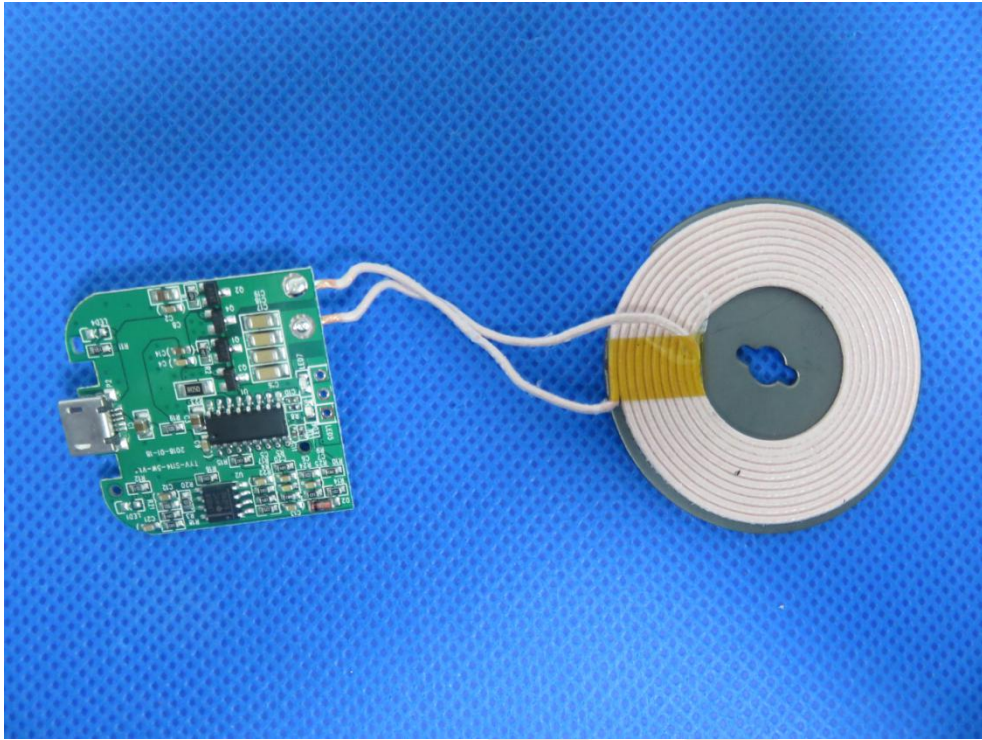

End of Report