

FCC TEST REPORT

Client Name : Shenzhen Minsuo Industrial Co.,Ltd
Address : 12th floor, Block B, Tengyao Building, No. 268 Gushu 2nd road,Xixiang Town, Bao'an, Shenzhen, Guangdong, China
Product Name : Bluetooth Transmitter
Date : Feb. 27, 2020

Shenzhen Anbotek Compliance Laboratory Limited

Contents

1. General Information.....	5
1.1. Client Information.....	5
1.2. Description of Device (EUT).....	5
1.3. Auxiliary Equipment Used During Test.....	6
1.4. Description of Test Modes.....	6
1.5. List of channels.....	7
1.6. Description Of Test Setup.....	8
1.7. Test Equipment List.....	9
1.8. Measurement Uncertainty.....	10
1.9. Description of Test Facility.....	10
2. Summary of Test Results.....	11
3. Conducted Emission Test.....	12
3.1. Test Standard and Limit.....	12
3.2. Test Setup.....	12
3.3. Test Procedure.....	12
3.4. Test Data.....	12
4. Radiation Spurious Emission and Band Edge.....	15
4.1. Test Standard and Limit.....	15
4.2. Test Setup.....	15
4.3. Test Procedure.....	16
4.4. Test Data.....	17
5. Maximum Peak Output Power Test.....	25
5.1. Test Standard and Limit.....	25
5.2. Test Setup.....	25
5.3. Test Procedure.....	25
5.4. Test Data.....	25
6. 20DB Occupy Bandwidth Test.....	29
6.1. Test Standard.....	29
6.2. Test Setup.....	29
6.3. Test Procedure.....	29
6.4. Test Data.....	29
7. Carrier Frequency Separation Test.....	33
7.1. Test Standard and Limit.....	33
7.2. Test Setup.....	33
7.3. Test Procedure.....	33
7.4. Test Data.....	33
8. Number of Hopping Channel Test.....	37
8.1. Test Standard and Limit.....	37

8.2. Test Setup..... 37

8.3. Test Procedure..... 37

8.4. Test Data..... 37

9. Dwell Time Test..... 39

9.1. Test Standard and Limit..... 39

9.2. Test Setup..... 39

9.3. Test Procedure..... 39

9.4. Test Data..... 39

10. 100kHz Bandwidth of Frequency Band Edge Requirement..... 43

10.1. Test Standard and Limit..... 43

10.2. Test Setup..... 43

10.3. Test Procedure..... 43

10.4. Test Data..... 43

11. Antenna Requirement..... 48

11.1. Test Standard and Requirement..... 48

11.2. Antenna Connected Construction..... 48

APPENDIX I -- TEST SETUP PHOTOGRAPH..... 49

APPENDIX II -- EXTERNAL PHOTOGRAPH..... 51

APPENDIX III -- INTERNAL PHOTOGRAPH..... 55

TEST REPORT

Applicant : Shenzhen Minsuo Industrial Co.,Ltd
Manufacturer : Shenzhen Minsuo Industrial Co.,Ltd.
Product Name : Bluetooth Transmitter
Model No. : BT-001
Trade Mark : N.A.
Rating(s) : Input: DC 5V, 1A

Test Standard(s) : FCC Part15 Subpart C 2018, Section 15.247
Test Method(s) : ANSI C63.10: 2013

The device described above is tested by Shenzhen Anbotek Compliance Laboratory Limited to determine the maximum emission levels emanating from the device and the severe levels of the device can endure and its performance criterion. The measurement results are contained in this test report and Shenzhen Anbotek Compliance Laboratory Limited is assumed full of responsibility for the accuracy and completeness of these measurements. Also, this report shows that the EUT (Equipment Under Test) is technically compliant with the FCC Part 15 Subpart C requirements.

This report applies to above tested sample only and shall not be reproduced in part without written approval of Shenzhen Anbotek Compliance Laboratory Limited.

Date of receipt

Dec. 11, 2019

Date of Test

Dec. 11, 2019~Jan. 15, 2020

Prepared by



Dolly mo

(Engineer / Dolly Mo)

Reviewer

Bibo Zhang

(Supervisor / Bibo Zhang)

Approved & Authorized Signer

Tom Chen

(Manager / Tom Chen)

1. General Information

1.1. Client Information

Applicant	:	Shenzhen Minsuo Industrial Co.,Ltd
Address	:	12th floor, Block B, Tengyao Building, No. 268 Gushu 2nd road,Xixiang Town, Bao'an, Shenzhen, Guangdong, China
Manufacturer	:	Shenzhen Minsuo Industrial Co.,Ltd.
Address	:	12th floor, Block B, Tengyao Building, No. 268 Gushu 2nd road, Xixiang Town, Bao'an, Shenzhen, China
Factory	:	Shenzhen Minsuo Industrial Co.,Ltd.
Address	:	12th floor, Block B, Tengyao Building, No. 268 Gushu 2nd road, Xixiang Town, Bao'an, Shenzhen, China

1.2. Description of Device (EUT)

Product Name	:	Bluetooth Transmitter	
Model No.	:	BT-001	
Trade Mark	:	N.A.	
Test Power Supply	:	AC 120V, 60Hz for adapter	
Test Sample No.	:	1-2-1(Normal Sample), 1-2-2(Engineering Sample)	
Product Description	:	Operation Frequency:	2402MHz~2480MHz
		Transfer Rate:	1/2/3 Mbits/s
		Number of Channel:	79 Channels
		Modulation Type:	GFSK, $\pi/4$ -DQPSK, 8-DPSK
		Antenna Type:	PCB Antenna
		Antenna Gain(Peak):	0 dBi
Remark: 1) For a more detailed features description, please refer to the manufacturer's specifications or the User's Manual.			

1.3. Auxiliary Equipment Used During Test

Adapter	:	Manufacturer: ZTE M/N: STC-A205011000USBA-C S/N: 201202102100876 Input: 100-240V~ 50/60Hz, 0.3A Output: DC 5V, 1000mA
----------------	---	---

1.4. Description of Test Modes

To investigate the maximum EMI emission characteristics generates from EUT, the test system was pre-scanning tested base on the consideration of following EUT operation mode or test configuration mode which possible have effect on EMI emission level. Each of these EUT operation mode(s) or test configuration mode(s) mentioned above was evaluated respectively.

TEST MODE:

Mode 1	GFSK	CH00	TX+ Charging Mode/TX Only
Mode 2		CH39	
Mode 3		CH78	
Mode 4	$\pi/4$ -DQPSK	CH00	
Mode 5		CH39	
Mode 6		CH78	
Mode 7	8-DPSK	CH00	
Mode 8		CH39	
Mode 9		CH78	

Note:

- (1) The measurements are performed at the highest, middle, lowest available channels.
- (2)The data rate was set in 1Mbps for radiated emission due to the highest RF output power.

1.5. List of channels

Channel	Freq. (MHz)	Channel	Freq. (MHz)	Channel	Freq. (MHz)	Channel	Freq. (MHz)	Channel	Freq. (MHz)
00	2402	17	2419	34	2436	51	2453	68	2470
01	2403	18	2420	35	2437	52	2454	69	2471
02	2404	19	2421	36	2438	53	2455	70	2472
03	2405	20	2422	37	2439	54	2456	71	2473
04	2406	21	2423	38	2440	55	2457	72	2474
05	2407	22	2424	39	2441	56	2458	73	2475
05	2408	23	2425	40	2442	57	2459	74	2476
07	2409	24	2426	41	2443	58	2460	75	2477
08	2410	25	2427	42	2444	59	2461	76	2478
09	2411	26	2428	43	2445	60	2462	77	2479
10	2412	27	2429	44	2446	61	2463	78	2480
11	2413	28	2430	45	2447	62	2464		
12	2414	29	2431	46	2448	63	2465		
13	2415	30	2432	47	2449	64	2466		
14	2416	31	2433	48	2450	65	2467		
15	2417	32	2434	49	2451	66	2468		
16	2418	33	2435	50	2452	67	2469		

Note:

1. The engineering test program was provided and the EUT was programmed to be in continuously transmitting mode.
2. EUT built-in battery-powered, fully-charged battery use of the test battery.

1.6. Description Of Test Setup

CE

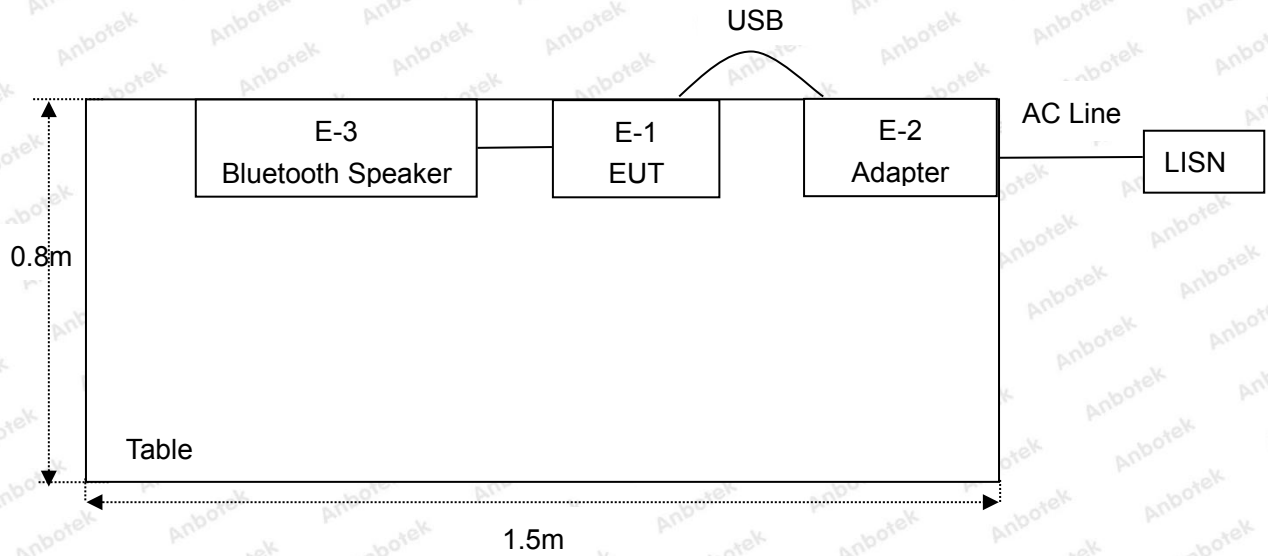

RE

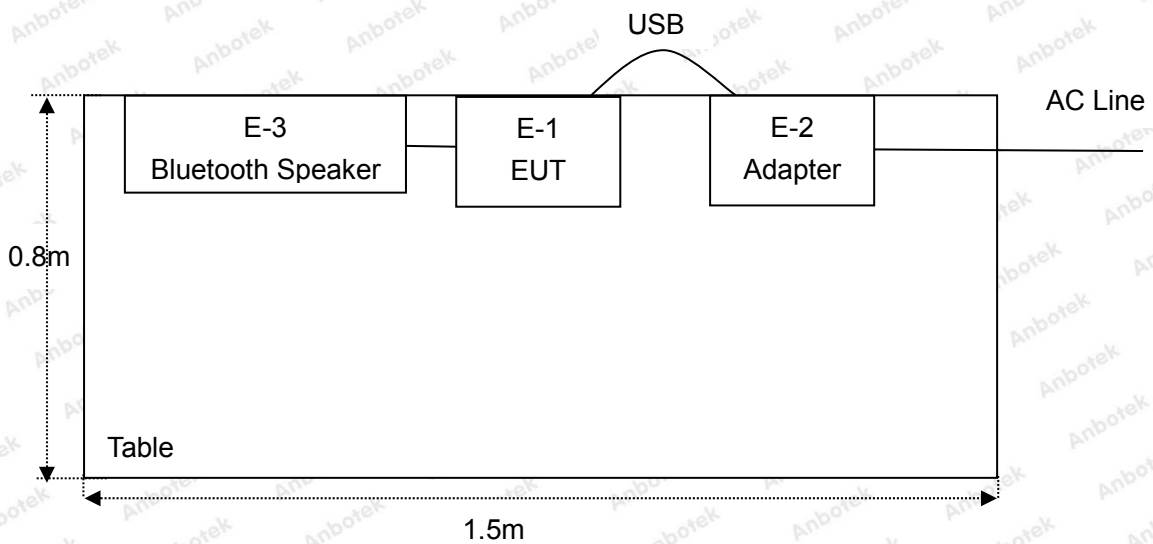

1.7. Test Equipment List

Item	Equipment	Manufacturer	Model No.	Serial No.	Last Cal.	Cal. Interval
1.	L.I.S.N. Artificial Mains Network	Rohde & Schwarz	ENV216	100055	Nov. 04, 2019	1 Year
2.	EMI Test Receiver	Rohde & Schwarz	ESPI3	101604	Nov. 04, 2019	1 Year
3.	RF Switching Unit	Compliance Direction	RSU-M2	38303	Nov. 04, 2019	1 Year
4.	MAX Spectrum Analysis	Agilent	N9020A	MY51170037	Nov. 04, 2019	1 Year
5.	Preamplifier	SKET Electronic	BK1G18G30 D	KD17503	Nov. 04, 2019	1 Year
6.	Double Ridged Horn Antenna	Instruments corporation	GTH-0118	351600	Nov. 01, 2019	1 Year
7.	Bilog Broadband Antenna	Schwarzbeck	VULB9163	VULB 9163-289	Nov. 01, 2019	1 Year
8.	Loop Antenna	Schwarzbeck	FMZB1519B	00053	Nov. 01, 2019	1 Year
9.	Horn Antenna	A-INFO	LB-180400-K F	J211060628	Nov. 01, 2019	1 Year
10.	Pre-amplifier	SONOMA	310N	186860	Nov. 04, 2019	1 Year
11.	EMI Test Software EZ-EMC	SHURPLE	N/A	N/A	N/A	N/A
12.	RF Test Control System	YIHENG	YH3000	2017430	Nov. 04, 2019	1 Year
13.	Power Sensor	DAER	RPR3006W	15I00041SN045	Nov. 04, 2019	1 Year
14.	Power Sensor	DAER	RPR3006W	15I00041SN046	Nov. 04, 2019	1 Year
15.	MXA Spectrum Analysis	Agilent	N9020A	MY51170037	Nov. 04, 2019	1 Year
16.	MXG RF Vector Signal Generator	Agilent	N5182A	MY48180656	Nov. 04, 2019	1 Year
17.	Signal Generator	Agilent	E4421B	MY41000743	Nov. 04, 2019	1 Year
18.	DC Power Supply	LW	TPR-6420D	374470	Nov. 04, 2019	1 Year
19.	Constant Temperature Humidity Chamber	ZHONGJIAN	ZJ-KHWS80 B	N/A	Nov. 04, 2019	1 Year

1.8. Measurement Uncertainty

Radiation Uncertainty	:	Ur = 3.9 dB (Horizontal)
		Ur = 3.8 dB (Vertical)
Conduction Uncertainty	:	Uc = 3.4 dB

1.9. Description of Test Facility

The test facility is recognized, certified, or accredited by the following organizations:

FCC-Registration No.: 184111

Shenzhen Anbotek Compliance Laboratory Limited, EMC Laboratory has been registered and fully described in a report filed with the (FCC) Federal Communications Commission. The acceptance letter from the FCC is maintained in our files. Registration No. 184111, September 27, 2019.

ISED-Registration No.: 8058A

Shenzhen Anbotek Compliance Laboratory Limited, EMC Laboratory has been registered and fully described in a report filed with the (ISED) Innovation, Science and Economic Development Canada. The acceptance letter from the ISED is maintained in our files. Registration 8058A, March 07, 2019.

Test Location

Shenzhen Anbotek Compliance Laboratory Limited.

1/F, Building D, Sogood Science and Technology Park, Sanwei community, Hangcheng Street, Bao'an District, Shenzhen, Guangdong, China.518102

2. Summary of Test Results

Standard Section	Test Item	Result
15.203/15.247(c)	Antenna Requirement	PASS
15.207	Conducted Emission	PASS
15.205/15.209	Spurious Emission	PASS
15.247(b)(1)	Conducted Peak Output Power	PASS
15.247(a)(1)	20dB Occupied Bandwidth	PASS
15.247(a)(1)	Carrier Frequencies Separation	PASS
15.247(a)(1)	Hopping Channel Number	PASS
15.247(a)(1)	Dwell Time	PASS
15.247(d)	Band Edge	PASS
Remark: "N/A" is an abbreviation for Not Applicable.		

3. Conducted Emission Test

3.1. Test Standard and Limit

Test Standard	FCC Part15 Section 15.207		
Test Limit	Frequency	Maximum RF Line Voltage (dBuV)	
		Quasi-peak Level	Average Level
	150kHz~500kHz	66 ~ 56 *	56 ~ 46 *
	500kHz~5MHz	56	46
5MHz~30MHz	60	50	

Remark: (1) *Decreasing linearly with logarithm of the frequency.
 (2) The lower limit shall apply at the transition frequency.

3.2. Test Setup

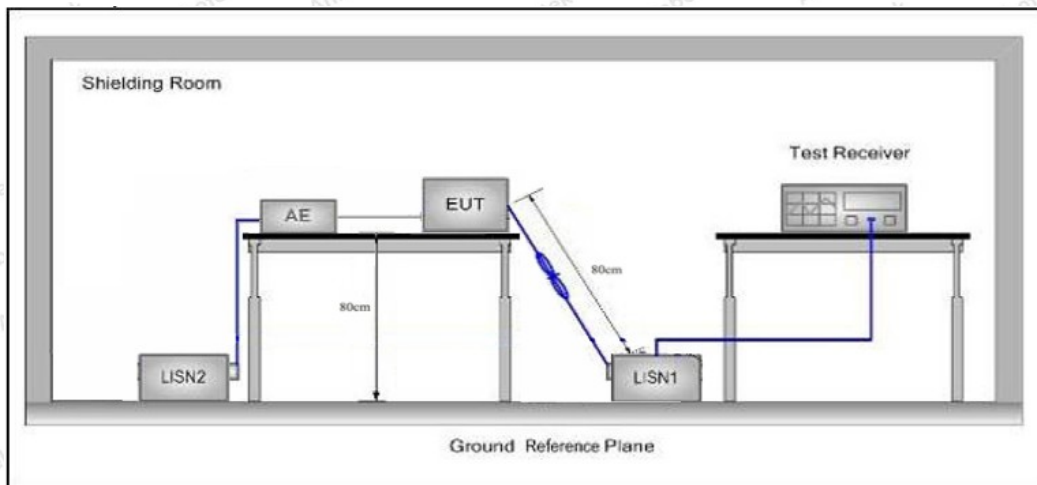

3.3. Test Procedure

The EUT system is connected to the power mains through a line impedance stabilization network (L.I.S.N.). This provides a 50ohm coupling impedance for the EUT system. Please refer the block diagram of the test setup and photographs. Both sides of AC line are checked to find out the maximum conducted emission. In order to find the maximum emission levels, the relative positions of equipment and all of the interface cables shall be changed according to FCC ANSI C63.10-2013 on Conducted Emission Measurement.

The bandwidth of test receiver (ESCI) set at 9kHz.

The frequency range from 150kHz to 30MHz is checked.

3.4. Test Data

During the test, pre-scan the GFSK, $\pi/4$ QPSK, 8DPSK modulation, and found the GFSK modulation Low channel(TX+Charging Mode) which is the worst case, only the worst case is recorded in the report. Please to see the following pages.

Conducted Emission Test Data

Test Site: 1# Shielded Room
 Operating Condition: Mode 1
 Test Specification: AC 120V, 60Hz for adapter
 Comment: Live Line
 Tem.: 18.1°C Hum.: 35%

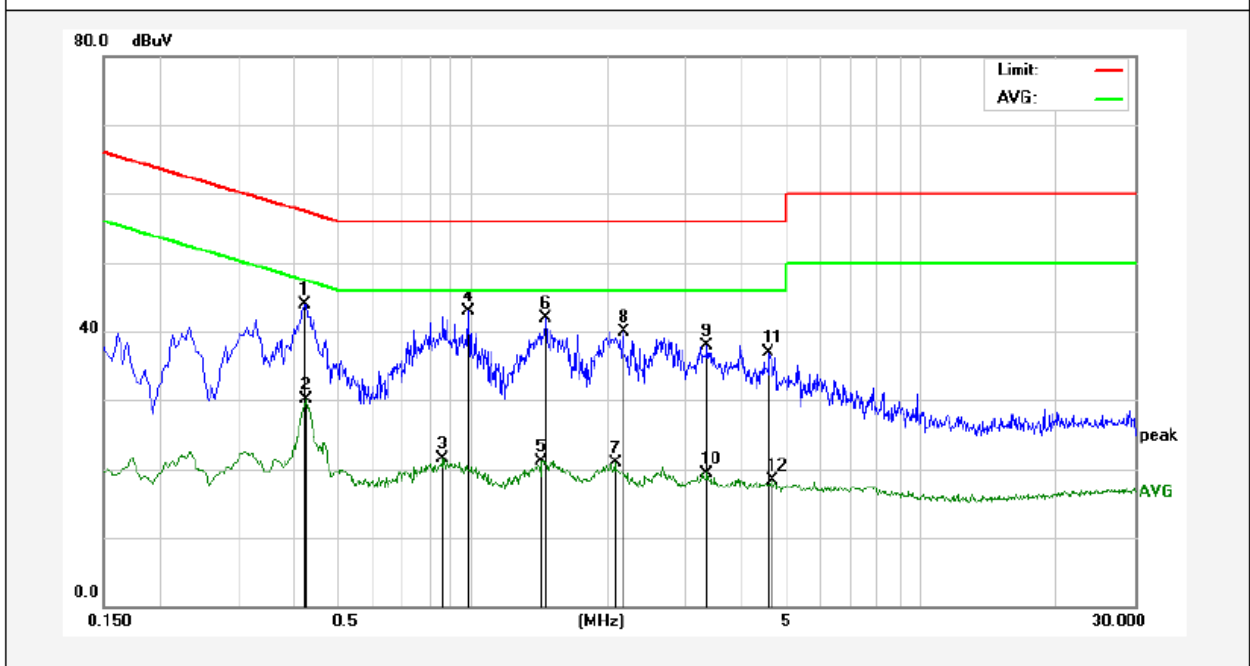

No.	Freq. (MHz)	Reading (dBuV)	Factor (dB)	Result (dBuV)	Limit (dBuV)	Over Limit (dB)	Detector	Remark
1	0.4220	23.93	19.94	43.87	57.41	-13.54	QP	
2	0.4260	10.22	19.95	30.17	47.33	-17.16	AVG	
3	0.8580	1.35	20.08	21.43	46.00	-24.57	AVG	
4	0.9820	22.86	20.12	42.98	56.00	-13.02	QP	
5	1.4299	1.01	20.13	21.14	46.00	-24.86	AVG	
6	1.4580	21.79	20.13	41.92	56.00	-14.08	QP	
7	2.0820	0.70	20.14	20.84	46.00	-25.16	AVG	
8	2.1780	19.86	20.14	40.00	56.00	-16.00	QP	
9	3.3420	17.81	20.17	37.98	56.00	-18.02	QP	
10	3.3420	-0.77	20.17	19.40	46.00	-26.60	AVG	
11	4.5860	16.63	20.20	36.83	56.00	-19.17	QP	
12	4.6779	-1.99	20.20	18.21	46.00	-27.79	AVG	

Conducted Emission Test Data

Test Site: 1# Shielded Room
 Operating Condition: Mode 1
 Test Specification: AC 120V, 60Hz for adapter
 Comment: Neutral Line
 Tem.: 18.1°C Hum.: 35%

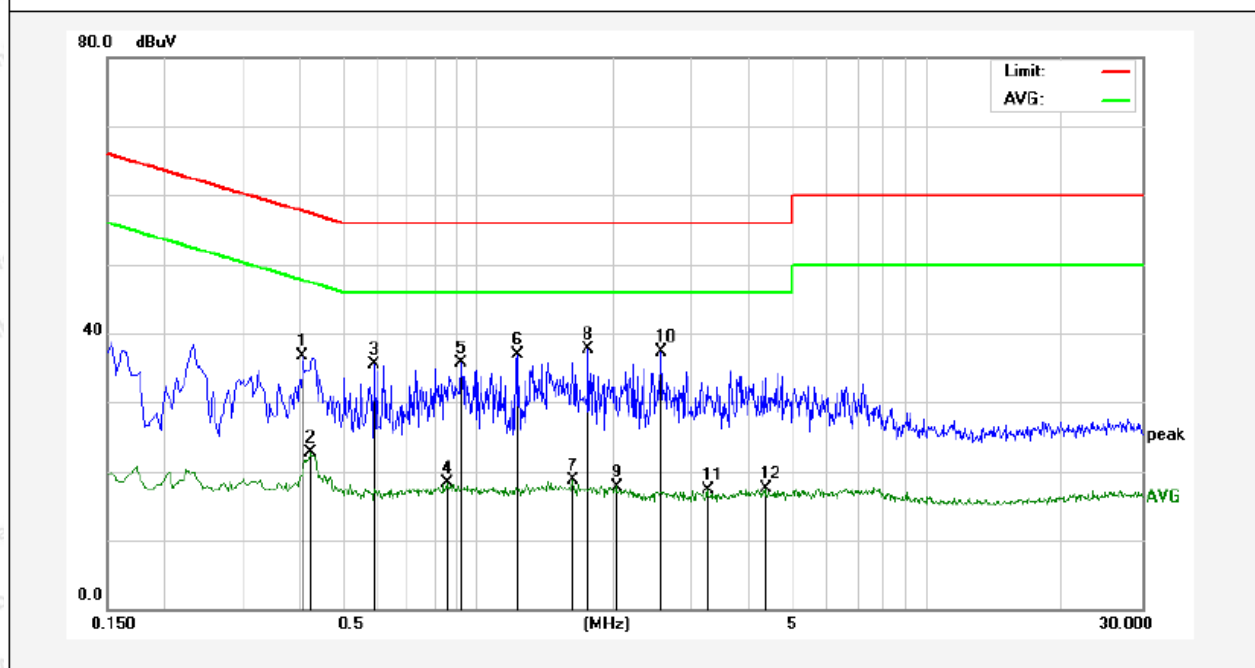

No.	Freq. (MHz)	Reading (dBuV)	Factor (dB)	Result (dBuV)	Limit (dBuV)	Over Limit (dB)	Detector	Remark
1	0.4100	16.82	19.94	36.76	57.65	-20.89	QP	
2	0.4260	2.75	19.95	22.70	47.33	-24.63	AVG	
3	0.5899	15.43	20.01	35.44	56.00	-20.56	QP	
4	0.8540	-1.87	20.08	18.21	46.00	-27.79	AVG	
5	0.9220	15.58	20.10	35.68	56.00	-20.32	QP	
6	1.2260	16.83	20.12	36.95	56.00	-19.05	QP	
7	1.6300	-1.47	20.13	18.66	46.00	-27.34	AVG	
8	1.7660	17.48	20.14	37.62	56.00	-18.38	QP	
9	2.0340	-2.34	20.14	17.80	46.00	-28.20	AVG	
10	2.5620	17.13	20.15	37.28	56.00	-18.72	QP	
11	3.2420	-2.82	20.16	17.34	46.00	-28.66	AVG	
12	4.3700	-2.60	20.19	17.59	46.00	-28.41	AVG	

4. Radiation Spurious Emission and Band Edge

4.1. Test Standard and Limit

Test Standard	FCC Part15 C Section 15.209 and 15.205				
Test Limit	Frequency (MHz)	Field strength (microvolt/meter)	Limit (dBuV/m)	Remark	Measurement distance (m)
	0.009MHz~0.490MHz	2400/F(kHz)	-	-	300
	0.490MHz-1.705MHz	24000/F(kHz)	-	-	30
	1.705MHz-30MHz	30	-	-	30
	30MHz~88MHz	100	40.0	Quasi-peak	3
	88MHz~216MHz	150	43.5	Quasi-peak	3
	216MHz~960MHz	200	46.0	Quasi-peak	3
	960MHz~1000MHz	500	54.0	Quasi-peak	3
	Above 1000MHz	500	54.0	Average	3
-		74.0	Peak	3	

Remark:

(1)The lower limit shall apply at the transition frequency.

(2) 15.35(b), Unless otherwise specified, the limit on peak radio frequency emissions is 20dB above the maximum permitted average emission limit applicable to the equipment under test. This peak limit applies to the total peak emission level radiated by the device.

4.2. Test Setup

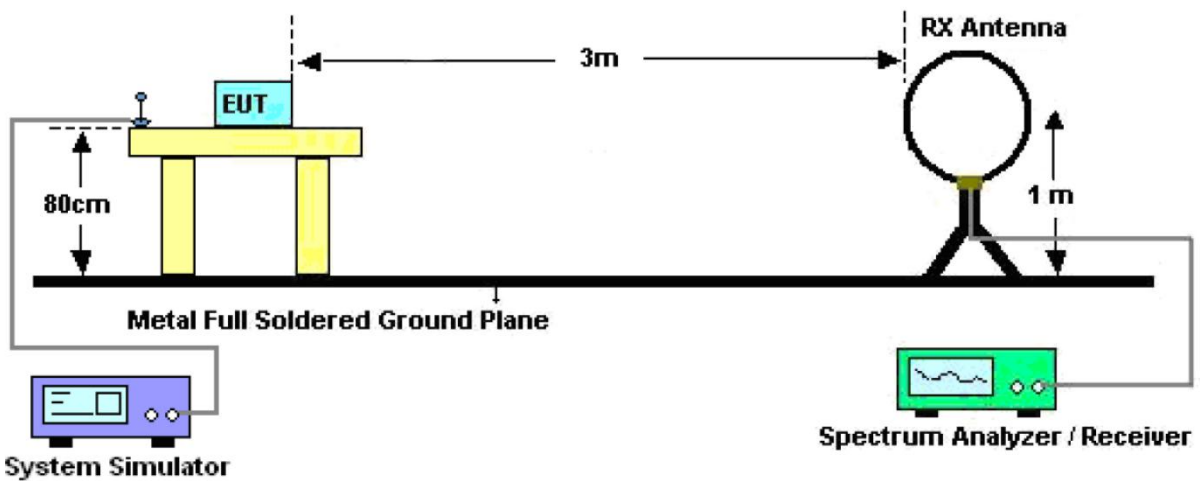

Figure 1. Below 30MHz

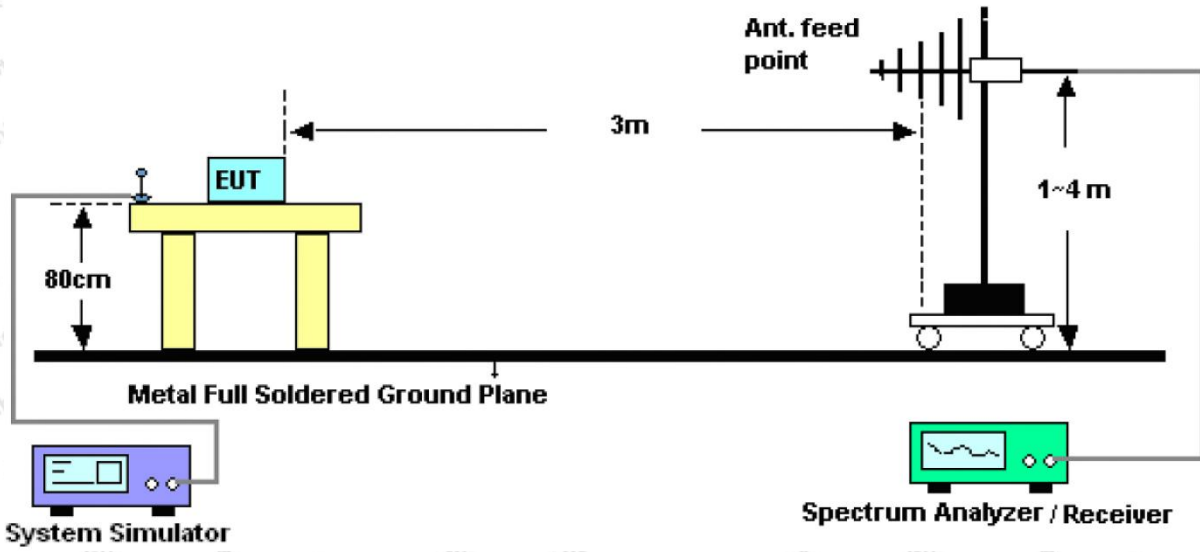

Figure 2. 30MHz to 1GHz

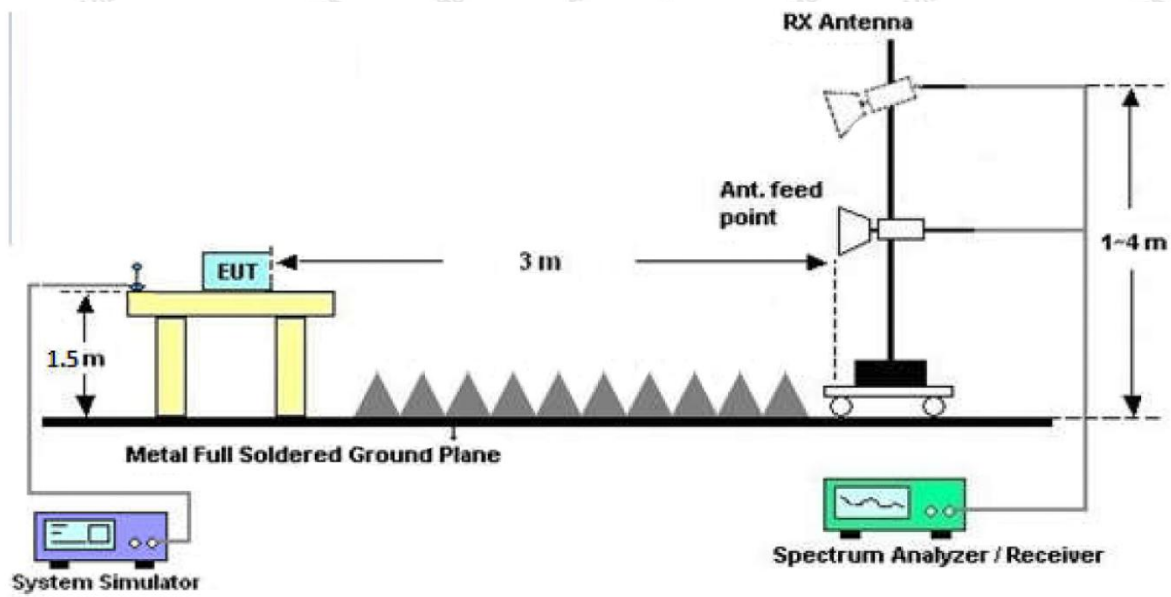

Figure 3. Above 1 GHz

4.3. Test Procedure

For below 1GHz: The EUT is placed on a turntable, which is 0.8m above the ground plane.

For above 1GHz: The EUT is placed on a turntable, which is 1.5m above the ground plane.

The turn table can rotate 360 degrees to determine the position of the maximum emission level. The EUT is set 3 meters away from the receiving antenna which is mounted on a antenna tower. The antenna can be moved up and down from 1 to 4 meters to find out the maximum emission level. Rotated the EUT through three orthogonal axes to determine the maximum emissions, both horizontal and vertical polarization of the antenna are set on test. The EUT is tested in 9*6*6 Chamber. The device is evaluated in xyz orientation.

For the radiated emission test above 1GHz:

Shenzhen Anbotek Compliance Laboratory Limited

Code:AB-RF-05-a

Address: 1/F., Building D, Sogood Science and Technology Park, Sanwei Community, Hangcheng Street, Bao'an District, Shenzhen, Guangdong, China.
Tel: (86) 755-26066440 Fax: (86) 755-26014772 Email: service@anbotek.com

Hotline
400-003-0500
www.anbotek.com

Place the measurement antenna away from each area of the EUT determined to be a source of emissions at the specified measurement distance, while keeping the measurement antenna aimed at the source of emissions at each frequency of significant emissions, with polarization oriented for maximum response. The measurement antenna may have to be higher or lower than the EUT, depending on the radiation pattern of the emission and staying aimed at the emission source for receiving the maximum signal. The final measurement antenna elevation shall be that which maximizes the emissions. The measurement antenna elevation for maximum emissions shall be restricted to a range of heights of from 1 m to 4 m above the ground or reference ground plane.

For 9kHz to 150kHz, Set the spectrum analyzer as:

RBW = 200Hz, VBW =1kHz, Detector= Quasi-Peak, Trace mode= Max hold, Sweep- auto couple.

For 150kHz to 30MHz, Set the spectrum analyzer as:

RBW = 9KHz, VBW =30kHz, Detector= Quasi-Peak, Trace mode= Max hold, Sweep- auto couple.

For 30MHz to 1000MHz, Set the spectrum analyzer as:

RBW = 100kHz, VBW =300kHz, Detector= Quasi-Peak, Trace mode= Max hold, Sweep- auto couple.

For above 1GHz, Set the spectrum analyzer as:

RBW =1MHz, VBW =1MHz, Detector= Peak, Trace mode= Max hold, Sweep- auto couple.

RBW =1MHz, VBW =10Hz, Detector= Average, Trace mode= Max hold, Sweep- auto couple.

4.4. Test Data

PASS

During the test, pre-scan the GFSK, $\pi/4$ QPSK, 8DPSK modulation, and found the GFSK modulation Middle channel(TX+Charging Mode) which is the worst case, only the worst case is recorded in the report

The test results of 9kHz-30MHz was attenuated more than 20dB below the permissible limits, so the results don't record in the report.



Test Results (30~1000MHz)

Test Mode: Mode 2
 Power Source: AC 120V, 60Hz for adapter
 Polarization: Vertical
 Temp.(°C)/Hum.(%RH): 25.6°C/51%RH

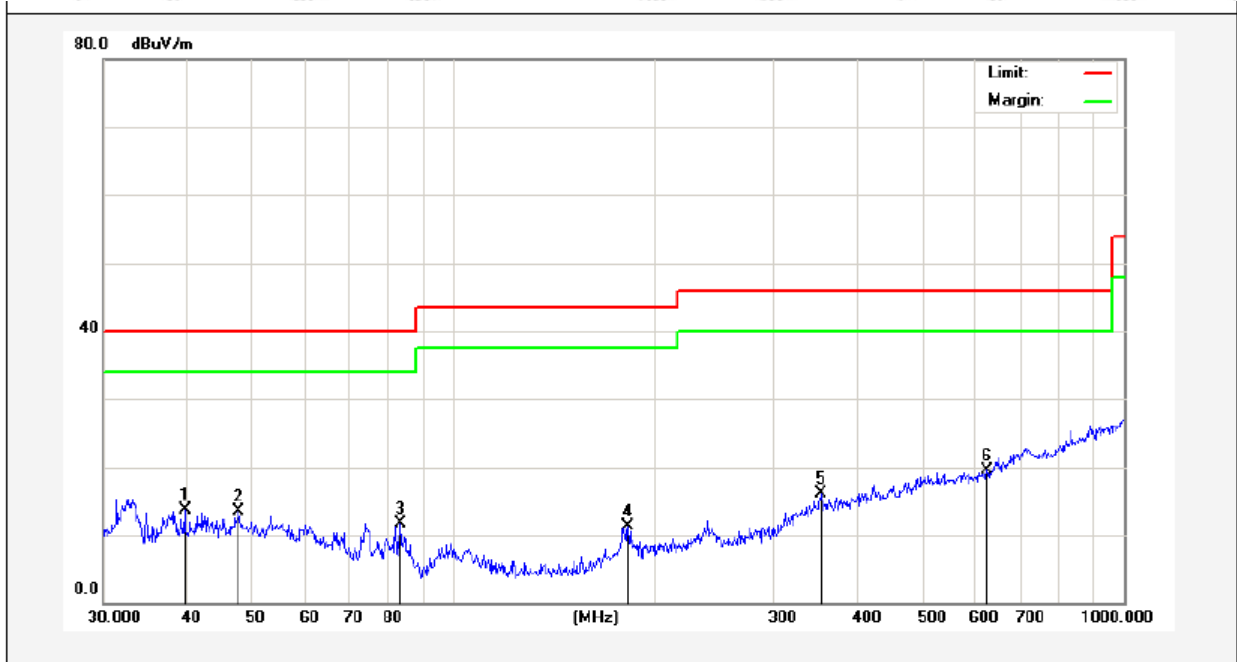

No.	Freq. (MHz)	Reading (dBuV)	Factor (dB/m)	Result (dBuV/m)	Limit (dBuV/m)	Over Limit (dB)	Detector	Height (cm)	degree (deg)	Remark
1	39.7146	30.61	-16.85	13.76	40.00	-26.24	QP	100	0	
2	47.8260	30.45	-16.97	13.48	40.00	-26.52	QP	100	360	
3	83.2298	31.84	-20.20	11.64	40.00	-28.36	QP	100	0	
4	181.9202	30.32	-18.97	11.35	43.50	-32.15	QP	100	360	
5	352.9433	31.26	-15.13	16.13	46.00	-29.87	QP	100	0	
6	625.0780	30.29	-10.69	19.60	46.00	-26.40	QP	100	360	

Test Results (30~1000MHz)

Test Mode: Mode 2
 Power Source: AC 120V, 60Hz for adapter
 Polarization: Horizontal
 Temp.(°C)/Hum.(%RH): 25.6°C/51%RH

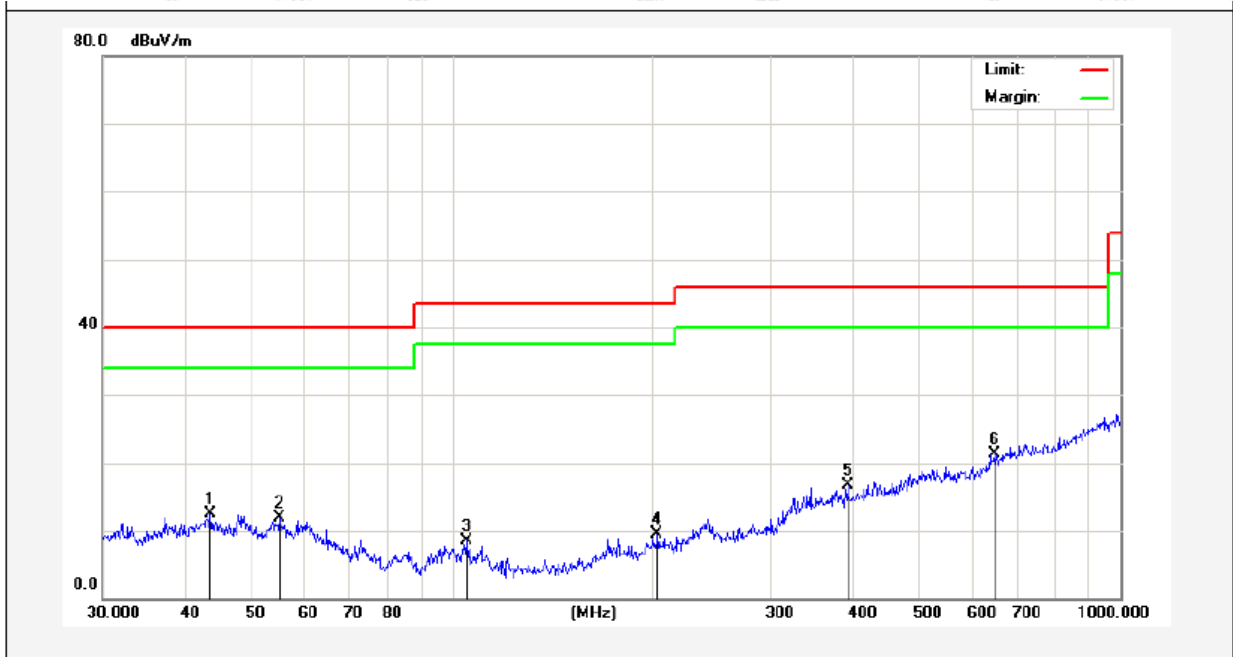

No.	Freq. (MHz)	Reading (dBuV)	Factor (dB/m)	Result (dBuV/m)	Limit (dBuV/m)	Over Limit (dB)	Detector	Height (cm)	degree (deg)	Remark
1	43.5057	30.36	-17.79	12.57	40.00	-27.43	QP	100	0	
2	55.2207	30.04	-18.22	11.82	40.00	-28.18	QP	100	360	
3	105.2718	31.54	-22.95	8.59	43.50	-34.91	QP	100	0	
4	202.8104	31.67	-22.09	9.58	43.50	-33.92	QP	100	360	
5	390.7226	32.14	-15.44	16.70	46.00	-29.30	QP	100	0	
6	647.3856	32.85	-11.60	21.25	46.00	-24.75	QP	100	360	

Test Results (1GHz-25GHz)

Test Mode: CH00					Test channel: Lowest			
Peak Value								
Frequency (MHz)	Read Level (dBuV)	Antenna Factor (dB/m)	Cable Loss (dB)	Preamp Factor (dB)	Level (dBuV/m)	Limit (dBuV/m)	Over Limit (dB)	Pol.
4804.00	37.84	34.04	6.58	34.09	44.37	74.00	-29.63	V
7206.00	32.18	37.11	7.73	34.50	42.52	74.00	-31.48	V
9608.00	31.78	39.31	9.23	34.79	45.53	74.00	-28.47	V
12010.00	*					74.00		V
14412.00	*					74.00		V
4804.00	42.23	34.04	6.58	34.09	48.76	74.00	-25.24	H
7206.00	33.99	37.11	7.73	34.50	44.33	74.00	-29.67	H
9608.00	31.26	39.31	9.23	34.79	45.01	74.00	-28.99	H
12010.00	*					74.00		H
14412.00	*					74.00		H
Average Value								
Frequency (MHz)	Read Level (dBuV)	Antenna Factor (dB/m)	Cable Loss (dB)	Preamp Factor (dB)	Level (dBuV/m)	Limit (dBuV/m)	Over Limit (dB)	Pol.
4804.00	26.55	34.04	6.58	34.09	33.08	54.00	-20.92	V
7206.00	20.81	37.11	7.73	34.50	31.15	54.00	-22.85	V
9608.00	19.85	39.31	9.23	34.79	33.60	54.00	-20.40	V
12010.00	*					54.00		V
14412.00	*					54.00		V
4804.00	30.84	34.04	6.58	34.09	37.37	54.00	-16.63	H
7206.00	23.02	37.11	7.73	34.50	33.36	54.00	-20.64	H
9608.00	19.63	39.31	9.23	34.79	33.38	54.00	-20.62	H
12010.00	*					54.00		H
14412.00	*					54.00		H

Test Results (1GHz-25GHz)

Test Mode: CH39					Test channel: Middle			
Peak Value								
Frequency (MHz)	Read Level (dBuV)	Antenna Factor (dB/m)	Cable Loss (dB)	Preamp Factor (dB)	Level (dBuV/m)	Limit (dBuV/m)	Over Limit (dB)	Pol.
4882.00	37.19	34.38	6.69	34.09	44.17	74.00	-29.83	V
7323.00	31.75	37.22	7.78	34.53	42.22	74.00	-31.78	V
9764.00	31.40	39.46	9.35	34.80	45.41	74.00	-28.59	V
12205.00	*					74.00		V
14646.00	*					74.00		V
4882.00	41.45	34.38	6.69	34.09	48.43	74.00	-25.57	H
7323.00	33.50	37.22	7.78	34.53	43.97	74.00	-30.03	H
9764.00	30.81	39.46	9.35	34.80	44.82	74.00	-29.18	H
12205.00	*					74.00		H
14646.00	*					74.00		H
Average Value								
Frequency (MHz)	Read Level (dBuV)	Antenna Factor (dB/m)	Cable Loss (dB)	Preamp Factor (dB)	Level (dBuV/m)	Limit (dBuV/m)	Over Limit (dB)	Pol.
4882.00	26.04	34.38	6.69	34.09	33.02	54.00	-20.98	V
7323.00	20.46	37.22	7.78	34.53	30.93	54.00	-23.07	V
9764.00	19.54	39.46	9.35	34.80	33.55	54.00	-20.45	V
12205.00	*					54.00		V
14646.00	*					54.00		V
4882.00	30.25	34.38	6.69	34.09	37.23	54.00	-16.77	H
7323.00	22.63	37.22	7.78	34.53	33.10	54.00	-20.90	H
9764.00	19.27	39.46	9.35	34.80	33.28	54.00	-20.72	H
12205.00	*					54.00		H
14646.00	*					54.00		H

Test Results (1GHz-25GHz)

Test Mode: CH78					Test channel: Highest			
Peak Value								
Frequency (MHz)	Read Level (dBuV)	Antenna Factor (dB/m)	Cable Loss (dB)	Preamp Factor (dB)	Level (dBuV/m)	Limit (dBuV/m)	Over Limit (dB)	Pol.
4960.00	35.63	34.72	6.79	34.09	43.05	74.00	-30.95	V
7440.00	30.72	37.34	7.82	34.57	41.31	74.00	-32.69	V
9920.00	30.48	39.62	9.46	34.81	44.75	74.00	-29.25	V
12400.00	*					74.00		V
14880.00	*					74.00		V
4960.00	39.57	34.72	6.79	34.09	46.99	74.00	-27.01	H
7440.00	32.33	37.34	7.82	34.57	42.92	74.00	-31.08	H
9920.00	29.74	39.62	9.46	34.81	44.01	74.00	-29.99	H
12400.00	*					74.00		H
14880.00	*					74.00		H
Average Value								
Frequency (MHz)	Read Level (dBuV)	Antenna Factor (dB/m)	Cable Loss (dB)	Preamp Factor (dB)	Level (dBuV/m)	Limit (dBuV/m)	Over Limit (dB)	Pol.
4960.00	24.80	34.72	6.79	34.09	32.22	54.00	-21.78	V
7440.00	19.62	37.34	7.82	34.57	30.21	54.00	-23.79	V
9920.00	18.80	39.62	9.46	34.81	33.07	54.00	-20.93	V
12400.00	*					54.00		V
14880.00	*					54.00		V
4960.00	28.84	34.72	6.79	34.09	36.26	54.00	-17.74	H
7440.00	21.68	37.34	7.82	34.57	32.27	54.00	-21.73	H
9920.00	18.39	39.62	9.46	34.81	32.66	54.00	-21.34	H
12400.00	*					54.00		H
14880.00	*					54.00		H

Remark:

1. During the test, pre-scan the GFSK, π/4QPSK, 8DPSK modulation, and found the GFSK modulation is worse case, the report only record this mode.
2. Level =Receiver Read level + Antenna Factor + Cable Loss – Pre-amplifier Factor
3. “*” means the test results were attenuated more than 20dB below the permissible limits, so the results don't record in the report.

Radiated Band Edge:





Remark:

1. During the test, pre-scan the GFSK, $\pi/4$ QPSK, 8DPSK modulation, and found the GFSK modulation is worse case, the report only record this mode.
2. Level =Receiver Read level + Antenna Factor + Cable Loss – Pre-amplifier Factor

5. Maximum Peak Output Power Test

5.1. Test Standard and Limit

Test Standard	FCC Part15 C Section 15.247 (b)(3)
Test Limit	125mW

5.2. Test Setup

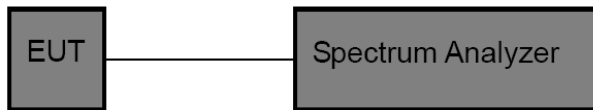

5.3. Test Procedure

- The EUT was directly connected to the spectrum analyzer and antenna output port as show in the block diagram above,
- Spectrum Setting:
 - RBW > the 20 dB bandwidth of the emission being measured
 - Span = approximately 5 times the 20 dB bandwidth, centered on a hopping channel
 - VBW ≥ RBW
 - Sweep = auto
 - Detector function = peak
 - Trace = max hold

5.4. Test Data

Test Item	: Max. peak output power	Test Mode	: CH Low ~ CH High
Test Voltage	: AC 120V, 60Hz for adapter	Temperature	: 23.2° C
Test Result	: PASS	Humidity	: 49 %

Channel Frequency (MHz)	Peak Power output (dBm)	Limit (dBm)	Results	Modulation
2402	-0.196	20.96	PASS	BDR
2441	0.144	20.96	PASS	BDR
2480	0.259	20.96	PASS	BDR
2402	-0.761	20.96	PASS	EDR
2441	-0.580	20.96	PASS	EDR
2480	-0.603	20.96	PASS	EDR

Remark: The EDR was tested on (π/4QPSK, 8DPSK) modes, only the worst data of (8DPSK) is attached in the following pages.

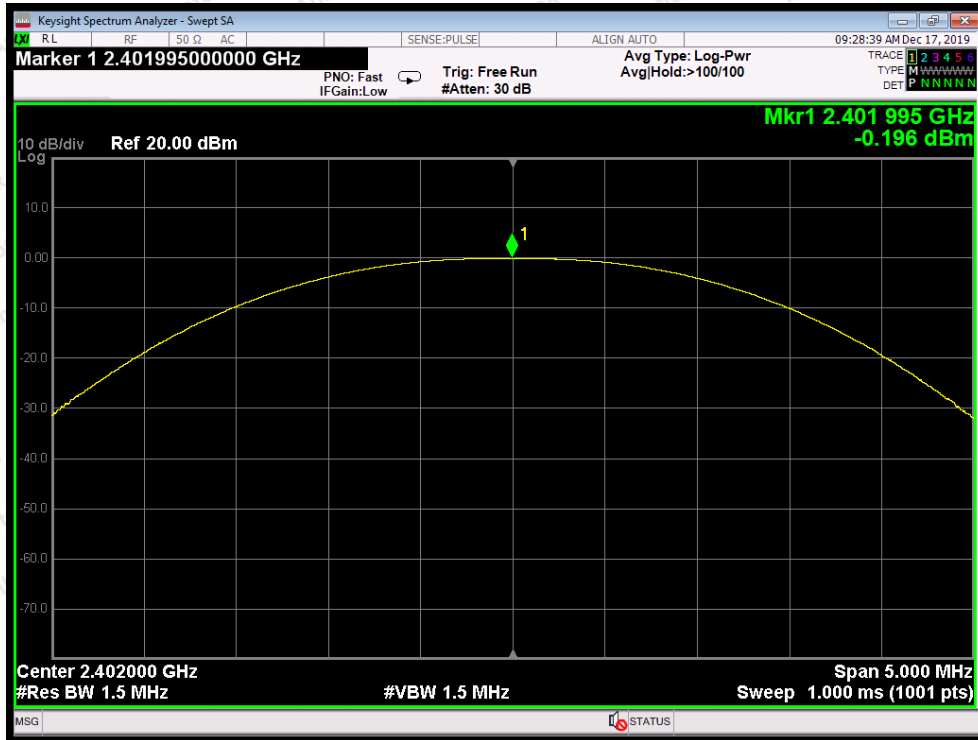

Test Mode: BDR---Low

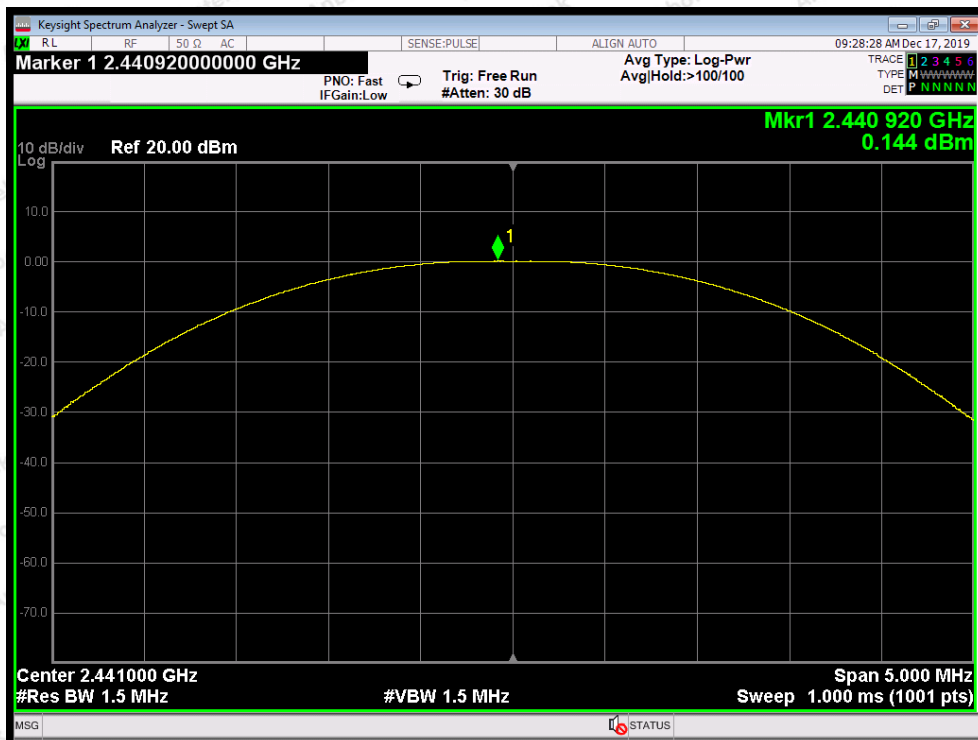

Test Mode: BDR---Middle

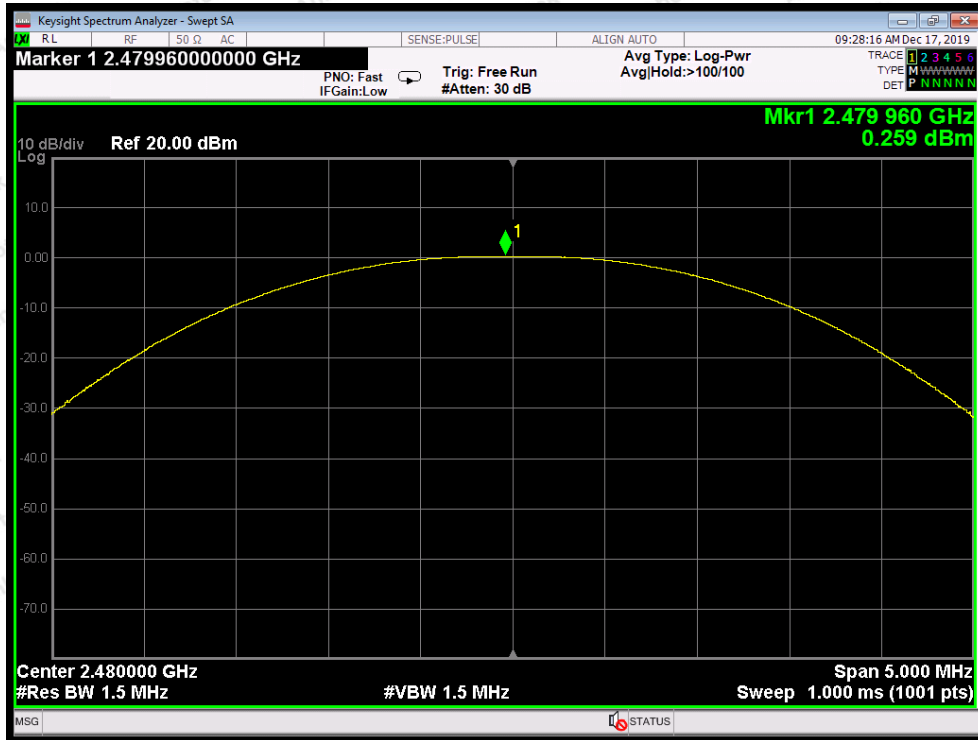

Test Mode: BDR---High

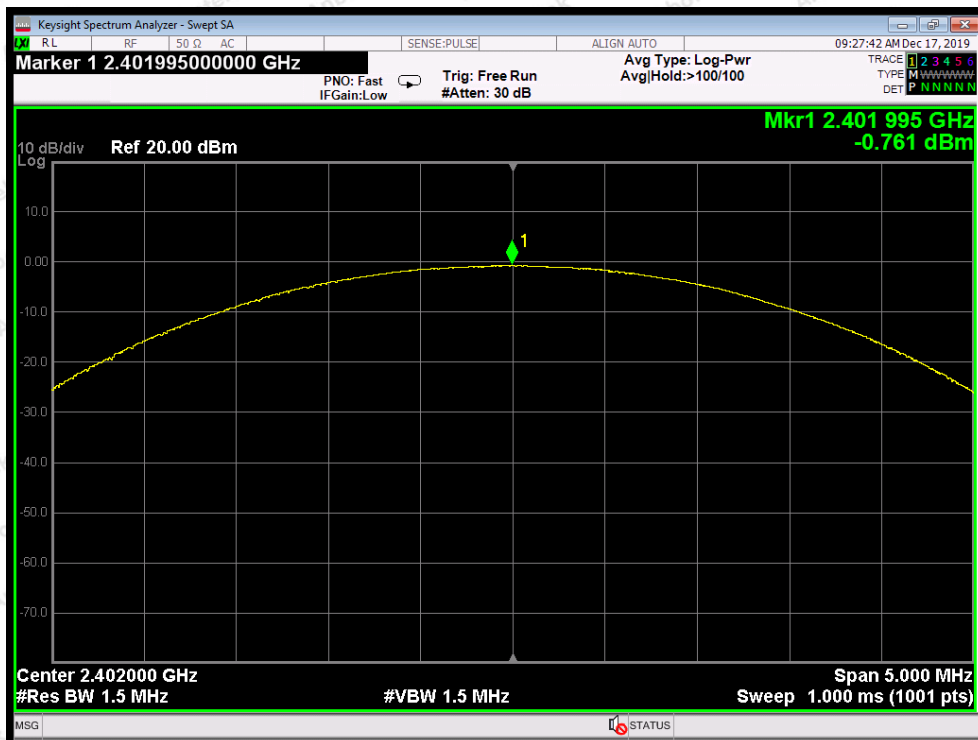

Test Mode: EDR---Low

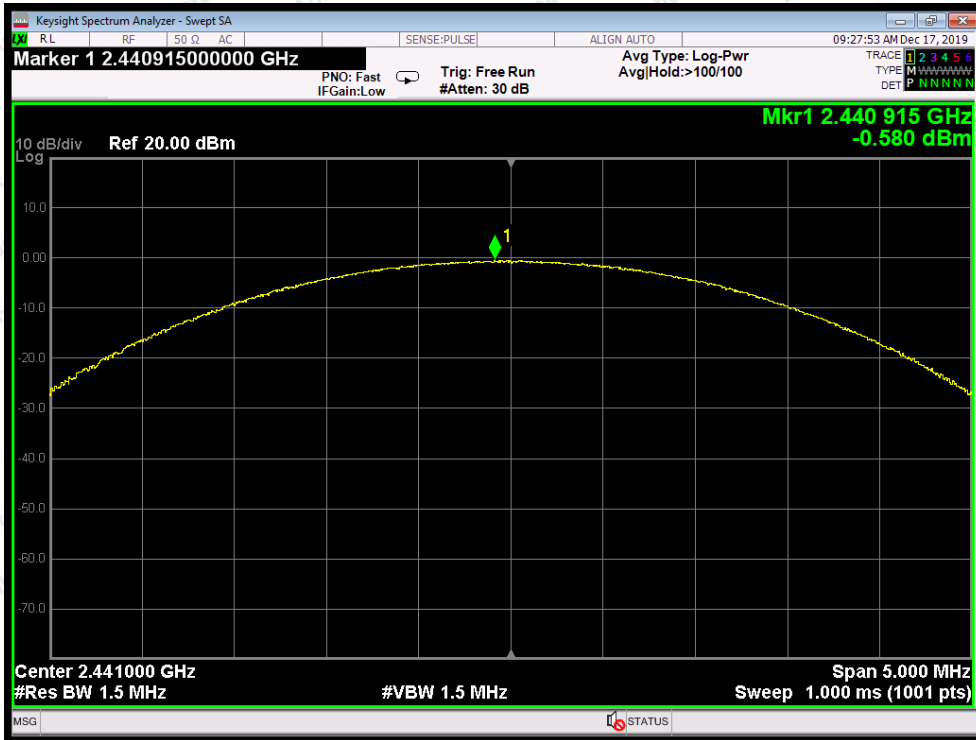

Test Mode: EDR---Middle

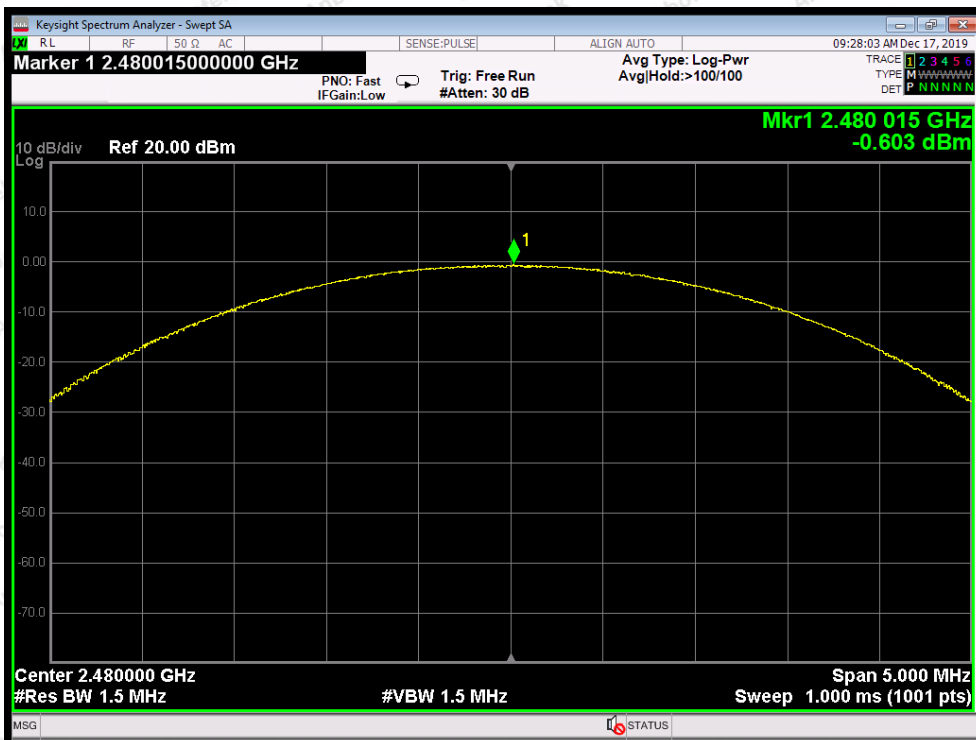

Test Mode: EDR---High

6. 20DB Occupy Bandwidth Test

6.1. Test Standard

Test Standard	FCC Part15 C Section 15.247 (a)(1)
---------------	------------------------------------

6.2. Test Setup

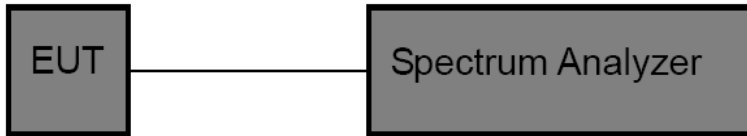

6.3. Test Procedure

Using the following spectrum analyzer settings:

1. Span= approximately 2 to 3 times the 20dB bandwidth, centered on a hopping channel.
2. Set the RBW = 30 kHz.
3. Set the VBW = 100 kHz.
4. Sweep time = auto couple.
5. Detector function = peak.
6. Trace mode = max hold.
7. Allow trace to fully stabilize.

6.4. Test Data

Test Item	: 20dB BW	Test Mode	: CH Low ~ CH High
Test Voltage	: AC 120V, 60Hz for adapter	Temperature	: 23.2° C
Test Result	: PASS	Humidity	: 49 %

Channel	Frequency(MHz)	20dB Down BW(kHz)	Modulation Mode
Low	2402	929.8	BDR
Middle	2441	933.5	BDR
High	2480	936.1	BDR
Low	2402	1266	EDR
Middle	2441	1266	EDR
High	2480	1261	EDR

Remark: The EDR was tested on (π/4QPSK, 8DPSK) modes, only the worst data of (8DPSK) is attached in the following pages.

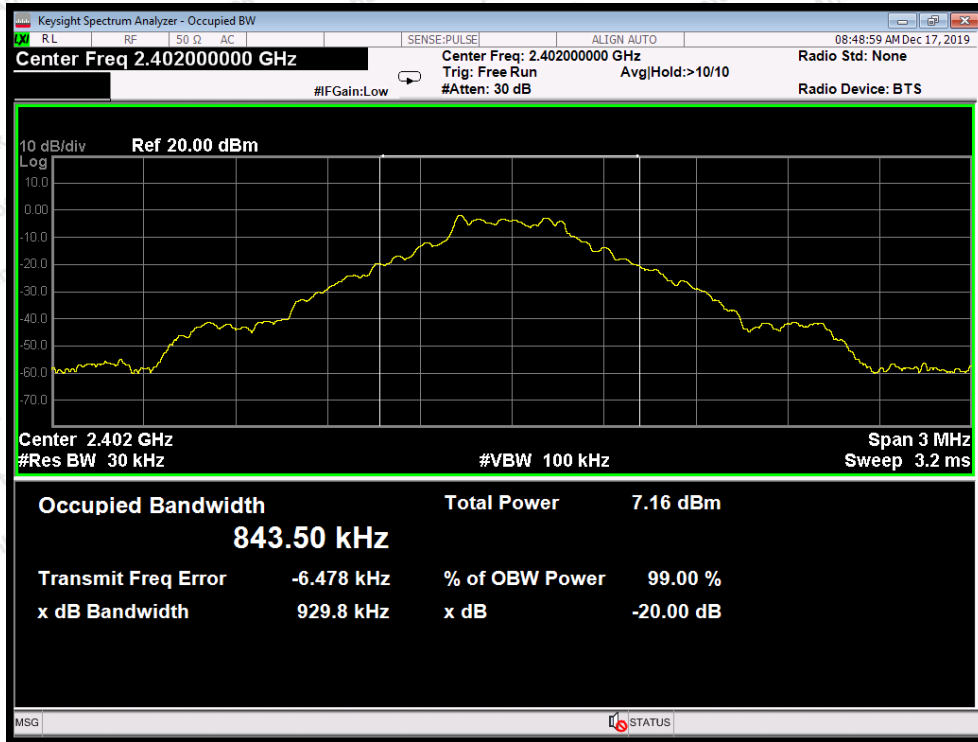

Test Mode: BDR---Low

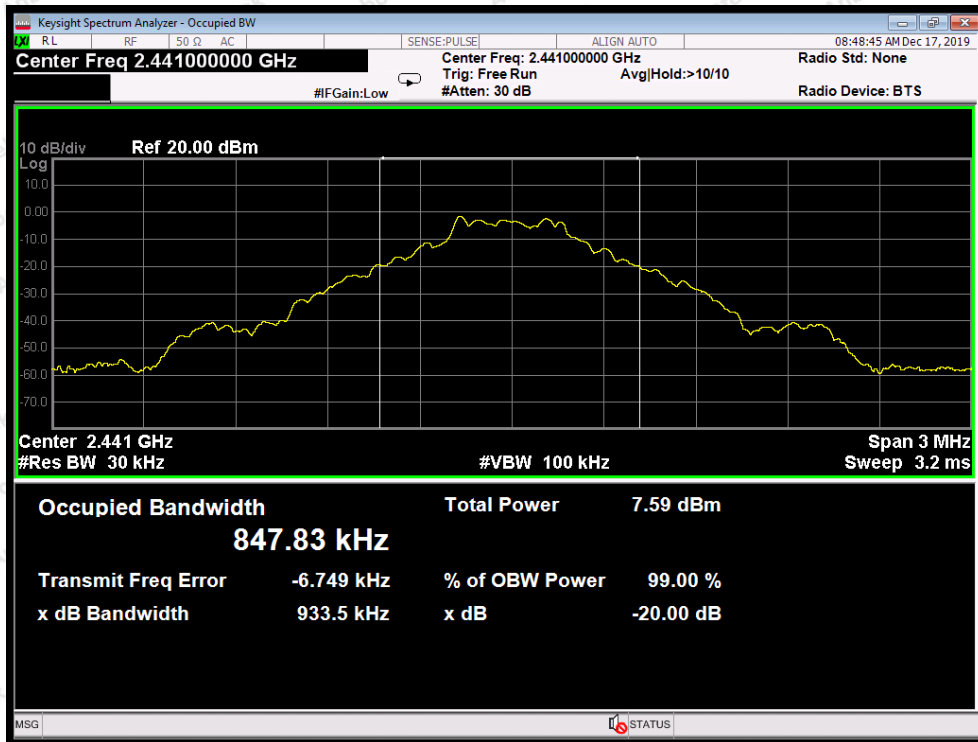

Test Mode: BDR---Middle

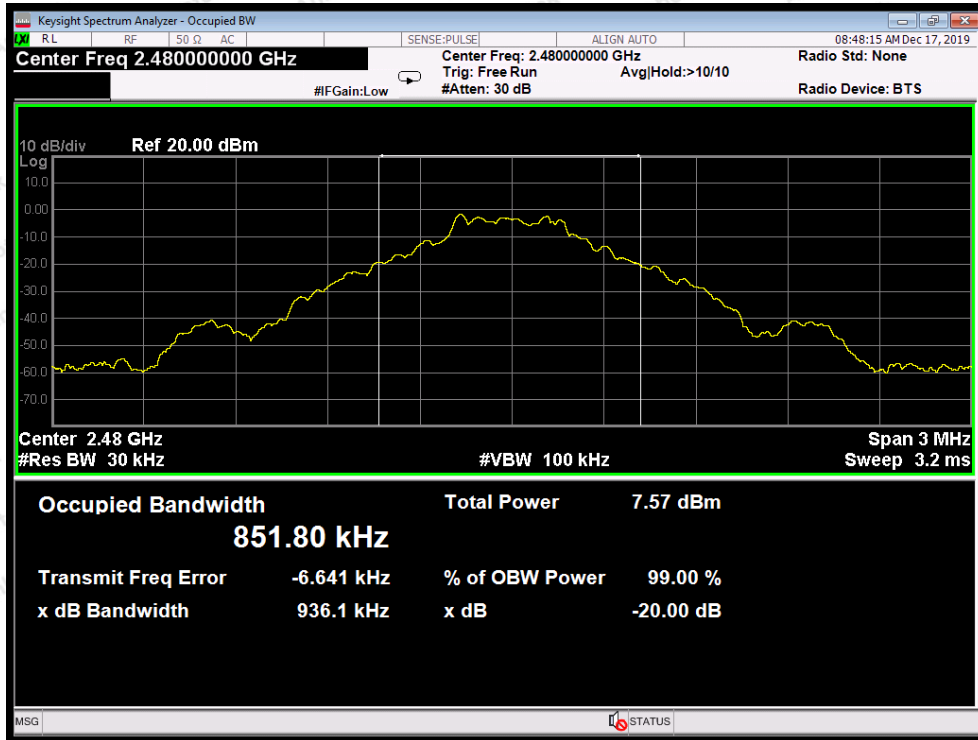

Test Mode: BDR---High

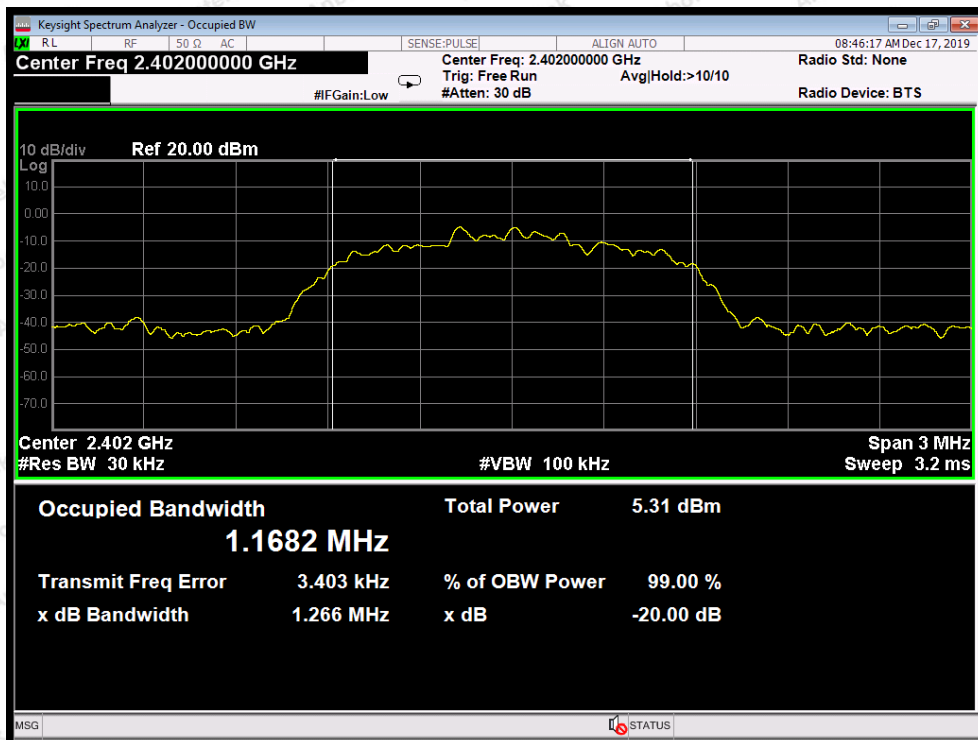

Test Mode: EDR---Low

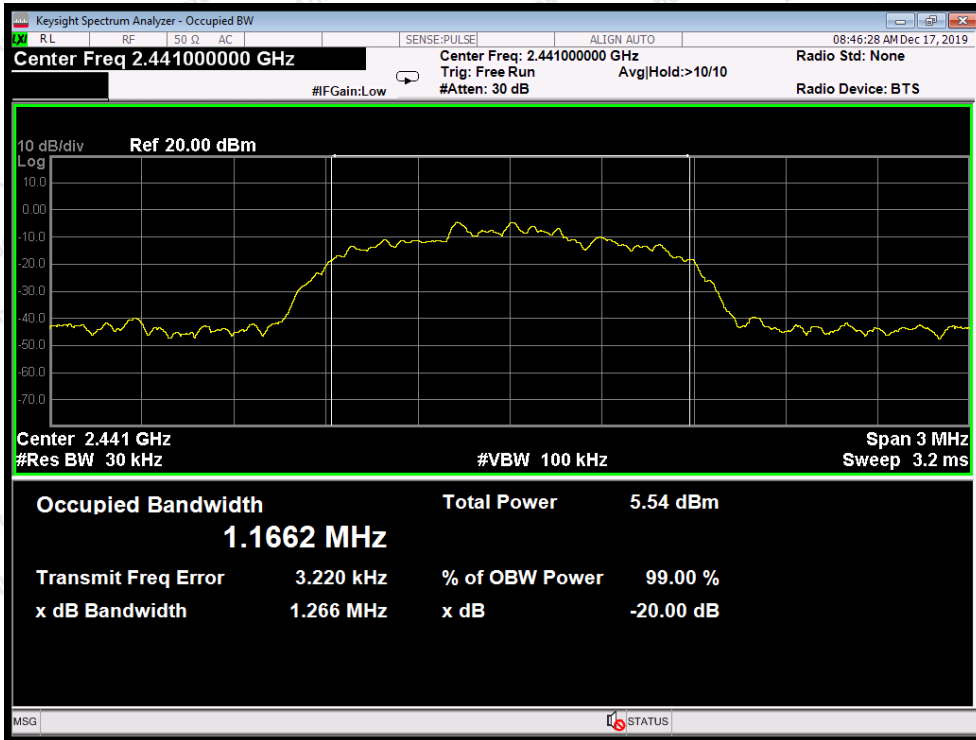

Test Mode: EDR---Middle

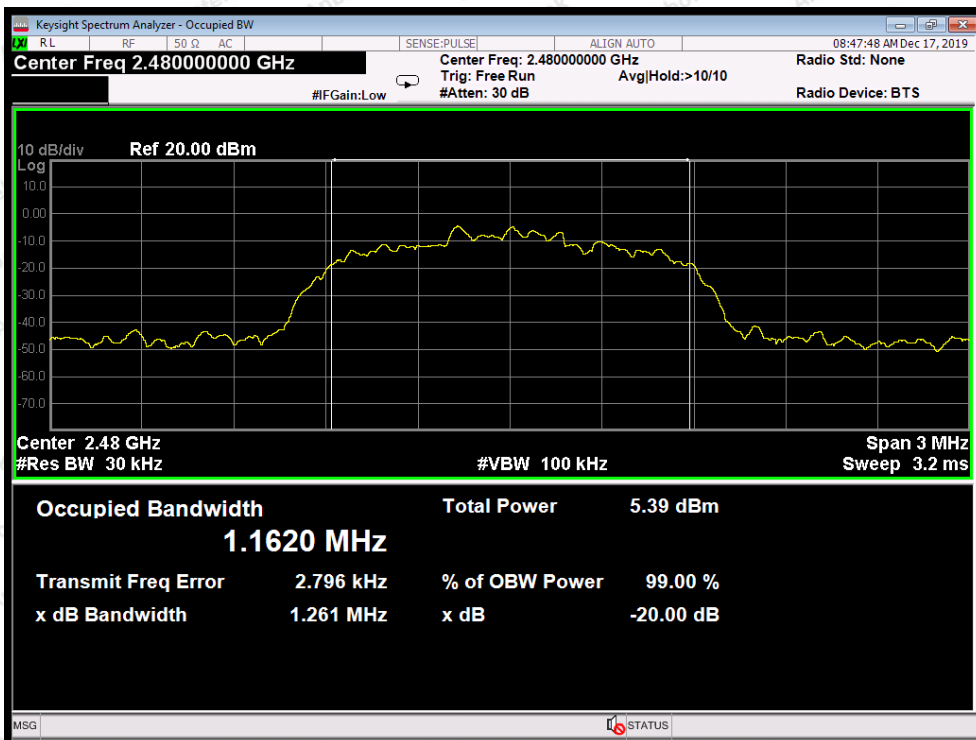

Test Mode: EDR---High

7. Carrier Frequency Separation Test

7.1. Test Standard and Limit

Test Standard	FCC Part15 C Section 15.247 (a)(1)
Test Limit	>25KHz or >two-thirds of the 20 dB bandwidth

7.2. Test Setup

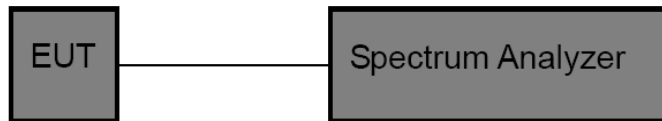

7.3. Test Procedure

The EUT must have its hopping function enabled. Using the following spectrum analyzer settings:

1. Span= Wide enough to capture the peaks of two adjacent channels
2. Set the RBW = 30 kHz.
3. Set the VBW = 100 kHz.
4. Sweep time = auto couple.
5. Detector function = peak.
6. Trace mode = max hold.
7. Allow trace to fully stabilize.

7.4. Test Data

Test Item	: Frequency Separation	Test Mode	: CH Low ~ CH High
Test Voltage	: AC 120V, 60Hz for adapter	Temperature	: 23.2° C
Test Result	: PASS	Humidity	: 49 %

Channel	Frequency (MHz)	Separation Read Value (kHz)	Limit (kHz)	Modulation Mode
Low	2402	1000	929.8	BDR
Middle	2441	1000	933.5	BDR
High	2480	1000	936.1	BDR
Low	2402	1000	844.0	EDR
Middle	2441	1000	844.0	EDR
High	2480	1000	840.7	EDR

Remark: 1. The EDR was tested on ($\pi/4$ QPSK, 8DPSK) modes, only the worst data of (8DPSK) is attached in the following pages.
2. The limit is 2/3 of 20dB BW.



Test Mode: BDR---Low



Test Mode: BDR---Middle



Test Mode: BDR---High



Test Mode: EDR---Low



Test Mode: EDR---Middle



Test Mode: EDR---High

8. Number of Hopping Channel Test

8.1. Test Standard and Limit

Test Standard	FCC Part15 C Section 15.247 (a)(1)
Test Limit	>15 channels

8.2. Test Setup

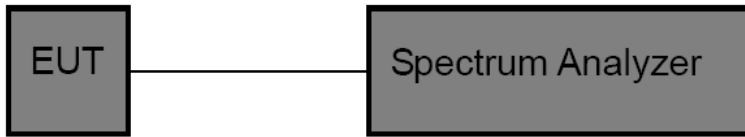

8.3. Test Procedure

The EUT must have its hopping function enabled. Using the following spectrum analyzer setting:

1. Span= the frequency band of operation
2. Set the RBW = 100kHz.
3. Set the VBW = 300kHz.
4. Sweep time = auto couple.
5. Detector function = peak.
6. Trace mode = max hold.
7. Allow trace to fully stabilize.

8.4. Test Data

Test Item : Number of Hopping Frequency
 Test Voltage : AC 120V, 60Hz for adapter
 Test Result : PASS

Test Mode : CH Low ~ CH High
 Temperature : 23.2° C
 Humidity : 49 %

Hopping Channel Frequency Range	Quantity of Hopping Channel	Quantity of Hopping Channel
2402-2480MHz	79	> 15

Remark: The EDR was tested on (π/4QPSK, 8DPSK) modes, only the worst data of (8DPSK) is attached in the following pages.

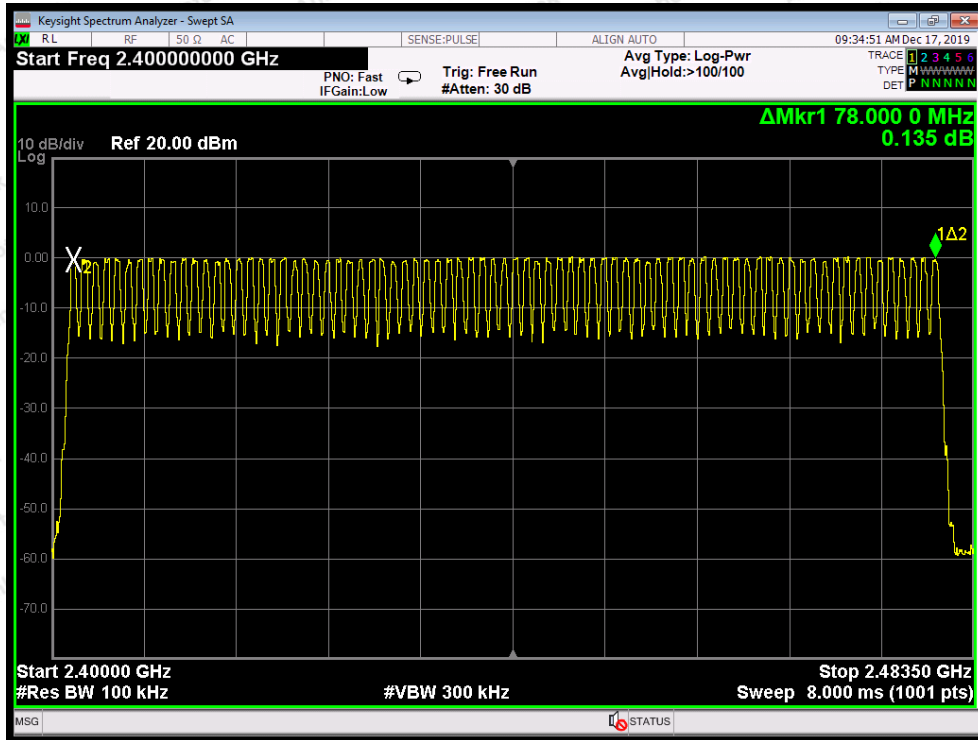

BDR Mode

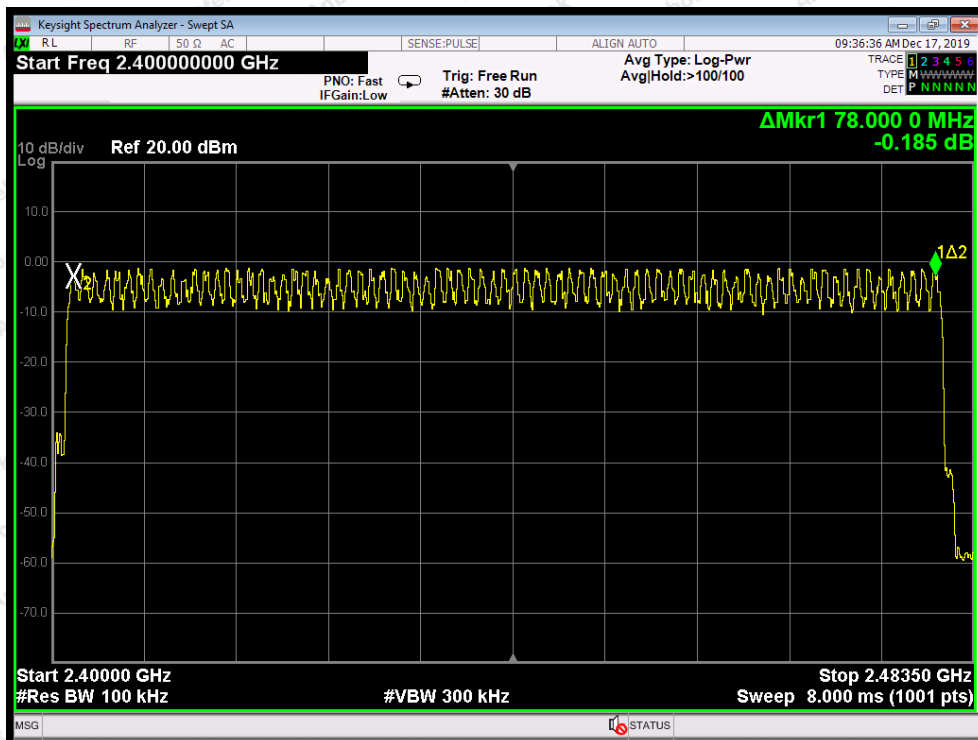

EDR Mode

9. Dwell Time Test

9.1. Test Standard and Limit

Test Standard	FCC Part15 C Section 15.247 (a)(1)
Test Limit	0.4 sec

9.2. Test Setup

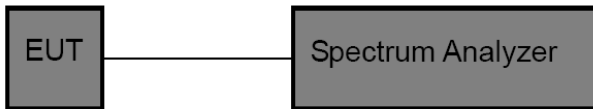

9.3. Test Procedure

The EUT must have its hopping function enabled. Use the following spectrum analyzer settings:

1. Span= zero span, centered on a hopping channel
2. Set the RBW = 1 MHz.
3. Set the VBW = 1 MHz.
4. Sweep time = as necessary to capture the entire dwell time per hopping channel.
5. Detector function = peak.
6. Trace mode = max hold.
7. Allow trace to fully stabilize.

9.4. Test Data

Test Item	: Time of Occupancy	Test Mode	: CH Low ~ CH High
Test Voltage	: AC 120V, 60Hz for adapter	Temperature	: 23.2° C
Test Result	: PASS	Humidity	: 49 %

Package Type	Pulse width (ms)	Time slot length(ms)	Dwell time (ms)	Limit (s)	Modulation
DH1	0.376	time slot length *1600/2 /79 * 31.6	120.32	0.4	BDR
DH3	1.630	time slot length *1600/4 /79 * 31.6	260.80	0.4	BDR
DH5	2.880	time slot length *1600/6 /79 * 31.6	307.20	0.4	BDR
3DH1	0.384	time slot length *1600/2 /79 * 31.6	122.88	0.4	EDR
3DH3	1.630	time slot length *1600/4 /79 * 31.6	260.80	0.4	EDR
3DH5	2.880	time slot length *1600/6 /79 * 31.6	307.20	0.4	EDR

Remark: The EDR was tested on (π /4QPSK, 8DPSK) modes, only the worst data of (8DPSK) is attached in the following pages.

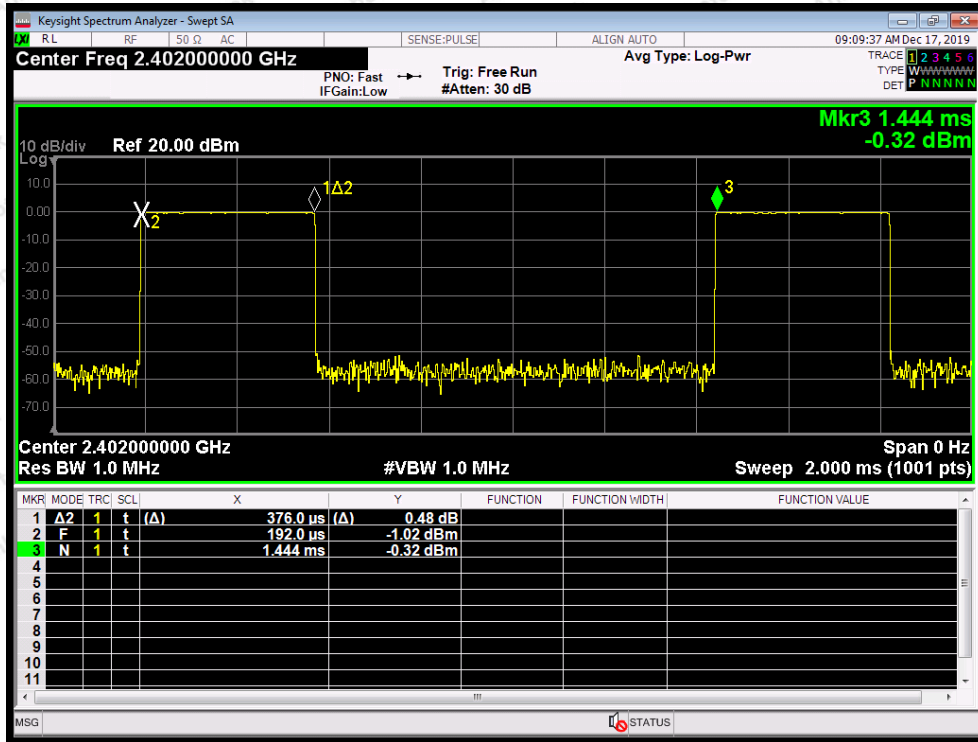

Test Mode: BDR---DH1

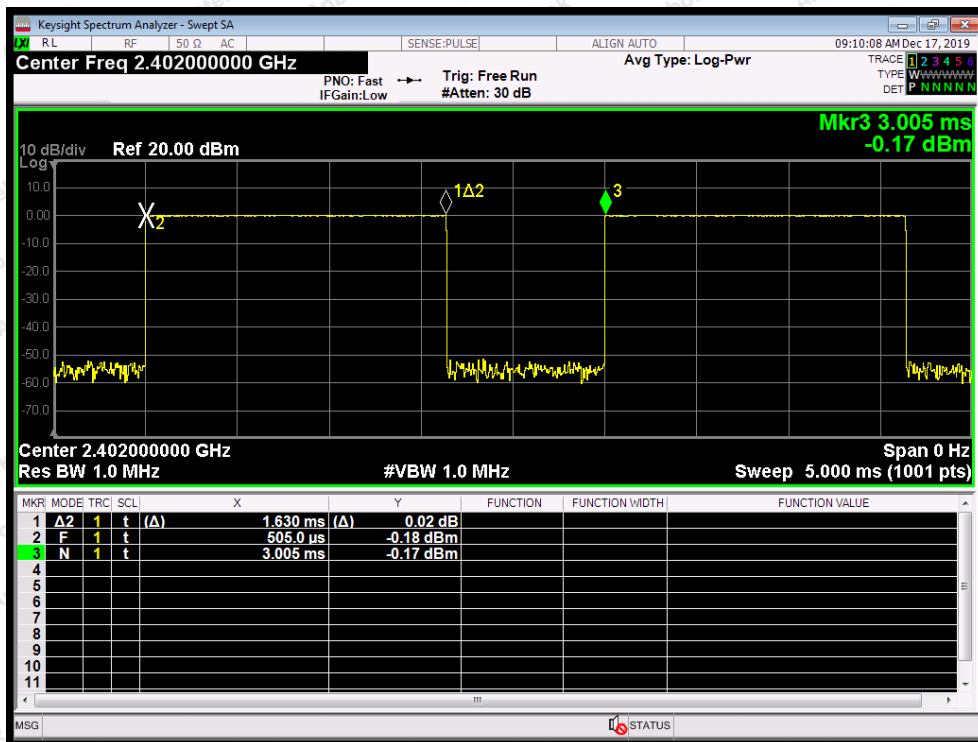

Test Mode: BDR---DH3

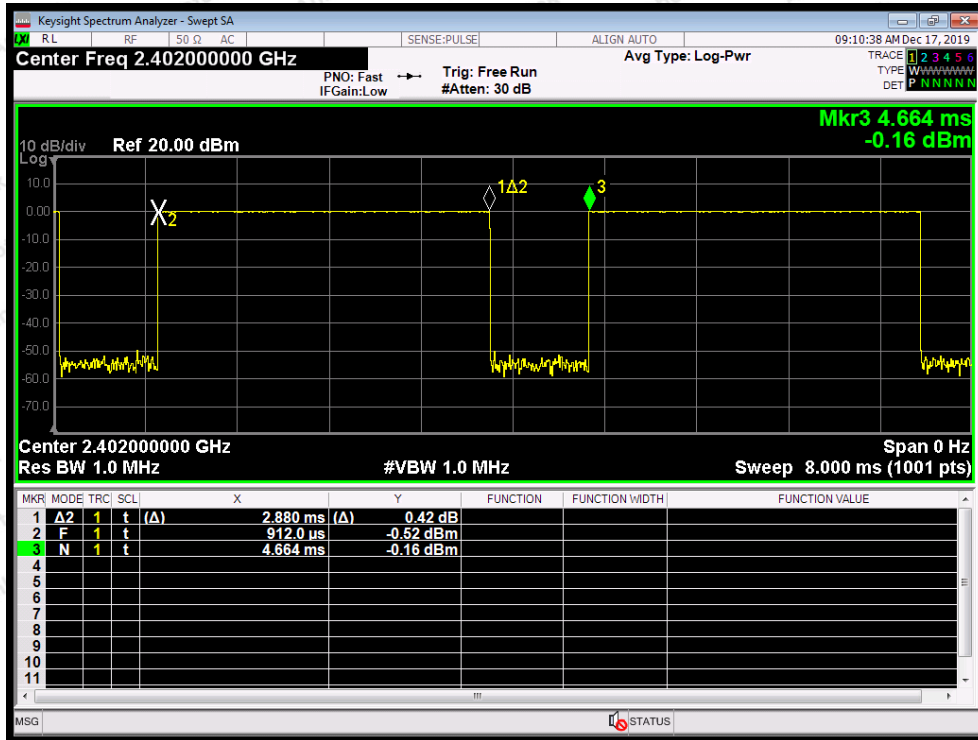

Test Mode: BDR---DH5

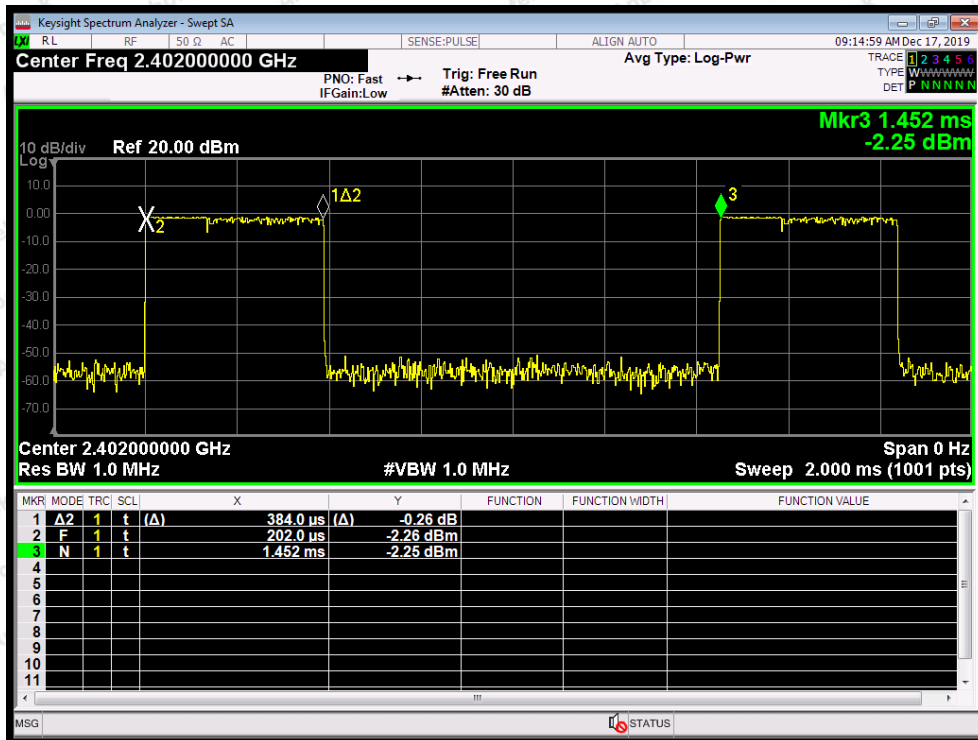

Test Mode: EDR---3DH1

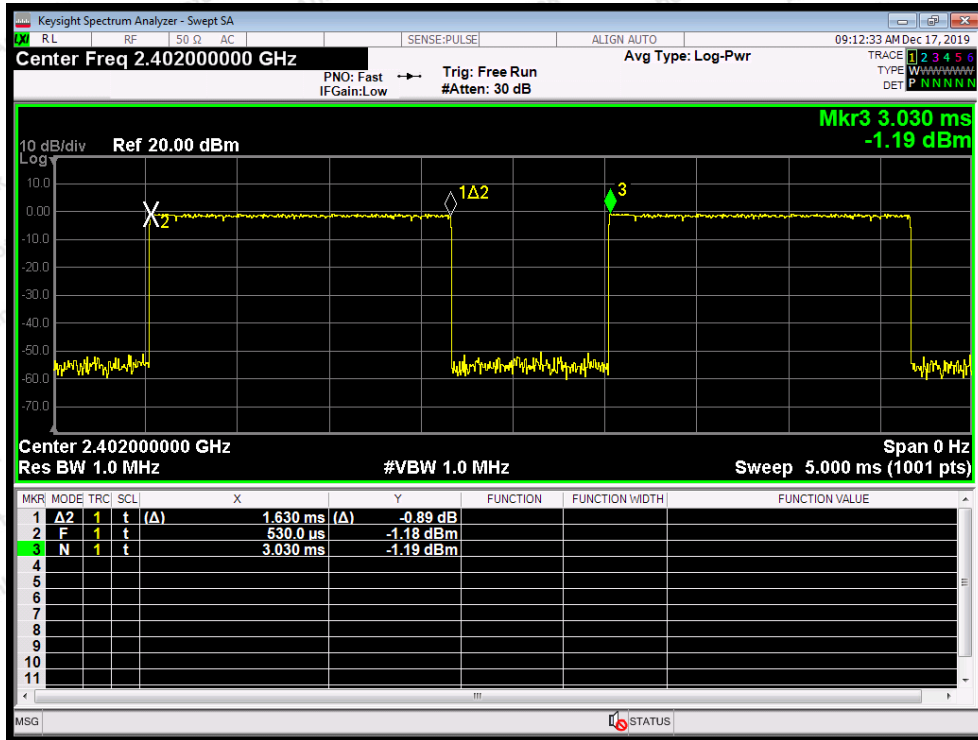

Test Mode: EDR---3DH3

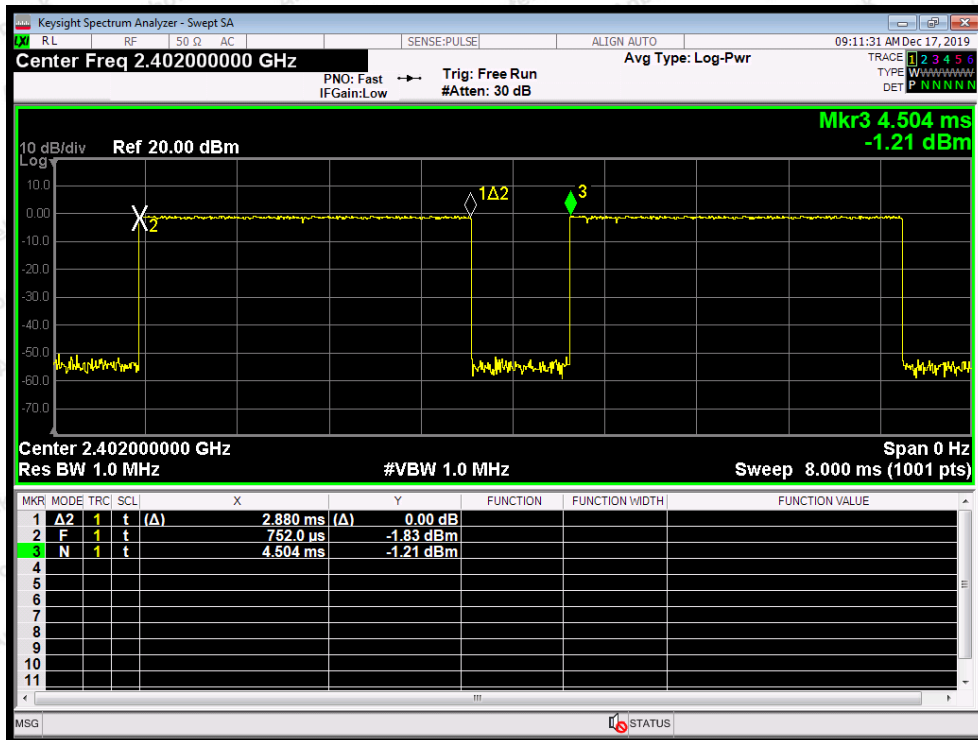

Test Mode: EDR---3DH5

10. 100kHz Bandwidth of Frequency Band Edge Requirement

10.1. Test Standard and Limit

Test Standard	FCC Part15 C Section 15.247 (d)
Test Limit	in any 100 kHz bandwidth outside the frequency bands in which the spread spectrum intentional radiator in operating, the radio frequency power that is produced by the intentional radiator shall be at least 20dB below that in the 100kHz bandwidth within the band that contains the highest level of the desired power, In addition, radiated emissions which fall in the restricted bands, as defined in §15.205(a), must also comply with the radiated emission limits specified in 15.209(a).

10.2. Test Setup

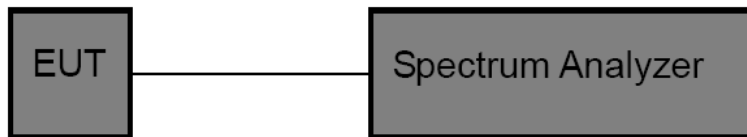

10.3. Test Procedure

The EUT must have its hopping/Non-hopping function enabled. Using the following spectrum analyzer setting:

1. Set the RBW = 100kHz.
2. Set the VBW = 300kHz.
3. Sweep time = auto couple.
4. Detector function = peak.
5. Trace mode = max hold.
6. Allow trace to fully stabilize.

10.4. Test Data

Test Item	: Band edge
Test Voltage	: AC 120V, 60Hz for adapter
Test Result	: PASS

Test Mode	: CH Low ~ CH High
Temperature	: 23.2° C
Humidity	: 49 %

Remark: The EDR was tested on (π/4QPSK, 8DPSK) modes, only the worst data of (π/4DQPSK) is attached in the following pages.

For Hopping Mode

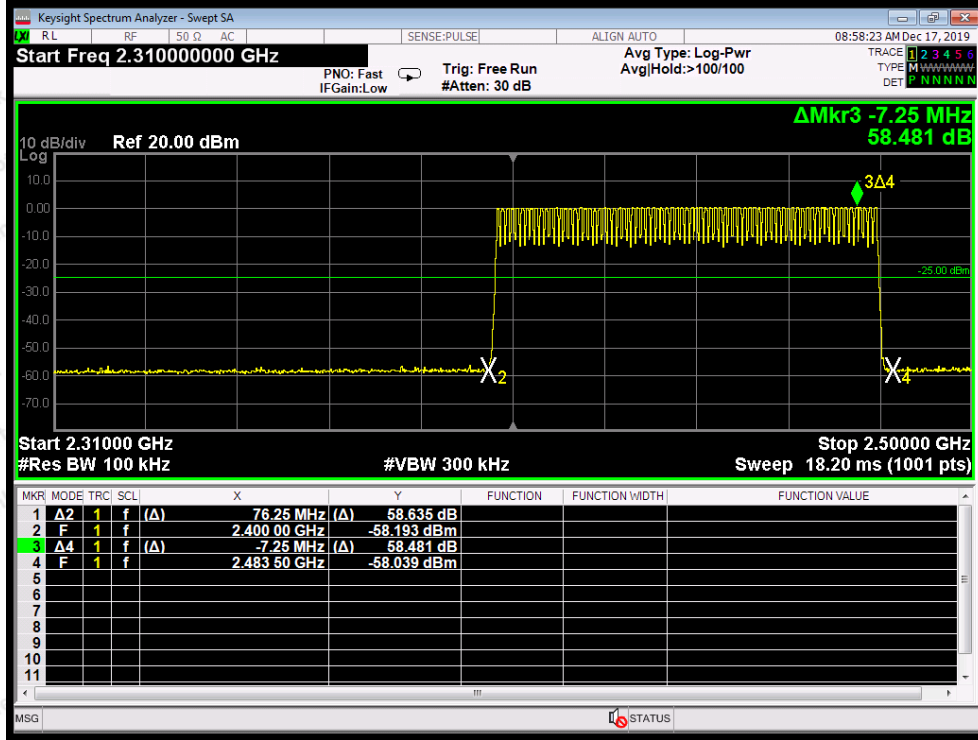

BDR mode

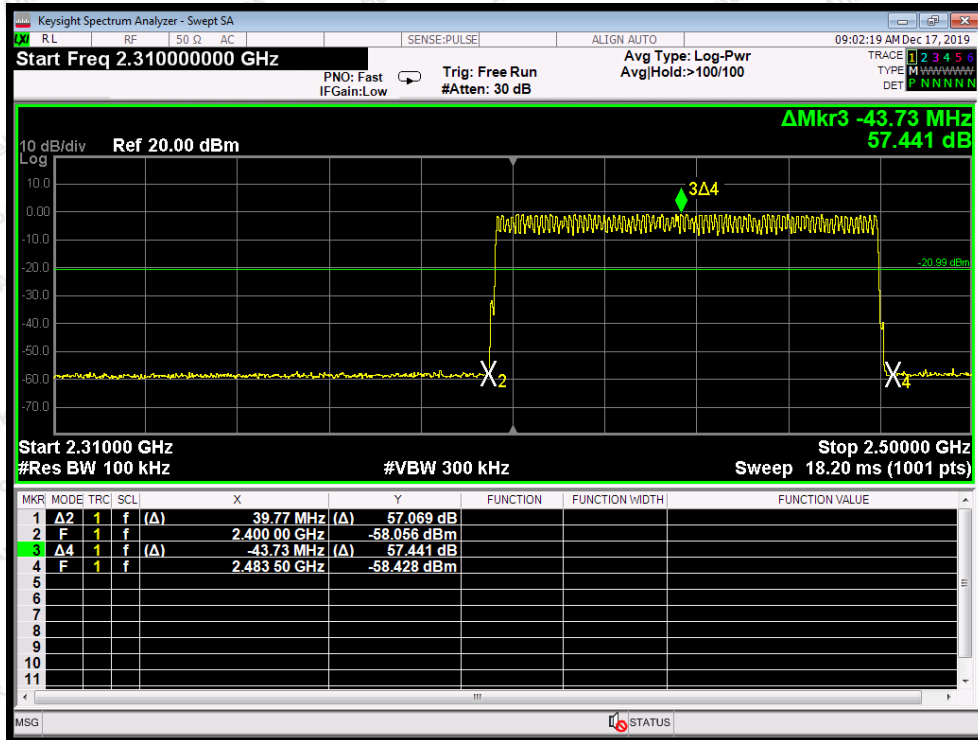

EDR mode

For Non-Hopping Mode

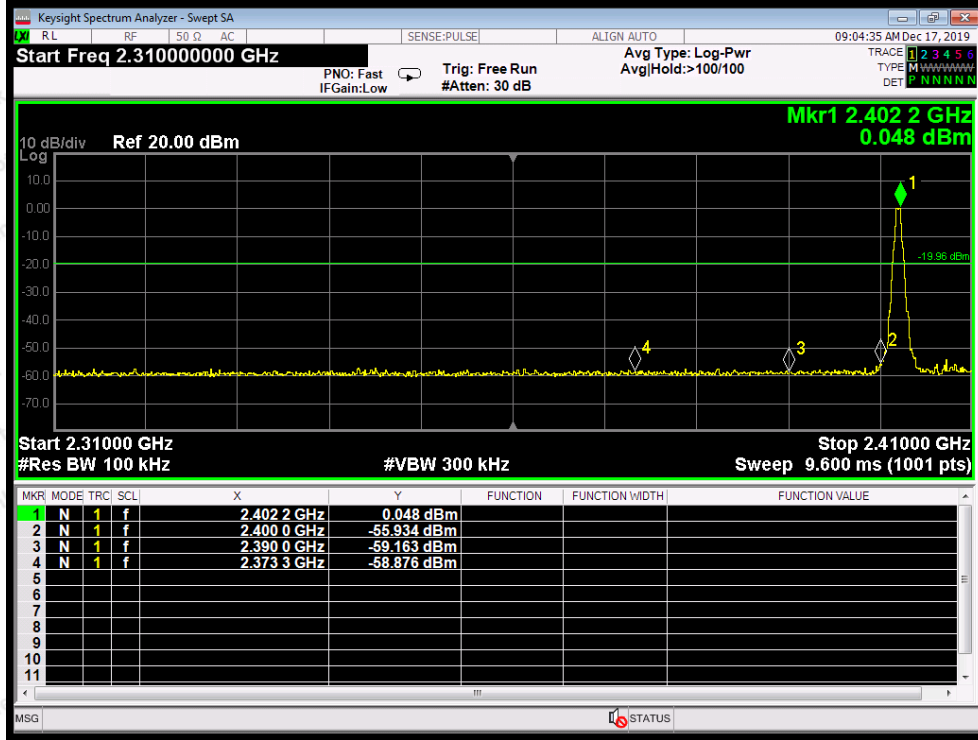

BDR mode -- Lowest

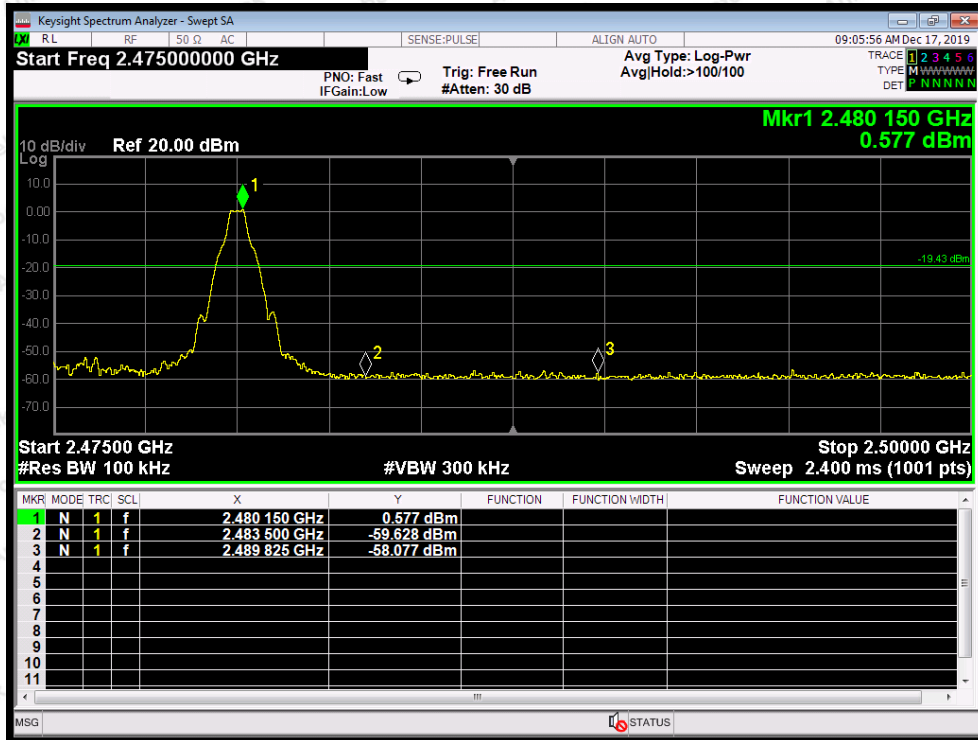

BDR mode -- Highest

For Non-Hopping Mode

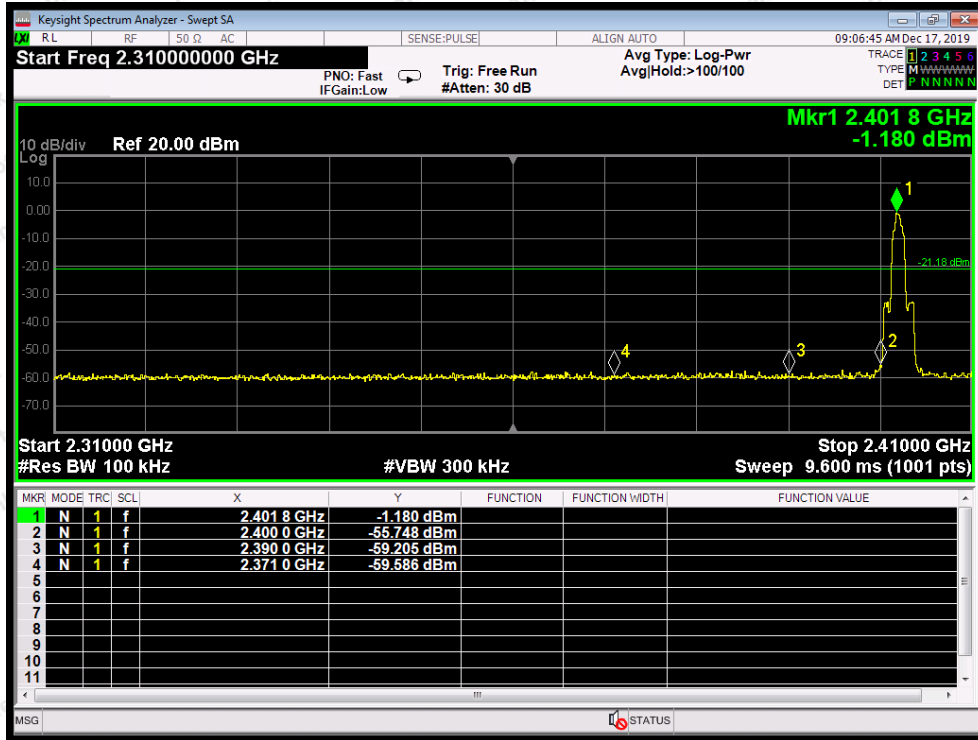

EDR mode -- Lowest

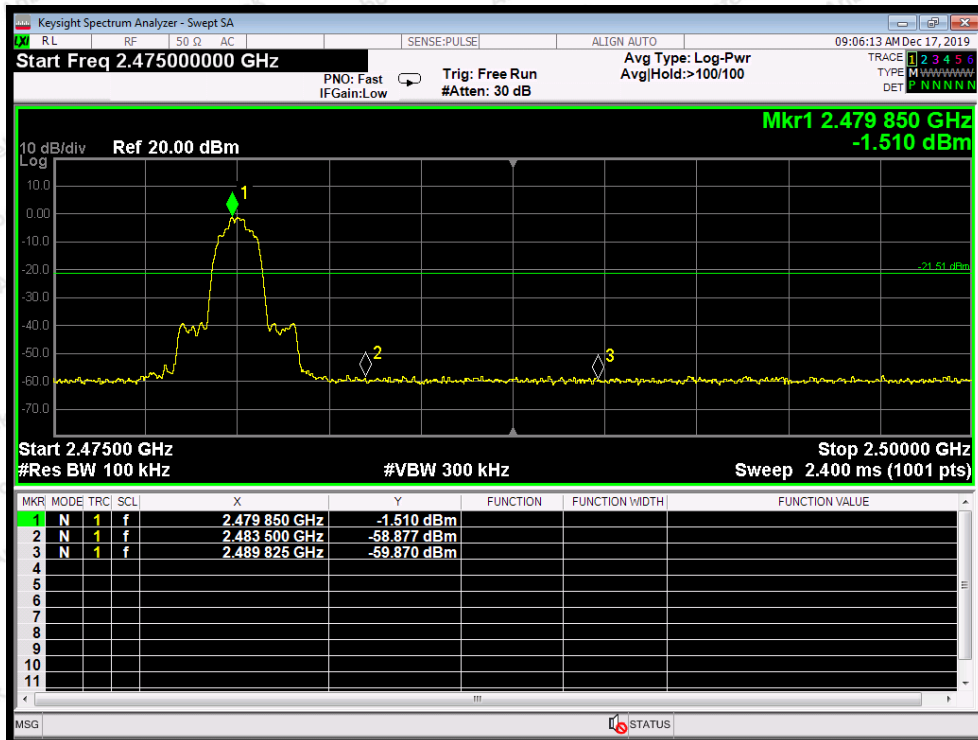

EDR mode -- Highest

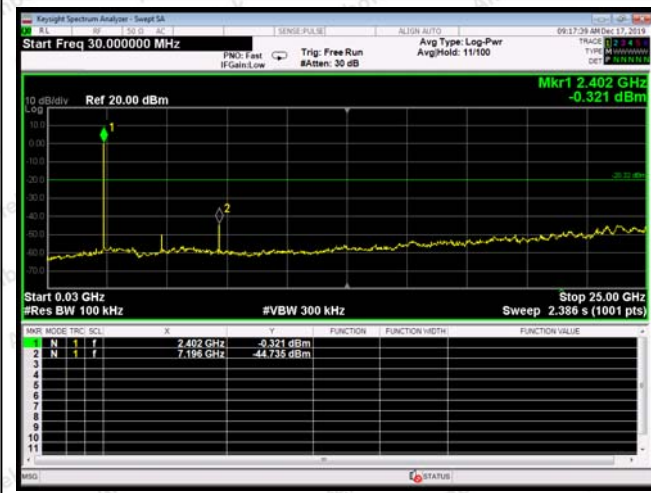

Test Mode: BDR---Low

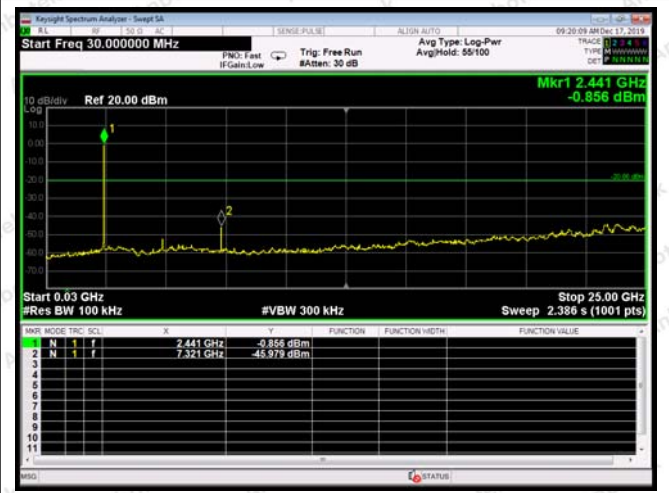

Test Mode: BDR---Mid

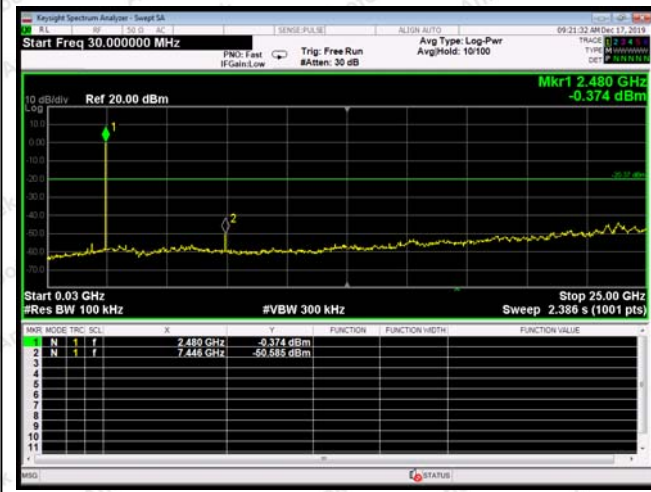

Test Mode: BDR---High

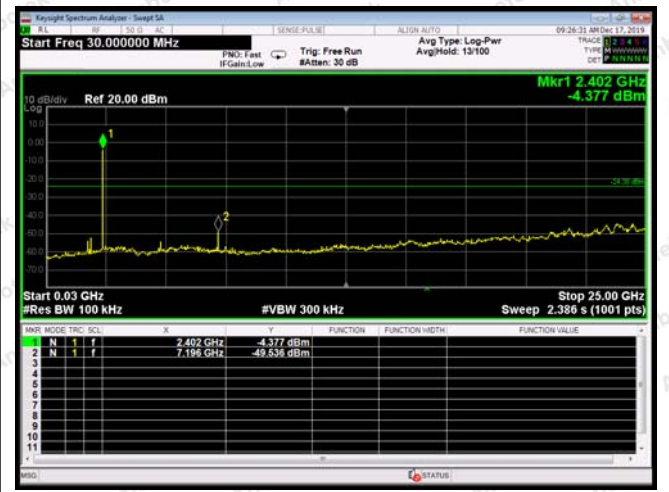

Test Mode: EDR---Low

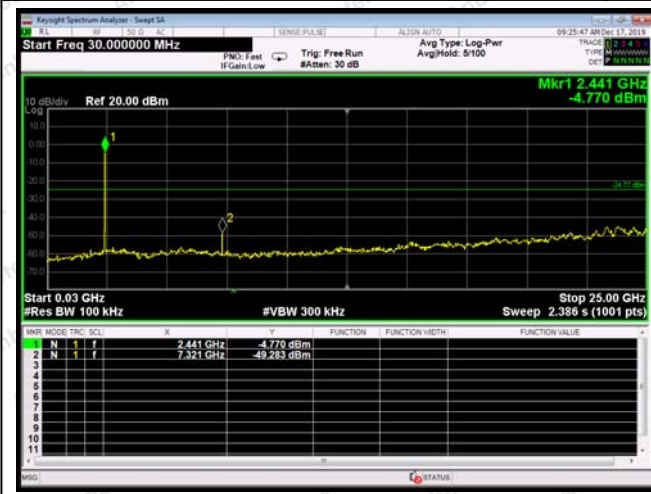

Test Mode: EDR---Mid

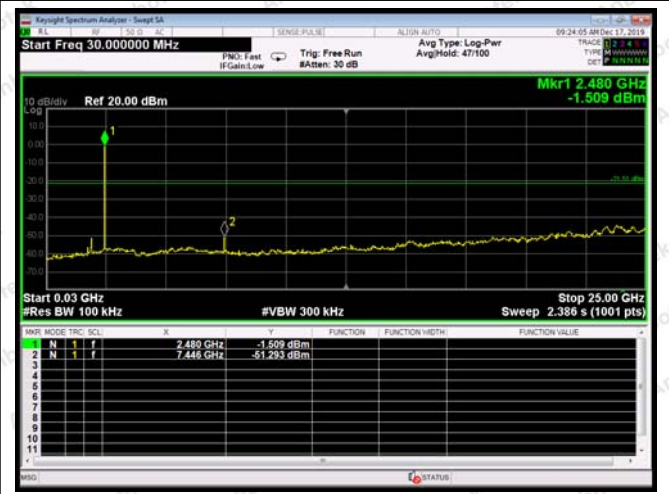

Test Mode: EDR---High

11. Antenna Requirement

11.1. Test Standard and Requirement

Test Standard	FCC Part15 Section 15.203 /247(c)
Requirement	<p>1) 15.203 requirement: An intentional radiator shall be designed to ensure that no antenna other than that furnished by the responsible party shall be used with the device. The use of a permanently attached antenna or of an antenna that uses a unique coupling to the intentional radiator, the manufacturer may design the unit so that a broken antenna can be replaced by the user, but the use of a standard antenna jack or electrical connector is prohibited.</p> <p>2) 15.247(c) (1)(i) requirement: Systems operating in the 2400-2483.5 MHz band that is used exclusively for fixed. Point-to-point operations may employ transmitting antennas with directional gain greater than 6dBi provided the maximum conducted output power of the intentional radiator is reduced by 1 dB for every 3 dB that the directional gain of the antenna</p>

11.2. Antenna Connected Construction

The antenna is PCB Antenna which permanently attached, and the best case gain of the antenna is 0 dBi. It complies with the standard requirement.

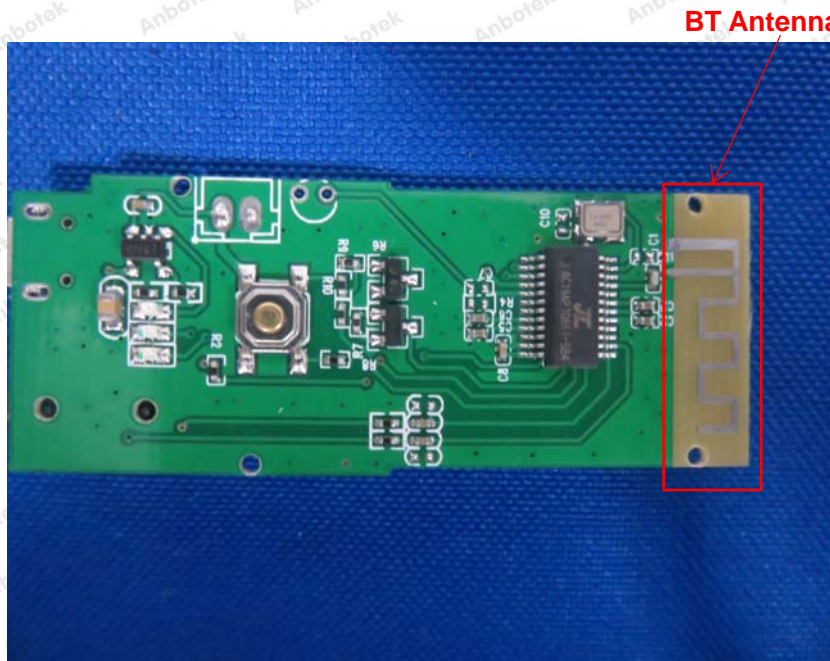

APPENDIX I -- TEST SETUP PHOTOGRAPH

Photo of Conducted Emission Measurement

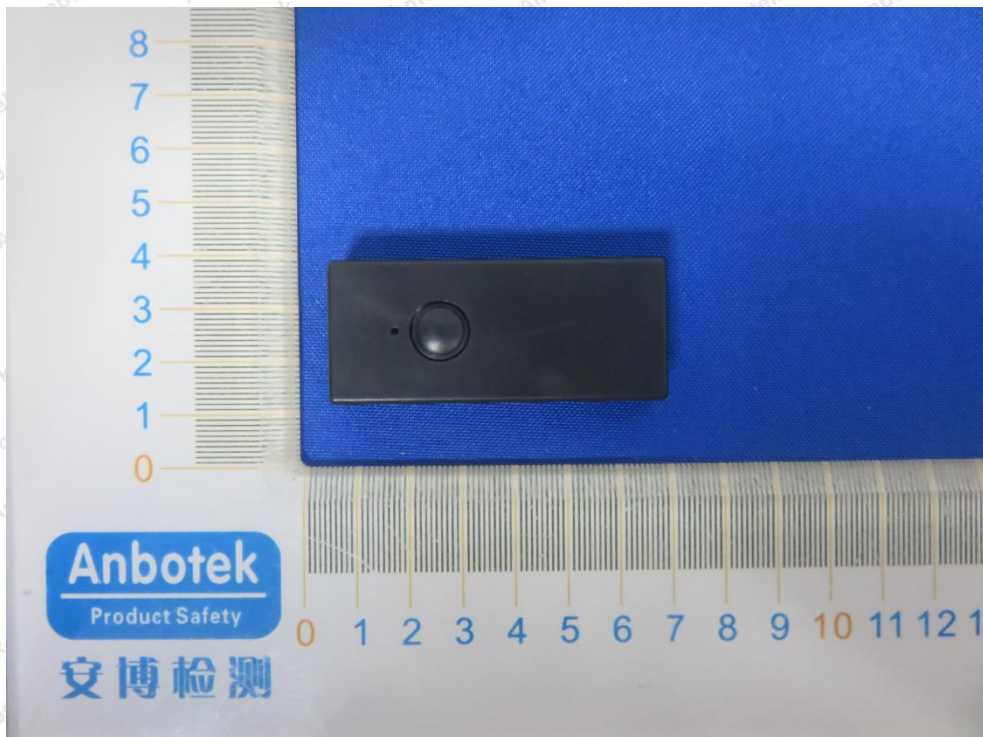

Photo of Radiation Emission Test





APPENDIX II -- EXTERNAL PHOTOGRAPH



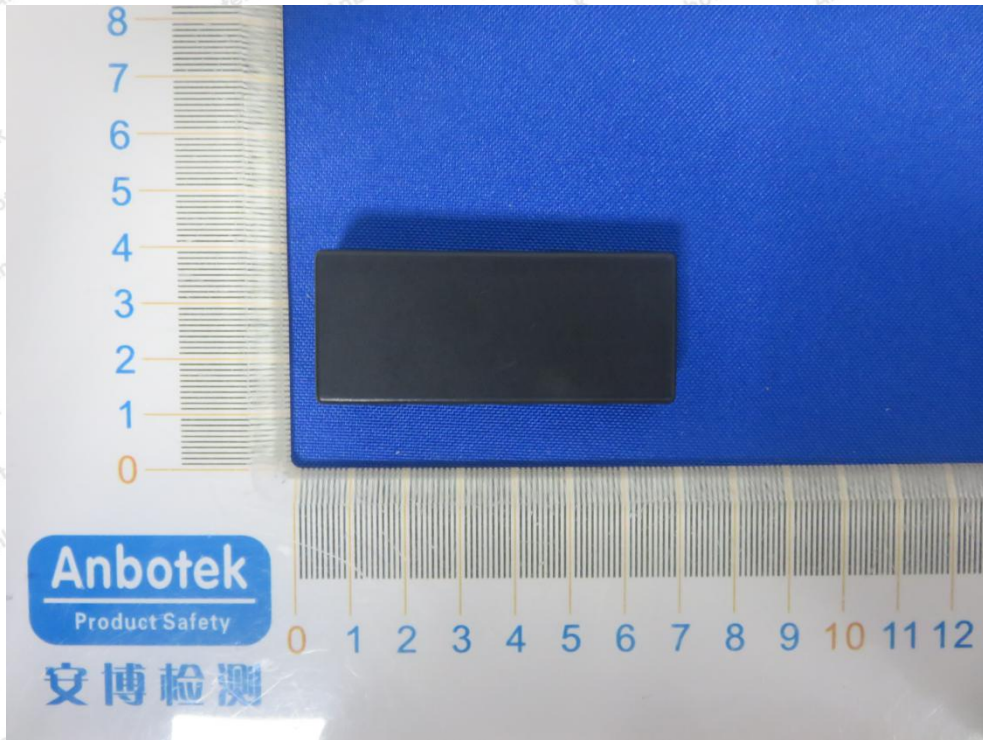

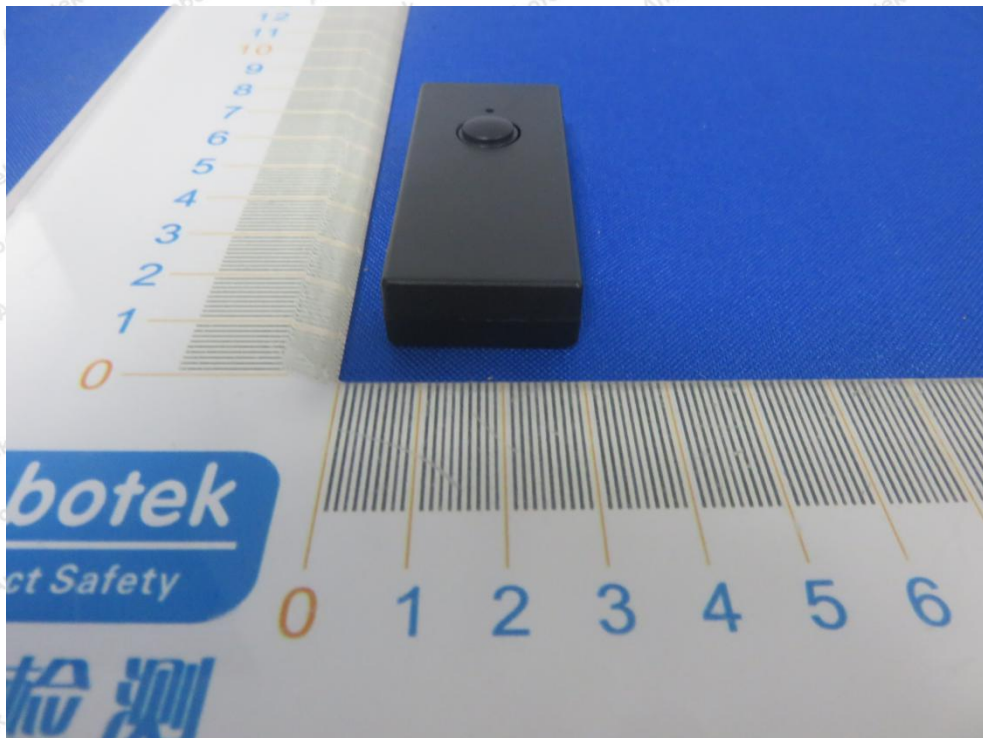

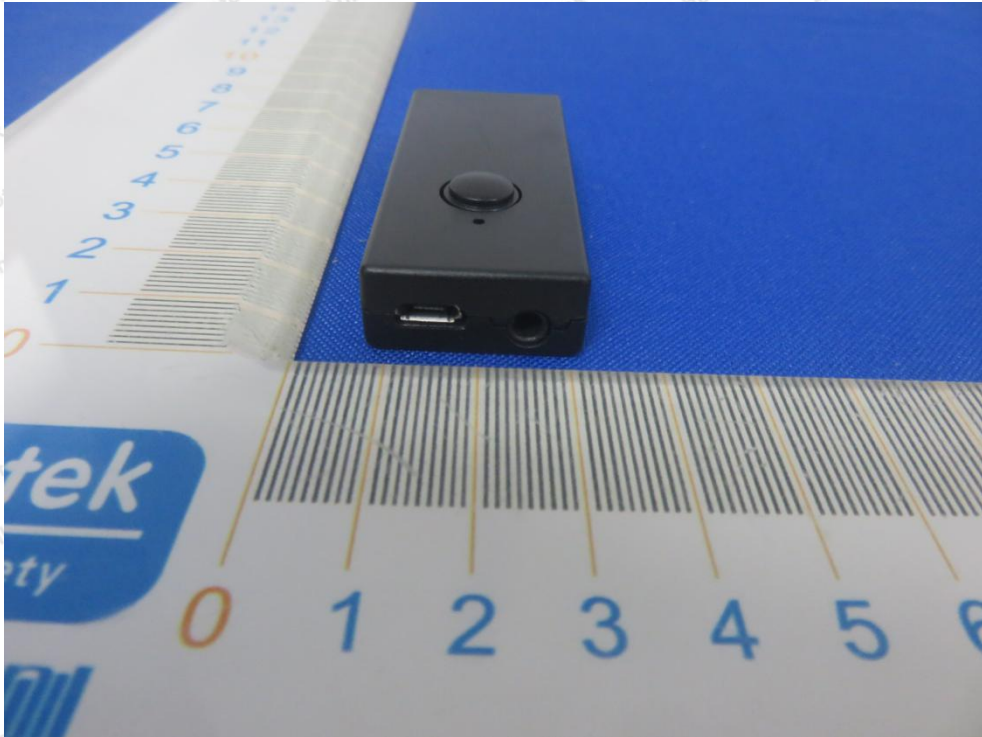

APPENDIX III -- INTERNAL PHOTOGRAPH

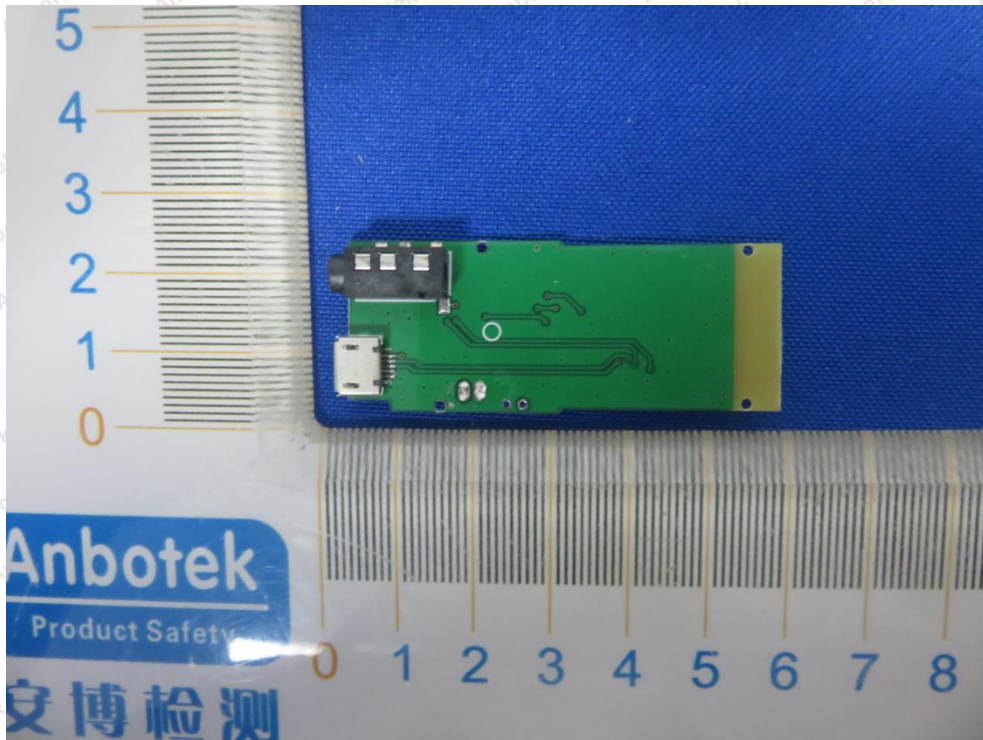
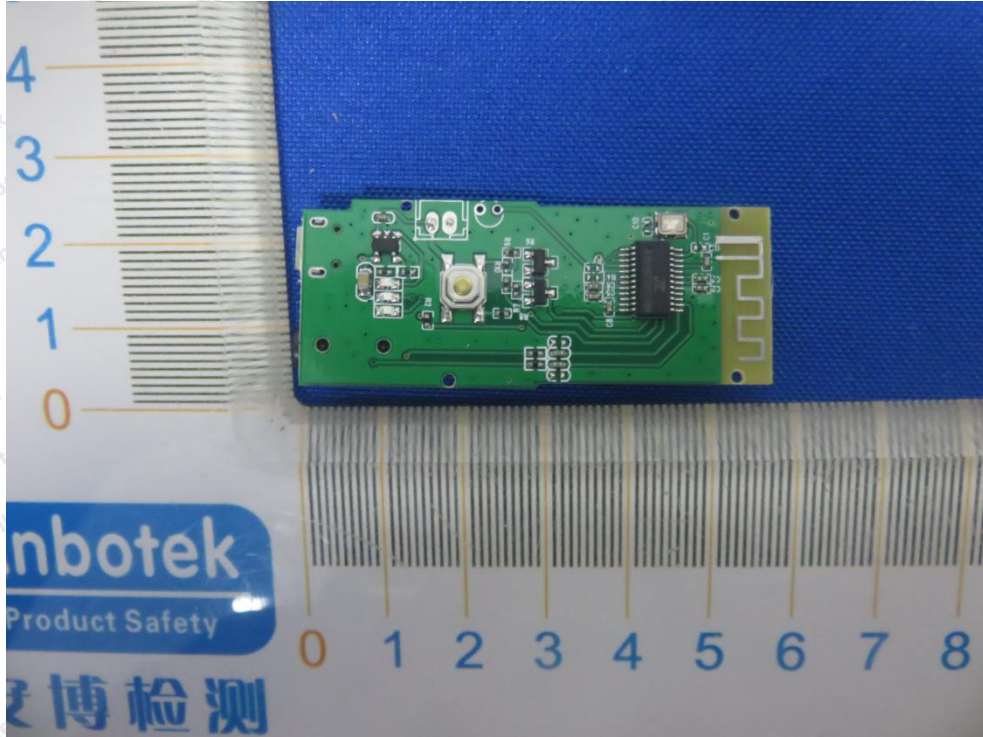

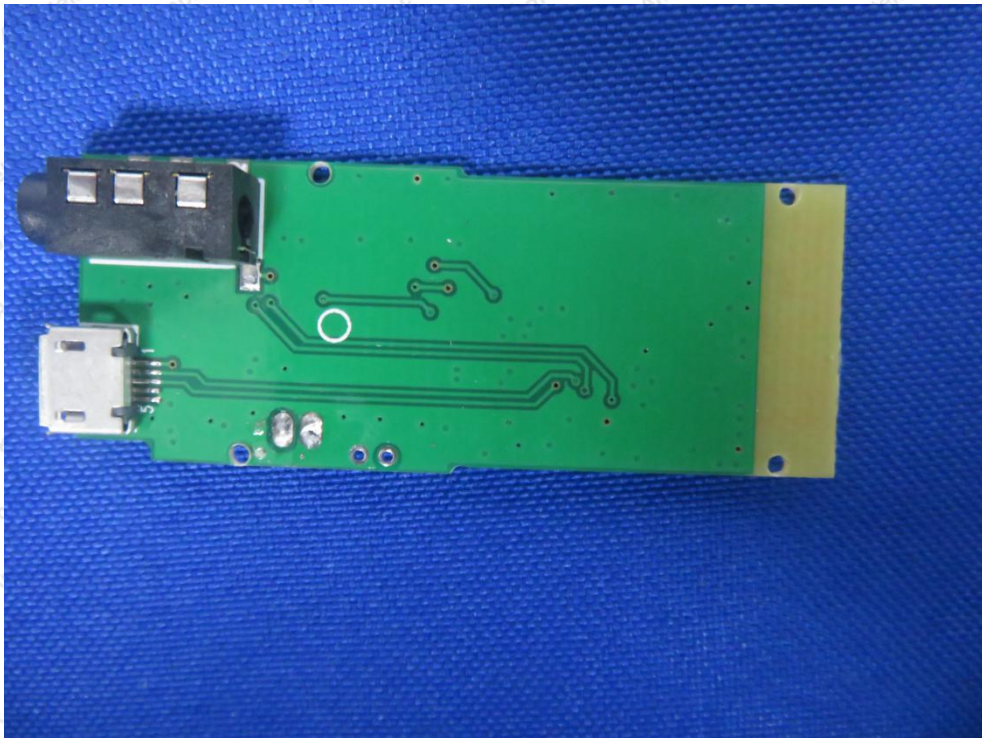
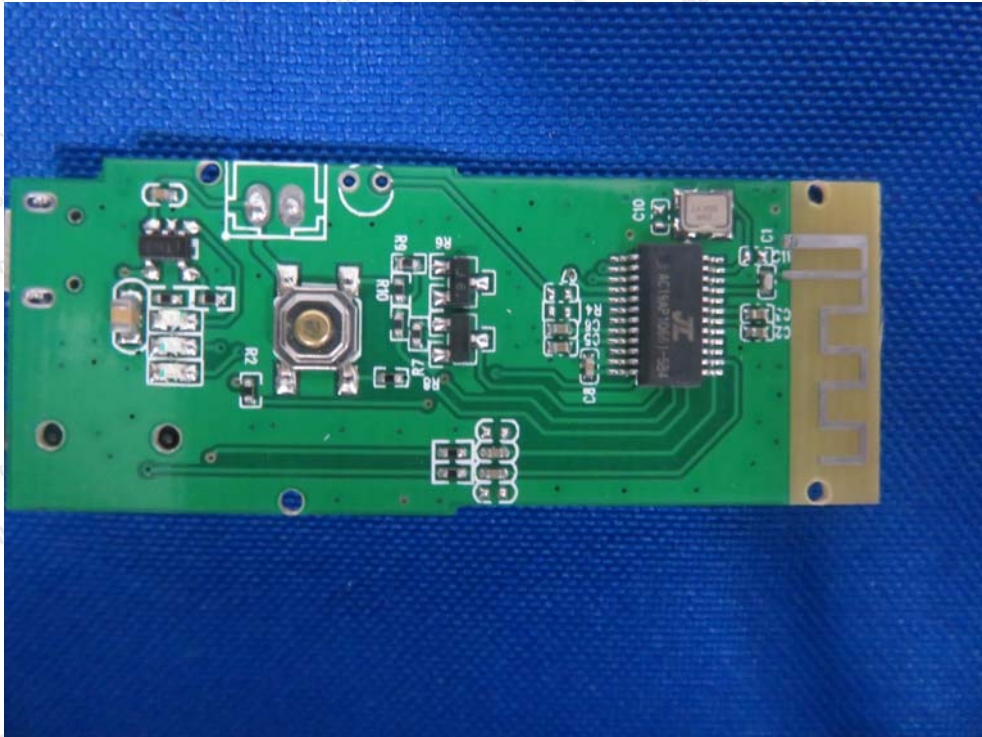

----- End of Report -----