

## Maintenance display

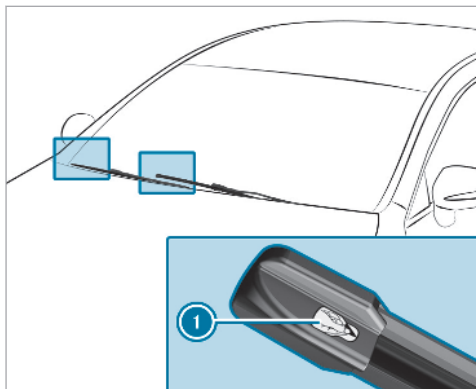

- ▶ Remove protective film ① from the maintenance display on the tip of the newly fitted wiper blades.

When the colour of the maintenance display changes from black to yellow, the wiper blades should be replaced.

- ① The duration until the colour changes varies depending on the usage conditions.

## Replacing the windscreen wiper blades (MAGIC VISION CONTROL)

### Moving the wiper arms into the replacement position

- ▶ Switch the ignition off.
- ▶ Within around 15 seconds, press the button on the combination switch  (→ page 152). The wiper arms will move into the replacement position.

## Removing the wiper blades

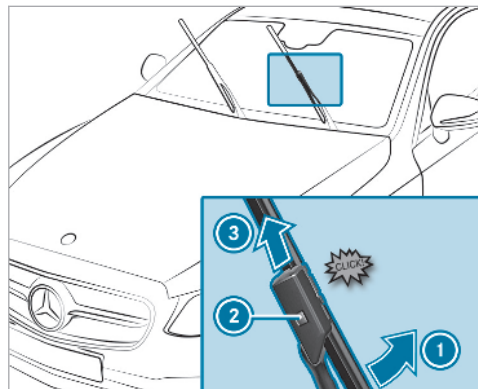

- ▶ **To bring the wiper blade into position to be removed:** hold the wiper arm firmly in one hand. With the other hand, turn the wiper blade in the direction of arrow ① beyond the point of resistance. The wiper blade will engage in the removal position with a click.

- ▶ **To remove the wiper blade:** press release knob ②, pull the wiper blade in the direction of arrow ③ and remove.

### Fitting the wiper blades

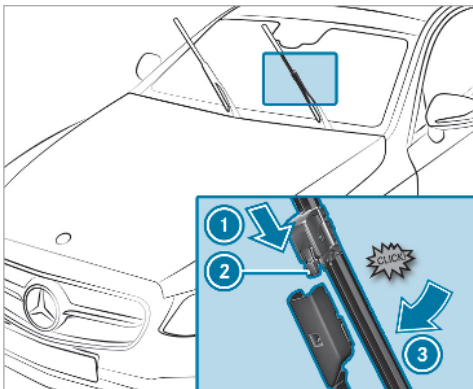

- ▶ Push the new wiper blade onto the wiper arm in the direction of arrow ① until release knob ② engages.

- ▶ Press the wiper blade onto the wiper arm in the direction of arrow ③ beyond the point of resistance. The wiper blade will engage with a noticeable click and move freely again.
- ▶ Fold the wiper arm back onto the wind-screen.

## Mirrors

### Operating the outside mirrors

- ⚠ **WARNING** Risk of accident due to adjusting vehicle settings while the vehicle is in motion

You could lose control of the vehicle in the following situations in particular:

- If you adjust the driver's seat, the head restraints, the steering wheel or the mirror while the vehicle is in motion.
- If you fasten your seat belt while the vehicle is in motion.

- ▶ Before starting the engine: adjust the driver's seat, the head restraints, the steering wheel and the mirror and fasten your seat belt.

- ⚠ **WARNING** Risk of accident due to misjudgement of distance when using the outside mirror

The outside mirrors reflect objects on a smaller scale. The objects in view are in fact closer than they appear.

- ▶ Therefore, always look over your shoulder in order to ensure that you are aware of the actual distance between you and the road users driving behind you.

## Folding the outside mirrors in/out

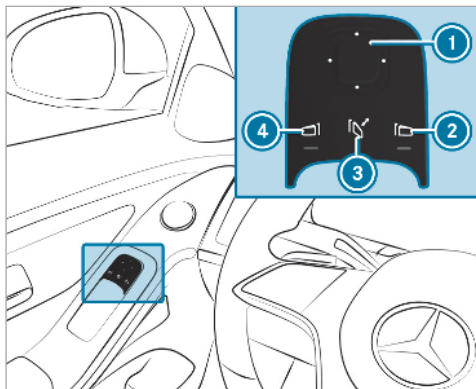

- ▶ Briefly press button ③.

## Resetting the outside mirrors

- ① If the battery has been disconnected or completely discharged, the outside mirrors must be reset. Only then will the automatic mirror folding function work properly.
- ▶ Briefly press button ③.

## Adjusting the outside mirrors

- ▶ Select the required mirror using button ② or ④.
- ① In vehicles with MBUX Interior Assistant, the required outside mirror can also be preselected automatically via a natural head movement to the left or right (→ page 317).
- ▶ Use button ① to set the position of the mirror you have selected.

## Engaging the outside mirrors

- ▶ Press and hold button ③. You will hear a click and the mirror will audibly click into place. The mirror will now be set to the correct position.

## Automatic anti-dazzle mirrors function

**⚠ WARNING** Risk of acid burns and poisoning due to the anti-dazzle mirror electrolyte

Electrolyte may escape if the glass in an automatic anti-dazzle mirror breaks.

The electrolyte is hazardous to health and causes irritation. It must not come into contact with your skin, eyes, respiratory organs or clothing or be swallowed.

- ▶ If you come into contact with electrolyte, observe the following:
  - Immediately rinse the electrolyte from your skin with water and seek medical attention.
  - If electrolyte comes into contact with your eyes, immediately rinse them thoroughly with clean water and seek medical attention.
  - If the electrolyte is swallowed, immediately rinse your mouth out thoroughly. Do not induce vomiting. Seek medical attention immediately.
  - Immediately change out of clothing which has been contaminated with electrolyte.
  - If an allergic reaction occurs, seek medical attention immediately.

The inside rearview mirror and the outside mirror on the driver's side will automatically go into anti-dazzle mode if light from a headlamp hits the sensor on the inside rearview mirror.

### System limits

The system will not go into anti-dazzle mode if:

- the engine is switched off.
- reverse gear is engaged.
- the interior lighting is switched on.

### Front-passenger outside mirror parking position function

The parking position makes parking easier.

The front-passenger outside mirror will swivel downwards in the direction of the rear wheel on the front passenger's side when:

- the parking position is stored (→ page 158).
- the front-passenger mirror is selected.
- reverse gear is engaged.

The front-passenger outside mirror will move back to its original position when:

- you shift the transmission to another transmission position.
- you are travelling at a speed greater than 15 km/h.
- you press the button for the outside mirror on the driver's side.

### Storing the parking position of the front-passenger outside mirror using reverse gear

#### Storing

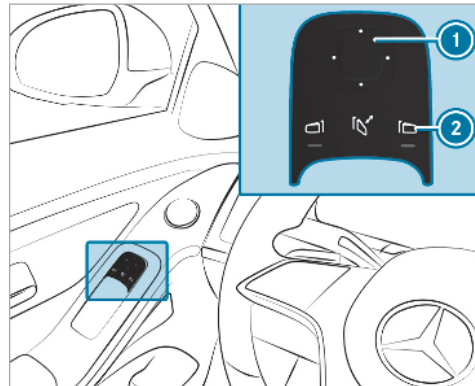

- ▶ Select the front-passenger outside mirror using button ②.
- ▶ Engage reverse gear.
- ▶ Move the front-passenger outside mirror into the desired parking position using button ①.

### Calling up

- ▶ Select the front-passenger outside mirror using button ②.
- ▶ Engage reverse gear.  
The front-passenger outside mirror will move into the stored parking position.

### Activating/deactivating the automatic mirror folding function

Multimedia system:

- ▶  ▶ Settings ▶ Vehicle
- ▶ Locking function ▶ Automatic fold-in
- ▶ Activate or deactivate the function.

### Area permeable to radio waves on the windscreen

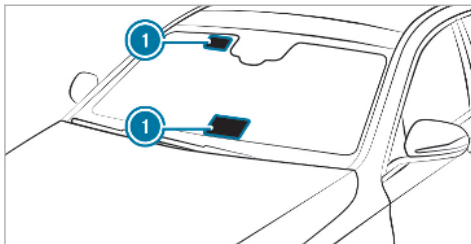

Radio-controlled equipment, such as toll systems, can be mounted only on areas ① of the windscreen that are permeable to radio waves.

Areas permeable to radio waves ① are best visible from outside the vehicle when the windscreen is illuminated with an external light source.

Note this position for vehicles with:

- Windscreen heating
- Infrared reflective windscreen

### Infrared-reflective windscreen function

The infrared-reflective windscreen is coated and reduces the build-up of heat in the vehicle interior.

The coating shields the vehicle interior from radio waves.

## Overview of climate control systems

### Notes on climate control

An interior air filter in combination with the pre-filter in the engine compartment must always be used so that the air conditioning system, pollution level monitoring and the air filtration work correctly. Make sure that the filter is installed correctly and the filter housing in the engine compartment is closed correctly using the cap and always tightly sealed when in operation. Use filters recommended and approved by Mercedes-Benz. Always have service work carried out at a qualified specialist workshop.

### Overview of the automatic climate control panel

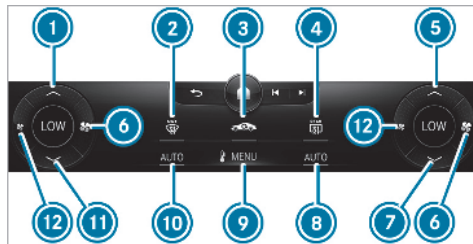

- ① Increases the temperature, left
- ② Demists the windscreen
- ③ Switches air-recirculation mode on/off (→ page 163)
- ④ Switches the rear window heater on/off
- ⑤ Increases the temperature, right
- ⑥ Increases the airflow or switches on climate control (→ page 161)
- ⑦ Reduces the temperature, right

- ⑧ Sets climate control to automatic mode, right (→ page 162)
- ⑨ Calls up the air conditioning menu (→ page 162)
- ⑩ Sets climate control to automatic mode, left (→ page 162)
- ⑫ Reduces the airflow or switches off climate control (→ page 161)

## Overview of the rear operating unit

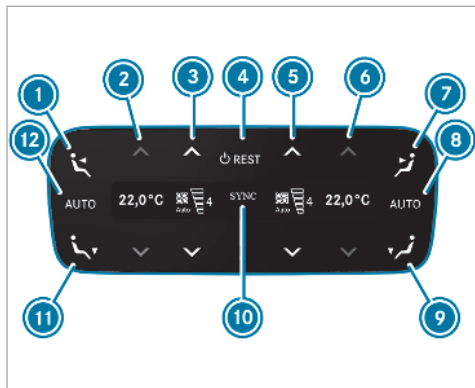



- ① Sets air distribution to the centre and side air vents, left
- ② Sets the temperature, left
- ③ Sets the airflow or switches climate control on/off, left (→ page 162)
- ④ Switches climate control on/off (→ page 161)

- Switches residual heat on/off (→ page 164)
- ⑤ Sets the airflow or switches climate control on/off, right (→ page 162)
- ⑥ Sets the temperature, right
- ⑦ Sets air distribution to the centre and side air vents, right
- ⑧ Sets climate control to automatic mode, right (→ page 162)
- ⑨ Sets the air distribution to the footwell vents, right
- ⑩ Synchronisation is activated (→ page 163)
- ⑪ Sets the air distribution to the footwell vents, left
- ⑫ Sets climate control to automatic mode, left (→ page 162)

The settings for the second row of seats can be configured via the rear operating unit, the multimedia system (→ page 163) or the MBUX rear tablet depending on the vehicle's equipment.

## Operating the climate control system

### Switching climate control on/off

- ▶ **To switch on:** set the airflow to level 1 or higher via  on the climate bar on the central display.
- ▶ **To switch off:** set the airflow to level 0 via  on the climate bar on the central display.
- ⓘ If climate control is switched off, the windows may mist up more quickly. Switch off climate control only briefly.

### Switching climate control on/off via the rear operating unit

- ▶ Press button ④.
- or
- ▶ Set the airflow to level 0 or higher using buttons ③ and ⑤.
- ⓘ If the rear climate control is switched off via button ④, **OFF** will be shown on the rear display.

## Calling up the air conditioning menu

The air conditioning menu can be called up via the air conditioning line. The air conditioning line is always shown on the lower edge of the central display.

- ▶ Select the **Climate menu** entry in the air conditioning line.  
The **First row of seats** menu is opened.

## Activating/deactivating the A/C function via the multimedia system

Multimedia system:



↳ **Climate menu**

Depending on the external conditions, improved cooling and dehumidification of the interior air are supported when the A/C function is activated.

- ▶ Select **First row of seats**.
- ▶ Select **A/C (A/C)**.

## Setting climate control to automatic mode

In automatic mode, the set vehicle interior temperature is controlled automatically and maintained at a constant level by the air supply.

- ▶ Press **AUTO** on the climate bar on the central display.
- ⓘ You can increase or reduce the airflow by pressing  on the climate bar on the multimedia system.
- ▶ **To switch to manual operation:** switch off automatic mode or adjust an aspect of air distribution, e.g. .



## Setting climate control to automatic mode via the rear operating unit

In automatic mode, the set temperature is regulated by the temperature of the dispensed air and the airflow.

- ▶ Press button **8** or **12**.

## Overview of the air distribution settings





The symbols on the display indicate which vents the airflow is being directed through:

-  demister vents
-  centre and side air vents
-  footwell vents

## Setting the air distribution

Multimedia system:

↳ **Climate menu**

- ▶ Select **First row of seats** or **Second row of seats**.
- ▶ **To set the air distribution:** select ,  or .
- ▶ Set the airflow.
- ⓘ Several air distribution options can be selected at the same time, for example to set the temperature/air conditioning for the windscreen and the footwells simultaneously. The  climate control for the windscreen can only be selected for the first seat row.



## Setting the footwell temperature

Multimedia system:

→ Climate menu



Set the footwell temperature.

## Setting climate control for the rear passenger compartment (multimedia system)

Multimedia system:

→ Climate menu

### Setting the temperature

- ▶ Select **Second row of seats**.
- ▶ Set the temperature.

### Setting the airflow

- ▶ Select **Second row of seats**.
- ▶ Set the airflow.

## Controlling the rear climate control automatically

- ▶ Select **AUTO**.

## Deactivating rear climate control

- ▶ Select **REAR OFF**.

## Activating/deactivating the climate control synchronisation function via the multimedia system

Multimedia system:

→ Climate menu

Climate control can be set centrally using the synchronisation function. The driver's settings for temperature, airflow and air distribution will be adopted automatically for all climate zones.

- ▶ Select **First row of seats** or **Second row of seats**.
- ▶ Select **SYNC (SYNC)**.

## Demisting the windows

### Windows misted up on the inside

- ▶ Press **AUTO** on the climate bar of the central display.
- ▶ If the windows remain misted up: press  on the climate bar of the central display.

### Windows misted up on the outside

- ▶ Switch on the windscreen wipers.
- ▶ Press the **AUTO** button.

## Switching air-recirculation mode on/off

- ▶ Press  on the climate bar on the central display.  
The interior air will be recirculated.

Air-recirculation mode automatically switches to fresh air mode after some time.

- ⓘ If air-recirculation mode is switched on, the windows may mist up more quickly. Switch on air-recirculation mode only briefly.

## Switching residual heat on/off

### Requirements:

- the vehicle is parked.

It is possible to make use of the residual heat from the engine to continue heating or ventilating the front compartment of the vehicle for approximately 30 minutes, depending on the temperature set.

▶ **To switch on:** select **Residual heat** on the climate bar on the central display.

Residual heat will be switched off automatically.

## Switching residual heat on/off via the rear operating unit

### Requirements:

- The vehicle is parked.

When the residual heat of the engine is activated in the rear compartment, you can heat or ventilate the front and rear compartments for approximately 15 minutes.

▶ Press button .

## Activating/deactivating ionisation

Multimedia system:

↪ **Climate menu**

Ionisation improves the quality of the vehicle's interior air. Ionisation of the interior air is odourless.

- ▶ Select **Air quality**.
- ▶ Select **Ionisation**.

 The function can only be performed if the AUTO mode is activated or the air distribution is set to the side air vent. The function may be restricted if the side air vents on the driver's side are closed.

## Fragrance system

### Setting the fragrance system

#### Requirements:

- The climate control system is switched on.
- The glove box is closed.
- A flacon is inserted.

Multimedia system:

↪ **Climate menu**

The fragrance system distributes a pleasant fragrance throughout the vehicle interior from a flacon located in the glove box.

- ▶ Select **Air quality**.
- ▶ Select **Air freshener**.
- ▶ Keep pressing until the desired intensity is reached.

### Inserting or removing the flacon of the fragrance system

 **WARNING** Risk of injury from liquid perfume

If children open the flacon, they could drink the liquid perfume or it could come into contact with their eyes.

- ▶ Do not leave children unattended in the vehicle.
- ▶ Consult a doctor immediately if liquid perfume has been drunk.

- ▶ If liquid perfume comes into contact with your eyes or skin, rinse your eyes with clean water.
- ▶ If symptoms continue, consult a doctor.

 **ENVIRONMENTAL NOTE** Environmental damage due to improper disposal of full flacons



Full flacons must not be disposed of with household waste.



Full flacons must be taken to a harmful substance collection point.

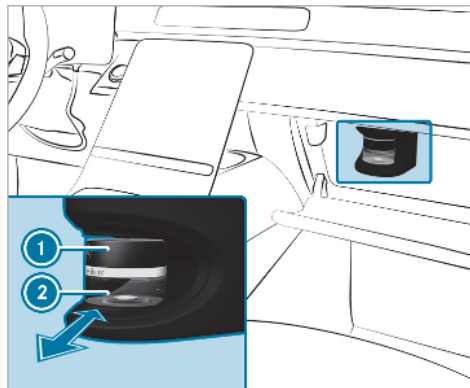

- ① Cap
- ② Flacon

- ▶ **To insert:** slide the flacon into the holder as far as it will go.
- ▶ **To remove:** after opening the glove box, wait for approximately seven seconds and pull out the flacon.

If you do not use genuine Mercedes-Benz interior perfumes, observe the manufacturers' safety notices on the perfume packaging.

Dispose of the genuine Mercedes-Benz interior perfume flacon when it is empty and do not refill it.

### Refillable flacon

- ▶ Unscrew the cap of the empty flacon.
- ▶ Fill the flacon with a maximum of 15 ml.
- ▶ Screw the cap back on to the flacon.

Always refill the empty refillable flacon with the same perfume. Observe the separate information sheet with the flacon.

### Information on the windscreen heater

The windscreen heater is activated automatically if  is switched on on the climate bar on the media display.

After the vehicle is started, the windscreen heater is switched on automatically as required.

## Stationary heater/ventilation

### Stationary heater/stationary ventilation function

- The air inside the vehicle is heated or ventilated to the set temperature.
- The air inside the vehicle cannot be cooled down to temperatures below the outside temperature.
- If the outside temperature changes, ventilation mode automatically switches to heating mode or heating mode automatically switches to ventilation mode.

The stationary heater and the exhaust gas outlet are situated behind the right-hand front wheel.

### Switching the stationary heater/ventilation on/off via the control panel

**⚠ DANGER** Risk of fatal injury due to poisonous exhaust gases

If the tailpipe is blocked or sufficient ventilation is not possible, poisonous exhaust gases such as carbon monoxide may enter the vehi-

cle. This is the case in enclosed spaces or if the vehicle gets stuck in snow, for example.

- ▶ Always switch the stationary heater off in enclosed spaces without an air extraction systems, e.g. in garages.
- ▶ Keep the tailpipe and the area around the vehicle free from snow when the engine or the stationary heater are running.
- ▶ Open a window on the windward side of the vehicle to ensure an adequate supply of fresh air.

**⚠ WARNING** Risk of fire due to hot stationary heater components and exhaust gases

Flammable materials such as leaves, grass or twigs may ignite.

- ▶ When the stationary heater is switched on, make sure that:
  - hot vehicle parts do not come into contact with flammable materials.

- the exhaust gas can flow out of the stationary heater exhaust pipe unhindered.
- the exhaust gas does not come into contact with flammable materials.

**⚠ NOTE** Battery discharge caused by stationary heater or stationary ventilation operation



Operating the stationary heater or stationary ventilation drains the battery.

- ▶ After heating or ventilating the vehicle twice, drive for a longer period of time.

### Requirements:

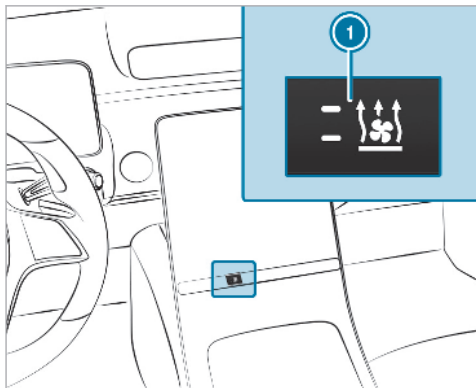
- the fuel tank is sufficiently full.
- ⓘ Please note that if the tank fill level is too low, it can result in function restrictions during stationary heating operation.



- ▶ Set the temperature using the arrows  on the climate bar on the media display.
- ▶ Press button .
- The red or blue indicator lamp on button  will light up or go out.

The colours of the indicator lamp have the following meaning:

- **Blue:** stationary ventilation is switched on.

- **Red:** the stationary heater is switched on.
- **Yellow:** the departure time is preselected.

The stationary heater/ventilation will switch off automatically after 50 minutes.

### Setting the stationary heater/stationary ventilation via the multimedia system

Multimedia system:

➔ [Climate menu](#)

- ▶ Select [Stationary heater](#).

### Selecting the departure time

- ▶ Select the time [Time A](#), [Time B](#) or [Time C](#).

### Setting the departure time

- ▶ Select the time [Time A](#), [Time B](#) or [Time C](#).
- ▶ Select the pen beside the time.
- ▶ Set a time.

### Setting the stationary heater/ventilation via remote control

#### Requirements:



- the fuel tank is sufficiently full.

### Switching on immediately



- ▶ Press and hold the  button.

### Setting the departure time

- ▶ Briefly press the  button.
- ▶ Press the  or  button repeatedly until the time to be changed appears on the display.

- ▶ Press the **ON** and **OFF** buttons simultaneously. The  symbol on the remote control display will flash.
- ▶ Press the **<** and **>** buttons to set the desired departure time.
- ▶ Press the **ON** and **OFF** buttons simultaneously. The new departure time will be stored.

Up to three departure times can be stored.

- ▶ **To activate the departure time:** select the desired departure time and press and hold the **ON** button. The  symbol, the departure time and, depending on the selected departure time, the letter **A**, **B** or **C** will appear on the display.
- ▶ **To deactivate the departure time:** select the desired departure time and press and hold the **OFF** button. **OFF** will appear on the display.
- ▶ **To check the status of the active stationary heater:** briefly press the **ON** button.

### Switching off immediately

- ▶ Press and hold the **OFF** button.

### Overview of the remote control displays (stationary heater/stationary ventilation)

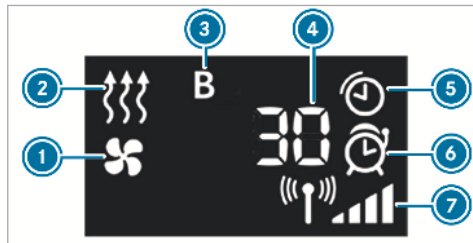

- ① Stationary ventilation switched on
- ② Stationary heater switched on
- ③ Selected departure time
- ④ Remaining time for the stationary heater/stationary ventilation (in minutes)
- ⑤ Stationary heater/stationary ventilation active
- ⑥ Departure time activated
- ⑦ Signal strength

Further possible displays:

- **Time:** activated departure time.
- **Zero minutes:** the running time for the stationary heater is increased, as the engine has not yet reached operating temperature when it is started.
- **OFF:** the stationary heater/stationary ventilation is switched off.

### Replacing the remote control battery (stationary heater)

**⚠ DANGER** Serious damage to health caused by swallowing batteries

Batteries contain toxic and corrosive substances. Swallowing batteries may cause serious damage to health.

There is a risk of fatal injury.

- ▶ Keep batteries out of the reach of children.
- ▶ If batteries are swallowed, seek medical attention immediately.

 **ENVIRONMENTAL NOTE** Environmental damage due to improper disposal of batteries



Batteries contain toxic and corrosive substances.



Take discharged batteries to a qualified specialist workshop or to a collection point for used batteries.

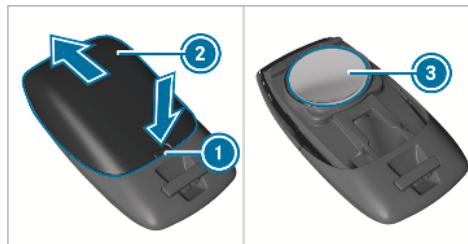



- ▶ Push a pointed object into recess ①.
- ▶ Slide battery cover ② backwards in the direction of the arrow.
- ▶ Insert new battery ③ with the lettering facing upwards.
- ▶ Slide battery cover ② in the opposite direction to the arrow onto the remote control until the battery cover engages.

#### Requirements:

- a CR2450 lithium battery

#### Problems with the remote control for the stationary heater/stationary ventilation

Problem	Possible causes/consequences and ▶ Solutions
FAIL 	The signal transmission between the transmitter and the vehicle is malfunctioning.

Problem	Possible causes/consequences and ► Solutions
	<ul style="list-style-type: none"> <li>► Change your position in relation to the vehicle, moving closer if necessary.</li> </ul>
FAIL	<p>The starter battery is not sufficiently charged.</p> <ul style="list-style-type: none"> <li>► Charge the starter battery.</li> </ul>
	<p>The fuel tank is not sufficiently filled.</p> <ul style="list-style-type: none"> <li>► Refuel at the nearest filling station.</li> </ul>
FAIL 	<p>The stationary heater is malfunctioning.</p> <ul style="list-style-type: none"> <li>► Have the stationary heater checked at a qualified specialist workshop.</li> </ul>

## Air vents

### Adjusting the front air vents

**⚠ WARNING** Risk of burns and frostbite due to being too close to the air vents

Very hot or very cold air can flow from the air vents.

- Make sure that all vehicle occupants always maintain a sufficient distance from the air vents.

- If necessary, direct the airflow to another area of the vehicle interior.

To guarantee the flow of fresh air through the air vents into the vehicle interior, comply with the following:

- Always keep the vents and the vent grilles in the vehicle interior clear.
- Keep the air inlet free of deposits (→ page 461).



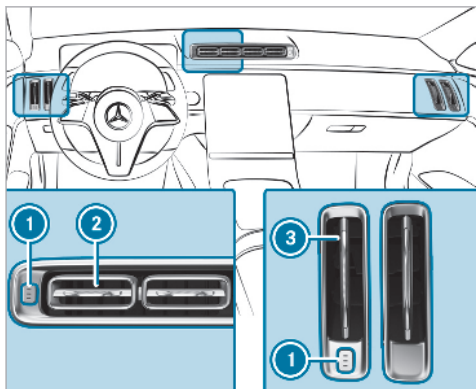

- ▶ **To open the centre and side air vents:** press button ①. The three indicator lamps on the button will light up. The air vents will be opened completely.

- ▶ **To close the centre and side air vents:** press button ① again. The three indicator lamps on the button will go out one by one. The air vents will be closed completely.
- ▶ **To adjust the air direction of the centre air vents:** hold air vent ② in the centre and move it up or down or to the left or right.
- ▶ **To adjust the air direction of the side air vents:** hold the outer side air vent ③ in the centre and move it up or down or to the left or right.

#### Adjusting the air vents in the rear

**⚠ WARNING** Risk of burns and frostbite due to being too close to the air vents

Very hot or very cold air can flow from the air vents.

- ▶ Make sure that all vehicle occupants always maintain a sufficient distance from the air vents.
- ▶ If necessary, direct the airflow to another area of the vehicle interior.

#### Adjusting the rear air vents

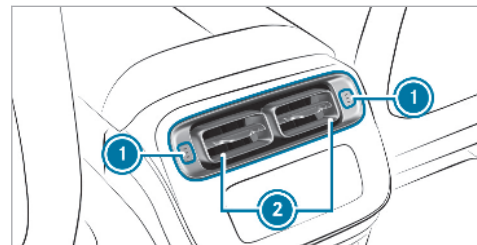

- ▶ **To open the rear air vents:** press button ①. The air vents will be opened completely and the three indicator lamps on the button will light up.
- ▶ **To close the rear air vents:** press button ① again. The air vents will be closed completely and the three indicator lamps on the button will go out one by one.
- ▶ **To adjust the air direction of the rear air vents:** hold air vent ② in the centre and move it up or down or to the left or right.

### Adjusting the rear side air vents

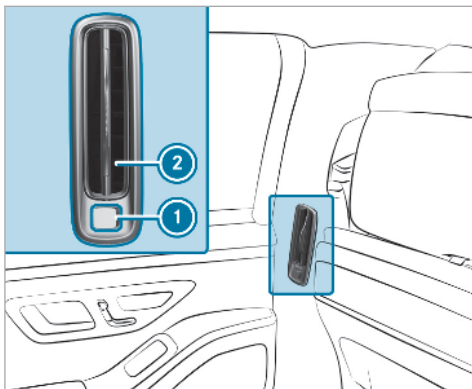

- ▶ **To open the side air vents in the rear:** press button ①. If the button is flush with the side trim, the side air vent is open.

- ▶ **To close the side air vents in the rear:** press button ① again. If the button protrudes from the side trim, the side air vent is closed.
- ▶ **To adjust the air direction of the side air vents:** hold air vent ② in the centre and move it up or down or to the left or right.

### Opening or closing the air vent in the glove box

**!** **NOTE** Damage to temperature-sensitive objects in the glove box

Temperature-sensitive objects stored in the glove box may be damaged by the air vent located inside the glove compartment.

- ▶ Close the air vent when you heat the vehicle.
- ▶ At high outside temperatures, open the air vent and switch on the A/C function.

The automatic climate control must be switched on to cool the glove box.

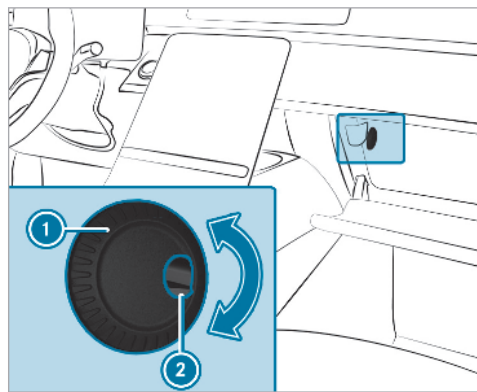

- ① Air vent controller
- ② Air vent

- ▶ **To open or close:** turn controller ① to the right or left.

## Driving

### Switching on the power supply or the ignition (without engine start)

**⚠ WARNING** Risk of accident and injury due to children left unattended in the vehicle

If children are left unsupervised in the vehicle, they could, in particular:

- open doors, thereby endangering other persons or road users.
- get out and be struck by oncoming traffic.
- operate vehicle equipment and become trapped, for example.

In addition, the children could also set the vehicle in motion, for example by:

- releasing the parking brake.
- change the transmission position.
- start the vehicle.

- ▶ Never leave children unattended in the vehicle.
- ▶ When leaving the vehicle, always take the key with you and lock the vehicle.
- ▶ Keep the key out of reach of children.

Also observe the "Notes on pets in the vehicle". This also applies to the Digital Vehicle Key if the "Digital Vehicle Key" function is activated via Mercedes me connect.

#### Requirements:

- the key is located in the vehicle and the key battery is not discharged.
- or: a Digital Vehicle Key is located in the cup holder (→ page 174).
- the brake pedal is not depressed.

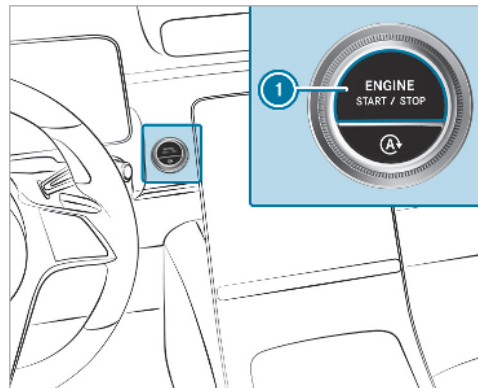

▶ **To switch on the power supply:** press button ① once. You can activate the windscreen wiper, for example.

The power supply is switched off again if the following conditions are met:

- you open the driver's door.
- you press button ① twice more.

- ▶ **To switch on the ignition:** press button ① twice.

The indicator lamps appear on the driver display.

The ignition is switched off again if one of the following conditions is met:

- you do not start the vehicle within 15 minutes and the transmission is in position **P** or the electric parking brake is applied.
- you press button ① once.

## Starting the vehicle

### Starting the vehicle with the start/stop button

**⚠ DANGER** Risk of death caused by exhaust gases

Combustion engines emit poisonous exhaust gases such as carbon monoxide. Inhaling these exhaust gases is hazardous to health and leads to poisoning.

- ▶ Never leave the engine or, if present, the auxiliary heating running in an enclosed space without sufficient ventilation.

**⚠ WARNING** Risk of fire due to flammable material in the engine compartment or the exhaust system

Flammable materials may ignite.

- ▶ Therefore, check regularly that there are no flammable materials in the engine compartment or on the exhaust system.

### Requirements:

- the key is located in the vehicle and the key battery is not discharged.
  - or: a Digital Vehicle Key is located in the cup holder (→ page 174).
- ▶ Shift the transmission to position **P** or **N**.
  - ▶ Depress the brake pedal and press button ① once.

- ▶ If the vehicle does not start: switch off non-essential consumers and press button ① once.

If the vehicle still does not start, one of the following display messages appears in the driver display:

- ▶ **Place the key in the marked space** See Owner's Manual: Starting the vehicle with the key in the marked space (emergency operation mode) (→ page 175).

or

- ▶ **Key not detected Place smartphone in charging bracket:** place the mobile phone in the marked space (→ page 140).

- ① You can switch off the engine while driving by pressing button ① for about three seconds or by pressing button ① three times within three seconds. Be sure to observe the safety notes under "Driving tips" (→ page 178).

### Starting the vehicle with a Digital Vehicle Key

#### Requirements:

- one of the following versions of the Digital Vehicle Key is available:
    - suitable mobile phone
    - Digital Vehicle Key sticker
  - the vehicle is equipped with the "Digital Vehicle Key" function.
  - the "Digital Vehicle Key" function is activated via Mercedes me connect: <https://www.mercedes.me>.
  - the mobile phone is sufficiently charged.
- i** Mercedes-Benz recommends that you carry the emergency key in case of function restrictions.
- i** If the mobile phone is in a protective case, this can impair the functionality.

### Using the Digital Vehicle Key for the first time

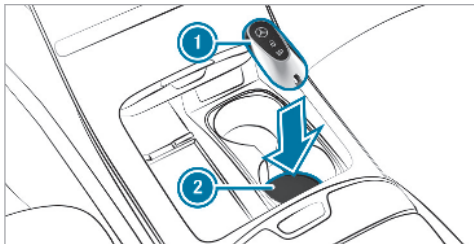

- ▶ Deactivate the key ① (→ page 68).
- ▶ Place the key ① in the cup holder ②.

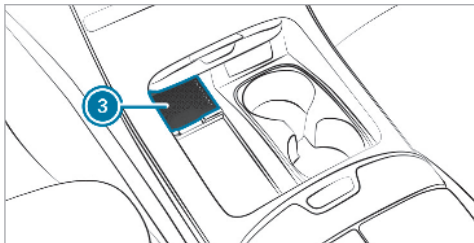

- ▶ Place the mobile phone or the Digital Vehicle Key sticker in the marked space ③.
- ▶ Depress the brake pedal and start the vehicle using the start/stop button.

### Any further starts with the Digital Vehicle Key

The key is not needed for any further starts.

- ▶ Place the mobile phone or the Digital Vehicle Key sticker in the marked space ③.
- ▶ Start the vehicle using the start/stop button.

The "Digital Vehicle Key" service can be deactivated in Mercedes me connect at <https://www.mercedes.me>. The function is then deactivated in the mobile phone via an online connection. If connection to the Internet is not possible, e.g. after the mobile phone or the Digital Vehicle Key sticker has been stolen, the key function can be deactivated at a Mercedes-Benz service centre.

### Starting the vehicle with the key in the marked space (emergency operation mode)

If the vehicle does not start and the display message Place the key in the marked space See

**Owner's Manual** appears in the driver display, you can start the vehicle in emergency operation mode.

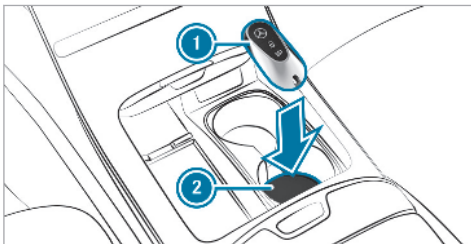

▶ Make sure that the cup holder ② is empty.

▶ Remove the key ① from the key ring.

▶ Place the key ① in the cup holder ②. The vehicle will start after a short time.

If the key ① is removed from the cup holder ②, the engine continues running. For further vehicle starts, however, the key ① must be located in the cup holder ② during the entire journey.

▶ Have the key ① checked at a qualified specialist workshop.

#### If the vehicle does not start:

▶ leave the key ① in the cup holder ②.

▶ Depress the brake pedal and start the vehicle using the start/stop button.

ⓘ You can also switch on the power supply or the ignition with the start/stop button.

#### Starting the vehicle via Remote Online services

#### Cooling or heating the vehicle interior before commencing your journey

Ensure the following before starting the engine:

- the legal stipulations in the area where your vehicle is parked allow engine starting via smartphone.
- it is safe to start and run the engine where your vehicle is parked.
- the fuel tank is sufficiently full.
- The starter battery is sufficiently charged.

#### Charging the battery before commencing your journey

If the vehicle battery is discharged, you receive a message on your smartphone. You can then start the vehicle with the smartphone to charge the battery. The vehicle is automatically switched off after ten minutes.

Ensure the following before starting the engine:

- the legal stipulations in the area where your vehicle is parked allow engine starting via smartphone.
- it is safe to start and run the engine where your vehicle is parked.
- the fuel tank is sufficiently full.

#### Starting the vehicle (Remote Online)

**⚠ WARNING** Risk of crushing or entrapment due to unintentional starting of the engine

Limbs could be crushed or trapped if the engine is started unintentionally during service or maintenance work.

- ▶ Always secure the engine against unintentional starting before carrying out maintenance or repair work.

### Requirements:

- park position **P** is selected.
- the anti-theft alarm system is not activated.
- the panic alarm is not activated.
- the hazard warning light system is switched off.
- The bonnet is closed.
- the doors are closed and locked.
- the windows and sliding sunroof are closed.

- ▶ Start the vehicle using the smartphone. After every vehicle start, the engine runs for ten minutes.

You can carry out a maximum of two consecutive starting attempts. The vehicle must be started once with the key before trying to start the vehicle again with the smartphone. you can stop the vehicle again at any time.

- ❗ Further information can be found in the smartphone app.

### Securing the engine against starting before carrying out maintenance or repair work:

- ▶ switch on the hazard warning light system.  
or
- ▶ unlock the doors.  
or
- ▶ open a side window or the sliding sunroof.

### Running-in notes

To preserve the engine during the first 1,500 km:

- drive at varying road speeds and engine speeds.
- drive the vehicle in drive program **C** or **E**.
- shift to the next highest gear at the very latest when the needle reaches the last third before the red area in the rev counter.
- do not shift down a gear manually in order to brake.

- avoid overstraining the vehicle, e.g. driving at full throttle.
- do not depress the accelerator pedal past the pressure point (kickdown).
- only increase the engine speed gradually and accelerate the vehicle to full speed after 1,500 km.

This also applies when the engine or parts of the drivetrain have been replaced.

Please also observe the following running-in notes:

- in certain driving and driving safety systems, the sensors adjust automatically while a certain distance is being driven after the vehicle has been delivered or after repairs. Full system effectiveness is not reached until the end of this teach-in process.
- brakepads, brake discs and tyres that are either new or have been replaced only achieve optimum braking effect and grip after several hundred kilometres of driving. Compensate for the reduced braking effect by applying greater force to the brake pedal.

## Notes on driving

### **⚠ WARNING** Risk of accident due to objects in the driver's footwell

Objects in the driver's footwell may impede pedal travel or block a depressed pedal.

This jeopardises the operating and road safety of the vehicle.

- ▶ Stow all objects in the vehicle securely so that they cannot get into the driver's footwell.
- ▶ Always fit the floor mats securely and as prescribed in order to ensure that there is always sufficient room for the pedals.
- ▶ Do not use loose floor mats and do not place floor mats on top of one another.

### **⚠ WARNING** Risk of accident due to incorrect footwear

Incorrect footwear includes, for example:

- shoes with platform soles
  - shoes with high heels
  - slippers
- ▶ Always wear suitable footwear so that you can operate the pedals safely.

### **⚠ WARNING** Risk of accident when switching off the ignition while driving

If you switch off the ignition while driving, safety functions are restricted or no longer available.

You will then need, for example, to use considerably more force to steer and brake.

- ▶ Do not switch off the ignition while driving.

### **⚠ DANGER** Risk of death caused by exhaust gases

Combustion engines emit poisonous exhaust gases such as carbon monoxide. Inhaling these exhaust gases is hazardous to health and leads to poisoning.

- ▶ Never leave the engine or, if present, the auxiliary heating running in an enclosed space without sufficient ventilation.

### **⚠ WARNING** Risk of skidding and of an accident due to shifting down on slippery road surfaces

If you shift down on slippery road surfaces to increase the engine braking effect, the drive wheels may lose traction.

- ▶ Do not shift down on slippery road surfaces to increase the engine braking effect.



**⚠ DANGER** Risk of fatal injury due to poisonous exhaust gases

If the tailpipe is blocked or sufficient ventilation is not possible, poisonous exhaust gases such as carbon monoxide may enter the vehicle. This is the case when the vehicle becomes stuck in snow, for example.

- ▶ Keep the tailpipe and the area around the vehicle free from snow when the engine or the stationary heater are running.
- ▶ Open a window on the side of the vehicle facing away from the wind to ensure an adequate supply of fresh air.

**⚠ WARNING** Risk of accident due to the brake system overheating

If you leave your foot on the brake pedal when driving, the brake system may overheat.

This increases the braking distance and the brake system may even fail.

- ▶ Never use the brake pedal as a footrest.
- ▶ Do not depress the brake pedal and the accelerator pedal at the same time while driving.

**! NOTE** Engine damage due to excessively high engine speeds

The engine will be damaged if you drive with the engine in the overrevving range.

- ▶ Do not drive with the engine in the overrevving range.

**! NOTE** Causing wear to the brake linings by permanently depressing the brake pedal

- ▶ Do not permanently depress the brake pedal while driving.
- ▶ To use braking effect of the engine, shift to a lower gear in good time.

**! NOTE** Damage to the drivetrain and engine when pulling away

- ▶ Do not warm up the engine while the vehicle is stationary. Pull away immediately.
- ▶ Avoid high engine speeds and driving at full throttle until the engine has reached its operating temperature.

**! NOTE** Damage to the catalytic converter due to non-combusted fuel

- The engine is not running smoothly and is misfiring.  
Non-combusted fuel may get into the catalytic converter.
- ▶ Only depress the accelerator pedal slightly.
  - ▶ Have the cause rectified immediately at a qualified specialist workshop.

**Notes on driving on salt-treated roads**

The braking effect is limited on salt-treated roads.

Therefore, observe the following notes:

- due to salt build-up on the brake disks and brakepads, the braking distance can increase considerably or result in braking only on one side
- maintain a much greater safe distance to the vehicle in front

To remove salt build-up:

- brake occasionally while paying attention to the traffic conditions
- carefully depress the brake pedal at the end of the journey and when starting the next journey

### Notes on aquaplaning

Aquaplaning can take place once a certain amount of water has accumulated on the road surface.

Observe the following notes during heavy precipitation or in conditions in which aquaplaning may occur:

- reduce speed
- avoid tyre ruts

- avoid sudden steering movements
- brake carefully

**i** Also observe the notes on regularly checking wheels and tyres (→ page 491).

### Notes on driving through water on the road surface

Water which has entered into the vehicle can damage the engine, electrics and transmission.

Water can also enter the air intake of the engine and cause engine damage.

Observe the following if you must drive through water:

- The water, when calm, may only reach the lower edge of the vehicle body.
- Drive at walking pace at most, otherwise water can enter the vehicle interior or engine compartment.
- Vehicles travelling in front, or oncoming vehicles, can create waves which may exceed the maximum permissible height of the water.

The braking effect of the brakes is reduced after fording. Brake carefully while paying attention to

the traffic conditions until braking power has been fully restored.

### Function of rear axle steering

---

The rear axle steering is an electromechanical auxiliary steering on the rear axle which adjusts the steering of the rear wheels according to the position of the front wheels, depending on the speed. This results in greater manoeuvrability and improved stability.

Rear axle steering has the following characteristics:

- reduced steering effort and turning circle resulting in reduced parking effort
- improved driving stability, e.g. when cornering
- more direct steering resulting in improved handling of the vehicle

Observe the notes on snow chains (→ page 491) and on activating snow chain mode.

## ECO start/stop function

### Operation of the ECO start/stop function

- **i** The ECO start/stop function is available only in the **S**, **C**, **E** and **I\*** drive programs (depending on the setting).

The engine is switched off automatically in the following situations if all vehicle conditions for an automatic engine stop are met:

- you brake the vehicle to a standstill in transmission position **D** or **N**.
- **vehicles with a 48 V on-board electrical system:** you depress the brake pedal when travelling at a low speed.

- **i** When the HOLD function is active and in transmission position **P**, the engine can stop in spite of an intelligent stop inhibitor, e.g. when stopping at a stop sign with no vehicle in front.

The engine is restarted automatically if:





- you engage transmission position **D** or **R**.
- you depress the accelerator pedal.

- an automatic engine start is required by the vehicle.

- **vehicles with a 48 V on-board electrical system:**

- you release the brake pedal on a downhill gradient and the vehicle does not roll.
- the vehicle rolls on a downhill gradient and does not enter glide mode at 20 km/h.

ECO start/stop function symbols in the driver display:

- the symbol  (green) appears when the vehicle is at a standstill: the engine was switched off by the ECO start/stop function.
- the symbol  (yellow) appears when the vehicle is at a standstill: not all vehicle conditions for an engine stop have been met.
- neither the symbol  nor  appears when the vehicle is at a standstill: an intelligent stop inhibitor was detected, e.g. a stop sign.

- the symbol  appears: the ECO start/stop function is deactivated or there is a malfunction.

If the engine was switched off by the ECO start/stop function and you leave the vehicle, a warning tone sounds and the engine is not restarted. In addition, the following display message appears in the driver display:

**Vehicle is operational Switch off ignition before exiting**

If you do not switch off the ignition, the ignition is automatically switched off after three minutes.

## Deactivating or activating the ECO start/stop function

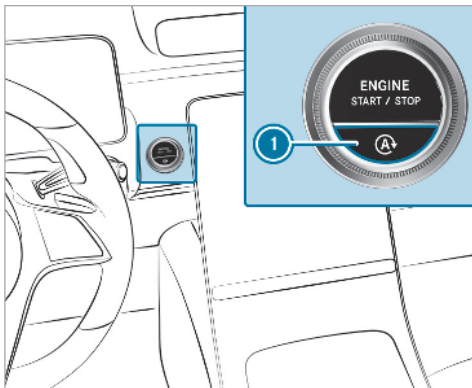

- ▶ Press button ①.  
A display appears in the instrument cluster when switching the ECO start/stop function off/on.

① A continuous **A** OFF display appears in the instrument cluster while the ECO start/stop function is deactivated.

## Function of the ECO rating

The **ECO rating** summarises your driving style from the start of the journey to its completion and helps you to optimise your fuel consumption.

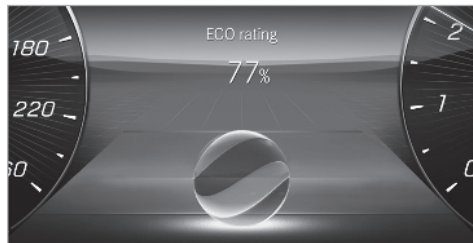

The **ECO rating** analyses the following criteria for the most economical driving style:

- coasting in good time
- consistent speed
- moderate acceleration

The more economically you drive, the higher the **ECO rating** between 0 and 100.

## ECO Assist function

### Vehicles with a 48 V on-board electrical system (EQ Boost technology)

① ECO Assist is active only in drive programs **E** and **C**.

ECO Assist analyses data for the vehicle's expected route. This allows the system to optimally adjust the driving style for the route ahead, save fuel and recuperate. If the system detects an event ahead and the vehicle nears the event, ECO Assist will calculate the optimum speed for maximum fuel economy and recuperative energy based on the distance, speed and downhill gradient.



#### How ECO Assist appears on the driver's display

- ① "Foot off the accelerator" prompt
- ② Route event ahead

① In the other menu, only the "Foot off the accelerator" prompt ① is shown next to the transmission position display.

A route event detected ahead ② is displayed as soon as the driver nears it.

If the driver depresses the accelerator pedal, symbol ① will also appear.

As soon as the driver lifts off the accelerator pedal, symbol ① is faded out. The route event ② is shown as long as the system is intervening

in the route event. Once the route event has been passed, the symbol ② is faded out again.

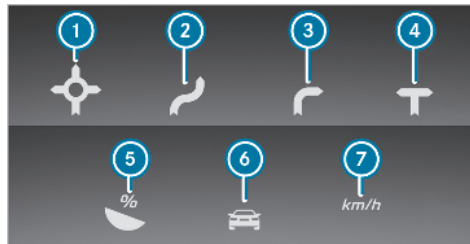

The following route events can be detected by ECO Assist:

- ① Roundabout
- ② S-bend
- ③ Sharp bend
- ④ T-junction
- ⑤ Downhill gradient
- ⑥ Vehicle in front
- ⑦ Speed limit

① If the system does not intervene during the route event, nothing will be displayed. The system is passive.

① In drive program **[C]**, only route event ⑥ is shown.

#### System limits

If the calculated route is adhered to when route guidance is active, ECO Assist can function even more precisely. The basic function is also available without active route guidance. Not all information and traffic situations can be foreseen. The quality depends on the map data.

ECO Assist is only an aid. The driver is responsible for keeping a safe distance from the vehicle in front, for vehicle speed and for braking in good time. The driver must be ready to brake at all times irrespective of whether the system intervenes.

The system may be impaired or may not function in the following situations:

- If visibility is poor, e.g. due to insufficient illumination of the road, highly variable shade conditions, rain, snow, fog or heavy spray.

- If there is glare, e.g. from oncoming traffic, direct sunlight or reflections.
- If there is dirt on the windscreen in the area of the multifunction camera or the camera is misted up, damaged or obscured.
- If traffic signs are hard to discern, e.g. due to dirt, snow or insufficient lighting, or because they are obscured.
- If the information on the navigation system's digital map is incorrect or out of date.
- If signs are ambiguous, e.g. where there are traffic signs in roadworks or in adjacent lanes.

### DYNAMIC SELECT switch

#### Function of the DYNAMIC SELECT button

Use the DYNAMIC SELECT button to change between the following drive programs:

- I\*** **(Individual)**: individual settings
- S\*** **(Sport +)**: sporty driving style with lowered suspension

- S** **(Sport)**: sporty driving style with lowered suspension
- C** **(Comfort)**: comfortable and economical driving style
- CV** **(CURVE)**: comfortable driving with curve inclination function (vehicles with E-ACTIVE BODY CONTROL)
- E** **(Eco)**: particularly economical driving style

**i** The drive program selected appears in the multifunction display of the on-board computer.

Depending on the drive program, the following systems change their characteristics:

- drive
  - engine and transmission management
  - Active Distance Assist DISTRONIC
  - availability of Glide mode
- ESP®
- suspension
  - suspension and damping

- Vehicle level
- electric power steering

#### Selecting the drive program

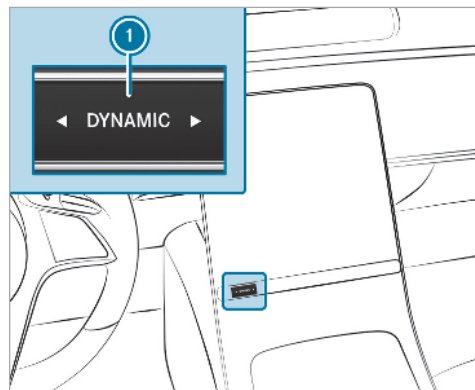

- ▶ Press the DYNAMIC SELECT button **1** on the left or right. The drive program selected appears in the multifunction display.

## Configuring DYNAMIC SELECT (multimedia system)

Multimedia system:

→  » Settings » Vehicle  
» DYNAMIC SELECT (DYNAMIC SELECT)

### Setting drive program I

- ▶ Select [Configure Individual](#).
- ▶ Select and set a category.

### Switching the reset display on/off

- ▶ Switch [Ask when starting](#) on or off.

**Function on:** the next time the vehicle is started a prompt appears asking whether the last active drive program should be restored. If the ECO start/stop function was deactivated, an additional prompt appears asking if the function should remain deactivated.

- ⓘ The prompt appears only if the previously active settings deviate from the standard settings.

**Function off:** the next time the vehicle is started the  drive program is set automatically.

The ECO start/stop function is activated automatically.

## Displaying vehicle data

Multimedia system:

-  » Info
- ▶ Select [Vehicle](#).  
The vehicle data is displayed.

## Displaying engine data

Multimedia system:

-  » Info
- ▶ Select [Engine data](#).  
The engine data is displayed.
  - ⓘ The actual (maximum) values that can be achieved for engine output and engine torque may deviate from the certified values within the country-specific guidelines for permissible tolerances (basis: UN-ECE No. 85 or country-specific guidelines).

Factors that can influence this are, for example:

- Sea level
  - Fuel grade
  - Outside temperature
  - Operating temperature of the engine
- ⓘ The values displayed serve only as orientation. The values for engine output and engine torque shown in the central display may deviate from the actual values.

## Calling up the fuel consumption indicator

Multimedia system:

-  » Info
- ▶ Select [Consumption](#).  
The current and average fuel consumption is displayed.

## Automatic transmission

### DIRECT SELECT lever

#### Function of the DIRECT SELECT lever

**⚠ WARNING** Risk of accident due to incorrect gearshifting

If the engine speed is higher than the idle speed and you engage the transmission position **D** or **R**, the vehicle may accelerate sharply.

▶ If you engage the transmission position **D** or **R** when the vehicle is at a standstill, always depress the brake pedal firmly and do not accelerate at the same time.

**⚠ WARNING** Risk of accident and injury due to children left unattended in the vehicle

If children are left unsupervised in the vehicle, they could, in particular:

- open doors, thereby endangering other persons or road users.
- get out and be struck by oncoming traffic.
- operate vehicle equipment and become trapped, for example.

In addition, the children could also set the vehicle in motion, for example by:

- releasing the parking brake.
  - change the transmission position.
  - start the vehicle.
- ▶ Never leave children unattended in the vehicle.
- ▶ When leaving the vehicle, always take the key with you and lock the vehicle.
- ▶ Keep the key out of reach of children.

This also applies to the Digital Vehicle Key if the "Digital Vehicle Key" function is activated via Mercedes me connect.

Use the DIRECT SELECT lever to switch the transmission position. The current transmission position is shown in the driver display.

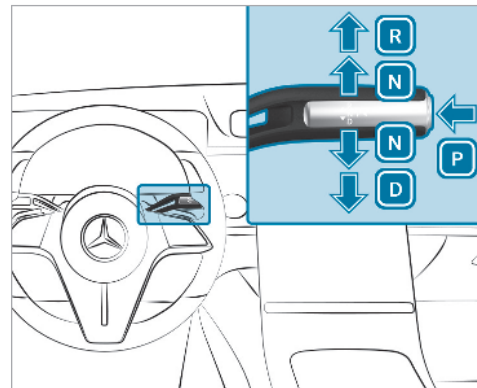

**P** Park position

**R** Reverse gear



**N** Neutral

**D** Drive position

### Engaging reverse gear R

- ▶ Depress the brake pedal and push the DIRECT SELECT lever upwards past the first point of resistance.

### Engaging neutral N

- ▶ Depress the brake pedal and push the DIRECT SELECT lever up or down to the first point of resistance.  
The transmission position display **N** is shown in the multifunction display.

Subsequently releasing the brake pedal will allow you to move the vehicle freely, e.g. to push it or tow it away.

**Proceed as follows if you want the automatic transmission to remain in neutral **N** even if the ignition is switched off or the driver's door is opened:**

- ▶ Start the vehicle.
- ▶ Depress the brake pedal and engage neutral **N** when the car is stationary.

- ▶ Release the brake pedal.

- ▶ Switch the ignition off.

The Wegrollgefahr N manuell aktiviert Kein automatischer Wechsel nach P message appears in the multifunction display.

- ⓘ If you then exit the vehicle leaving the key in the vehicle, the automatic transmission remains in neutral **N**.

The park position **P** is automatically re-engaged as soon as one of the following conditions is met:

- you switch to transmission position **D** or **R**.
- you press the button **P**.

### Engaging park position P

- ▶ Observe the notes on parking the vehicle (→ page 196).
- ▶ Depress the brake pedal until the vehicle is stationary.

- ▶ When the vehicle is stationary, press button **P**.

When the transmission position display shows **P**, the park position is engaged. If no transmission position display **P** appears, secure the vehicle to prevent it from rolling away.

- ⓘ Depending on the situation, it may take a short time until **P** is engaged. Therefore, always pay attention to the transmission position display.

Park position **P** is engaged automatically if one of the following conditions is met:

- you switch off the ignition when the vehicle is stationary and the transmission is in position **D** or **R**.
- you open the driver's door when the vehicle is stationary or when driving at a very low speed and the transmission is in position **D** or **R**.
- you switch the engine off and bring the vehicle to a standstill when the vehicle is rolling and the transmission is in position **D** or **R**.

- you switch off the engine, bring the vehicle to a standstill and open the driver's door when the vehicle is stationary or when the vehicle is rolling and the transmission is in position **N**.
  - engaging park position **P** automatically is required by the vehicle.
- i** To manoeuvre with an open driver's door, open the driver's door while stationary and engage transmission position **D** or **R** again.

### Engaging drive position D

▶ Depress the brake pedal and push the DIRECT SELECT lever down past the first point of resistance.

When the automatic transmission is in transmission position **D**, it shifts the gears automatically. This depends, among other things, on the following factors:

- the selected drive program
- the position of the accelerator pedal
- the driving speed

### Manual gearshifting

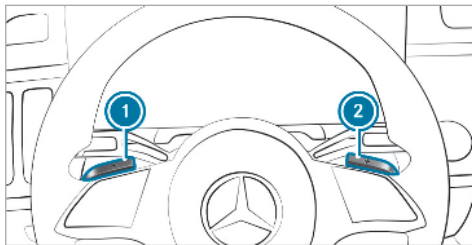

When the automatic transmission is shifted to position **D**, you can manually shift it with the steering wheel gearshift paddle. If permitted, the automatic transmission shifts to a higher or lower gear depending on the steering wheel gearshift paddle being pulled.

You have two options to manually shift the automatic transmission:

- temporary setting
- permanent setting

The gears shift automatically when manual gearshifting is deactivated.

### Temporary setting:

- ▶ **to activate:** pull steering wheel gearshift paddle **1** or **2**. Manual gearshifting is activated for a short time. The transmission position display shows **M** and the current gear.
- i** How long the manual gearshifting stays activated is dependant on various factors. Manual gearshifting can be automatically deactivated in the following cases:
  - changing the drive program
  - restarting the vehicle
  - when the transmission position **D** is engaged again
  - driving style
- ▶ **To shift up:** pull steering wheel gearshift paddle **2**.
- ▶ **To shift down:** pull steering wheel gearshift paddle **1**.
- ▶ **To deactivate:** pull steering wheel gearshift paddle **2** and hold it in place. The transmission position display shows **D**.

**Permanent setting:**

- ▶ change to drive program **[I\*]** (→ page 184).
- ▶ select drive setting **[M]** (→ page 185).

**Gearshift recommendation**

The gearshift recommendation assists you in adopting an economical driving style.



- ▶ If the gearshift recommendation **①** appears next to the transmission position display, shift to the recommended gear.

**Using kickdown**

- ▶ **Maximum acceleration:** depress the accelerator pedal beyond the pressure point.

The automatic transmission shifts up to the next gear when the maximum engine speed is reached to protect the engine from overrevving.

**Glide mode function**

With an anticipatory driving style, Glide mode helps you to reduce fuel consumption.

Glide mode is characterised by the following:

- the combustion engine is disconnected from the drivetrain and continues to run in neutral.
- the transmission position display **[D]** is shown in green.
- **Vehicles with 48 V on-board electrical system (EQ-Boost technology):** the combustion engine can be switched off. All of the vehicle functions remain active.

Glide mode is activated if the following conditions are met:

- drive program **[E]** is selected.
- the speed is within a suitable range.
- the road's course is suitable, e.g. no steep uphill or downhill inclines or tight bends.
- There is no trailer coupled to the trailer hitch, and no bicycle rack fitted.
- you do not depress the accelerator or brake pedal (except for light brake applications).

**i** Glide mode can also be activated if you have selected the "Eco" setting for the drive in the drive program **[I\*]**.

Glide mode is deactivated again if one of the conditions is no longer met.

**Vehicles with Active Distance Assist**

**DISTRONIC:** when Active Distance Assist DISTRONIC is active, the glide mode function is restricted.

Glide mode can also be prevented by the following parameters:

- Incline

- Downhill gradient
- Temperature
- height
- Speed
- operating status of the engine
- traffic situation

### Function of the 4MATIC

4MATIC ensures that all four wheels are driven. Together with ESP® and 4ETS, 4MATIC improves the traction of your vehicle whenever a driven wheel spins due to insufficient traction.

If you fail to adapt your driving style, 4MATIC can neither reduce the risk of an accident nor override the laws of physics. 4MATIC cannot take account of road, weather and traffic conditions. 4MATIC is only an aid. You are responsible especially for maintaining a safe distance from the vehicle in front, for vehicle speed, for braking in good time and for staying in lane.

 In wintry road conditions, the maximum effect of 4MATIC can be achieved only if you

use winter tyres (M+S tyres), with snow chains if necessary.

### Refuelling

#### Refuelling the vehicle

 **WARNING** Risk of fire or explosion from fuel

Fuels are highly flammable.

- ▶ Fire, naked flames, smoking and creation of sparks must be avoided.
- ▶ Switch off the ignition and, if available, the stationary heater, before and while refuelling the vehicle.

 **WARNING** Risk of injury from fuels

Fuels are poisonous and hazardous to your health.

- ▶ Do not swallow fuel or let it come into contact with skin, eyes or clothing.
- ▶ Do not inhale fuel vapour.

- ▶ Keep children away from fuel.
- ▶ Keep doors and windows closed during the refuelling process.

If you or other people come into contact with fuel, observe the following:

- ▶ Immediately rinse fuel off your skin with soap and water.
- ▶ If fuel comes into contact with your eyes, immediately rinse them thoroughly with clean water. Seek medical attention immediately.
- ▶ If you swallow fuel, seek medical attention immediately. Do not induce vomiting.
- ▶ Change immediately out of clothing that has come into contact with fuel.

 **WARNING** Risk of fire and explosion due to electrostatic charge

Electrostatic charge can ignite fuel vapour.

- ▶ Before you open the fuel filler cap or take hold of the pump nozzle, touch the metallic vehicle body.
- ▶ To avoid creating another electrostatic charge, do not get into the vehicle again during the refuelling process.

**⚠ WARNING** Risk of fire from fuel mixture

Vehicles with a diesel engine:

While the engine is running, component parts in the exhaust system may overheat without warning.

- ▶ Never refuel using petrol.
- ▶ Never mix petrol with diesel fuel.

**! NOTE** Damage caused by the wrong fuel

Vehicles with a petrol engine:

Even small amounts of the wrong fuel could result in damage to the fuel system, the engine and the emission control system.

- ▶ Only refuel using unleaded, sulphur-free fuel that conforms to European EN 228, or an equivalent specification.

Fuel of this specification may contain up to 10% ethanol. Your vehicle is suitable for use with E10 fuel.

Never refuel with one of the following fuels:

- diesel
- regular petrol with an octane number lower than 91 RON
- petrol with more than 10% ethanol by volume, e.g. E15, E20, E85, E100
- petrol with more than 3% methanol by volume, e.g. M15, M30
- petrol with additives containing metal

If you have accidentally refuelled with the wrong fuel:

- ▶ do not switch the ignition on.
- ▶ Consult a qualified specialist workshop.

**! NOTE** Damage caused by the wrong fuel

Vehicles with a diesel engine:

Even small amounts of the wrong fuel could result in damage to the fuel system, the engine and the emission control system.

- ▶ Only refuel using sulphur-free diesel fuel that conforms to European standard EN 590, or an equivalent specification. In countries without sulphur-free diesel fuel, refuel using only low-sulphur diesel fuel with a sulphur content less than 50 ppm.

Never refuel using any of the following fuels:

- petrol
- marine diesel
- heating oil
- pure bio-diesel fuel or vegetable oil
- paraffin or kerosene

If you accidentally refuel with the wrong fuel:

- ▶ Do not switch the ignition on.
- ▶ Consult a qualified specialist workshop.

**!** **NOTE** Do not use diesel to refuel vehicles with a petrol engine

If you have accidentally refuelled with the wrong fuel:

- do not switch the ignition on. Otherwise fuel can enter the engine.

Even small amounts of the wrong fuel could result in damage to the fuel system and the engine. The repair costs are high.

- ▶ Consult a qualified specialist workshop.
- ▶ Have the fuel tank and fuel lines drained completely.

**!** **NOTE** Do not use petrol to refuel vehicles with a diesel engine

If you have accidentally refuelled with the wrong fuel:

- do not switch the ignition on. Otherwise, fuel can enter the fuel system.

Even small amounts of the wrong fuel could result in damage to the fuel system and the engine. The repair costs are high.

- ▶ Consult a qualified specialist workshop.
- ▶ Have the fuel tank and fuel lines drained completely.

**!** **NOTE** Damage to the fuel system caused by overfilled fuel tanks

- ▶ Only fill the fuel tank until the pump nozzle switches off.

If you have added too much fuel because of a defective filling pump, for instance:

- ▶ Do not switch the ignition on.

- ▶ Consult a qualified specialist workshop.

**!** **NOTE** Fuel may spray out when you remove the fuel pump nozzle

- ▶ Only fill the fuel tank until the pump nozzle switches off.

#### Requirements:

- The vehicle is unlocked.

**i** Do not get into the vehicle again during the refuelling process. Otherwise, electrostatic charge could build up again.

Observe the notes on operating fluids and fuel.

The recommended octane number for your vehicle can be found on the information label in the fuel filler flap.

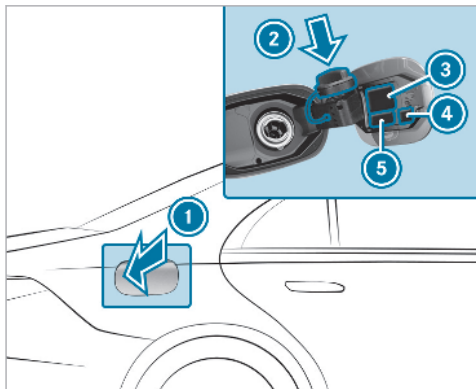

- ① Fuel filler flap
- ② Bracket for fuel filler cap
- ③ Tyre pressure table
- ④ QR code for rescue card
- ⑤ Fuel type

- ▶ Press on the back area of fuel filler flap ①.
- ▶ Turn the fuel filler cap anti-clockwise and remove it.

- ▶ Insert the fuel filler cap from above into bracket ②.
- ▶ Completely insert the pump nozzle into the tank filler neck, hook in place and refuel.
- ▶ Only fill the fuel tank until the pump nozzle switches off.

① **Vehicles with a diesel engine:** the tank filler neck is designed for refuelling at diesel filling pumps.

① **Vehicles with a diesel engine:** when the fuel tank is completely empty, top up with at least 5 litres of diesel.

① **Vehicles with a diesel engine:** use a filler neck with a large diameter for vehicles with a diesel engine when topping up fuel from a fuel can. Otherwise, the filler neck cannot slide into the tank.

- ▶ Replace the cap on the filler neck and turn clockwise until it engages audibly.

- ▶ Close fuel filler flap ①.

① Close the fuel filler flap before locking the vehicle.

### AdBlue® (vehicles with a diesel engine only)

#### Notes on refilling AdBlue®

AdBlue® is a water-soluble fluid for the NOx exhaust gas aftertreatment of diesel engines. In order for the exhaust gas aftertreatment to function properly, only use AdBlue® in accordance with ISO 22241.

AdBlue® is characterised by the following:

- non-toxic
- colourless and odourless
- non-flammable

If you open the AdBlue® tank, small amounts of ammonia vapour may be released. Only fill the AdBlue® tank in well-ventilated areas.

Do not let AdBlue® come into contact with skin, eyes or clothes. Keep AdBlue® away from children.

Do not ingest AdBlue®. If AdBlue® is swallowed, immediately rinse your mouth out thoroughly. Drink plenty of water. Seek medical attention at once.

Observe the notes on operating fluids (→ page 564).

AdBlue® is available here:

- AdBlue® can be topped up by fast service at a qualified specialist workshop, e.g. a Mercedes-Benz Service Centre.
- AdBlue® is available at many filling stations from AdBlue® filling pumps.
- Alternatively, AdBlue® is available at qualified specialist workshops, e.g. Mercedes-Benz Service Centres, and at many filling stations in AdBlue® refill canisters or AdBlue® refill bottles.

 Ensure the connection between the refill container and vehicle filler neck does not drip.

### Topping up AdBlue®

 **NOTE** Engine damage due to AdBlue® being in the fuel

- ▶ AdBlue® must not be used to fill the fuel tank.
- ▶ Only use AdBlue® to fill the AdBlue® tank.
- ▶ Do not overfill the AdBlue® tank.

 **NOTE** Contamination of the vehicle interior due to AdBlue® leakage

- ▶ After topping up, carefully close the AdBlue® refill container.
- ▶ Avoid carrying AdBlue® refill containers permanently in the vehicle.

### Requirements:

- The vehicle is unlocked.

The following messages appear in order in the driver's display when the AdBlue® tank requires topping up:

- **Refill AdBlue See Owner's Manual**The AdBlue® level has fallen below the reserve range. Top up AdBlue® immediately.
- **Top up AdBlue Emergency op. in XXX km See Owner's Manual**The low AdBlue® level will lead to limited performance after the remaining distance displayed has been driven. Top up AdBlue® immediately.
- **XX,X I Top up AdBlue Emerg. op.: max. XXX km/h Start not poss. in XXX km**The low AdBlue® level will lead to limited performance from the speed displayed. After the remaining distance displayed has been covered, it will no longer be possible to start the engine. Top up with at least the amount of AdBlue® displayed.
- **XX,X I Top up AdBlue Switch on ignition, wait 60 sec. or eng. start not poss..** The AdBlue® tank is empty. You can no longer start the engine. Top up with at least the amount of



AdBlue<sup>®</sup> displayed. Switch on the ignition and wait for approximately 60 seconds. Start the engine.

You can see the AdBlue<sup>®</sup> range and the level in the driver's display.

- ① The AdBlue<sup>®</sup> range shown depends strongly on the driving style and operating conditions. The actual range can therefore deviate from the calculated range.

### Opening the AdBlue<sup>®</sup> filler cap

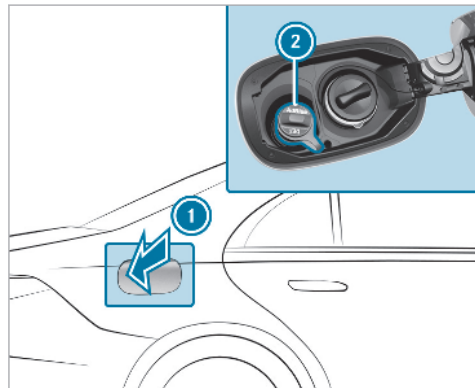

- ▶ Press on the back area of fuel filler flap ①.
- ▶ Turn AdBlue<sup>®</sup> filler cap ② anti-clockwise and remove it.
- ① You can also store the AdBlue<sup>®</sup> filler cap in the fuel filler cap holder in the fuel filler flap hinge arm.

### Topping up AdBlue<sup>®</sup>

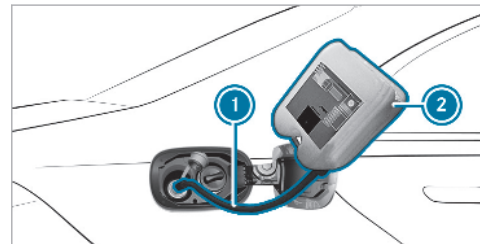

- ▶ Screw on the fastener of AdBlue<sup>®</sup> refill canister ②.
- ▶ Screw disposable hose ① onto the opening of AdBlue<sup>®</sup> refill canister ② until hand-tight.
- ▶ Screw disposable hose ① onto the filler neck of the vehicle until hand-tight.
- ▶ Lift up and tip AdBlue<sup>®</sup> refill canister ②. The filling process stops when the AdBlue<sup>®</sup> tank is completely full. AdBlue<sup>®</sup> refill canister ② can be removed when it has been only partially emptied.

- ▶ Unscrew and close disposable hose ① and AdBlue® refill canister ② in reverse order.
  - ▶ Replace the AdBlue® filler cap and turn it clockwise.
  - ▶ Close the fuel filler flap.
  - ▶ Switch on the ignition for at least 60 seconds.
- ⓘ If the vehicle could not be started as the AdBlue® tank was empty, it can take up to 60 seconds for the refill to be detected.
- ▶ Start the vehicle.
- ⓘ Avoid storing AdBlue® refill containers permanently in the vehicle.

## Parking

### Parking the vehicle

- ⚠ WARNING** Risk of accident and injury caused by an insufficiently secured vehicle rolling away.

If the vehicle is not securely parked sufficiently, it can roll away in an uncontrolled way even at a slight downhill gradient.

- ▶ On gradients, turn the front wheels so that the vehicle will roll towards the kerb if it starts moving.
- ▶ apply the parking brake.
- ▶ Switch the transmission to position **P**.

- ⚠ WARNING** Risk of fire caused by hot exhaust system parts

Flammable materials such as leaves, grass or twigs may ignite.

- ▶ Park the vehicle so that no flammable material can come into contact with hot vehicle components.

- ▶ In particular, do not park on dry grassland or harvested grain fields.

- ⚠ WARNING** Risk of accident and injury due to children left unattended in the vehicle

If children are left unsupervised in the vehicle, they could, in particular:

- open doors, thereby endangering other persons or road users.
- get out and be struck by oncoming traffic.
- operate vehicle equipment and become trapped, for example.

In addition, the children could also set the vehicle in motion, for example by:

- releasing the parking brake.
- change the transmission position.
- start the vehicle.

- ▶ Never leave children unattended in the vehicle.

- ▶ When leaving the vehicle, always take the key with you and lock the vehicle.
- ▶ Keep the key out of reach of children.

This also applies to the Digital Vehicle Key if the "Digital Vehicle Key" function is activated via Mercedes me connect.

**!** **NOTE** Damage to the vehicle due to it rolling away

- ▶ Always secure the vehicle against rolling away.

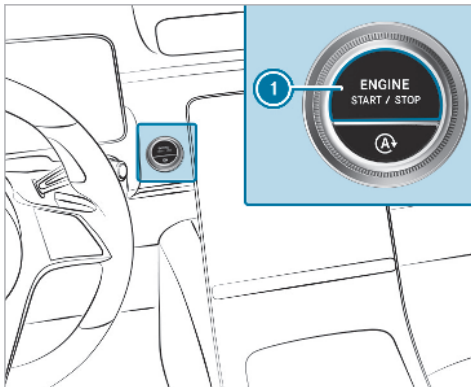

- ▶ Bring the vehicle to a standstill by applying the brake pedal.
- ▶ On gradients, turn the front wheels so that the vehicle will roll towards the kerb if it starts moving.
- ▶ Apply the electric parking brake.

- ▶ Engage transmission position **P** in a stationary vehicle with the brake pedal applied (→ page 187).
  - ▶ Switch off the engine and the ignition by pressing the **1** button.
  - ▶ Release the service brake slowly.
  - ▶ Get out of the vehicle and lock it.
- i** When you park the vehicle, you can still operate the side windows and the panorama sliding sunroof for approximately five minutes if the driver's door is closed.

## Garage door opener

### Programming buttons for the garage door opener

**!** **DANGER** Risk of death caused by exhaust gases

Combustion engines emit poisonous exhaust gases such as carbon monoxide. Inhaling these exhaust gases is hazardous to health and leads to poisoning.

- ▶ Never leave the engine or, if present, the auxiliary heating running in an enclosed space without sufficient ventilation.

**⚠ WARNING** Risk of injury when opening or closing a door with the garage door opener

When you operate or program the door with the integrated garage door opener, persons in the range of movement of the door may become trapped or be struck by the door.

- ▶ Always make sure that nobody is within the range of movement of the door.

### Requirements:

- The vehicle has been parked outside the garage or outside the range of movement of the door.
  - The engine is switched off.
  - The ignition is switched on.
- i** The garage door opener function is always available when the ignition is switched on.

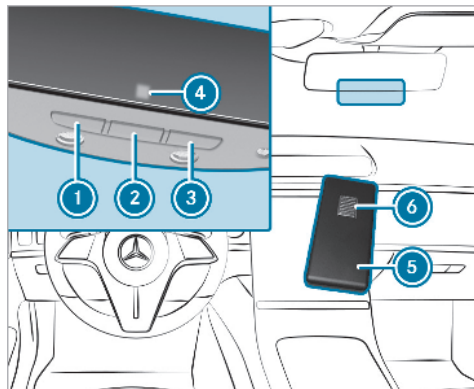

- ▶ Press and hold button ①, ② or ③ that you wish to program. Indicator lamp ④ flashes yellow.
- i** It can take up to 20 seconds before the indicator lamp flashes yellow.
- ▶ Release the previously pressed button. Indicator lamp ④ continues to flash yellow.

- ▶ Point remote control ⑤ from a distance of 1 cm to 8 cm towards button ①, ② or ③.
- ▶ Press and hold button ⑥ of remote control ⑤ until one of the following signals appears:
  - Indicator lamp ④ lights up green continuously. Programming is complete.
  - Indicator lamp ④ flashes green. Programming was successful. Additionally, synchronisation of the rolling code with the door system must also be carried out.
- ▶ If indicator lamp ④ does not light up or flash green: repeat the procedure.
- ▶ Release all of the buttons.

**i** The remote control for the door drive is not included in the scope of delivery of the garage door opener.

### Synchronising the rolling code Requirements:

- The door system uses a rolling code.
- The vehicle must be within range of the garage door or door drive.

- The vehicle as well as persons and objects are located outside the range of movement of the door.

- ▶ Press the programming button on the door drive unit. Initiate the next step within approximately 30 seconds.
- ▶ Press previously programmed button ①, ② or ③ repeatedly until the door closes. When the door closes, programming is completed.

- ⓘ Please also read the operating instructions for the door drive.

### Troubleshooting when programming the remote control

- ▶ Check if the transmitter frequency of remote control ⑤ is supported.
- ▶ Replace the batteries in remote control ⑤.
- ▶ Hold remote control ⑤ at various angles from a distance of 1 cm to 8 cm front of the inside rearview mirror. You should test every position for at least 25 seconds before trying another position.

- ▶ Hold remote control ⑤ at the same angles at various distances in front of the inside rear view mirror. You should test every position for at least 25 seconds before trying another position.

- ▶ Note that some remote controls transmit only for a limited period, press button ⑥ on remote control ⑤ again before transmission ends.

- ▶ Align the aerial line of the door opener unit with the remote control.

- ⓘ Support and additional information on programming:

- On the HomeLink® Hotline on (0) 08000 466 354 65 or +49 (0) 6838 907-277.
- On the Internet at <https://www.homelink.com>.

### Opening or closing the garage door Requirements:

- The corresponding button is programmed to operate the door.

- ▶ Press and hold buttons ①, ② or ③ until the door opens or closes.
- ▶ If indicator lamp ④ flashes yellow after approximately 20 seconds: press and hold the previously pressed button again until the door opens or closes.

### Clearing the garage door opener memory

- ▶ Press and hold buttons ① and ③. Indicator lamp ④ lights up yellow.
- ▶ If indicator lamp ④ flashes green: release buttons ① and ③. The entire memory has been deleted.

## Electric parking brake

### Electric parking brake function (applying automatically)

**⚠ WARNING** Risk of accident and injury due to children left unattended in the vehicle

If children are left unsupervised in the vehicle, they could, in particular:

- open doors, thereby endangering other persons or road users.
- get out and be struck by oncoming traffic.
- operate vehicle equipment and become trapped, for example.

In addition, the children could also set the vehicle in motion, for example by:

- releasing the parking brake.
- change the transmission position.
- start the vehicle.

- ▶ Never leave children unattended in the vehicle.
- ▶ When leaving the vehicle, always take the key with you and lock the vehicle.
- ▶ Keep the key out of reach of children.

This also applies to the Digital Vehicle Key if the "Digital Vehicle Key" function is activated via Mercedes me connect.

The electric parking brake is applied if the transmission is in position **P** and one of the following conditions is fulfilled:

- The engine is switched off.
- The seat belt tongue is not inserted in the seat belt buckle of the driver's seat and the driver's door is opened.

**i** To prevent application: pull the handle of the electric parking brake.

In the following situations, the electric parking brake is also applied:

- Active Distance Assist DISTRONIC is bringing the vehicle to a standstill.

- The HOLD function is keeping the vehicle stationary.
- Active Parking Assist is keeping the vehicle stationary.

This is the case if one of the following conditions is also fulfilled:

- The engine is switched off.
- The seat belt tongue is not inserted in the seat belt buckle of the driver's seat and the driver's door is opened.
- There is a system malfunction.
- The power supply is insufficient.
- The vehicle is stationary for a lengthy period.

When the electric parking brake is applied, the red **(P)** indicator lamp appears in the driver's display.

The electric parking brake is not automatically applied if the engine is switched off by the ECO start/stop function.

### Electric parking brake function (releasing automatically)

The electric parking brake is released when the following conditions are fulfilled:

- The driver's door is closed.
- The engine is running.
- The transmission is in position **D** or **R** and you depress the accelerator pedal or you shift from transmission position **P** to **D** or **R** when on level ground with the driver's door closed.
- If the transmission is in position **R**, the boot lid must be closed.
- The seat belt tongue is inserted into the seat belt buckle of the driver's seat.

If the seat belt tongue is not inserted into the seat belt buckle of the driver's seat, one of the following conditions must be fulfilled:

- You shift from transmission position **P**.
- You have previously driven at speeds greater than 3 km/h.

When the electric parking brake is released, the red **(P)** indicator lamp in the driver's display goes out.

### Applying/releasing the electric parking brake manually

#### Applying

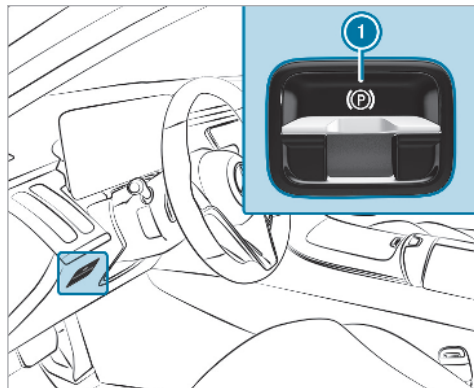

- ▶ Push handle ①.

The red **(P)** indicator lamp appears in the driver's display.

- ① The electric parking brake is only securely applied if the indicator lamp is lit continuously.

#### Releasing

- ▶ Switch on the ignition.

- ▶ Pull handle ①.

The red **(P)** indicator lamp appears in the driver's display.

#### Emergency braking

- ▶ Press and hold handle ①.

As long as the vehicle is driving, the **Release parking brake** message is displayed.

When the vehicle has been braked to a standstill, the electric parking brake is applied. The red **(P)** indicator lamp appears in the driver's display.

## Information on collision detection on a parked vehicle

If a collision is detected when the tow-away protection is primed on a locked vehicle, you will receive a notification in the multimedia system when you switch on the ignition.

You will receive information about the following points:

- The area of the vehicle that may have been damaged.
- The force of the impact.

The following situations can lead to inadvertent activation:

- The parked vehicle is moved, e.g. in a two-storey garage.

**i** Deactivate tow-away protection in order to prevent inadvertent activation. If you deactivate tow-away protection, collision detection will also be deactivated. You can permanently deactivate the collision detection via the multimedia system (→ page 202).

## System limits

Detection may be restricted in the following situations:

- the vehicle is damaged without impact, e.g. if an outside mirror is torn off or the paint is damaged by a key
- an impact occurs at low speed
- the electric parking brake is not applied

## Setting collision detection on a parked vehicle (MMS)

Multimedia system:

→  **Settings** **Vehicle**  
**Collision notification**

▶ Activate or deactivate the function.

## Activating or deactivating the collision photos function

Please note possible legal restrictions in some countries regarding automatic recording of the vehicle surroundings.

▶ Activate or deactivate **Collision photos**.

## Transferring the collision photos with the Mercedes me App

- ▶ Select **Upload collision photos**.
- ▶ Scan the QR code on the central display with the Mercedes me App. The encrypted collision photos will then be uploaded to Mercedes me.
- i** Any device that can scan QR codes can be used to view the collision photos in the Mercedes me App.

## Copying the collision photos onto a USB flash drive

- ▶ Connect a USB flash drive (→ page 425).
- ▶ Select **Manage collision photos**.
- ▶ Select **Copy (USB)**. All collision photos are copied onto the USB flash drive.

## Deleting collision photos

- ▶ Select **Manage collision photos**.
- ▶ Select **Delete**. All collision photos will be deleted.



## Notes on parking up the vehicle

If you leave the vehicle parked up for longer than six weeks, it may suffer damage through disuse.

The 12 V battery may also be impaired or damaged by heavy discharging.

- ① Further information can be obtained at a qualified specialist workshop.

## Standby mode (extension of the starter battery's period out of use)

### Standby mode function

- ① This function is not available for all models.
- If standby mode is activated, energy loss will be minimised during extended periods of non-operation.
- Standby mode is characterised by the following:
- The starter battery is preserved.
  - The maximum non-operational time appears in the media display.
  - The connection to online services is interrupted.

If the following conditions are fulfilled, standby mode can be activated or deactivated using the multimedia system:

- The engine is switched off.
- The ignition is switched on.

Exceeding the vehicle's displayed non-operational time may cause inconvenience, i.e. it cannot be guaranteed that the starter battery will reliably start the engine.

The starter battery must be charged first in the following situations:

- The vehicle's non-operational time must be extended.
  - The **Battery charge insufficient for standby mode** message appears in the media display.
- ① Standby mode is automatically deactivated when the ignition is switched on.

### Activating/deactivating standby mode (parking up the vehicle)

#### Requirements:

- The engine is switched off.

Multimedia system:

→  » Settings » Vehicle  
» Other functions

▶ Activate or deactivate **Standby mode**.

## Driving and driving safety systems

### Driving systems and your responsibility

Your vehicle is equipped with driving systems which assist you in driving, parking and manoeuvring the vehicle. The driving systems are only aids. They are not a substitute for your attention to the surroundings and do not relieve you of your responsibility pertaining to road traffic law. The driver is always responsible for maintaining a safe distance to the vehicle in front, for vehicle speed, for braking in good time and for staying in lane. Pay attention to the traffic conditions at all times and intervene when necessary. Be aware of the limitations regarding the safe use of these systems.

Driving systems can neither reduce the risk of accident if you fail to adapt your driving style nor override the laws of physics. They cannot always

take into account road, weather or traffic conditions.

### Information on vehicle sensors and cameras

Some driving and driving safety systems use radar, lidar or ultrasonic sensors and cameras to monitor the area in front of, behind or next to the vehicle (depending on the vehicle's equipment).

Depending on the vehicle's equipment, the radar and lidar sensors are integrated behind the bumpers and/or behind the Mercedes star. The ultrasonic sensors are located in the front and rear bumpers. The cameras are located behind the front and rear windows. Keep these parts free of dirt, ice and slush (→ page 465). The sensors must not be covered, for example by bicycle racks, overhanging loads, stickers, foil or foils to protect against stone chipping. Additional licence plate brackets can likewise impair the function of the ultrasonic sensors.

In the event of damage to the bumpers or radiator grille, or following a collision impacting the bumpers or radiator grille, have the function of

the sensors checked at a qualified specialist workshop. Have damage or stone chipping in the area of the cameras on the front and rear windows repaired at a qualified specialist workshop. If the sensors or cameras are damaged, some driving systems and driving safety systems may no longer function properly.

### Overview of driving systems and driving safety systems

In this section, you will find information about the following driving systems and driving safety systems:

- 360° Camera (→ page 244)
- ABS (**A**nti-**l**ock **B**raking **S**ystem) (→ page 205)
- Active Distance Assist DISTRONIC (→ page 219)
- Adaptive Brake Lights (→ page 215)
- AIRMATIC (→ page 233)
- Active Brake Assist (→ page 208)
- Active Lane Keeping Assist (→ page 263)

- Traffic Light Assist (→ page 259)
- ATTENTION ASSIST (→ page 253)
- BAS (**B**rake **A**ssist **S**ystem) (→ page 205)
- Hill Start Assist (→ page 232)
- E-ACTIVE BODY CONTROL (→ page 236)
- EBD (**E**lectronic **B**rake**f**orce **D**istribution) (→ page 208)
- ESP® (**E**lectronic **S**tability **P**rogram) (→ page 205)
- ESP® Crosswind Assist (→ page 207)
- ESP® trailer stabilisation (→ page 207)
- Active Speed Limit Assist (→ page 223)
- HOLD function (→ page 232)
- STEER CONTROL (→ page 208)
- Active Steering Assist (→ page 225)
- Limiter (→ page 216)
- Active Emergency Stop Assist (→ page 230)
- Active Parking Assist (→ page 247)
- Parking Assist PARKTRONIC (→ page 239)
- Reversing camera (→ page 241)

- Active Lane Change Assist (→ page 227)
- Cruise control (→ page 215)
- Blind Spot Assist and Active Blind Spot Assist with exit warning (→ page 260)
- Traffic Sign Assist (→ page 256)

### Function of ABS

The Anti-lock Brake System (ABS) regulates the brake pressure in critical driving situations:

- During braking, e.g. at full brake application or insufficient tyre traction, the wheels are prevented from locking.
- Vehicle steerability while braking is ensured.

If ABS intervenes when braking, you will feel a pulsing in the brake pedal. The pulsating brake pedal can be an indication of hazardous road conditions and can serve as a reminder to take extra care while driving.

### Function of BAS

The Brake Assist System (BAS) supports your emergency braking situation with additional brake force.

If you depress the brake pedal quickly, BAS is activated:

- BAS automatically boosts the brake pressure.
- BAS can shorten the braking distance.
- ABS prevents the wheels from locking.

The brakes will function as usual once you release the brake pedal. BAS is deactivated.

### Function of ESP® (Electronic Stability Program)

**⚠ WARNING** Risk of skidding if ESP® is deactivated

If you deactivate ESP®, ESP® cannot carry out vehicle stabilisation.

▶ ESP® should only be deactivated in the following situations.

ESP® can monitor and improve driving stability and traction in the following situations, within physical limits:

- When pulling away on wet or slippery carriageways.
- When braking.

If the vehicle deviates from the direction desired by the driver, ESP® can stabilise the vehicle by intervening in the following ways:

- One or more wheels are braked.
- The engine output is adapted according to the situation.

When ESP® is deactivated, the  warning lamp lights up continuously:

- Driving stability will no longer be improved.
- The drive wheels could spin.
- ETS/4ETS traction control is still active.

- ⓘ When ESP® is deactivated, you are still assisted by ESP® when braking.

When the  warning lamp flashes, one or several wheels has reached its grip limit:

- Adapt your driving style to suit the current road and weather conditions.
- Do not deactivate ESP®.
- Only depress the accelerator pedal as far as is necessary when pulling away.

Deactivate ESP® in the following situations to improve traction:

- When using snow chains.
- In deep snow.
- On sand or gravel.

- ⓘ Spinning the wheels results in a cutting action, which enhances traction.

If the  ESP® warning lamp lights up continuously, ESP® is not available due to a malfunction.

Observe the following information:

- Indicator and warning lamps (→ page 634)
- Display messages (→ page 574)

### ETS/4ETS (Electronic Traction System)

ETS/4ETS traction control is part of ESP® and makes it possible to pull away and accelerate on a slippery carriageway.

ETS/4ETS can improve the vehicle's traction by intervening in the following ways:

- The drive wheels are braked individually if they spin.
- More drive torque is transferred to the wheel or wheels with traction.



### Influence of drive programs on ESP®

The drive programs enable ESP® to adapt to different weather and road conditions as well as the driver's preferred driving style. You can select the drive programs using the DYNAMIC SELECT switch (→ page 184).

### ESP® modes

Depending on the selected drive program, the appropriate ESP® mode will be activated automatically. You can select the drive programs using the DYNAMIC SELECT switch (→ page 184).

### ESP® Comfort

- drive program ,  and 
- balance between traction and stability
- recommended for all road surface conditions
- suitable for dry and difficult road conditions (e.g. snow and ice or wet road surface)

### ESP® Sport

- drive program 
- offers stability but with a sporty setup
- allows the sporty driver a more active driving style
- only suitable for good road conditions, a dry road surface and a clear stretch of road

### ESP® Sport +

- drive program 
- emphasises the vehicle's own oversteering and understeering characteristics for a more active driving style
- only suitable for good road conditions, a dry road surface and a clear stretch of road

## Activating/deactivating ESP® (Electronic Stability Program)

Multimedia system:

  **Vehicle quick-access**

- ESP® can only be activated/deactivated using quick access when at least one other function is available in quick access. ESP® can otherwise be found in the [Assistance](#) menu.

Select **ESP**.

Select **On** or  **Off**.

ESP® is deactivated if the  ESP® OFF warning lamp lights up continuously in the instrument cluster.

Observe the information on warning lamps and display messages which may be shown in the instrument cluster.

## Function of ESP® Crosswind Assist

ESP® Crosswind Assist detects sudden gusts of side wind and helps the driver to keep the vehicle in the lane:

- ESP® Crosswind Assist is active at vehicle speeds between approx. 80 km/h and 200 km/h when driving straight ahead or cornering slightly.
- The vehicle is stabilised by means of a targeted and individual brake application on one side.

## Function of ESP® trailer stabilisation

**⚠ WARNING** Risk of accident in poor road and weather conditions

In poor road and weather conditions, the trailer stabilisation cannot prevent lurching of the vehicle/trailer combination. Trailers with a high centre of gravity may tip over before ESP® detects this.

Always adapt your driving style to suit the current road and weather conditions.

When driving with a trailer, ESP® can stabilise your vehicle if the trailer begins to swerve from side to side:

- ESP® trailer stabilisation is active above speeds of 65 km/h.
- Slight swerving is reduced by means of a targeted, individual brake application on one side.
- In the event of severe swerving, the engine output is also reduced and all wheels are braked.

ESP® trailer stabilisation may be impaired or may not function if:

- The trailer is not connected correctly or is not detected properly by the vehicle.

### Function of EBD

Electronic Brakeforce Distribution (EBD) is characterised by the following:

- Monitoring and regulating the brake pressure on the rear wheels.
- Improved driving stability when braking, especially on bends.

### Function of STEER CONTROL

STEER CONTROL helps you by transmitting a noticeable steering force to the steering wheel in the direction required for vehicle stabilisation.

This steering recommendation is given particularly in the following situations:

- Both right wheels or both left wheels are on a wet or slippery road surface when you brake.
- The vehicle starts to skid.

### System limits

STEER CONTROL may be impaired or may not function in the following situations:

- ESP® is deactivated.
- ESP® is malfunctioning.
- The steering is malfunctioning.

If ESP® is malfunctioning, you will be assisted further by the electric power steering.

### Function of Active Brake Assist

Active Brake Assist consists of the following functions:

- Distance warning function
- Autonomous braking function
- Situation-dependent braking assistance
- **Vehicles with Driving Assistance Package:** Evasive Steering Assist and cornering function

Active Brake Assist can help you to minimise the risk of a collision with vehicles, cyclists, large

animals (at animal crossings) or pedestrians, or reduce the effects of such a collision.

**Vehicles with Driving Assistance Package:** to minimise the risk of collision when pulling away even further, Active Brake Assist also limits the possible acceleration.

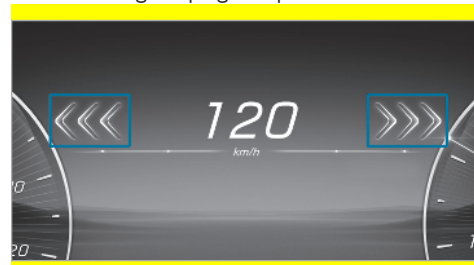

**Vehicles with Driving Assistance Package:** Active Brake Assist can also help to minimise the risk of collision with pedestrians and cyclists when turning by monitoring the area which the vehicle will cross.

If Active Brake Assist has detected a risk of collision, a warning tone sounds and the  distance warning lamp lights up.

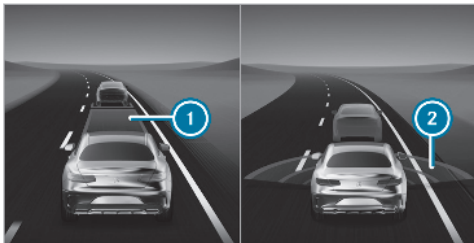

If, when pulling away at walking pace, the risk of collision with other crossing vehicles is detected, three red arrows pointing in the corresponding direction light up in the instrument cluster. Depending on the situation, these can either appear one after the other or flash simultaneously. If the situation is particularly critical, a warning tone will also sound and the  distance warning lamp will light up.



Too small a distance to the vehicle in front  is displayed in red in the menu "Assistance" in the multifunction display. If the gap becomes even smaller, the vehicle in front will also be highlighted red. In case of autonomous braking, red radar waves  appear in front of the vehicle.

**Vehicles with PRE-SAFE®:** depending on the country, an additional haptic warning occurs in the form of slight, repeated tensioning of the seat belt.

If you do not react to the warning, autonomous braking can be initiated in critical situations.

In particularly critical situations, Active Brake Assist can also initiate autonomous braking directly. In this case, the warning lamp and warning tone occur simultaneously with the braking application.

If you apply the brake yourself in a critical situation or apply the brake during autonomous braking, situation-dependent braking assistance occurs. The brake pressure increases up to maximum full-stop braking if necessary.

 If autonomous braking or situation-dependent braking assistance has occurred, a pop up appears in the multifunction display and then automatically goes out after a short time.



If the autonomous braking function or the situation-dependent braking assistance is triggered,

additional preventive measures for occupant protection (PRE-SAFE®) may also be initiated.

 **WARNING** Risk of an accident caused by limited detection performance of Active Brake Assist

Active Brake Assist cannot always clearly identify objects and complex traffic situations.

In such cases, Active Brake Assist might:

- Give a warning or brake without reason
  - Not give a warning or not brake
-  Always pay careful attention to the traffic situation; do not rely on Active Brake Assist alone. Active Brake Assist is only an aid. The driver is responsible for maintaining a suitable distance to the vehicle in front, vehicle speed and for braking in good time.
-  Be prepared to brake or swerve if necessary.

 If the system is unavailable, the  display appears in the multifunction display.

Also observe the system limits of Active Brake Assist.

### **The individual subfunctions are available in the following speed ranges:**

The distance warning function issues a warning in the following situations:

- From approximately 30 km/h, if over several seconds the distance maintained to the vehi-

cle travelling in front is insufficient for the driven speed, the  distance warning lamp lights up in the instrument cluster.

- From approximately 7 km/h, if your vehicle is critically close to a vehicle or pedestrian, you will hear an intermittent warning tone and the  distance warning lamp lights up in the instrument cluster.

**Vehicles with PRE-SAFE®:** depending on the country, an additional haptic warning

occurs in the form of slight, repeated tensioning of the seat belt.

Brake immediately or take evasive action, provided it is safe to do so and the traffic situation allows this.



The distance warning function can aid you in the following situations with an intermittent warning tone and a warning lamp:

	Vehicles travelling in front	Stationary vehicles	Crossing vehicles	Crossing pedestrians	Stationary pedestrians	Crossing cyclists	Cyclists travelling in front	Stationary cyclists
Vehicles without Driving Assistance Package	Up to approx. 250 km/h	Up to approx. 80 km/h	No reaction	Up to approx. 80 km/h	No reaction	Up to approx. 60 km/h	Up to approx. 80 km/h	No reaction
Vehicles with Driving Assistance Package	Up to approx. 250 km/h	Up to approx. 100 km/h	Up to approx. 120 km/h	Up to approx. 120 km/h	Up to approx. 70 km/h	Up to approx. 120 km/h	Up to approx. 80 km/h	Up to approx. 70 km/h

The autonomous braking function may intervene in the following situations:

	Vehicles travelling in front	Stationary vehicles	Crossing vehicles	Crossing pedestrians	Stationary pedestrians	Crossing cyclists	Cyclists travelling in front	Stationary cyclists
Vehicles without Driving Assistance Package	From 7 km/h up to approx. 200 km/h	From 7 km/h up to approx. 50 km/h	No reaction	From 7 km/h up to approx. 60 km/h	No reaction	From 7 km/h up to approx. 60 km/h	From 7 km/h up to approx. 80 km/h	No reaction
Vehicles with Driving Assistance Package	From 7 km/h up to approx. 250 km/h	From 7 km/h up to approx. 100 km/h	Up to approx. 120 km/h	Up to approx. 120 km/h	From 7 km/h up to approx. 70 km/h	Up to approx. 120 km/h	From 7 km/h up to approx. 80 km/h	From 7 km/h up to approx. 70 km/h

The situation-dependent braking assistance may intervene in the following situations:

	Vehicles travelling in front	Stationary vehicles	Crossing vehicles	Crossing pedestrians	Stationary pedestrians	Crossing cyclists	Cyclists travelling in front	Stationary cyclists
Vehicles without Driving Assistance Package	From 7 km/h up to approx. 200 km/h	From 7 km/h up to approx. 50 km/h	No reaction	From 7 km/h up to approx. 60 km/h	No reaction	From 7 km/h up to approx. 60 km/h	From 7 km/h up to approx. 80 km/h	No reaction
Vehicles with Driving Assistance Package	From 7 km/h up to approx. 250 km/h	From 7 km/h up to approx. 100 km/h	Up to approx. 120 km/h	Up to approx. 120 km/h	From 7 km/h up to approx. 70 km/h	Up to approx. 120 km/h	From 7 km/h up to approx. 80 km/h	From 7 km/h up to approx. 70 km/h

### Cancelling a brake application of Active Brake Assist

You can cancel a brake application of Active Brake Assist at any time by:

- Activating kickdown.
- Releasing the brake pedal.

Active Brake Assist may cancel the brake application when one of the following conditions is fulfilled:

- You manoeuvre to avoid the obstacle.
- There is no longer a risk of collision.
- An obstacle is no longer detected in front of your vehicle.

### Reaction to oncoming road users (only vehicles with Driving Assistance Package)

Active Brake Assist can also react to detected oncoming road users:

- Reaction up to speeds of approximately 100 km/h
- Warning for oncoming road users through acoustic warning and warning lamp

- Autonomous braking application in order to reduce the severity of an accident

### **Evasive Steering Assist (only vehicles with Driving Assistance Package)**

**⚠ WARNING** Risk of an accident despite Evasive Steering Assist

Evasive Steering Assist cannot always clearly identify objects and complex traffic situations.

In addition, the steering support of Evasive Steering Assist is generally not sufficient to avoid a collision.

In such cases Evasive Steering Assist can:

- give an unnecessary warning or provide assistance
- not give a warning or not provide assistance

▶ Always pay careful attention to the traffic situation; do not rely on Evasive Steering Assist alone.

- ▶ Be ready to brake and take evasive action, if necessary.
- ▶ Prevent the assistance by actively steering in non-critical driving situations.
- ▶ Drive at an appropriate speed if pedestrians are close to the path of your vehicle.

Evasive Steering Assist has the following characteristics:

- Detection of pedestrians, cyclists and vehicles.
- Assistance through power-assisted steering if it detects a swerving manoeuvre.
- Activation by an abrupt steering movement during a swerving manoeuvre.
- Assistance during swerving and straightening of the vehicle.
- Reaction from a speed of approximately 20 km/h up to a speed of approximately 70 km/h.

You can prevent the assistance at any time by actively steering.

### **Cornering function (only vehicles with Driving Assistance Package)**

If a risk of collision with an oncoming vehicle is detected when turning, autonomous braking can be initiated at speeds up to approx. 20 km/h.

### **System limits**

Full system performance is not available for a few seconds after switching on the ignition or after driving off.

The system may be impaired or may not function in the following situations:

- In snow, rain, fog, heavy spray, if there is glare, in direct sunlight or in greatly varying light conditions.
- If the sensors are dirty, misted up, damaged or covered.
- If the sensors are impaired due to interference from other radar sources, e.g. strong radar reflections in multi-storey car parks.
- If a loss of tyre pressure or a defective tyre has been detected and displayed.

- In complex traffic situations where objects cannot always be clearly identified.
  - In the case of persons smaller than approx. 1.10 m.
  - If pedestrians, cyclists or vehicles move quickly into the sensor detection range.
  - If road users are hidden by other objects or are located close to other objects.
  - If the typical outline of a pedestrian or cyclist cannot be distinguished from the background.
  - If a pedestrian or cyclist is not detected as such, e.g. due to special clothing or other objects.
  - On bends with a tight radius.
- i** The Active Brake Assist sensors adjust automatically while a certain distance is being driven after the vehicle has been delivered. Active Brake Assist is unavailable or only partially available during this teach-in period.

## Setting Active Brake Assist

### Requirements:

- The ignition is switched on.

Multimedia system:

  **» Settings** **» Assistance**  
**» Active Brake Assist**

- ▶ Select the desired setting.  
The setting is retained when the engine is next started.

### Deactivating Active Brake Assist

- i** It is recommended that you always leave Active Brake Assist activated.
- ▶ Select **Off**.  
The distance warning function, the autonomous braking function and the Evasive Steering Assist are deactivated.  
When the engine is next started, the medium setting is automatically selected.
- i** If Active Brake Assist is deactivated, the  symbol appears in the status bar of the multifunction display.

## Function of Adaptive Brake Lights

Adaptive Brake Lights warn following traffic in an emergency braking situation with the following actions:

- By flashing the brake lamps
- By activating the hazard warning lights

If the vehicle is braked sharply from speeds above 50 km/h, the brake lamps flash rapidly. This provides traffic travelling behind you with an even more noticeable warning.

If the vehicle is travelling at speeds of more than 70 km/h at the beginning of the brake application, the hazard warning lights switch on once the vehicle is stationary. When you pull away again, the hazard warning lights will switch off automatically at approximately 10 km/h. You can also switch off the hazard warning lights using the hazard warning button.

## Cruise control and limiter

### Function of cruise control



Cruise control regulates the speed to the value selected by the driver.

If you accelerate to overtake, for example, the stored speed is not deleted. If you remove your foot from the accelerator pedal after overtaking, cruise control will resume speed regulation back to the stored speed.

Cruise control is operated using the corresponding steering wheel buttons. You can store any speed above 20 km/h up to the maximum design speed or up to the set winter tyre limit.

Observe the notes on driving systems and your responsibility; you may otherwise fail to recognise dangers (→ page 203).

### Messages in the driver's display

-  (grey): cruise control is selected but not yet active, or temporarily passive.
-  (green): cruise control is active.

A stored speed appears under the  display. If cruise control is active or temporarily passive, the speed dial in the speedometer will be greyed out up to the currently stored speed.

### System limits

Cruise control may be unable to maintain the stored speed on uphill gradients. The stored speed is resumed when the gradient evens out.

Change into a lower gear in good time on long and steep downhill gradients. Take particular note of this when driving a laden vehicle. By doing so, you will make use of the engine's braking effect. This relieves the load on the brake system and prevents the brakes from overheating and wearing too quickly.

Do not use cruise control in the following situations:

- In traffic situations which require frequent changes of speed, e.g. in heavy traffic, on winding roads.
- On slippery roads. Accelerating can cause the drive wheels to lose traction and the vehicle could then skid.
- If you are driving when visibility is poor.

### Function of the limiter

The limiter restricts the speed of the vehicle. To reduce the speed to the set speed, the limiter applies the brakes automatically.



You can limit the speed as follows:

- **Variable:** for a temporary restriction of the vehicle speed, for example, in built-up areas.
- **Permanent:** for a permanent restriction of the vehicle speed, for example, when driving in winter tyre mode.

The variable limiter is operated using the corresponding steering wheel buttons. You can store any speed above 20 km/h up to the maximum design speed or up to the set winter tyre limit. You can also perform settings while the vehicle is stationary if the vehicle has been started.

Observe the notes on driving systems and your responsibility; you may otherwise fail to recognise dangers (→ page 203).

### Messages in the driver's display

-  (grey): variable limiter is selected but not yet activated.
-  (flashes grey): variable limiter is temporarily passive.
-  (green): variable limiter is activated.

A stored speed appears under the **LIM** display. If the variable limiter is active, the speed dial in the speedometer will be greyed out up to the currently stored speed.

- ① When the driving speed is greater than the stored speed, display **LIM** flashes.

### Kickdown

If you depress the accelerator pedal beyond the pressure point (kickdown), the variable limiter switches to passive mode. The **LIM** *pas-*  
*sive* message appears in the driver's display.

After completion of kickdown, the variable limiter is activated again in the following situations:

- If the driven speed drops below the stored speed.
- If the stored speed is called up.
- If you store a new speed.

### Operating cruise control or the variable limiter

**⚠ WARNING** Risk of accident due to stored speed

If you call up the stored speed and this is lower than your current speed, the vehicle decelerates.

- ▶ Take into account the traffic situation before calling up the stored speed.

### Requirements:

#### Cruise control

- Cruise control is selected.
- ESP® must be activated, but not intervening.
- The driven speed is at least 20 km/h.
- The transmission is in position **D**.

#### Variable limiter

- The vehicle has been started.
- The variable limiter is selected.

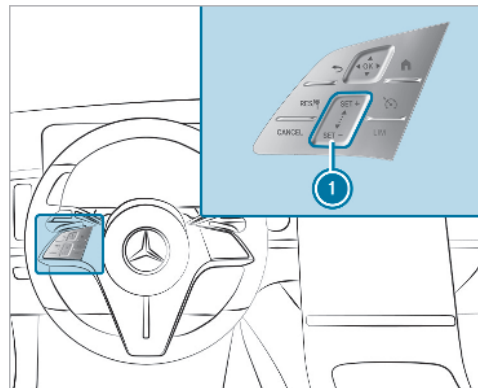

Steering wheel control panel for cruise control and limiter

- RES+** Adopts the stored/detected speed
- CANCEL** Deactivates cruise control/the variable limiter
- CC** Selects cruise control
- LIM** Selects the limiter
- ① Control panel to increase/decrease speed

### Switching between cruise control and the variable limiter:

▶ **To select cruise control:** press .

▶ **To select the variable limiter:** press .

❗ Vehicles with Active Distance Assist DISTRONIC: the variable limiter is selected by a different button (→ page 221).

### Activating cruise control or the variable limiter:

▶ Press (SET+) or (SET-) in control panel . The current driven speed is stored and the vehicle maintains this speed (cruise control) or does not exceed it (limiter).

or

▶ Press . The last stored speed is called up and the vehicle maintains this speed (cruise control) or does not exceed it (variable limiter).

If the last stored speed has previously been deleted, the currently driven speed is stored.

❗ When you switch off the vehicle, the last speed stored is cleared.

When you activate cruise control or Active Distance Assist DISTRONIC, the last speed stored for the variable limiter is cleared.

### Increasing/decreasing the stored speed:

▶ To increase the stored speed: swipe upwards from the bottom of control panel .

- The stored speed is increased by 1 km/h.

▶ To decrease the stored speed: swipe downwards from the top of control panel .

- The stored speed is decreased by 1 km/h.

or

▶ Briefly press (SET+) or (SET-) in control panel .

The stored speed is increased or decreased to the next increment of ten (e.g. to 50 km/h or 60 km/h).

or

▶ Press and hold (SET+) or (SET-) in control panel . The stored speed is increased or decreased to the next increment of ten and afterwards by increments of 10 km/h.

or

▶ Accelerate the vehicle to the desired speed.

▶ Press (SET+) in control panel .

❗ When the variable limiter is switched to passive mode, you cannot increase or decrease its stored speed in increments of 1 km/h.

### Adopting a detected speed:

If cruise control/variable limiter is activated and Traffic Sign Assist has detected a speed restriction sign with a maximum permissible speed and this is displayed in the instrument cluster:

▶ Press .

The maximum permissible speed shown by the traffic sign is stored and the vehicle maintains or does not exceed this speed.

### Deactivating cruise control or the variable limiter:

▶ Press .

❗ If you brake, deactivate ESP® or if ESP® intervenes, cruise control is deactivated. The variable limiter is not deactivated.



### Permanent limiter

If the vehicle should never exceed a specific speed (e.g. for driving in winter tyre mode), you can set this speed with the permanent limiter.

You do this by limiting the speed to a value between 160 km/h and 240 km/h in the multimedia system (→ page 219).

Shortly before the set speed is reached, it appears in the driver's display. When you confirm the message, display messages no longer appear until you switch off the vehicle. The speed will only be displayed again once the vehicle has been restarted or if the set speed is changed.

The permanent limiter does not switch to passive mode even during kickdown and the driven speed remains below the set speed.

### Setting the speed limitation for winter tyres

Multimedia system:

 **Settings** **Vehicle**  
**Winter tyre limit**

 Select a speed or deactivate the function.

### Active Distance Assist DISTRONIC

#### Function of Active Distance Assist DISTRONIC

Active Distance Assist DISTRONIC maintains the set speed on free-flowing roads. If vehicles in front are detected, the set distance is maintained, if necessary, until the vehicle comes to a halt. The vehicle accelerates or brakes depending on the distance to the vehicle in front and the set speed. The speed and distance to the vehicle in front are set and saved on the steering wheel on vehicles without the Driving Assistance Package, in the range between 20 km/h and 200 km/h and, on vehicles with the Driving Assistance Package, in the range between 20 km/h and 210 km/h.

Other features of Active Distance Assist DISTRONIC:

- Adjusts the driving style depending on the selected drive program (fuel-saving, comfortable or dynamic) (→ page 184)
- **Vehicles with Driving Assistance Package:** reacts to stationary vehicles detected (except bicycles and motorcycles)

- Initiates acceleration to the stored speed if the turn signal indicator is switched on to change to the overtaking lane
- **Vehicles with Driving Assistance Package:** takes one-sided overtaking restrictions into account on motorways or on multi-lane roads with separate carriageways (country-dependent)

#### Vehicles with Active Parking Assist and Driving Assistance Package:

if the vehicle has been braked to a standstill by Active Distance Assist DISTRONIC, it can automatically follow the vehicle in front driving off again within 30 seconds. If a critical situation is detected when driving off, a visual and acoustic warning is given indicating that the driver must now take control of the vehicle. The vehicle is not accelerated any further.

Observe the notes on driving systems and your responsibility; you may otherwise fail to recognise dangers (→ page 203).

## Active Distance Assist DISTRONIC display in the multifunction display

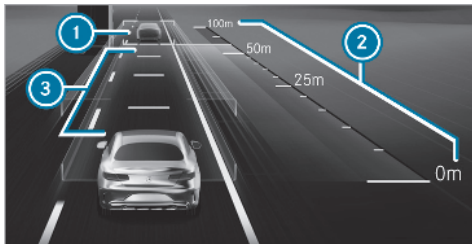

- ① Vehicle in front
- ② Distance indicator
- ③ Set specified distance

Vehicle detected in front ① is highlighted in green. It may also be in the lane to the left of your vehicle in situations where it is not permitted to overtake on the right, for example, on motorways.

## Permanent status display of Active Distance Assist DISTRONIC

- (white): Active Distance Assist DISTRONIC selected, specified distance set
- (green): Active Distance Assist DISTRONIC active, specified distance set and vehicle detected

The stored speed is shown under the permanent status display and highlighted on the speedometer. When Active Distance Assist DISTRONIC is passive, the speed is greyed out under the status display.

If the speed of the vehicle in front or the speed adjustment is less than the stored speed due to the route event ahead, the segments in the speedometer light up.

When the set specified distance is increased or decreased, the display briefly appears under the vehicle in the permanent status display.

- ① On motorways or high-speed major roads, the green vehicle symbol is displayed cyclically when the vehicle is ready to pull away.

- ① If you depress the accelerator pedal beyond the setting of the Active Distance Assist DISTRONIC, the system is switched to passive mode. The **suspended** message appears in the multifunction display.

## System limits

The system may be impaired or may not function in the following situations, for example:

- In snow, rain, fog, heavy spray, if there is glare, in direct sunlight or in greatly varying light conditions.
- The windscreen in the area of the camera is dirty, misted up, damaged or covered.
- If the radar sensors are dirty or covered.
- In multi-storey car parks or on roads with steep uphill or downhill gradients.
- If there are narrow vehicles in front, such as bicycles or motorcycles.

In addition, on slippery roads, braking or accelerating can cause one or several wheels to lose traction and the vehicle could then skid.

Do not use Active Distance Assist DISTRONIC in these situations.

**⚠ WARNING** Risk of accident from acceleration or braking by Active Distance Assist DISTRONIC

Active Distance Assist DISTRONIC may accelerate or brake in the following cases, for example:

- If the vehicle pulls away using Active Distance Assist DISTRONIC.
- If the stored speed is called up and is considerably faster or slower than the currently driven speed.
- If Active Distance Assist DISTRONIC no longer detects a vehicle in front or does not react to relevant objects.

- ▶ Always carefully observe the traffic conditions and be ready to brake at all times.
- ▶ Take into account the traffic situation before calling up the stored speed.

**⚠ WARNING** Risk of accident due to insufficient deceleration by Active Distance Assist DISTRONIC

Active Distance Assist DISTRONIC brakes your vehicle with up to 50 % of the maximum possible deceleration. If this deceleration is not sufficient, Active Distance Assist DISTRONIC alerts you with a visual and acoustic warning.

- ▶ In these cases, adjust your speed and keep a sufficient distance.
- ▶ Brake the vehicle yourself and/or take evasive action.

**⚠ WARNING** Risk of accident if detection function of Active Distance Assist DISTRONIC is impaired

Active Distance Assist DISTRONIC does not react or has a limited reaction:

- when driving on a different lane or when changing lanes

- to pedestrians, animals, bicycles or stationary vehicles, or unexpected obstacles
- to complex traffic conditions
- to oncoming vehicles and crossing traffic

As a result, Active Distance Assist DISTRONIC may neither give warnings nor intervene in such situations.

- ▶ Always observe the traffic conditions carefully and react accordingly.

**Operating Active Distance Assist DISTRONIC Requirements:**

- The vehicle has been started.
- The electric parking brake is released.
- ESP® is activated and is not intervening.
- The transmission is in position **D**.
- All the doors are closed.
- Check of the radar sensor system has been successfully completed.
- Parking Assist PARKTRONIC is not being used to park the vehicle or to exit from a parking space.

- The vehicle does not skid.

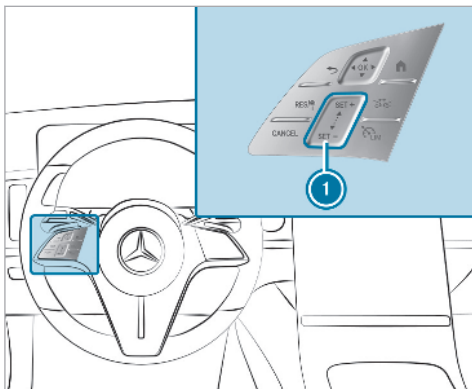

### Switching between Active Distance Assist DISTRONIC and the limiter

- ▶ Press .

### Activating the variable limiter or Active Distance Assist DISTRONIC

- ▶ **To activate without a stored speed:** press the upper section (SET+) or lower section (SET-) of control panel ① or press . **Active Distance Assist DISTRONIC:** remove your foot from the accelerator pedal.

or

- ▶ **To activate with a stored speed:** press . **Active Distance Assist DISTRONIC:** remove your foot from the accelerator pedal. The current driven speed is stored and maintained (Active Distance Assist DISTRONIC) or limited (variable limiter) by the vehicle.

### Adopting the speed limitation shown in the instrument cluster

- ▶ Activate Active Distance Assist DISTRONIC.
- ▶ Press . The speed limit displayed in the instrument cluster is adopted as the stored speed. The vehicle adapts its speed to that of the vehicle in front, but only up to the stored speed.

### Pulling away with Active Distance Assist DISTRONIC

- ▶ Activate Active Distance Assist DISTRONIC and remove your foot from the brake pedal.
- ▶ Press .

or

- ▶ Depress the accelerator pedal briefly and firmly. The functions of Active Distance Assist DISTRONIC continue to be carried out.

### Deactivating Active Distance Assist DISTRONIC

**⚠ WARNING** Risk of accident due to Active Distance Assist DISTRONIC still being activated when you leave the driver's seat

If you leave the driver's seat while the vehicle is being braked by Active Distance Assist DISTRONIC only, the vehicle can roll away.

- ▶ Always deactivate Active Distance Assist DISTRONIC and secure the vehicle to prevent it from rolling away before you leave the driver's seat.

- ▶ Press .

- ⓘ If you brake, deactivate ESP® or if ESP® intervenes, Active Distance Assist DISTRONIC is deactivated.

### Increasing or decreasing the speed

- ▶ To increase the stored speed: swipe upwards from the bottom of control panel ①.
  - The stored speed is increased by 1 km/h.
- ▶ To decrease the stored speed: swipe downwards from the top of control panel ①.
  - The stored speed is decreased by 1 km/h.

or

- ▶ Briefly press the upper section (SET+) or the lower section (SET-) on control panel ①. The stored speed is increased or decreased by 10 km/h.

or

- ▶ Press and hold the upper section (SET+) or the lower section (SET-) on control panel ①. The stored speed is increased or decreased in increments of 10 km/h.

or

- ▶ Accelerate the vehicle to the desired speed.
- ▶ Press the upper section (SET+) on control panel ①.

### Increasing or decreasing the specified distance from the vehicle in front

- ▶ Press . The set specified distance is shown in the assistance graphic.

### Function of Active Speed Limit Assist

If a change in the speed limit is detected and automatic adoption of speed limits is activated, the new speed is automatically adopted as the stored speed (→ page 258).

The driven speed is adjusted when the vehicle is level with the traffic sign at the latest. In the case of signs indicating entry into an urban area, the speed is adapted according to the speed permitted within the urban area. The speed limit display in the Instrument Display is always updated when the vehicle is level with the traffic sign.

If you are driving on German motorways and there is no speed limit, the system uses the

speed stored on an unlimited stretch of road as the recommended speed. If you do not alter the stored speed on an unlimited stretch of road, the recommended speed is 130 km/h.

If Active Distance Assist DISTRONIC has been put into passive mode by pressing the accelerator pedal, only speed limits which are higher than the set speed are adopted.

The maximum permissible speed does not take the road condition and current weather and traffic conditions into account. Adjust your speed accordingly, when necessary.

Observe the notes on driving systems and your responsibility; you may otherwise fail to recognise dangers (→ page 203).

### System limits

The system limits of Traffic Sign Assist apply to the detection of traffic signs (→ page 256).

**⚠ WARNING** Risk of accident due to Active Speed Limit Assist adapting the vehicle's speed

The speed adopted by Active Speed Limit Assist may be too high or incorrect in some individual cases, such as:

- In the wet or in fog
  - When towing a trailer
- ▶ Ensure that the driven speed complies with traffic regulations.
- ▶ Adjust the driving speed to suit current traffic and weather conditions.

### Function of route-based speed adaptation

**i** The following function is country-dependent and only available in conjunction with the Driving Assistance Package.

When Active Distance Assist DISTRONIC is activated, the vehicle speed will be adjusted accordingly to the route events ahead. Depending on the drive program selected, the vehicle negotiates a route event ahead in a fuel-saving, com-

fortable or dynamic manner. When the route event has been passed, the vehicle accelerates again to the stored speed. The set distance to the vehicle in front, vehicles detected ahead and speed restrictions ahead are taken into account.

Route-based speed adaptation can be activated in the multimedia system (→ page 225).

The following route events are taken into account:

- Bends
- Roundabouts and toll stations
- T-junctions
- Turns and exits
- Traffic jams ahead (only with Live Traffic (→ page 355))

**i** When the toll station is reached, Active Distance Assist DISTRONIC adopts the speed as the stored speed.

Also, the speed is reduced if the turn signal indicator to change lanes is switched on and one of the following situations is detected:

- Turning off at junctions

- Driving on slowing-down lanes
- Driving on lanes adjacent to slowing-down lanes

The driver is responsible for choosing the right speed and observing other road users. This applies in particular to junctions, roundabouts and traffic lights, as route-based speed adaptation does not brake the vehicle to a standstill.

If a corresponding route event is detected while route guidance is active, the first speed adjustment is carried out automatically. If the turn signal indicator is switched on, the selected route is confirmed and further speed adjustment is activated.

Speed adjustment is cancelled in the following cases:

- If the turn signal indicator is switched off before the route event and it is therefore assumed that the route event is not relevant to the driver.
- If the driver depresses the accelerator or brake pedal during the process.

### System limits

Route-based speed adaptation does not take right of way rules into account. The driver is responsible for complying with road traffic regulations and driving at a suitable speed.

In difficult conditions (e.g. unclear roads, narrow lanes, wet road surfaces, snow or ice) or when driving with a trailer, the speed adjustment made by the system may not always be suitable. In these situations the driver must intervene accordingly.

**⚠ WARNING** Risk of accident in spite of route-based speed adjustment

Route-based speed adjustment might malfunction or be temporarily unavailable in the following situations:

- If the driver does not follow the calculated route
- If map data is not up to date or available
- In road construction areas
- In bad weather or road conditions

- If the accelerator pedal is depressed
  - In the event of electronically displayed speed limitations
- ▶ Adjust the speed to the traffic situation.

### Setting route-based speed adaptation

#### Requirements:

- Active Distance Assist DISTRONIC is activated.

Multimedia system:

→  →  → Vehicle quick-access

- ▶ Select **Route-based speed adaptation**. When the function is active, the vehicle speed is adjusted depending on the route events ahead.
- ⓘ Further information on the route-based speed adaptation (→ page 224).

### Active Steering Assist

#### Function of Active Steering Assist



- ⓘ The following function is country-dependent and only available in conjunction with the Driving Assistance Package.



Active Steering Assist is only available up to a speed of 210 km/h. The system helps you to stay in the centre of the lane by means of moderate steering interventions. Depending on the speed driven, Active Steering Assist uses the vehicles ahead and lane markings as a reference.

- ⓘ Depending on the country, in the lower speed range Active Steering Assist can use the surrounding traffic as a reference. If necessary, Active Steering Assist can then also provide assistance when driving outside the centre of the lane.

If the detection of lane markings and vehicles ahead is impaired, Active Steering Assist switches to passive mode. The system provides no support in this case.

### Active Steering Assist status display in the multifunction display

-  (grey): activated and passive
-  (green): activated and active
-  (red, flashing): prompt to the driver to actively confirm or transition from active to passive status, system limit detected

**i** During the transition from active to passive status, the  symbol is shown as enlarged and flashing. Once the system is passive, the  symbol is shown as grey in the multifunction display.

### Contact detection

The driver is required to keep their hands on the steering wheel at all times and be able to intervene at any time to correct the course of the vehicle and keep it in lane. The driver must expect a change from active to passive mode or vice versa at any time.



If the driver removes their hands from the steering wheel for a considerable period, display **1** appears first. If the driver still does not steer the vehicle, or gives no confirmation to the system, a warning tone sounds in addition to the visual warning message.

**The warning is not issued or is stopped as soon as the system detects that the driver is holding the steering wheel.**

If Active Steering Assist detects that a system limit has been reached, a visual and acoustic warning is issued.

Observe the notes on driving systems and your responsibility; you may otherwise fail to recognise dangers (→ page 203).

### System limits

Active Steering Assist has a limited steering torque for lateral guidance. In some cases, the steering intervention is not sufficient to keep the vehicle in the lane or to drive through exits.

The system may be impaired or may not function in the following instances:

- There is poor visibility, e.g. due to snow, rain, fog, heavy spray, greatly varying light conditions or strong shadows on the carriageway.
- There is glare, e.g. from oncoming traffic, direct sunlight or reflections.
- Insufficient road illumination.
- The windscreen is dirty, misted up, damaged or covered in the vicinity of the camera, e.g. by a sticker.
- No, or several, unclear lane markings are present for one lane, or the markings change quickly, e.g. in a construction area or junctions.



- The lane markings are worn away, dark or covered up, e.g. by dirt or snow.
- The distance to the vehicle in front is too small and the lane markings thus cannot be detected.
- The road is narrow and winding.
- There are obstacles on the lane or projecting out into the lane, such as object markers.
- When towing a trailer.

The system does not provide assistance in the following conditions:

- On tight bends and when turning.
- When crossing junctions.
- At roundabouts or toll stations.
- When actively changing lane without switching on the turn signal indicator.
- When the tyre pressure is too low.

Depending on the selected vehicle settings, Active Steering Assist may be unavailable. Observe the status display of Active Steering Assist in the multifunction display.

**⚠ WARNING** Risk of accident if Active Steering Assist unexpectedly stops functioning

If the system limits of Active Steering Assist are reached there is no guarantee that the system will remain active or will keep the vehicle in lane.

- ▶ Always keep your hands on the steering wheel and observe the traffic carefully.
- ▶ Always steer the vehicle paying attention to traffic conditions.

**⚠ WARNING** Risk of accident if Active Steering Assist unexpectedly intervenes



A malfunction in the detection of lane markings and objects can occur. This could cause unexpected steering intervention.



- ▶ Steer according to traffic conditions.

**Activating/deactivating Active Steering Assist Requirements:**

- ESP® is activated, but is not intervening.
- Active Distance Assist DISTRONIC is activated.

Multimedia system:

- 



[Vehicle quick-access](#)  
 ▶ Select  [Act. Steering Asst.](#)

### Function of Active Lane Change Assist

- ⓘ The following function is country-dependent and only available in conjunction with the Driving Assistance Package.

Active Lane Change Assist supports the driver when changing lanes by applying steering torque if the driver operates a turn signal indicator.

Assistance when changing lanes is provided if all the following conditions are met:

- You are on a motorway or high-speed major road.
- The neighbouring lane is separated by a broken lane marking.

- No vehicle or obstacle is detected in the adjacent lane.
- The driven speed is between 80 km/h and 180 km/h.
- Active Lane Change Assist is switched on in the multimedia system.
- Active Distance Assist DISTRONIC and Active Steering Assist are switched on and active.
- There is no trailer coupled to the trailer hitch, and no bicycle rack fitted.
- The sensors have detected a vehicle at a suitable distance behind your vehicle (country-dependent).

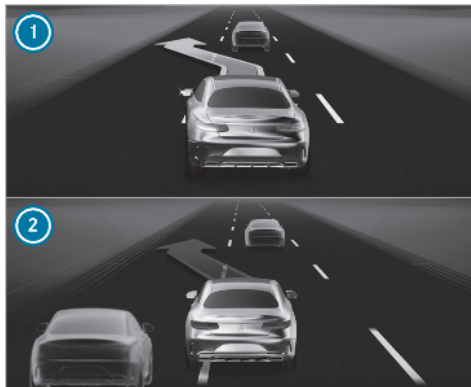

Active Lane Change Assist display in the "Assistance" menu in the multifunction display

- ① Green arrow: lane change initiated
- ② Red arrow: obstacle detected, lane change cancelled

As soon as Active Lane Change Assist is available, the  display appears in the instrument cluster.

If no vehicle or obstacle is detected in the adjacent lane and a lane change is permitted, the lane change begins after the driver has briefly activated the turn signal indicator. This is shown to the driver with a green arrow next to the  steering wheel symbol. Green arrow ① is displayed in the appropriate adjacent lane in context assistance in the multifunction display. The Lane change to the left (placeholder) message also appears, for example.

If a lane change is not possible directly after the driver has activated the turn signal indicator because an obstacle has been detected, for example, the arrow will be shown in grey next to the  steering wheel symbol (country-dependent).

The neighbouring lane will continue to be monitored and, if it becomes free, a lane change will be performed. If the grey arrow is hidden, the lane change must be activated again.

Active Lane Change Assist can be cancelled in the following situations, in particular:

- Conditions change (e.g. detected obstacle).

- The driver removes their hands from the steering wheel.
- The driver steers in the opposite direction or activates the turn signal indicator in the opposite direction.
- When Active Distance Assist DISTRONIC or Active Steering Assist is deactivated.

Cancellation of Active Lane Change Assist can be displayed as follows:

- The arrow in the selected direction of travel turns red.
- An appropriate message appears in the multifunction display.
- A warning tone sounds.

**⚠ WARNING** Risk of accident from changing lane to an occupied adjacent lane

Lane Change Assist cannot always detect clearly if the adjacent lane is free.

The lane change might be initiated although the adjacent lane is not free.

- ▶ Before changing lanes, make sure that the neighbouring lane is free and there is no danger to other road users.
- ▶ Monitor the lane change.

**⚠ WARNING** Risk of accident if Lane Change Assist unexpectedly stops functioning

If the system limitations for Lane Change Assist have been reached, there is no guarantee that the system will remain active.

Lane Change Assist cannot then assist you by applying steering torques.

- ▶ Always monitor the lane change and keep your hands on the steering wheel. Observe the traffic conditions and steer and/or brake if necessary.

### System limits

The system limitations of Active Steering Assist apply to Active Lane Change Assist (→ page 225).

The system may also be impaired or may not function in the following situations:

- The exterior lighting shows a defect.
- The system does not detect a suitable road, for example, in tight bends or shortly after entering a motorway.

**i** The Active Lane Change Assist sensors adjust automatically while a certain distance is being driven after the vehicle has been delivered. Active Lane Change Assist is unavailable or only partially available during the teach-in process; no arrow appears next to the  Active Steering Assist symbol when the turn signal indicator is activated.

Observe the notes on driving systems and your responsibility; you may otherwise fail to recognise dangers (→ page 203).

## Activating/deactivating Active Lane Change Assist

Multimedia system:

 ▶▶ Vehicle quick-access  
 ▶▶ Aktiver Spurwechsel-Assistent (Active Lane Change Assist)

▶ Activate or deactivate the function.

## Function of Active Emergency Stop Assist

Active Emergency Stop Assist uses touch sensors to monitor whether the driver holds the steering wheel and initiates an emergency stop if necessary.

If Active Lane Keeping Assist is deactivated, the accelerator and brake pedal are monitored as well as the steering wheel. A warning is issued when neither the steering wheel is held nor a pedal depressed, and the vehicle is in danger of leaving the lane.



Active Emergency Stop Assist issues the following warnings in order:

- Display ① appears in the multifunction display.
- In addition to display ① a warning tone sounds.
- The **Beginning emergency stop** message appears in the multifunction display, a continuous warning tone sounds, the vehicle no longer accelerates, and there is a slight, repeated tensioning of the seat belt.
- The vehicle speed is reduced in increments until it is at a standstill. Sharp brake impulses are also produced.

Depending on the country, a lane change to the adjacent right-hand lane is carried out, if possible.

① It is only possible to change across one lane and only into the right-hand lane, and not onto the hard shoulder.

Depending on the country, the hazard warning lights are switched on when automatic braking is initiated.

When the vehicle is stationary, the following actions are carried out:

- the vehicle is secured with the electric parking brake
- Active Distance Assist DISTRONIC is ended
- the vehicle is unlocked
- if possible, an emergency call is placed to the Mercedes-Benz emergency call centre

You can cancel the intervention by Active Emergency Stop Assist before automatic braking is initiated by one of the following actions:

- steering
- braking or accelerating

You can cancel the intervention by Active Emergency Stop Assist after automatic braking is initiated by one of the following actions:

- accelerating
- braking: the emergency stop is cancelled, but the warning message, warning tone and power-assisted steering remain active
- steering: power-assisted steering is cancelled, the warning message and warning tone remain active and the vehicle continues to be braked

- ① Active Emergency Stop Assist can initiate an emergency stop a maximum of three times within one ignition cycle.

### System limits

If Active Lane Keeping Assist does not detect lane markings, Active Emergency Stop Assist is not active.

For the detection of vehicles and other obstacles, observe the system limits of the following functions:

- Active Distance Assist DISTRONIC (→ page 219)

- Active Steering Assist (→ page 225)
- Active Lane Change Assist (→ page 227)

### Function of Active Traffic Jam Assist

- ① Active Traffic Jam Assist is country-dependent and only available for vehicles with the Driving Assistance Plus Package.

Active Traffic Jam Assist helps you when in traffic jams on multi-lane roads with separate carriageways by automatically pulling away within up to 60 seconds and with moderate steering manoeuvres. It orients itself using the vehicle in front and lane markings. Active Traffic Jam Assist automatically maintains a safe distance from the vehicle in front and vehicles cutting in.

Active Traffic Jam Assist requires you, as the driver, to keep your hands on the steering wheel at all times so that you are able to intervene at any time to correct the course of the vehicle and keep it in lane.

Observe the notes on driving systems and your responsibility; you may otherwise fail to recognise dangers (→ page 203).

Active Traffic Jam Assist activates automatically when all of the following conditions are met:

- You are in a traffic jam on a motorway or high-speed major road.
- Active Distance Assist DISTRONIC is switched on and active (→ page 221).
- Active Brake Assist is available (→ page 208).
- Active Steering Assist is switched on and active (→ page 227).
- You are travelling no faster than 60 km/h.

The following symbol is displayed in the instrument cluster when the system is active:



### System limits

The system limitations of Active Distance Assist DISTRONIC and Active Steering Assist apply to Active Traffic Jam Assist (→ page 225).

## Activating/deactivating Active Traffic Jam Assist

Multimedia system:

 Vehicle quick-access



## Function of Hill Start Assist

Hill Start Assist holds the vehicle for a short time when pulling away on a hill under the following conditions:

- The transmission is in position **D** or **R**.
- The electric parking brake is released.

This gives you enough time to move your foot from the brake pedal to the accelerator pedal and depress it before the vehicle begins to roll away.

**⚠ WARNING** Risk of accident and injury due to the vehicle rolling away

After a short time, Hill Start Assist no longer holds the vehicle.

▶ Swiftly move your foot from the brake pedal to the accelerator pedal. Do not leave the vehicle when it is being held by Hill Start Assist.

## HOLD function

### HOLD function

The HOLD function holds the vehicle at a standstill without requiring you to depress the brake pedal, e.g. while waiting in traffic.

The HOLD function is only an aid. The responsibility for the vehicle safely standing still remains with the driver.

### System limits

The HOLD function is only intended to provide assistance when driving and is not a sufficient means of safeguarding the vehicle against rolling away when stationary.

- The incline must not be greater than 30%.

## Activating/deactivating the HOLD function

**⚠ WARNING** Risk of an accident due to the HOLD function being activated when you leave the vehicle

If the vehicle is only braked with the HOLD function it could, in the following situations, roll away:

- If there is a malfunction in the system or in the power supply.
- If the HOLD function is deactivated by depressing the accelerator pedal or brake pedal, e.g. by a vehicle occupant.

▶ Always secure the vehicle against rolling away before you leave it.

### Requirements:

- The vehicle is stationary.
- The driver's door is closed or the seat belt on the driver's side is fastened.

- The engine is running or has been automatically switched off by the ECO start/stop function.
- The electric parking brake is released.
- Active Distance Assist DISTRONIC is deactivated.
- The transmission is in position **D**, **R** or **N**.

### Activating the HOLD function

- ▶ Depress the brake pedal, and after a short time quickly depress further until the **HOLD** display appears in the driver's display.
- ▶ Release the brake pedal.

### Deactivating the HOLD function

- ▶ Depress the accelerator pedal to pull away.  
or
- ▶ Depress the brake pedal until the **HOLD** display disappears from the driver's display.

The HOLD function is deactivated in the following situations:

- Active Distance Assist DISTRONIC is activated.

- The transmission is shifted to position **P**.
- The vehicle is secured with the electric parking brake.

In the following situations, the vehicle is held by transmission position **P** and/or by the electric parking brake:

- The seat belt is unfastened and the driver's door is opened.
- The vehicle is switched off.
- There is a malfunction in the system or the power supply is insufficient.

In addition, the **Brake immediately** message may appear in the driver's display and a horn tone may sound at regular intervals.

- ▶ Immediately depress the brake pedal firmly until the warning message disappears. The HOLD function is deactivated.
- ▶ Additionally secure the vehicle against rolling away.

## AIRMATIC





### Function of AIRMATIC

AIRMATIC is an air suspension system with variable damping for improved driving comfort. The all-round level control system ensures the best possible suspension and constant ground clearance, even with a laden vehicle. When driving at speed, the vehicle is lowered automatically to improve driving safety and to reduce fuel consumption. You also have the option of manually adjusting the vehicle level.

AIRMATIC includes the following components and functions:

- air suspension with automatic all-round level control
- speed-dependent lowering to reduce fuel consumption
- raised vehicle level setting manually selectable via the multimedia system for greater ground clearance
- ADS PLUS (Adaptive Damping System with constant damping force adjustment)

## Available suspension settings

Drive program	Characteristics
<ul style="list-style-type: none"> <li> (Sport)</li> <li> (Sport +)</li> </ul>	<ul style="list-style-type: none"> <li>• The suspension setting is firmer.</li> <li>• The vehicle is set to low level -1.</li> <li>• The vehicle is lowered to low level -2 when driving at speeds above 120 km/h.</li> <li>• When driving at speeds below 80 km/h, the vehicle is raised again to low level -1.</li> </ul>
<ul style="list-style-type: none"> <li> (Comfort)</li> <li> (Economy)</li> </ul>	<ul style="list-style-type: none"> <li>• The suspension setting is comfortable.</li> <li>• The vehicle is set to the normal level.</li> <li>• The vehicle is lowered to low level -1 when driving at speeds above 120 km/h.</li> <li>• The vehicle is lowered to low level -2 when driving at speeds above 160 km/h.</li> <li>• When driving at speeds below 120 km/h, the vehicle is raised again to low level -1.</li> <li>• When driving at speeds below 80 km/h, the vehicle is raised again to the normal level.</li> </ul>

 **Operation with a trailer or bicycle rack:** if the electrical connection has been correctly established, the vehicle remains at normal level irrespective of speed or the drive program selected.

## Setting the vehicle level

 **WARNING** Risk of accident because vehicle level is too high

Driving characteristics may be impaired.

The vehicle can drift outwards, for example, when steering or cornering.

 Choose a vehicle level which is suited to the driving style and the road surface conditions.



**⚠ WARNING** Risk of entrapment from vehicle lowering

When lowering the vehicle, other people could become trapped if their limbs are between the vehicle body and the tyres or underneath the vehicle.

- ▶ Make sure no one is underneath the vehicle or in the immediate vicinity of the wheel arches when the vehicle is being lowered.

**⚠ WARNING** Risk of becoming trapped due to the vehicle lowering

**Vehicles with AIRMATIC or level control:** when you unload luggage or leave the vehicle, the vehicle first rises slightly and then returns to the set level shortly afterwards.

You or anyone else in the vicinity of the wheel arches or the underbody could thus become trapped.

The vehicle can also be lowered after being locked.

- ▶ When leaving the vehicle, make sure that nobody is in the vicinity of the wheel arches or the underbody.

**! NOTE** Damage due to vehicle lowering

Parts of the body could be damaged when the vehicle is lowered.

- ▶ Make sure that there are no obstacles such as kerbs underneath or in the immediate vicinity of the body when the vehicle is being lowered.

**Requirements:**

- The vehicle has been started.
- The vehicle is not moving faster than 60 km/h.
- When the trailer socket is contacted (trailer/bicycle rack): the vehicle is not moving faster than 30 km/h.

Multimedia system:



**Raising the vehicle**

- ▶ Select **Vehicle level**.

The indicator lamp lights up continuously.

The vehicle is raised to off-road level +1.

Your selection is saved. The off-road level +1 set remains stored even after the ignition has been switched off.

The vehicle is lowered again in the following situations:

- When driving faster than 80 km/h.
- When driving briefly between 60 km/h and 80 km/h.
- After selecting a different drive program using the DYNAMIC SELECT switch.  
In this case, the vehicle is adjusted to the height of the active drive program.
- When the trailer socket is contacted (trailer/bicycle rack): the vehicle is moving faster than 30 km/h.

### Lowering the vehicle

▶ Select **Vehicle level**.

The indicator lamp goes out when the lowering process is complete.

The vehicle is adjusted to the height of the active drive program.

ⓘ In the Sport drive program, only the normal vehicle level is possible when the trailer socket is contacted (trailer/bicycle rack).

### E-ACTIVE BODY CONTROL

#### Function of E-ACTIVE BODY CONTROL

E-ACTIVE BODY CONTROL is an electrohydraulic suspension system with variable damping for improved driving comfort. The all-round level control system ensures the best possible sus-

pension and constant ground clearance, even with a laden vehicle. When driving at speed, the vehicle is lowered automatically to improve driving safety and to reduce fuel consumption. The suspension setting is adjusted depending on the road surface, vehicle load and the drive program selected.

The ROAD SURFACE SCAN function detects areas of unevenness in the road before you drive over them by means of a multifunction camera. This reduces chassis movements.

The damping is adjusted individually to each wheel and depends on the following factors:

- Driving style, e.g. sporty
- Road condition, e.g. bumps
- Drive program

E-ACTIVE BODY CONTROL is comprised of the following functions and components:

- ROAD SURFACE SCAN
- Curve inclination function CURVE
- Air suspension with automatic level control
- Speed-dependent lowering to reduce fuel consumption
- ADS PLUS (Adaptive Damping System with constant adjustment of damping characteristics)
- DYNAMIC SELECT button for selecting a drive program (→ page 184)
- Manual level adjustment via the multimedia system

## Characteristics per drive program

Drive program	Suspension settings and vehicle level
<ul style="list-style-type: none"> <li><b>S</b> (Sport)</li> <li><b>S+</b> (Sport +)</li> </ul>	<ul style="list-style-type: none"> <li>• The suspension setting is firmer.</li> <li>• The vehicle is set to low level -1.</li> <li>• The vehicle is lowered to low level -2 when driving at speeds above 120 km/h.</li> <li>• When driving at speeds below 80 km/h, the vehicle is raised again to low level -1.</li> <li>• ROAD SURFACE SCAN is deactivated.</li> <li>• <b>S</b>: the curve inclination function is deactivated.</li> <li>• <b>S+</b>: The curve inclination function is active.</li> </ul>
<ul style="list-style-type: none"> <li><b>C</b> (Comfort)</li> <li><b>CV</b> (CURVE)</li> <li><b>E</b> (Economy)</li> </ul>	<ul style="list-style-type: none"> <li>• The suspension setting is comfortable.</li> <li>• The vehicle is set to the normal level.</li> <li>• The vehicle is lowered to low level -1 when driving at speeds above 120 km/h.</li> <li>• The vehicle is lowered to low level -2 when driving at speeds above 160 km/h.</li> <li>• When driving at speeds below 120 km/h, the vehicle is raised again to low level -1.</li> <li>• When driving at speeds below 80 km/h, the vehicle is raised again to the normal level.</li> <li>• <b>C</b> and <b>CV</b>: ROAD SURFACE SCAN is active.</li> <li>• <b>CV</b>: The curve inclination function is active.</li> </ul>

- ❗ **Operation with a trailer or bicycle rack:** if the electrical connection has been correctly established, the vehicle remains at normal level irrespective of speed or the drive program selected.

### Function of ROAD SURFACE SCAN

- ❗ This function is not available in all countries.

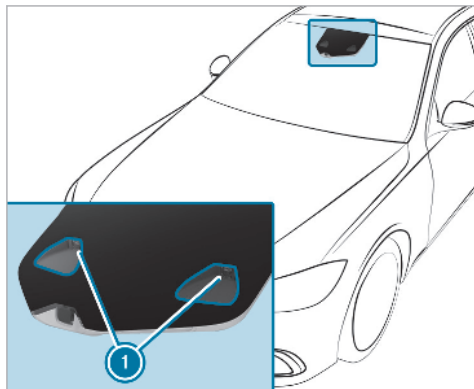

The ROAD SURFACE SCAN function monitors the road in front of your vehicle using multifunction camera ①. ROAD SURFACE SCAN detects unevenness in the road surface, e.g. bumps, before the vehicle drives over them. Chassis movements are reduced and driving comfort is increased.

ROAD SURFACE SCAN is automatically activated if the following conditions are met:

- Drive program **C** (Comfort) or **CV** (CURVE) is selected.
- The vehicle is set to the normal level.
- You are driving at a speed between 7 km/h and 180 km/h.

### System limits

ROAD SURFACE SCAN can be impaired in the following situations or can stop functioning:

- If the carriageway is insufficiently lit, e.g. at night.
- In snow, rain, fog, heavy spray, if there is glare, in direct sunlight or in greatly varying light conditions.

- If the windscreen in the area of multifunction camera ① is dirty, misted up, damaged or covered.
- If the road surface has no optic structure or reflects light.
- If you are driving too close to the vehicle in front.
- If sections of the route have a very small radius of curvature.
- During abrupt driving manoeuvres, e.g. heavy braking or sudden acceleration.

Observe the notes on cleaning the multifunction camera (→ page 465).

## Parking Assist PARKTRONIC

### Function of Parking Assist PARKTRONIC

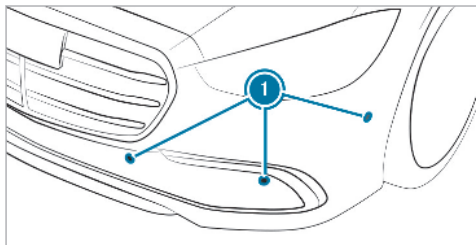

Parking Assist PARKTRONIC is an electronic parking assistance system with ultrasound. It monitors the area around your vehicle using sensors ① on the front bumper and on the rear bumper. Parking Assist PARKTRONIC shows you the distance between your vehicle and a detected obstacle visually and audibly.

In the standard setting, an intermittent warning tone sounds from a distance of approximately 0.3 m to an obstacle in front and approximately 1.0 m to an obstacle behind. A continuous warning tone sounds from a distance of approx-

imately 0.2 m. Using the **Warn early all-round** (placeholder) setting in the multimedia system, the warning tones for front and side impact protection can be set to sound at a greater distance of approximately 1.0 m in front and 0.6 m on the sides (→ page 241).

① The **Warn early all-round** (placeholder) setting is always active in the rear of the vehicle.

If Parking Assist PARKTRONIC is deactivated, Active Parking Assist is unavailable.

**Observe the notes on driving systems and your responsibility; you may otherwise fail to recognise dangers (→ page 203).**

### Parking Assist PARKTRONIC display in the multimedia system

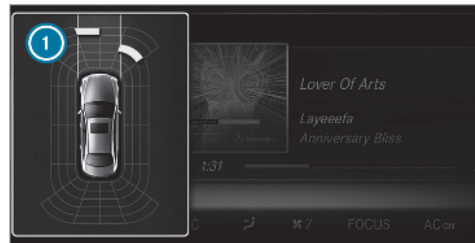

Placeholder

Vehicles with Active Parking Assist without a 360° Camera



Placeholder

Vehicles with Active Parking Assist and a 360° Camera

If Active Parking Assist is deactivated and an obstacle is detected in the path of the vehicle, a pop-up window for Parking Assist PARKTRONIC ① appears in the multimedia system at speeds below 10 km/h.

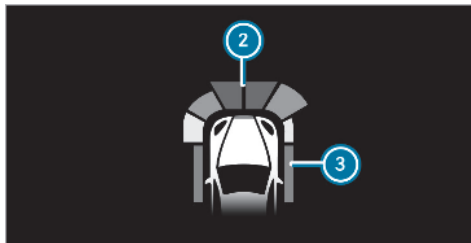

Placeholder

Display of Active Parking Assist PARKTRONIC in the head-up display

Optionally, obstacles detected by Active Parking Assist PARKTRONIC from a distance of approximately 1.0 m in front ① and 0.6 m on the sides ② can also be displayed in the head-up display.

### System limits

Parking Assist PARKTRONIC does not necessarily take into account the following obstacles:

- Obstacles below the detection range, e.g. persons, animals or objects.

- Obstacles above the detection range, e.g. overhanging loads, overhangs or loading ramps of lorries.

The sensors must be free of dirt, ice and slush. Otherwise, they may not function correctly. Clean the sensors regularly, taking care not to scratch or damage them.

**Vehicles with trailer hitch:** Parking Assist PARKTRONIC is deactivated for the rear zone when you establish an electrical connection between your vehicle and a trailer.

### Activating/deactivating Parking Assist PARKTRONIC

**!** **NOTE** Risk of an accident from objects at close range

Parking Assist PARKTRONIC may not detect certain objects at close range.

▶ When parking or manoeuvring the vehicle, pay particular attention to any objects which are above or below the sensors, e.g. flowerpots or drawbars.

The vehicle or other objects could otherwise be damaged.

If the  symbol is shown in the multifunction display, Parking Assist PARKTRONIC is not active.

Multimedia system:

   Vehicle quick-access

▶ Select **PARKTRONIC**.

 Parking Assist PARKTRONIC is automatically activated when the engine is started.

### Adjusting the warning tones of Parking Assist PARKTRONIC

Multimedia system:

  Settings  Assistance

 Camera & parking

### Adjusting the volume of the warning tones

▶ Set the desired level under **Warning tone volume**.

### Adjusting the pitch of the warning tones

▶ Set the desired level under **Warning tone pitch**.

## Reversing camera

### Function of the reversing camera

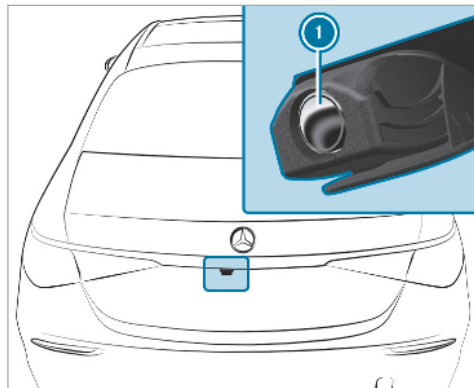

If you have activated the function in the multimedia system, the image from reversing camera 

is shown in the media display when the reverse gear is engaged. Dynamic guide lines show the path the vehicle will take with the steering wheel in its current position. This helps you to orient yourself and to avoid obstacles when reversing.

Observe the notes on driving systems and your responsibility; you may otherwise fail to recognise dangers (→ page 203).

Depending on the vehicle equipment, you can select from the following views:

- Normal view
- Wide-angle view
- Trailer view

The area behind the vehicle is displayed as a mirror image, as in the inside rearview mirror.

### Vehicles without Active Parking Assist

The following camera views are available in the multimedia system:

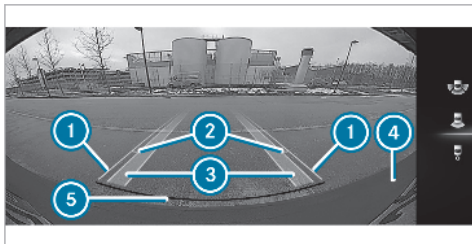

Normal view

- ① Yellow guide line, vehicle width (driven surface) depending on the current steering wheel angle (dynamic)
- ② Yellow guide line at a distance of approximately 1.0 m from the rear area
- ③ Yellow lane marking the course the tyres will take at the current steering wheel angle (dynamic)
- ④ Bumper
- ⑤ Red guide line at a distance of approximately 0.3 m from the rear area

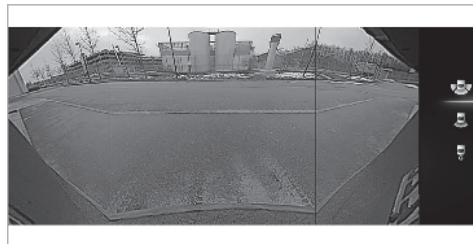

Wide-angle view

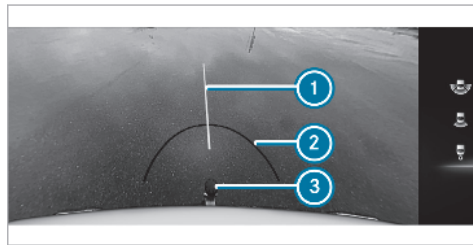

Trailer view (vehicles with a trailer hitch)

- ① Yellow guide line, locating aid

- ② Red guide line at a distance of approximately 0.3 m from the ball head of the trailer hitch
- ③ Ball head of the trailer hitch

### Vehicles with Active Parking Assist

The following camera views are available in the multimedia system:

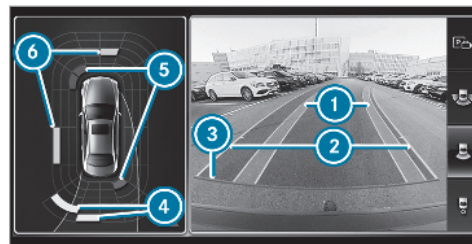

Normal view

- ① Yellow lane marking the course the tyres will take at the current steering wheel angle (dynamic)
- ② Yellow guide line, vehicle width (driven surface) depending on the current steering wheel angle (dynamic)



- ③ Red guide line at a distance of approximately 0.3 m from the rear area
  - ④ Yellow warning indicator of Parking Assist PARKTRONIC: obstacles at a distance between approximately 0.6 m and 1.0 m
  - ⑤ Red warning display of Parking Assist PARKTRONIC: obstacles are very close (approximately 0.3 m or less)
  - ⑥ Orange warning display of Parking Assist PARKTRONIC: obstacles are a medium distance away (between approximately 0.3 m and 0.6 m)
- ① If the entire system fails, the internal segments of the warning display are shown in red and the  symbol appears in the multifunction display in the instrument cluster. If the system fails at the rear, the rear segments are shown in red when reversing and are hidden when driving forwards. When Active Parking Assist is active, lane markings ① are displayed in green. If Parking Assist PARKTRONIC is deactivated, the warning display fades out.



Wide-angle view

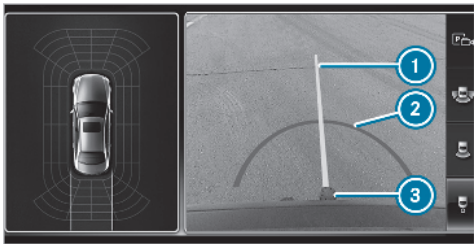

Trailer view (vehicles with a trailer hitch)

- ① Yellow guide line, locating aid

- ② Red guide line at a distance of approximately 0.3 m from the ball head of the trailer hitch
- ③ Ball head of the trailer hitch

### System failure



If the vehicle is not operationally ready, a message appears in the multimedia system.

### System limits

The reversing camera will not function or will only partially function in the following situations:

- The boot lid is open.
- There is heavy rain, snow or fog.
- The light conditions are poor, e.g. at night.

- The camera lens is obstructed, dirty or misted up. Observe the notes on cleaning the reversing camera (→ page 465).
- The camera or rear of your vehicle is damaged. In this case, have the camera and its position and setting checked at a qualified specialist workshop.

**i** Do not use the reversing camera in these types of situation. You could otherwise injure others or collide with objects when parking the vehicle.

The field of vision and other functions of the reversing camera may be restricted due to additional accessories on the rear of the vehicle (e.g. licence plate bracket or bicycle rack).

- i** The contrast of the display may be impaired by direct sunlight or by other light sources, e.g. when driving out of a garage. In this case, pay particular attention.
- i** Have the display repaired or replaced if, for example, pixel errors considerably restrict its use.

### 360° Camera

#### Function of the 360° Camera

The 360° Camera is a system that consists of four cameras. The cameras cover the immediate vehicle surroundings. The system assists you, e.g. when parking or at exits with reduced visibility.

Observe the notes on driving systems and your responsibility; you may otherwise fail to recognise dangers (→ page 203).

The system evaluates images from the following cameras:

- Reversing camera
- Front camera
- Two side cameras in the outside mirrors

#### Views of the 360° Camera

You can select from different views:

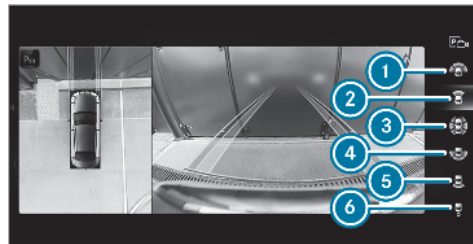

- ① Wide-angle view, front
- ② Top view with image from the front camera
- ③ Top view with images from the side cameras in the outside mirrors
- ④ Wide-angle view, rear
- ⑤ Top view with image from the reversing camera
- ⑥ Top view with trailer view (vehicles with a trailer hitch)

## Top view



- ① Lane indicating the route the vehicle will take at the current steering wheel angle
- ② Yellow warning display of Parking Assist PARKTRONIC: obstacles at a distance of approximately 1.0 m or less
- ③ Your vehicle from above

If the distance to the object is reduced, the colour of warning display ② changes:

- From approx. 1.0 m: yellow
- From approx. 0.6 m: orange
- From approx. 0.3 m: red

When Parking Assist PARKTRONIC is operational and no object is detected, the segments of the warning display are shown in grey.

- ① If the entire system fails, the segments of the warning display are shown in red and the  symbol appears in the multifunction display in the instrument cluster.

If the system fails at the rear, the display of the segments changes as follows:

- The rear segments are shown in red when reversing.
- The rear segments are hidden when driving forwards.

If Parking Assist PARKTRONIC is deactivated, the warning display fades out.

## Guide lines

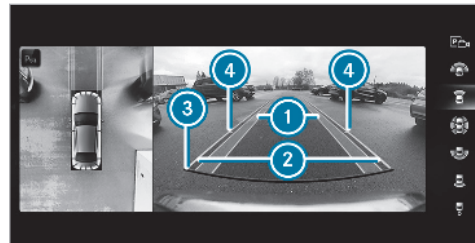

- ① Yellow lane marking the course the tyres will take at the current steering wheel angle (dynamic)
  - ② Yellow guide line, vehicle width (driven surface) depending on the current steering wheel angle (dynamic)
  - ③ Red guide line at a distance of approximately 0.3 m from the rear area
  - ④ Mark at a distance of approx. 1.0 m
- ① When Active Parking Assist is active, lane markings ① are displayed in green.

The guide lines in the media display show the distances to your vehicle. The distances apply to road level. In trailer mode, the guide lines are shown at the level of the trailer hitch.

### Trailer view (vehicles with a trailer hitch)

If you select trailer view and no trailer is coupled to the vehicle, the following display appears:

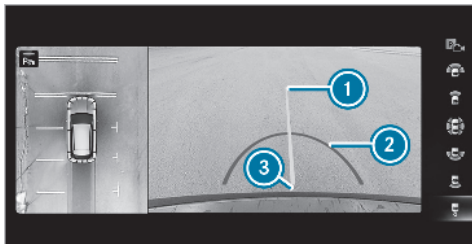

- ① Yellow guide line, locating aid
- ② Red guide line at a distance of approximately 0.3 m from the ball head of the trailer hitch
- ③ Ball head of the trailer hitch



When the electrical connection is established between the vehicle and the trailer, the display changes to the side camera view.

This view supports manoeuvring procedures with a trailer.

### Side view of the mirror cameras

The sides of the vehicle can be seen in this view.

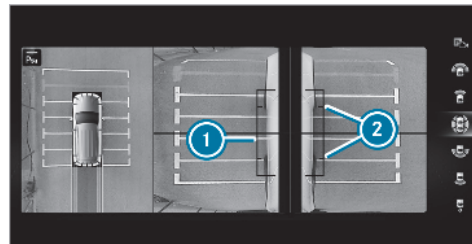

- ① Guide line of external vehicle dimensions with outside mirrors folded out
- ② Marker of the wheel contact points

### System failure

If the vehicle is not operationally ready, the following message appears in the multimedia system:

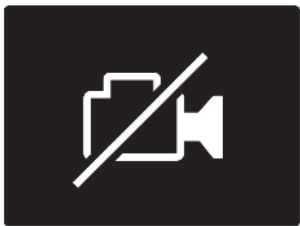

### System limits

The 360° Camera will not function or will only partially function in the following situations:

- The doors are open.
- The side mirrors are folded in.
- The boot lid is open.
- There is heavy rain, snow or fog.
- The light conditions are poor, e.g. at night.
- The camera lens is obstructed, dirty or misted up.
- If cameras or vehicle components in which the cameras are fitted are damaged. In this event, have the cameras, their positions and

their setting checked at a qualified specialist workshop.

- ⓘ Do not use the 360° Camera under such circumstances. You could otherwise injure others or collide with objects when parking the vehicle.

For technical reasons, the standard height of the vehicle may be altered if the vehicle is carrying a heavy load and can result in inaccuracies in the guide lines and in the display of the generated images.

The field of vision and other functions of the camera system may be restricted due to additional attachments on the vehicle (e.g. licence plate bracket, bicycle rack).

- ⓘ The contrast of the display may be impaired by abrupt direct sunlight or by other light sources, e.g. when driving out of a garage. In this case, pay particular attention.
- ⓘ Have the display repaired or replaced if, for example, pixel errors considerably restrict its use.

See the notes on cleaning the 360° Camera (→ page 465).

### Active Parking Assist

#### Function of Active Parking Assist

Active Parking Assist is an electronic parking assistance system which uses ultrasound and is automatically activated during forward travel. The system is operational at speeds below approximately 35 km/h.

If all requirements are met, the  display appears in the multifunction display. The system then independently locates and measures parallel and perpendicular parking spaces on both sides of the vehicle.

When Active Parking Assist detects parking spaces, the  display appears in the multifunction display. The arrows show on which side of the road detected parking spaces are located. They are then shown in the media display. The parking space and, if necessary, the parking direction can be selected as desired. Active Parking Assist calculates a suitable vehicle path, switches on the turn signal indicator and assists you in parking and exiting the parking space.

Active Parking Assist provides assistance when changing gear, accelerating, braking and steering the vehicle.

Observe the notes on driving systems and your responsibility; you may otherwise fail to recognise dangers (→ page 203).

Active Parking Assist is cancelled if, among other things, one of the following actions is carried out:

- Parking Assist PARKTRONIC is deactivated.
- Active Parking Assist is deactivated.
- You begin steering.
- You apply the parking brake.
- You engage transmission position **P**.
- ESP<sup>®</sup> intervenes.
- You open the doors or the boot lid while driving.

### System limits

Objects located above or below the detection range of Active Parking Assist are not detected when the parking space is being measured. These are also not taken into account when the

parking manoeuvre is calculated, e.g. overhanging loads, overhangs or loading ramps of lorries, or the boundaries of parking spaces. In some circumstances, Active Parking Assist may therefore guide you into the parking space prematurely.

**⚠ WARNING** Risk of accident due to objects located above or below the detection range of Active Parking Assist

If there are objects above or below the detection range, the following situations may arise:

- Active Parking Assist may steer too early.
- **Vehicles with automatic transmission:** The vehicle may not stop in front of these objects.

This could cause a collision.

▶ In these situations, do not use Active Parking Assist.

Snowfall or heavy rain may lead to a parking space being measured inaccurately. Parking spaces that are partially occupied by trailer drawbars might not be identified as such or be

measured incorrectly. Only use Active Parking Assist on level, high-grip ground.

Do not use Active Parking Assist in the following situations:

- In extreme weather conditions such as ice, packed snow or in heavy rain.
- When transporting a load that protrudes beyond the vehicle.
- If the parking space is on a steep downhill or uphill gradient.
- When snow chains are fitted.

Active Parking Assist may also display parking spaces which are unsuitable for parking, for example, the following:

- Parking spaces where parking is prohibited.
- Parking spaces on unsuitable surfaces.

Active Parking Assist will not assist you with parking spaces at right angles to the direction of travel in the following situations:

- If two parking spaces are located immediately next to each other.

- If the parking space is immediately next to a low obstacle such as a kerb.

Active Parking Assist will not assist you with parking spaces parallel or at right angles to the direction of travel in the following situations:

- If the parking space is on a kerb.
- If the parking space is bordered by an obstacle, e.g. a tree, a post or a trailer.

### Parking with Active Parking Assist

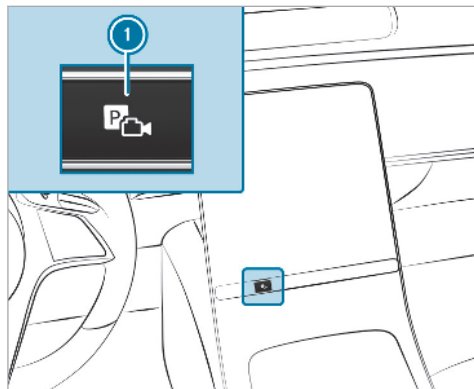

▶ Press button ①.

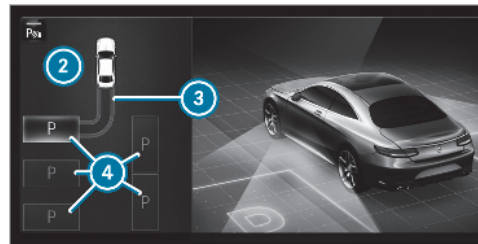

The media display shows the view of Active Parking Assist. Area ② displays detected parking spaces ④ and vehicle path ③.

ⓘ Vehicle path ③ shown on the media display may differ from the actual vehicle path.

- ▶ If you have driven past a parking space: bring the vehicle to a standstill.
- ▶ Select desired parking space ④.
- ▶ Where necessary, select the parking direction: forwards or reverse. Vehicle path ③ is shown, depending on selected parking space ④ and the parking direction.

▶ Confirm selected parking space ④.

① The turn signal indicator is switched on automatically when the parking procedure begins. The turn signal indicator is switched off automatically when you switch to **D**.

You are responsible for selecting the turn signal indicator in accordance with the traffic conditions. If necessary, select the turn signal indicator accordingly.

**⚠ WARNING** Risk of accident due to vehicle swinging out while parking or pulling out of a parking space

While parking or exiting a parking space, the vehicle swings out and can drive onto areas of the oncoming lane.

This could cause you to collide with objects or other road users.

▶ Pay attention to objects and other road users.

▶ Where necessary, stop the vehicle or cancel the parking procedure with Active Parking Assist.

▶ If, for example, the **Please engage reverse gear** (placeholder) message appears in the media display: select the corresponding transmission position. The vehicle drives into the selected parking space.

On completion of the parking procedure, the **Parking Assist finished, take control of vehicle** (placeholder) display message appears. Further manoeuvring may still be necessary.

▶ After completion of the parking procedure, safeguard the vehicle against rolling away. When required by legal requirements or local conditions: turn the wheels towards the kerb.

① You can stop the vehicle and change the transmission position during the parking procedure. The system then calculates a new vehicle path. The parking procedure can then be continued. If no new vehicle path is available, the transmission position will be changed again. If the vehicle has not yet reached the parking space, the parking procedure will be cancelled, should a gear be changed.

## Exiting a parking space with Active Parking Assist

### Requirements:

- The vehicle has been parked with Active Parking Assist.

Please note that you are responsible for the vehicle and surroundings during the entire parking procedure.

▶ Start the vehicle.



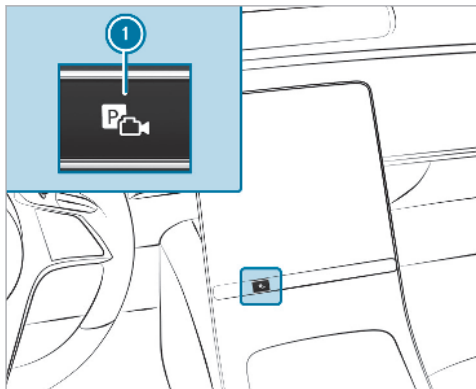

- ▶ Press button ①.  
The media display shows the view of Active Parking Assist.

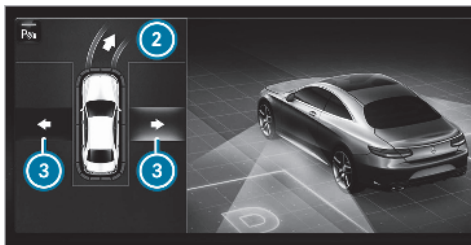

- ▶ If the vehicle has been parked at right angles to the direction of travel: in area ②, select direction of travel ③.

① The vehicle path shown on the media display may differ from the actual vehicle path.

- ▶ Confirm direction of exit ③ to drive out of the parking space.

① The turn signal indicator is switched on automatically when the exiting procedure begins.

You are responsible for selecting the turn signal indicator in accordance with the traffic conditions. If necessary, select the turn signal indicator accordingly.

**⚠ WARNING** Risk of accident due to vehicle swinging out while parking or pulling out of a parking space

While parking or exiting a parking space, the vehicle swings out and can drive onto areas of the oncoming lane.

This could cause you to collide with objects or other road users.

- ▶ Pay attention to objects and other road users.
- ▶ Where necessary, stop the vehicle or cancel the parking procedure with Active Parking Assist.

- ▶ If, for example, the **Please engage forward gear** (placeholder) message appears in the media display: select the corresponding transmission position.  
The vehicle moves out of the parking space. The turn signal indicator is switched off automatically.

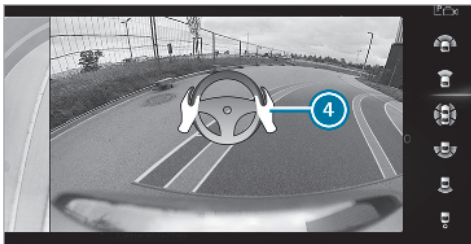

The image shows an example of a vehicle with a 360° Camera.

After the exiting procedure has been completed, the **Parking Assist finished, take control of vehicle** (placeholder) message appears in the media display. A warning tone and display ④ in the media display prompt you to take control of the vehicle. You have to accelerate, brake, steer and change gear yourself again.

### Function of Drive Away Assist

Drive Away Assist can reduce the severity of an impact when pulling away. If an obstacle is detected in the direction of travel, the vehicle's speed is briefly reduced to approx. 2 km/h. If a

critical situation is detected, the following symbol appears in the media display:



**⚠ WARNING** Risk of accident caused by limited detection performance of Drive Away Assist

Drive Away Assist cannot always clearly identify objects and traffic situations.

In such cases, Drive Away Assist might:

- Warn you without reason and limit the vehicle speed.
- Not warn you or not limit the vehicle speed.
- ▶ Always pay careful attention to the traffic situation; do not rely on Drive Away Assist alone.
- ▶ Be prepared to brake or swerve as necessary, provided the traffic situation

permits and that it is safe to take evasive action.

Observe the notes on driving systems and your responsibility; you may otherwise fail to recognise dangers (→ page 203).

A risk of a collision may arise in the following situations, for example:

- If the driver mixes up the accelerator and brake pedals.
- If the wrong gear is selected.

Drive Away Assist is active under the following conditions:

- If Parking Assist PARKTRONIC is activated.
- Every time the gear is changed to **R** or **D** when the vehicle is at a standstill.
- If the detected obstacle is less than approx. 1.0 m away.
- If the manoeuvring assistant function is activated in the multimedia system.

### System limits

The performance of Drive Away Assist is limited on inclines.

When driving with a trailer, Drive Away Assist is not available.

### Function of Cross Traffic Alert

- ① Also read the instructions on Blind Spot Assist (→ page 260).



**Vehicles with Blind Spot Assist:** Cross Traffic Alert can warn drivers of any crossing traffic when reversing out of a parking space. The radar sensors in the bumper also monitor the area adjacent to the vehicle. If a critical situation is

detected, symbol ① appears in the media display. If the driver does not respond to the warning, the vehicle's brakes can be applied automatically.

If the radar sensors are obstructed by vehicles or other objects, detection is not possible.

Cross Traffic Alert is active under the following conditions:

- If Blind Spot Assist is activated.
- If the vehicle is reversing at walking pace.
- If the manoeuvring assistant function is activated in the multimedia system.

### System limits

Cross Traffic Alert is not available in the following situations.

- on inclines
- when towing a trailer

## ATTENTION ASSIST

### Function of ATTENTION ASSIST with microsleep detection

ATTENTION ASSIST with microsleep detection assists you on long, monotonous journeys, e.g. on motorways and trunk roads. If indicators of fatigue or increasing lapses in concentration on the part of the driver are detected, the system suggests taking a break.

ATTENTION ASSIST with microsleep detection is only an aid. It cannot always detect fatigue or lapses in concentration in time. The system is not a substitute for a well-rested and attentive driver. On long journeys, take regular breaks in good time that allow for adequate recuperation.

You can choose between two settings:

- **Standard:** normal system sensitivity.
- **Sensitive:** increased system sensitivity: the driver is warned earlier and the attention level detected by the system is adapted accordingly.

If drowsiness or increasing lapses in concentration are detected, the [ATTENTION ASSIST: Take](#)

a **break!** warning appears in the multifunction display. You can acknowledge the message and take a break where necessary. If you do not take a break and ATTENTION ASSIST continues to detect increasing lapses in concentration, you will be warned again after a minimum of 15 minutes.



The following information is shown in the ATTENTION ASSIST display:

- The length of the journey since the last break.
- The attention level determined by ATTENTION ASSIST:

- The more segments ② of the circle displayed, the higher the detected attention level.
- Fewer segments ② are displayed in the circle as the attention level decreases.
- Microsleep detection ① status:
  - Deactivated: display ① is hidden.
  - Activated but not operational: display ① is grey.
  - Activated and operational: display ① is green.

If ATTENTION ASSIST is unable to calculate the attention level and cannot issue a warning, the **System suspended** message appears.

If the system, which uses the driver camera, detects indicators of microsleep, the **ATTENTION ASSIST Microsleep Take a break!** warning message appears in the multifunction display and a warning tone sounds simultaneously. This warning message must be confirmed by Touch Control. It is recommended that you take a break immediately.

If a warning appears in the multifunction display, the multimedia system offers to search for a rest area. You can select a rest area and start navigation to this rest area. This function can be activated and deactivated in the multimedia system.

ATTENTION ASSIST with microsleep detection is activated automatically when the engine is restarted. The last selected sensitivity level remains stored.

### System limits

ATTENTION ASSIST is active in the 60 km/h to 200 km/h speed range.

The microsleep detection function is available at a speed of 20 km/h and above.

The functionality of ATTENTION ASSIST is restricted, and warnings may be delayed or not occur at all in the following situations:

- If you have been driving for less than approximately 30 minutes.
- If the road condition is poor (uneven road surface or potholes).
- If there is a strong side wind.

- If you adopt a sporty driving style (high cornering speeds or high rates of acceleration).
- If the Steering Assist function of Active Distance Assist DISTRONIC is active.
- If the clock is set to the incorrect time.
- If you change lanes and vary your speed frequently in active driving situations.

Microsleep detection also does not function when the driver camera cannot detect the eyes of the driver, as a result of the following factors, for example:

- The driver's eyes are covered, e.g. due to steering wheel position.
- Poor lighting conditions.
- Some types of spectacles or sunglasses.
- The driver's line of vision is outside the driver camera's field of vision.

Also observe any information regarding display messages that can be displayed in the instrument cluster  
(→ page 602, 645, 602, 645, 602, 645, 602).

The tiredness or alertness assessment of ATTENTION ASSIST with microsleep detection is deleted and restarted when continuing the journey in the following situations:

- If you switch off the engine.
- If you unfasten your seat belt and open the driver's door (e.g. changing drivers or taking a break).

### Setting ATTENTION ASSIST

Multimedia system:

→  Settings Assistance  
▶ ATTENTION ASSIST

### Setting the sensitivity

- ▶ Select **Setting**.
- ▶ Select **Standard**, **Sensitive** or **Off**.

### Activating/deactivating the microsleep warning

- ▶ Activate/deactivate **Microsleep warning**.

### Suggesting a rest area

- ▶ Switch **Suggest rest area** on or off. If ATTENTION ASSIST detects fatigue or increasing lack of attention, it suggests a rest area in the vicinity.
- ▶ Select the suggested rest area. You are guided to the selected rest area.

### Suggesting a power nap

- ▶ Switch **Suggest Power Nap** on or off.

## Traffic Sign Assist

### Function of Traffic Sign Assist

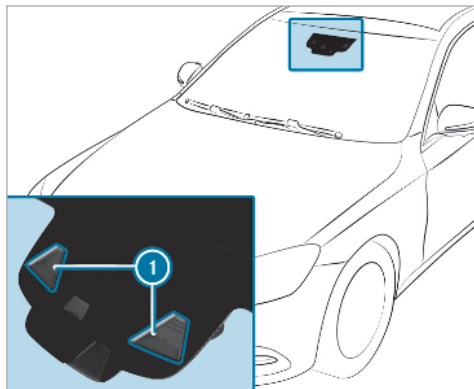

Traffic Sign Assist detects traffic signs with multifunction camera ① and compares this with information in the digital navigation map. It assists you by displaying detected speed limits and overtaking restrictions in the Instrument Display and in the head-up display. The system

can issue a warning when you exceed the maximum permissible speed. In some countries, the system can provide further functions such as warning when the vehicle is approaching pedestrian crossings or warning when stop signs, give way signs or red lights are crossed unintentionally.

The camera also detects and analyses traffic signs with a restriction indicated by an additional sign (e.g. when wet).

Traffic Sign Assist only visualises selected signs in the Instrument Display. Actual traffic signs and speed limits always have priority over traffic signs and speed limits shown in the Instrument Display.

Always observe the following notes:

- drive carefully, paying attention to the traffic and your immediate surroundings
- select a speed adjusted to the traffic, surrounding and weather conditions
- observe actual traffic signs
- observe applicable traffic rules and regulations

- always look in the direction of travel

Observe the notes on driving systems and your responsibility; you may otherwise fail to recognise dangers (→ page 203).

### Messages in the Instrument Display

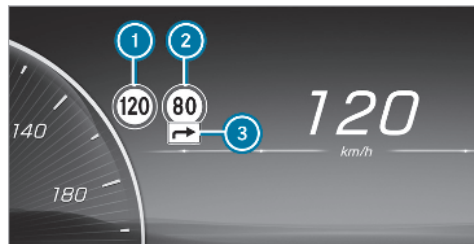

- ① Permissible speed
- ② Permissible speed when there is a restriction
- ③ Additional sign with restriction

The system can show up to two signs in the Instrument Display simultaneously. The system always prioritises displaying speed limits. If two speed signs are shown (when speed limits are

detected, for example), the value of left-hand speed limit ① is transmitted to the limiter, cruise control or Active Distance Assist DISTRONIC for adoption.



Examples of traffic signs which can be displayed

Traffic Sign Assist can detect and display following traffic signs ①:

- speed restrictions
- end of the speed limit
- no overtaking
- play streets
- signs showing the start or end of motorways

- signs showing the start or end of dual carriageways

Traffic Sign Assist can detect following additional signs ③ and, if necessary, analyse the relevance of the restrictions using other vehicle sensors:

- in wet conditions
- on slippery road surfaces
- in fog
- temporary restrictions
- exits
- limits for car/trailer combinations

Traffic Sign Assist also uses data from the digital street map in the navigation system. Therefore, the display in the Instrument Display can be updated without detecting traffic signs when you leave or enter a municipality or change roads, e.g. motorway exit or slip road or after you turn at a junction.

If Traffic Sign Assist cannot determine the current maximum permissible speed (e.g. due to

missing signs), the following display appears in the Instrument Display:



This is displayed continuously if the vehicle is in a country where Traffic Sign Assist is not supported. Traffic Sign Assist is not available in all countries.

③ Also observe the information on display messages in Traffic Sign Assist (→ page 574).

### **Warning when the maximum permissible speed is exceeded**

The system can warn you if you unintentionally exceed the maximum permissible speed. To do this, you can specify in the multimedia system by how much the maximum permissible speed can be exceeded before a warning is issued. You can set the warning to be only optical (the speed pictogram flashes three times in the Instrument Display) or that it should also be acoustic with a warning tone.

### Additional functions of Traffic Sign Assist (country-specific)

In some countries, the system can issue a warning in the following situations:

- if you drive onto a section of road in the wrong direction of travel (only vehicles with Driving Assistance Package)
- if you approach pedestrian crossings, provided that pedestrians are in the danger zone or are moving towards it
- if you unintentionally drive past stop signs, give way signs or red lights, provided that the sign is clearly visible

If no clear sign is detected or if multiple signs of traffic lights with different signals are detected, no warning can be issued.

You can set the warning to be only optical (a message in the Instrument Display) or that it should also be acoustic with a warning tone.

### System limits

The system may be impaired or may not function in the following situations:

- If visibility is poor, e.g. due to insufficient illumination of the road, highly variable shade conditions, rain, snow, fog, swirling dust or heavy spray.
- If there is glare, e.g. from oncoming traffic, direct sunlight or reflections.
- If there is dirt on the windscreen in the area of the multifunction camera or the camera is misted up, damaged or obscured.
- If traffic signs are hard to detect, e.g. due to dirt, snow, ice, insufficient lighting or driving too close to the vehicle in front, or because they are covered, faded, damaged, badly positioned or twisted.
- Active traffic signs with LED displays may not be detected correctly or at all due to technical factors (station frequency).
- If the information on the navigation system's digital map is incorrect, incomplete or out of date.

- If signs or the road layout is ambiguous, e.g. traffic signs in roadworks, at exits and ramps, in neighbouring lanes or parallel roads.
- If signs do not conform to the standard.
- If signs or road layouts are specific to the country and deviate from the route guidance in the navigation system, e.g. at or beyond construction sites.
- If you turn sharply on tight bends, you may pass traffic signs that are outside the camera's field of vision.
- If the system detects incorrectly.
- If you overtake vehicles with traffic signs attached.
- When using transport equipment secured to the vehicle by a trailer coupling, e.g. a bicycle rack, restrictions for car/trailer combinations may be considered valid if applicable.

### Setting Traffic Sign Assist Requirements:

- **Only vehicles with Driving Assistance Package:**



Active Distance Assist DISTRONIC must be activated for the automatic adoption of speed limits.

Multimedia system:

  **▶▶ Settings ▶▶ Assistance**  
**▶▶ Traffic Sign Assist**

### Activating/deactivating automatic adoption of speed limits (only vehicles with Driving Assistance Package)

▶ Select **Adopt limit**.

▶ Activate or deactivate the function. The speed limits detected by Traffic Sign Assist are automatically adopted by Active Distance Assist DISTRONIC.

 If one of the following systems is activated, the detected speed can be manually adopted as the speed limit:

- Active Distance Assist DISTRONIC
- Cruise control
- Variable limiter

Further information (→ page 221).

### Adjusting the type of warning

- ▶ Select **Warning type**.
- ▶ Select **Visual & audible** or **Visual**.

### Adjusting the warning threshold

This value determines the speed at which a warning is issued when exceeded.

- ▶ Set the desired speed under **Warning threshold**.

### Traffic Light Assistant

#### Function of the Traffic Lights Assistant

When approaching a junction, traffic lights are detected by the Traffic Lights Assistant and shown in augmented reality in the central display. The respective traffic lights must be selected by pressing briefly.

#### System limits

The Traffic Lights Assistant is only an aid. Always observe the traffic situation.

Detection of traffic lights may be restricted in the following cases:

- as a result of dazzling, e.g. through strong sunlight
- in the case of pedestrian crossings
- in the case of flashing orange traffic lights

### Switching on display of traffic lights

Multimedia system:

  **▶▶ Settings ▶▶ Assistance**  
**▶▶ Information**

▶ Activate **Traffic light assistant**.

When the camera image opens in the media display and traffic lights have been detected, a frame appears around the displayed traffic lights.

▶ **To select the monitored traffic lights:** designate the respective traffic lights by tapping on the selection symbol. The traffic lights are highlighted.

Depending on the selected setting, you receive a message when the traffic lights have changed.

- ▶ **To select the type of message for the change:** select the pen symbol.
- ▶ Select **Visual** or **Visual & audible**.  
If **Visual** is set, the frame of the video image flashes.
- ▶ If **Visual & audible** is set, a warning tone also sounds.

### Blind Spot Assist and Active Blind Spot Assist with exit warning

#### Function of Blind Spot Assist and Active Blind Spot Assist with exit warning

Blind Spot Assist and Active Blind Spot Assist use radar sensors to monitor the area up to 40 m behind and 3 m next to your vehicle.

The system can detect vehicles travelling from approximately 12 km/h and bicycles travelling from approximately 30 km/h and issue a warning if they move into the monitoring range.



Display in the "assistance" menu in the multifunction display

If a vehicle is detected close to the side of your vehicle, the red warning lamp in the corresponding outside mirror flashes. The lane that the vehicle is detected in is hatched out by the assistance graphic.

If you still switch on the turn signal indicator in the corresponding direction, a warning tone sounds once and red radar waves next to your vehicle are displayed in the assistance graphic. If the turn signal indicator remains on, no further warning tone will be sounded for other detected vehicles.

If you overtake a vehicle quickly, no warning is given.

Observe the notes on driving systems and your responsibility; you may otherwise fail to recognise dangers (→ page 203).

**⚠ WARNING** Risk of accident despite Blind Spot Assist

Blind Spot Assist does not react to vehicles approaching and overtaking you at a greatly different speed.

As a result, Blind Spot Assist cannot warn drivers in this situation.

- ▶ Always pay careful attention to the traffic situation and maintain a safe distance at the side of the vehicle.

#### Exit warning

The exit warning is an additional function of Blind Spot Assist and can warn vehicle occupants about approaching vehicles when leaving the vehicle when stationary.

**⚠ WARNING** Risk of accident despite exit warning

The exit warning reacts neither to stationary objects nor to vehicles approaching you at a greatly different speed.

As a result, the exit warning cannot warn drivers in these situations.

- ▶ Always pay particular attention to the traffic situation when opening the doors and make sure there is sufficient clearance.

If there is a vehicle in the monitoring range, this is indicated in the outside mirror. If a vehicle occupant opens the door on the side with the warning, a warning tone sounds and the warning lamp in the outside mirror starts to flash.

This additional function is only available when Blind Spot Assist is activated and up to a maximum of three minutes after the ignition has been switched off. The exit warning is no longer available once the warning lamp in the outside mirror flashes three times.

The exit warning is only an aid and not a substitute for the attention of vehicle occupants. The responsibility for opening and closing the doors and for leaving the vehicle remains with the vehicle occupants.

### System limits

Blind Spot Assist and Active Blind Spot Assist may be limited in the following situations:

- if there is dirt on the sensors or the sensors are obscured
- in poor visibility, e.g. due to fog, heavy rain or snow
- if there are narrow vehicles, e.g. bicycles or motorbikes
- if the road has very wide or narrow lanes
- if vehicles are not driving in the middle of their lane

Warnings may be issued in error when driving close to crash barriers or similar solid lane borders. Always make sure that there is sufficient distance to the side for other traffic or obstacles.

Warnings may be interrupted when driving alongside long vehicles, for example lorries, for a prolonged time.

Blind Spot Assist and Active Blind Spot Assist are not operational when reverse gear is engaged.

Blind Spot Assist and Active Blind Spot Assist are not operational when a trailer is coupled to the vehicle and the electrical connection has been correctly established.

The exit warning may be limited in the following situations:

- when the sensors are covered by adjacent vehicles in narrow parking spaces
- when people approach the vehicle
- in the event of stationary or slowly moving objects

### Function of brake application (Active Blind Spot Assist)

- ⓘ The brake application function is only available for vehicles with a Driving Assistance Package.

If Active Blind Spot Assist detects a risk of a side impact in the monitoring range, a course-correcting brake application is carried out. This is designed to help you avoid a collision.

The course-correcting brake application is available in the speed range between approximately 30 km/h and 200 km/h.

**⚠ WARNING** Risk of accident despite brake application of Active Blind Spot Assist

A course-correcting brake application cannot always prevent a collision.

- ▶ Always steer, brake or accelerate yourself, especially if Active Blind Spot Assist warns you or makes a course-correcting brake application.
- ▶ Always maintain a safe distance at the sides.

**⚠ WARNING** Risk of accident despite Active Blind Spot Assist

Active Blind Spot Assist does not react especially in the following situations:

- If you overtake vehicles at a high speed.
- If vehicles approach and overtake you at a greatly different speed.

As a result, Active Blind Spot Assist may neither give warnings nor intervene, especially in such situations.

- ▶ Always pay careful attention to the traffic situation and maintain a safe distance at the side of the vehicle.

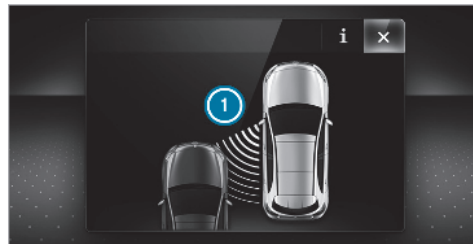

Placeholder

If a course-correcting brake application occurs, the red warning lamp flashes in the outside mirror and a warning tone sounds. In addition, a display ① indicating the danger of a side collision appears in the multifunction display.

In rare cases, the system may make an inappropriate brake application. This brake application may be interrupted at any time if you steer slightly in the opposite direction or accelerate.

## System limits

Either a course-correcting brake application appropriate to the driving situation, or none at all, may occur especially in the following situations:

- Vehicles or obstacles, e.g. crash barriers, are located on both sides of your vehicle.
- A vehicle approaches too closely on the side.
- You have adopted a sporty driving style with high cornering speeds.
- You brake or accelerate significantly.
- A driving safety system intervenes, e.g. ESP® or Active Brake Assist.
- ESP® is deactivated.
- A loss of tyre pressure or a defective tyre is detected.
- You are driving with a trailer and the electrical connection to the trailer hitch has been correctly established.

## Activating/deactivating Blind Spot Assist or Active Blind Spot Assist

Multimedia system:

→  → Settings → Assistance

▶ Activate/deactivate **Blind Spot Assist**.

or

▶ Activate/deactivate **Active Blind Spot Assist**.

## Active Lane Keeping Assist

### Function of Active Lane Keeping Assist

Active Lane Keeping Assist monitors the area in front of your vehicle by means of the multifunction camera and can warn you before you leave your lane unintentionally. The system can guide you back into your lane through a course-correcting steering intervention and additionally warns you with vibration pulses in the steering wheel. Active Lane Keeping Assist is available in the speed range between 60 km/h and 200 km/h.

The system can intervene in the following situations:

- Active Lane Keeping Assist detects a lane marking.
- One of your front wheels goes over a lane marking.

The system does not intervene if you activate the turn signal indicator. If the system detects an obstacle, such as another vehicle in the adjacent lane, it will intervene regardless of the turn signal indicator.

If you leave the lane without using the turn signal indicator, but an obstacle is detected in your lane, the system will not intervene.







Display **1** will appear in the multifunction display and a warning tone will sound in the following situations:

- Active Lane Keeping Assist intervenes for longer than approximately ten seconds.
- Two or more interventions occur within approximately three minutes without any steering intervention from the driver.

In the Active Lane Keeping Assist settings, you can set the sensitivity of the system and set the level of support. Additionally, you can set whether the system should react to broken lane markings or only solid lane markings. The respective setting is also saved even when the vehicle is restarted (→ page 265).

#### Status displays for Active Lane Keeping Assist in the on-board computer

-  (grey): Active Lane Keeping Assist is activated, but not operating.
-  (green): Active Lane Keeping Assist is activated and operating. If the system is operational on only one side, the status is displayed on the corresponding side.

-  (red): Active Lane Keeping Assist has guided you back into your lane with a course-correcting steering intervention. The status display will flash if there is also a haptic warning in the steering wheel. The status display is displayed on the corresponding side.
-  (white): Active Lane Keeping Assist is deactivated.
-  (yellow): there is a malfunction. Please also observe the display messages.

#### Active Lane Change Assist display in the "assistance" menu



If the front wheel of the vehicle drives over a detected lane marking, this will be highlighted red in the "assistance" menu in the multifunction display.

#### System limits

No lane-correcting steering intervention occurs in the following situations:

- You clearly and actively steer, brake or accelerate.
- A driving safety system intervenes, such as ESP®, Active Brake Assist or Active Blind Spot Assist.
- You have adopted a sporty driving style with high cornering speeds or high rates of acceleration.
- When ESP® is deactivated.
- When driving with a trailer, the electrical connection to the trailer has been correctly established.
- If a loss of tyre pressure or a defective tyre has been detected and displayed.

The system may be impaired or may not function in the following situations:

- If there is poor visibility, e.g. due to insufficient illumination of the road, if there are highly variable shade conditions or in rain, snow, fog or heavy spray.
- If there is glare, e.g. from oncoming traffic, the sun or reflections.
- If the windscreen in the area of the multi-function camera is dirty, or if the camera is misted up, damaged or covered.
- If there are no lane markings, or several unclear lane markings are present for one lane, e.g. around roadworks.
- If the lane markings are worn, dark or covered.
- If the distance to the vehicle in front is too short and thus the lane markings cannot be detected.
- If the lane markings change quickly, e.g. lanes branch off, cross one another or merge.

- If the carriageway is very narrow and winding.

Observe the notes on driving systems and your responsibility; you may otherwise fail to recognise dangers (→ page 203).

### Activating/deactivating Active Lane Keeping Assist

Multimedia system:

→  →  → Vehicle quick-access  
 → Active Lane Keeping Assist

▶ Activate or deactivate the function.

ⓘ After starting the engine, the settings are country-specific.

### Setting Active Lane Keeping Assist

Multimedia system:

→  → Settings → Assistance  
 → Active Lane Keeping Assist

### Setting the sensitivity

▶ Select .

▶ Select Medium, Early or Late.

The last selected setting will be adopted the next time the engine is started.

ⓘ The standard setting for this function is dependent on the country.

### Activating or deactivating assistance on discontinuous lane markings

▶ Select Advanced support.

The last selected setting will be adopted the next time the engine is started.

ⓘ The standard setting for this function is dependent on the country.

## Trailer hitch

### Notes on trailer operation

Observe the following notes on the tongue weight:

- Do not use a tongue weight that exceeds or falls below the permissible tongue weight
- Use a tongue weight as close as possible to the maximum tongue weight

Do not exceed the following values:

- Permissible towing capacity
- Permissible rear axle load of the towing vehicle
- Permissible gross mass of the towing vehicle
- Permissible gross mass of the trailer
- Maximum permissible speed of the trailer

Ensure the following before starting a journey:

- The tyre pressure on the rear axle of the towing vehicle is set for a maximum load
- The lighting of the connected trailer is operational

In the event of increased rear axle load, the car/trailer combination may not exceed a maximum speed of 100 km/h for reasons concerning the operating permit. This also applies in countries in which the permissible maximum speed for car/trailer combinations is above 100 km/h.

### Extending/retracting the ball neck fully electrically

**⚠ WARNING** Risk of accident due to the ball neck not being engaged

If the ball neck is not engaged, the trailer may come loose.

▶ Make sure that the ball neck securely engages and locks into place.

**! NOTE** Damage to the all-electric trailer hitch due to additional pressure

The all-electric trailer hitch could be mechanically damaged by applying additional pressure when the ball neck is being extended or retracted.

▶ Do not make the ball neck extend/retract faster by applying additional pressure.

#### Requirements:

- The vehicle is secured against rolling away.
- The swivel range is clear.

- The trailer cables or adapter plugs have been removed.

### Extending the ball neck fully electrically

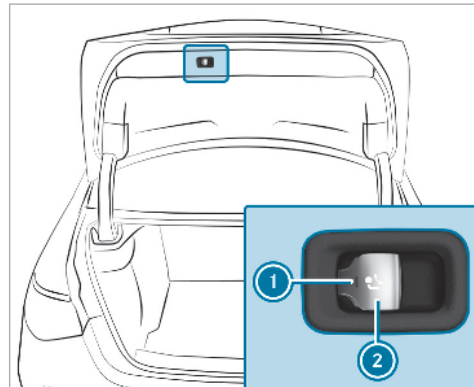

▶ **To extend:** pull button ②.

Indicator lamp ① will flash and the display message **Trailer coupling in motion** will appear on the driver's display.

The ball neck will extend fully electrically.



- ▶ Wait until the ball neck has locked in place. The ball neck is securely locked in place when indicator lamp ① is continuously lit.

If the ball neck is not securely locked in place, indicator lamp ① will flash and the display message **Check trailer hitch lock** will appear on the driver's display.

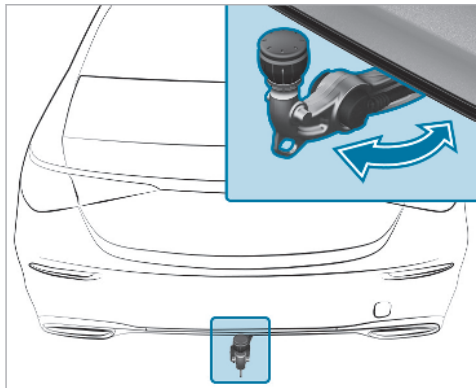

### Retracting the ball neck fully electrically

- ▶ Pull button ②.

Indicator lamp ① will flash and the display message **Trailer coupling in motion** will appear on the driver's display.

The ball neck will retract fully electrically.

- ▶ Wait until the ball neck has locked in place. The ball neck will be securely locked in place when indicator lamp ① goes out.

If the ball neck is not securely locked in place, indicator lamp ① will flash and the display message **Trailer coupling Check lock** will appear on the driver's display.

Observe the information about the notifications on the driver's display:

- Indicator and warning lamps (→ page 634)
- Display messages (→ page 574)

### Folding the ball neck in/out fully electrically (multimedia system)

**⚠ WARNING** Risk of accident due to the ball neck not being engaged

If the ball neck is not engaged, the trailer may come loose.

- ▶ Always engage the ball neck as described.

**! NOTE** Damage to the all-electric trailer hitch due to additional pressure

The all-electric trailer hitch could be mechanically damaged by applying additional pressure when the ball neck is being extended or retracted.

- ▶ Do not make the ball neck extend/retract faster by applying additional pressure.

### Requirements:

- The vehicle is secured against rolling away.
- The swivel range is clear.

- The trailer cables or adapter plugs have been removed.

Multimedia system:

    **Vehicle quick-access**

### Extending the ball neck fully electrically

- ▶ Select . The display message **Trailer coupling in motion** will appear on the driver's display. The ball neck will extend fully electrically.
- ▶ Wait until the ball neck has locked in place.

If the ball neck is not securely locked in place, the display message **Check trailer hitch lock** will appear on the driver's display.

### Retracting the ball neck fully electrically

- ▶ Select . The display message **Trailer coupling in motion** will appear on the driver's display. The ball neck will retract fully electrically.
- ▶ Wait until the ball neck has locked in place.

If the ball neck is not securely locked in place, the display message **Trailer coupling Check lock** will appear on the driver's display.

Observe the information about the displays on the instrument cluster:

- Indicator and warning lamps (→ page 634)
- Display messages (→ page 574)

### Coupling up/uncoupling a trailer

 **WARNING** Risk of injury from the vehicle level being changed

**Vehicles with level control system:** the vehicle level may be changed unintentionally, e.g. by other persons. You may become trapped if you couple up or uncouple a trailer while the vehicle level is changing. In addition, other people could become trapped if their limbs are between the vehicle body and the tyres or underneath the vehicle.

When coupling up or uncoupling a trailer, make sure that:

- ▶ The doors or tailgate are not opened or closed.
- ▶ You do not initiate the level control system and do not operate the DYNAMIC SELECT switch.
- ▶ Do not lock or unlock the vehicle.

### Requirements:

- The ball neck is extended and engaged in a securely locked position.

Trailers with a 7-pin plug can be connected to the vehicle with the following adapters:

- Adapter plug
- Adapter cable

The trailer will be correctly detected by the vehicle only if the following conditions are met:

- The trailer is connected correctly
- The trailer lighting system is in working order

The functions of the following systems will be affected by a correctly connected trailer:

- Active Lane Keeping Assist

- ESP® trailer stabilisation
- Parking Assist PARKTRONIC
- Active Parking Assist
- Blind Spot Assist or Active Blind Spot Assist
- Drive Away Assist
- Cross Traffic Alert
- Reversing camera
- 360° camera
- AIR BODY CONTROL

### Coupling up a trailer

**!** **NOTE** Damage to the starter battery due to full discharge

Charging the trailer battery using the power supply of the trailer can damage the starter battery.

▶ Do not use the vehicle's power supply to charge the trailer battery.

▶ Remove the cover from the ball head and store it in a safe place (→ page 119).

▶ Position the trailer on a level surface behind the vehicle and couple it up to the vehicle.



- ▶ Open the socket cap.
- ▶ Insert the plug with lug ① in groove ③ on the socket.
- ▶ Turn bayonet coupling ② to the right as far as it will go.
- ▶ Let the cap engage.
- ▶ Secure the cable to the trailer with cable ties (only if you are using an adapter cable).
- ▶ Make sure that the cable is always slack for ease of movement during cornering.

Under the following conditions, a message may appear on the driver's display even if the trailer has been connected correctly:

- LEDs have been installed in the trailer lighting system
  - The current has fallen below the trailer lighting system's minimum current (50 mA)
- ⓘ Accessories can be connected to the permanent power supply up to 180 W and to the power supply that is switched on via the ignition lock.

### Uncoupling a trailer

**!** **WARNING** Risk of being crushed and becoming trapped when uncoupling a trailer

When uncoupling a trailer with an engaged inertia-activated brake, your hand may become trapped between the vehicle and the trailer drawbar.

▶ Do not uncouple trailers with an engaged overrun brake.

**!** **NOTE** Damage when uncoupling in a state of overrun

Uncoupling in a state of overrun can damage the vehicle.

- ▶ Do not uncouple trailers with an engaged overrun brake.

**!** **WARNING** Risk of becoming trapped when disconnecting the trailer cable

**Vehicles with level control system:** The vehicle may lower when the trailer cable is disconnected.

This could result in you or other people becoming trapped if your or their limbs are between the vehicle body and the tyres or underneath the vehicle.

- ▶ Make sure that nobody is underneath the vehicle or in the immediate vicinity of the wheel arches when you disconnect the trailer cable.

- ▶ Secure the trailer against rolling away.

- ▶ Disconnect the electrical connection between the vehicle and the trailer.
- ▶ Uncouple the trailer.
- ▶ Place the cover cap on the ball head.

### Bicycle rack function

**!** **WARNING** Risk of an accident when using the bicycle rack incorrectly

The bicycle rack may become detached from the vehicle in the following cases:

- the permissible load capacity of the trailer hitch is exceeded.
- the bicycle rack is used incorrectly.
- the bicycle rack is secured to the ball neck beneath the ball head.

Observe the following for your own safety and that of other road users:

- always adhere to the permissible load capacity of the trailer hitch.

- only use the bicycle rack to transport bicycles.
- always mount the bicycle rack properly by attaching to the ball head and the ball neck guide pin, if possible.
- when transporting four bicycles, always use bicycle racks which have additional support on the ball neck guide pin.
- only use bicycle racks approved by Mercedes-Benz.
- always observe the bicycle rack operating instructions.

**!** **NOTE** Damage to, or cracks on, the trailer hitch due to unsuitable bicycle racks or bicycle racks being used incorrectly

- ▶ use only bicycle racks approved by Mercedes-Benz.

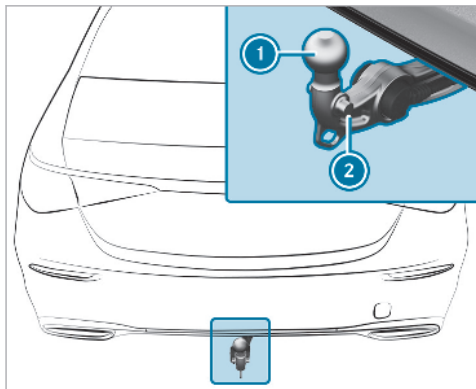

Trailer hitch (example with additional guide pin)

Depending on the bicycle rack's design, different numbers of bicycles can be transported.

The following bicycle rack designs are possible:

- When mounted by attaching to the ball head ①, the maximum load capacity is 75 kg. Up to three bicycles can be transported.

- When mounted on the ball head ① and the guide pin ②, the maximum load capacity is 100 kg. Up to four bicycles can be transported.

The load capacity is calculated from the weight of the bicycle rack and the bicycle rack load.

The vehicle's driving characteristics will change when a bicycle rack is fitted. Adapt your driving style accordingly. Drive carefully and maintain a safe distance.

When using a bicycle rack, set the tyre pressure for increased load on the rear axle of the vehicle. Further information on the tyre pressure can be found in the tyre pressure table (→ page 493).

### Notes on loading

The larger the distance between the load's centre of gravity and the ball head, the greater the load on the trailer hitch.

Observe the following notes:

- Mount heavy bicycles as close to the vehicle as possible.

- Always distribute the load on the bicycle rack as evenly as possible across the vehicle's longitudinal axis.

Mercedes-Benz recommends removing all detachable parts from bicycles (e.g. baskets, child seats, rechargeable batteries) before loading them onto the bicycle rack. This will improve the aerodynamic resistance and centre of gravity of the bicycle rack.

Always secure the bicycles to prevent them from moving around and check them at regular intervals to ensure that they are secure.

Do not use tarpaulins or other covers. The driving characteristics and rear view may be impaired. In addition, aerodynamic resistance and the load on the trailer hitch will increase.

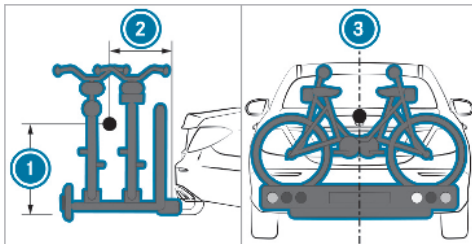

Load distribution on the bicycle rack

- ① Vertical distance between centre of gravity and ball head
- ② Horizontal distance between centre of gravity and ball head
- ③ The centre of gravity is on the vehicle's centre axis

Observe the following information when loading the bicycle rack:

### Loading the bicycle rack

	3 bicycles	4 bicycles
Total weight of bicycle rack and load	Up to 75 kg	Up to 100 kg
Max. distance ①	420 mm	420 mm
Max. distance ②	300 mm	400 mm

When transporting four bicycles or with a total weight between 75 kg and 100 kg, always use bicycle racks with additional support on the trailer hitch guide pin.

### Vehicle towing instructions

The vehicle is not suitable for the use of tow bar systems that are used for flat towing or dinghy towing, for example. Attaching and using tow bar systems can lead to damage on the vehicle. When you are towing a vehicle with tow bar systems, safe driving characteristics cannot be

guaranteed for the towing vehicle or the towed vehicle. The vehicle-trailer combination may swerve from side to side. Comply with the permitted towing methods (→ page 482) and the instructions for towing with both axles on the ground (→ page 483).

## Overview of the driver display

**⚠ WARNING** Risk of accident due to a driver display malfunction

If the driver display has failed or malfunctioned, the function restrictions applying to safety relevant systems are not visible.

The operating safety of your vehicle may be impaired.

- ▶ Drive on carefully.
- ▶ Have the vehicle checked immediately at a qualified specialist workshop.

If the operating safety of your vehicle is impaired, park the vehicle immediately and safely. Contact a qualified specialist workshop.

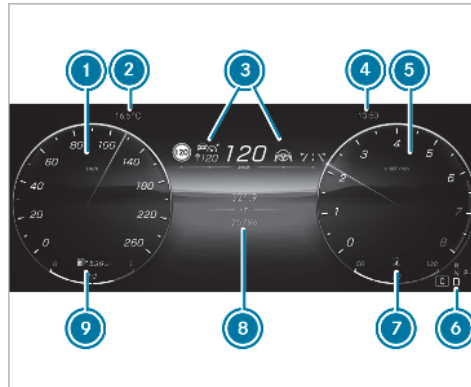

- ① Speedometer
- ② Outside temperature
- ③ Status displays for driver assistance systems
- ④ Time
- ⑤ Rev counter
- ⑥ Transmission position
- ⑦ Coolant temperature display

- ⑧ Display range, centre
- ⑨ Fuel level and fuel filler flap location indicator
- ⓘ Please note that the status displays of the driver assistance systems vary depending on the status. You can find a selection here: (→ page 277).

The segments on speedometer ① indicate the status of the following systems:

- Cruise control (→ page 215)
- Limiter (→ page 216)
- Active Distance Assist DISTRONIC (→ page 219)

**Vehicles with Traffic Sign Assist:** detected instructions and traffic signs appear on the upper status display (→ page 256).

**⚠ NOTE** Engine damage due to excessively high engine speeds

The engine will be damaged if you drive with the engine in the overrevving range.

- ▶ Do not drive with the engine in the over-revving range.

The overrevving range is shown in red on rev counter ③. When the overrevving range is reached, the fuel supply will be interrupted to protect the engine.

During normal operating conditions, coolant temperature display ⑦ may rise to 120°C.

**⚠ WARNING** Danger of burns when opening the bonnet

If you open the engine bonnet when the engine has overheated or during a fire in the engine compartment, you could come into contact with hot gases or other escaping operating fluids.

- ▶ Before opening the bonnet, allow the engine to cool down.
- ▶ In the event of a fire in the engine compartment, keep the engine bonnet closed and call the fire service.

### Vehicles with a 48 V on-board electrical system (EQ Boost technology)

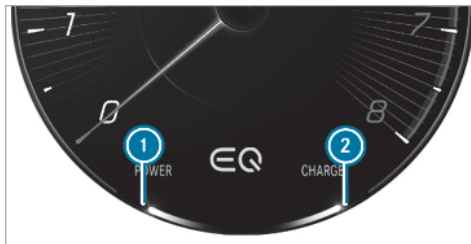

- ① POWER shows the electric drive support
- ② CHARGE shows the recuperation power of the electric motor

**READY** shows the drive system's operational readiness.

### Overview of the buttons on the steering wheel

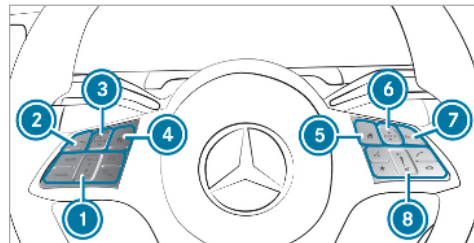

- ① Control panel for cruise control/limiter or Active Distance Assist DISTRONIC (→ page 217)
- ② Back button, on-board computer
- ③ Touch Control, on-board computer  
Swipe (navigate)  
Press **OK** (confirm)
- ④ Main menu, on-board computer
- ⑤ Activation buttons and DRIVE PILOT readiness display
- ⑥ Main menu, MBUX multimedia system



- ⑦ Touch Control, MBUX multimedia system  
Swipe (navigate)  
Press (confirm)
- ⑧  Back button, MBUX multimedia system
- ⑨ Control panel for the MBUX multimedia system (→ page 293)

## Operating the on-board computer

### Calling up and operating menus

**⚠ WARNING** Risk of distraction from information systems and communications equipment

If you operate information and communication equipment integrated in the vehicle when driving, you will be distracted from the traffic situation. This could also cause you to lose control of the vehicle.

- ▶ Only operate this equipment when the traffic situation permits.
- ▶ If you cannot be sure of this, stop the vehicle whilst paying attention to road

and traffic conditions and operate the equipment with the vehicle stationary.

Observe the legal requirements for the country in which you are currently driving when operating the on-board computer.

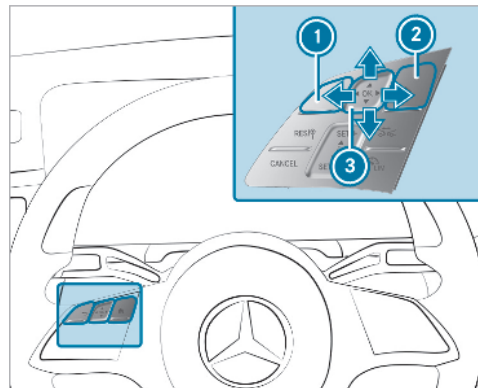

- ① Back button
- ② Home button
- ③ Touch Control

You can navigate in menus and lists via the touch-sensitive surface of Touch Control ③ by using **a single-finger swipe**.

When the on-board computer is being operated, different acoustic signals will sound as operating

feedback, e.g. when the end of a list is reached or when you are scrolling through a list.



- ▶ **To call up a menu via the menu bar:** press home button ②.
- ▶ Activate a menu by swiping to the left or right on Touch Control ③.
- ▶ Confirm by pressing Touch Control ③.
- ▶ **To switch between the menus:** switch directly from one menu to the next by swiping to the left or right.
- ▶ **To call up a submenu:** press Touch Control ③.
- ▶ **To exit a submenu:** press back button ①.

- ▶ **To scroll through displays or lists on the menu or submenu:** swipe upwards or downwards on left-hand Touch Control ③.

① Index points that show which menu you are currently in or which menu content has been selected appear at the bottom of the menu bar or within a menu.

### Setting display content as the standard display

- ▶ Press Touch Control ③.  
On the **Options** submenu, the request **Use current display as standard display?** will appear.
- ▶ Select **Yes** by swiping to the left and confirm by pressing Touch Control ③.
- ▶ **To call up standard displays:** press back button ① on the upper level of a menu.
- ① Pressing back button ① on the standard display calls up the previous screen.

### Resetting values on the on-board computer

You can reset the values of the following functions:

- Trip meter
- Trip computer **From start** and **From reset**
- ECO display (→ page 182)

- ▶ **To call up a submenu:** press Touch Control ③.
- ▶ **To select the function to be reset:** swipe on Touch Control ③.
- ▶ Press Touch Control ③.
- ▶ Select **Yes**.
- ▶ Press Touch Control ③.

### Selecting display content, centre on the instrument cluster

On-board computer:

➔ **Classic**

Depending on the vehicle equipment, you can choose between different display content in the

centre display range of the **Classic** and **Exclusive** menus on the instrument cluster.

- ① You can select colour settings on the centre display range on the **Understated** menu.

▶ **To select display content:** swipe upwards or downwards on the left-hand Touch Control to select the required display content.

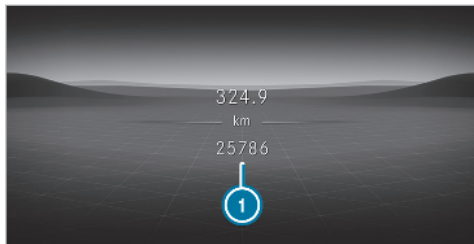

- ① Display content, centre on the **Classic** menu (example)

The following display content, for example, can be displayed on the centre display range:

- Navigation
- Standard display

- ATTENTION ASSIST
- ECO display
- Accepting or rejecting calls, switching between connected telephones and calling up call lists

You can select further settings for the respective display content on the display range, centre on the **Options** submenu.

### Status displays on the driver display

- ↑ Gearshift recommendation (→ page 189)
- ↓ Pedestrian detection
- P / P Active Parking Assist (→ page 249)
- P OFF PARKTRONIC deactivation (→ page 240)
- Cruise control (→ page 215)
- LIM Limiter (→ page 216)
- Active Distance Assist DISTRONIC (→ page 219)



Specified distance for Active Distance Assist DISTRONIC (→ page 219)



Active Brake Assist (→ page 215)



Active Steering Assist (→ page 225)



Active Lane Change Assist (→ page 227)



Active Lane Keeping Assist (→ page 263)



Active Blind Spot Assist (→ page 261)



Haptic accelerator pedal (→ page 182)



ECO start/stop function (→ page 181)



HOLD function (→ page 232)



Adaptive Highbeam Assist Plus (→ page 148)



Maximum permissible speed exceeded (for certain countries only)



Active Traffic Jam Assist  
(→ page 231)



Active Brake Assist, danger of collision with crossing traffic  
(→ page 208).

**Vehicles with Traffic Sign Assist:** detected instructions and traffic signs (→ page 256).

## Menus and submenus

### Adjusting displays on the Service menu of the on-board computer

On-board computer:



Service

You can show/hide different display content on the **Service** menu.

- ▶ Swipe upwards or downwards on the left-hand Touch Control. Different display content will be shown or hidden.

Display content on the **Service** menu:

- **AdBlue:** AdBlue® range and fill level

- **Tyres:**
  - Check the tyre pressure with the tyre pressure monitoring system (→ page 494)
  - Restart the tyre pressure monitoring system (→ page 495)
- **ASSYST PLUS:** call up the service due date (→ page 455)
- **Engine oil level:** check the engine oil level (→ page 458)

The following functions are available on the **Options** submenu:

- Set display content as the standard display (→ page 275)
- Message memory (→ page 574)
- Tyre pressure (→ page 494)

### Adjusting the assistant display

On-board computer:



Assistance



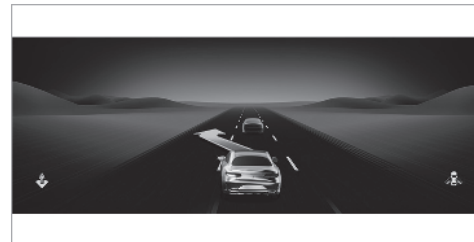

You can show/hide different display content on the **Assistance** menu.

- ▶ Swipe upwards or downwards on the left-hand Touch Control. Different display content will be shown or hidden.



- ⓘ There are also navigation instructions on the left-hand display range of the assistant display. These navigation instructions as well as the level of detail of the assistant display may vary depending on the display content.

Status displays on the assistant display:

-  Green: pedestrian detection active
-  Grey: pedestrian detection enabled
-  Green radar waves next to vehicle: Blind Spot Assist or Active Blind Spot Assist enabled and ready for operation
-  Grey radar waves next to vehicle: Blind Spot Assist or Active Blind Spot Assist enabled but not ready for operation
- Status displays for Active Lane Keeping Assist (→ page 263)
- Further status displays for Blind Spot Assist or Active Blind Spot Assist (→ page 260)
- Status displays for Active Brake Assist (→ page 208)

- Status displays for Active Distance Assist DISTRONIC (→ page 219)

The content on the assistant display is adapted to the following situations:

- Number of detected lanes
- Driving style
- Current road conditions
- Rain
- Detected road users

- ⓘ Please note that the detected obstacles themselves are not displayed on the assistant display.

The following functions are available on the **Options** submenu:

- Select route
- Set display content as the standard display (→ page 275)

## Calling up displays on the Sport menu

On-board computer:

➔ Sport

You can show/hide different display content on the **Sport** menu.

▶ Swipe upwards or downwards on the left-hand Touch Control.

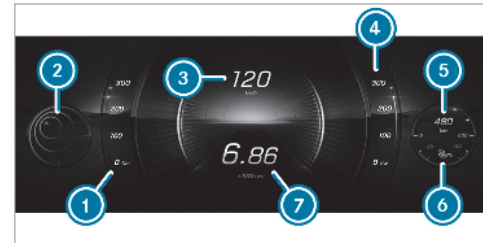

- ① Current torque
- ② G-meter
- ③ Digital speedometer
- ④ Current power output
- ⑤ Boost pressure