



EMI TEST REPORT

Test Report No. : 12615475H-B-R1

Applicant : M-SYSTEM CO., LTD.
Type of Equipment : WIRELESS TOWER LIGHT
Model No. : IT60SW5F-5RYGBWD2U-R
FCC ID : 2AOTF-0000006
Test regulation : FCC Part 15 Subpart B: 2018 Class A
Test Result : Complied (Refer to SECTION 3.2)

1. This test report shall not be reproduced in full or partial, without the written approval of UL Japan, Inc.
2. The results in this report apply only to the sample tested.
3. This sample tested is in compliance with the above regulation.
4. The test results in this report are traceable to the national or international standards.
5. This test report covers EMC technical requirements. It does not cover administrative issues such as Manual or non-EMC test related Requirements. (if applicable)
6. The all test items in this test report are conducted by UL Japan, Inc. Ise EMC Lab.
7. This test report must not be used by the customer to claim product certification, approval, or endorsement by NVLAP, NIST, or any agency of the Federal Government.
8. The information provided from the customer for this report is identified in SECTION 1.
9. This report is a revised version of 12615475H-B. 12615475H-B is replaced with this report.

Date of test: February 23 to March 19, 2019

Representative test engineer:

Masaya Minami
Engineer
Consumer Technology Division

Approved by:

Satofumi Matsuyama
Engineer
Consumer Technology Division

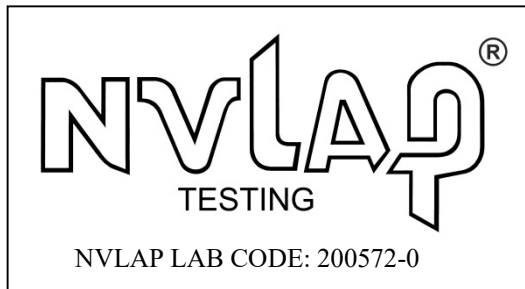

This laboratory is accredited by the NVLAP LAB CODE 200572-0, U.S.A. The tests reported herein have been performed in accordance with its terms of accreditation. *As for the range of Accreditation in NVLAP, you may refer to the WEB address, http://japan.ul.com/resources/emc_accruited/

- The testing in which "Non-accreditation" is displayed is outside the accreditation scopes in UL Japan.
 There is no testing item of "Non-accreditation".

UL Japan, Inc.

Ise EMC Lab.

4383-326 Asama-cho, Ise-shi, Mie-ken 516-0021 JAPAN

Telephone : +81 596 24 8999

Facsimile : +81 596 24 8124

CONTENTS	PAGE
SECTION 1: Customer information	4
SECTION 2: Equipment under test (E.U.T.).....	4
SECTION 3: Test specification, procedures & results	6
SECTION 4: Operation of E.U.T. during testing.....	9
SECTION 5: Conducted Emission.....	11
SECTION 6: Radiated Emission.....	12
APPENDIX 1: Test data	14
Conducted Emission	14
Radiated emission	15
APPENDIX 2: Test instruments	17
APPENDIX 3: Photographs of test setup	18
Conducted Emission	18
Radiated Emission	19

SECTION 1: Customer information

Company Name : M-SYSTEM CO., LTD.
Address : 5-2-55 MINAMITSUMORI, NISHINARI-KU, OSAKA, 557-0063 JAPAN
Telephone Number : +81-6-6659-8258
Facsimile Number : +81-6-6659-8514
Contact Person : Juri Sugiyama

The information provided from the customer is as follows;

- Applicant, Type of Equipment, Model No. on the cover and other relevant pages
- SECTION 1: Customer information
- SECTION 2: Equipment under test (E.U.T.)
- SECTION 4: Operation of E.U.T. during testing

* The laboratory is exempted from liability of any test results affected from the above information in SECTION 2 and 4.

SECTION 2: Equipment under test (E.U.T.)

2.1 Identification of E.U.T.

Type of Equipment : WIRELESS TOWER LIGHT
Model No. : IT60SW5F-5RYGBWD2U-R
Serial No. : Refer to Section 4, Clause 4.2
Rating : DC 24 V
Receipt Date of Sample : February 20, 2019
(Information from test lab.)
Country of Mass-production : Japan
Condition of EUT : Engineering prototype
(Not for Sale: This sample is equivalent to mass-produced items.)
Modification of EUT : No Modification by the test lab

2.2 Product Description

Model: IT60SW5F-5RYGBWD2U-R (referred to as the EUT in this report) is a WIRELESS TOWER LIGHT.

General Specification

Clock frequency(ies) in the system : 252 MHz (max.)

Radio Specification

	IEEE802.15.4g
Frequency of operation	902 MHz - 928 MHz
Type of modulation	GFSK
Channel spacing	0.6 MHz
Antenna type	sleeve antenna
Antenna Connector type	Connector for connecting antenna
Antenna Gain	3 dBi (max)
Clock frequency (maximum)	928 MHz

*WIRELESS TOWER LIGHT has the following model variations in the table below and the suffixes (-xxxxxD2U-Rx: x is replaced with specified alphanumeric numbers).

Model variations	the diameter of the indicator light tower
IT60SW5F (Tested model)	60 mm
IT50SW5F	50 mm
IT40SW5F	40 mm

The model variations is only for the diameter of indicating lamp, and they are completely identical in EMC characteristics. The suffixes only relate to lamp layer, color, mounting, design, intended use country and power input that do not affect to EMC characteristics.

Therefore, the test was performed with as IT60SW5F as representative.

* The RF module is a FCC certificated module made by Oki Electric Industry Co., Ltd. Model number: MH920-Mod-F (FCC ID: 2AKGW-1TD3016A1).

SECTION 3: Test specification, procedures & results

3.1 Test Specification

Test Specification : FCC Part 15 Subpart B
FCC Part 15 final revised on March 12, 2018 and effective April 11, 2018

Title : FCC 47CFR Part15 Radio Frequency Device
Subpart B Unintentional Radiators

3.2 Procedures and results

Item	Test Procedure	Limits	Deviation	Worst margin	Result	Remarks
Conducted emission	FCC: ANSI C63.4: 2014 7. AC power - line conducted emission measurements IC: ICES-003 Issue 6: 2016 + Amendment 1: 2017	Class A	N/A	[QP] 37.95 dB 16.53680 MHz, N [AV] 29.95dB 16.53680 MHz, N	Complied a)	-
Radiated emission	FCC: ANSI C63.4: 2014 8. Radiated emission measurements IC: ICES-003 Issue 6: 2016 + Amendment 1: 2017	Class A	N/A	11.6 dB 454.781 MHz, Vertical. QP	Complied b)	-
*Note: UL Japan, Inc's EMI Work Procedure 13-EM-W0420.						
a) Refer to APPENDIX 1 (data of Conducted Emission)						
b) Refer to APPENDIX 1 (data of Radiated emission)						
Symbols:						
Complied The data of this test item has enough margin, more than the measurement uncertainty.						
Complied# The data of this test item meets the limits unless the measurement uncertainty is taken into consideration.						

3.3 Addition to standard

No addition, exclusion nor deviation has been made from the standard.

3.4 Uncertainty

EMI

There is no applicable rule of uncertainty in this applied standard. Therefore, the following results are derived depending on whether or not laboratory uncertainty is applied.

The following uncertainties have been calculated to provide a confidence level of 95 % using a coverage factor $k = 2$.

Conducted emission

using Item	Frequency range	Uncertainty (+/-)
AMN (LISN)	0.009 MHz to 0.15 MHz	3.8 dB
	0.15 MHz to 30 MHz	3.4 dB

Radiated emission

Measurement distance	Frequency range	Uncertainty (+/-)	
10 m	30 MHz to 200 MHz	(Horizontal)	4.8 dB
		(Vertical)	4.9 dB
	200 MHz to 1000 MHz	(Horizontal)	5.0 dB
		(Vertical)	5.0 dB
3 m	1 GHz to 6 GHz	5.0 dB	
	6 GHz to 18 GHz	5.3 dB	

3.5 Test Location

UL Japan, Inc. Ise EMC Lab.
4383-326 Asama-cho, Ise-shi, Mie-ken 516-0021 JAPAN
Telephone: +81 596 24 8999, Facsimile: +81 596 24 8124
NVLAP Lab. code: 200572-0 / FCC Test Firm Registration Number: 199967

Test site	IC Registration Number	Width x Depth x Height (m)	Size of reference ground plane (m) / horizontal conducting plane	Other rooms	Maximum measurement distance
No.1 semi-anechoic chamber	2973C-1	19.2 x 11.2 x 7.7	7.0 x 6.0	No.1 Power source room	10 m
No.2 semi-anechoic chamber	2973C-2	7.5 x 5.8 x 5.2	4.0 x 4.0	-	3 m
No.3 semi-anechoic chamber	2973C-3	12.0 x 8.5 x 5.9	6.8 x 5.75	No.3 Preparation room	3 m
No.3 shielded room	-	4.0 x 6.0 x 2.7	N/A	-	-
No.4 semi-anechoic chamber	2973C-4	12.0 x 8.5 x 5.9	6.8 x 5.75	No.4 Preparation room	3 m
No.4 shielded room	-	4.0 x 6.0 x 2.7	N/A	-	-
No.5 semi-anechoic chamber	-	6.0 x 6.0 x 3.9	6.0 x 6.0	-	-
No.6 shielded room	-	4.0 x 4.5 x 2.7	4.0 x 4.5	-	-
No.6 measurement room	-	4.75 x 5.4 x 3.0	4.75 x 4.15	-	-
No.7 shielded room	-	4.7 x 7.5 x 2.7	4.7 x 7.5	-	-
No.8 measurement room	-	3.1 x 5.0 x 2.7	3.1 x 5.0	-	-
No.9 measurement room	-	8.8 x 4.6 x 2.8	2.4 x 2.4	-	-
No.11 measurement room	-	6.2 x 4.7 x 3.0	4.8 x 4.6	-	-

* Size of vertical conducting plane (for Conducted Emission test) : 2.0 m x 2.0 m for No.1, No.2, No.3, and No.4 semi-anechoic chambers and No.3 and No.4 shielded rooms.

3.6 Test data, Test instruments, and Test set up

Refer to APPENDIX.

UL Japan, Inc.

Ise EMC Lab.

4383-326 Asama-cho, Ise-shi, Mie-ken 516-0021 JAPAN

Telephone : +81 596 24 8999

Facsimile : +81 596 24 8124

SECTION 4: Operation of E.U.T. during testing

4.1 Operating Mode(s)

Mode	Remarks
1) Normal Operation mode	The following operations are performed under the Normal Operation mode. - Communication mode - LED lighting mode - Buzzer ON

4.2 Configuration and peripherals

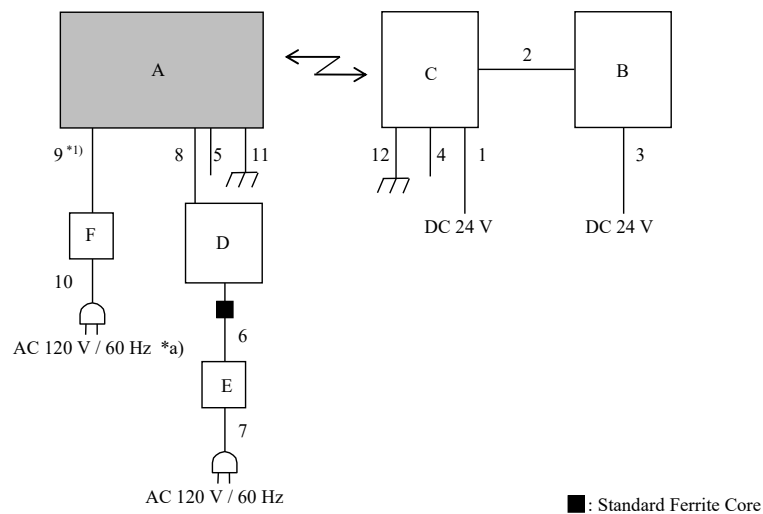

- * Cabling and setup(s) were taken into consideration and test data was taken under worse case conditions.
- *a) Conducted emission test was performed on this port
- *1) DC 24 V is supplied to Item A by DC Cable.

Description of EUT and Support equipment

No.	Item	Model number	Serial number	Manufacturer	Remarks
A	WIRELESS TOWER LIGHT	IT60SW5F-5RYGB WD2U-R	P-38120	M-SYSTEM CO., LTD.	EUT
B	MODBUS I/O MODULE	R7M-DA1-6F-R	8H011863	M-SYSTEM CO., LTD.	-
C	WIRELESS TOWER LIGHT	IT60SW6F-R	P-37231	M-SYSTEM CO., LTD.	-
D	Laptop PC	2672-C2J	99-PPBKH	IBM	-
E	AC Adapter	08K8212	11S08K8212Z1Z7 UB4160FD	IBM	-
F	DC Power Supply	PMC35-2A	13090501	KIKUSUI	for CE

List of cables used

No.	Name	Length (m)	Shield		Remarks
			Cable	Connector	
1	DC Cable	1.5	Unshielded	Unshielded	-
2	Signal Cable	2.0	Unshielded	Unshielded	-
3	DC Cable	1.5	Unshielded	Unshielded	-
4	Signal cable	1.5	Unshielded	Unshielded	-
5	Signal cable	1.5	Unshielded	Unshielded	-
6	DC Cable	1.8	Unshielded	Unshielded	-
7	AC Cable	0.9	Unshielded	Unshielded	-
8	LAN Cable	3.0	Shielded	Shielded	-
9	DC Cable	1.5	Unshielded	Unshielded	-
10	AC Cable	1.5	Unshielded	Unshielded	for CE
11	Earth Cable	1.5	Unshielded	Unshielded	-
12	Earth Cable	1.5	Unshielded	Unshielded	-

*CE : Conducted emission

UL Japan, Inc.

Ise EMC Lab.

4383-326 Asama-cho, Ise-shi, Mie-ken 516-0021 JAPAN

Telephone : +81 596 24 8999

Facsimile : +81 596 24 8124

SECTION 5: Conducted Emission

5.1 Operating environment

Test place : No.1 semi anechoic chamber
Temperature : See data
Humidity : See data

5.2 Test configuration

EUT was placed on a urethane platform of nominal size, 1.0 m by 1.5 m, raised 0.8 m above the conducting ground plane. The rear of tabletop was located 40 cm to the vertical conducting plane. The rear of EUT and its peripherals was aligned and flushed with rear of tabletop. All other surfaces of tabletop were at least 80 cm from any other grounded conducting surface. EUT was located 80 cm from the LISN/AMN and excess AC cable was bundled in center. I/O cables that were connected to the other peripherals were bundled in center. They were folded back and forth forming a bundle 30 cm to 40 cm long and were hanged at a 40 cm height to the ground plane. Each EUT current-carrying power lead, except the ground (safety) lead, was individually connected through a LISN/AMN to the input power source. All unused 50 ohm connectors of the LISN/AMN were resistivity terminated in 50 ohm when not connected to the measuring equipment. Photographs of the set up are shown in Appendix 3.

Frequency range : 0.15 MHz - 30 MHz
EUT position : Table top
EUT operation mode : See Clause 4.1

5.3 Test procedure

The AC Mains Terminal Continuous disturbance Voltage has been measured with the EUT within a semi anechoic chamber. The EUT was connected to a Line Impedance Stabilization Network (LISN)/ Artificial Mains network (AMN). An overview sweep with peak detection has been performed. The measurements have been performed with a quasi-peak detector and if required, with an average detector.

The conducted emission measurements were made with the following detector function of the test receiver.

Detector Type : Quasi-Peak and CISPR AV
IF Bandwidth : 9 kHz

Figure 1: Test Setup

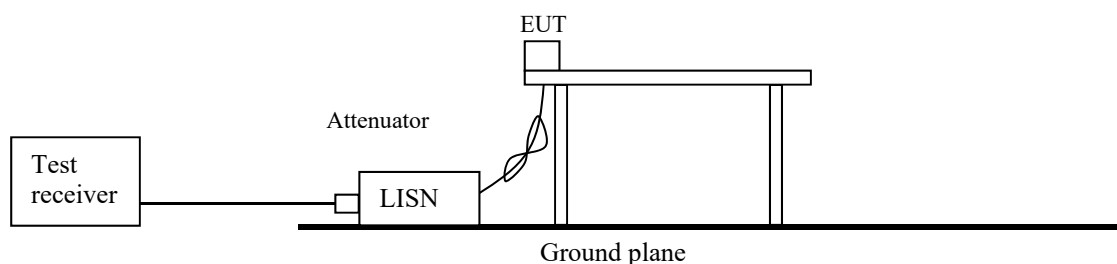

5.4 Test result

Summary of the test results: Pass

The test result is rounded off to one or two decimal places, so some differences might be observed.

Date: February 24, 2019

Test engineer: Ryota Yamanaka

UL Japan, Inc.

Ise EMC Lab.

4383-326 Asama-cho, Ise-shi, Mie-ken 516-0021 JAPAN

Telephone : +81 596 24 8999

Facsimile : +81 596 24 8124

SECTION 6: Radiated Emission

6.1 Operating environment

Test place : No.1 semi anechoic chamber
Temperature : See data
Humidity : See data

6.2 Test configuration

EUT was placed on a urethane platform of nominal size, 1.0 m by 1.5 m, raised 0.8 m above the conducting ground plane. The EUT was set on the edge of the tabletop.

Test was made with the antenna positioned in both the horizontal and vertical planes of polarization. The measurement antenna was varied in height above the conducting ground plane to obtain the maximum signal strength.

Photographs of the set up are shown in Appendix 3.

6.3 Test conditions

Frequency range : 30 MHz - 200 MHz (Biconical antenna) / 200 MHz - 1000 MHz (Logperiodic antenna)
1000 MHz - 10000 MHz (Horn antenna)
Test distance : 10 m (30 MHz - 1000 MHz) / 3 m (1000 MHz - 10000 MHz)
EUT position : Table top
EUT operation mode : See Clause 4.1

6.4 Test procedure

The height of the measuring antenna varied between 1 and 4 m and EUT was rotated a full revolution in order to obtain the maximum value of the electric field intensity.

The measurements were performed for both vertical and horizontal antenna polarization with the Test Receiver.

The radiated emission measurements were made with the following detector function of the Test Receiver.

Frequency	Below 1GHz	Above 1GHz *1)
Instrument used	Test Receiver	Test Receiver
IF Bandwidth	QP: BW 120 kHz	PK: BW 1 MHz, CISPR AV: BW 1 MHz

*1) The measurement data was adjusted to a 10 m distance using the following Distance Factor.

Distance Factor: $20 \times \log(3.6 \text{ m} / 10 \text{ m}) = -8.87 \text{ dB}$

Figure 2: Test Setup

Below 1 GHz

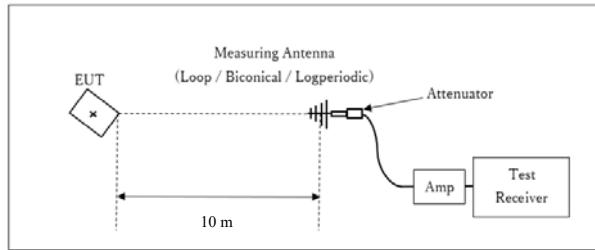

× : Center of turn table

Test Distance: 10 m

1 GHz - 10 GHz

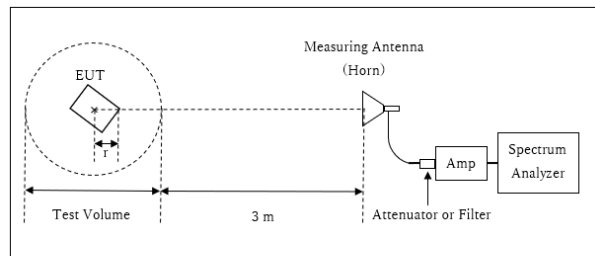

r : Radius of an outer periphery of EUT

× : Center of turn table

Distance Factor: $20 \times \log(3.6 \text{ m}^*/10.0 \text{ m}) = -8.87 \text{ dB}$

* Test Distance: $(3 + \text{Test Volume} / 2) - r = 3.6 \text{ m}$

Test Volume: 2 m

(Test Volume has been calibrated based on CISPR 16-1-4.)

$r = 0.4 \text{ m}$

The test was made on EUT at the normal use position.

6.5 Test result

Summary of the test results: Pass

The limit is rounded down to one decimal place.

The test result is rounded off to one or two decimal places, so some differences might be observed.

Date: February 23 and March 19, 2019

Test engineer: Masaya Minami

APPENDIX 1: Test data

Conducted Emission

Report No. 12615475H
Test place Ise EMC Lab.
Semi Anechoic Chamber No.1
Date February 24, 2019
Temperature / Humidity 20 deg. C / 30 % RH
Engineer Ryota Yamanaka
Mode Mode 1

Limit : FCC_Part 15 Subpart B(15.107)_Class A

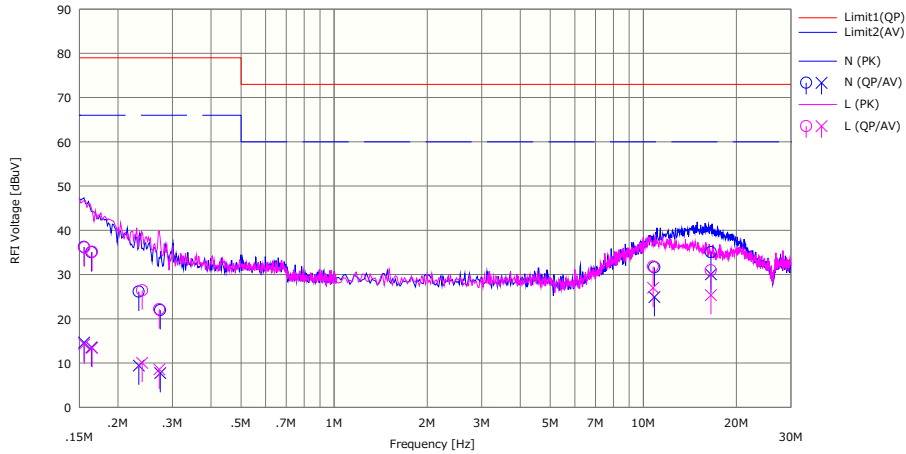

No.	Freq. [MHz]	Reading		LISN [dB]	LOSS [dB]	Results		Limit		Margin		Phase	Comment
		<QP> [dBuV]	<AV> [dBuV]			<QP> [dBuV]	<AV> [dBuV]	<QP> [dB]	<AV> [dB]				
1	0.15525	23.10	1.50	0.05	13.07	36.22	14.62	79.00	66.00	42.78	51.38	N	
2	0.16415	21.90	0.40	0.05	13.08	35.03	13.53	79.00	66.00	43.97	52.47	N	
3	0.23353	13.00	-3.70	0.04	13.10	26.14	9.44	79.00	66.00	52.86	56.56	N	
4	0.27394	8.80	-5.40	0.04	13.10	21.94	7.74	79.00	66.00	57.06	58.26	N	
5	10.86320	17.40	10.70	0.24	13.98	31.62	24.92	73.00	60.00	41.38	35.08	N	
6	16.53680	20.40	15.40	0.43	14.22	35.05	30.05	73.00	60.00	37.95	29.95	N	
7	0.15572	23.00	1.10	0.05	13.07	36.12	14.22	79.00	66.00	42.88	51.78	L	
8	0.16500	22.00	0.30	0.05	13.08	35.13	13.43	79.00	66.00	43.87	52.57	L	
9	0.23960	13.30	-3.10	0.04	13.10	26.44	10.04	79.00	66.00	52.56	55.96	L	
10	0.27205	9.00	-4.60	0.04	13.10	22.14	8.54	79.00	66.00	56.86	57.46	L	
11	10.75220	17.60	12.80	0.23	13.97	31.80	27.00	73.00	60.00	41.20	33.00	L	
12	16.53740	16.30	10.70	0.43	14.22	30.95	25.35	73.00	60.00	42.05	34.65	L	

CHART: WITH FACTOR Peak hold data. CALCULATION : RESULT = READING + C.F (LISN + CABLE + ATT)
Except for the above table: adequate margin data below the limits.

Radiated emission

Report No. 12615475H
Test place Ise EMC Lab.
Semi Anechoic Chamber No.1
Date February 23, 2019
Temperature / Humidity 20 deg. C / 35 % RH
Engineer Masaya Minami
(Below 1 GHz)
Mode Mode 1

LIMIT : FCC15.109(b) (subpart B class A) 10m, below 1GHz:QP, above 1GHz:PK
Except for the data below : adequate margin data below the limits.

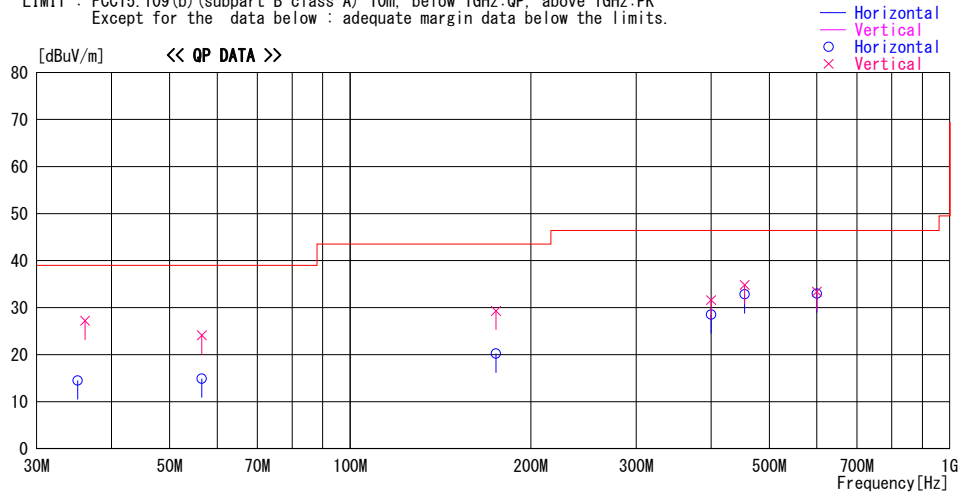

Frequency [MHz]	Reading [dBuV]	DET	Antenna	Loss&	Level	Angle	Height	Polar.	Limit	Margin
			Factor [dB/m]	Gain [dB]						
35.110	29.6	QP	16.4	-31.5	14.5	115	400	Hori.	39.0	24.5
36.132	42.6	QP	16.0	-31.4	27.2	314	100	Vert.	39.0	11.8
56.573	37.3	QP	8.7	-31.1	14.9	8	400	Hori.	39.0	24.1
56.573	46.5	QP	8.7	-31.1	24.1	57	100	Vert.	39.0	14.9
175.000	33.8	QP	16.0	-29.6	20.2	253	400	Hori.	43.5	23.3
175.000	42.9	QP	16.0	-29.6	29.3	8	100	Vert.	43.5	14.2
400.000	39.9	QP	15.7	-27.1	28.5	302	222	Hori.	46.4	17.9
400.000	43.0	QP	15.7	-27.1	31.6	180	100	Vert.	46.4	14.8
454.781	42.8	QP	16.8	-26.8	32.8	65	244	Hori.	46.4	13.6
454.781	44.8	QP	16.8	-26.8	34.8	135	290	Vert.	46.4	11.6
600.003	39.3	QP	19.3	-25.6	33.0	62	183	Hori.	46.4	13.4
600.003	39.7	QP	19.3	-25.6	33.4	202	275	Vert.	46.4	13.0

CHART: WITH FACTOR

ANT TYPE: - 30 MHz: LOOP, 30 MHz - 200 MHz: BICONICAL, 200 MHz - 1000 MHz: LOGPERIODIC, 1000 MHz -: HORN
CALCULATION: RESULT = READING + ANT FACTOR + LOSS & GAIN (CABLE + ATT - GAIN(AMP))

UL Japan, Inc.
Ise EMC Lab.

4383-326 Asama-cho, Ise-shi, Mie-ken 516-0021 JAPAN
Telephone : +81 596 24 8999
Facsimile : +81 596 24 8124

Radiated emission

Report No.	12615475H	
Test place	Ise EMC Lab.	
Semi Anechoic Chamber	No.1	
Date	February 23, 2019	March 19, 2019
Temperature / Humidity	20 deg. C / 35 % RH	22 deg. C / 35 % RH
Engineer	Masaya Minami	Masaya Minami
	1 GHz - 5 GHz	5 GHz - 10 GHz
Mode	Mode 1	

Limit : FCC_Part 15 Subpart B(15.109)_Class A

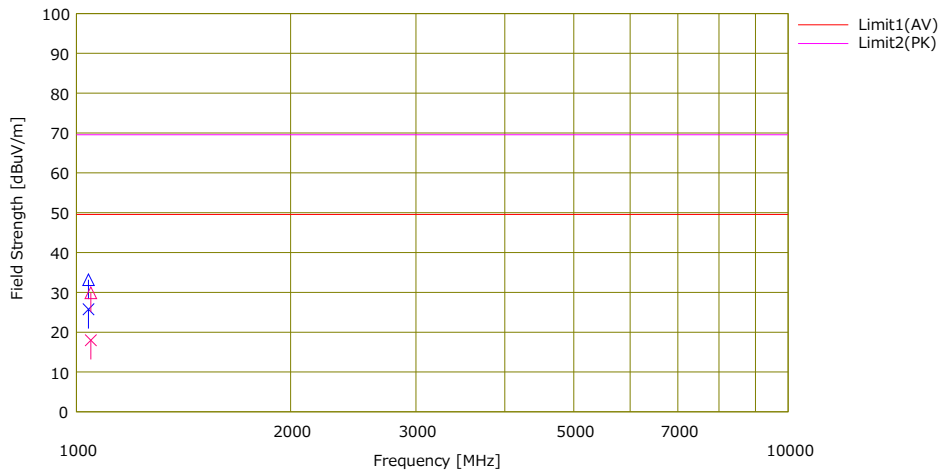

No.	Freq. [MHz]	Reading		Ant.Fac. [dB/m]	Loss [dB]	Gain [dB]	Result		Limit		Margin		Pola. [H/V]	Height [cm]	Angle [deg]	Art. Type	Comment
		<AV> [dBuV]	<PK> [dBuV]				<AV> [dBuV/m]	<PK> [dBuV/m]	<AV> [dBuV/m]	<PK> [dBuV/m]	<AV> [dB]	<PK> [dB]					
1	1040.080	45.30	52.70	24.71	-6.95	37.31	25.75	33.15	49.50	69.50	23.75	36.35	Hori.	110	238	HA5	
2	1048.096	37.70	49.60	24.52	-6.95	37.30	17.97	29.87	49.50	69.50	31.53	39.63	Vert.	100	39	HA5	

CHART: WITH FACTOR

ANT TYPE: - 30 MHz: LOOP, 30 MHz - 200 MHz: BICONICAL, 200 MHz - 1000 MHz: LOGPERIODIC, 1000 MHz -: HORN
CALCULATION: RESULT = READING + ANT FACTOR + LOSS & GAIN (CABLE + Filter - GAIN(AMP) + D-factor)

UL Japan, Inc.

Ise EMC Lab.

4383-326 Asama-cho, Ise-shi, Mie-ken 516-0021 JAPAN

Telephone : +81 596 24 8999

Facsimile : +81 596 24 8124

APPENDIX 2: Test instruments

Test Instruments

Test Item	LIMS ID	Description	Manufacturer	Model	Serial	Last Calibration Date	Calibration Due Date	Cal Int
CE/RE	141530	Digital Tester	Fluke Corporation	FLUKE 26-3	78030621	8/21/2018	8/31/2019	12
CE/RE	141950	EMI Test Receiver	Rohde & Schwarz	ESU26	100412	6/15/2018	6/30/2019	12
CE/RE	141152	EMI measurement program	TSJ	TEPTO-DV	-	-	-	-
CE	141537	LISN(AMN)	Schwarzbeck	NSLK8127	8127-731	7/12/2018	7/31/2019	12
CE	141538	LISN(AMN)	Schwarzbeck	NSLK8127	8127-732	7/12/2018	7/31/2019	12
CE	141290	Attenuator(13dB)	JFW Industries, Inc.	50FP-013H2 N	-	12/27/2018	12/31/2019	12
CE	141925	Terminator	TME	CT-01	-	11/7/2018	11/30/2019	12
CE/RE	141566	Thermo-Hygrometer	CUSTOM	CTH-201	A08Q26	1/11/2019	1/31/2020	12
CE/RE	142226	Measure	KOMELON	KMC-36	-	-	-	-
CE	141215	Coaxial Cable	Fujikura/Suhner/TSJ	5D-2W/3D-2W/ RG400u/ RFM-E421(SW)	-/01068 (Switcher)	6/4/2018	6/30/2019	12
CE/RE	141998	AC1_Semi Anechoic Chamber(NSA)	TDK	Semi Anechoic Chamber 10m	DA-06881	6/18/2018	6/30/2020	24
RE	141213	Attenuator(6dB)	Weinschel Corp	2	BK7971	11/5/2018	11/30/2019	12
RE	141350	Coaxial Cable	Suhner/storm/Agilent/TSJ	-	-	6/4/2018	6/30/2019	12
RE	141264	Logperiodic Antenna(200-1000MHz)	Schwarzbeck	VUSLP9111B	911B-189	6/1/2018	6/30/2019	12
RE	141585	Pre Amplifier	MITEQ	MLA-10K01-B01-35	1237616	2/8/2019	2/29/2020	12
RE	141994	AC1_Semi Anechoic Chamber(SVSWR)	TDK	Semi Anechoic Chamber 10m	DA-06881	4/4/2018	4/30/2019	12
RE	141511	Horn Antenna 1-18GHz	Schwarzbeck	BBHA9120D	253	6/4/2018	6/29/2019	12
RE	141859	Band Rejection Filter(880-915MHz)	TOKYO KEIKI	880-915MHz	-	7/4/2018	7/31/2019	12
RE	141393	Microwave Cable	Junkosha	MWX221	1604S254(1 m) / 1608S088(5 m)	8/8/2018	8/31/2019	12
RE	141576	Pre Amplifier	AGILENT	8449B	3008A01671	2/8/2019	2/29/2020	12
RE	141227	Microwave Cable	Junkosha	MMX221-00500DM SDMS	1502S305	3/12/2018	3/31/2019	12
RE	141198	Biconical Antenna	Schwarzbeck	BBA9106	2513	6/1/2018	6/30/2019	12

*Hyphens for Last Calibration Date, Calibration Due Date and Cal Int (month) are instruments that Calibration is not required (e.g. software), or instruments checked in advance before use.

The expiration date of the calibration is the end of the expired month.

All equipment is calibrated with valid calibrations. Each measurement data is traceable to the national or international standards.

As for some calibrations performed after the tested dates, those test equipment have been controlled by means of an unbroken chains of calibrations.

Test item:

CE: Conducted emission

RE: Radiated emission

UL Japan, Inc.

Ise EMC Lab.

4383-326 Asama-cho, Ise-shi, Mie-ken 516-0021 JAPAN

Telephone : +81 596 24 8999

Facsimile : +81 596 24 8124