

COMPLIANCE MARKS:

IC: 28201-NBIQ2KUS
FCC ID: 2AOT9-NBIQ2KUS
Poppins Logo 6pt

REV No.	REVISION RECORD	DATE	REVR.
R1.9	INITIAL DRAWING	04.01.2023	DM

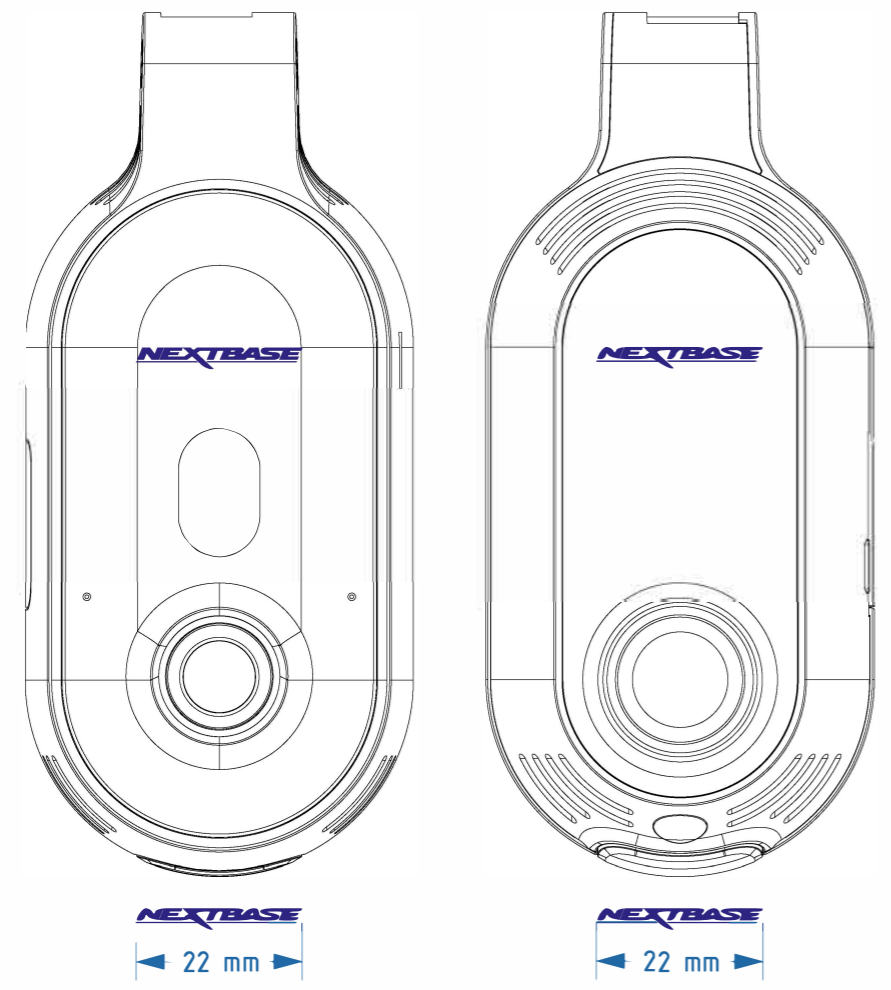
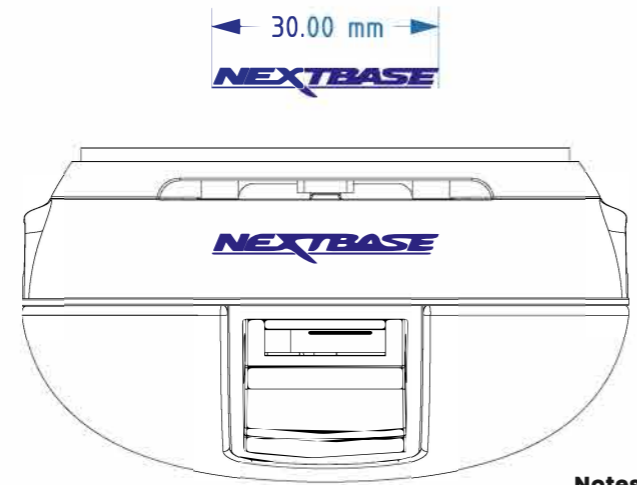

- Notes:**
- 1) REAR CAM, POWER & RESET markings to be applied using diecut label
Black material + PT 877C printing
 - 2) Mount band to match the mount plate & pendant sides
 - 3) Mount Light pipe, to be opaque white (same as IFA) samples

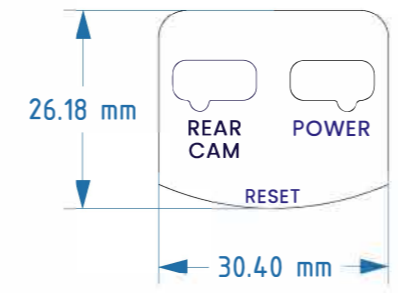
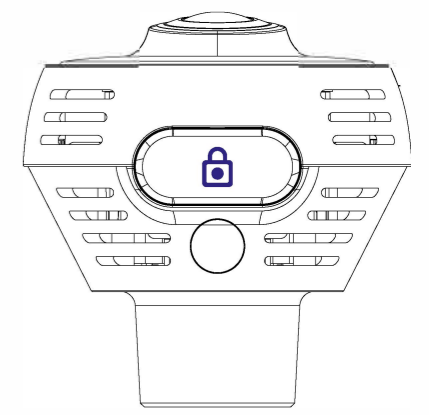
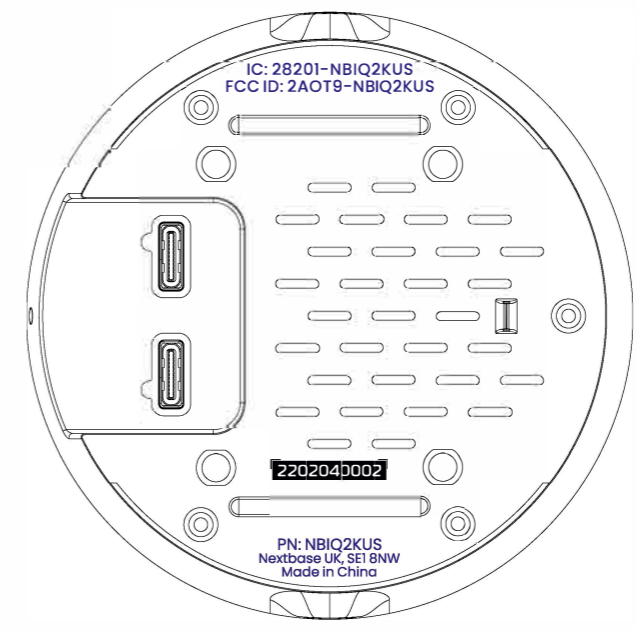
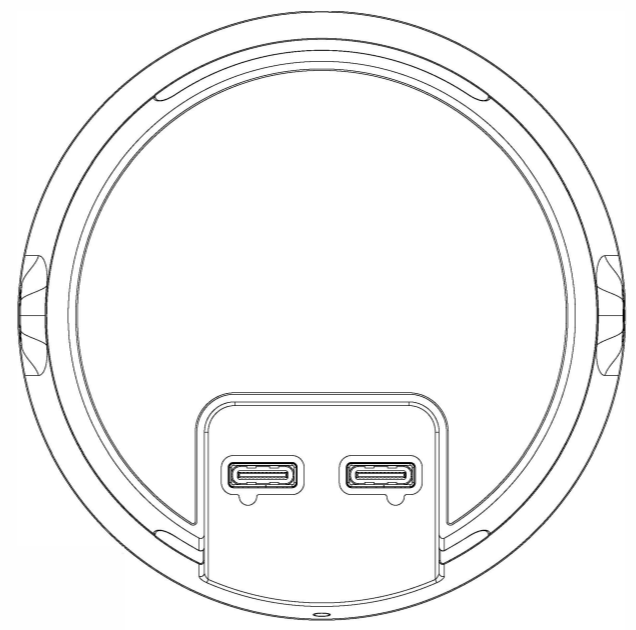

PN: NBIQ2KUS
Poppins (regular) 6pt

Nextbase UK, SE1 8NW
Made in China
Poppins (regular) 5pt

SERIAL NUMBER FORMAT:
2202040002
22 = YEAR
02 = WEEK
04 = MODEL (01=1KEU,02=2KEU,03=4KEU,04=1KUS,05=2KUS,06=4KUS,07=RWC)
0002 = NUMBER
2202040002 15MM X 2.5MM

KEY	FINISH	PROCESS
■	CLEAR	MATERIAL
□	MOLDED	TOOLING
■	GREY	LASER ETCH
■	CLEAR 300A-110	SILKSCREEN
■	PT 427C (GREY)	SILKSCREEN
■	PT COOL GREY 8C	SILKSCREEN
■	PT 000C (WHITE)	SILKSCREEN
■	PT 649C (SILVER)	SILKSCREEN
■	PT COOL GREY 6C	SILKSCREEN
■	PT BLACK	SILKSCREEN
■	PT COOL GREY 7C	SILKSCREEN
■	PT 485C (RED)	SILKSCREEN
■	PT 877C (SILVER)	SILKSCREEN
KEY	COLOUR	APPLICATION

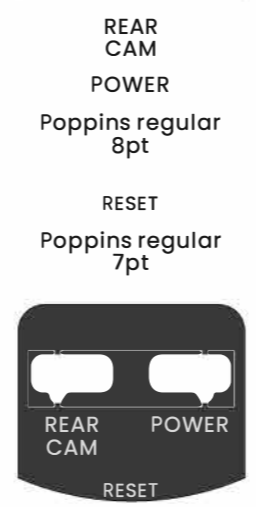

FOR ILLUSTRATION PURPOSES ONLY

DRAWING TYPE	PRODUCT MARKINGS	DRAWING No.	NBIQ2KUS-R1	
NEXTBASE PART No.	NBIQ2KUS	DRAWN BY	D MOORE	04/01/2023
NEXTBASE PART NAME	4G FRONT CAMERA (US) CV28 (BETTER)	CHECKED BY		
BRANDING	NEXTBASE	APPROVED BY		
CUSTOMER	NEXTBASE	ECN No.	N/A	
SHEET: 1 of 1		SCALE	1 : 1	MASS ###g
PRODUCT ENVIRONMENTAL STANDARD: ROHS2		SIZE	A3	MASS TOL. ±#g
TOLERANCES UNLESS OTHERWISE SPECIFIED X=±0.5 .XX=±0.01 .X=±0.1 .XXX=±0.005 ANGLE=±0.1		3RD ANGLE PROJECTION		Portable Multimedia Limited T/A Nextbase Registered office: Floor 6, 230 Blackfriars Road, London, SE1 8NW, United Kingdom Registration: 04038169