

COMPLIANCE MARKS:

IC: 28201-NBIQIKUS
FCC ID: 2AOT9-NBIQIKUS
Poppins Logo 6pt

| | | | |
|---------|-----------------|------------|-------|
| REV No. | REVISION RECORD | DATE | REVR. |
| R1.9 | INITIAL DRAWING | 04.01.2023 | DM |

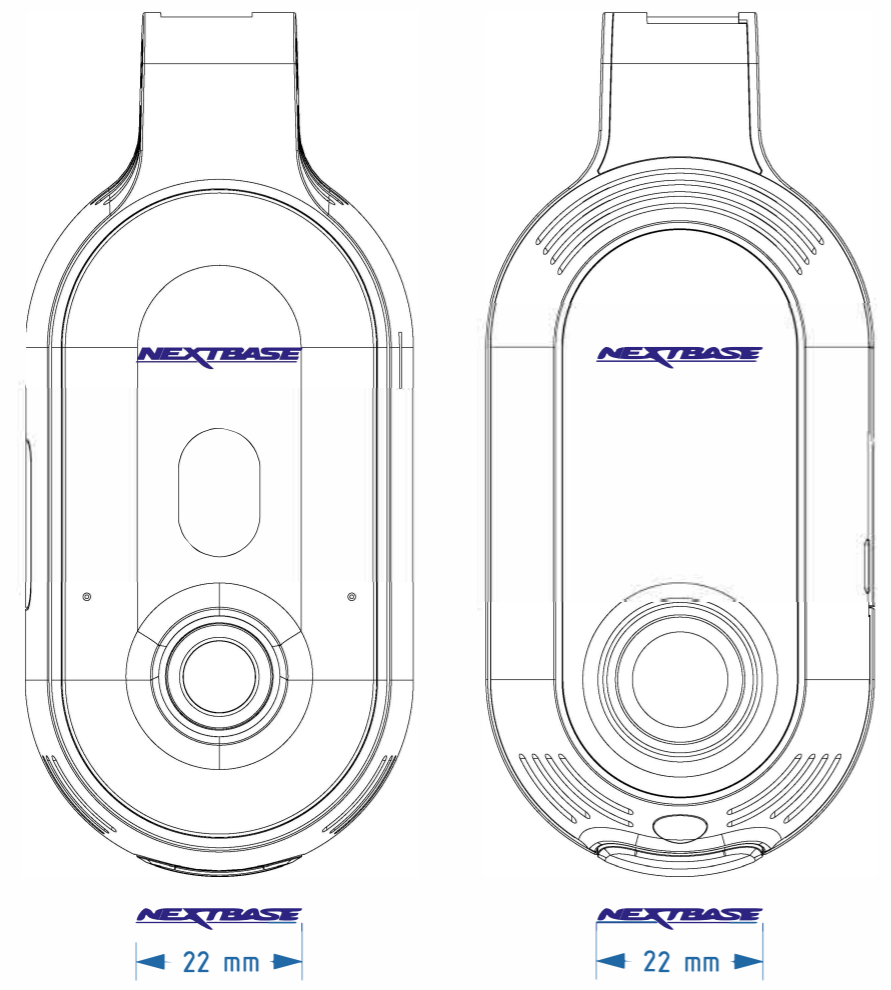
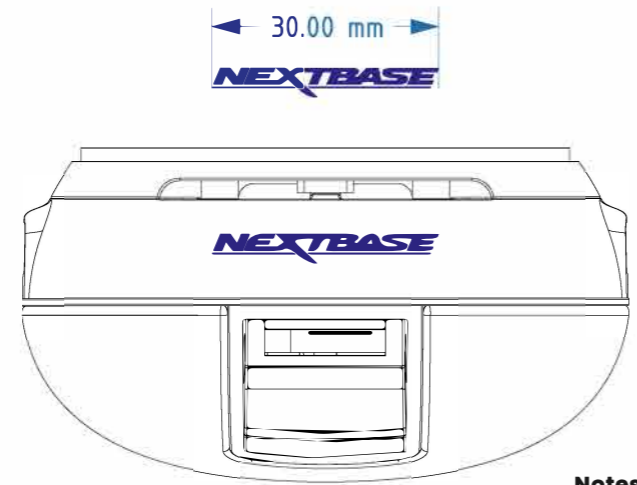

- Notes:**
- 1) REAR CAM, POWER & RESET markings to be applied using diecut label
Black material + PT 877C printing
 - 2) Mount band to be Grey Metallic - PU-207046
 - 3) Mount Light pipe, to be opaque white (same as IFA) samples

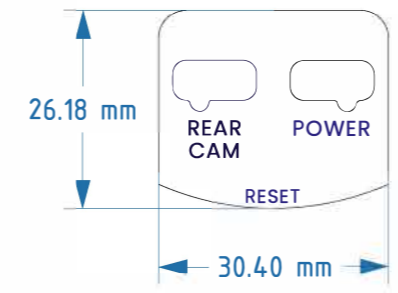
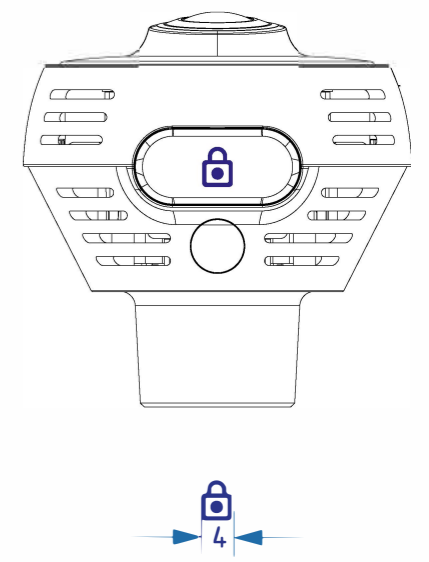
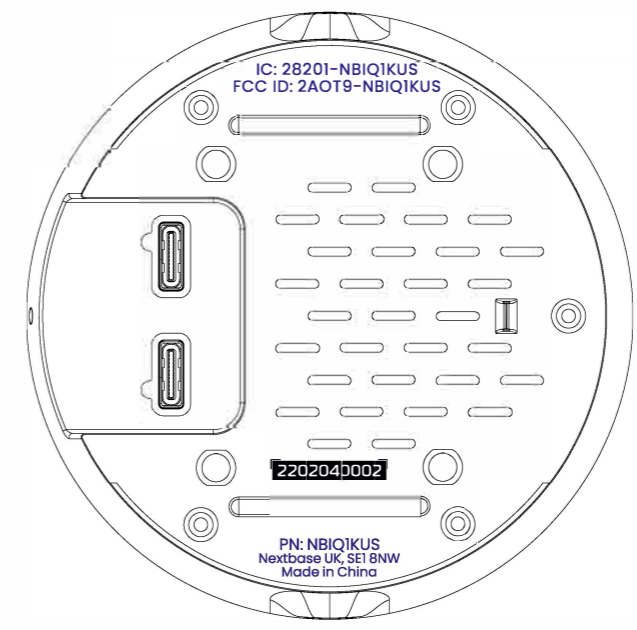
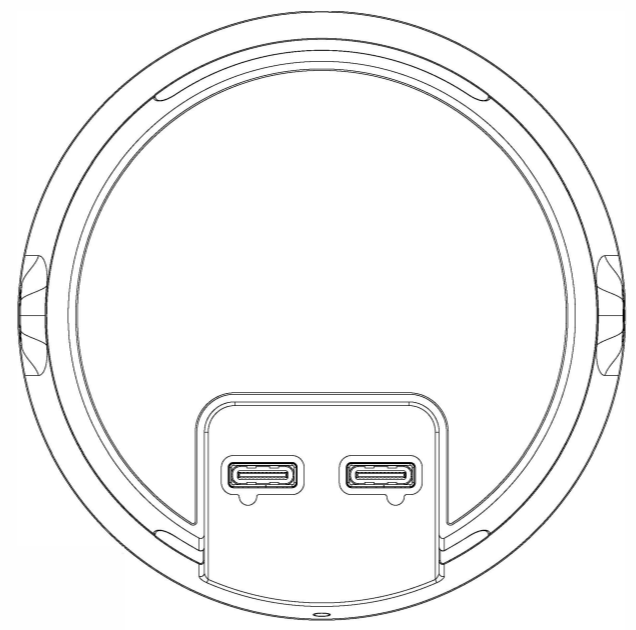

PN: NBIQIKUS
Poppins (regular) 6pt

Nextbase UK, SE1 8NW
Made in China
Poppins (regular) 5pt

SERIAL NUMBER FORMAT:
2202040002
22 = YEAR
02 = WEEK
04 = MODEL (01=1KEU,02=2KEU,03=4KEU,04=1KUS,05=2KUS,06=4KUS,07=RWC)
0002 = NUMBER
2202040002 15MM X 2.5MM

| KEY | FINISH | PROCESS |
|-----|------------------|-------------|
| ■ | CLEAR | MATERIAL |
| □ | MOLDED | TOOLING |
| ■ | GREY | LASER ETCH |
| ■ | CLEAR 300A-110 | SILKSCREEN |
| ■ | PT 427C (GREY) | SILKSCREEN |
| ■ | PT COOL GREY 8C | SILKSCREEN |
| ■ | PT 000C (WHITE) | SILKSCREEN |
| ■ | PT 649C (SILVER) | SILKSCREEN |
| ■ | PT COOL GREY 6C | SILKSCREEN |
| ■ | PT BLACK | SILKSCREEN |
| ■ | PT COOL GREY 7C | SILKSCREEN |
| ■ | PT 485C (RED) | SILKSCREEN |
| ■ | PT 877C (SILVER) | SILKSCREEN |
| KEY | COLOUR | APPLICATION |

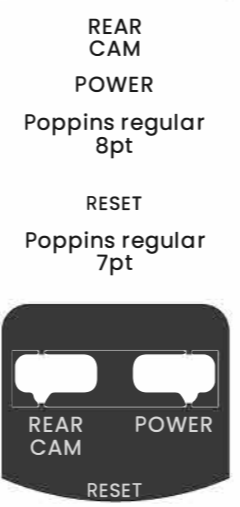

FOR ILLUSTRATION PURPOSES ONLY

| | | | | |
|--|----------------------------------|----------------------|-------------|--|
| DRAWING TYPE | PRODUCT MARKINGS | DRAWING No. | NBIQ1KUS-R1 | |
| NEXTBASE PART No. | NBIQ1KUS | DRAWN BY | D MOORE | 04/01/2023 |
| NEXTBASE PART NAME | 4G FRONT CAMERA (US) CV28 (GOOD) | CHECKED BY | APPROVED BY | |
| BRANDING | NEXTBASE | ECN No. | N/A | |
| CUSTOMER | NEXTBASE | SCALE | 1 : 1 | MASS |
| SHEET: 1 of 1 | | SIZE | A3 | MASS TOL. |
| PRODUCT ENVIRONMENTAL STANDARD: ROHS2 | | UNITS | MM | ±#g |
| TOLERANCES UNLESS OTHERWISE SPECIFIED X=±0.5 .XX=±0.01 .X=±0.1 .XXX=±0.005 ANGLE=±0.1 | | 3RD ANGLE PROJECTION | | Portable Multimedia Limited T/A Nextbase Registered office: Floor 6, 230 Blackfriars Road, London, SE1 8NW, United Kingdom Registration: 04038169 |