

# NBDVR612GW\_User Manual



**612GW** | **4K Elite**  
4K HD Dash Cam with GPS,  
Wi-Fi & Anti Glare Polarising Filter

**iN-CAR CAM**™

## INTRODUCTION TO USING A DASH CAM

The iN-CAR CAM range of Dash Cams have been designed specifically with ease of use in mind, it is recommended NOT to change the default settings, which have been carefully selected to give the best performance for day to day use.

Basic operation:

It is essential that a quality branded U3 type micro SD card is used with this Dash Cam due to the very large data rate generated by 4K recording.

The Dash Cam is set to record video, in files of just 1 minute in length. This means that each video file is a manageable size should you need to download and send to your insurance company. Eventually your MicroSD card will fill up with video files but don't worry, the camera automatically deletes the oldest file to make space for new recordings. This way you never run out of space and have plenty of driving historical evidence saved.

All Video files are recorded in BOTH High resolution and Low resolution simultaneously, with the Low resolution file being ideal for watching on smaller portable devices via Wi-fi.

The Time and Date are automatically set upon the camera from satellite data, based on the Country selected from within the first Time Use menu.

The Time and Date will also update automatically for Daylight Savings Time, again based on the Country selected.

There are 3 modes of camera operation - Video, Photo and Playback.

Video Mode: The default mode when the camera is turned on, for video recording.

Photo Mode: Allows you to take still photographs.

Playback mode: Allows you to view recorded video or photographs upon the Dash Cam LCD screen.

Press the MODE button on the Dash Cam to select required mode.

Automatic Start / Stop Technology. The Dash Cam senses power supplied to the cigarette lighter socket as soon as the vehicle ignition is turned on and will start to record automatically. When the ignition is turned off, the Dash Cam will perform an automatic shutdown process.

1. Tips for capturing best video footage:

- 1.1 Position the Dash Cam in the centre of the windscreen and ideally behind the rear view mirror so it is not a distraction to the driver.
- 1.2 Reduce the amount of sky in the picture, by angling the view of the camera towards the road. Too much sky will make the road appear darker due to the automatic exposure compensation.
- 1.3 Remove unnecessary items from your dashboard. If objects are placed on your dashboard these can cause reflections to be seen on the windscreen and these reflections may be captured during recording.

2. Tips for stable memory card performance:

- 2.1 Format your memory card using the Dash Cam. This will make sure that the card is structured specifically for your camera. Press SETTINGS and choose the Format Card option on the first page. Follow the on-screen instructions accordingly.
- 2.2 Switch off the Dash Cam before removing or inserting the SD memory card, to prevent the chance of damage being caused to the memory card or the files stored upon it.

## TABLE OF CONTENTS

INTRODUCTION TO USING A DASH CAM .....	03
TABLE OF CONTENTS .....	04
PRECAUTIONS .....	05
CAUTIONS ON USING THIS PRODUCT .....	05
PRODUCT SPECIFICATION .....	06
PACKAGE CONTENTS .....	07
PRODUCT FEATURES .....	07
POWERED GPS MOUNT .....	08
CAMERA - PARTS & CONTROLS .....	09
IN VEHICLE INSTALLATION .....	14
FIRST TIME USE .....	18
TOUCH SCREEN .....	19
VIDEO MODE .....	20
PHOTO MODE .....	23
PLAYBACK MODE .....	24
SETTINGS .....	27
PC CONNECTION .....	37
TV CONNECTION .....	38
TROUBLE SHOOTING .....	40

## PRECAUTIONS

Please read this manual carefully before operation and keep it for future reference. It will be helpful should you encounter any operational problem.

**WARNING:** Do not expose this product to rain, moisture or water under any circumstances, doing so may result in the risk of electric shock or fire.

**CAUTION:** To reduce the risk of electric shock, do not perform any servicing other than that contained in the instruction manual unless you are qualified to do so.

Have the unit serviced by a qualified service technician if:

The Unit has been exposed to rain or water.

The unit does not seem to operate normally.

The unit exhibits a marked change in performance.

**LCD:** A Liquid Crystal Display (LCD) screen is a multilayer complex component, containing 691,200 pixels. Pixels can however fail during normal product life. 1 pixel = 0.0001% failure rate, and one pixel failure per year of operation is considered normal and not a cause for concern.

**WEEE:** Disposal of Waste Electrical and Electronic Equipment and/or Battery by users in private households in the European Union.



This symbol on the product or on the packaging indicates that this cannot be disposed of as household waste. You must dispose of your waste equipment and/or battery by handing it over to the applicable take-back scheme for the recycling of electronic equipment and/or batteries. For more information please contact your local household waste disposal office.

## CAUTIONS ON USING THIS PRODUCT

1. Ensure that the windscreen is free of dirt or grease before placing mount upon it.
2. Do not obscure the view of the road ahead or impede the deployment of any airbags in the event of an accident.
3. When not in use, please disconnect the car adaptor from both the 12/24Vdc outlet in your vehicle and the device itself.
4. Only clean the device with a soft dry cloth, for tough dirt, apply some neutral detergent diluted in 5 to 6 parts water to a soft cloth.  
Note that alcohol, thinner, benzene etc could cause damage to the paint or coatings.
5. Avoid making contact with the lens as damage may be caused.
6. If required clean the glass lens carefully using spectacle lens cleaning fluid on a soft cloth only.
7. The video recordings made by this Dash Cam are intended for personal use only.
8. Publication of the recordings on Youtube, the internet or other methods are subject to the Data Protection Act and the requirements thereof must be adhered to.  
If the Dash Cam is to be used within a commercial environment, i.e. truck use, then the CCTV regulation apply also, in addition to the Data Protection Act regulations. This includes labeling to identify the use of CCTV is taking place, the omission of Audio recording and informing the relevant authorities of who controls the data.
9. Video playback upon the device which is visible to the driver is prohibited or restricted in some countries or States. Please adhere to these laws.
10. Whilst driving, do not adjust the controls of your device as this is a distraction to driving.

## PRODUCT SPECIFICATION

Model Number / Name	NBDVR612GW / ELITE
Power Requirements	5V / 1.5A
Power Supply	12-24Vdc Car Power Cable (supplied) Fuse Type: 20mm / 1.5A Output: 5Vdc
Sensor Resolution	8. 57M Pixel
Lens - Type / Angle / Aperture	7G / 150° / F1.6
Recording Resolution	3840 x 2160 @ 30fps & 768 x 432 @ 30fps (default)
Screen Type	Touch (Capacitive)
Screen Size	3.0"
Screen Resolution	960 (W) X 240 (H) pixels x RGB
Screen Ratio	16:9
Card Reader	64-128GB MicroSD Card
SD Card (Recommended Type)	64-128GB MicroSD Card, U3 type, for best results use a recognized brand <b>Please note, a U3 MicroSD Card is required for 4K recording</b>
SD Card Recorded file Capacity (based on default settings)	64GB MicroSD = 200 minutes of recording 128GB MicroSD = 400 minutes of recording
Recording Format	MP4
Video / Audio Out	High Definition: Type C Socket (Video / Audio)
Internal Battery	Lithium-ion 3.7V / 260mAh (approx. 15mins recording time) Battery design allows the 'Auto Power Off' feature to function in event of power loss within the vehicle. It is not intended as an alternative power source to replace the supplied car adaptor.
Unit Dimensions	97 x 59 x 42mm
Unit Weight	151g

Android is a trademark of Google Inc. in the United States and other countries.

Mac is a registered trademark of Apple Inc. in the United States and other countries.

iOS is a trademark or registered trademark of Cisco in the United States and other countries.

Windows is a registered trademark of Microsoft Corporation in the United States and other countries.

Exmor R is a trademark of Sony Corporation.





NEXTBASE Replay 3 is a registered trademark of Portable Multimedia LTD in the United Kingdom.

NEXTBASE Cam Viewer is a registered trademark of Portable Multimedia LTD in the United Kingdom.

© 2015 Google Inc. All rights reserved. Google Maps™ mapping service is a trademark of Google Inc.

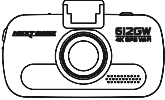
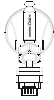
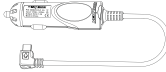
## PACKAGE CONTENTS

Please check the contents of your NEXTBASE product.

<p><b>Dash Cam</b></p> 	<p><b>Powered GPS Mount</b></p>  <p>(adhesive mount included)</p>	<p><b>Car Power Cable</b></p> 	<p><b>USB Cable</b></p> 
<p><b>Window Sticker</b></p> 	<p><b>Quick Start Guide</b></p> 	<p><b>Instruction Manual &amp; Software Disk</b></p> 	

Product appearance may differ slightly to that shown above.

## PRODUCT FEATURES

Thank you for purchasing this NEXTBASE Dash Cam, in this section we will outline some of the features available with this Dash Cam.

### 3.0" LCD Colour Touch Screen

LCD touch screen for ease of use and viewing the playback of recorded videos and photos.

### Powered GPS Mount

Supplied with an Easy-fit powered mount, which allows the Dash Cam to be fitted and removed quickly and easily. The car power cable can remain in place, connected to the mount.

### GPS Logger

GPS co-ordinates and also time and date are recorded. The journey can then be viewed using the supplied NEXTBASE Replay 3™ Windows & Mac playback software.

The software is also available to download from [www.nextbase.co.uk](http://www.nextbase.co.uk)

### Wi-Fi Connectivity

Connect your smartphone or tablet device to the Dash Cam wirelessly. Use your smartphone to Start/Stop recording or to view or download files from the Dash Cam.

### G Sensor / File Protection

In the event of an impact, a separate additional 30 seconds of protected recording will be saved within the 'Protected' folder on the memory card.

This 30 second recording contains the 10 seconds prior to the protection taking place and the following 20 seconds thereafter.

### Intelligent Parking Mode

The Dash Cam will power on automatically and record 30 seconds of video, when physical movement of your vehicle is detected.

### Polarising filter

This Dash Cam incorporates a polarising filter to reduce windscreen glare and reflection.

### Auto Dimming

Once enabled, the screen will automatically dim during night-time driving.

## POWERED GPS MOUNT

Please see below to identify the parts of the supplied powered mount.

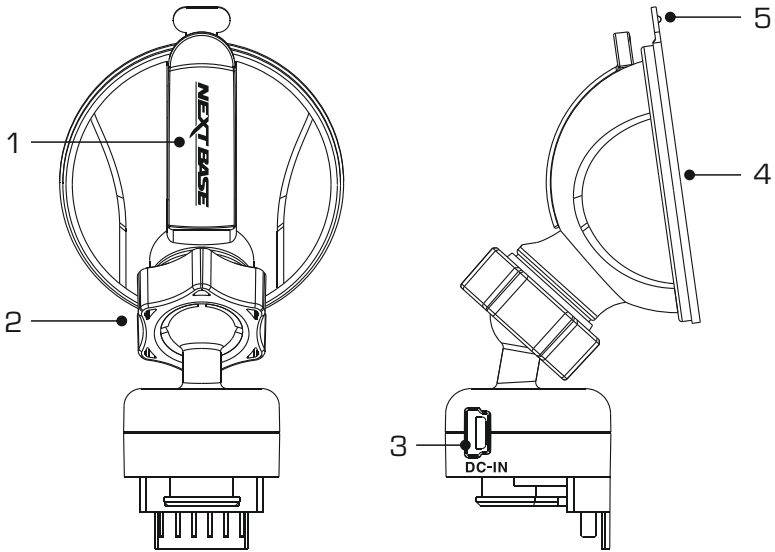

**1. Locking lever**

The locking lever is used to attach and release the window mount to your vehicles windscreen. Pull the lever down to prepare the window mount for use. Once the mount is firmly upon the windscreen (in a suitable location) push the lever to lock the mount in place.

**2. Locking ring**

Loosen the locking ring to adjust the Dash Cam position if required, remembering to re-tighten before use.

**3. DC-IN socket**

Connect the supplied car power cable here.

**4. Suction cup**

This is used to attach and release the window mount to your vehicles windscreen. Affix to a clear piece of windscreen where there is no paint effect applied.

**5. Suction release tab**

Once the locking lever has been opened use this release tab to break the seal between the mount and windscreen.

## CAMERA - PARTS & CONTROLS

Please see below to identify the parts and controls of your Dash Cam.

Front:

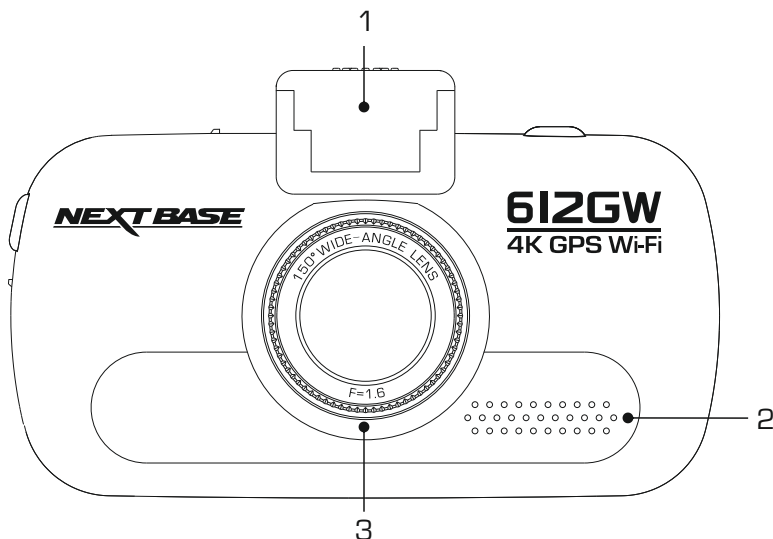

**1. Mounting point (located under the dust cover)**

After removing the dust cover, attach the supplied powered GPS mount here.

**2. Speaker**

Integral speaker for audio playback directly from the Dash Cam.

**3. Polarising filter**

This Dash Cam incorporates a polarising filter to reduce windscreen glare and reflection, often seen on recordings.

In bright sunlight the filter will also enhance the colour and contrast levels to help capture important number plate detail.

The filter has a rotating bezel, so you can adjust the polarising filter exactly how you need in your vehicle.

To set the polarising filter, place a piece of paper on your dashboard below the rear view mirror, but away from the windscreen. With the camera turned ON, you will see the reflection of the paper in the LCD screen of the Dash Cam. Rotate the front ring of the polarising filter to reduce reflection to the lowest possible level. This dramatically improves the recorded image quality.

Note:

- Do not place fingers on the glass lens of the filter.
- Do not adjust the filter whilst in control of the vehicle.



## CAMERA - PARTS & CONTROLS (CONTD.)

Back:

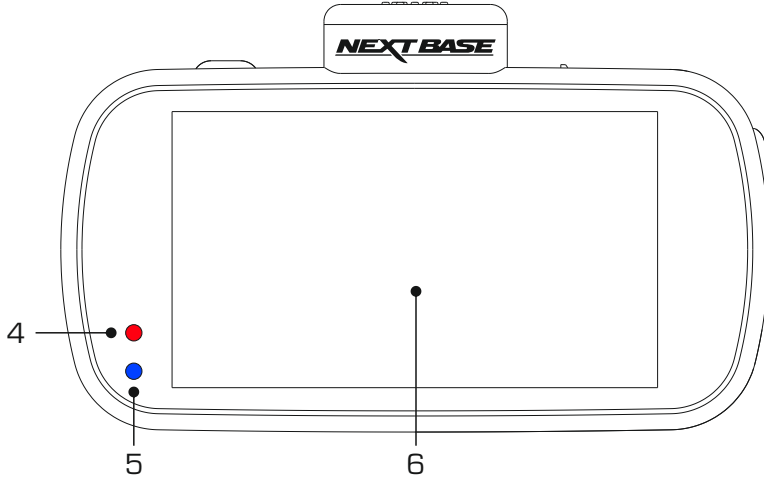

### 4. Red Power / Recording LED

This red LED will be lit when the Dash Cam is turned ON. During recording the LED will flash.

### 5. Blue Battery LED

This blue LED will be lit when the internal battery is charging, once fully charged the LED will go out.

Note:

- This Dash Cam uses Negative Temperature Coefficient (NTC) technology to protect the battery. This will shut down battery charging should the Dash Cam's internal temperature exceed 70degrees.

This can happen during normal use and is not a cause for concern.

When the NTC is active the on screen battery icon will be seen as: 

Charging will resume once the Dash Cam has returned to an acceptable internal temperature.

### 6. Touch Screen

The 3" touch screen makes the operation of the Dash Cam very easy, simply touch the screen to open the main menu. It is from the main menu that the various modes and settings of the Dash Cam can be accessed.

## CAMERA - PARTS & CONTROLS (CONTD.)

Top:

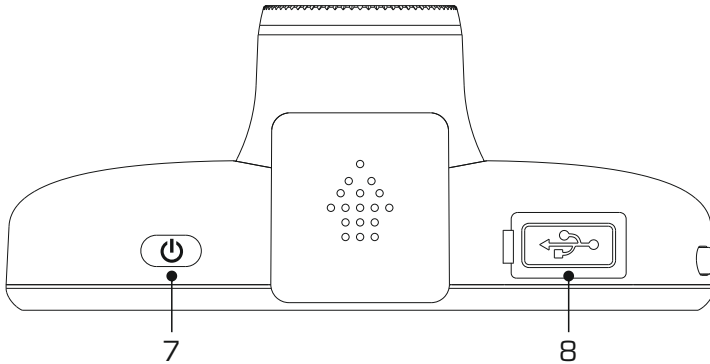

**7. Power On / Off**

Press and hold for 2 seconds to turn on / off the Dash Cam.

**8. DC-IN & USB socket (located under the dust cover)**

Connect the supplied car power cable or USB data cable here.

Note:

- Normally the car power cable is connected to the mount when in use, not directly to this socket.

## CAMERA - PARTS & CONTROLS (CONTD.)

Bottom:

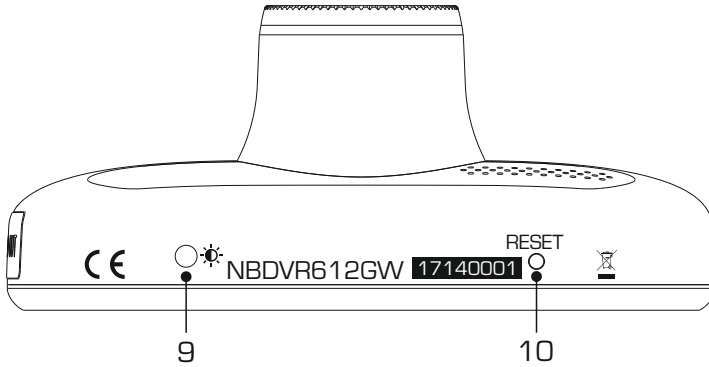

**9. Light sensor**

Detects the ambient light level and will adjust the screen brightness accordingly. Turned on and off within the Settings Menu.

**10. Reset button**

In the unlikely event the Dash Cam becomes unresponsive, press the RESET button to restart the Dash Cam.

## CAMERA - PARTS & CONTROLS (CONTD.)

Sides:

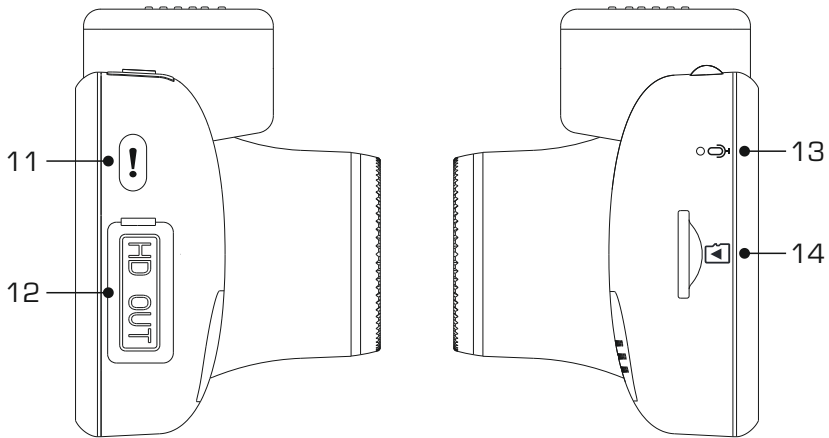

### 11. Protect button

Press whilst recording to protect the current file in event of an emergency situation.

If file protection is activated during recording by using the Protect button (or automatically by the G Sensor), an additional 30 seconds protected recording will be saved within the 'Protected' folder on the memory card.

This 30 second recording contains the 10 seconds prior to the protection taking place and the following 20 seconds thereafter.

Note:

- The original recording will also be saved to the memory card as usual.

### 12. HD Output (located under the dust cover)

Used to connect your Dash Cam to a television using an HD Cable (sold separately).

### 13. Microphone

Integral microphone for audio recording.

### 14. MicroSD Card slot

Insert the MicroSD card here, taking care that the gold contacts are facing towards the back of the Dash Cam.

## IN VEHICLE INSTALLATION

Please follow the instructions below for first-time installation of the Dash Cam. For day to day use simply remove the camera from the mount as required.

### 1. Insert MicroSD Card

Insert a suitable U3 standard MicroSD in to the Dash Cam, taking care that the gold contacts are facing towards the LCD screen side of the Dash Cam. Push the memory card until it clicks into place.



Note:

- Use the edge of a small coin (or similar object) to push the memory card in place if required. Take care that card has 'clicked' into place, a second push inwards will release the memory card.
- Do not remove or insert the memory card when the Dash Cam is turned on. This may damage the memory card.

### 2. Remove dust cover from Dash Cam

Remove the dust cover that is located on the top of the Dash Cam to gain access to the mounting point.

To remove the dust cover, slide it forwards away from the LCD screen of the Dash Cam.

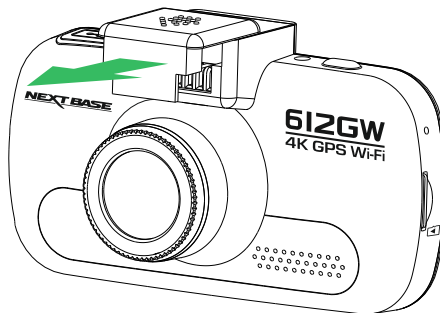

Note:

- If the Dash Cam is not to be used for a period of time please replace the dust cover to help keep the metal contacts free of dust or other contaminants.

**IN VEHICLE INSTALLATION (CONTD.)****3. Attach the mount to the Dash Cam**

Slide the Dash Cam onto the mount. Once attached magnets within the mount will hold the two parts together.

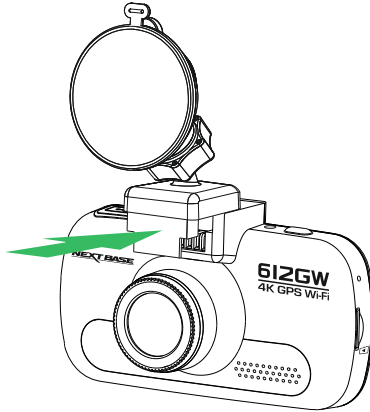
**4. Attach the mount to the windscreen**

Remove the protective plastic film from the suction cup of the mount.

Select a suitable position for the mount and clean the windscreen with a dry / clean cloth to achieve a good contact between the glass and suction cup.

Release the locking lever of the mount by pulling down and then whilst holding the suction cup onto the glass push the lever up to secure the mount to the windscreen.

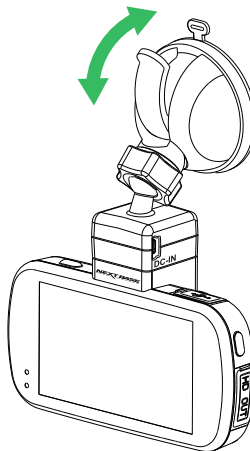

To use the supplied adhesive mount, simply unscrew the locking ring and pull the mount apart. Replace the sucker mount, remembering to tighten the locking ring securely.

Note:

- Choose a smooth glass area without painted effect.
- Please ensure that once mounted the Dash Cam will be located within the area of the vehicles windscreen wipers to maintain a clear view during rainfall.

**IN VEHICLE INSTALLATION (CONTD.)****5. Connect car power cable**

Route the supplied car power cable (as shown) and connect it to the DC-IN socket of the mount.

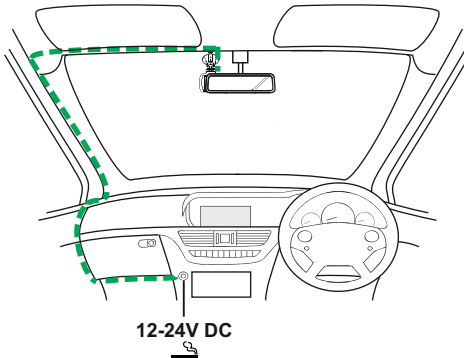

*The above diagram is for illustration purposes only.*

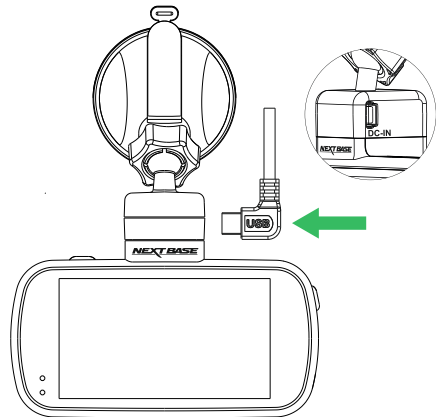

The Dash Cam will automatically power on and start recording once power is available. In some vehicles this will be when connections are made, for others the Dash Cam will power on once the ignition has been turned on.

If the vehicle in which the Dash Cam is installed has permanent live cigarette lighter sockets, the user can simply use the power button to switch the Dash Cam off when the vehicle stops. To take advantage of the Automatic Start / Stop Technology a Nextbase Hardwire Kit can be installed on a switched-live power supply.

The Nextbase Hardwire Kit includes the necessary 12-24Vdc to 5Vdc convertor and battery protection circuitry.

Should your vehicle not have a 12-24Vdc outlet, but does have a 5Vdc USB Outlet, this can be used instead. Connect the USB cable supplied with your Dash Cam in place of the car power cable.

You **MUST** however connect the USB cable to the mount, **NOT** directly to the Dash Cam USB socket.

**Note:**

- Do **NOT** wire the Dash Cam directly to a 12V supply by cutting the cigarette plug off the end of the cable, or damage will result.

## IN VEHICLE INSTALLATION (CONTD.)

Please read and follow the notes below for the safe operation of your Dash Cam within your vehicle.

As per the installation instructions, you must install the Dash Cam so it does NOT obstruct the drivers view of the road, preferably on the passenger side of the vehicle and behind the rear view mirror. Whilst the Dash Cam clearly needs to view through the windscreen in an area swept by the windscreen wipers, the Dash Cam should be installed so as not to intrude significantly within the wiped area. A 40mm intrusion into the green wiped area is the maximum permitted by law.

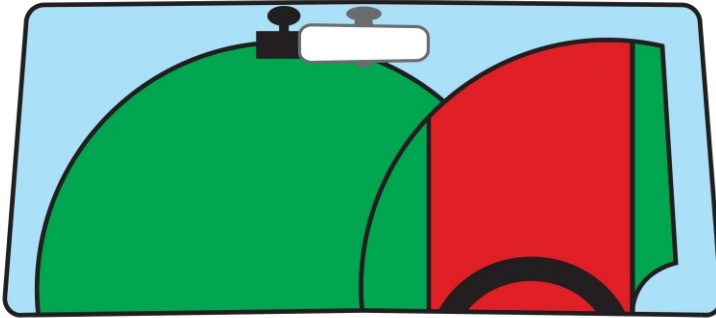

Do NOT mount the Dash Cam in front of the driver, as depicted by the red area in the above illustration.

When installing the Dash Cam in a vehicle, always place the device securely against the windscreen and where possible conceal the power cable under trim. Make sure that the Dash Cam power cable does not interfere with the drivers operating controls, such as the steering wheel, pedals or gear levers.

Do NOT mount the Dash Cam in front of an airbag field of deployment or in a position to obscure any mirrors.

Clean the windscreen at the point of location, prior to fitting the Dash Cam, also, applying some moisture to the suction cup may be beneficial, to ensure absolute adhesion.

It is recommended NOT to operate the Dash Cam whilst driving. The automatic Start-Stop technology incorporated within the device negates any need to operate the controls whilst driving.

Adjust any settings or review recordings whilst stationery, not whilst driving.

Only use your mobile device whilst stationery, not whilst driving.

After the preliminary SETUP has been carried out upon the Dash Cam, adjust the Screen Saver setting to On, this will blank the screen automatically shortly after starting the vehicle and therefore the screen will NOT be a distraction in any way to the driver.



## FIRST TIME USE

To ensure the set up of this Dash Cam is as quick and simple as possible, there is an easy to follow 'First Time Use' menu.

This menu is used to set your preferred Language, Country (this defines your time zone) and speed units.

The menu is available when -

- 1) The Dash Cam is first turned on.
- 2) There has been a firmware update applied to the Dash Cam.
- 3) After the Dash Cams settings have been reset, by using the 'Defaults Settings' option within the Setup Menu.

Simply follow the on screen instructions, tapping the touch screen to select your preferred Language, Country and Speed Unit options.

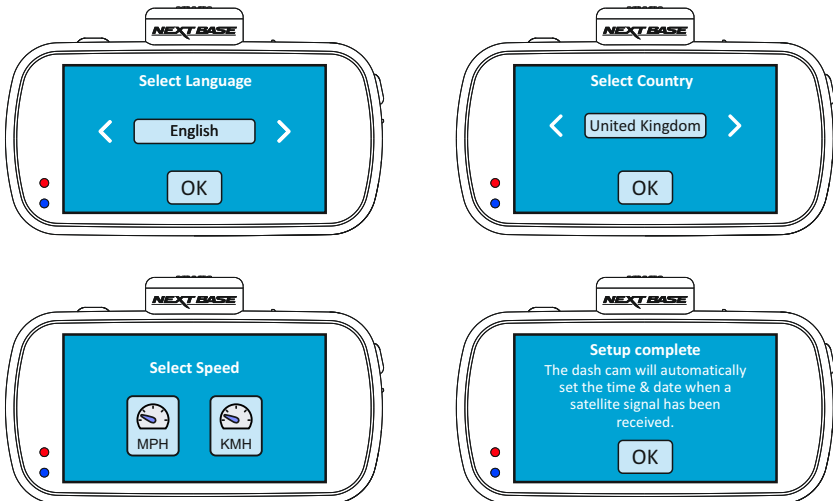

Once the First Time Use menu has been completed the Dash Cam will then open in Video mode and be ready for use.

The default settings within the Dash Cam have been set to allow you to use the Dash Cam without the need to change any settings.

Note:

- The settings that influence the device time & date will be applied upon receiving a GPS connection.
- Whilst the First Time Use menus adjust the settings within the Dash Cam, the settings can still be adjusted thereafter, by using the normal Setup Menu options. Changing country location is one such example of a change you could make, after the First Time Use setup.

## TOUCH SCREEN

This Dash Cam uses a capacitive touch screen, this makes the operation very easy.

Firstly turn on the Dash Cam, by either connecting the supplied car adaptor via the GPS mount or by pressing the power button located on the top of the housing.

Once the Dash Cam has powered on tap the screen anywhere to open the 'Main Menu' screen, as shown below.

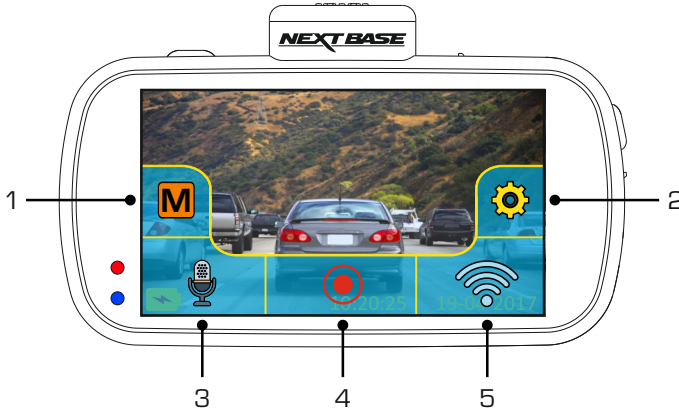

It is from the 'Main Menu' screen that the key functions, the modes and the settings of the Dash Cam can be accessed.

The five options within the 'Main Menu' screen are as follows:

**1. Mode**

Tap here to open the Mode select screen, from which you can then choose from video, photo or playback modes.

**2. Settings**

Tap here to open the Settings menus. For further information on the various settings, please see pages 27 to 36. Note: The settings menus are not available during recording.

**3. Audio recording**

Tap to turn off and on the microphone when recording videos.

**4. Record button**

Tap to start and stop recordings.

**5. Wi-Fi button**

Push and hold for 3 seconds to turn on Wi-Fi mode.

The home screen will close automatically after 4 seconds, if the touch screen is not used.

Note:

- Capacitive displays can be controlled with very light touches of a finger and generally cannot be used with a mechanical stylus or a gloved hand.

## VIDEO MODE

Once the Mode select screen is open, select Video mode by tapping the video icon.

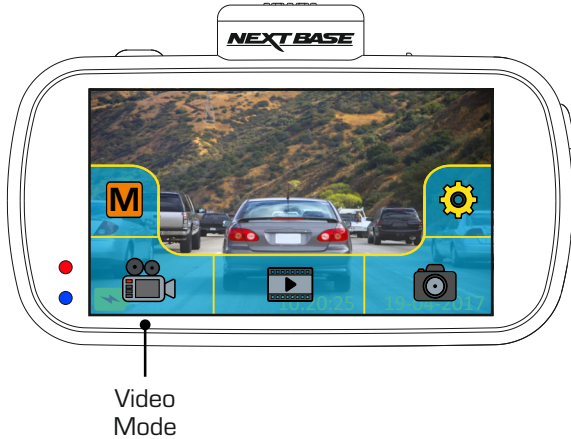

See below for details of the various icons seen on screen when in Video mode.

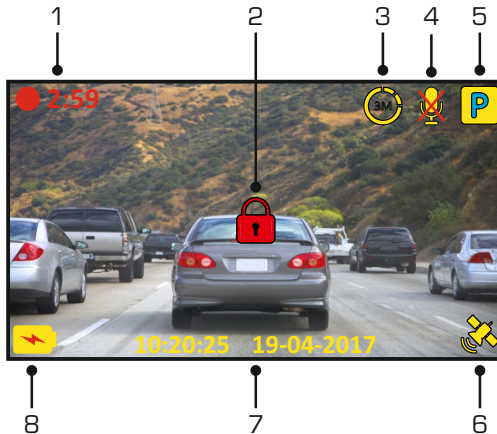

**1. Recording**

Seen on screen during recording.

**2. Protected**

Seen on screen when the current recording has been protected, either by activation of the G Sensor or by pressing the protect button on the side on the Dash Cam.

Continued on next page.

## VIDEO MODE (CONTD.)

See below for details of the various icons seen on screen when in Video mode.

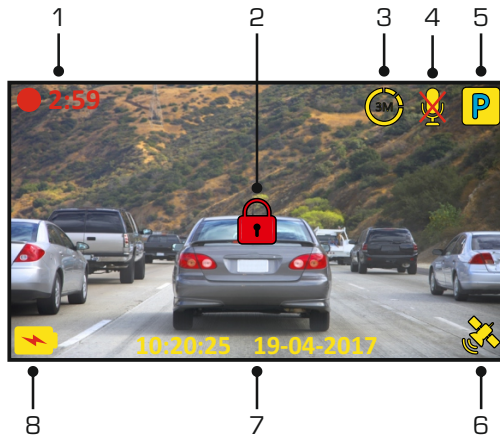

### 3. Time Lapse recording

Seen on screen during Time Lapse recording.

### 4. Audio recording

Seen on screen when the microphone is turned off.

### 5. Parking mode

Seen on screen when Parking Mode has been turned on.

### 6. GPS status

Displays the current status of satellite connection, the icon is colour-coded dependant on the strength of the connection.

Yellow flashing = not connected, searching for available satellites.

Yellow = connected, weak connection with  $\leq 3$  satellites.

Orange = connected, average connection with 4 satellites.

Green = connected, strong connection with  $\geq 5$  satellites.

### 7. Time & Date

Displays the current time & date.

### 8. Battery Status

The charging symbol is seen on screen when the battery is charging. A battery status indicator is shown when the Dash Cam is running from the internal battery.

See the Settings pages within this manual for further information on each function.

## VIDEO MODE (CONTD.)

Tapping the screen when in Video mode will open the 'Main Menu' screen, from where you can start & stop recordings and turn off & on the audio recording by tapping the relevant icons.

The 'Main Menu' screen will disappear after 4 seconds, simply tap once more to re-open.

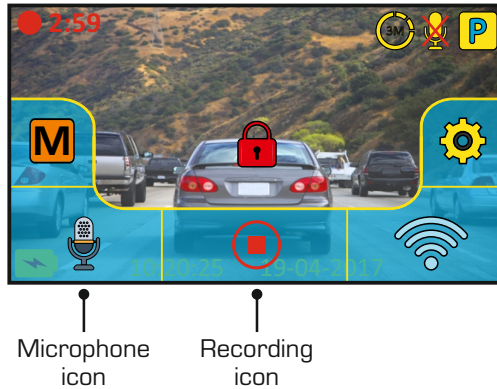

The default settings within the Dash Cam have been set to allow you to use the Dash Cam without the need to change any settings.

Should you wish to change any settings then tap the screen to open the 'Main Menu' and then tap the Settings icon.



For further information on the various settings, please see pages 27 to 36.

Note:

- The settings menus are not available during recording.

## PHOTO MODE

Once the Mode select screen is open, select Photo mode by tapping the camera icon.

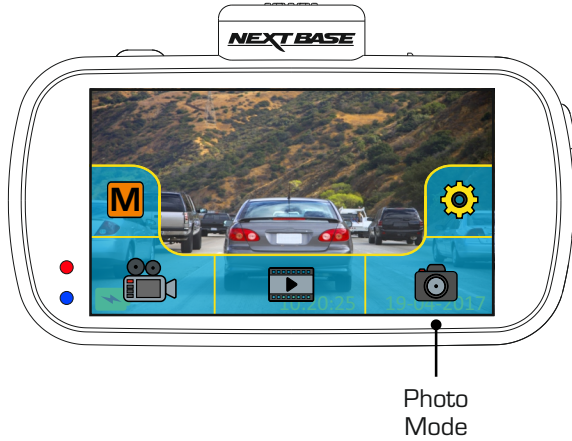

Once photo mode has been selected, then you are ready to take photos by tapping the red shutter release icon.

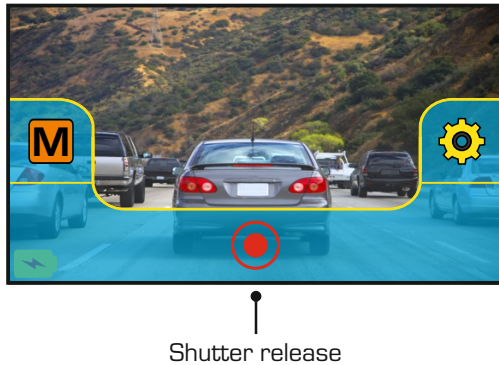

Unlike the other modes the controls will remain on screen whilst in photo mode, this is so the shutter release icon is readily available to take the photograph you want.

Photos taken will be saved in the Photos folder within the SD card directory.

## PLAYBACK MODE

Once the Mode select screen is open, select Playback mode by tapping the playback icon.

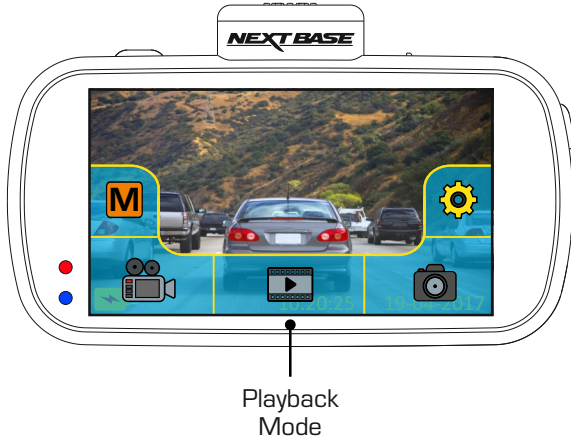

Recordings and photos will be saved in one of three folders: Protected Videos, Videos and Photos.

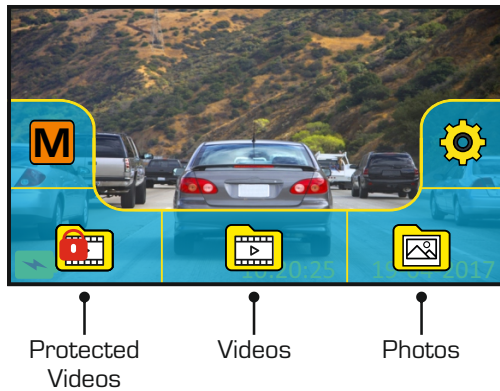

### 1. Protected

This folder will contain the 30 second recordings that have been created by either G Sensor activation or by-pressing the Protect button manually, during recording.

### 2. Videos

This folder contains normal recordings.

### 3. Photos

This folder contains photos.

Simply tap the required folder to view the files within.

## PLAYBACK MODE (CONTD.)

Video playback:

When viewing recordings within playback mode, there are the standard controls one would expect to see, such as play, pause, stop, etc.

There are also some advanced functions such as deleting unwanted files and protecting recordings so they cannot be accidentally deleted.

Once the required folder has been selected, recordings will be seen in the 'preview' screen, as shown below.

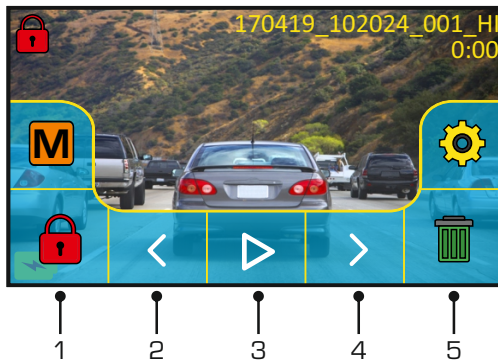

### 1. Protect

This can be used to protect the current recording, thus preventing it from being deleted accidentally or over-written as part of the card looping logic. Playback must be paused before the recording can be protected and /or unprotected.

Note:

- This will not change the file location, for example the newly protected file will remain in the original 'Video' folder.

### 2. Previous

View the previous recording.

### 3. Play

Start and pause playback.

### 4. Next

View the next recording.

### 5. Delete

Delete the current recording. There will be an additional confirmation message to prevent files from being deleted accidentally.

Note:

- The controls close automatically after 4 seconds, if the touch screen is not used. Tap the screen to re-open the last seen controls.



## PLAYBACK MODE (CONTD.)

During playback:

Once playback has been started by tapping the play icon, the controls will refresh to giving you the pause, fast forward and stop icons, as seen below.

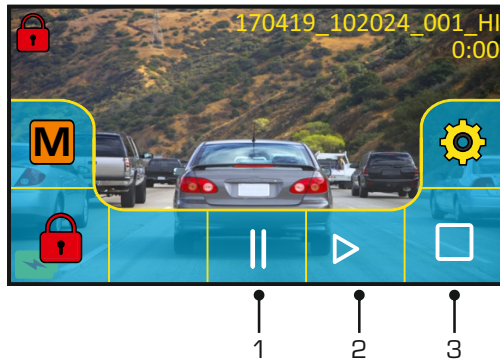

### 1. Pause

Tap once during playback to pause, press again to resume playback.

### 2. Fast forward

Tap to fast forward playback (x2, x4), pressing a third time will return to normal playback.

### 3. Stop

Tap to stop playback

Paused playback:

Once playback has been paused the controls will refresh, as seen below.

Whilst paused the file can be protected by tapping the protect icon.

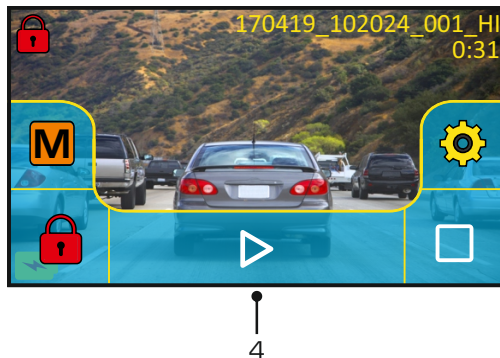

### 4. Play

Tap to resume playback.

Note:

- The controls close automatically after 4 seconds, if the touch screen is not used. Tap the screen to re-open the last seen controls.

## SETTINGS

How to use the Settings:

There are 5 settings screens in total, these screens are numbered from 1 - 5. Each screen contains 6 settings and 3 navigation controls. See below example which shows the first settings screen.

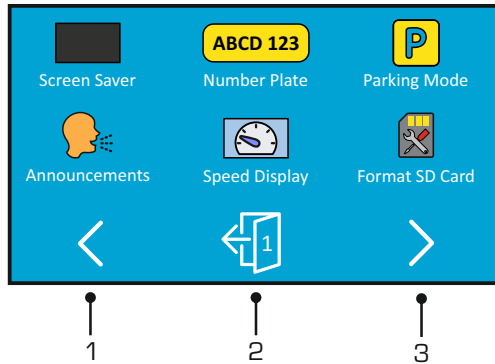

### 1. Previous settings screen

Move to the previous settings screen, this can also be used to move directly to screen 5 from the opening settings screen number 1.

### 2. Exit

Tap to exit settings and return to video mode

Note:

- The screen number is seen as the door number.

### 3. Next settings screen

Move to the next settings screen.

Tap on the required option to open the settings, there are two types of options:

Type 1: Tap only

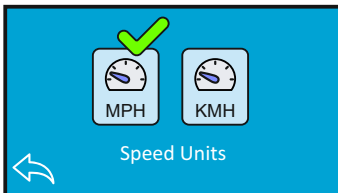

A green tick marks the current setting, simply tap on the required setting to change.

Type 2: Using selection arrows



Use the left & right arrows to select the required field and use the up & down buttons to make selection.

Use the back button at the bottom of the screen to return to the previous settings screen.

## SETTINGS (CONTD.)

Screen 1:

This screen includes the following settings:

Screen Saver, Number Plate, Parking Mode, Announcements, Speed Display and Format SD Card

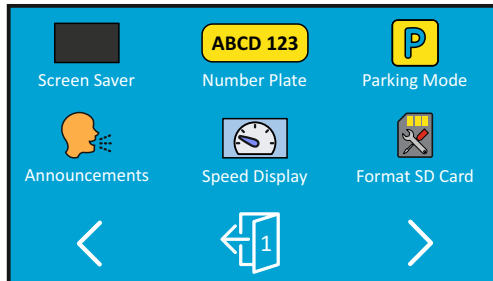

### 1. Screen Saver

Turn on the Screen Saver function to shut down the screen after 30 seconds of button inactivity, tap the screen to re-activate the display.

Options: On and Off  
Default Setting: Off

### 2. Number Plate

Enter the registration number for your vehicle, this will then be shown upon the recorded video file.

### 3. Parking Mode

When Parking Mode has been turned on, the Dash Cam enters standby mode when the 12Vdc supply has been turned OFF (typically removing your ignition key).

Should physical movement of the vehicle be detected, the Dash Cam will power on and start recording a 30 second protected video. If no further physical movement is detected then the Dash Cam will return to standby mode, if physical movement is detected subsequently, then the camera will continue to record normally, i.e. driving once more.

Options: On and Off  
Default Setting: Off

## SETTINGS (CONTD.)

Screen 1: continued

### 4. Announcements

Turn Off / On the spoken Announcements.

The spoken announcements provide an audible confirmation of the button that has been pressed and its function. The announcements also serve as positive confirmation after a file has been protected due to G-Sensor activation during recording.

Options: On and Off  
Default Setting: Off

Note:

- Announcements are currently only available in English.
- Turning on Announcements will turn off the Device Sounds.

### 5. Speed Display

When turned on, the screen will display current speed after 30 seconds of button inactivity, tap the screen to return to normal viewing, this function is only available when a GPS connection is present.

Options: On and Off  
Default Setting: Off

### 6. Format SD Card

Format the inserted memory card. This will delete all content upon the SD card.

Note:

- For stable performance, it is recommended that you format the memory card every 2 weeks.
- Of course, you should only do this AFTER you've downloaded any files from the card that you may want to keep.

## SETTINGS (CONTD.)

Screen 2:

This screen includes the following settings:

Resolution, Exposure, Video Length, Time Lapse, Dual Files and Audio

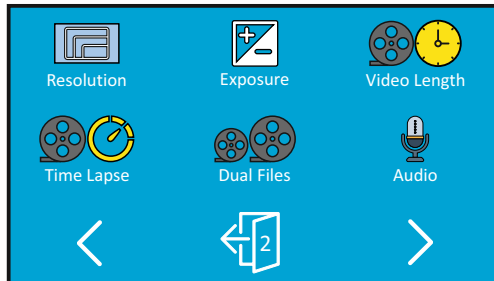

### 1. Resolution

Select recording resolution of the High resolution file, this will increase or decrease the quality of the recorded video.

Options: 4K, 1440P 60FPS, 1440P, 1080P 60FPS and 1080P

Default Setting: 4K

### 2. Exposure

Adjust exposure level for different light conditions.

Options: +2, +1, 0, -1 and -2

Default Setting: 0

### 3. Video Length

Select the duration of the individual recorded video files. The Dash Cam will continue recording, filling the memory card. When the memory card becomes full, the oldest file will be automatically deleted to make space for the new recording.

Options: 1 Minute, 2 Minutes and 3 Minutes

Default Setting: 1 Minute

## SETTINGS (CONTD.)

Screen 2: continued

### 4. Time Lapse

Time Lapse recording is a technique whereby the frequency at which file frames are captured (frame rate) is lower than that used when playing back the recording.

Time Lapse recording can be considered the opposite of slow motion, as when the recording is played back time appears to be moving faster.

For example, a recording taken over three minutes would be played back as a 30 second movie.

Options: 3 Minutes, 30 Minutes and Off  
Default Setting: Off

Note:

- It is recommended to use a high-capacity SD Card (min 64GB) for Time Lapse recording.
- Time lapse is considered as a leisure activity setting and not for use in order to collect evidence in the case of an incident / accident. Time Lapse should be turned off for normal driving conditions.
- The options of 3 Minutes and 30 Minutes are the recording durations, NOT the playback time. Playback time will be 1/6th of the live recording time.

### 5. Dual Files

During normal recording there will be two files saved to the SD Card, one will be the full sized High Resolution recording (example: 3840 x 2160) and the other is a Low Resolution recording (768 x 432). The Low resolution file can be turned On/Off with this setting.

The two recorded files can be identified by the filenames:  
170419\_102024\_001\_HI.MOV and 170419\_102024\_001\_LO.MOV

Both files will be treated as a single recording by the Dash Cam, in regards file protection and deletion.

The Low Resolution recording is used when streaming recordings from the Dash Cam to the CAM Viewer™ APP, this reduces any buffering that may be seen if the full-sized High Resolution recording is used.

Note:

- Only the larger High Resolution recordings will have the Stamps, GPS Location, Speed etc.

Options: On and Off  
Default Setting: On

### 6. Audio

Turn On / Off the microphone.

Options: On and Off  
Default Setting: On

**SETTINGS (CONTD.)**

Screen 3:

This screen includes the following settings:

Time Stamp, Speed Stamp, GPS Stamp, Model Stamp, Screen Dimming and Rotate Display

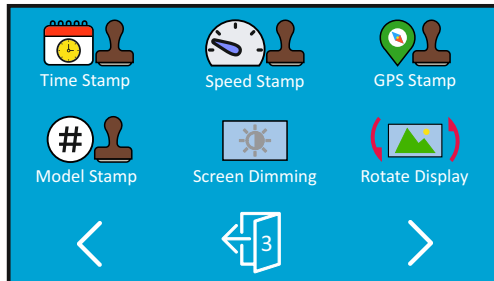
**1. Time Stamp**

Turn On / Off the time and date stamp shown on recorded files.

Options: Off and On

Default Setting: On

**2. Speed Stamp**

Turn On / Off the Speed Stamp shown on recorded files.

Options: On and Off

Default Setting: On

**3. GPS Stamp**

Turn On / Off both the GPS co-ordinates and speed stamp that are shown on recorded files. When a recording is viewed using the supplied NEXTBASE Replay playback software both the GPS co-ordinates and speed information remain available.

Options: On and Off

Default Setting: On

## SETTINGS (CONTD.)

Screen 3: continued

### 4. Model Stamp

Turn On / Off the Model stamp shown in the bottom left corner of recorded files.

Options: On and Off

Default Setting: On

### 5. Screen Dimming

Turn Off / On the automatic screen brightness, when driving in low level light conditions.

Options: On and Off

Default Setting: On

### 6. Rotate Display

Rotate the display 180°, particularly useful should the Dash Cam be mounted on the dashboard, the Dash Cam control button functions do not rotate.

Options: On and Off

Default Setting: Off



## SETTINGS (CONTD.)

Screen 4:

This screen includes the following settings:

Language, Country, Time Zone / DST, Time & Date, Speed Units and Auto power Off

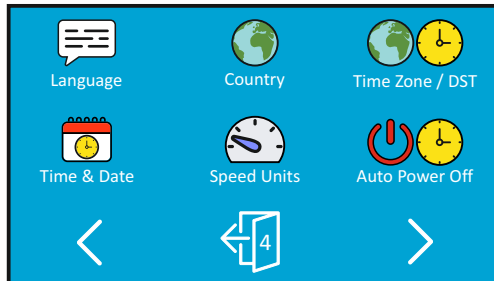

### 1. Language

Select preferred language.

Options: English, Danish, German, Spanish, French, Italian, Dutch, Norwegian, Finnish and Swedish

Default Setting: English

### 2. Country

Select your current Country, this will then automatically adjust the Time Zone / DST setting to your Time Zone, i.e. if France is selected the Time Zone will become GMT +1.

If your required Country is not available, select 'Other'. This will take you to the 'Time Zone / DST' menu, from there you can manually select your Time Zone.

Options: United Kingdom, Belgium, Denmark, Finland, France, Germany, Italy, Netherlands, Norway, Poland, Spain, Sweden and Other

Default Setting: United Kingdom

### 3. Time Zone / DST

The Time and Date are set automatically upon satellite connection, based on the Country selected from within the First Time Use menu.

The Time Zone / DST options are used should you want to manually select a Time Zone that falls outside of the available Country options.

## SETTINGS (CONTD.)

Screen 4: continued

### 4. Time & Date

The Time and Date are set automatically upon satellite connection, based on the Country selected from within the First Time Use menu.

### 5. Speed Units

Select whether to record and display speed in KMH or MPH.

Options: KMH and MPH

Default Setting: MPH

### 6. Auto Power Off

Adjust the timing of the Auto Power Off function, this can be used to continue recording in event of loss of power within the vehicle.

Options: 10 Seconds, 1 Minute and 2 Minutes

Default Setting: 10 Seconds

## SETTINGS (CONTD.)

Screen 5:

This screen includes the following settings:

GPS Info, SD Card Info, System Info, G Sensor, Device Sounds and Default Settings

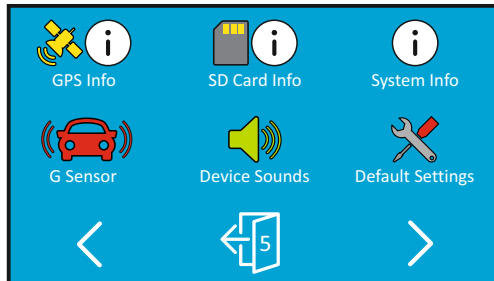

### 1. GPS Info

Displays current status of the Satellite: Satellite System and Satellite Lock

### 2. SD Card Info

Displays current status of the SD Card: File System, Capacity, Used Space, Free Space

### 3. System Info

Version:

The installed software version of your Dash Cam is displayed here.

Wi-Fi Info:

View the SSID (network name) and Password of your Dash Cam.

### 4. G Sensor

Turn Off or adjust the sensitivity of the built in G Sensor. The G Sensor detects forces which will automatically protect the current recording in event of a collision.

Note:

- This does not affect Parking mode sensitivity.

Options: High, Medium, Low and Off

Default Setting: Medium

### 5. Device Sounds

Turn Off / On the beep sound which is heard when a button is pressed and also mute the startup and shutdown chimes.

Options: On and Off

Default Setting: On

### 6. Default Settings

Reset the Dash Cam to the default settings.

## PC CONNECTION

Use the supplied USB cable to connect the Dash Cam directly to your PC via the  socket, do NOT connect the USB cable to the Powered Mount.

Once connected the Dash Cam will power on with three options available, as shown below.

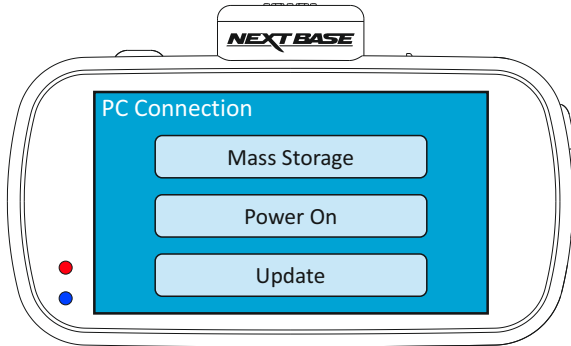

Tap the required option to select required function.

### Mass Storage (Windows)

When this option is selected, the Dash Cam will function as a card reader for your PC. An extra drive will appear, e.g. Removable Disk [D:] and you will be able to view / manage the stored files upon the MicroSD card within the Dash Cam.

Note:

- The Dash Cam is a 'read-only' device, therefore uploading files to the SD card when in Mass Storage mode is not possible.

Turn off the camera before disconnecting from your computer.

### Mass Storage (Mac)

When this option is selected, the Dash Cam will function as a card reader for your MAC. The Dash Cam will be seen as an external disk upon your MAC and you will be able to view and/or manage stored files.

Note:

- The Dash Cam is a 'read-only' device, therefore uploading files to the SD card when in Mass Storage mode is not possible.

Turn off the camera before disconnecting from your computer.

Continued on next page.

## PC CONNECTION (CONTD.)

Continued from previous page.

### **Power On (Windows & Mac)**

When this option is selected, the Dash Cam will power on with all functions available. This includes charging of the internal battery, a full charge will take approximately 2 hours.

Note:

- ALWAYS turn Off the Dash Cam before disconnecting from your computer.

### **Update (Windows and Mac)**

When this option is selected, it is for use with the NEXTBASE Replay 3 Playback software in order to update the firmware within the Dash Cam to the latest version.

Please see details within the NEXTBASE Replay 3 Playback software for more information.

## TV CONNECTION

The Dash Cam can be connected to an external display by using the HD Out socket, this is to allow the viewing of recordings directly from the Dash Cam on a large television.

When you connect a compatible High Definition cable (sold separately) between the Dash Cam and your television, the Dash Cam screen will blank. This is normal, as all output is now visible upon your television.

Please contact your local NEXTBASE dealer for accessory purchases.

Please note that recording is NOT available whilst using the HD Out function.

Note:

- Turn off the Dash Cam before disconnecting the HD cable.
- An external power supply may be required when viewing recordings via the HD output of the Dash Cam, e.g. using the supplied USB cable with a 5Vdc/USB adaptor, of the type typically supplied with mobile phones.
- ENSURE that any external power sources are of the correct 5Vdc output, otherwise damage will be caused that is not covered under the manufacturer's warranty.

## TROUBLE SHOOTING

PROBLEM	SOLUTION
The sucker will not stay in place upon my windscreen.	Ensure that the protective cover (plastic film) has been removed from the suction pad. Moisten the sucker slightly before affixing upon the windscreen. Ensure that the locking lever is fully open when the sucker is pushed on to the windscreen and then close the lever. Make sure that the glass is smooth and clean. Do not stick to glass that has any non-smooth effect or paint whatsoever. Affix to the glass firmly and then close the locking lever fully.
The Touch screen does not respond.	The touch screen is of the Capacitive type, these are controlled with light touches of a finger and generally cannot be used with a mechanical stylus or a gloved hand.
I cannot insert the MicroSD card.	MicroSD card are very small and require delicate use. Align the card with the diagram shown upon the Dash Cam and insert the card until you feel a slight spring resistance. You now need to push the card, using your finger nail, until you hear and feel a small latch. Release pressure and the card will stay retained within the device. Use the edge of a small coin if you have difficulty.
I cannot remove the MicroSD card.	With the card previously installed, you now need to push the card further inwards slightly, using your finger nail, until you hear and feel a small latch. Use the edge of a small coin if you have difficulty. Release pressure and the card will spring out sufficiently for you to take hold of it.
I can only record a few minutes of video on my MicroSD card.	Change the recording size (Video Length function) to a smaller size. Increase the size of the U3 type MicroSD card. Max 128GB.
I cannot save files to the memory card when the Dash Cam is connected to my computer under Mass Storage mode.	Correct, the Dash Cam is a 'read-only' device. It is not recommended to save files from other sources to the same memory that you will use for recording within the Dash Cam, as these may have a negative effect on the performance of the Dash Cam.
No power to my Dash Cam, but it works upon my PC.	The cigarette power cable is not working. Inspect the fuse in the Car Power plug. Replacement fuse = 2A 20mm type. If the fuse is found to be blown, inspect the power cable for damage which may have caused the fuse blow.
My Dash Cam shuts down by itself after a while.	Either the battery has gone flat, there is no power to the Dash Cam and the Auto Power Off period has been triggered or Parking Mode has been turned on and no vehicle movement has been detected for 5 minutes.
The screen blanks after a few minutes upon my Dash Cam.	The screen saver is set to ON. Change settings to OFF if required. Default setting is off.
The battery will not charge.	Ensure the Dash Cam is connected to a reliable power source and that the supplied Car Power Cable is being used, with the Power LED lit.

## TROUBLE SHOOTING (CONTD.)

PROBLEM	SOLUTION
The battery only last 30 seconds.	The battery will only receive charge when the Dash Cam is connected to power, please reconnect the car adaptor or domestic USB charger and leave the Dash Cam to charge. Charging takes approximately 90 minutes and a full charge is indicated when the BLUE [charging] LED goes out.
The battery only lasts 12 minutes.	This is normal, the battery design allows the 'Auto Power Off' feature to function in event of power loss within the vehicle. It is not intended as an alternative power source to replace the supplied car adaptor.
The Dash Cam cannot lock onto satellite.	After power on and with the device mounted with clear view of the sky it can take up to 10 minutes to find the three satellites required to achieve a stable signal. Reception can also be affected by atmospheric conditions and the proximity of buildings / trees obscuring the sky.
I get the message "SD Card Error. Please format SD card" on screen.	The SD card has been formatted in another device and the Cluster Size is not compatible. There may also be an error on the card. Use the Setup option to re-format the SD card from within the Dash Cam. Ensure that the SD card is a U3 type SD card of 64-128GB
I get the message "Card Full" on screen.	The SD card has become full. Delete unnecessary files or perform a full FORMAT upon the SD card from within the Dash Cam Settings Menu.
The SD card in my Dash Cam cannot be read.	Use a good quality branded SD card between 64GB and 128GB Type U3 and format the card from within the Settings Menu.
I can't delete files on my SD card within the Dash Cam.	Check to see if these files are 'protected', if so please follow instructions to 'un-protect'.
Mass Storage function does not work.	The Mass storage function will work on both Windows and Mac. Restart the PC, as this may be required for the necessary driver to be loaded correctly. Disconnect and reconnect the Dash Cam. Contact NEXTBASE for the required driver.
Video files cannot be played.	The video files from the Dash Cam are in .MP4 format and may not be compatible with your PC if suitable playback software is not installed.
Video Image is blurred.	Remove the protective lens cover, clean the lens, adjust the polarising filter correctly, clean the windscreen!



**TROUBLE SHOOTING (CONTD.)**

PROBLEM	SOLUTION
Video file playback is jumpy.	Remove the SD card and reformat to remove non-contiguous files. For best recording use a quality branded U3 type SD card of 64 to 128GB recommended size. PC may not be sufficient for the playback task, try a different PC. Copy the recorded video files onto the PC / Mac for playback directly rather than use the Dash Cam as a card reader, as the USB system on your PC may be too slow for 4K UHD video playback. Reduce the resolution of the recording within the Dash Cam and record some new files to test if this is the problem.
The sound is not synchronised with video during playback.	The Codecs upon your PC may not be compatible or the latest standard. Download the latest Codecs from: <a href="http://www.nextbase.co.uk">www.nextbase.co.uk</a>
Video has no sound.	Ensure that "Audio" setting is turned ON within the Settings of the Dash Cam.
Video playback is really quick on my PC, not consistent with the drive that was recorded.	Turn off the Time Lapse Recording within the Settings of the Dash Cam.
Photograph is blurred.	Hold the camera still whilst taking the photo. Please be aware the photo is taken around 1 second after the shutter noise is heard.
I have turned on 'Parking Mode' and now can't stop the recording.	The Dash Cam will start a recording whenever motion is detected. To turn off Parking Mode firstly shutdown the Dash Cam and remove the SD card, this will avoid recording being activated accidentally. Switch the Dash Cam On and within the Settings Menu, turn off the 'Parking Mode'.
When I get in to my car, the Dash Cam is already recording and the file is protected.	This is normal. Parking Mode has been switched on and the Dash Cam has sensed vibration and has started to record correctly. Parking mode can be turned off within the Settings menu if required.
The time on my Dash Cam is wrong and when I adjust the time manually, it keeps changing.	The Dash Cam sets the time based upon the country which has been selected and also whether Daylight Savings time is currently in force. Please verify the Country setting within the menu is correct. The Time Zone can be set manually, if the Dash Cam is to be used outside the listed countries in the Settings menu.
Downloading files from <a href="http://www.nextbase.co.uk">www.nextbase.co.uk</a> using Google Chrome results in a Malicious Software message.	This is not a cause for concern, simply go to the settings within Google Chrome and turn off the malicious software protection temporarily to download and install the playback software. Reinststate previous Google Chrome settings thereafter.

**TROUBLE SHOOTING (CONTD.)**

PROBLEM	SOLUTION
My Mobile Device will not connect to my camera.	Please ensure that you have turned the Dash Cam Wi-fi Mode on by either using the Wi-fi button or through the Settings Menu. When Wi-fi Mode is turned on the screen of the Dash Cam will display the Network Name and Password. This password is case sensitive.
The NEXTBASE Cam Viewer app will not open.	Please uninstall the NEXTBASE Cam Viewer app and re-download again from your devices App Store.
When I open the NEXTBASE Cam Viewer App I get a message saying 'Please Check Device'.	Ensure that the Dash Cam is in Wi-fi Mode and that your mobile device has connected to the Dash Cam Wi-fi connection.
When I try to play back a file from my Dash Cam I get a message saying 'Buffering' but the video does not load.	Please restart your mobile device and reconnect to the Dash Cam Wi-fi connection. Then re-open the Cam Viewer App.
I am unable to playback a specific video file from the SD card when using my PC.	The file may have not been closed correctly during recording. Repair may be possible by re-inserting the SD card back in to the Dash Cam, select Playback Mode and playing the affected video file.
When looking at my SD card using a computer I see HI & LO files. Why is this ?	The HI file is High Resolution video file (as per the settings) and the LO file is LOW resolution video file which is used by the Wi-fi APP to mobile devices, for efficient streaming / uploading etc.
Unresolved issues.	Reset the Dash Cam to the Default Settings within the Setup Menu and try again. Should the problem persist call the helpline (02920) 866429 or email: support@nextbase.co.uk

**NOTES**

This device complies with part 15 of the FCC Rules. Operation is subject to the following two conditions: (1) This device may not cause harmful interference, and (2) this device must accept any interference received, including interference that may cause undesired operation.

Note: This equipment has been tested and found to comply with the limits for a Class B digital device, pursuant to part 15 of the FCC Rules. These limits are designed to provide reasonable protection against harmful interference in a residential installation. This equipment generates, uses and can radiate radio frequency energy and, if not installed and used in accordance with the instructions, may cause harmful interference to radio communications. However, there is no guarantee that interference will not occur in a particular installation. If this equipment does cause harmful interference to radio or television reception, which can be determined by turning the equipment off and on, the user is encouraged to try to correct the interference by one or more of the following measures:

- Reorient or relocate the receiving antenna.
- Increase the separation between the equipment and receiver.
- Connect the equipment into an outlet on a circuit different from that to which the receiver is connected.
- Consult the dealer or an experienced radio/TV technician for help.

Note: The Grantee is not responsible for any changes or modifications not expressly approved by the party responsible for compliance. such modifications could void the user's authority to operate the equipment.

The device has been evaluated to meet general RF exposure requirement. To maintain compliance with FCC's RF exposure guidelines, this equipment should be installed and operated with a minimum distance of 20cm between the radiator and your body.

# ***NEXT BASE***

[www.nextbase.co.uk](http://www.nextbase.co.uk)

