

422GW

User Manual



Introduction to your Dash Cam

This range of Nextbase™ Dash Cams has been designed specifically with ease of use in mind; it is recommended NOT to change the default settings, which have been carefully selected to give the best performance for day to day use.

Please check the firmware version of the Dash Cam, the version can be found in the Setup menu under System Info.

The latest versions are available to download from our website, where you can download and update when necessary.

www.nextbase.com

Basic Operation

It is essential that a quality branded Class 10 or U1 type Micro SD card is used with this Dash Cam due to the very large data rate generated by high resolution recording. For best results, we recommend using our Nextbase™ branded SD cards with your Dash Cam.

Your Nextbase™ Dash Cam is set to record video, in files of just 1 minute in length. This means that each video file is a manageable size should you need to download and send to your insurance company. Eventually your MicroSD card will fill up with video files but don't worry, the camera automatically deletes the oldest file to make space for new recordings. This way you never run out of space and have plenty of driving data saved.

Typically a 16Gb card will store the last 1.5 hours of driving footage.

The GPS will automatically adjust for Daylight Savings Time.

Automatic Start / Stop Technology

This Nextbase™ Dash Cam senses power supplied to the cigarette lighter socket as soon as the vehicle ignition is turned on and will start to record automatically. When the ignition is turned off, the Dash Cam will perform an automatic shutdown process.

1. Tips for capturing best video footage:

- 1.1 Position the Dash Cam in the centre of the windscreen and ideally behind the rear view mirror so it is not a distraction to the driver.
- 1.2 Ensure that the area on the windscreen that the Dash Cam is looking through is clear of dirt and is within the wiper zone. This will ensure that your videos are as clear as possible.
- 1.3 Reduce the amount of sky in the picture, by angling the view of the camera towards the road. Too much sky will make the road appear darker due to the automatic exposure compensation.
- 1.4 Remove unnecessary items from your dashboard. If objects are placed on your dashboard these can cause reflections to be seen on the windscreen and these reflections may be captured during recording.
- 1.5 To improve dash board glare, a Nextbase™ Reflection Free lens can be purchased.

2. Tips for stable memory card performance:

- 2.1 Periodically format the memory card. Every 2-3 weeks we recommend that you format the memory card. This will wipe any files from the card and set it up afresh for continued use with your Dash Cam. Of course, you should only do this AFTER you've downloaded any files from the card that you may want to keep, as formatting the card will remove all content.
- 2.2 Format your memory card using the Dash Cam. This will make sure that the card is structured specifically for your camera. Press MENU twice and choose the Format Card option. Follow the on-screen instructions accordingly.
- 2.3 Switch off the Dash Cam before removing the SD Card, to prevent the chance of damage being caused to the memory card or the files stored upon it.

Table of Contents

INTRODUCTION TO USING AN IN-CAR CAM	02	EMERGENCY SOS FREQUENTLY ASKED QUESTIONS	28
TABLE OF CONTENTS	03	CONNECT APPS (MYNEXTBASE CONNECT™ & ALEXA)	29
PRECAUTIONS / CAUTIONS ON USING THIS PRODUCT	04	VIDEO MODE / FOLDER SELECTION / PHOTO	30
PRODUCT WARNINGS	05	PLAYBACK MODE - VIDEO	31
USAGE PRECAUTIONS / NOTICES / CANADA COMPLIANCE	06	PLAYBACK MODE - VIDEO EDITING	32
FCC STATEMENT	07	PLAYBACK MODE - PROTECT & DELETE	33
FCC- SUPPLIER'S DECLARATION OF CONFORMITY	08	MYNEXTBASE CONNECT™	34
PRODUCT SPECIFICATION	09	MYNEXTBASE PLAYER™ - OVERVIEW	35
PACKAGE CONTENTS / PRODUCT FEATURES	10	MYNEXTBASE PLAYER™ - EDITING	36
CAMERA PARTS & CONTROLS	11 - 12	MYNEXTBASE CLOUD™	37
IN VEHICLE INSTALLATION	13 - 16	AMAZON ALEXA™ & VOICE CONTROL	38
POSITIONING YOUR DASH CAM / ACCESSORIES	17	PC CONNECTION	39
CHANGING MOUNT ATTACHMENTS	18	FIRMWARE UPDATE INFORMATION	40
FIRST TIME USE	19 - 21	TV CONNECTION	41
MENUS / VIDEO SETTINGS	22	NEXTBASE™ SD CARDS / CE MARK INFORMATION	42
VIDEO SETTINGS (CONT.) / SETUP SETTINGS	23	FREQUENTLY ASKED QUESTIONS	43 - 44
SETUP SETTINGS (CONT.)	24	SOFTWARE LICENSE AGREEMENT	45
DRIVER ASSISTANCE	25	WARRANTY / ONLINE & INTERNATIONAL PURCHASES	46
DRIVER ASSISTANCE (EMERGENCY SOS)	26	MORE NEXTBASE™ PRODUCTS / SERVICES / SOFTWARE	47
EMERGENCY SOS - FLOW DIAGRAM	27	DASH CAM RANGE FUNCTIONS	48

Precautions

Please read this manual carefully before operation and keep it for future reference. It will be helpful should you encounter any operational problem.

- WARNING:** Do not expose this product to rain, moisture or water under any circumstances, doing so may result in the risk of electric shock or fire.
- CAUTION:** To reduce the risk of electric shock, do not perform any servicing other than that contained in the instruction manual unless you are qualified to do so. Have the unit serviced by a qualified service technician if;
The unit has been exposed to rain or water.
The unit does not seem to operate normally.
The unit exhibits a marked change in performance.
- LCD:** A Liquid Crystal Display (LCD) screen is a multilayer complex component, containing 311,040 pixels. Pixels can however fail during normal product life. 1 pixel = 0.00003% failure rate, and one pixel failure per year of operation is considered normal and not a cause for concern.
- WEEE:**  Disposal of Waste Electrical and Electronic Equipment and/or Batteries by users in private households in the European Union. This symbol on the product or on the packaging indicates that this cannot be disposed of as household waste. You must dispose of your waste equipment and/or battery by handing it over to the applicable take-back scheme for the recycling of electronic equipment and/or batteries. For more information please contact your local household waste disposal office.
- CHOKING HAZARD:** Some Products may contain components that are small enough to be swallowed. Please keep out of reach of children.

Cautions on Using this Product

1. Ensure that the windscreen is free of dirt or grease before placing mount upon it.
2. Do not obscure the view of the road ahead or impede the deployment of any airbags in the event of an accident.
3. When not in use, please disconnect the car adaptor from both the 12/24Vdc outlet in your vehicle and the device itself.
4. Only clean the device with a soft dry cloth, for tough dirt, apply some neutral detergent diluted in 5 to 6 parts water to a soft cloth. Please note that alcohol, thinner, benzene etc could cause damage to the paint or coatings.
5. Avoid making contact with the lenses as damage may be caused.
6. If required clean the glass lens carefully using spectacle lens cleaning fluid on a soft cloth only.
7. The video recordings made by this Dash Cam are intended for personal use only.
8. Publication of the recordings on Youtube, the internet or other methods are subject to the Data Protection Act and the requirements thereof must be adhered to. If the Dash Cam is to be used within a commercial environment, i.e. truck use, then the CCTV regulation apply also, in addition to the Protection Act regulations. This includes labelling to identify the use of CCTV is taking place, the omission of Audio recording and informing the relevant authorities of who controls the data.
9. Video playback upon the device which is visible to the driver is prohibited or restricted in some countries or States. Please adhere to these laws.
10. Whilst driving, do not adjust the controls of your device as this is a distraction to driving.
11. Before using the device on your windscreen, check the state and local laws and ordinances where you drive. Some laws prohibit or restrict the placement of objects on the windscreen of a motor vehicle.
IT IS THE USER'S RESPONSIBILITY TO MOUNT THE DEVICE IN COMPLIANCE WITH ALL APPLICABLE LAWS AND ORDINANCES.
Always mount your Nextbase device in a location that does not obstruct the driver's view of the road. Nextbase does not assume any responsibility for any fines, penalties, or damages of your Nextbase device.
Nextbase accepts no responsibility for any damage or injury caused when the dash cam is in use.

Distractions can lead to accidents, and the risk of injury or death. Always keep your eyes on the road, and keep aware of your surroundings.



Product Warnings

Failure to heed the following warnings could result in an accident or collision resulting in death or serious injury.

Distraction Warning

This device is intended to enhance the situational awareness when used properly. If used improperly, you could become distracted by the display, which could lead to an accident causing serious personal injury or death. **DO NOT** seek to access the information stored on the device or change the device settings whilst driving. Information stored on the device should be reviewed only when your vehicle is stationary, and you are parked in a safe place in compliance with local laws.

The device settings should only be changed when your vehicle is stationary, and you are parked in a safe place in compliance with local laws. Always maintain awareness of your surroundings and do not stare at the display or become distracted by the display. Focusing on the display could cause you to miss obstacles or hazards. Use the device at your own risk.

Video playback upon devices with display which are visible to the driver, is prohibited or restricted in some countries or States. Please adhere to these laws.

Vehicle Installation Warnings

When installing the device in a vehicle, do not place the device where it obstructs the driver's view of the road or interferes with vehicle operating controls, such as the steering wheel, foot pedals, or transmission levers. Do not place unsecured on the vehicle dashboard.

Do not place the device in front of or above any airbag.

Battery Warnings

Lithium-ion batteries are used in most Nextbase™ devices. If these guidelines are not followed, batteries may experience a shortened life span or may present a risk of damage to the device, fire, chemical burn, electrolyte leak, and/or injury.

- Do not disassemble, modify, remanufacture, puncture, or damage the device or batteries.
- Do not remove or attempt to remove the non-user replaceable battery.
- Do not expose the device to fire, explosion, or other hazard.
- Do not expose the device to rain or water.

Magnet Warnings

Both the Dash Cam and its mount may contain magnets. Under certain circumstances, magnets may cause interference with some internal medical devices, including pacemakers and insulin pumps. Devices and mounts that contain magnets should be kept away from such medical devices. Magnets may cause damage to some electronic devices, including hard drives in laptop computers and bank / credit or membership cards. Use caution when devices and mounts that contain magnets are near electronic devices or bank / credit or membership cards.



Usage Precautions

Failure to heed the following precautions could result in personal injury or property damage, or negatively impact the device functionality.

Battery Precaution

- Do not immerse or expose the Dash Cam or batteries to rain, water or other liquids.
- Do not leave the device exposed to a heat source or in a high-temperature location, such as in the sun or in an unattended vehicle. To prevent the possibility of damage, remove the Dash Cam from the vehicle or store it out of direct sunlight, such as in the glove box.
- Do not operate the Dash Cam outside of the following temperature range: from -20° to 45°C (from -4° to 113°F).
- When storing the Dash Cam for an extended time period, store within the following temperature range: from 0° to 25°C (from 32° to 77°F).
- Do not use a power and/or data cable that is not approved or supplied by Nextbase™.
- Contact your local waste disposal department to dispose of the Dash Cam/batteries in accordance with applicable local laws and regulations.

Windshield Mounting Legal Restriction Precaution

Before using the Dash Cam on your windshield, check the state and local laws and ordinances where you drive. Some laws prohibit or restrict the placement of objects on the windshield of a motor vehicle.

IT IS THE USER'S RESPONSIBILITY TO MOUNT THE DEVICE IN COMPLIANCE WITH ALL APPLICABLE LAWS AND ORDINANCES.

Always mount your Nextbase™ Dash Cam in a location that does not obstruct the driver's view of the road.

Nextbase does not assume any responsibility for any fines, penalties, or damages that may be incurred as a result of any state or local law or ordinance relating to the use of your Nextbase Dash Cam.

Camera Legal Requirements Precaution

In some jurisdictions it could be considered an invasion of privacy rights to take or publicly display photographs or videos of people or their vehicles using this product. It is your responsibility to know and comply with applicable laws and rights to privacy in your jurisdiction and in any jurisdiction in which you may use this device. Video recordings made by this Dash Cam should be for personal use only.

Publication of the recordings on YouTube, the internet or other methods is subject to the data protection legislation and the requirements thereof must be adhered to. Such data protection legislation may prohibit the use and dissemination by you of Dash Cam footage or may impose restrictions on it – we recommend that you check the legal requirements with your legal advisor before disseminating any Dash Cam footage.

If the Dash Cam is to be used within a UK commercial environment, i.e. truck use, then the CCTV regulations apply in addition to the Data Protection Act regulations. This includes labelling to identify the use of CCTV is taking place, the omission of Audio recording and informing the relevant authorities of who controls the data. For use in a commercial environment in non-UK countries, please refer and adhere to local regulations and requirements. For non-UK operation, specific legal requirements may apply where Dash Cams are to be used in a commercial or employment context - again, we recommend that you check the legal requirements with your legal advisors prior to commencing use of Dash Cams in commercial or employment contexts.

Notices

G Sensor Notice

The G Sensor within the Dash Cam measures forces exerted upon it, with reference to one g which is the nominal force exerted upon us when stationary on the earth's surface.

The G Sensor will also trigger to protect any recording currently in progress, if a pre-determined threshold of force is exceeded.

The G Sensor protection will be adversely affected if the Dash Cam is NOT mounted in the vertical direction i.e. with the lens pointing to or from the direction of travel.

G Force information derived from a G Sensor is not warranted to be totally accurate at all times, as it is derived from the G Sensor through a sampling method over time. The precision of the G Sensor value recorded depends upon when the acceleration took place at the instance of the sample taken.

The thresholds to trigger the video protection rely upon a trigger value being exceeded between two successive samples, in any one of the three G Sensor axis.

If the Automatic G Sensor protection does NOT trigger during an event, then the Protect button should be pressed, in order to protect the file. Protecting the file can also be performed using the Playback function upon the Dash Cam (models with LCD screens), or indeed through the MyNextbase Connect™ App for applicable Wi-Fi models.

Product Compliance Information

Innovation, Science, and Economic Development Canada Compliance

This device complies with Innovation, Science and Economic Development Canada license-exempt RSS standard(s).

Operation is subject to the following two conditions:

- (1) this device may not cause interference, and
- (2) this device must accept any interference, including interference that may cause undesired operation of the device.

Radio Frequency Band and Power Information

Hereby, Portable Multimedia Limited declares that the radio equipment type Series 2 Dash Cam is in compliance with Directive 2014/53/EU.

Product Wireless Information

2400–2483.5 MHz: Wi-Fi (Max 16.3 dBm), BT (Max 6.0 dBm), BLE (Max 6.0 dBm).

RF Exposure Information (MPE)

This device meets the EU requirements and the International Commission on Non-Ionising Radiation Protection (ICNIRP) on the limitation of exposure of the general public to electromagnetic fields by way of health protection. To comply with the RF exposure requirements, this equipment must be operated in a minimum of 20 cm separation distance to the user.

FCC Statement

This device complies with Part 15 of the FCC Rules. Operation is subject to the following two conditions:

- (1) this device may not cause harmful interference, and
- (2) this device must accept any interference received, including interference that may cause undesired operation.

This equipment has been tested and found to comply with the limits for a Class B digital device, pursuant to Part 15 of the FCC Rules. These limits are designed to provide reasonable protection against harmful interference in a residential installation. This equipment generates, uses and can radiate radio frequency energy and, if not installed and used in accordance with the instructions, may cause harmful interference to radio communications. However, there is no guarantee that interference will not occur in a particular installation. If this equipment does cause harmful interference to radio or television reception, which can be determined by turning the equipment off and on, the user is encouraged to try to correct the interference by one or more of the following measures:

- Reorient or relocate the receiving antenna.
- Increase the separation between the equipment and receiver.
- Connect the equipment to an outlet on a circuit different from that to which the receiver is connected.
- Consult the dealer or an experienced radio/TV technician for help.
- This appliance and its antenna must not be co-located or operated conjunction with any other antenna or transmitter.
- A minimum separation distance of 20cm must be maintained between the antenna and the person for this appliance to satisfy the RF exposure requirements.

FCC CAUTION:

This product does not contain any user-serviceable parts. Repairs should only be made by an authorised Nextbase™ service centre. Unauthorized repairs or modifications could result in permanent damage to the equipment, and void your warranty and your authority to operate this device under Part 15 regulations.

FCC Identifier

The FCC Identifier (FCC ID) is available as an E-label within your Dash Cam's System Info pages.

To view the FCC ID please follow the steps below:

Step 1:

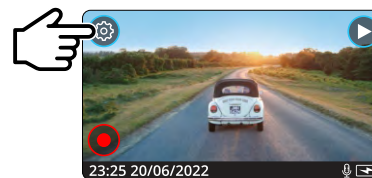

Press the 'Menu' button to enter the Dash Cam's menu system.

Step 2:

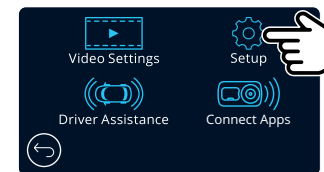

Press the 'Setup' button.

Step 3:

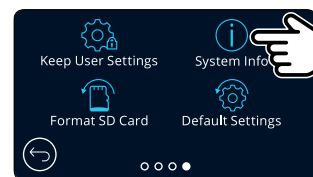

Swipe through the menu pages and select System Info.

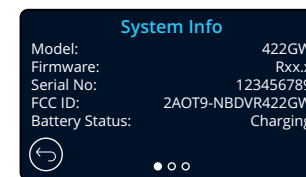

The FCC Identifier (FCC ID) is seen as above.

Note:

- The Regulatory Information (inc. the FCC ID) is embedded with the Dash Cam's firmware, applied to the gift box and included within this User Manual.
- The FCC ID cannot be changed by the user.

FCC - Supplier's Declaration of Conformity Statement

SUPPLIER'S DECLARATION OF CONFORMITY (47 CFR Section 2.906).

We; Tank Design
(The responsible party, who must be located in the United States)

Hereby, Declare that the essential requirements set out in the 47 CFR Sections 2.906 of FCC, have been fully fulfilled on our product with indication below:

1. Applicant's Info

Company Name: Portable Multimedia Ltd
Mailing Address: Unit 2, Caerphilly Business Park, Van Road, Caerphilly. CF83 3ED. UK
Contact: Graham Lambert
Tel: +44 02920 866429
Email Address: support@nextbase.com

2. Product Info

Product Name: Dash Cam
Model No.: NBDVR422GW
Brand Name: Nextbase

3. Applied Standard

Standards
E-CFR Title 47 Part 15 Subpart B—Unintentional Radiators: 2018

Report No. WTS19S04021638E

4. Test Firm Used to Take Measurements:

Name: Waltek Services (Shenzhen) Co., Ltd.
Address: 1/F, Fukangtai Building, West Baima Rd Songgang Street, Baoan District,
Shenzhen, Guangdong, People's Republic of China, 518105
Contact Name: Philo Zhong
Tel: +86 755 8355 1033 802
Email: CB@waltek.com.cn
Designation No.: CN1201
FRN: 523476

5. FCC Marking



6. Responsibilities and obligations

Strictly follow the FCC rules of 2.906, 2.908, 2.909.

7. Applicant's Authorisation

Company Name: Portable Multimedia Ltd
Mailing Address: Unit 2, Caerphilly Business Park, Van Road,
Caerphilly. CF83 3ED. UK
Contact person: Graham Lambert
Signature: *G. K. Lambert*
Email Address: support@nextbase.com
Tel: +44 02920 866429
Date: 30th April 2019

8. Responsible party in US.

Company name: Tank Design
Mailing Address: 158 Sidney Street, Cambridge, MA 02139, United States
Contact person: Mr Scott Watts
Signature: *Scott Watts*
Email address: SWatts@tankdesign.com
Tel: (617) 388-8380
Date: 30th April 2019

Product Specification

Model Number / Name	NBDVR422GW
Power Requirements	5V / 1.5A
Power Supply	12-24Vdc Car Power Cable (supplied) Fuse Type: 32mm / 2A Output: 5Vdc
	Hardwire Kit also available to purchase for a hidden, permanent power supply.
Sensor Resolution	2.12M Pixel (1936 x 1097)
Lens - Type / Angle / Aperture	5G / 140° / F1.6
Recording Resolution	2560x1440 @30fps day & night
Screen Size	2.5"
Screen Resolution	732 (W) X 240 (H) pixels x RGB (720)
Screen Ratio	16:9
Card Reader	MicroSD, Class 10, up to 128GB
SD Card (Recommended Type)	8-128GB SDHC, U3, Class 10 (48mb/s) For best results, use a recognized brand.
SD Card Recorded File Capacity (based on default settings)	8GB MicroSD = 60 minutes of recording 16GB MicroSD = 120 minutes of recording 32GB MicroSD = 240 minutes of recording 64GB MicroSD = 480 minutes of recording 128GB MicroSD = 960 minutes of recording
Recording Format	MP4
Internal Battery	Lithium-Polymer 3.7V / 320mAh (approx. 15 mins recording time) Battery design allows the 'Auto Power Off' feature to function in event of power loss within the vehicle. It is not intended as an alternative power source to replace the supplied car adaptor.
GPS Module	simple / ST702G-15C40
Unit Dimensions	82 x 46 x 47
Unit Weight	105g

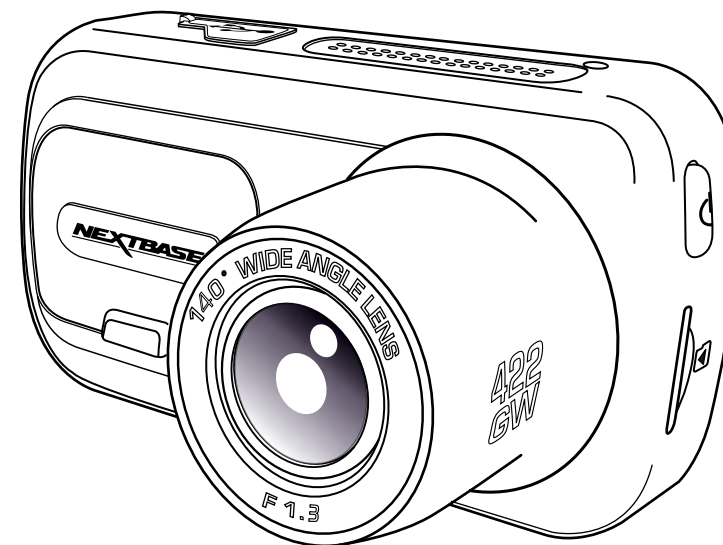

Amazon, Alexa and all related logos are trademarks of Amazon.com Inc or its affiliates
The Bluetooth™ word mark and logos are registered trademarks owned by Bluetooth SIG.
Windows is a registered trademark of Microsoft Corporation in the United States and other countries.
Android is a trademark of Google Inc in the United States and in other countries.
2015 Google Inc. All rights reserved. Google Maps™ mapping service is a trademark of Google Inc.
Mac is a registered trademark of Apple Inc in the United States and in other countries.
iOS is a trademark or registered trademark of Cisco in the United States and in other countries.
Wi-Fi is a registered mark of Wi-Fi Alliance Corporation.
microSD and the microSD logo are trademarks of SD-3C, LLC.
MyNextbase Player™, MyNextbase Cloud™, and Click&Go PRO™ are registered trademarks of Portable Multimedia Ltd.

Package Contents

Please check the contents of your Nextbase™ Dash Cam product.

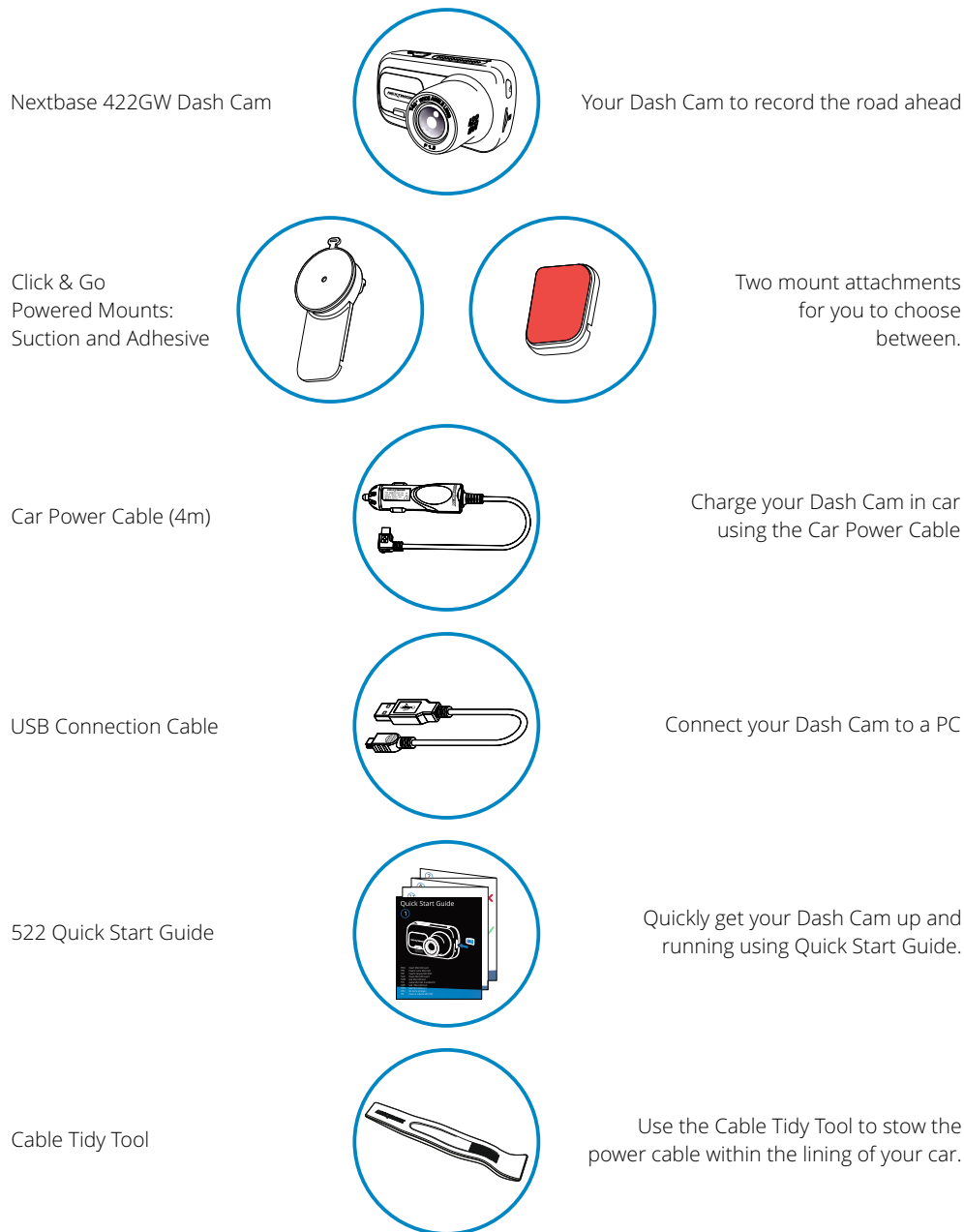

Product appearance may differ slightly to that shown above.

Product Features

Thank you for purchasing this Nextbase Dash Cam product, in this section we will outline some of the features available with this dash cam.

HD Recording Capability

1440p HD recording at 30 fps, to record the road ahead.

HD Touch Panel Display

Bright, clear, high definition 3" screen with IPS technology for a wide viewing angle.

Click & Go Pro Powered Mount

Our exclusive Click and Go Pro powered magnetic car mount to easily install and remove your Dash Cam with just one hand. Supplied with both adhesive and suction fittings.

G Sensor / File Protection

In the event of an impact the device will automatically 'protect' the recording, stopping the file from being over-written. This can also be performed manually, by pressing the 'protect' button. Individual files can also be 'protected' when viewed within playback mode.

Inbuilt GPS

Inbuilt GPS to keep track of your journeys.

Automatic Start / Stop Technology

As soon as the vehicle ignition is turned on, your Dash Cam will start to record automatically. When the ignition is turned off, the Dash Cam will perform an automatic shutdown process.

Intelligent Parking Mode

Intelligent Parking Mode triggers recording automatically when motion is detected, keeping your car safe when parked.

Built-in Microphone & Speaker

Record audio to compliment the video recordings.

Nextbase Cloud™ Service

View and share your footage online using the MyNextbase Cloud™ service. Upload your video to the Nextbase™ server to get a shareable link to send to friends, insurers, and social media. Upload your videos via the file upload area on [Mynextbase.com](https://mynextbase.com). The uploaded file will be deleted after 30 days, when the link will also expire.

MyNextbase Connect™

MyNextbase Connect™ is the new Nextbase™ app that allows you to view and manage your videos, upload files to social media, and contact emergency services in the event of an incident.

Alexa Voice Control

Operate your Dash Cam through Alexa Voice control (must have Alexa app installed).

Dash Cam Accessories

Your Dash Cam can be fitted with a range of Nextbase accessories to enhance your recordings, including Rear Facing Cameras to record the road behind you, or the interior of your vehicle. See the Nextbase™ Accessories Manual on nextbase.com to view the full range.

Camera Parts and Controls

See below to identify the parts and controls of your Dash Cam

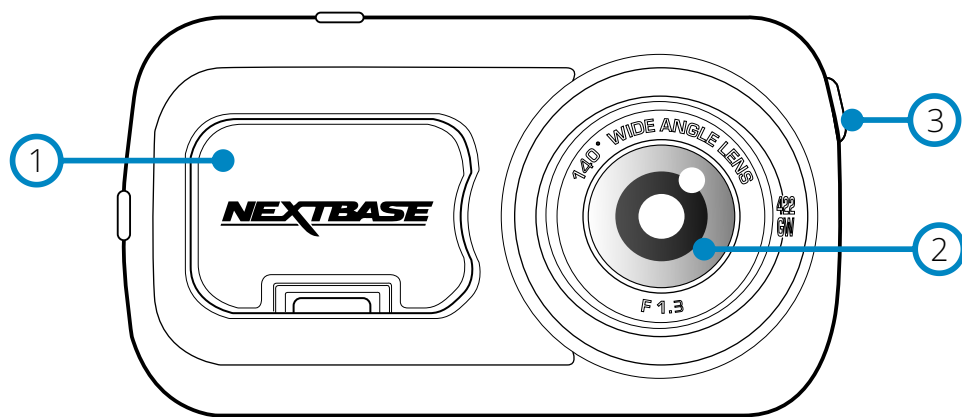

- ① **Dust Cover**
Mounting point located under the dust cover
- ② **Camera Lens**
Wide angle 140°
- ③ **Power Button**
Press and hold for 2 seconds to turn the Dash Cam On/Off

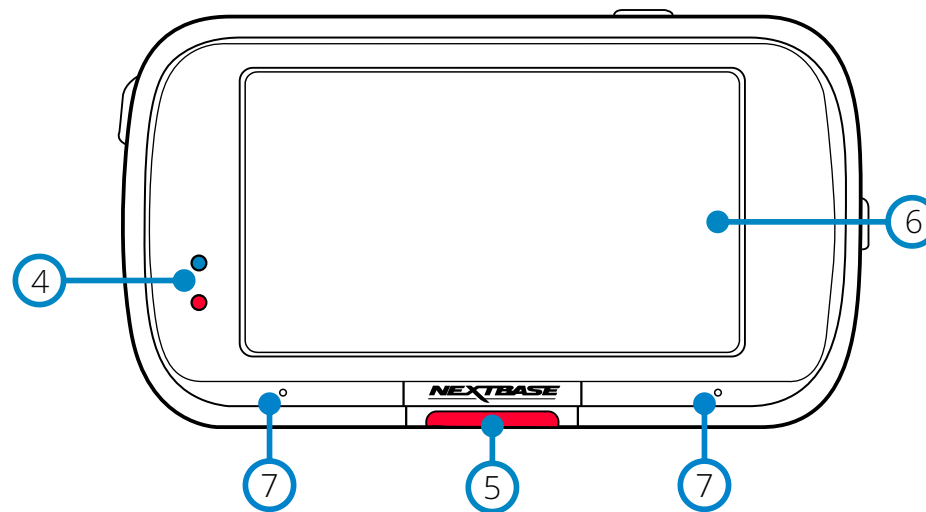

- ④ **LEDs**
Top: Blue
- The Blue LED will be on while the Dash Cam is charging. It will turn off when charging is complete, even if the Dash Cam is still plugged in.
Bottom: Red
- The Red LED is permanently on while the Dash Cam is active. It will flash while recording.
- ⑤ **Protect Button**
Press whilst recording to protect the current file in event of an emergency situation.
Note:
- When the 'Protect' function is activated a file containing 10 seconds prior to the incident and 20 seconds after is written to the Protected folder.
- ⑥ **Screen**
2.5" Inch High Resolution Screen.
Tap the centre of the screen to take a photo. This applies while recording and while in video mode. If a Rear Cam is attached, touch the centre of the Front Facing view to take a photo. This will save 2 photos, one from the Front Facing camera, and one from the Rear Facing camera.
- ⑦ **Microphone**
Integrated microphone for audio recording.

Camera Parts and Controls (cont.)

See below to identify the parts and controls of your Dash Cam

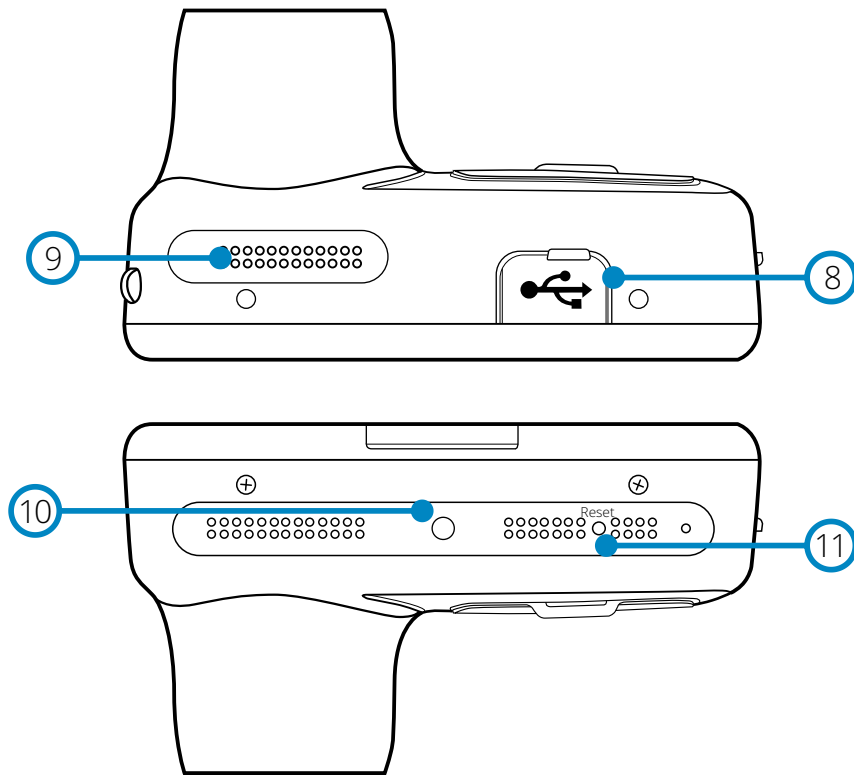

- 8 **USB Cover**
USB port located under the dust cover
- 9 **Speakers**
Integrated speakers for audio playback
- 10 **Light Sensor**
Automatically adjusts the screen brightness relative to the ambient light levels.
- 11 **Reset Button**
Press to force the Dash Cam to restart.

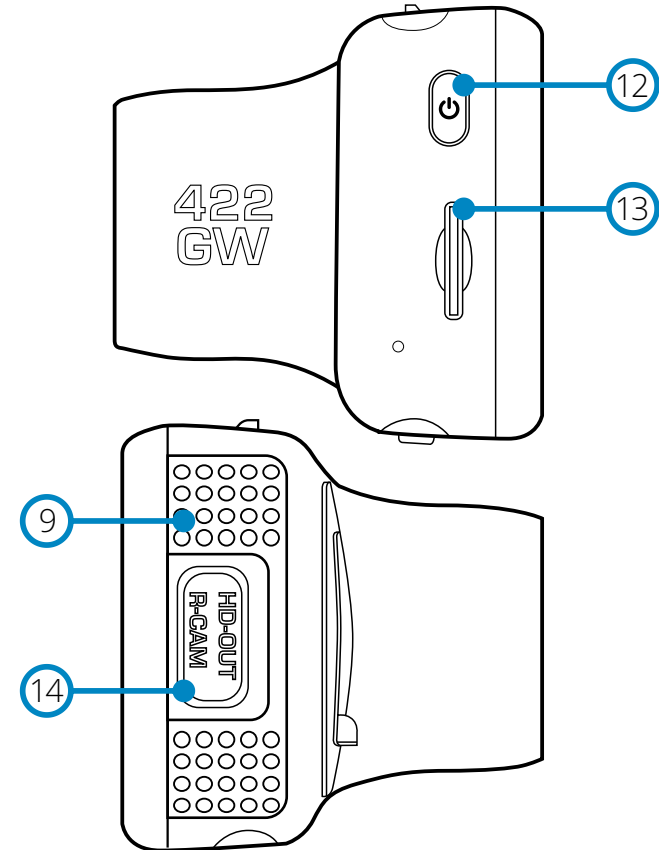

- 12 **Power Button**
Press and hold for 2 seconds to turn the Dash Cam On/Off
- 13 **MicroSD Card Slot**
Insert the MicroSD card here, taking care that the gold contacts are facing towards the rear of the Dash Cam.
- 14 **HD-Out/Rear Cam Input**
Connection point for the Rear Cameras

In Vehicle Installation

Please follow the instruction below for the first-time installation of the Dash Cam. For day to day use, simply remove the camera from the mount as required.

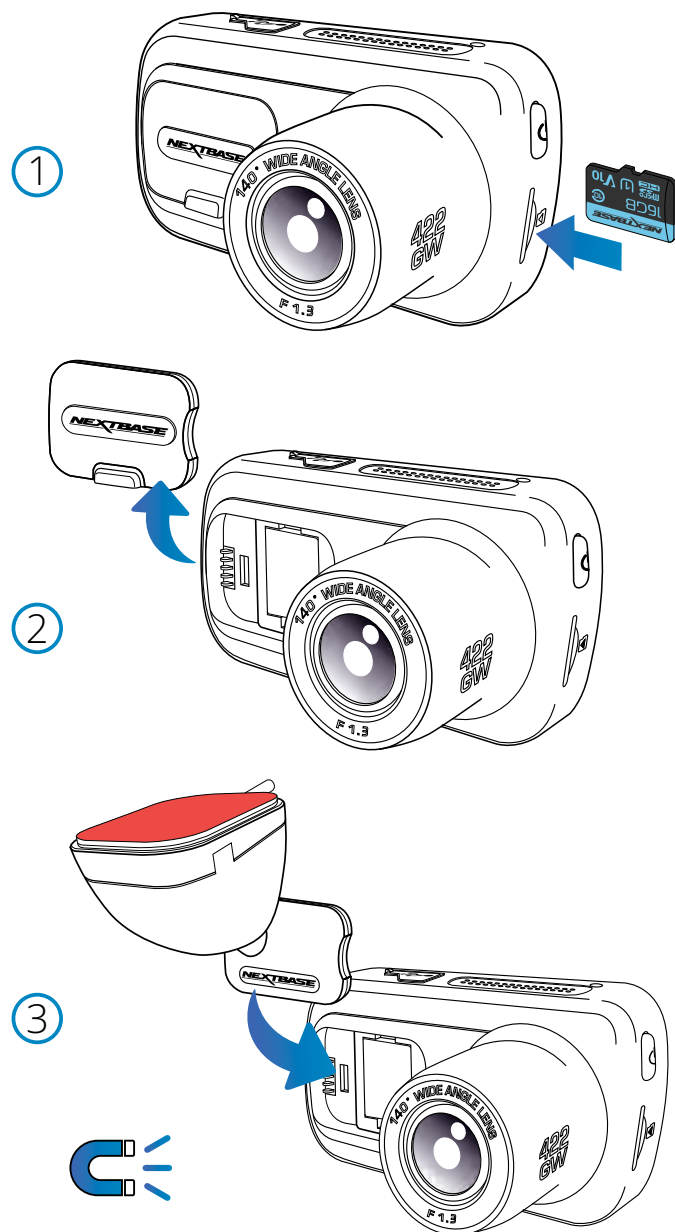

1 Insert MicroSD Card

Insert a suitable MicroSD card (Class 10, minimum 48/Mbps) in to the Dash Cam, taking care that the gold contacts are facing towards the LCD screen side of the Dash Cam. Push the memory card until it clicks into place.

Note:

- Use the edge of a small coin (or similar object) to push the memory card in place if required. Take care that card has 'clicked' into place, a second push inwards will release the memory card.
- For best results, we recommend using Nextbase™ branded SD cards.
- Do not remove or insert the memory card when the Dash Cam is turned on. This may damage the memory card, or the recording within.

2 Remove dust cover from the Dash Cam

Remove the dust cover that is located on the front of the Dash Cam to gain access to the mounting point.

To remove the dust cover, lift the cover away from the body of the Dash Cam.

Note:

- If the Dash Cam is not to be used for a period of time replace the dust cover to help keep the components free of dust or other contaminants.

3 Attach the mount to the Dash Cam

Place the mount in space under the dust cover on the Dash Cam. Once in place, magnets within the mount and camera will hold the two parts together.

See page 18 for more information on changing mounts attachments.

In Vehicle Installation (cont.)

4

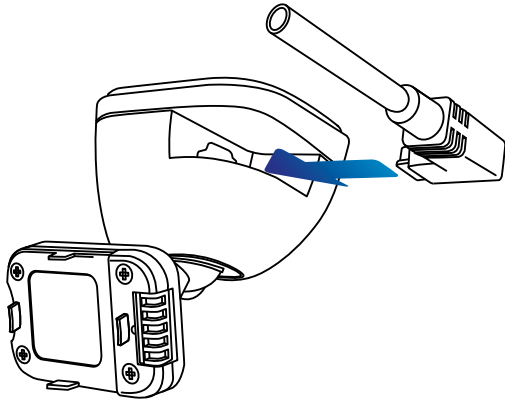

4 Connect car power cable

Connect the supplied car power cable to the Dash Cam Mount's USB port. Do NOT connect the power cable to the USB port on the Dash Cam.

5

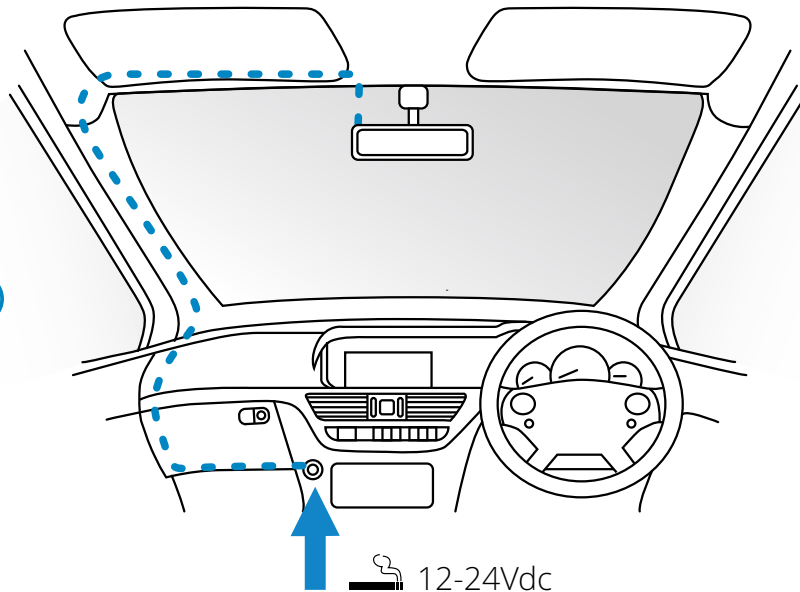

5 Plug the power cable into the 12-24Vdc outlet of your vehicle

The Dash Cam will automatically power on and start recording once power is available. In some vehicles this will be when connections are made, for others the Dash Cam will power on once the ignition has been turned on.

Also available to purchase is a Nextbase Hardwire Kit. This connects your Dash Cam directly to the vehicle's fusebox to power it leaving your 12Vdc outlet available for Phone / Sat Nav charging. The Nextbase™ Hardwire Kit includes the necessary 12-24Vdc to 5Vdc convertor and battery protection circuitry. See page 9-10 of the Nextbase Accessories Manual for further information.

Route the power cable around the windshield to the 12-24Vdc socket, ensuring that your view is not obstructed, and that the cable is not a distraction. Use the cable fitting tool (bottom, left) included with your Dash Cam to more easily open the lining of your vehicle, within which you can stow the cable.

See page 17, 'Positioning your Dashcam' for more details.

Note:

- Do NOT wire the Dash Cam directly to a 12Vdc supply by cutting the cigarette plug off the end of the cable, or permanent damage will result.

The above diagram is for illustration purposes only.

In Vehicle Installation (cont.)



- 6 Remove the adhesive cover layer**
Peel back the red cover layer to expose the adhesive surface, ready to mount on your windscreen.

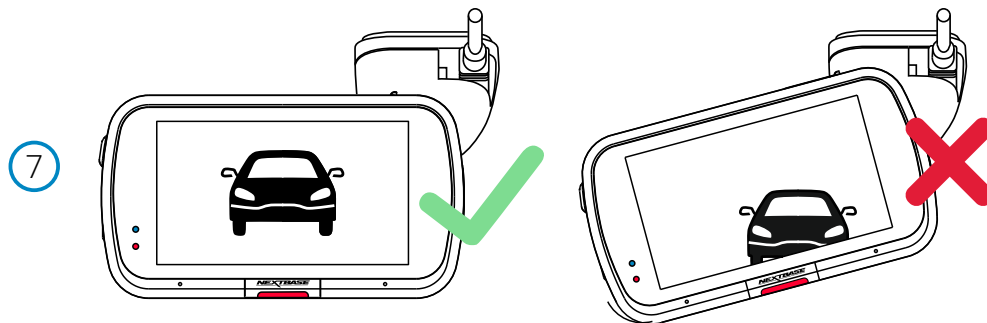

- 7 Straighten the Dash Cam**
Ensure that the Dash Cam is horizontal and faces straight out of the windscreen. Ensure that objects on the Dash Cam display appear level, and adjust as required.

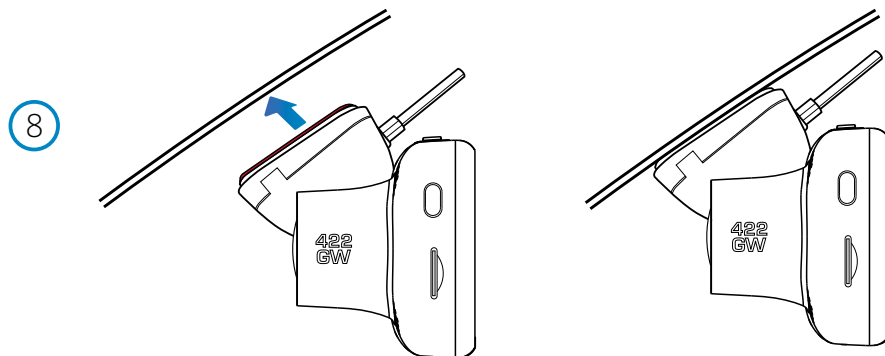

- 8 Attach the Dash Cam to the windscreen**
When you are satisfied with the placement and orientation of the Dash Cam, firmly place the mount on the windscreen.

In Vehicle Installation (cont.)

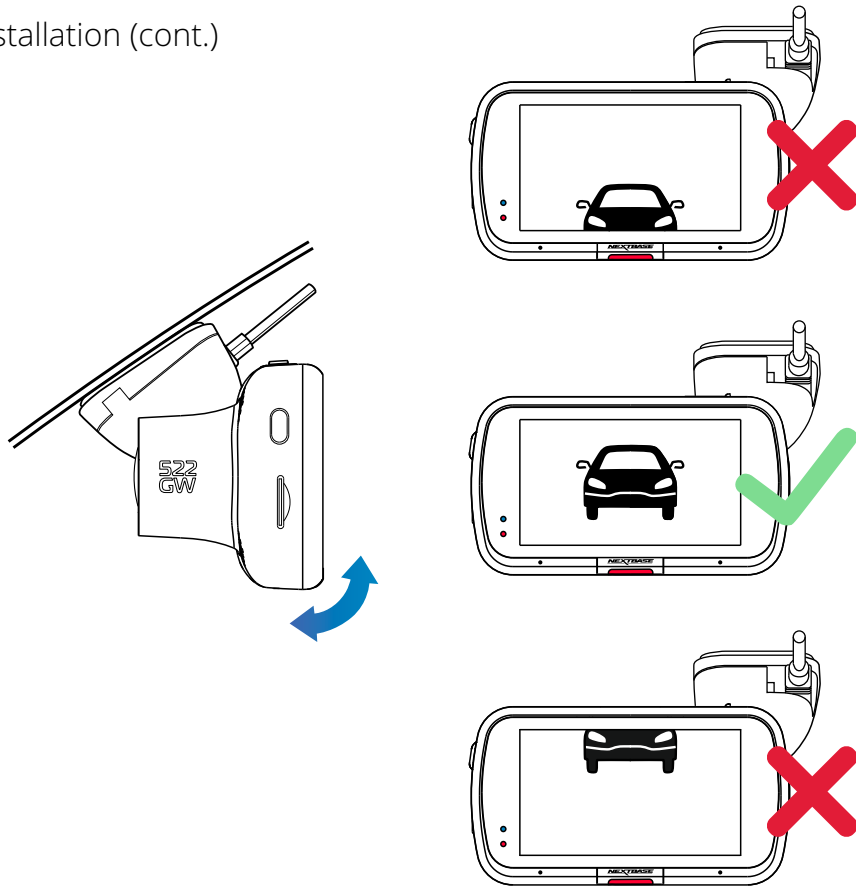

9

9 Adjusting the Dash Cam

With the mount attached to the windscreen, ensure that objects on the Dash Cam display are level and adjust as required. Ensure that the road ahead is at the centre of the image, in the central third of the display. If too much of the sky is visible it may risk underexposing details on the road; ensure that the road ahead is clearly visible on the Dash Cam display. Do NOT attempt to adjust the Dash Cam while driving.

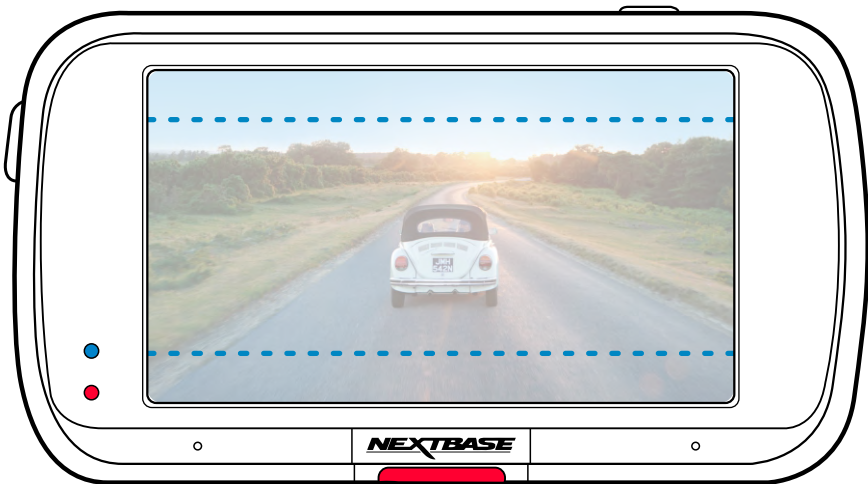

Positioning Your Dash Cam

Please read and follow the notes below for the safe operation of your Dash Cam within your vehicle.

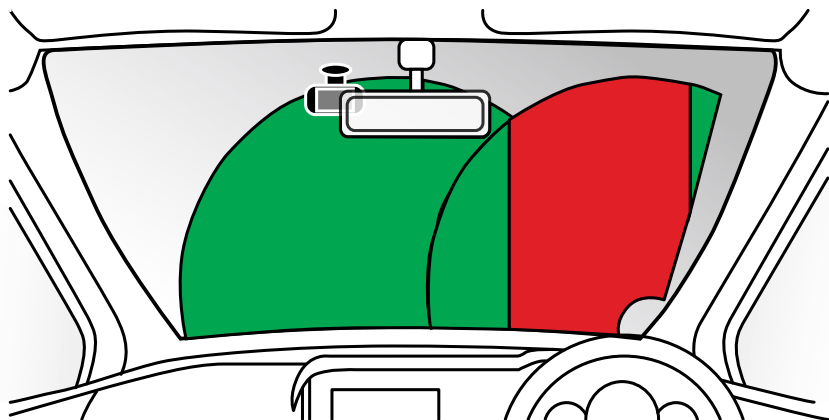

Before using the device on your windscreen, check the state and local laws and ordinances where you drive. Some laws prohibit or restrict the placement of objects on the windscreen of a motor vehicle. IT IS THE USER'S RESPONSIBILITY TO MOUNT THE DEVICE IN COMPLIANCE WITH ALL APPLICABLE LAWS AND ORDINANCES.

Always mount your Nextbase™ device in a location that does not obstruct the driver's view of the road. Nextbase does not assume any responsibility for any fines, penalties, or damages that may be incurred as a result of any state or local law or ordinance relating to the use of your Nextbase device.

As per the installation instructions, you must install the Dash Cam so it does NOT obstruct the driver's view of the road (red, above), preferably on the passenger side of the vehicle and behind the rear view mirror. The Dash Cam needs to view through a clear section of windscreen in an area swept by the windscreen wipers (green, above). However, the Dash Cam should be installed so as not to intrude significantly within the wiped area. A 40mm intrusion into the green wiped area is the maximum permitted by UK law.

Hiding the Cable

Make sure the hanging cable does not obstruct your view out of your rear window. Ensure that there are no kinks in the cable as you are stowing it. If necessary, use the cable tidy tool supplied with your Dash Cam; this can be used to help pry open the lining of your car (see illustration below).

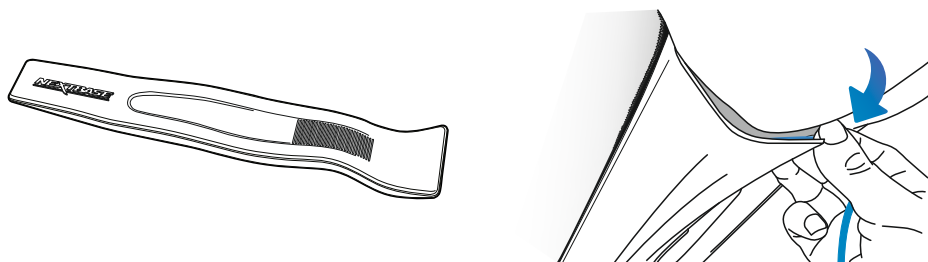

Notes On Positioning Your Dash Cam

- Do NOT mount the Dash Cam in front of the driver, as depicted by the red area in the illustration to the left of this page.
- When installing the Dash Cam in a vehicle, always place the device securely against the windscreen and where possible conceal the power cable under trim.
- Make sure that the Dash Cam power cable does not interfere with the drivers operating controls, such as the steering wheel, pedals or gear levers.
- Do NOT mount the Dash Cam in front of an airbag field of deployment or in a position to obscure any mirrors.
- Clean the windscreen at the point of location, prior to fitting the Dash Cam, also, applying some moisture to the suction cup may be beneficial, to ensure absolute adhesion.
- It is recommended NOT to operate the Dash Cam whilst driving. The automatic Start-Stop technology incorporated within the device negates any need to operate the controls whilst driving.
- Adjust any settings or review recordings whilst stationary, not whilst driving.
- After the preliminary SETUP has been carried out upon the Dash Cam, adjust the Screen Saver settings to either ON or Speed display (showing only your speed). Turning the Screen Saver ON will blank the screen 30 seconds after starting the vehicle and therefore the screen will NOT be a distraction to the driver.

Accessories

Multiple accessories can be purchased for your Nextbase Dash Cam, including a Rear Window Camera, a Polarising Filter, and a Rear Facing Camera. Some of these products can effect where you should position your camera.

For more information on how to position and use these products, download the 'Nextbase Accessories Manual' PDF a www.nextbase.com.

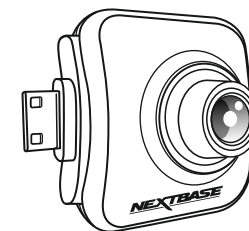

Changing Mount Attachments

Follow the instructions below to switch between mounts attachments; 3M adhesive or suction. To attach each mount, align the pins on the mount with the holes on the adhesive/suction attachment and slide firmly to the right until you hear the pieces click into place. To remove the top, simply do the reverse, slide it to the left until you can lift it off of the mounting pins.

Ensure the windshield is free of grease and dirt before mounting; if necessary, clean with a warm, clean cloth. Ensure that the Mount and Dash Cam do not obstruct the driver's view.

Removing Adhesive Residue

If you wish to remove the adhesive mount from your windshield, use hot soapy water or an alcohol based solution to get rid of any sticky residue and ensure that your windshield remains clean and clear. Leaving residue on the windshield for an extended period of time will make it harder to remove.

If hot water or an alcohol based solution proves ineffective, it may be necessary to use a small sharp blade. If this is the case, protect your fingers and use the blade flat against the surface of the glass to avoid causing scratches.

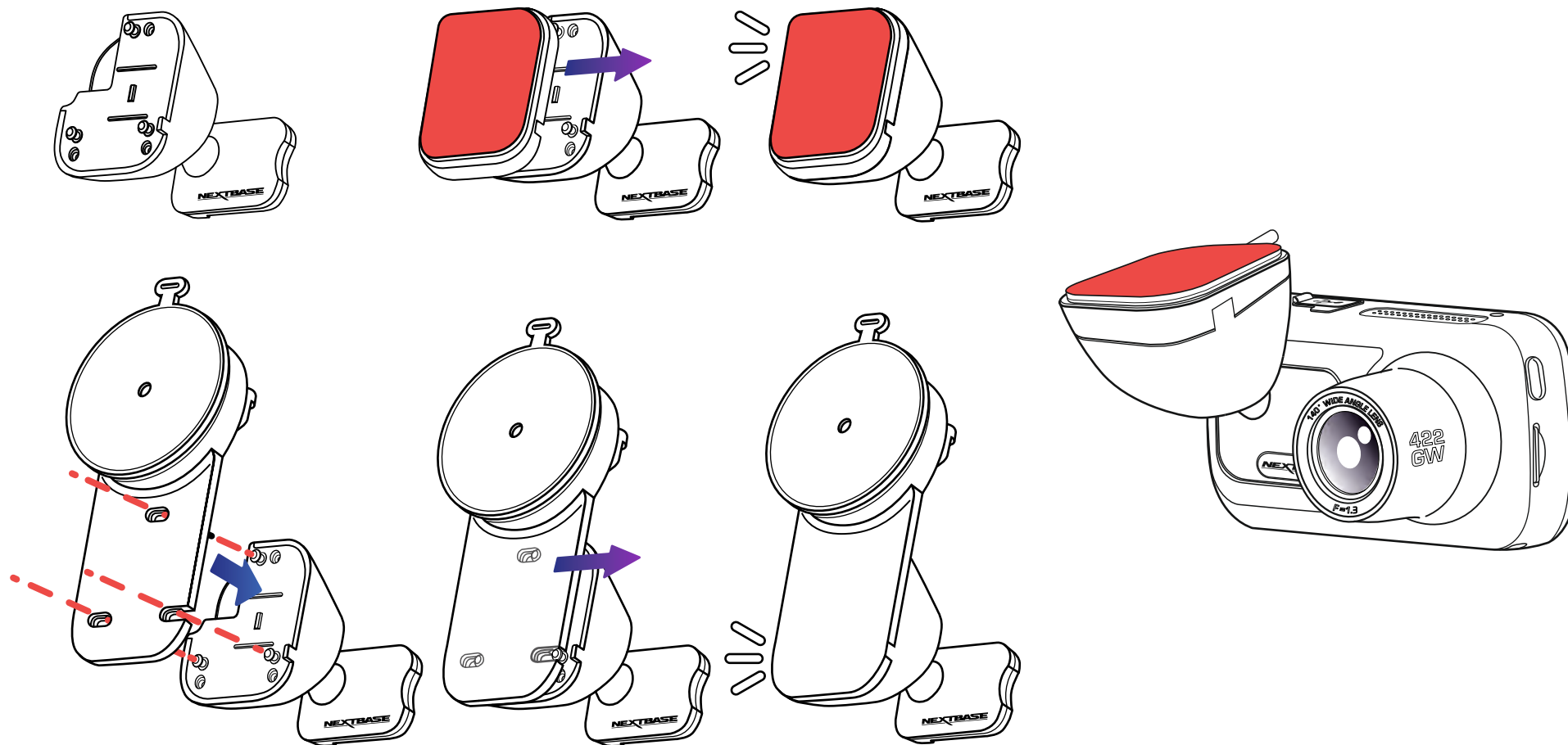

First Time Use

To ensure the set up of this Dash Cam is as quick and simple as possible, there is an easy to follow 'First Time Use' menu.

This menu is used to set your preferred Language, Country (inc. Time Zone) and Speed Units.

This menu will appear when:

1. The Dash Cam is first turned on.
2. There has been a Firmware Update applied to the Dash Cam and 'Keep User Settings' has been set to OFF. If it is set to ON, your Dash Cam will start normally, with your settings intact.
3. After the Dash Cam's settings have been reset, by using the 'Default Settings' option in the Setup Menu.

Follow the on-screen instruction to select the Language, Country, and Speed Units.
The settings that influence the displayed time & date will be applied upon receiving a GPS connection.

Note: The First Time Use menu is in place to get you up and running quickly and smoothly.
The settings you choose during First Time Use can be changed at any later time in the setup menus.

See pages 20 and 21 for the First Time Use screens.



First Time Use - Screens

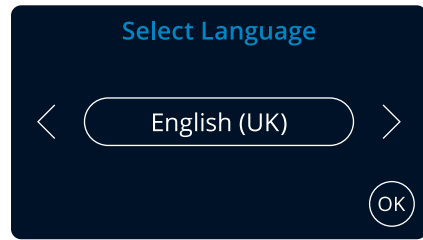

Options:
English (UK), English (US), Dansk, Deutsch, Espanol
Francais, Italiano, Nederlands, Norsk, Suomi, Svenska

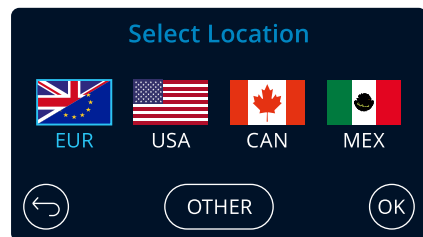
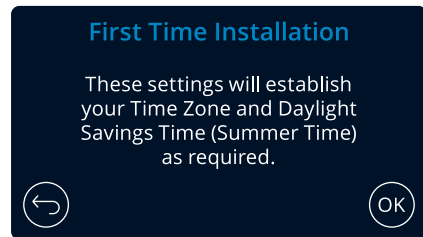
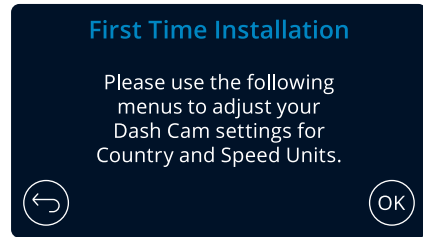

Select a Location to designate your Time Zone.
Selecting Other allows you to choose a Time Zone manually.

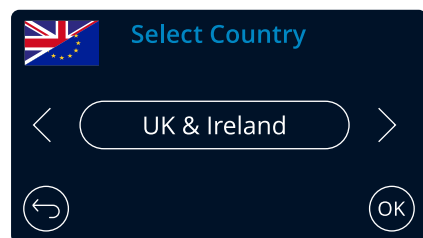
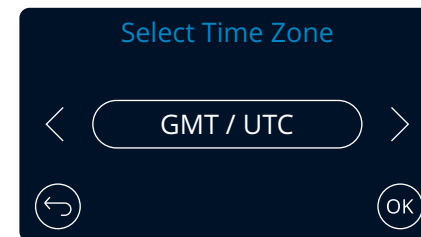

EUR: UK & Ireland, Belgium, Denmark, Finland, France, Germany
Italy, Netherlands, Norway, Poland, Spain, Sweden.
USA: Eastern, Central, Mountain, Pacific, Alaska, Hawaii
CAN: Newfoundland, Atlantic, Eastern, Central, Mountain, Pacific
MEX: Eastern, Central, Mountain, Pacific

First Time Use - Screens

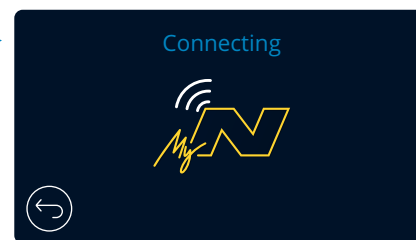
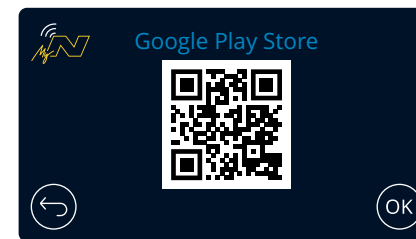
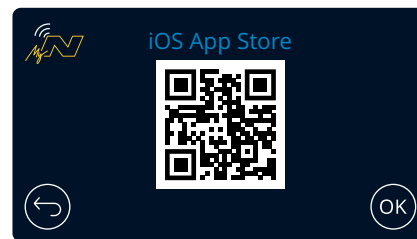
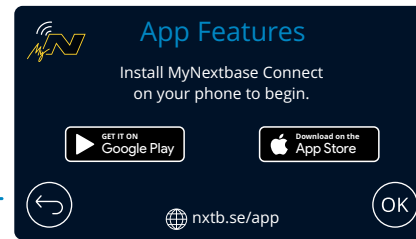
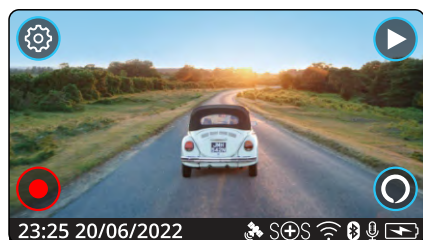
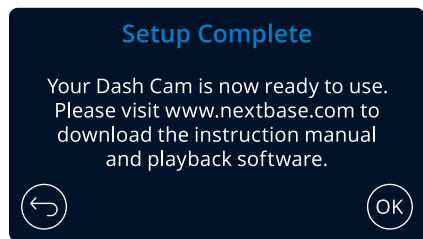
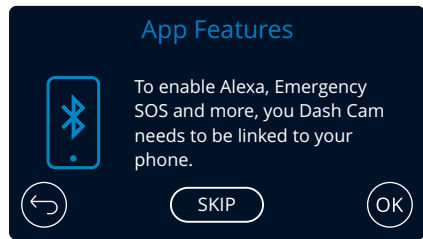
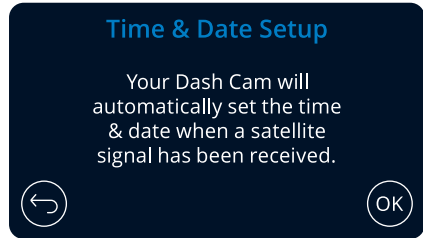
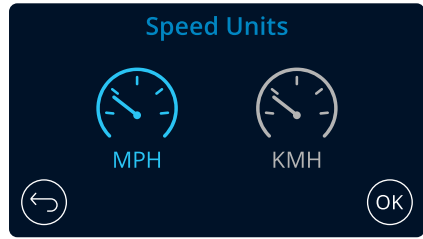

←

↓

↓

↓

↓

↓

↓

←

Scan the QR Code (on iOS use your camera; for Android users, download a QR Scanner from the Play Store) or search: 'MyNextbase Connect' on the appropriate app store. Once the app is successfully installed, press 'OK' to make the Dash Cam discoverable by your smart-phone. Use the 'Connect Dash Cam' feature in the app to pair your Dash Cam.

Menus

Press the 'Menu' button to enter the Dash Cam's menu system.



The default settings have been carefully selected to allow you to use your Dash Cam without the need to change any settings. However, should you wish to change a setting then please see below:

- Use the touch screen to select a settings submenu (Video Settings, Setup, Driver Assistance, Communications)
- Once in the submenu, use the touchscreen to select which function to change.
- When swiping through the menu pages, swipe from the middle of the screen, to avoid accidentally selecting a submenu/function.

Notes:

- Menus are not accessible whilst the Dash Cam is recording.
- Within the Setup Menu there is a 'Default Settings' option to allow you to reset the Dash Cam to the factory defaults, if required.

Menu Tree:

See below for the settings to be found under each submenu:

Video Settings: <ul style="list-style-type: none"> - Resolution - Exposure - Video Length - Audio - Time Stamp - Speed Stamp - GPS Stamp - Model Stamp - Dual Files - Time lapse - Number Plate - G Sensor 	Setup: <ul style="list-style-type: none"> - Screen Saver - Alerts - Recording History - Parking Mode - Language - Country - Time Zone / DST - Time & Date - Speed Units - Device Sounds - Screen Dimming - Auto Power Off - Keep User Settings - System Info - Format SD Card - Default Settings 	Driver Assistance: <ul style="list-style-type: none"> - Emergency SOS - Reversing Camera 	Connect Apps: <ul style="list-style-type: none"> - MyNextbase - Alexa
---	---	---	--

Video Settings

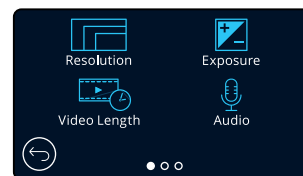

- Resolution**
 Change your Dash Cam's recording resolution
Options: 1440P @ 30FPS (frames per second), 1080P @ 60FPS, 1080P @ 30FPS
Default: 1440P @ 30FPS

The resolution of an attached Rear Facing Camera is dictated by the chosen resolution of the Front Facing camera. The resolution of the Rear Camera cannot be altered independently of the resolution of the Front Camera; the two resolutions are linked together to ensure maximum performance. See the table below for the Rear Camera resolutions:

	Front Camera	Rear Camera (if connected)
	1440P @ 30FPS	720P @ 30FPS
Resolution	1080P @ 60FPS	720P @ 30FPS
	1080P @ 30FPS	1080P @ 30FPS

- Exposure**
 Adjust the exposure level for different lighting conditions.
Options: Values range from -6 to +6
Default: 0
- Video Length**
 Set the length of the individual recorded video files. The Dash Cam will continue recording, filling the memory card. When the memory card becomes full, the oldest file will be automatically deleted to make space for the new recording.
 Note: Protected Files will not be deleted.
Options: 1 minute, 2 minutes, 3 minutes
Default: 1 minute
- Audio**
 Turn On/Off the microphone for video recording.
Options: On and Off
Default: On

Video Settings (cont.)

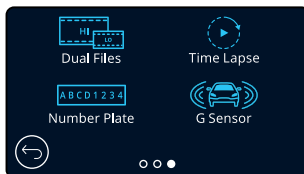
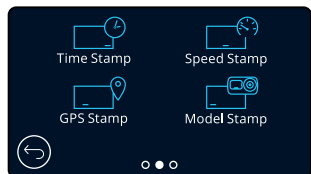

- 5 **Time Stamp**
Turn On/Off the time and date stamp shown on recorded files.
Options: On and Off
Default: On
- 6 **Speed Stamp**
Turn On/Off the speed stamp shown on recorded files.
Options: On and Off
Default: On
- 7 **GPS Stamp**
Turn On/Off the location data stamp shown on recorded files.
Options: On and Off
Default: On
- 8 **Model Stamp**
Turn On/Off the Dash Cam model stamp shown on recorded files.
Options: On and Off
Default: On
- 9 **Dual Files**
When recording, both a high and low quality video are saved. The smaller file size of the low quality video means it is quicker to transfer and edit within the app. If a Rear-Cam is attached, and Dual Files is switched ON, High and Low quality files will be saved for the Rear view as well, giving you a total of 4 files (Front High, Front Low, Rear High, Rear Low)
Note: Recording both high and low quality versions will take up more space on the memory card.
Options: On and Off
Default: On
- 10 **Time Lapse**
Turn on to record a time-lapse video of your journey.
When Time Lapse is turned On, Recording History will be turned Off.
Options: 3 mins, 30 mins, Off
Default: Off
- 11 **Number Plate**
Input your vehicle's number plate to add a number plate stamp to your recordings.
Default: Off
- 12 **G Sensor**
Turn off or adjust the sensitivity of the internal G Sensor. The G Sensor detects forces which will protect the current recording in the event of a collision. The higher the G Sensor sensitivity, the less force will be needed to trigger automatic file protection.
Options: Off, Low, Medium, High
Default: Medium

Setup Settings

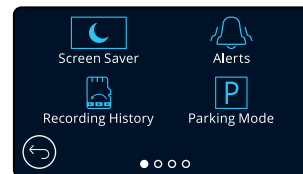

- 13 **Screen Saver**
Turn on the screen saver function to shut down the screen after a chosen period of inactivity. You can also choose for the screensaver to show your current speed.
Options: On and Off and Speed Display
Default: Off
- 14 **Alerts**
Turn On/Off the beeps that sound when a recording starts, when a recording ends, and when a file is protected.
Options: On and Off
Default: Off
- 15 **Recording History**
In some territories, there are laws prohibiting the amount of footage your Dash Cam should hold. The default setting is 'Maximum', where your Dash Cam records and stores videos without restriction.
If 'Minimum' is selected you will first be asked to Format (wipe) your SD Card; be sure to back up, or protect any files you wish to keep before doing this. If you choose not to Format the SD Card, no action is taken and the function will not be activated. Format SD Card will *not* affect protected files.
Once the SD Card has been formatted, the file recording length will be automatically set to 1 minute. The Dash Cam will now be limited to storing only 4 unprotected files at any one time. When a new file is recorded it will overwrite the oldest file, keeping the number of stored files at the maximum of 4.
As protected files (i.e. recordings of incidents) cannot be overwritten, these do not count towards the 4 file maximum, and are stored to the capacity of the SD Card.
When Recording History is turned On, Time Lapse will be turned Off.
Options: Maximum and Minimum
Default: Maximum
- 16 **Parking Mode**
When Parking Mode has been turned on, the Dash Cam enters standby mode when the 12Vdc supply has been turned OFF (typically removing your ignition key).

The Dash Cam will also enter standby mode if no physical movement is detected for 5 minutes, this is designed to allow use of a permanent 12Vdc supply, i.e hard-wire kit.

Should physical movement of the vehicle be detected, the Dash Cam will power on and start recording a 1-2 minute protected video. If no further physical movement is detected then the Dash Cam will return to standby mode, if physical movement is detected subsequently, then the camera will continue to record normally, i.e. driving once more.
Options: On and Off
Default: Off

Setup Settings (cont.)

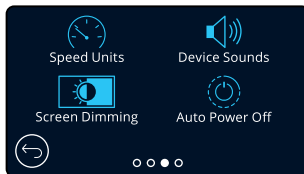
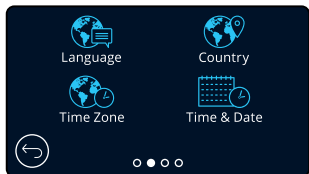

- 17 Language**
Select your preferred language
Options: English (UK), English (US) Danish, German, Spanish, French, Italian, Dutch, Norwegian, Finnish, Swedish
Default: Follows your First Time Use selection.
- 18 Country**
Select your country to adjust your Dash Cam's time display.
Options: EUR, USA, CAN, MEX, Other
Default: Follows your First Time Use selection.
- 19 Time Zone/DST**
Manually adjust your time zone to adjust your Dash Cam's time display. Manually changing your time zone will change your Country setting to Other.
Options: -12 to +12
Default: GMT / UTC
- 20 Time & Date**
Adjust the time & date as required. Press MENU to exit and return to the Setup Menu.
Note: Time and date settings will be over-written upon satellite connection.
- 21 Speed Units**
Choose between MPH and KMH
Options: MPH and KMH
Default: MPH
- 22 Device Sounds**
Turn On/Off the beep that sounds when the touch panel is pressed. Start up sound is NOT muted.
Options: On and Off
Default: On
- 23 Screen Dimming**
The Dash Cam automatically adjusts the brightness of the display to match ambient light levels. This is to ensure that a bright screen is not a distraction while driving at night.
Options: On and Off
Default: Off
- 24 Auto Power Off**
While recording, if Auto Power Off is turned OFF and the Dash Cam loses power: the Dash cam will turn off after 10 seconds.
While recording, if Auto Power Off is turned ON and the Dash Cam loses power: the Dash Cam will turn off after 30 seconds.
Options: On and Off
Default: Off

Setup Settings (cont.)

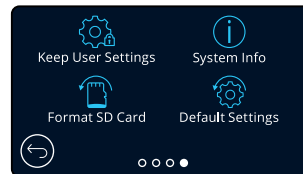

- 25 Keep User Settings**
Turn this ON in order to keep your preferred individual user settings during the Dash Cam firmware update process.
Select OFF in order to clear all user settings and return them to defaults during the Dash Cam update process.
Options: On and Off
Default Setting: On
- 26 System Info**
Information such as Dash Cam model, Battery status, Firmware version, and SD card information can be found here. This information covers multiple screens (pages), swipe left or right on the display to scroll through as required.
- 27 Format SD Card**
Format the inserted SD card. This will delete all content. If the format is unsuccessful, a message will appear on the display;
"Format failed, please try another SD Card (Class 10 128GB Max)."

Note: For stable performance, it is recommended that you format the SD card every 2-3 weeks. You should only do this AFTER you've downloaded any files from the card that you may want to keep.
- 28 Default Settings**
Resets the Dash Cam to default settings. Your recordings will not be affected.