

# 380 GWX

User Manual



## Table of Contents

TABLE OF CONTENTS	02	CAM VIEWER APP	
INTRODUCTION TO YOUR DASH CAM	03	- INTRODUCTION	32
USING CCTV IN A COMMERCIAL ENVIRONMENT	04	- CONNECT YOUR DEVICE / MAIN SCREEN	33
PRECAUTIONS / CAUTIONS ON USING THIS PRODUCT	05	- LIVE VIEW AND PIP	34
FCC STATEMENT	06	- DOWNLOADING RECORDINGS (iOS & ANDROID)	35
FCC-SUPPLIER'S DECLARATION OF CONFORMITY	07	- SHARING RECORDINGS / DASH CAM SETTINGS	36
PRODUCT SPECIFICATION	08	- DASH CAM SETTINGS	37 - 39
PACKAGE CONTENTS / PRODUCT FEATURES	09	PC CONNECTION	40
POWERED GPS MOUNT	10	NEXTBASE SD CARDS	41
FRONT FACING CAMERA - PARTS & CONTROLS	11 - 16	TROUBLESHOOTING	42 - 43
REAR FACING CAMERA - PARTS & CONTROLS	17	CE MARK INFO. / SOFTWARE LICENSE AGREEMENT	44
IN VEHICLE INSTALLATION	18 - 21	WARRANTY / ONLINE & INTERNATIONAL PURCHASES	45
CONNECTING YOUR DASH CAM TO CAM VIEWER APP	22 - 23		
INSTALLING YOUR DASH CAM (FRONT)	24 - 25		
POSITIONING YOUR DASH CAM (FRONT)	26		
INSTALLING YOUR DASH CAM (REAR)	27 - 28		
FINISHED DASH CAM & REAR CAM SETUP	29 - 30		
ANTI-TAMPER SECURITY INSTALLATION	31		

## Introduction to your Dash Cam

The Nextbase range of Dash Cams have been designed specifically with ease of use in mind, it is recommended NOT to change the default settings, which have been carefully selected to give the best performance for day to day use.

### Basic operation

The Dash Cam is set to record video, in files 1 minute in length. This means that each video file is a manageable size should you need to download and send to your insurance company. Eventually your MicroSD card will fill up with video files but don't worry, the camera automatically deletes the oldest file to make space for new recordings. This way you never run out of space and have plenty of driving historical evidence saved.

Typically a 16Gb card will store the last 2 hours of driving footage.

The Time and Date are automatically set upon the camera from satellite data. They will also update automatically for Daylight Savings Time, again based on the Country selected.

### Automatic Start / Stop Technology.

The Dash Cam senses power supplied to the cigarette lighter socket as soon as the vehicle ignition is turned on and will start to record automatically.

When the ignition is turned off, the Dash Cam will perform an automatic shutdown process.

### 1. Tips for capturing best video footage:

- 1.1 Position the Dash Cam in the centre of the windscreen and ideally behind the rear view mirror so it is not an obstruction to the driver's field of view.
- 1.2 Position the Rear Facing Camera towards the top-centre of the rear window, ensuring that it is not an obstruction to the driver's field of view.
- 1.3 Reduce the amount of sky in the picture, by angling the view of the camera towards the road. Too much sky will make the road appear darker due to the automatic exposure compensation.
- 1.4 Remove unnecessary items from your dashboard. If objects are placed on your dashboard these can cause reflections to be seen on the windscreen and these reflections may be captured during recording.

### 2. Tips for stable memory card performance:

- 2.1 Periodically format the memory card. Every 2-3 weeks we recommend that you reformat the memory card. This will wipe any files from the card and set it up afresh for continued use with your Dash Cam.  
Of course, you should only do this AFTER you've downloaded any files from the card that you may want to keep, as formatting the card will remove all content.
- 2.1 Format your memory card using the Dash Cam, this will make sure that the card is structured specifically for your camera.
- 2.2 Switch off the Dash Cam before removing or inserting the SD memory card, to prevent the chance of damage being caused to the memory card or the files stored upon it.

## Using CCTV in a Commercial Environment

When using the NEXTBASE 380GWX in a commercial vehicle you must ensure that you comply with any applicable legislation set out by the Government in your location. The following guide is written for usage of the product in the UK.

UK requirements include but are not limited to the Data Protection Act, the CCTV Code of Practice and the Surveillance Camera Code of Practice.

A simple CCTV Compliance Checklist is included upon the Software Disk included with the NEXTBASE 380GWX. Additional supporting documents are also included to help Data Controllers comply with applicable legislation. Example Policy and Procedure documents are also supplied (in editable Word document format) so that you can amend them to suit your business.

### CCTV Compliance Checklist Steps

1. The CCTV Code of Practice states that there should be a pressing need for a camera to be installed in your vehicle as using cameras can be privacy intrusive. You should ensure that you have identified a clear need for a camera to be installed (e.g. For the purpose of driver and passenger safety)
2. You must have a designated Data Controller who will be responsible for ensuring data is recorded correctly and securely as well as ensuring all Operators are aware of all relevant policies and procedures regarding the use of Dash Cams. The Data Controller must register with the Information Commission's Office (ICO). This can be done by visiting [www.ico.org.uk](http://www.ico.org.uk).
3. The CCTV Code of practice states that you must let people know when they are in an area where a surveillance system is in operation.

Supplied with your product are three 'CCTV Window Stickers' (shown below) for this purpose.

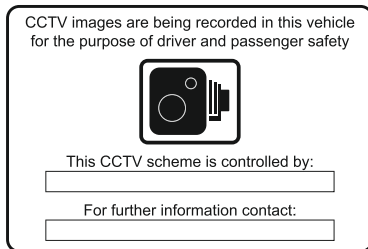

To comply with Surveillance Camera Legislation, the above window stickers should be located on all entrance points to your vehicle.

4. Using a suitable permanent marker pen please add contact details for CCTV / Data controller, before applying stickers to your vehicles windows
5. The Data Controller is responsible for ensuring that all Dash Cam operators/drivers are aware of their responsibilities regarding the data being recorded. Included in the "NEXTBASE Policy and Procedure Examples" Folder on the Software Disk is an Operator/Driver Briefing Checklist, to help the Data Controller monitor this.
6. The company should have clear, documented policies regarding all aspects of data being recorded and stored. These are covered individually later in the checklist. An example of a CCTV Recording Policy is included in the "NEXTBASE Policy and Procedure Examples" Folder on the Software Disk.
7. All Operators/Drivers should know where to find company policies and procedures for using the Dash Cam. This is covered in the Operator/Driver Briefing Checklist.
8. The Data Controller must state how long data is to be stored by the company. The CCTV Code of Practice states that data should be deleted once it is no longer needed. An example of a CCTV Data Storage Policy is included in the "NEXTBASE Policy and Procedure Examples" Folder on the Software Disk.
9. The Data Controller should specify how data is deleted once it is no longer needed. This is also covered in the CCTV Data Storage Policy example, on the Software Disk.
10. The Data Controller should decide who has access to stored data. This is also covered in the CCTV Data Storage Policy example on the Software Disk.
11. The Data Controller should decide how the company handles a request for access to data it has stored. An example of a CCTV Request for Access Policy is included in the "NEXTBASE Policy and Procedure Examples" Folder on the Software Disk.

Requests for Access can be made by members of the public or from Police forces.

Examples of both Public and Police request forms have been included in the "NEXTBASE Policy and Procedure Examples" Folder on the Software Disk.

CCTV Compliance Checklist and Example Documents produced using information provided by The Home Office, Information Commissioner's Office and the Surveillance Camera Commissioner. Contains public sector information licensed under the Open Government Licence v3.0.

## Precautions

Please read this manual carefully before operation and keep it for future reference. It will be helpful should you encounter any operational problem.

**WARNING:** Do not expose this product to rain, moisture or water under any circumstances, doing so may result in the risk of electric shock or fire.

**CAUTION:** To reduce the risk of electric shock, do not perform any servicing other than that contained in the instruction manual unless you are qualified to do so.  
Have the unit serviced by a qualified service technician if:  
The Unit has been exposed to rain or water.  
The unit does not seem to operate normally.  
The unit exhibits a marked change in performance.

**CHOKING HAZARD:** Some Products may contain components that are small enough to be swallowed. Please keep out of reach of children.

**WEEE:** Disposal of Waste Electrical and Electronic Equipment and/or Battery by users in private households in the European Union.  
 This symbol on the product or on the packaging indicates that this cannot be disposed of as household waste. You must dispose of your waste equipment and/or battery by handing it over to the applicable take-back scheme for the recycling of electronic equipment and/or batteries. For more information please contact your local household waste disposal office.

## Cautions on using this product

1. Ensure that the windscreen/rear window is free of dirt or grease before placing mount upon it.
2. Do not obscure the view of the road ahead or impede the deployment of any airbags in the event of an accident.
3. When not in use, please disconnect the car adaptor from both the 12/24Vdc outlet in your vehicle.
4. Only clean the device with a soft dry cloth, for tough dirt, apply some neutral detergent diluted in 5 to 6 parts water to a soft cloth.  
Note that alcohol, thinner, benzene etc could cause damage to the paint or coatings.
5. Avoid making contact with the lens as damage may be caused.
6. If required clean the glass lens carefully using spectacle lens cleaning fluid on a soft cloth only.
7. The video recordings made by this Dash Cam are intended for personal use only.
8. Publication of the recordings on Youtube, the internet or other methods are subject to the Data Protection Act and the requirements thereof must be adhered to.  
If the Dash Cam is to be used within a commercial environment, i.e. truck use, then the CCTV regulation apply also, in addition to the Data Protection Act regulations. This includes labelling to identify the use of CCTV is taking place, the omission of Audio recording and informing the relevant authorities of who controls the data.
9. Whilst driving, do not adjust the controls of your device as this is a distraction to driving.

## Radio Frequency Band and Power Information

Hereby, Portable Multimedia Limited declares that the Radio Equipment type 312GW is in compliance with the following directive 2014/53/EU. The full text of the EU Declaration Of Conformity is available at the following internet address: <https://www.nextbase.com/certifications/>

## Product Wireless Information

2400-2483.5 MHz: Wi-Fi (Max 16.3 dBm), BT (Max 6.0 dBm), BLE (Max 6.0 dBm).

## RF Exposure Information (MPE)

This device meets the EU requirements and the International Commission on Non-Ionising Radiation Protection (ICNIRP) on the limitation of exposure of the general public to electromagnetic fields by way of health protection. To comply with the RF exposure requirements, this equipment must be operated in a minimum of 20 cm separation distance to the user.

## FCC Statement

This device complies with Part 15 of the FCC Rules. Operation is subject to the following two conditions: (1) this device may not cause harmful interference, and (2) this device must accept any interference received, including interference that may cause undesired operation.

This equipment has been tested and found to comply with the limits for a Class B digital device, pursuant to Part 15 of the FCC Rules. These limits are designed to provide reasonable protection against harmful interference in a residential installation. This equipment generates, uses and can radiate radio frequency energy and, if not installed and used in accordance with the instructions, may cause harmful interference to radio communications. However, there is no guarantee that interference will not occur in a particular installation. If this equipment does cause harmful interference to radio or television reception, which can be determined by turning the equipment off and on, the user is encouraged to try to correct the interference by one or more of the following measures:

- Reorient or relocate the receiving antenna.
- Increase the separation between the equipment and receiver.
- Connect the equipment to an outlet on a circuit different from that to which the receiver is connected.
- Consult the dealer or an experienced radio/TV technician for help.
- This appliance and its antenna must not be co-located or operated conjunction with any other antenna or transmitter.
- A minimum separation distance of 20cm must be maintained between the antenna and the person for this appliance to satisfy the RF exposure requirements.

### **FCC CAUTION:**

Any changes or modifications to the equipment not expressly approved by the party responsible for compliance could void your authority to operate the equipment.

# FCC - SUPPLIER'S DECLARATION OF CONFORMITY STATEMENT

## SUPPLIER'S DECLARATION OF CONFORMITY

(47 CFR Section 2.906).

We; Tank Design

Hereby, Declare that the essential requirements set out in the 47 CFR Sections 2.906 of FCC, have been fully fulfilled on our product with indication below:

### 1. Applicant's Info

Company Name: Portable Multimedia Ltd  
Mailing Address: Unit 2, Caerphilly Business Park, Van Road, Caerphilly. CF83 3ED. UK  
Contact: Graham Lambert  
Tel: +44 02920 866429  
Email Address: Support@nextbase.co.uk

### 2. Product Info

Product Name: Dash Cam  
Model No.: NBDVR380GWX  
Brand Name: Nextbase

### 3. Applied Standard

Standards  
E-CFR Title 47 Part 15 Subpart B—Unintentional Radiators: 2017

Report No. TBC\*

### 4. Test Firm Used to Take Measurements:

Name: Waltek Services (Shenzhen) Co., Ltd.  
Address: 1/F, Fukangtai Building, West Baima Rd Songgang Street, Baoan District,  
Shenzhen, Guangdong, People's Republic of China, 518105  
Contact Name: Philo Zhong  
Tel: +86 755 8355 1033 802  
Email: CB@waltek.com.cn  
Designation No.: TBC\*  
FRN: TBC\*

### 5. FCC Marking



### 6. Responsibilities and obligations

Strictly follow the FCC rules of 2.906, 2.908, 2.909.

### 7. Applicant's Authorization

Company Name: Portable Multimedia Ltd  
Mailing Address: Unit 2, Caerphilly Business Park, Van Road, Caerphilly. CF83 3ED. UK  
Contact Person: Graham Lambert  
Signature: *G. Lambert*  
Email Address: Support@nextbase.co.uk  
Tel: +44 02920 866429  
Date: TBC\*

### 8. Responsible party in US.

Company Name: Tank Design  
Mailing Address: 158 Sidney Street, Cambridge, MA 02139, United States  
Contact Person: Mr Scott Watts  
Signature: *Scott Watts*  
Email Address: SWatts@tankdesign.com  
Tel: (617) 388-8380  
Date: TBC\*

\* Please visit <https://www.nextbase.com/en-gb/help-and-support/dash-cams/>  
download the latest 380GWX manual

A full list of certifications can be found at <https://www.nextbase.com/certifications/>

## Product Specification

<b>Model Number / Name</b>	NBDVR380GWX	NBDVR380GWX Rear Camera
<b>Power Requirements</b>	5V / 1.5A	Video and Power supplied through connection to Dash Cam.
<b>Power Supply</b>	12-24Vdc Car Power Cable (supplied) Fuse Type: 20mm / 1.5A Output: 5Vdc	
<b>Sensor Resolution</b>	2.12M Pixel	2.12M Pixel
<b>Lens - Type / Angle / Aperture</b>	6G / 140° / F1.8	6G / 140° / F1.8
<b>Recording Resolution</b>	1920 x 1080 @ 30fps	1920 x 1080 @ 30fps
<b>Card Reader</b>	8 - 128GB MicroSD Card	
<b>SD Card (Recommended Type)</b>	8 - 128GB MicroSD Card, Class 10 for best results use a Nextbase branded SD Card.	
<b>SD Card Recorded file Capacity (Single Camera, based on default settings)</b>	8GB MicroSD = 60 minutes 16GB MicroSD = 120 minutes 32GB MicroSD = 240 minutes 64GB MicroSD = 480 minutes 128GB MicroSD = 960 minutes	With the Rear Cam attached, recording times will be significantly reduced.
<b>Recording Format</b>	.MOV	.MOV
<b>Unit Dimensions (inc. mount)</b>	W58mm x L98mm x H47mm	W49mm x L68mm (+30cm connector cable) x H37mm
<b>Unit Weight (inc. mount)</b>	125g	125g
<b>Cam Viewer (min req.)</b>	V5.1	
<b>Android</b>	10.3	
<b>iOS</b>		
<b>Replay 3 (min req.)</b>	Windows7	
<b>Windows</b>	10.7	
<b>Mac</b>		

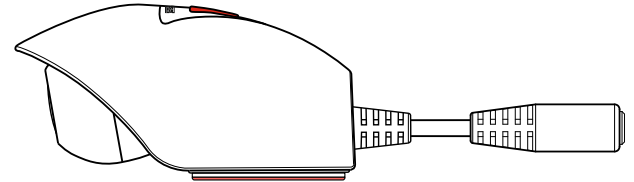
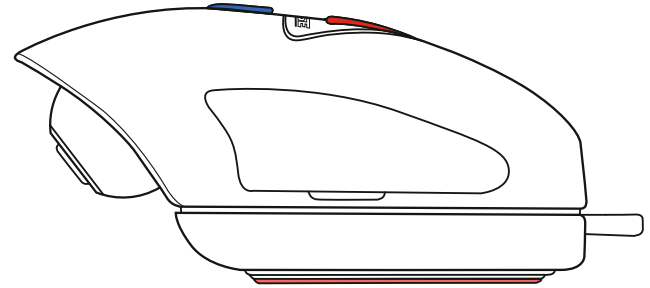

Android is a trademark of Google Inc. in the United States and other countries.

Mac is a registered trademarks of Apple Inc. in the United States and other countries.

iOS is a trademark or registered trademark of Cisco in the United States and other countries.

© 2015 Google Inc. All rights reserved. Google Maps™ mapping service is a trademark of Google Inc.

Windows is a registered trademark of Microsoft Corporation in the United States and other countries.

NEXTBASE Replay 3 is a registered trademark of Portable Multimedia LTD in the United Kingdom.

NEXTBASE Cam Viewer is a registered trademark of Portable Multimedia LTD in the United Kingdom.

microSD™ and the microSD logo are trademarks of SD-3C, LLC.

Wi-Fi® is a registered mark of Wi-Fi Alliance Corporation.

Other trademarks and trade names are those of their respective owners.



## Package Contents

Please check the contents of your NEXTBASE product.

Dash Cam, Mount, &  
Rear Facing Camera Module

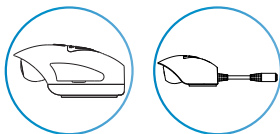

Your Dash Cam and Rear Camera can record both the road and the road behind you

Car Power Cable

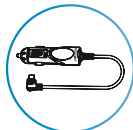

Charge your Dash Cam in your vehicle using the Car Power Cable.

USB Cable

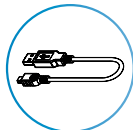

Connect your Dash Cam to your PC.

Security Pack



Use the additional security attachments to prevent tampering with the Dash Cam.

Quick Start Guide



Quickly get your Dash Cam set up and running using the Quick Start Guide.

Window Stickers



Stickers for CCTV usage and to warn other road users that your vehicle is protected.

Manual, CCTV, & Software Disk



Everything you need to get you started with your Dash Cam.

Product appearance may differ slightly to that shown above.

## Product Features

Thank you for purchasing this Nextbase Dash Cam, in this section we will outline some of the features available with this Dash Cam.

Designed in the UK the 380GWX is discreet and fits neatly at the top of the windscreen to record the road ahead in FULL 1080p HD to ensure that you capture every detail such as road signs and number plates. The Nextbase 380GWX Dash Cam has been made specifically for the commercial and fleet market, protecting both business and your drivers. The 380GWX has also been designed to be compatible with a Rear Facing Camera, to cover your view of the road behind you, as well as the road ahead.

By having a unique lens with 90 degree vertical adjustment the Nextbase 380GWX is the only Dash Cam really suited to commercial cars, vans and trucks with flat windscreens.

With any Dash Cam a key concern of any fleet manager is making sure that the device is running at all times. On the side of the Nextbase 380GWX are special security covers, protecting the user controls to make sure the device is working. The SD card, power connector and On/Off button can all be locked away with security to ensure that the camera is running at all times and there is no chance of the SD card being tampered with.

1. Corporate responsibility – protect your employees and drivers on the road.
2. Prove that your driver wasn't to blame in the event of an incident.
3. In the event of an accident – Dash Cam footage can significantly reduce insurance claim time to get your fleet vehicles back on the road sooner.
4. Protect your brand reputation – by having a Dash Cam Drivers tend to be more cautious, on average 33% safer than without a Dash Cam\*

\*telematics scores with and without Dash Cam fitted

For Help and Support please call 02920 866 429

## Powered GPS Mount

Please see below to identify the parts of the supplied GPS mount.

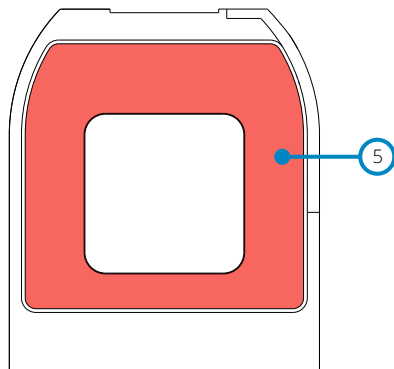
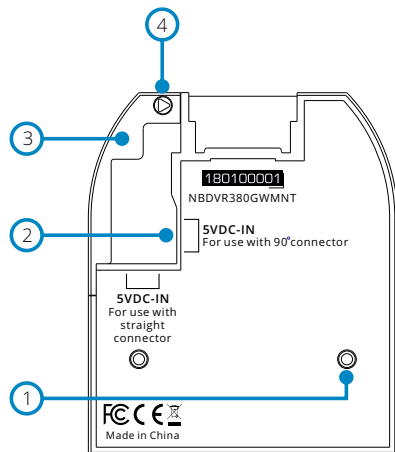

- 1 Locking Pins**  
These pins will locate and then allow the camera to be attached to the mount.
- 2 DC-IN Sockets**  
There are two sockets available, one for use with the supplied 90° car adaptor, the other for use with the Nextbase Hardwire Kit (sold separately) which uses a straight connector.  
Please contact your Nextbase retailer to purchase the Nextbase Hardwire Kit.
- 3 Cable Lock**  
The cable lock secures the car adaptor or hardwire kit cable to the mount.
- 4 Cable Lock Anti-Tamper Screw**  
Location of the anti-tamper screw, that can be used to secure the cable lock to the mount.

- 5 Adhesive Pad**  
Once the backing tape has been removed this adhesive pad will securely adhere the mount to your windscreen.

### Note:

- Before removing the red backing tape from the adhesive pad make sure you have determined the optimum position for the Dash Cam (see page 26) and that the windscreen is free of dust and/or dirt.
- A spare adhesive pad has been provided, in case you wish to change the mounts location.

## Front Facing Camera - Parts and Controls

Please see below to identify the parts and controls of your Dash Cam.

Left side:

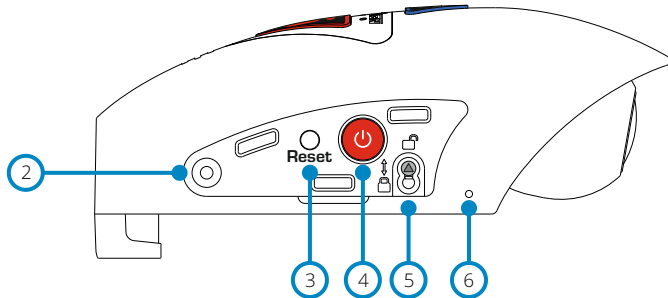
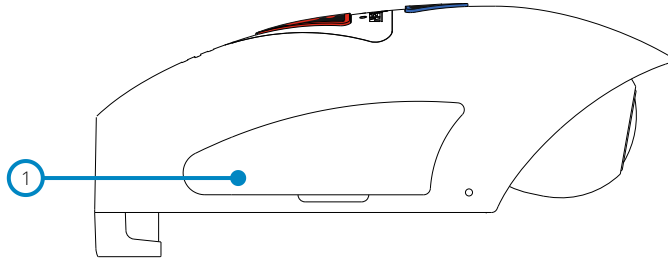

- ① **Side Cover**  
There are two types of side cover supplied:

Standard covers:

These are fitted when the Dash Cam as standard and are used during normal operation. Remember to replace the side cover before use.

Locking covers:

Included within the Security Pack are two locking covers, these can be secured to the Dash Cam using the supplied anti-tamper screws. This allows the owner of the vehicle to prevent un-authorised access to or operation of the Dash Cam.

- ② **Anti-Tamper Screw Insert**  
Insert thread for the anti-tamper screw.

- ③ **Reset Button**  
In the unlikely event the Dash Cam becomes unresponsive, press the RESET button to restart the Dash Cam.

- ④ **Power & Start / Stop Recording Button**  
Long press (2 seconds) power On/Off the Dash Cam.  
Short press to start / stop recording.

- ⑤ **Camera to Mount Locking Screw**  
The camera can be secured to the mount to prevent un-authorised removal, see pages 41 - 42 for further details.

- ⑥ **Microphone**  
Integral microphone for audio recording, this can be turned off via the Cam Viewer App.

## Front Facing Camera - Parts and Controls (contd.)

Please see below to identify the parts and controls of your Dash Cam.

Right side:

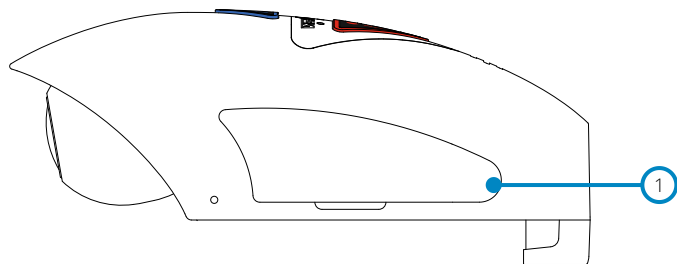

① **Side Cover**  
Removable side cover, remember to replace the side cover before use.

② **Anti-Tamper Screw Insert**  
Insert thread for the anti-tamper screw.

③ **USB Socket**  
Connect the supplied USB data cable here to connect the Dash Cam to a computer.

**Note:**  
During normal use the car power cable is connected to the mount, not directly to this socket.

④ **SD Card Slot**  
Insert the MicroSD card here, taking care that the gold contacts are facing towards the mount.

⑤ **Camera to Mount Locking Screw**  
The camera can be secured to the mount to prevent un-authorized removal, see pages 31 for further details.

