



Instruction For Use

Vi-CELL BLU

Cell Viability Analyzer



PN C13232AA7 FINAL
June 2018



Beckman Coulter, Inc.
250 S. Kraemer Blvd.
Brea, CA 92821 U.S.A.

FINAL

Subject_to_Technical_Review



Vi-CELL BLU Cell Viability Analyzer

Instructions for Use

PN C13232AA5 (April 2018)

© 2018 Beckman Coulter, Inc.

All Rights Reserved

Beckman Coulter, the stylized logo, and the Beckman Coulter product and service marks mentioned herein are trademarks or registered trademarks of Beckman Coulter, Inc. in the United States and other countries.

Contact Us

If you have any questions, contact our Customer Support Center.

- Worldwide, find us via our website at www.beckmancoulter.com/customersupport/support.
- In the USA and Canada, call us at 1-800-369-0333.
- Outside of the USA and Canada, contact your local Beckman Coulter Representative.

EC REP

Beckman Coulter Eurocenter S.A.
22, rue Juste-Olivier
Case Postale 1044
CH - 1260 Nyon 1, Switzerland
Tel: +41 (0) 22 365 36 11

Draft Labeling
Subject to Technical Review

Revision History

Initial Issue, 05/18
Software version 1.0

This document applies to the latest software listed and higher versions. When a subsequent software version affects the information in this document, a new issue will be released to the Beckman Coulter Web site. For labeling updates, go to www.beckmancoulter.com and download the latest version of the manual or system help for your instrument.

Draft Labeling
Subject to Technical Review

Draft Labeling
Subject to Technical Review

Safety Notice

Read all product manuals and consult with Beckman Coulter-trained personnel before attempting to operate instrument. Do not attempt to perform any procedure before carefully reading all instructions. Always follow product labeling and manufacturer's recommendations. If in doubt as to how to proceed in any situation, [contact us](#).

Beckman Coulter, Inc. urges its customers to comply with all national health and safety standards such as the use of barrier protection. This may include, but is not limited to, protective eyewear, gloves, and suitable laboratory attire when operating or maintaining this or any other automated laboratory analyzer.

Alerts for Warning and Caution

Throughout this manual, you will see the appearance of these alerts for Warning and Caution conditions:



WARNING indicates a potentially hazardous situation, which, if not avoided, could result in death or serious injury.

In this document the signal word WARNING is only used to indicate the possibility of personal injury. It is not used to indicate the possibility of erroneous data.



CAUTION indicates a potentially hazardous situation, which, if not avoided, may result in minor or moderate injury. It may also be used to alert against unsafe practices.

Safety Precautions

WARNING

Risk of operator injury if:

- All doors covers and panels are not closed and secured in place prior to and during instrument operation.
- Instrument alarms and error messages are not acknowledged and acted upon.
- You mishandle broken parts.
- Doors, covers and panels are not opened, closed, removed and/or replaced with care.
- Improper tools are used for troubleshooting.

To avoid injury:

- Keep doors, covers and panels closed and secured in place while the instrument is in use.
- Take full advantage of the safety features of the instrument.
- Acknowledge and act upon instrument alarms and error messages.
- Keep away from moving parts.
- Report any broken parts to your Beckman Coulter Representative.
- Open/remove and close/replace doors, covers and panels with care.
- Use the proper tools when troubleshooting.

CAUTION

System integrity could be compromised and operational failures could occur if:

- This equipment is used in a manner other than specified. Operate the instrument as instructed in the Product Manuals.
- You introduce software that is not authorized by Beckman Coulter into your computer. Only operate your system's computer with software authorized by Beckman Coulter.
- You install software that is not an original copyrighted version. Only use software that is an original copyrighted version to prevent virus contamination.
- You connect external devices such as thumb drives and external hard drives. Ensure that all external devices are free from viruses before connecting.

CAUTION

If you purchased this product from anyone other than Beckman Coulter or an authorized Beckman Coulter distributor, and, it is not presently under a Beckman Coulter service maintenance agreement, Beckman Coulter cannot guarantee that the product is fitted with the most current mandatory engineering revisions or

that you will receive the most current information bulletins concerning the product. If you purchased this product from a third party and would like further information concerning this topic, call your Beckman Coulter Representative.

 **WARNING**

California Proposition 65: This product can expose you to chemicals including phthalates, which are known to the State of California to cause cancer and birth defects or other reproductive harm. For more information go to www.P65Warnings.ca.gov.

General Warning and Cautions

 **WARNING**

Risk of infection. Dispose and handle all solid waste and Reagent Packs as biohazardous waste. Follow your local regulations.

Always use the appropriate Personal Protective Equipment (PPE) when working with biohazardous materials. If unsure, ask your Laboratory Safety Officer.

Use universal precautions when working with pathogenic materials. Means must be available to decontaminate the instrument and to dispose of biohazardous waste.

 **WARNING**

Risk of operator injury or biohazardous contamination if you have skin contact with the sample probe or reagent probe. The sample probe or reagent probe might contain residual biological material and must be handled with care. Clean up spills immediately.

Use universal precautions when working with pathogenic materials. Means must be available to decontaminate the instrument and to dispose of biohazardous waste.

Always use the appropriate Personal Protective Equipment (PPE) when working with biohazardous materials.

 **WARNING**

Risk of infection. Only let authorized personnel collect and work with biologic samples. Make sure to wear gloves.

Use universal precautions when working with pathogenic materials. Means must be available to decontaminate the instrument and to dispose of biohazardous waste.

 **WARNING**

Risk of infection. Make sure that you wear gloves during replacement and maintenance procedures.

Use universal precautions when working with pathogenic materials. Means must be available to decontaminate the instrument and to dispose of biohazardous waste.

 **CAUTION**

Risk of operator injury. The reagent door and the sample station contain automated moving parts. Use caution around these areas to avoid injury.

 **CAUTION**

Risk of instrument damage. If conditions cause static charge to exist in your lab, be sure to properly ground yourself before touching the instrument.

Electrical Safety

To prevent electrically related injuries and property damage, properly inspect all electrical equipment prior to use and immediately report any electrical deficiencies. [Contact us](#) for any servicing of equipment requiring the removal of covers or panels.

 **CAUTION**

Risk of electric shock. The external power supply module uses a three-wire power cord and plug to connect it to earth-ground. Make sure that the matching wall outlet receptacle is properly wired and earth-grounded. Never cut-off the plug's ground pin or use a three prong to two prong adapter.

 **CAUTION**

Risk of equipment damage. This instrument uses an external, certified, power supply module. Do not substitute with another power supply module. If you experience problems, immediately unplug the power supply module from the wall outlet and call a Beckman Coulter representative for assistance.

 **CAUTION**

Risk of instrument damage. The power-supply cord and plug of the analyzer must comply with national regulations. External devices connected to the analyzer must be in compliance with the standard UL 60950 for US and IEC 60950 for Europe. If the regulations are not complied with, the equipment may be damaged.

EMC

 **CAUTION**

It is advised that prior to operation of the device, the electromagnetic environment should be evaluated. Do not use this device in close proximity to sources of strong electromagnetic radiation (for example, unshielded intentional RF sources), as these could interfere with the proper operation.

 **CAUTION**

Changes or modifications not expressly approved could void your authority to use this equipment.

Certification

Canadian Radio Interference-Causing Equipment Regulation, IECS-003, Class A:

Supporting test records reside with the manufacturer.

This Class A digital apparatus meets all requirements of the Canadian Interference-Causing Equipment Regulations.

Cet appareil numérique de classe A répond à toutes les exigences de la réglementation canadienne sur les équipements provoquant des interférences.

FCC Part 15, Class "A" Limits

Supporting test records reside with the manufacturer. The device complies with Part 15 of the FCC Rules. Operation is subject to the following conditions:

1. The equipment may not cause harmful interference.

2. The equipment must accept any interference received, including interference that may cause undesired operation.

Changes or modifications to this equipment not expressly approved by the party responsible for compliance could void the user's authority to operate the equipment. This equipment has been tested and found to comply with the limits for a Class A digital device, pursuant to Part 15 of the FCC rules. These limits are designed to provide reasonable protection against harmful interference when the equipment is operated in a commercial environment. This equipment generates, uses and can radiate radio frequency energy and, if not installed and used in accordance with the instruction manual, may cause harmful interference to radio communications. Operation of this equipment in a residential area is likely to cause harmful interference, in which case the user will be required to correct the interference at their expense. The following techniques can be used to reduce interference problems:

1. Disconnect the equipment from its power source to verify that it is or is not the source of the interference.
2. If the equipment is connected to the same outlet as the device experiencing interference, connect the equipment to a different outlet.
3. Move the equipment away from the device receiving the interference.
4. Reposition the receiving antenna for the device receiving the interference.
5. Try combinations of the above.

RFID Module

This instrument contains an internal radio frequency identification device (RFID) certified for the countries in which it will be marketed. Certification IDs are listed on the exterior label of the instrument. Refer to for RFID specifications.

Registration Information

Parameter	Value
FCC identification number	FCC ID: 2AOSQRFIDM2
Canadian ISED identification number	IC: 23864-RFIDM2
KCC certification number	R-CMM-bci-RFIDM2
Japan certification number	TBD
Frequency	13.56 MHz to ± 7 kHz
RF output power	<200 mW

Disposal of Electronic Equipment

It is important to understand and follow all laws regarding the safe and proper disposal of electrical instrumentation.



The symbol of a crossed-out wheeled bin on the product is required in accordance with the Waste Electrical and Electronic Equipment (WEEE) Directive of the European Union. The presence of this marking on the product indicates:

- That the device was put on the European Market after August 13, 2005 and
- That the device is not to be disposed via the municipal waste collection system of any member state of the European Union.

For products under the requirement of WEEE directive, please contact your dealer or local Beckman Coulter office for the proper decontamination information and take back program which will facilitate the proper collection, treatment, recovery, recycling, and safe disposal of device.

Draft Labeling
Subject to Technical Review

Moving Parts

WARNING

Risk of personal injury. To avoid injury due to moving parts, observe the following:

- Never attempt to exchange labware, reagents, or tools while the instrument is operating.
- Never attempt to physically restrict any of the moving components of the instrument.
- Do not override instrument interlocks
- Keep the instrument work area clear to prevent obstruction of the movement.

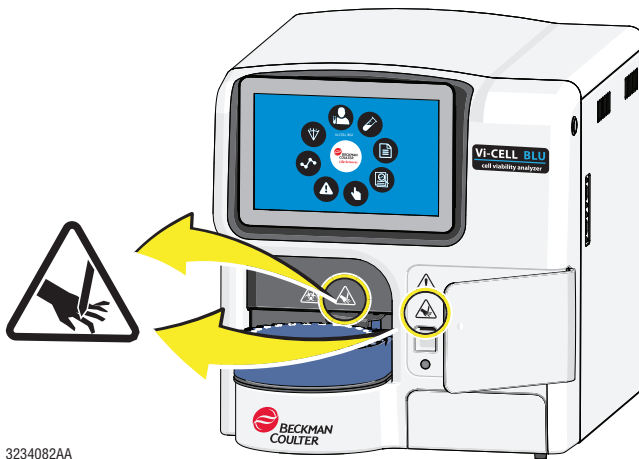

Cleaning

WARNING

Risk of infection. Make sure that you wear gloves during replacement and maintenance procedures.

Use universal precautions when working with pathogenic materials. Means must be available to decontaminate the instrument and to dispose of biohazardous waste.

Always use the appropriate Personal Protective Equipment (PPE) when working with biohazardous materials. If unsure, check with your Laboratory Safety Officer or Lab Supervisor.

Observe the cleaning procedures outlined in this manual for the instrument. Prior to cleaning equipment that has been exposed to hazardous material:

- Contact the appropriate Chemical and Biological Safety personnel.

- Review the Chemical and Biological Safety information in the this manual.

Maintenance

Perform only the maintenance described in this manual. Maintenance other than that specified in this manual should be performed only by service engineers.

IMPORTANT It is your responsibility to decontaminate components of the instrument before requesting service by a Beckman Coulter Representative or returning parts to Beckman Coulter for repair. Beckman Coulter will NOT accept any items which have not been decontaminated where it is appropriate to do so. If any parts are returned, they must be enclosed in a sealed plastic bag stating that the contents are safe to handle and are not contaminated.

RoHS Notice

These labels and materials declaration table (the Table of Hazardous Substance's Name and Concentration) are to meet People's Republic of China Electronic Industry Standard SJ/T11364-2006 "Marking for Control of Pollution Caused by Electronic Information Products" requirements.





RoHS Caution Label



This label indicates that the electronic information product contains certain toxic or hazardous substances. The center number is the Environmentally Friendly Use Period (EFUP) date, and indicates the number of calendar years the product can be in operation. Upon the expiration of the EFUP, the product must be immediately recycled. The circling arrows indicate the product is recyclable. The date code on the label or product indicates the date of manufacture.

Safety Symbols

Safety symbols alert you to potentially dangerous conditions. The symbol applies to specific procedures and appears as needed throughout this manual.

Symbol	Warning Condition	Action
	Biohazard	Use universal precautions when working with pathogenic materials. Means must be available to decontaminate the instrument and to dispose of biohazardous waste.
	Consider all materials (specimens, controls, monoclonal antibodies, and so forth) as being potentially infectious. NOTE This symbol does not appear on the instrument. This symbol is used in instrument documentation	Wear standard laboratory attire and follow safe laboratory procedures when handling any material in the laboratory.
	Caution / Warning	Refer to the appropriate section in this manual for more information.
	Pierce hazard The instrument contains probes and moving parts. <ul style="list-style-type: none"> • The probes are sharp and the probe motor is strong enough to cause the probe to puncture your skin. • The probe may contain biohazardous materials, including controls, monoclonal antibodies, and blood samples. • The probe is in motion during many types of instrument cycles such as startup and shutdown, not just during sample analysis. 	Avoid any unnecessary contact with the probe and probe area. Always use caution when working in the probe area.
	A "CE" mark indicates that a product has been assessed before being placed on the market, and has been found to meet European Union safety, health, and/or environmental protection requirements.	None

Draft Labeling Technical Review
Subject to Technical Review

Contents

Revision History, iii

Safety Notice, v

Introduction, xxi

CHAPTER 1: Introducing the Vi-CELL BLU, 1-1

System Overview, 1-1

Sequence of Analysis Events, 1-1

Vi_CELL BLU Normal Mode, 1-1

Vi_CELL BLU Fast Mode, 1-2

Measuring Viability And Cellular Parameters, 1-3

Why Measure Viability?, 1-3

Historical Perspective – The Hemacytometer, 1-3

How Viability is Determined, 1-3

The Trypan Blue Dye Exclusion Method, 1-3

An Image Analysis Solution, 1-3

System Components, 1-5

Software, 1-6

CHAPTER 2: Installation and Verification, 2-1

Special Requirements – Pre-installation Checks, 2-1

Environment, 2-1

Power Requirements, 2-1

Temperature and Humidity Requirements, 2-2

Worktable, 2-2

Ventilation and Cleaning, 2-3

Installation, 2-4

Materials Shipped, 2-4

Unpacking, 2-5

Connecting the Instrument, 2-6

First time Login, 2-8

Home Screen, 2-9

Install a Reagent Pack, 2-11

System Settings, 2-16

Setup Users, 2-19

User Administration, 2-19

- Add a User, 2-19
 - Edit a User, 2-20
 - My Profile, 2-21
 - Instrument Status, 2-22
 - Instrument Performance Verification, 2-22
 - Daily Verification, 2-22
 - CHAPTER 3: Startup, 3-1**
 - Daily Startup, 3-1
 - Setting Up Preferences, 3-3
 - CHAPTER 4: Run Samples, 4-1**
 - Add Carousel Samples to the Queue, 4-1
 - Add 96 Well Plate Samples to the Queue, 4-4
 - Run Results, 4-8
 - Camera Image Options, 4-9
 - Bioprocess Results, 4-12
 - What Is A Bioprocess?, 4-12
 - Signoff Results, 4-14
 - CHAPTER 5: Data Analysis, 5-1**
 - Reviewing/Reanalyze Data, 5-1
 - Import Results, 5-2
 - Export Results, 5-4
 - CHAPTER 6: Software Administration, 6-1**
 - Cell Type Administration, 6-1
 - What is a Cell Type?, 6-1
 - Cell Type Screen, 6-1
 - Reports Administration, 6-4
 - Report Results, 6-4
 - Completed Run Summary Reports, 6-4
 - Run Results Reports, 6-5
 - Bioprocess Reports, 6-7
 - Quality controls Reports, 6-8
 - Cell type Reports, 6-10
 - Instrument Reports, 6-11
 - Storage Administration, 6-11
 - User Types and Access Levels, 6-12

Draft Labeling Technical Review
Subject to Technical Review

CHAPTER 7:	Quality Control, 7-1
	What Is The Control Feature?, 7-1
	Run a Concentration Control, 7-1
CHAPTER 8:	Regulatory Compliance – 21 CFR Part 11, 8-1
	21 CFR Part 11 , 8-1
	Electronic Records, 8-1
	FDA Requirements, 8-2
	Implementing Electronic Records and Signatures, 8-2
	Controls for Electronic Records, 8-2
	Establishing an Electronic Record, 8-3
	21 CFR Part 11 Security, 8-3
	File History, 8-3
	Electronic Signature, 8-4
	Generating Electronic Signatures, 8-5
	Applying Electronic Signatures, 8-5
APPENDIX A:	System Specifications, A-1
	Data Acquisition, A-1
	Cell Viability/Concentration/Cell Count, A-1
	Physical Requirements, A-1
	Unit Dimensions, A-2
APPENDIX B:	Service and Maintenance, B-1
	Focusing Wizard, B-1
	Set Focus, B-1
	Calibration Control, B-2
APPENDIX C:	Statistics, C-1
	Circularity, C-1
	System Performance, C-1
	Run Statistics, C-1
	Effective Field of View, C-1
APPENDIX D:	Troubleshooting, D-1
	Troubleshooting Table, D-1
APPENDIX E:	Replacing Reagents and Decontamination, E-1
	Reagent Status, E-1
	Replace Reagent Pack, E-1

Prime the Instrument, E-9
Decontaminate, E-9
Decontaminate with Vaporized Hydrogen Peroxide, E-11

Abbreviations

Index

Beckman Coulter, Inc.
Customer End User License Agreement

Related Documents

Draft Labeling
Subject to Technical Review

Illustrations

- 1.1 Trypan Blue Dye Exclusion Method, 1-4
- 1.2 Vi-CELL BLU with carousel, 1-5
- 1.3 Vi-CELL BLU with 96 well plate, 1-6
- 2.1 Home screen, 2-9
- 2.2 Main menu, 2-10

Draft Labeling
Subject to Technical Review

Tables

5	Registration Information, -x
2.1	Main menu buttons, 2-10
6.1	User Types and Access Levels, 6-12
D.1	Troubleshooting Table - Instrument, D-1
D.2	Troubleshooting Table - Controller Board (Main Board), D-3
D.3	Troubleshooting Table - Reagents, D-3
D.4	Troubleshooting Table - Motion, D-5
D.5	Troubleshooting Table - Fluidics, D-6
D.6	Troubleshooting Table - Imaging, D-7

Draft Labeling
Subject to Technical Review

Manual Description

This manual is intended to provide the user with information needed to operate and maintain the Vi-CELL BLU system safely and effectively.

Conventions

This manual applies the following conventions:

- Menu and dialog items that can be selected or clicked appear in **bold** type.
- Blue text indicates that you can click on the text to access related information.
- Instrument may be used when referring to the Vi-CELL BLU system.
- The terms “screen” and “window” are used interchangeably.
- *Italics font* indicates screen text displayed on the instrument, such as *Preparing Samples*.
- The term “select” is used to indicate either one or both of the following actions:
 - To tap or touch with your finger.
 - To click with a mouse.
- The software path to a specific function or screen appears with the greater than (>) symbol between the succeeding screen options, like this: File > Open Protocol.

NOTE A **Note** is used to call attention to notable information that should be followed during installation, use or maintenance of this equipment.

IMPORTANT An **IMPORTANT** is used for comments that add value to the step or procedure being performed. Following the advice in the **IMPORTANT** adds benefit to the performance of a piece of equipment or to a process.

Safety

See also [Safety Notice](#) in the Safety chapter.

Hazardous Waste Precautions

Always observe local and state regulations regarding the handling and discarding of hazardous waste. Refer to the Material Safety Data Sheet for more information.

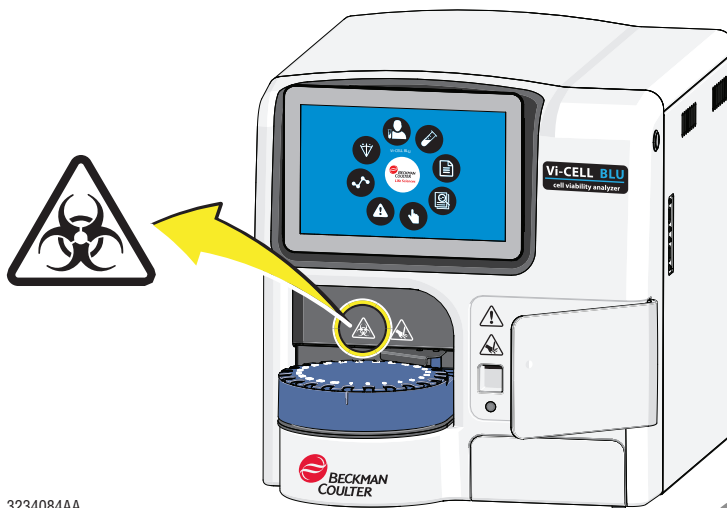

3234084AA

If a hazardous substance such as blood or biological sample is spilled, clean up the spill by using your laboratory decontamination procedure. Then follow your laboratory procedure for disposal of hazardous materials.

Reagent Specific Precautions

Observe warnings on the packaging of Reagents (Vi-CELL BLU Reagent Pack) and other materials as well as Material Safety Data Sheets.

Other Precautions

Warnings

 **WARNING**

If the equipment is used in a manner not specified by Beckman Coulter, Inc., the protection provided by the equipment may be impaired.

NOTE For Safety Data Sheets (SDS/MSDS) information, go to the Beckman Coulter website at www.beckmancoulter.com.

 **WARNING**

Risk of biohazard contamination. Toxicity, safety, and proper handling procedures for diluents and reagents used should be adhered to at all times. To prevent biohazard contamination consult appropriate safety manuals, Safety Data Sheets and Material Safety Data Sheets for the items.

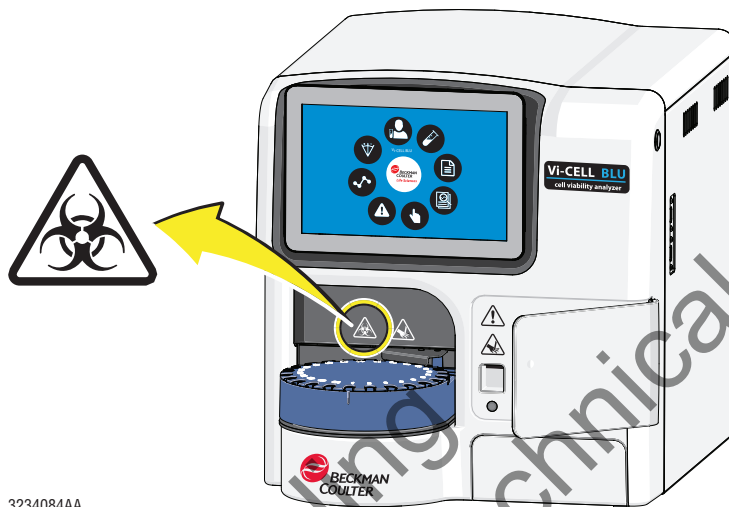

3234084AA

Draft Labeling
Subject to Technical Review

Introducing the Vi-CELL BLU

System Overview

This manual is intended to provide the user with information needed to operate and maintain the Vi-CELL BLU system safely and effectively.

The Vi-CELL BLU Cell Viability Analyzer is a video imaging system for analyzing yeast, insect and mammalian cells in culture media or in suspension. It automates the widely accepted trypan blue dye exclusion protocol and is designed to analyze a wide variety of cell types. The software includes features to monitor bioreactors and other cell culture processes and is designed to facilitate compliance with the US Food and Drug Administration's (FDA) regulations on electronic records and electronic signatures (21 CFR Part 11).

The main features of the system are:

- Fully automated sample preparation, analysis and post run cleaning
- Cell Viability reported in percentage, concentration and cell count
- Concentration range of 50,000 to 15,000,000 cells per mL
- Cell size range of 2 microns to 60 microns
- 24-position carousel auto-sampler
- 96 well plate auto-sampler
- User-friendly reagent system

Sequence of Analysis Events

IMPORTANT The Vi-CELL BLU performs an auto flush every 24 hour period at 6:00AM. If the unit is turned off during its scheduled flush, it will perform a flush upon the next turn on. For best results, Vi-CELL Blue **Normal Mode** requires an accurately measured initial sample volume of 0.2 mL +/- 0.02 mL.

Vi_CELL BLU Normal Mode

The time to complete one cycle in the Vi-CELL BLU **Normal Mode** is approximately 2:15 minutes. Lena says this needs to be verified, she timed it at 2 min The time to complete is subject to change based upon number of images taken and analysis time.

- The carousel rotates or sample plate and places the sample under the sample probe.
- The sample probe lowers into the sample.
- The syringe aspirates the full volume of 0.6 mL.
- The syringe dispenses the sample back into the well or vial to re-suspend all cells.

- The syringe aspirates the complete sample of 0.6 mL.
- The syringe dispenses all but 0.15 mL (Vi-CELL BLU) of the sample to waste.
- The syringe draws in 0.15 mL of trypan blue. [Lena says this is 0.6 mL?](#)
- The sample and trypan blue is mixed by being dispensed into the cup and drawn back into the syringe as specified in the cell type parameter.
- The mixed sample is now dispensed through the flow cell for image collection.
- The remaining sample is dispensed to waste.
- The flow cell is rinsed and back flushed.
- The sample vial or well is rinsed with cleaning agent.
- The flow cell and sample vial or well are rinsed with disinfectant.
- The flow cell and sample vial or well are rinsed with buffer.
- The aspiration tube is dried for 1 cycle with air.
- The sample probe raises from the sample vial or well.
- The carousel rotates and ejects the sample vial.

Vi_CELL BLU Fast Mode

The time to complete one cycle in the Vi-CELL BLU **Fast Mode** is approximately 1:45 minutes. The time to complete is subject to change based upon number of images taken and analysis time.

IMPORTANT Vi-CELL BLU **Fast Mode** requires an accurately measured initial sample volume of 170uL.

- The carousel rotates and places the sample under the sample probe.
- The sample probe lowers into the sample.
- The syringe primes the valve with buffer.
- The syringe draws in 0.15 mL of trypan blue.
- The sample and trypan blue is mixed by being dispensed into the cup and drawn back into the syringe as specified in the cell type parameter.
- The mixed sample is now dispensed through the flow cell for image collection.
- The remaining sample is dispensed to waste.
- The flow cell is rinsed and backflushed.
- The sample vial or well is rinsed with cleaning agent.
- The flow cell and sample vial or well are rinsed with buffer.
- The aspiration tube is dried for 1 cycle with air.
- The sample probe raises from the sample vial or well.
- The carousel rotates and ejects the sample vial.

Measuring Viability And Cellular Parameters

Why Measure Viability?

The measurement of overall health of cell cultures requires accurate measurements of both cell concentration and percentage of viable or live cells. This data is essential to the decision making process for basic tissue culture cell growth and maintaining optimum culture conditions in bioreactors.

Historical Perspective – The Hemacytometer

Cell viability (Trypan Blue Dye Exclusion Method) determinations traditionally have been performed using a light microscope and hemacytometer. Unfortunately, this technique has numerous major shortcomings. The hemacytometer has a significant repeatability error. Different technicians analyzing the same cell sample obtain variations in results. In addition, the manual method is tedious and quite time consuming for today's busy laboratory environment.

How Viability is Determined

The Trypan Blue Dye Exclusion Method

The widely accepted method for cell viability determination is the Trypan Blue Dye Exclusion Method. When cells die, their membranes become permeable allowing for the uptake of the trypan blue dye. As a result, the dead or non-viable cells become darker than the viable cells. This contrast is what is measured in order to determine viability.

An Image Analysis Solution

The Beckman Coulter Vi-CELL BLU automates the Trypan Blue Dye Exclusion Method. Utilizing video capture technology and sample handling, the Vi-CELL BLU takes the cell sample and delivers it to a flow cell and camera for imaging. The Vi-CELL BLU default setting will capture at least 80 images for its determination of cellular viability.

The software determines which cells have absorbed trypan blue dye and those that have not. Cells absorbing the trypan blue dye appear darker hence have lower gray scale values. Cells with higher gray scale values are considered viable.

Figure 1.1 Trypan Blue Dye Exclusion Method

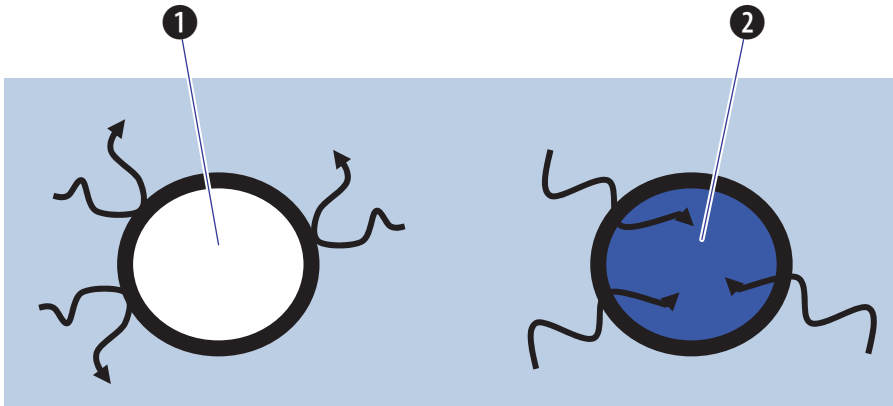

1. Live cells exclude dye
2. Dye permeable dead cells

Draft Labeling
Subject to Technical Review

System Components

The following images describe the main components of the Vi-CELL BLU Cell Viability Analyzer.

Figure 1.2 Vi-CELL BLU with carousel

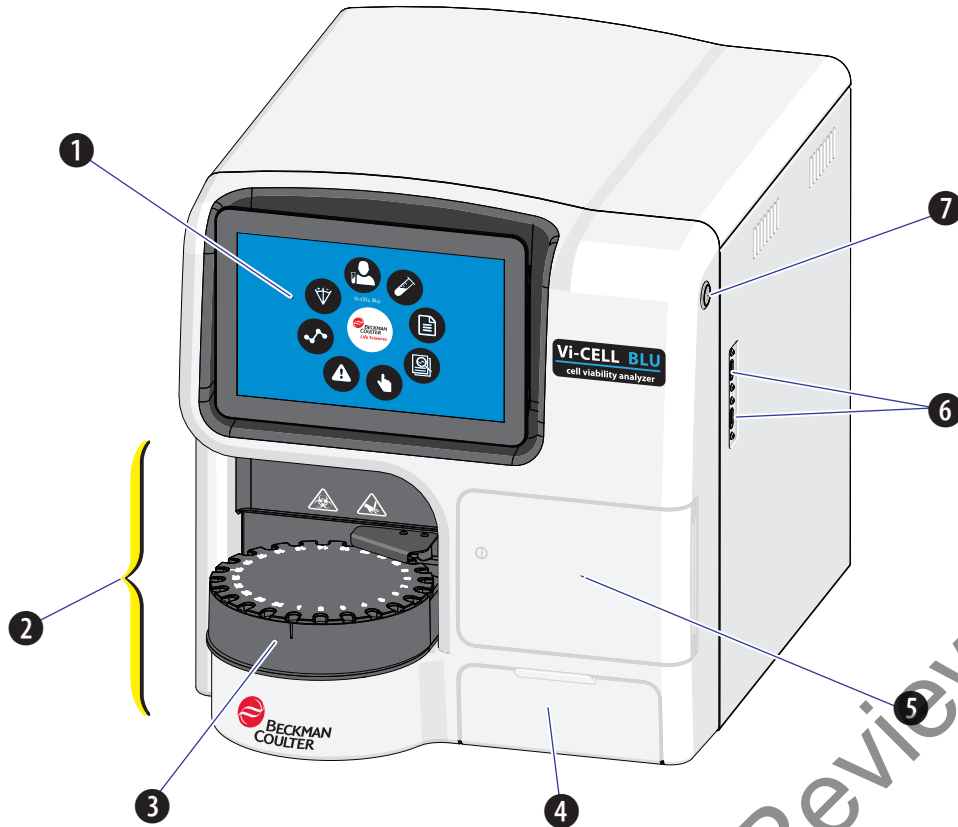

- | | |
|-------------------------|-----------------|
| 1. Touchscreen | 5. Reagent Door |
| 2. Sample Station | 6. USB Ports |
| 3. Carousel | 7. Power Button |
| 4. Spent Tube Tray Door | |

Draft Labeling
Subject to Technical Review

Figure 1.3 Vi-CELL BLU with 96 well plate

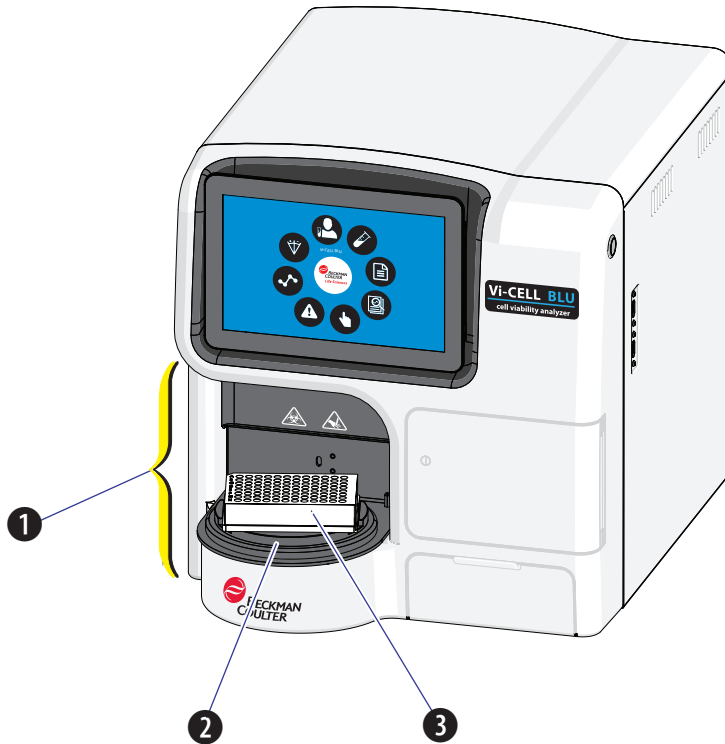

1. Sample Station
2. Plate Holder

3. 96 Well Plate

Software

Beckman Coulter provides the Vi-CELL BLU software.

Draft Labeling
Subject to Technical Review

Installation and Verification

Special Requirements – Pre-installation Checks

Environment

The instrument should be placed on a surface that is not subject to:

1. Excessive airborne dust
2. Strong vibrations
3. Extremes of temperature and humidity

Power Requirements

 **WARNING**

Risk of electric shock and/or instrument damage. Ensure that the power source is properly grounded. Improper grounding can cause electric shock and damage the system. Verify that the output voltage of the power outlet conforms to the system requirements. To prevent personal injury, Beckman Coulter recommends using a power source designed to protect against electrical shock.

 **CAUTION**

Possible instrument damage could occur if you use an extension cord or a power strip to connect the instrument. Always plug the instrument into a dedicated outlet with an isolated ground.

- Power: 180 watts max.
- AC Input: 90-264V AC, 2.5A, 47-63 Hz

Temperature and Humidity Requirements

CAUTION

Risk of instrument damage and/or erroneous results. To ensure reliability, the system must be operated in the specified environment, within the required temperature and humidity ranges. If the ambient temperature or humidity level falls outside the ranges mentioned above, use appropriate air conditioning.

- Temperature: 13 to 37°C (55 to 99°F)
Temperature Variation of: $\pm 3^{\circ}\text{C}$ over 8 hours.
- Humidity: 10 to 90%
Humidity Variation of: $\pm 10\%$ over 8 hours

Worktable

CAUTION

Risk of instrument damage. Place the instrument on a level surface. Failing to do so places the system in danger of toppling and can result in damage. Take all necessary precautions throughout the process of storing or transporting the instrument.

- The tabletop must be smooth and level.
- Minimum tabletop load bearing capacity 35 kg (77 lb)

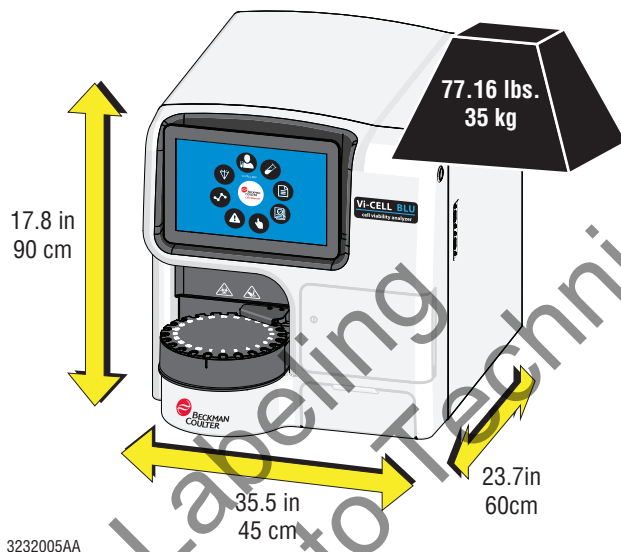

- The tabletop must not vibrate or shake.

- Position the instrument so that you can disconnect the power cable on the back of the instrument. See Operating and Servicing clearances below.

Operating clearances

- 10 cm (4 in.) clearance right side
- 5 cm (2 in.) clearance left side
- 5 cm (2 in.) clearance back of instrument
- 1 cm (0.5 in.) clearance top of instrument

Servicing clearances

- 20 cm (7.9 in.) clearance right side
- 20 cm (7.9 in.) clearance left side
- 20 cm (7.9 in.) clearance back of instrument
- 70 cm (27.2 in.) clearance top of instrument

Ventilation and Cleaning

IMPORTANT If necessary, use ventilation equipment, but airflow must not be allowed to blow directly on the instrument, as it can affect the reliability of the data.

- Ensure that the working environment is well ventilated for proper heat dissipation.
- Maintain a clearance of at least 20 cm from the back of the instrument for heat dissipation.
- Keep the environment as dust free as possible.
- Avoid direct exposure to sunlight.
- Avoid placing near heat sources or exposing to drafts.
- Avoid corrosives or flammable gases.

Draft Labeling
Subject to Technical Review

Installation

 **WARNING**

Risk of personal injury if only one person lifts the instrument. The instrument has no lifting handles, and it weighs more than one person should lift. Therefore, to prevent injury, at least two people following necessary safety precautions should lift the instrument together.

 **WARNING**

Risk of personal injury. Use caution when lowering the instrument to avoid pinching fingers.

Materials Shipped

NOTE The Instrument and Accessory Kit are shipped separately.

Instrument container

- Vi-CELL BLU Instrument
- Vi-CELL BLU Quick Start Guide (this manual)
- Vi-CELL BLU Safety Notices

Accessories Kit

- Power Supply, 90-264 V AC, 220 W, 12V/15A
- Assy, Ejection Carousel, Vi-CELL BLU
- Power Cord, 18VBI SVT blk
- Microfuge Tube, no cap, 350 count
- 96-Well Plates, 5 count
- Vinyl Film, 10 count
- 8mm Hex Allen Wrench, Std L
- Snap-in Hole Plug, Blk Nyl, 0.750-in. dia

Draft Labeling
Subject to Technical Review

Unpacking

 WARNING

Risk of personal injury if only one person lifts the instrument. The instrument has no lifting handles, and it weighs more than one person should lift. Therefore, to prevent injury, at least two people following necessary safety precautions should lift the instrument together. Use caution when lowering the instrument to avoid pinching fingers.

 WARNING

Risk of personal injury. Use caution when lowering the instrument to avoid pinching fingers.

1. Remove the instrument box from the wooden shipping crate.

 CAUTION

Risk of instrument damage. Place the instrument on a level surface. Failing to do so places the system in danger of toppling and can result in damage. Take all necessary precautions throughout the process of storing or transporting the instrument.

2. Remove the instrument from the instrument box and place the instrument on a bench.
3. Remove the accessories from the accessories box and check the packing list to ensure all the accessory items are included and there is no damage. Notify Beckman Coulter if damage is observed or parts are missing.
 - Worldwide, find us via our website at www.beckmancoulter.com/customer-support/support.
 - In the USA and Canada, call us at 1-800-369-0333.
 - Outside of the USA and Canada, contact your local Beckman Coulter Representative.

4. Remove the shipping restraints.
 - a. Remove the large allen bolt **1** on the right side of the instrument with the 8mm allen key from the accessory kit and then cover the hole with the plug **2** from the accessory kit.
 - b. Remove the piece of shipping tape **3** covering the USB ports on the right side of the instrument.
 - c. Remove the foam insert **4** in the carousel location.

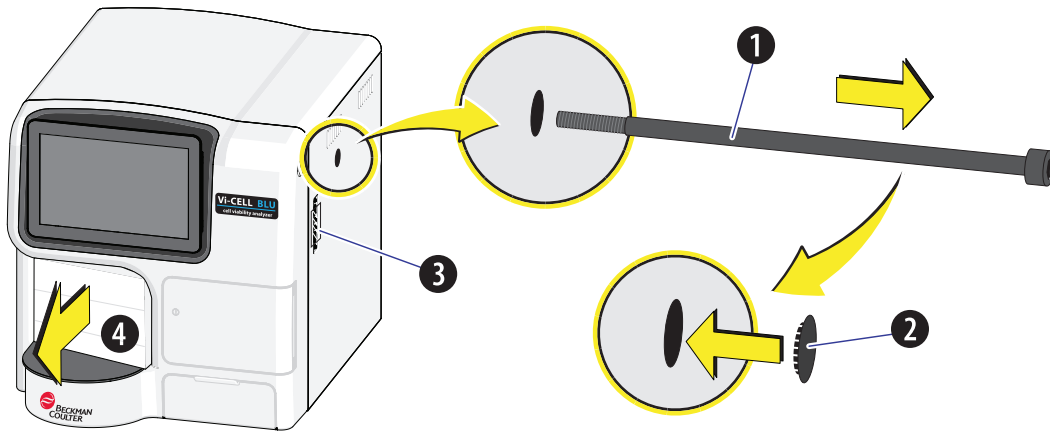

Connecting the Instrument

- 1 Connect the instrument to the power supply module.
The power supply Module supports 90-264V AC, 2.5A, 47-63 Hz.
- 2 Use the appropriate cable to plug the power supply module into an electrical outlet.
- 3 Install a 96 well plate or a carousel.

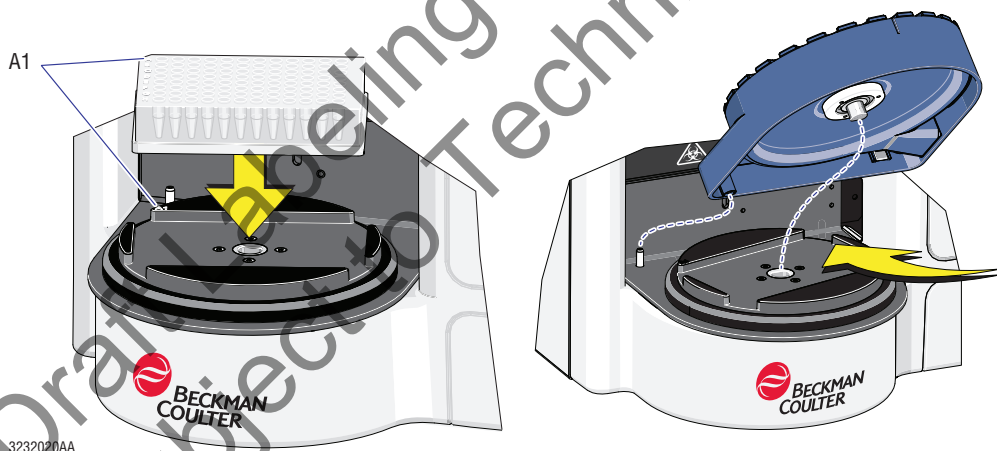

CAUTION

If the system fails to start properly, check first to see whether the power cable and connection cables are properly connected.

Never shut off the power or disconnect a data cable while the system is performing a task. Doing so can result in data loss or damage to the system.

- 4 Press the power button,  to turn the instrument on.
The software user interface will automatically load.

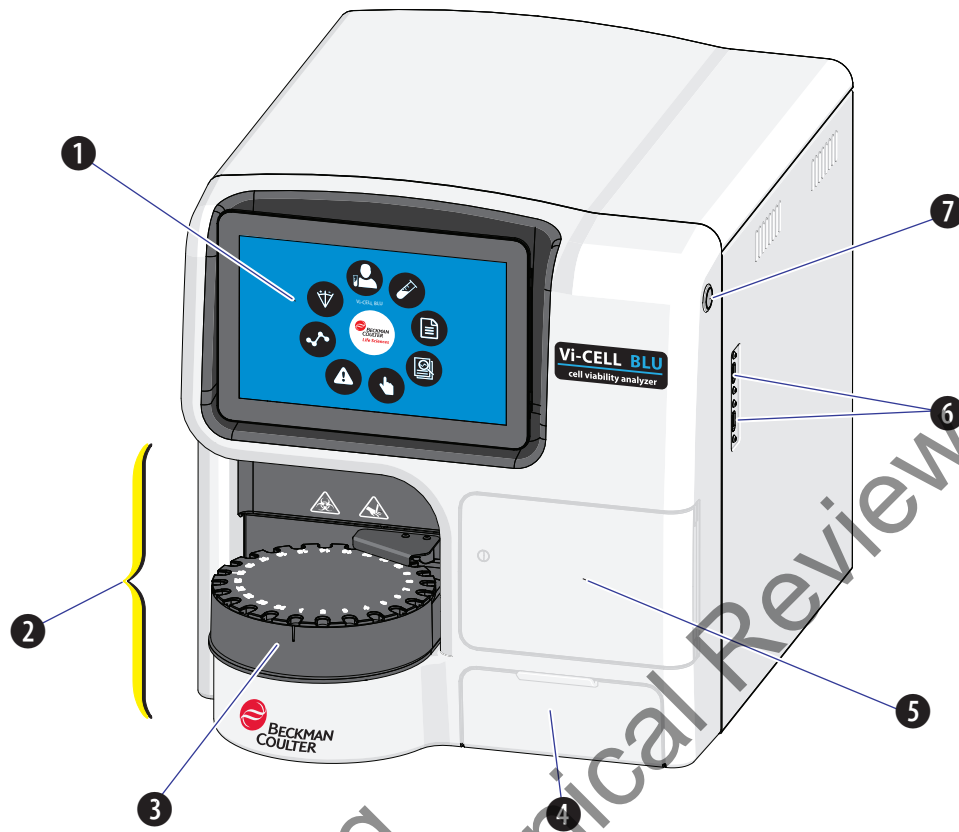

1. Touchscreen
2. Sample Station
3. Carousel
4. Spent Tube Tray Door
5. Reagent Door
6. USB Ports
7. Power Button

- 5 Follow the instructions for [First time Login](#).

First time Login

- 1 After powering on the instrument the Initializing screen is displayed.



- 2 Select **System Admin** to login.

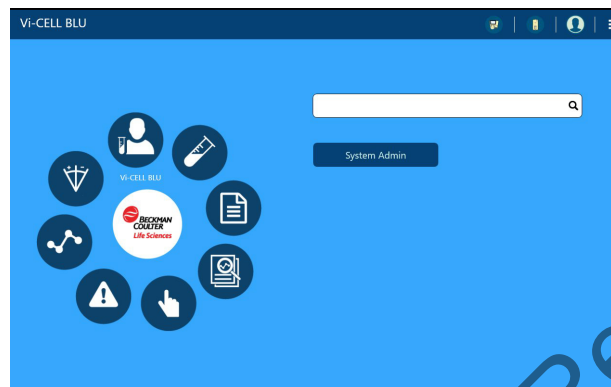

- 3 Enter the default login credentials.

- Username - bci_admin
- Password - bci_admin

- 4 You are prompted to enter a new password.

Enter a new password and select  to save.

See [Setup Users](#) for adding additional users.

Home Screen

After login the home screen is displayed.

Figure 2.1 Home screen

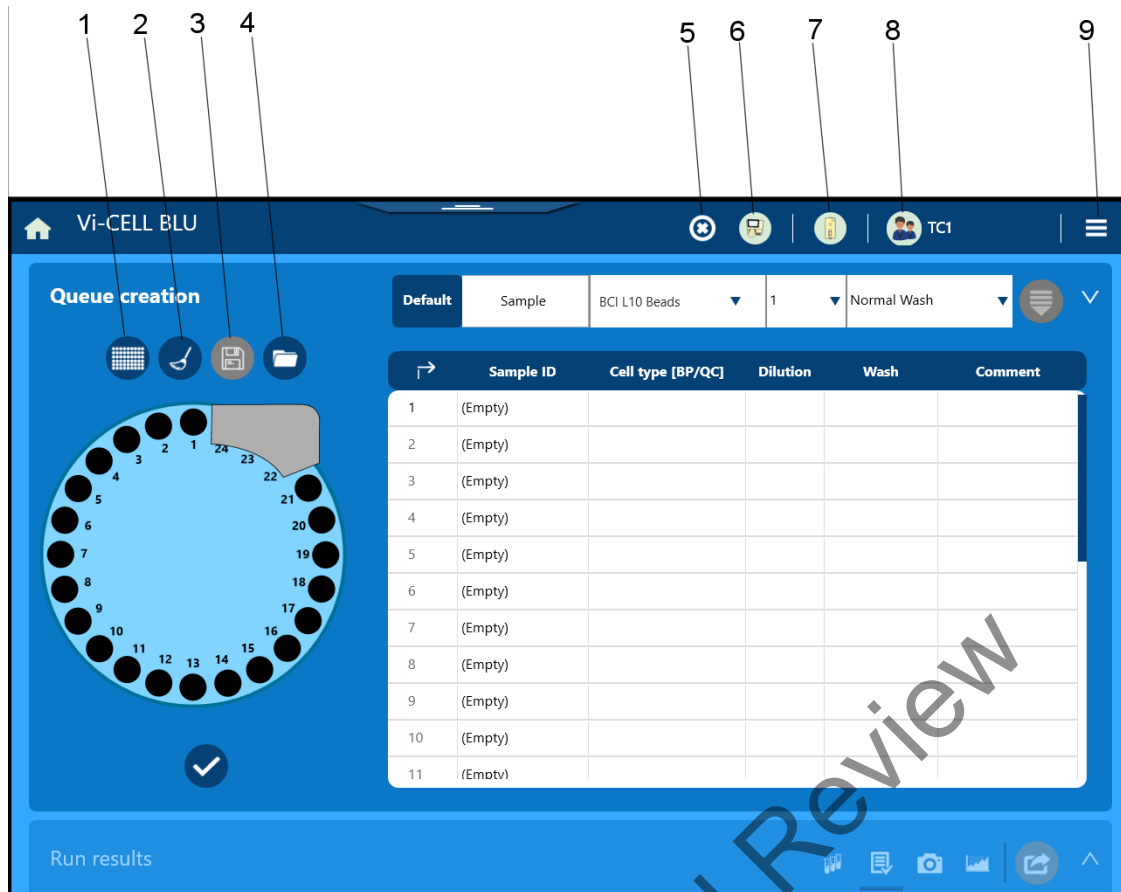

1. Select 96 well plate
2. Clear queue
3. Save queue
4. Choose saved queue
5. Exit software
6. Instrument status
7. Reagent status
8. Current user
9. Main menu, see [Figure 2.2, Main menu](#)

Figure 2.2 Main menu

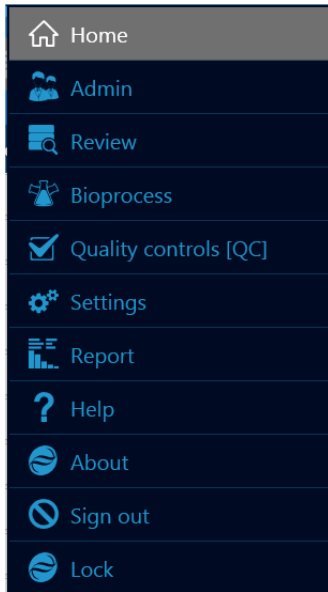
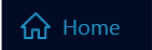

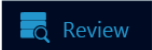









Table 2.1 Main menu buttons

 Home	Sample queue creation screen to program and run samples.
 Admin	Administration screen to add or change users, assign or change passwords, assign or add cell types and setup the storage size, backup and clean up options.
 Review	Review sample results to reanalyze, export or sign off the results.
 Bioprocess	View, export and delete a Bioprocess or add a Bioprocess.
 Quality controls [QC]	View, export and delete a Quality Control or add a Quality Control.
 Settings	Setup the system settings, see System Settings .
 Report	Create, print or export results reports and view or export audit, sample error and calibration log files.
 Help	Opens the Vi-CELL BLU manual.
 About	Displays the Vi-CELL BLU software version number and copyright statement.
 Sign out	Sign out the current user without exiting the software.
 Lock	Lock the software user interface.

Install a Reagent Pack

 **WARNING**

Risk of biohazardous exposure if you have skin contact with the Reagent Pack waste liquid. The Reagent Pack waste bottle has a vent and the Reagent Pack must be upright whenever you are handling a used Reagent Pack in order to prevent waste liquid from leaking out of the Reagent Pack waste bottle. Clean up spills immediately. Dispose of the Reagent Pack and the solid waste in accordance with your local regulations and acceptable laboratory procedures.

Always use the appropriate Personal Protective Equipment (PPE) when working with biohazardous materials.



- 1 Select  and Replace Reagent Pack.

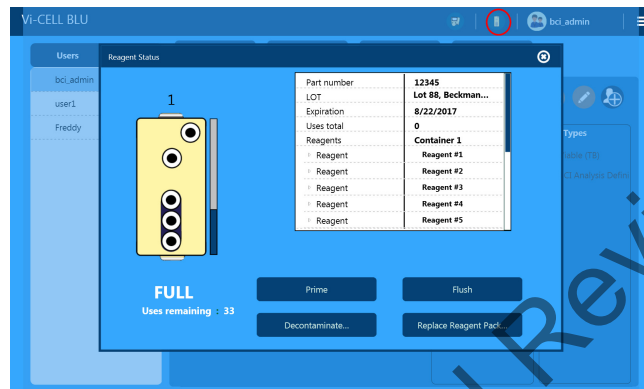

- 2 Select **None** and select . [need new screen with None choice](#)

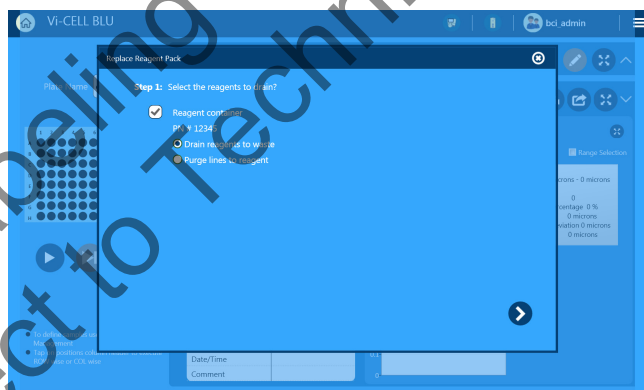

- 3 The reagent door opens.

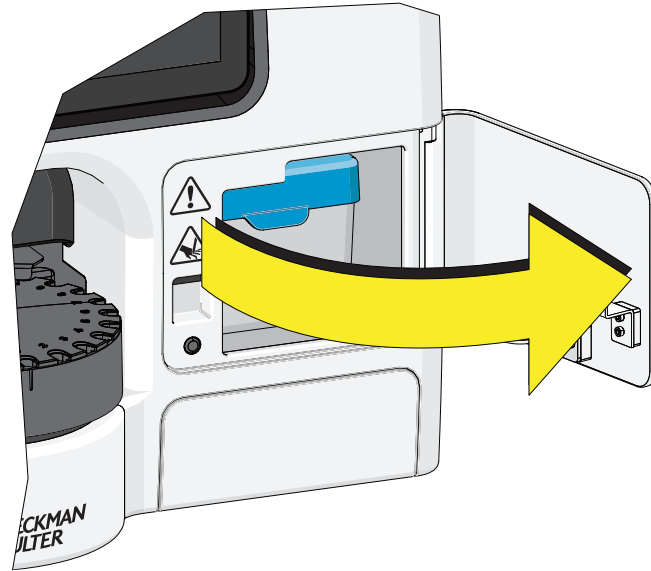

Draft Labeling
Subject to Technical Review

WARNING

Risk of biohazardous exposure if you have skin contact with the Reagent Pack waste liquid. The Reagent Pack waste bottle has a vent and the waste bottle must be upright whenever you are handling a used Reagent Pack in order to prevent waste liquid from leaking out of the waste bottle. Clean up spills immediately. Dispose of the Reagent Pack and the solid waste in accordance with your local regulations and acceptable laboratory procedures.

Always use the appropriate Personal Protective Equipment (PPE) when working with biohazardous materials.

- 4 Insert new Reagent Pack.

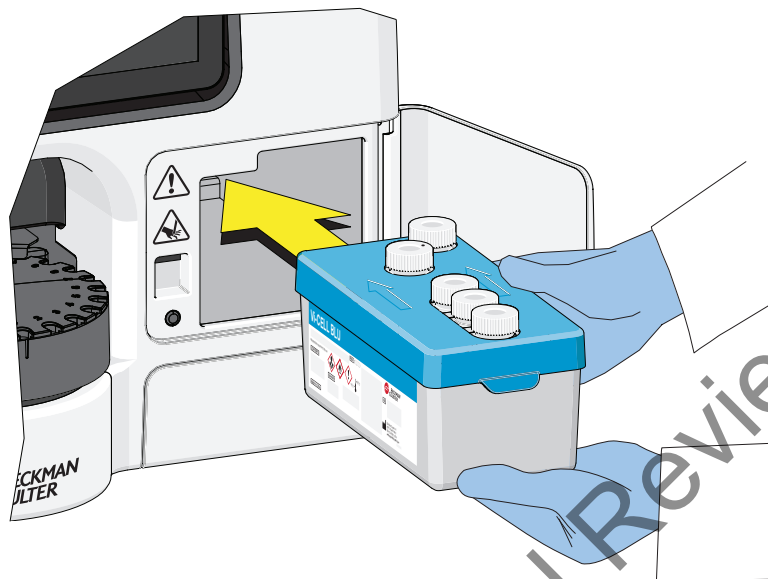

Draft Labeling
Subject to Technical Review