

## Onboard antenna specification

### 1、Onboard antenna detailed dimensions:

Model: QH06

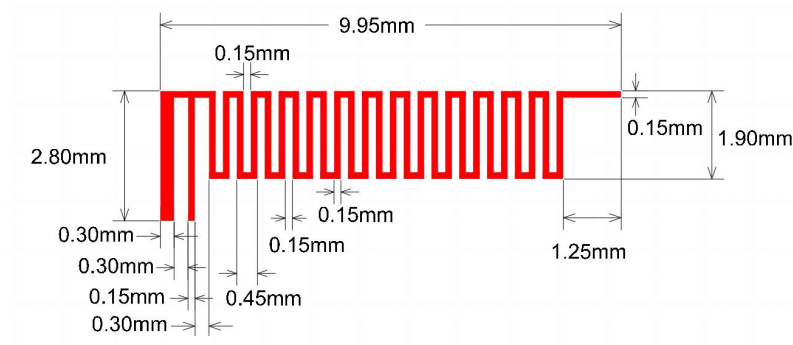

### 2、characteristic

- Ultra-small size: 2.8\*9.95mm
- 50 ohmage
- maximum gain: 2.08dBi
- Operates in the 2.4GHz band

### 3、Antenna S parameter

10dB Operating bandwidth:156MHz

Center band S11: -36dB@2.44GHz

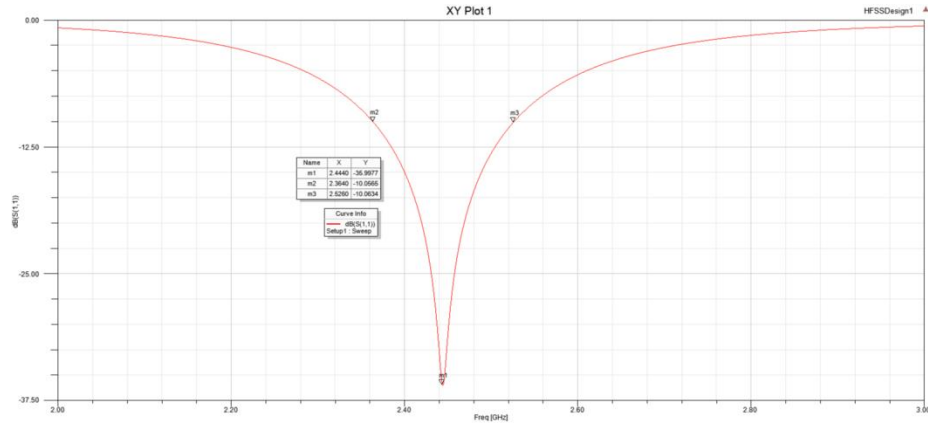

### 4、antenna gain

2.4GHz: maximum gain 1.86dBi

E Face:

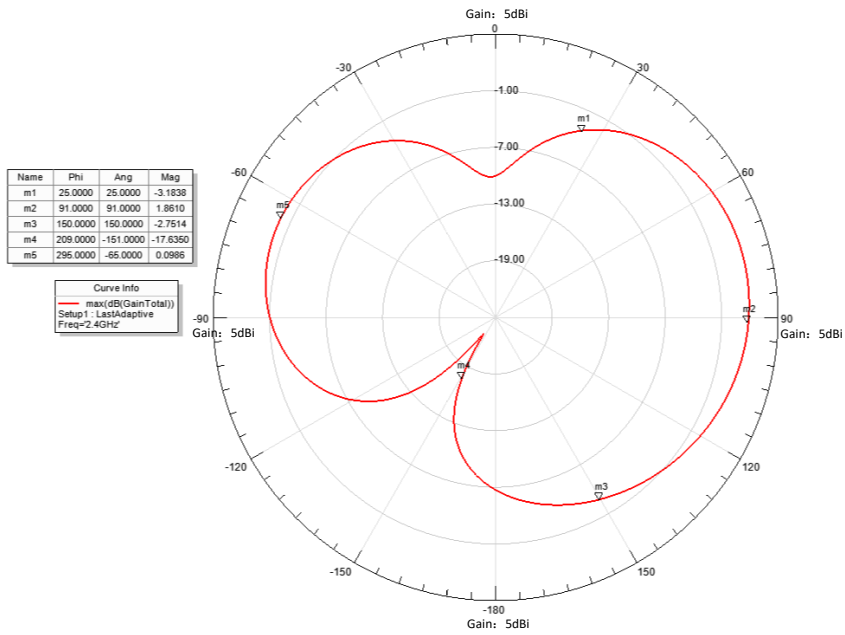

H Face:

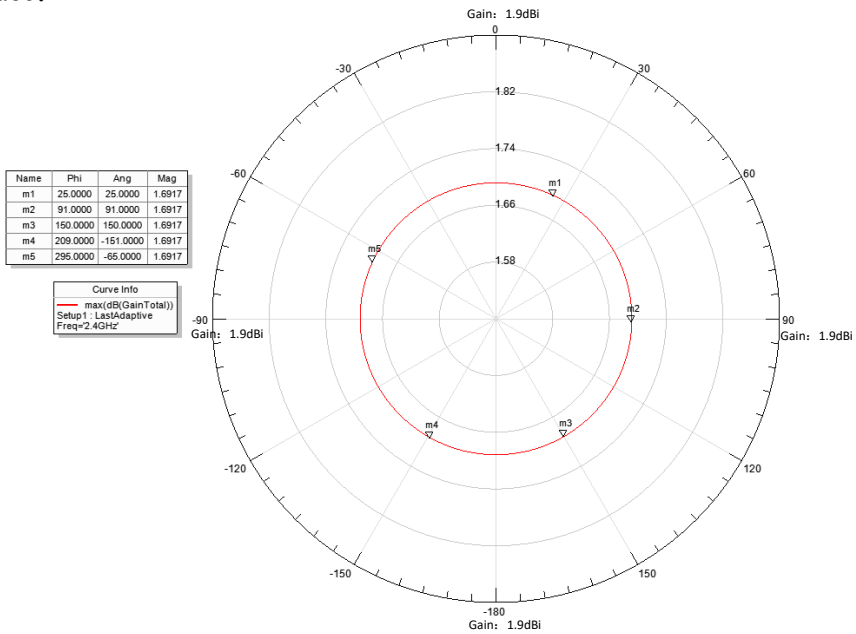

2.44GHz : maximum gain 2.08dBi

E Face:

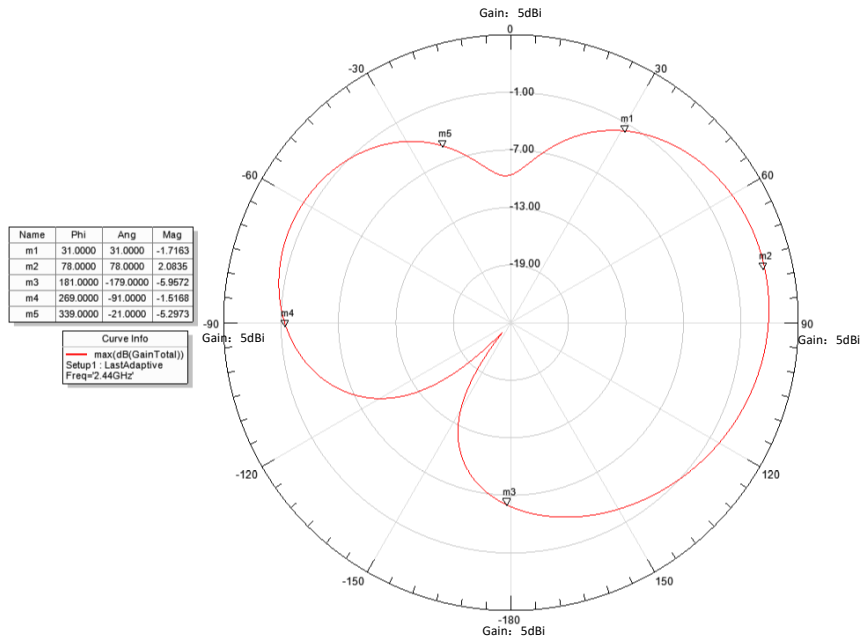

H Face:

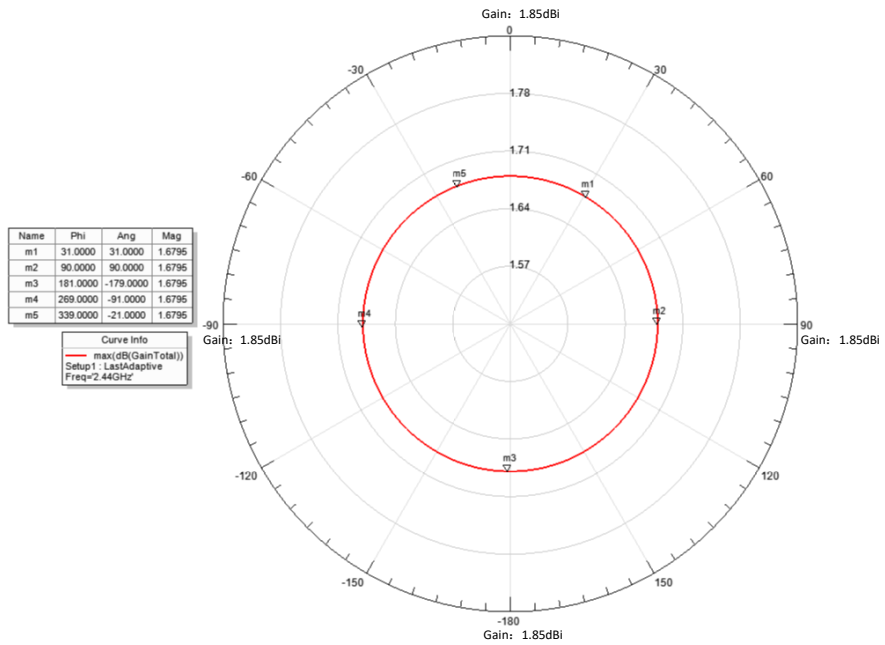

2.48GHz: maximum gain 2.02dBi

E Face:

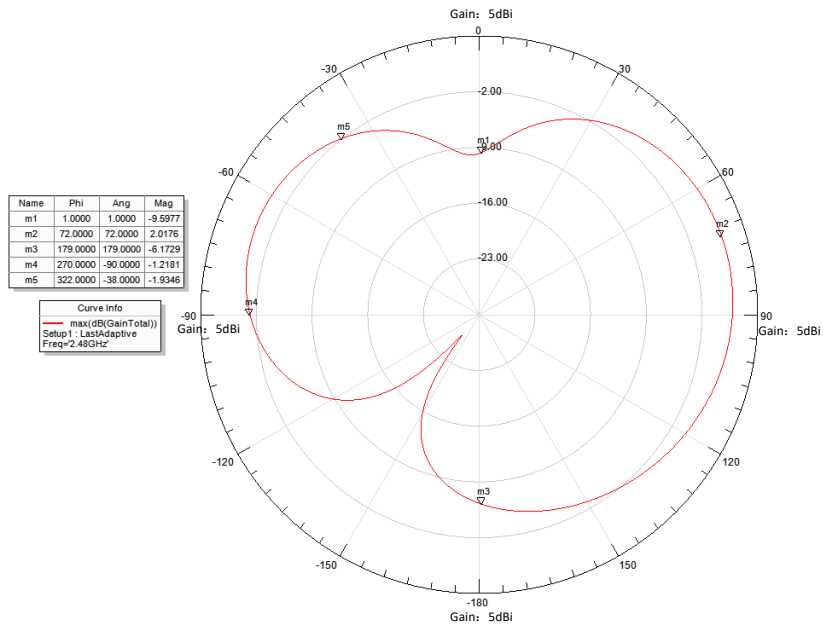

H Face:

