



Report No.: E01A22030366F00201

1 of 50

**ELECTROMAGNETIC EMISSIONS COMPLIANCE REPORT
FCC PART 15 SUBPART C REQUIREMENT**

OF

Flydigi Mobile Phone Cooling Fan B5

Model No.: Flydigi B5

Trademark: Flydigi

FCC ID: 2AORE-B5

Report No.: E01A22030366F00201

Issue Date: Mar. 29, 2022

Prepared for

Shanghai Flydigi Electronics Technology Co., Ltd.

Rm 1108, No.258 Guoxia Rd, Yangpu District, Shanghai, China.

Prepared by

Dong Guan Anci Electronic Technology Co., Ltd.

**1-2 Floor, Building A, No.11, Headquarters 2 Road, Songshan, Lake Hi-tech
Industrial Development Zone, Dongguan City, Guangdong Pr., China.**

**This report shall not be reproduced, except in full, without the written approval of
Dong Guan Anci Electronic Technology Co., Ltd.**



VERIFICATION OF COMPLIANCE

| | |
|----------------------|---|
| Applicant: | Shanghai Flydigi Electronics Technology Co., Ltd. Rm 1108, No.258 Guoxia Rd, Yangpu District, Shanghai, China. |
| Manufacturer: | Dashine Electronics CO., LTD. Address:No.53, Guangtian Road, Yanchuan community, Yanluo street, Bao'an District, ShenZhen, China |
| Product Description: | Flydigi Mobile Phone Cooling Fan B5 |
| Trade Mark: | Flydigi |
| Model Number: | Flydigi B5 |

We hereby certify that:

The above equipment was tested by Dong Guan Anci Electronic Technology Co., Ltd. The test data, data evaluation, test procedures, and equipment configurations shown in this report were made in accordance with the procedures given in ANSI C63.10-2013 and the energy emitted by the sample EUT tested as described in this report is in compliance with conducted and radiated emission limits of FCC Rules Part 15.247(2020).

Date of Test : Mar. 12, 2022 to Mar. 25, 2022

Prepared by : 
Tomas Yang/Editor

Approved & Authorized Signer : 
Alan He/Manager





Modified Information

| Version | Summary | Revision Date | Report No. |
|---------|-----------------|---------------|--------------------|
| Ver.1.0 | Original Report | / | E01A22030366F00201 |
| | | | |
| | | | |
| | | | |
| | | | |
| | | | |
| | | | |



Table of Contents

| | |
|---|-----------|
| 1. GENERAL INFORMATION | 6 |
| 1.1 PRODUCT DESCRIPTION | 6 |
| 1.2 TEST METHODOLOGY | 6 |
| 2. TEST FACILITY | 7 |
| 3. DESCRIPTION OF TEST MODES | 8 |
| 4. SUMMARY OF TEST RESULTS..... | 10 |
| 5. TEST SYSTEM UNCERTAINTY..... | 11 |
| 6. CONDUCTED EMISSIONS TEST | 12 |
| 6.1 MEASUREMENT PROCEDURE: | 12 |
| 6.2 TEST SET-UP (BLOCK DIAGRAM OF CONFIGURATION)..... | 12 |
| 6.3 MEASUREMENT EQUIPMENT USED: | 12 |
| 6.4 CONDUCTED EMISSION LIMIT | 12 |
| 6.5 MEASUREMENT RESULT: | 13 |
| 7. RADIATED EMISSION TEST..... | 16 |
| 7.1 MEASUREMENT PROCEDURE | 16 |
| 7.2 TEST SET-UP (BLOCK DIAGRAM OF CONFIGURATION)..... | 18 |
| 7.3 MEASUREMENT EQUIPMENT USED: | 19 |
| 7.4 RADIATED EMISSION LIMIT | 20 |
| 7.5 MEASUREMENT RESULT | 21 |
| 7.6 RADIATED MEASUREMENT PHOTOS:..... | 27 |
| 8. 6DB BANDWIDTH MEASUREMENT | 28 |
| 8.1 MEASUREMENT PROCEDURE | 28 |
| 8.2 TEST SET-UP (BLOCK DIAGRAM OF CONFIGURATION)..... | 28 |
| 8.3 MEASUREMENT EQUIPMENT USED: | 28 |
| 8.4 LIMIT | 28 |
| 8.5 MEASUREMENT RESULTS: | 28 |
| 9. MAXIMUM PEAK OUTPUT POWER TEST | 31 |
| 9.1 MEASUREMENT PROCEDURE | 31 |
| 9.2 TEST SET-UP (BLOCK DIAGRAM OF CONFIGURATION)..... | 31 |
| 9.3 MEASUREMENT EQUIPMENT USED: | 31 |
| 9.4 PEAK POWER OUTPUT LIMIT | 31 |
| 9.5 MEASUREMENT RESULTS:..... | 31 |
| 10.1 MEASUREMENT PROCEDURE | 34 |
| 10.2 TEST SET-UP (BLOCK DIAGRAM OF CONFIGURATION) | 34 |
| 10.3 MEASUREMENT EQUIPMENT USED: | 34 |



| | |
|---|-----------|
| 10.4 MEASUREMENT PROCEDURE | 34 |
| 10.5 MEASUREMENT RESULTS: | 35 |
| 11. BAND EDGE TEST | 38 |
| 11.1 MEASUREMENT PROCEDURE | 38 |
| 11.2 TEST SET-UP (BLOCK DIAGRAM OF CONFIGURATION) | 39 |
| 11.3 MEASUREMENT EQUIPMENT USED: | 39 |
| 11.4 MEASUREMENT RESULTS: | 40 |
| 12 ANTENNA APPLICATION | 46 |
| 12.1 ANTENNA REQUIREMENT | 46 |
| 12.2 RESULT | 46 |
| 13 PHOTOS OF EUT | 47 |



1. GENERAL INFORMATION

1.1 Product Description

| Characteristics | Description |
|---------------------------|-------------------------------------|
| Product Name | Flydigi Mobile Phone Cooling Fan B5 |
| Model number | Flydigi B5 |
| Input Rating | DC 5V/2A, 9V/2A |
| Power Supply | DC 9V from Adpater 120V/50Hz |
| Kind of Device | Bluetooth Ver. 5.0 |
| Modulation | GFSK |
| Operating Frequency Range | 2402-2480MHz |
| Number of Channels | 40 |
| Transmit Power Max(PK) | 0.07dBm(0.001W) |
| Antenna Type | FPC antenna |
| Antenna Gain | 0.1dBi |

1.2 Test Methodology

All the test program has follow FCC new test procedure KDB 558074 D01 DTS Meas Guidance v05 and in accordance with the procedures given in ANSI C63.10-2013.



Report No.: E01A22030366F00201

7 of 50

2. Test Facility

Site Description

EMC Lab. : Accredited by CNAS, 2017.06.26
The certificate is valid until 2022.10.28
The Laboratory has been assessed and proved to be in compliance with CNAS-CL01:2006 (identical to ISO/IEC 17025:2005)
The Certificate Registration Number is L6214.

Accredited by A2LA, 2018.03.15
The Certificate Number is 4422.01.

Name of Firm : Dong Guan Anci Electronic Technology Co., Ltd.
Site Location : 1-2 Floor, Building A, No.11, Headquarters 2 Road, Songshan, Lake Hi-tech Industrial Development Zone, Dongguan City, Guangdong Pr., China.



3. Description of test modes

The EUT has been tested under its typical operating condition and fully-charged battery for EUT tested alone. Pre-defined engineering program for regulatory testing used to control the EUT for staying in continuous transmitting. Only the worst case data were reported.

The EUT has been associated with peripherals pursuant to ANSI C63.10-2013 and configuration operated in a manner tended to maximize its emission characteristics in a typical application. Frequency range investigated: radiation (9 KHz to the 10th harmonics of the highest fundamental frequency or to 40 GHz, whichever is lower).

For Radiated: The EUT’s antenna was pre-tested under the following modes:

| Test Mode | Description |
|---------------|-----------------|
| Mode A | X-Y axis |
| Mode B | Y-Z axis |
| Mode C | X-Z axis |

From the above modes, the worst case was found in Mode C. Therefore only the test data of the mode was recorded in this report.

Configuration of Tested System



Equipment Used in Tested System

| Item | Equipment | Trademark | Model No. | FCC ID | Note |
|------|-------------------------------------|-----------|------------|----------|------------|
| 1. | Flydigi Mobile Phone Cooling Fan B5 | Flydigi | Flydigi B5 | 2AORE-B5 | EUT |



Report No.: E01A22030366F00201

9 of 50

The EUT has been tested under TX operating condition.

Channel List:

| Channel | Frequency (MHz) | Channel | Frequency (MHz) | Channel | Frequency (MHz) |
|-----------|-----------------|-----------|-----------------|-----------|-----------------|
| 00 | 2402 | 14 | 2430 | 28 | 2458 |
| 01 | 2404 | 15 | 2432 | 29 | 2460 |
| 02 | 2406 | 16 | 2434 | 30 | 2462 |
| 03 | 2408 | 17 | 2436 | 31 | 2464 |
| 04 | 2410 | 18 | 2438 | 32 | 2466 |
| 05 | 2412 | 19 | 2440 | 33 | 2468 |
| 06 | 2414 | 20 | 2442 | 34 | 2470 |
| 07 | 2416 | 21 | 2444 | 35 | 2472 |
| 08 | 2418 | 22 | 2446 | 36 | 2474 |
| 09 | 2420 | 23 | 2448 | 37 | 2476 |
| 10 | 2422 | 24 | 2450 | 38 | 2478 |
| 11 | 2424 | 25 | 2452 | 39 | 2480 |
| 12 | 2426 | 26 | 2454 | | |
| 13 | 2428 | 27 | 2456 | | |

Note:

1. Test of channel was included the lowest 2402MHz, middle 2440MHz and highest frequency 2480MHz in highest data rate and to perform the test, then record on this report.



4. Summary of Test Results

| FCC Rules | Description Of Test | Result |
|--------------------|------------------------------------|-----------|
| §15.207 | AC Power Conducted Emission | Compliant |
| §15.247(d),§15.209 | Radiated Emission | Compliant |
| §15.247(a)(2) | 6dB Bandwidth Measurement | Compliant |
| §15.247(b) | MAXIMUM PEAK OUTPUT POWER TEST | Compliant |
| §15.247(e) | Power Spectral Density Measurement | Compliant |
| §15.247(d) | Band EDGE test | Compliant |
| §15.203 | Antenna Requirement | Compliant |

Remark: The product was tested under the battery fully charged. According to FCC OET KDB 558074, the report use radiated measurements in the restricted frequency bands. In addition, the radiated test is also performed to ensure the emissions emanating from the device cabinet also comply with the applicable limits.

Note 1: During the charging proceed, the Bluetooth function of this device is inactive.

Note 2: Left and right earbuds have the same RF module and antenna, schematics, PCB Layout and component, Here right earbud was selected for related conducted tests. And for the radiated test, both earbuds are under the test. Right earbud acts as a master device and left earbud acts as a slave device.



5. TEST SYSTEM UNCERTAINTY

The following measurement uncertainty levels have been estimated for tests performed on the apparatus:

| Parameter | Uncertainty |
|--------------------------------|-------------------------|
| Radio Frequency | $\pm 1 \times 10^{-5}$ |
| Maximum Peak Output Power Test | $\pm 1.0\text{dB}$ |
| Conducted Emissions Test | $\pm 2.0\text{dB}$ |
| Radiated Emission Test | $\pm 2.0\text{dB}$ |
| Power Density | $\pm 2.0\text{dB}$ |
| Occupied Bandwidth Test | $\pm 1.0\text{dB}$ |
| Band Edge Test | $\pm 3\text{dB}$ |
| All emission, radiated | $\pm 3\text{dB}$ |
| Antenna Port Emission | $\pm 3\text{dB}$ |
| Temperature | $\pm 0.5^\circ\text{C}$ |
| Humidity | $\pm 3\%$ |

Remark: The coverage Factor ($k=2$), and measurement Uncertainty for a level of Confidence of 95%

6. Conducted Emissions Test

6.1 Measurement Procedure:

1. The EUT was placed on a table, which is 0.8m above ground plane.
2. Maximum procedure was performed on the six highest emissions to ensure EUT compliance.
3. Repeat above procedures until all frequency measured was complete.

6.2 Test SET-UP (Block Diagram of Configuration)

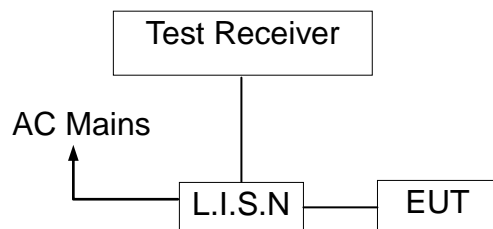

6.3 Measurement Equipment Used:

| EQUIPMENT TYPE | MFR | MODEL NUMBER | SERIAL NUMBER | Calibrated until |
|-------------------|---------------|--------------|---------------|------------------|
| L.I.S.N | SCHWARZBECK | NSLK 8127 | 8127-669 | 2022-05-17 |
| 10 db attenuator | JFW | 50FP-010-H4 | 4360846-427-1 | 2022-05-17 |
| RF Cable | N/A | N/A | 2# | 2022-05-17 |
| EMI Test Receiver | ROHDE&SCHWARZ | ESCI | 101358 | 2022-05-17 |

6.4 Conducted Emission Limit

(7) Conducted Emission

Frequency(MHz)

0.15-0.5

0.5-5.0

5.0-30.0

Quasi-peak

66-56

56

60

Average

56-46

46

50

Note:

1. The lower limit shall apply at the transition frequencies
2. The limit decreases in line with the logarithm of the frequency in the range of 0.15 to 0.50MHz.



6.5 Measurement Result:

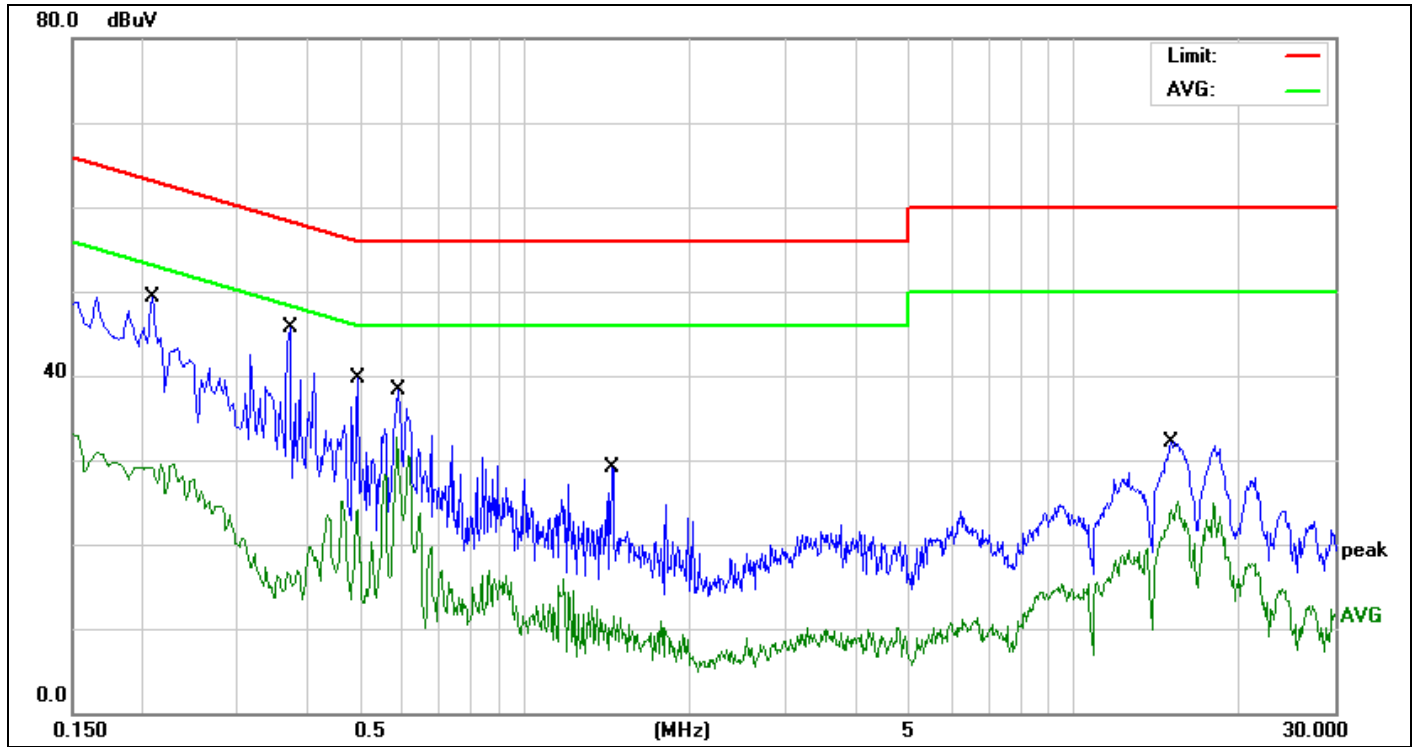

| | | | | | |
|--------|-------------------------------------|---------------|--------------|-----------------|-------|
| Site: | 843 | Phase: | L1 | Temperature(C): | 26(C) |
| Limit: | FCC Part 15 C Conduction(QP) | Test Time: | 2022-03-22 | Humidity(%): | 60% |
| EUT: | Flydigi Mobile Phone Cooling Fan B5 | Power Rating: | AC 120V/60Hz | Test Engineer: | Jack |
| M/N.: | Flydigi B5 | Note: | | | |
| Mode: | BT | | | | |

| No. | Frequency (MHz) | Reading Level(dBuV) | Factor (dB) | Measurement(dBuV) | Limit (dBuV) | Over (dB) | Detector | Comment |
|-----|-----------------|---------------------|-------------|-------------------|--------------|-----------|----------|---------|
| 1 | 0.2100 | 25.91 | 10.21 | 36.12 | 63.20 | -27.08 | QP | |
| 2 | 0.2100 | 13.51 | 10.21 | 23.72 | 53.20 | -29.48 | AVG | |
| 3 | 0.3740 | 18.41 | 10.17 | 28.58 | 58.41 | -29.83 | QP | |
| 4 | 0.3740 | 5.07 | 10.17 | 15.24 | 48.41 | -33.17 | AVG | |
| 5 | 0.4980 | 15.00 | 10.18 | 25.18 | 56.03 | -30.85 | QP | |
| 6 | 0.4980 | 8.64 | 10.18 | 18.82 | 46.03 | -27.21 | AVG | |
| 7 | 0.5899 | 17.84 | 10.16 | 28.00 | 56.00 | -28.00 | QP | |
| 8 * | 0.5899 | 15.55 | 10.16 | 25.71 | 46.00 | -20.29 | AVG | |
| 9 | 1.4460 | 5.54 | 10.15 | 15.69 | 56.00 | -40.31 | QP | |
| 10 | 1.4460 | -1.41 | 10.15 | 8.74 | 46.00 | -37.26 | AVG | |
| 11 | 15.0700 | 16.81 | 10.58 | 27.39 | 60.00 | -32.61 | QP | |
| 12 | 15.0700 | 11.21 | 10.58 | 21.79 | 50.00 | -28.21 | AVG | |

*:Maximum data x:Over limit !:over margin

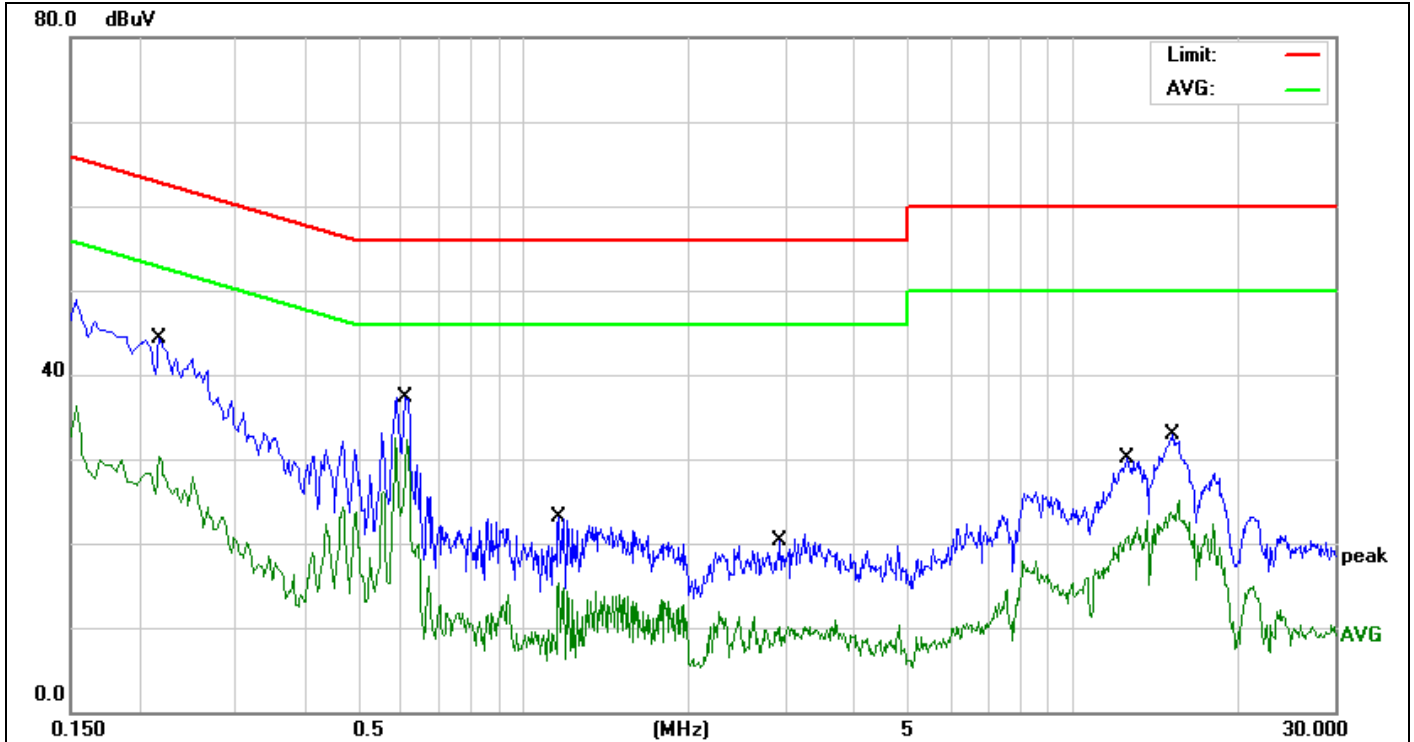

| | | | | | |
|--------|-------------------------------------|---------------|--------------|-----------------|-------|
| Site: | 843 | Phase: | N | Temperature(C): | 26(C) |
| Limit: | FCC Part 15 C Conduction(QP) | Test Time: | 2022-03-22 | Humidity(%): | 60% |
| EUT: | Flydigi Mobile Phone Cooling Fan B5 | Power Rating: | AC 120V/60Hz | Test Engineer: | Jack |
| M/N.: | Flydigi B5 | | | | |
| Mode: | BT | | | | |
| Note: | | | | | |

| No. | Frequency (MHz) | Reading Level(dBuV) | Factor (dB) | Measurement(dBuV) | Limit (dBuV) | Over (dB) | Detector | Comment |
|-----|-----------------|---------------------|-------------|-------------------|--------------|-----------|----------|---------|
| 1 | 0.2180 | 25.65 | 10.21 | 35.86 | 62.89 | -27.03 | QP | |
| 2 | 0.2180 | 15.79 | 10.21 | 26.00 | 52.89 | -26.89 | AVG | |
| 3 | 0.6100 | 25.05 | 10.16 | 35.21 | 56.00 | -20.79 | QP | |
| 4 * | 0.6100 | 19.27 | 10.16 | 29.43 | 46.00 | -16.57 | AVG | |
| 5 | 1.1620 | 4.15 | 10.15 | 14.30 | 56.00 | -41.70 | QP | |
| 6 | 1.1620 | 0.55 | 10.15 | 10.70 | 46.00 | -35.30 | AVG | |
| 7 | 2.9380 | 4.24 | 10.20 | 14.44 | 56.00 | -41.56 | QP | |
| 8 | 2.9380 | -0.36 | 10.20 | 9.84 | 46.00 | -36.16 | AVG | |
| 9 | 12.5620 | 15.71 | 10.52 | 26.23 | 60.00 | -33.77 | QP | |
| 10 | 12.5620 | 9.96 | 10.52 | 20.48 | 50.00 | -29.52 | AVG | |
| 11 | 15.1660 | 15.42 | 10.58 | 26.00 | 60.00 | -34.00 | QP | |
| 12 | 15.1660 | 9.81 | 10.58 | 20.39 | 50.00 | -29.61 | AVG | |

*:Maximum data x:Over limit !:over margin

6.5 Conducted Measurement Photos:



7. Radiated Emission Test

7.1 Measurement Procedure

1. The testing follows the guidelines in ANSI C63.10-2013.
2. Below 1000MHz, The EUT was placed on a turn table which is 0.8m above ground plane. And above 1000MHz, The EUT was placed on a styrofoam table which is 1.5m above ground plane.
3. The EUT was set 3 meters from the interference receiving antenna, which was mounted on the top of a variable height antenna tower.
4. The EUT was arranged to its worst case and then tune the Antenna tower (From 1m to 4m) and turntable (from 0 degree to 360 degrees) to find the maximum reading. A pre-amp and a high pass filter are used for the test in order to get better signal level.
5. For measurement below 1GHz, if the emission level of the EUT measured by the peak detector is 3dB lower than the applicable limit, the peak emission level will be reported. Otherwise, the emission measurement will be repeated using the quasi-peak detector and reported.
6. Final measurement (Above 1GHz): The frequency range will be divided into different sub ranges depending of the frequency range of the used horn antenna. The EMI Receiver set to peak and average mode and a resolution bandwidth of 1MHz. The measurement will be performed in horizontal and vertical polarization of the measuring antenna and while rotating the EUT in its vertical axis in the range of 0 degree to 360 degree in order to have the antenna inside the cone of radiation.
7. Test Procedure of measurement (For Above 1GHz):
 - 1) Monitor the frequency range at horizontal polarization and move the antenna over all sides of the EUT(if necessary move the EUT to another orthogonal axis).
 - 2) Change the antenna polarization and repeat 1) with vertical polarization.
 - 3) Make a hardcopy of the spectrum.
 - 4) Measure the frequency of the detected emissions with a lower span and resolution bandwidth to increase the accuracy and note the frequency value.
 - 5) Change the analyser mode to Clear/ Write and found the cone of emission.
 - 6) Rotate and move the EUT, so that the measuring distance can be enlarged to 3m and the antenna will be still inside the cone of emission.
 - 7) Measure the level of the detected frequency with the correct resolution bandwidth, with the antenna polarization and azimuth and the peak and average detector, which causes the maximum emission.
 - 8) Repeat steps 1) to 7) for the next antenna spot if the EUT is larger than the antenna beamwidth.



Use the following spectrum analyzer settings:

When spectrum scanned from 30MHz to 1GHz setting resolution bandwidth 120KHz and video bandwidth 300KHz:

| | |
|-------------------|----------|
| EMI Test Receiver | Setting |
| Attenuation | Auto |
| RB | 120KHz |
| VB | 300KHz |
| Detector | QP |
| Trace | Max hold |

When spectrum scanned above 1GHz setting resolution bandwidth 1MHz, video bandwidth 3MHz:

| | |
|-------------------|----------|
| EMI Test Receiver | Setting |
| Attenuation | Auto |
| RB | 1MHz |
| VB | 3MHz |
| Detector | Peak |
| Trace | Max hold |

When spectrum scanned above 1GHz setting resolution bandwidth 1MHz, video bandwidth 10Hz:

| | |
|-------------------|----------|
| EMI Test Receiver | Setting |
| Attenuation | Auto |
| RB | 1MHz |
| VB | 10Hz |
| Detector | Average |
| Trace | Max hold |

For Average Measurement:

VBW=10Hz, when duty cycle is no less than 98 percent.

$VBW \geq 1/T$, when duty cycle is less than 98 percent where T is the minimum transmission duration over which the transmitter is on and is transmitting at its maximum power control level for the tested mode of operation.

| Band | Duty Cycle(%) | T(μ s) | 1/T(KHz) | Average Correction Factor | VBW Setting |
|-----------|---------------|-------------|----------|---------------------------|-------------|
| 2402-2480 | 100 | - | - | 0 | 10Hz |

7.2 Test SET-UP (Block Diagram of Configuration)

(A) Radiated Emission Test Set-Up, Frequency Below 30MHz

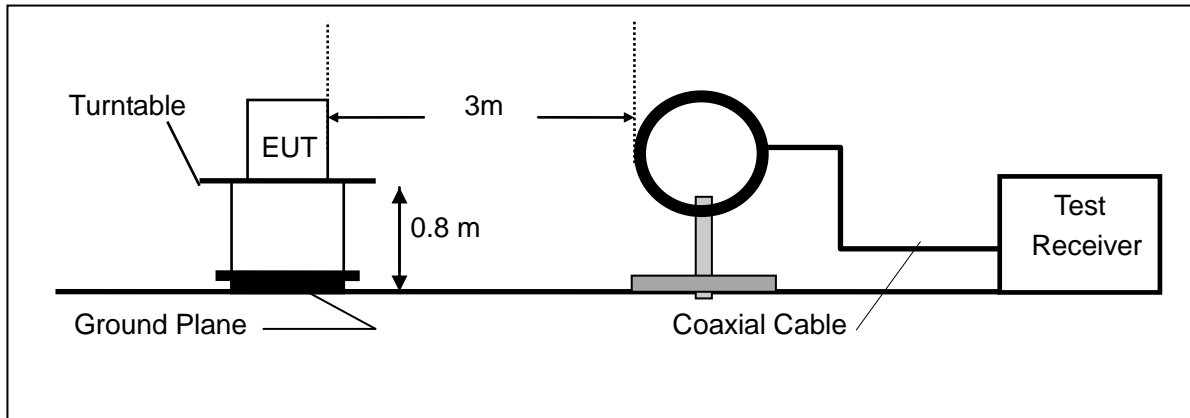

(B) Radiated Emission Test Set-Up, Frequency Below 1000MHz

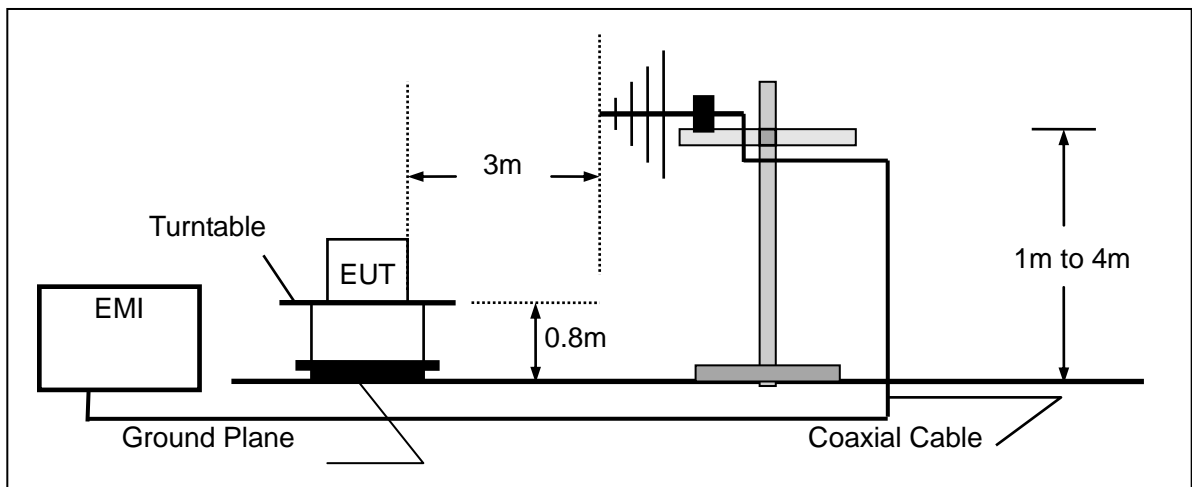

(C) Radiated Emission Test Set-Up, Frequency above 1000MHz

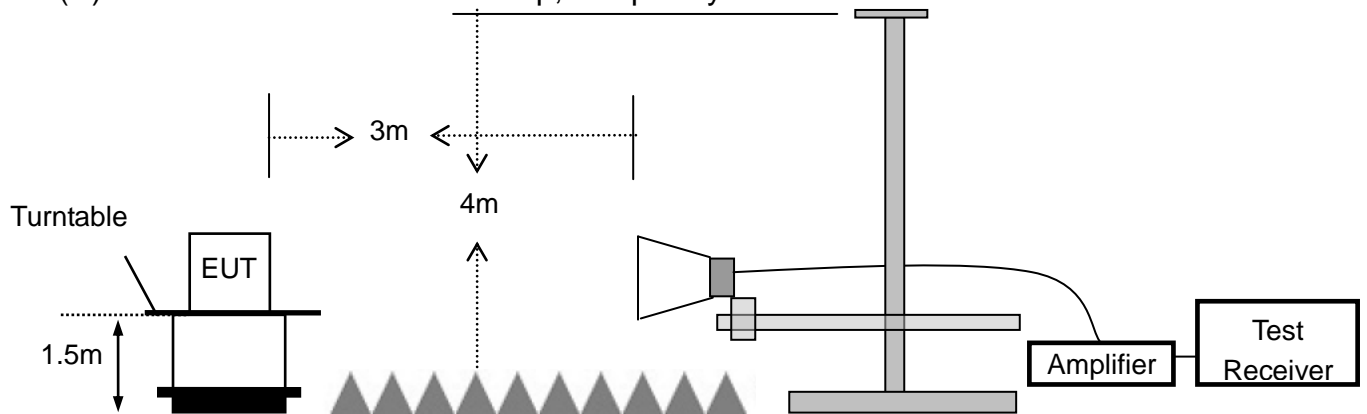



7.3 Measurement Equipment Used:

| Item | Equipment | Manufacturer | Model No. | Serial No. | Calibrated until |
|------|------------------------------|--------------------|---------------------------|--------------------|------------------|
| 1. | EMI Test Receiver | Rohde & Schwarz | ESPI | 100502 | 2022-11-13 |
| 2. | Pre-Amplifier | HP | 8447D | 2727A06172 | 2022-05-22 |
| 3. | Bilog Antenna | Schwarzbeck | VULB9163 | VULB9163-588 | 2022-05-22 |
| 4. | Loop Antenna | Schwarzbeck | FMZB 1516 | 1516-141 | 2022-11-13 |
| 5. | Spectrum Analyzer | Rohde & Schwarz | FSV40 | US40240623 | 2022-11-13 |
| 6. | Low noise Amplifiers | A-INFO | LA1018N4009 | J101313052400 1 | 2022-05-22 |
| 7. | Horn antenna | A-INFO | LB-10180-SF | J203109061212 3 | 2022-05-22 |
| 8. | Broadband RF Power Amplifier | AEROFLEX | AEROFLEX10 0KHz-40GHz | J101313052400 1 | 2022-11-13 |
| 9. | DRG Horn Antenna | A.H.SYSTEMS | SAS-574 | J203109061212 3 | 2022-11-13 |
| 10. | RF Cable | Gigalink Microwave | ZT40-2.92J-2. 92J-2m | N/A | 2022-11-13 |
| 11. | RF Cable | Gigalink Microwave | ZT40-2.92J-2. 92J-0.3m | N/A | 2022-11-13 |
| 12. | RF Cable | N/A | N/A | 6# | 2022-05-22 |
| 13. | RF Cable | N/A | N/A | 1-1# | 2022-05-22 |
| 14. | RF Cable | N/A | N/A | 1-2# | 2022-05-22 |
| 15. | RF Cable | N/A | N/A | 7# | 2022-05-22 |
| 16. | 3m Semi-anechoic Chamber | chengyu | 9m*6m*6m | N/A | 2022-05-22 |
| 17. | Test Software | Farad | EZ-EMC Ver:ANCI-3A1 | N/A | N/A |

7.4 Radiated emission limit

The emissions from an intentional radiator shall not exceed the field strength levels specified in the following table 15.209(a):

| Frequencies (MHz) | Field Strength (micorvolts/meter) | Measurement Distance (meters) |
|-------------------|-----------------------------------|-------------------------------|
| 0.009~0.490 | 2400/F(KHz) | 300 |
| 0.490~1.705 | 24000/F(KHz) | 30 |
| 1.705~30.0 | 30 | 30 |
| 30~88 | 100 | 3 |
| 88~216 | 150 | 3 |
| 216~960 | 200 | 3 |
| Above 960 | 500 | 3 |

15.205 Restricted bands of operation

| MHz | MHz | MHz | GHz |
|----------------------------|-----------------------|-----------------|---------------|
| 0.090 - 0.110 | 16.42 - 16.423 | 399.9 - 410 | 4.5 - 5.15 |
| ¹ 0.495 - 0.505 | 16.69475 - 16.69525 | 608 - 614 | 5.35 - 5.46 |
| 2.1735 - 2.1905 | 16.80425 - 16.80475 | 960 - 1240 | 7.25 - 7.75 |
| 4.125 - 4.128 | 25.5 - 25.67 | 1300 - 1427 | 8.025 - 8.5 |
| 4.17725 - 4.17775 | 37.5 - 38.25 | 1435 - 1626.5 | 9.0 - 9.2 |
| 4.20725 - 4.20775 | 73 - 74.6 | 1645.5 - 1646.5 | 9.3 - 9.5 |
| 6.215 - 6.218 | 74.8 - 75.2 | 1660 - 1710 | 10.6 - 12.7 |
| 6.26775 - 6.26825 | 108 - 121.94 | 1718.8 - 1722.2 | 13.25 - 13.4 |
| 6.31175 - 6.31225 | 123 - 138 | 2200 - 2300 | 14.47 - 14.5 |
| 8.291 - 8.294 | 149.9 - 150.05 | 2310 - 2390 | 15.35 - 16.2 |
| 8.362 - 8.366 | 156.52475 - 156.52525 | 2483.5 - 2500 | 17.7 - 21.4 |
| 8.37625 - 8.38675 | 156.7 - 156.9 | 2690 - 2900 | 22.01 - 23.12 |
| 8.41425 - 8.41475 | 162.0125 - 167.17 | 3260 - 3267 | 23.6 - 24.0 |
| 12.29 - 12.293 | 167.72 - 173.2 | 3332 - 3339 | 31.2 - 31.8 |
| 12.51975 - 12.52025 | 240 - 285 | 3345.8 - 3358 | 36.43 - 36.5 |
| 12.57675 - 12.57725 | 322 - 335.4 | 3600 - 4400 | (?) |

Remark 1. Emission level in dBuV/m=20 log (uV/m)

- : 2. Measurement was performed at an antenna to the closed point of EUT distance of meters.
- 3. Only spurious frequency is permitted to locate within the Restricted Bands specified in provision of § 15.205, and the emissions located in restricted bands also comply with 15.209 limit.



7.5 Measurement Result

Below 30MHz:

| | | | |
|--------------------|------------|---------------|------------|
| Operation Mode: | TX | Test Date : | 2022-03-22 |
| Frequency Range: | 9KHz~30MHz | Temperature : | 25°C |
| Test Result: | PASS | Humidity : | 58 % |
| Measured Distance: | 3m | Test By: | Best |

| Freq. (MHz) | Ant.Pol. H/V | Emission Level (dBuV/m) | Limit 3m (dBuV/m) | Over (dB) |
|----------------|-----------------|-------------------------------|----------------------|--------------|
| -- | -- | -- | -- | -- |

Note: The low frequency, which started from 9KHz-30MHz, was pre-scanned and the result which was 20dB lower than the limit line per 15.31(o) was not reported.

Below 1000MHz:

Pass.

The data of the mode (GFSK 2480MHz) are recorded in the following pages.

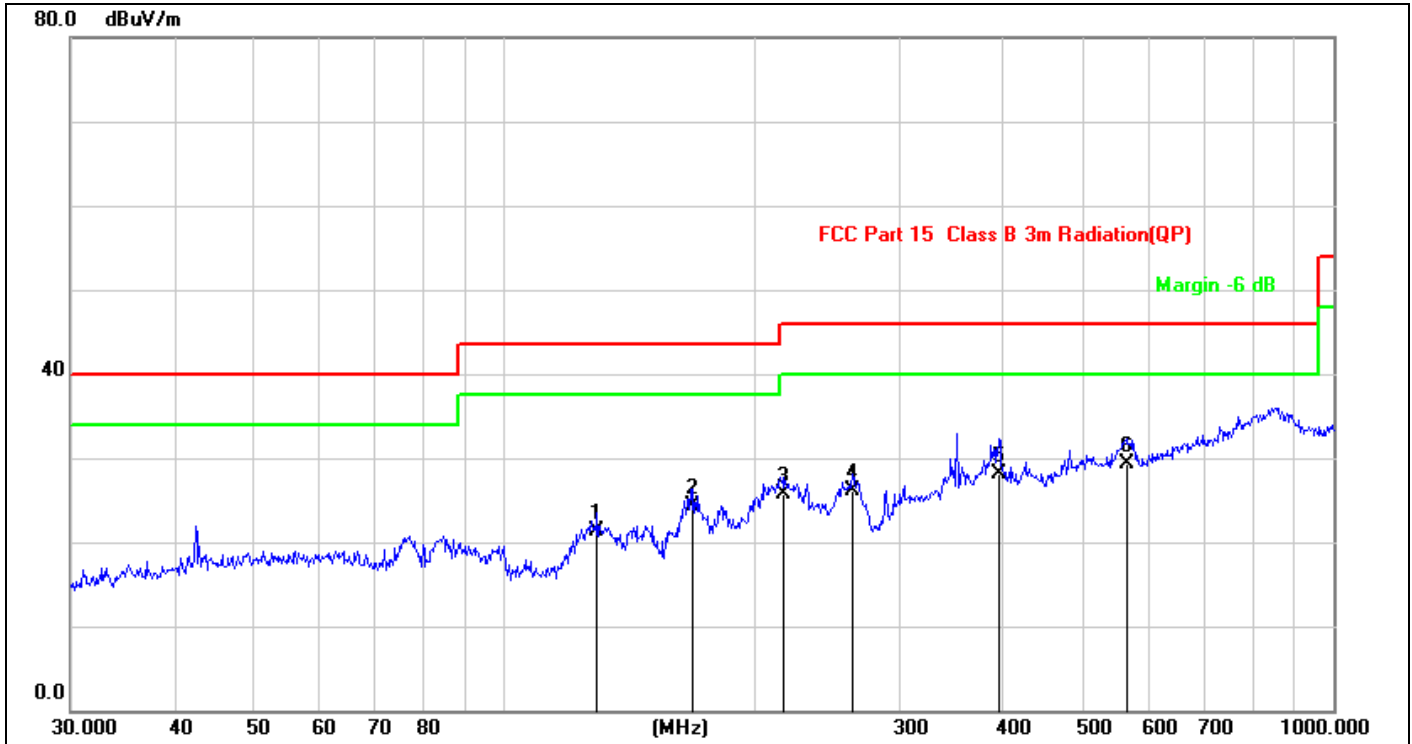

| | | | | | |
|---------------|-------------------------------------|-----------------------|--------------|------------------------|-------|
| Site: | LAB | Antenna:: | Horizontal | Temperature(C): | 26(C) |
| Limit: | FCC Part 15 C 3m Radiation | | | Humidity(%): | 60% |
| EUT: | Flydigi Mobile Phone Cooling Fan B5 | Test Time: | 2022-03-22 | | |
| M/N.: | Flydigi B5 | Power Rating: | AC 120V/60Hz | | |
| Mode: | TX2480 | Test Engineer: | Bast | | |
| Note: | | | | | |

| No. | Frequency (MHz) | Reading (dBuV) | Factor (dB/m) | Level (dBuV/m) | Limit (dBuV/m) | Margin (dB) | Det. | Height (cm) | Azimuth (deg) | Remark |
|-----|-----------------|----------------|---------------|----------------|----------------|-------------|------|-------------|---------------|--------|
| 1 | 129.4677 | 33.64 | -12.24 | 21.40 | 43.50 | -22.10 | QP | 112 | 45 | |
| 2 | 169.0054 | 36.26 | -11.87 | 24.39 | 43.50 | -19.11 | QP | 156 | 302 | |
| 3 | 216.7828 | 36.88 | -11.15 | 25.73 | 46.00 | -20.27 | QP | 202 | 27 | |
| 4 | 262.8955 | 35.05 | -9.03 | 26.02 | 46.00 | -19.98 | QP | 177 | 132 | |
| 5 | 394.8545 | 32.14 | -3.94 | 28.20 | 46.00 | -17.80 | QP | 136 | 273 | |
| 6 * | 562.6624 | 29.36 | 0.04 | 29.40 | 46.00 | -16.60 | QP | 190 | 96 | |

*:Maximum data x:Over limit !:over margin

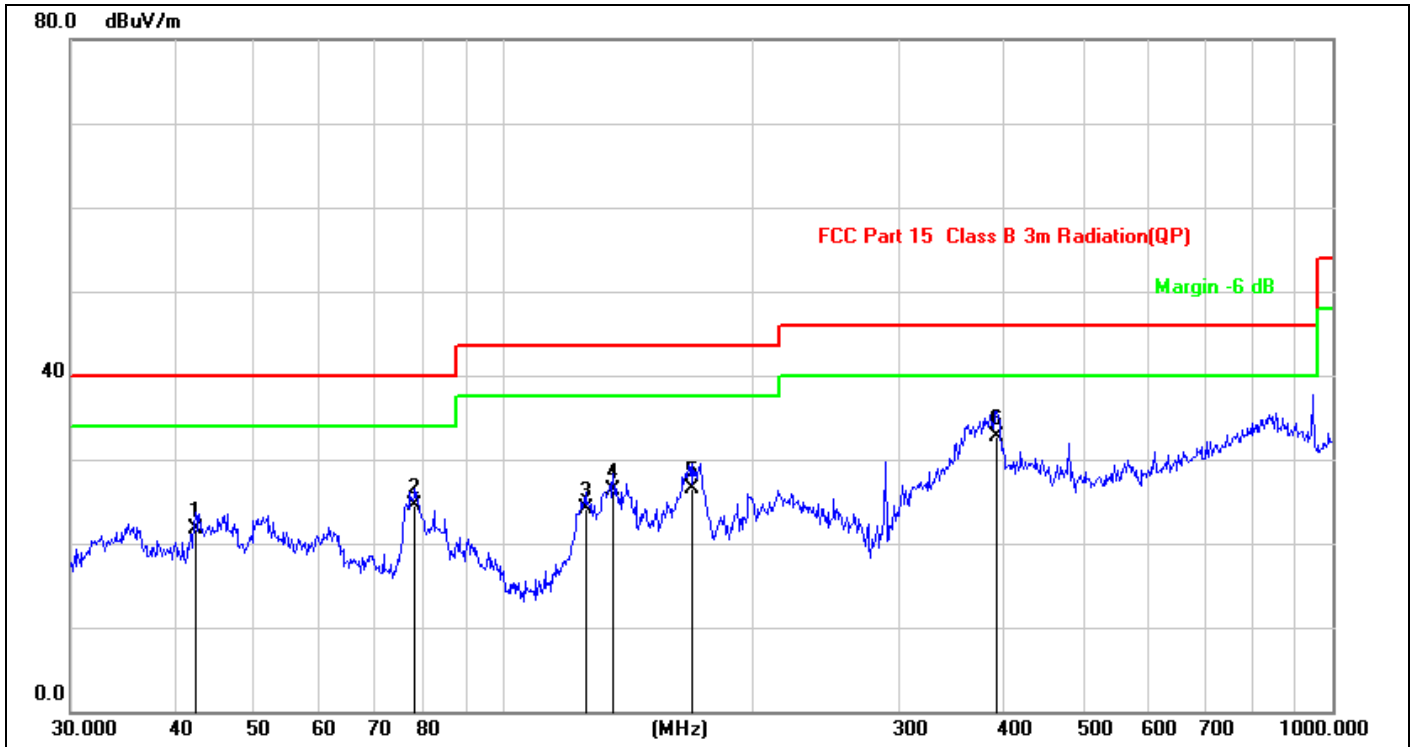

| | | | | | |
|---------------|--|-----------------------|-----------------|------------------------|--------------|
| Site: | LAB | Antenna:: | Vertical | Temperature(C): | 26(C) |
| Limit: | FCC Part 15 C 3m Radiation | Test Time: | | Humidity(%): | 60% |
| EUT: | Flydigi Mobile Phone Cooling Fan B5 | Power Rating: | | 2022-03-22 | |
| M/N.: | Flydigi B5 | Test Engineer: | | AC 120V/60Hz | |
| Mode: | TX2480 | | | Bast | |
| Note: | | | | | |

| No. | Frequency (MHz) | Reading (dBuV) | Factor (dB/m) | Level (dBuV/m) | Limit (dBuV/m) | Margin (dB) | Det. | Height (cm) | Azimuth (deg) | Remark |
|-----|-----------------|----------------|---------------|----------------|----------------|-------------|------|-------------|---------------|--------|
| 1 | 42.4508 | 32.46 | -10.68 | 21.78 | 40.00 | -18.22 | QP | 109 | 223 | |
| 2 | 78.1389 | 36.86 | -12.38 | 24.48 | 40.00 | -15.52 | QP | 186 | 88 | |
| 3 | 125.4457 | 36.41 | -12.26 | 24.15 | 43.50 | -19.35 | QP | 161 | 129 | |
| 4 | 135.5062 | 38.50 | -12.19 | 26.31 | 43.50 | -17.19 | QP | 155 | 187 | |
| 5 | 169.0054 | 38.32 | -11.87 | 26.45 | 43.50 | -17.05 | QP | 123 | 165 | |
| 6 * | 393.4723 | 36.66 | -3.99 | 32.67 | 46.00 | -13.33 | QP | 176 | 87 | |

*:Maximum data x:Over limit !:over margin



Above 1000MHz~10th Harmonics:

Operation Mode: TX Mode (CH00: 2402MHz) Test Date : 2022-03-22
 Frequency Range: 1-25GHz Temperature : 25°C
 Test Result: PASS Humidity : 58 %
 Measured Distance: 3m Test By: Best

| Freq. (MHz) | Ant. Pol. H/V | Reading Level(dBuV/m) | | Correct Factor dB | Emission Level(dBuV/m) | | Limit 3m(dBuV/m) | | Over(dB) | |
|----------------|---------------------|--------------------------|-------|-------------------------|---------------------------|-------|---------------------|----|----------|--------|
| | | PK | AV | | PK | AV | PK | AV | PK | AV |
| 4804 | V | 95.55 | 76.82 | -32.3 | 63.25 | 44.52 | 74 | 54 | -10.75 | -9.48 |
| 7206 | V | 98.4 | 78.83 | -37.2 | 61.2 | 41.63 | 74 | 54 | -12.8 | -12.37 |
| 9608 | V | 98.12 | 79.38 | -39.8 | 58.32 | 39.58 | 74 | 54 | -15.68 | -14.42 |
| 12010 | V | 96.84 | 78.3 | -40.5 | 56.34 | 37.8 | 74 | 54 | -17.66 | -16.2 |
| 14412 | V | 97.9 | 78.55 | -41.7 | 56.2 | 36.85 | 74 | 54 | -17.8 | -17.15 |
| 16814 | V | 95.69 | 76.46 | -40 | 55.69 | 36.46 | 74 | 54 | -18.31 | -17.54 |
| 4804 | H | 95.05 | 75.57 | -31.6 | 63.45 | 43.97 | 74 | 54 | -10.55 | -10.03 |
| 7206 | H | 96.73 | 77.8 | -35.5 | 61.23 | 42.3 | 74 | 54 | -12.77 | -11.7 |
| 9608 | H | 96.5 | 77.95 | -38.3 | 58.2 | 39.65 | 74 | 54 | -15.8 | -14.35 |
| 12010 | H | 95.2 | 76.62 | -39 | 56.2 | 37.62 | 74 | 54 | -17.8 | -16.38 |
| 14412 | H | 97.14 | 78.58 | -42 | 55.14 | 36.58 | 74 | 54 | -18.86 | -17.42 |
| 16814 | H | 94.62 | 75.71 | -39.3 | 55.32 | 36.41 | 74 | 54 | -18.68 | -17.59 |

Other harmonics emissions are lower than 20dB below the allowable limit.

- Note:**
- (1) All Readings are Peak Value and AV.
 - (2) Emission Level= Reading Level+ Probe Factor +Cable Loss.
 - (3) The average measurement was not performed when the peak measured data under the limit of average detection.
 - (4) Measuring frequencies from 1GHz to 25GHz.



Operation Mode: TX Mode (CH19: 2440MHz) Test Date : 2022-03-22
 Frequency Range: 1-25GHz Temperature : 25°C
 Test Result: PASS Humidity : 58 %
 Measured Distance: 3m Test By: Best

| Freq. (MHz) | Ant. Pol. H/V | Reading Level(dBuV/m) | | Correct Factor dB | Emission Level(dBuV/m) | | Limit 3m(dBuV/m) | | Margin(dB) | |
|----------------|---------------------|--------------------------|-------|-------------------------|---------------------------|-------|---------------------|----|------------|--------|
| | | PK | AV | | PK | AV | PK | AV | PK | AV |
| 4880 | V | 96.6 | 76.53 | -32.3 | 64.3 | 44.23 | 74 | 54 | -9.7 | -9.77 |
| 7320 | V | 98.2 | 79.22 | -37.2 | 61 | 42.02 | 74 | 54 | -13 | -11.98 |
| 9760 | V | 98.36 | 79.42 | -39.8 | 58.56 | 39.62 | 74 | 54 | -15.44 | -14.38 |
| 12200 | V | 97.82 | 79.12 | -40.5 | 57.32 | 38.62 | 74 | 54 | -16.68 | -15.38 |
| 14640 | V | 97.3 | 78.58 | -41 | 56.3 | 37.58 | 74 | 54 | -17.7 | -16.42 |
| 17080 | V | 96.4 | 77.68 | -41.1 | 55.3 | 36.58 | 74 | 54 | -18.7 | -17.42 |
| 4880 | H | 95.3 | 75.29 | -31.6 | 63.7 | 43.69 | 74 | 54 | -10.3 | -10.31 |
| 7320 | H | 96.82 | 77.8 | -35.5 | 61.32 | 42.3 | 74 | 54 | -12.68 | -11.7 |
| 9760 | H | 96.62 | 77.77 | -38.3 | 58.32 | 39.47 | 74 | 54 | -15.68 | -14.53 |
| 12200 | H | 97.347 | 78.36 | -39 | 58.347 | 39.36 | 74 | 54 | -15.65 | -14.64 |
| 14640 | H | 98.32 | 79.25 | -42 | 56.32 | 37.25 | 74 | 54 | -17.68 | -16.75 |
| 17080 | H | 97.8 | 78.62 | -41.5 | 56.3 | 37.12 | 74 | 54 | -17.7 | -16.88 |

Other harmonics emissions are lower than 20dB below the allowable limit.

- Note:**
- (1) All Readings are Peak Value and AV.
 - (2) Emission Level= Reading Level+ Probe Factor +Cable Loss.
 - (3) The average measurement was not performed when the peak measured data under the limit of average detection.
 - (4) Measuring frequencies from 1GHz to 25GHz.



Operation Mode: TX Mode (CH39: 2480MHz) Test Date : 2022-03-22
 Frequency Range: 1-25GHz Temperature : 25°C
 Test Result: PASS Humidity : 58 %
 Measured Distance: 3m Test By: Best

| Freq. (MHz) | Ant. Pol. | Reading Level(dBuV/m) | | Correct Factor dB | Emission Level(dBuV/m) | | Limit 3m(dBuV/m) | | Margin(dB) | |
|----------------|--------------|--------------------------|-------|-------------------------|---------------------------|-------|---------------------|----|------------|--------|
| | | PK | AV | | PK | AV | PK | AV | PK | AV |
| 4960 | V | 95.75 | 75.88 | -32.3 | 63.45 | 43.58 | 74 | 54 | -10.55 | -10.42 |
| 7440 | V | 98.4 | 79.33 | -37.2 | 61.2 | 42.13 | 74 | 54 | -12.8 | -11.87 |
| 9920 | V | 99.01 | 79.82 | -39.8 | 59.21 | 40.02 | 74 | 54 | -14.79 | -13.98 |
| 12400 | V | 96.82 | 78.08 | -40.5 | 56.32 | 37.58 | 74 | 54 | -17.68 | -16.42 |
| 14880 | V | 96.32 | 77.47 | -41 | 55.32 | 36.47 | 74 | 54 | -18.68 | -17.53 |
| 17360 | V | 96.22 | 77.68 | -41.1 | 55.12 | 36.58 | 74 | 54 | -18.88 | -17.42 |
| 4960 | H | 95.07 | 75.23 | -31.6 | 63.47 | 43.63 | 74 | 54 | -10.53 | -10.37 |
| 7440 | H | 96.52 | 77.52 | -35.5 | 61.02 | 42.02 | 74 | 54 | -12.98 | -11.98 |
| 9920 | H | 96.62 | 77.92 | -38.3 | 58.32 | 39.62 | 74 | 54 | -15.68 | -14.38 |
| 12400 | H | 95.32 | 76.85 | -39 | 56.32 | 37.85 | 74 | 54 | -17.68 | -16.15 |
| 14880 | H | 97.02 | 78.47 | -42 | 55.02 | 36.47 | 74 | 54 | -18.98 | -17.53 |
| 17360 | H | 96.67 | 77.76 | -41.5 | 55.17 | 36.26 | 74 | 54 | -18.83 | -17.74 |

Other harmonics emissions are lower than 20dB below the allowable limit.

- Note:**
- (1) All Readings are Peak Value and AV.
 - (2) Emission Level= Reading Level+ Probe Factor +Cable Loss.
 - (3) The average measurement was not performed when the peak measured data under the limit of average detection.
 - (4) Measuring frequencies from 1GHz to 25GHz.

7.6 Radiated Measurement Photos:





8. 6dB Bandwidth Measurement

8.1 Measurement Procedure

The EUT was operating in Bluetooth mode or could be controlled its channel. Printed out the test result from the spectrum by hard copy function.

8.2 Test SET-UP (Block Diagram of Configuration)

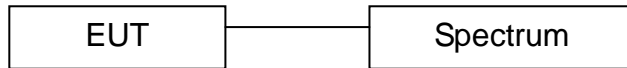

8.3 Measurement Equipment Used:

| EQUIPMENT TYPE | MFR | MODEL NUMBER | SERIAL NUMBER | CALIBRATED UNTIL |
|-------------------|--------------------|--------------|---------------|------------------|
| Spectrum Analyzer | Rohde & Schwarz | FSV40 | US40240623 | 2022-11-13 |
| Coaxial Cable | Gigalink Microwave | ZT40 | 19022092 | 2022-11-13 |
| Antenna Connector | ARTHUR-YANG | 2244-N1TG1 | N/A | 2022-11-13 |

Remark: The temporary antenna connector is soldered on the PCB board in order to perform conducted tests and this temporary antenna connector is listed in the equipment list.

8.4 Limit

The minimum 6dB bandwidth shall be at least 500kHz.

8.5 Measurement Results:

Refer to attached data chart.

| | | | |
|--------------------|------|---------------|------------|
| Spectrum Detector: | PK | Test Date : | 2022-03-14 |
| Test By: | Best | Temperature : | 24 °C |
| Test Result: | PASS | Humidity : | 53 % |

| Channel number | Channel frequency (MHz) | Measurement level (KHz) | Required Limit (KHz) |
|----------------|-------------------------|-------------------------|----------------------|
| 00 | 2402 | 663 | >500 |
| 19 | 2440 | 681 | >500 |
| 39 | 2480 | 695 | >500 |

6dB NVNT BLE 2402MHz Ant1

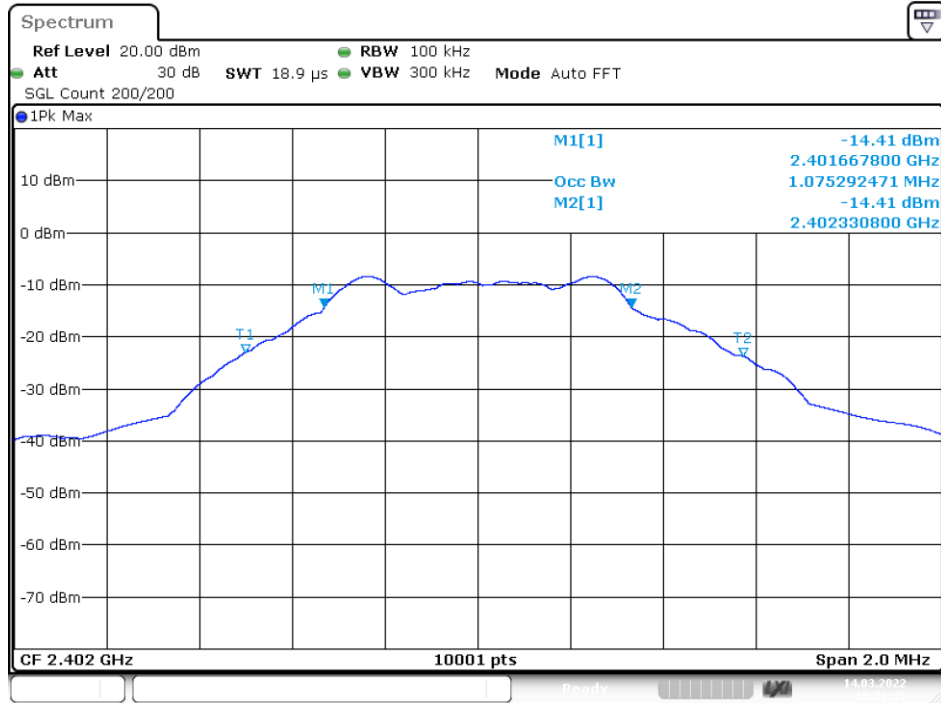

Date: 14.MAR.2022 10:31:35

6dB NVNT BLE 2440MHz Ant1

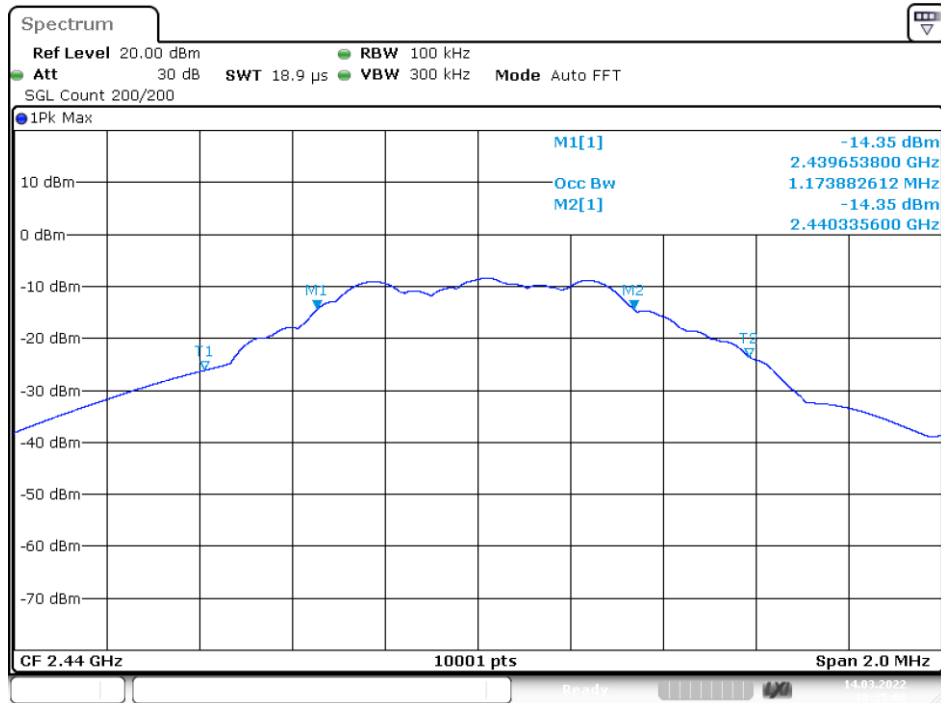

Date: 14.MAR.2022 10:35:06



Report No.: E01A22030366F00201

30 of 50

6dB NVNT BLE 2480MHz Ant1

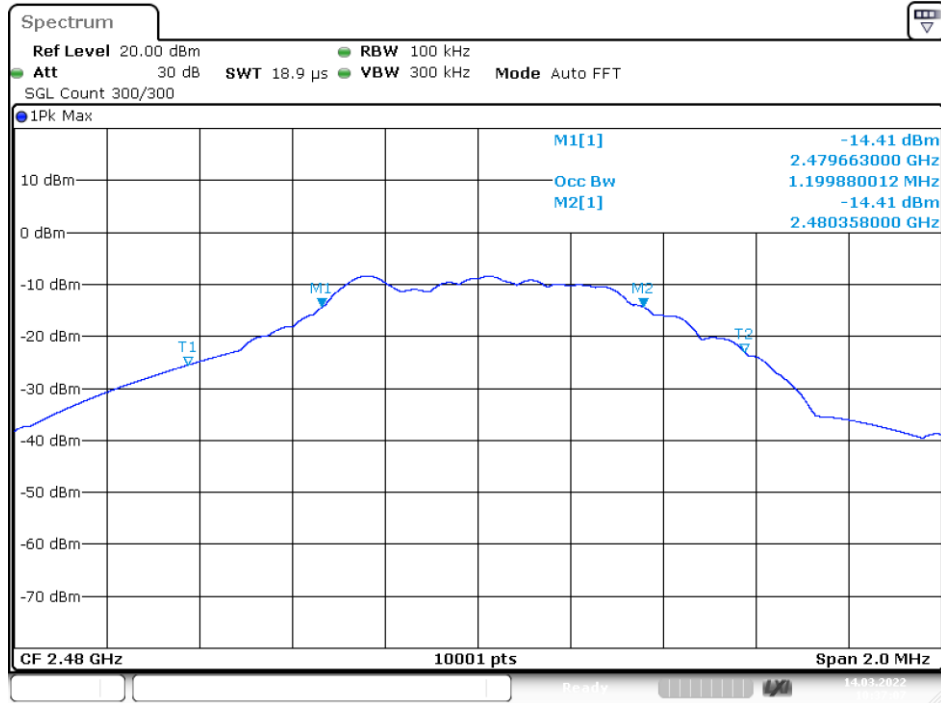

Date: 14.MAR.2022 10:37:07

9. MAXIMUM PEAK OUTPUT POWER TEST

9.1 Measurement Procedure

- a. The Transmitter output (antenna port) was connected to the spectrum Analyzer.
- b. Turn on the EUT and then record the peak power value.
- c. Repeat above procedures on all channels needed to be tested.

9.2 Test SET-UP (Block Diagram of Configuration)



9.3 Measurement Equipment Used:

| EQUIPMENT TYPE | MFR | MODEL NUMBER | SERIAL NUMBER | CALIBRATED UNTIL |
|-------------------|--------------------|--------------|---------------|------------------|
| Spectrum Analyzer | Rohde & Schwarz | FSV40 | US40240623 | 2022-11-13 |
| Coaxial Cable | Gigalink Microwave | ZT40 | 19022092 | 2022-11-13 |
| Antenna Connector | ARTHUR-YANG | 2244-N1TG1 | N/A | 2022-11-13 |

Remark: The temporary antenna connector is soldered on the PCB board in order to perform conducted tests and this temporary antenna connector is listed in the equipment list.

9.4 Peak Power output limit

The maximum peak power shall be less 1Watt.

9.5 Measurement Results:

Refer to attached data chart.

| | | | |
|--------------------|------|---------------|------------|
| Spectrum Detector: | PK | Test Date : | 2022-03-14 |
| Test By: | Best | Temperature : | 24 °C |
| Test Result: | PASS | Humidity : | 53 % |



| Channel number | Channel Frequency (MHz) | Peak Power output(dBm) | Peak Power output(mW) | Peak Power Limit(mW) | Pass/Fail |
|----------------|-------------------------|------------------------|-----------------------|----------------------|-----------|
| 01 | 2402 | -0.08 | 0.982 | 1000 | PASS |
| 19 | 2441 | 0 | 1.000 | 1000 | PASS |
| 39 | 2480 | 0.07 | 1.016 | 1000 | PASS |

Power NVNT BLE 2402MHz Ant1

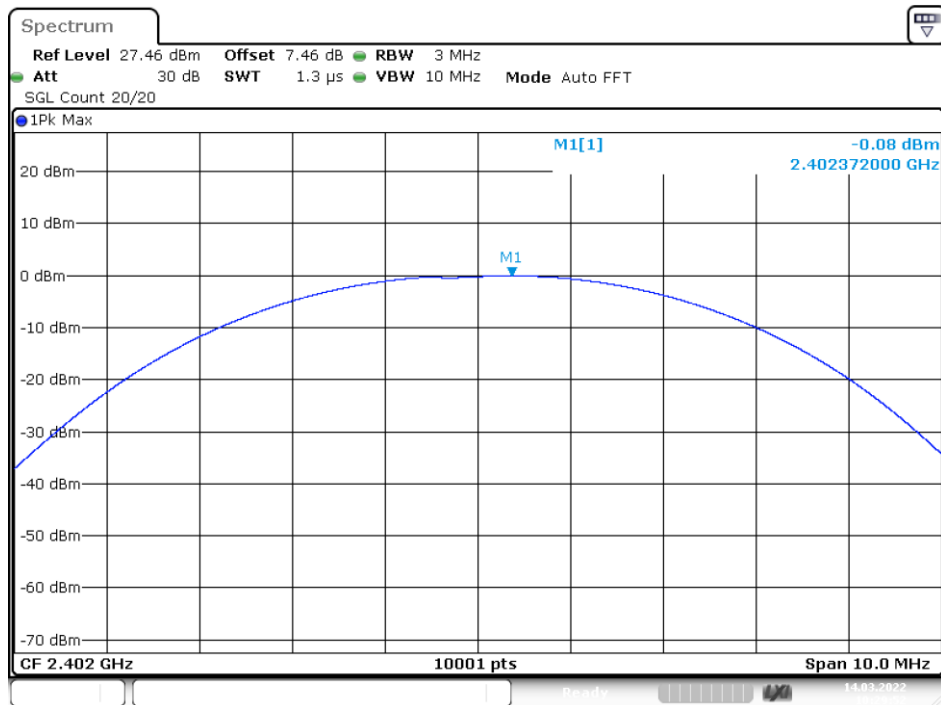

Date: 14.MAR.2022 10:29:52



Power NVNT BLE 2440MHz Ant1

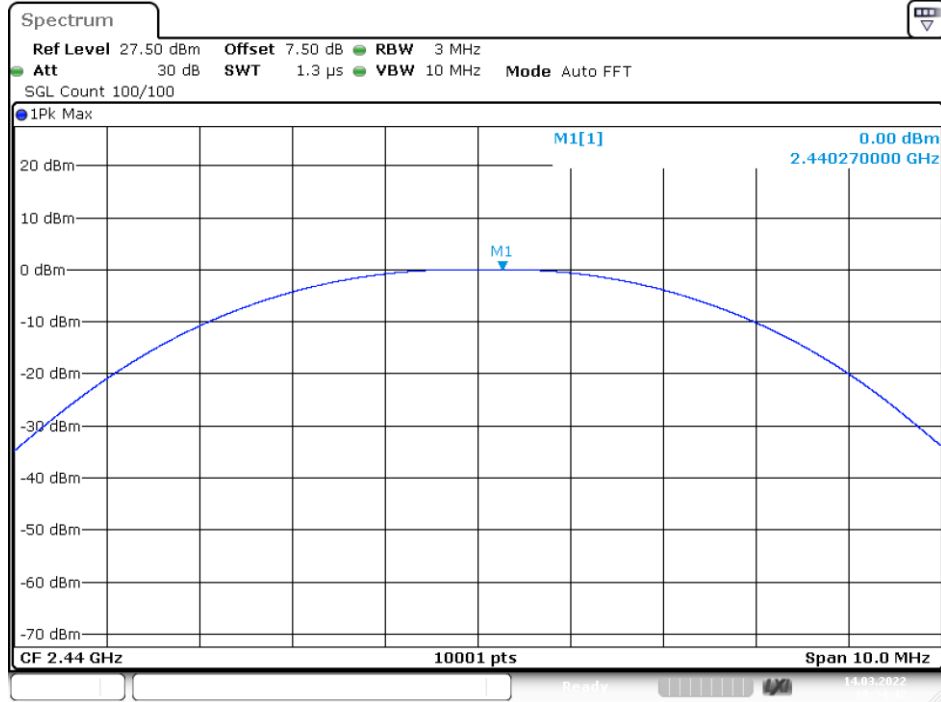

Date: 14.MAR.2022 10:34:42

Power NVNT BLE 2480MHz Ant1

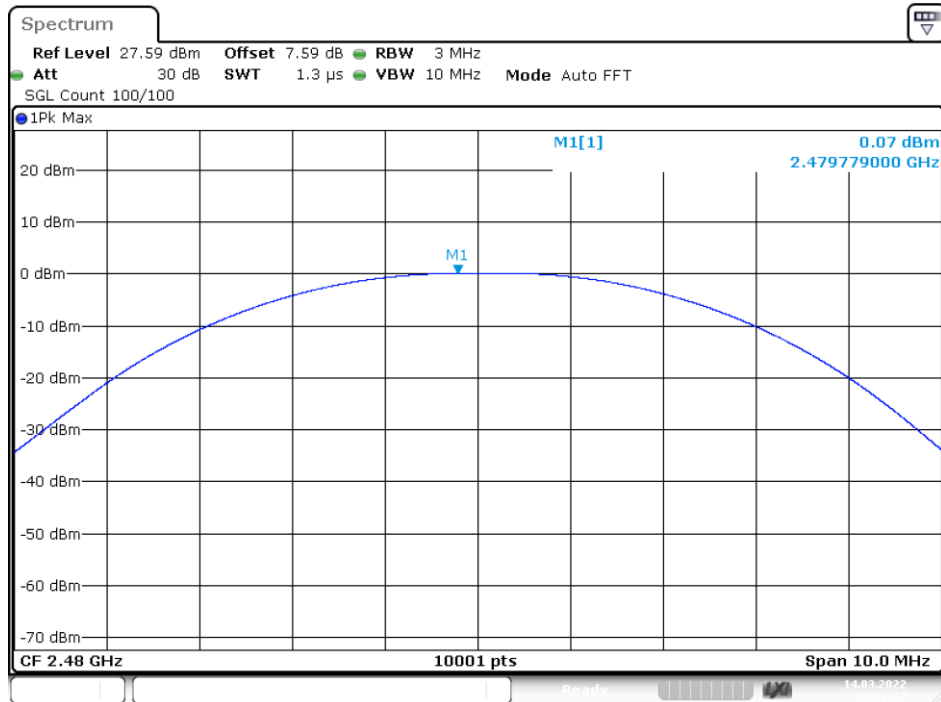

Date: 14.MAR.2022 10:36:26

10. Power Spectral Density Measurement

10.1 Measurement Procedure

The EUT was operating in Bluetooth mode or could be controlled its channel. Printed out the test result from the spectrum by hard copy function.

10.2 Test SET-UP (Block Diagram of Configuration)

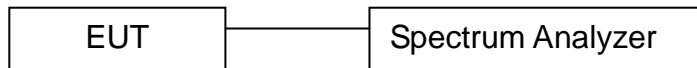

10.3 Measurement Equipment Used:

| EQUIPMENT TYPE | MFR | MODEL NUMBER | SERIAL NUMBER | CALIBRATED UNTIL |
|-------------------|--------------------|--------------|---------------|------------------|
| Spectrum Analyzer | Rohde & Schwarz | FSV40 | US40240623 | 2022-11-13 |
| Coaxial Cable | Gigalink Microwave | ZT40 | 19022092 | 2022-11-13 |
| Antenna Connector | ARTHUR-YANG | 2244-N1TG1 | N/A | 2022-11-13 |

Remark: The temporary antenna connector is soldered on the PCB board in order to perform conducted tests and this temporary antenna connector is listed in the equipment list.

10.4 Measurement Procedure

10.4.1 The RF output of EUT was connected to the spectrum analyzer by RF cable and attenuator. The path loss was compensated to the results for each measurement.

10.4.2. Set to the maximum power setting and enable the EUT transmit continuously.

10.4.3. Make the measurement with the spectrum analyzer's resolution bandwidth (RBW) = 3 kHz. Video bandwidth VBW = 10 kHz In order to make an accurate measurement, set the span to 1.5 times DTS Channel Bandwidth. (6dB BW)

10.4.4. Detector = peak, Sweep time = auto couple, Trace mode = max hold, Allow trace to fully stabilize. Use the peak marker function to determine the maximum power level.

10.4.5. Measure and record the results in the test report.

10.4.6. The Measured power density (dBm)/ 100KHz is a reference level and used as 20dBc down limit line for Conducted Band Edges and Conducted Spurious Emission.



10.5 Measurement Results:

The following table is the setting of spectrum analyzer.

| Spectrum analyzer | Setting |
|-------------------|--|
| Attenuation | Auto |
| Span Frequency | Set the span to 1.5 times the DTS bandwidth. |
| RB | 3KHz |
| VB | 10KHz |
| Detector | Peak |
| Trace | Max hold |
| Sweep Time | Automatic |

Refer to attached data chart.

| | | | |
|--------------------|------|---------------|------------|
| Spectrum Detector: | PK | Test Date : | 2022-03-14 |
| Test By: | Best | Temperature : | 24 °C |
| Test Result: | PASS | Humidity : | 53 % |

| Channel number | Channel frequency (MHz) | Measurement level (dBm) | Required Limit (dBm/3kHz) | Pass/Fail |
|----------------|-------------------------|-------------------------|---------------------------|-----------|
| | | PSD/3kHz | | |
| 00 | 2402 | -14.98 | 8 | PASS |
| 19 | 2440 | -16.38 | 8 | PASS |
| 39 | 2480 | -14.51 | 8 | PASS |

Note:

1. Measured power density(dBm) has offset with cable loss.
2. The measured power density(dBm)/100KHz is reference level and used as 20dBc down for Conducted Band Edges and Conducted Spurious Emission limit line.



Report No.: E01A22030366F00201

36 of 50

PSD NVNT BLE 2402MHz Ant1

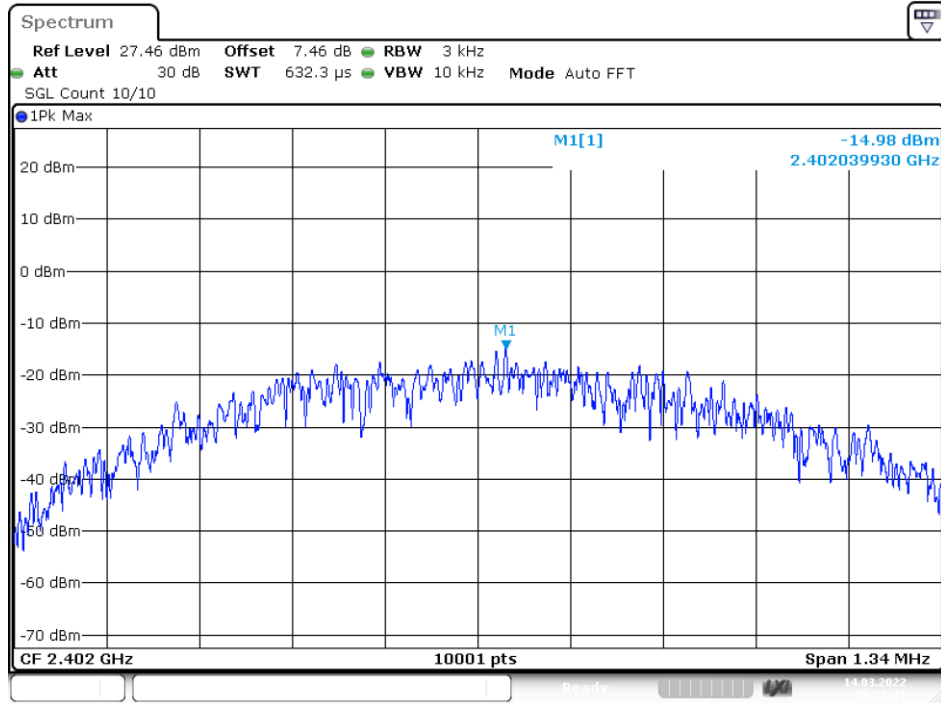

Date: 14.MAR.2022 10:31:11

PSD NVNT BLE 2440MHz Ant1

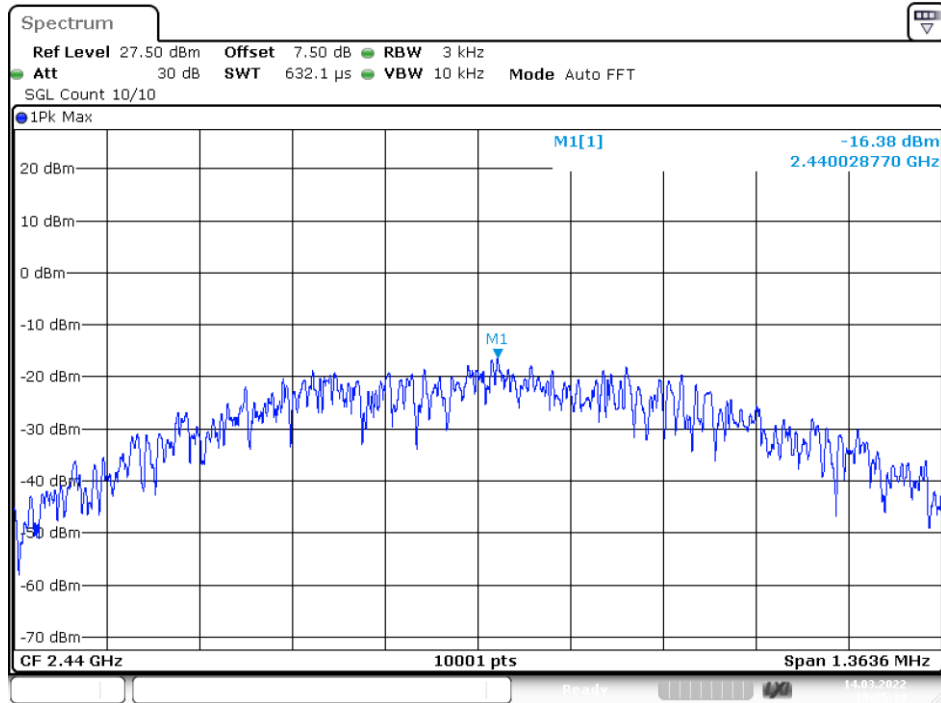

Date: 14.MAR.2022 10:35:14



PSD NVNT BLE 2480MHz Ant1

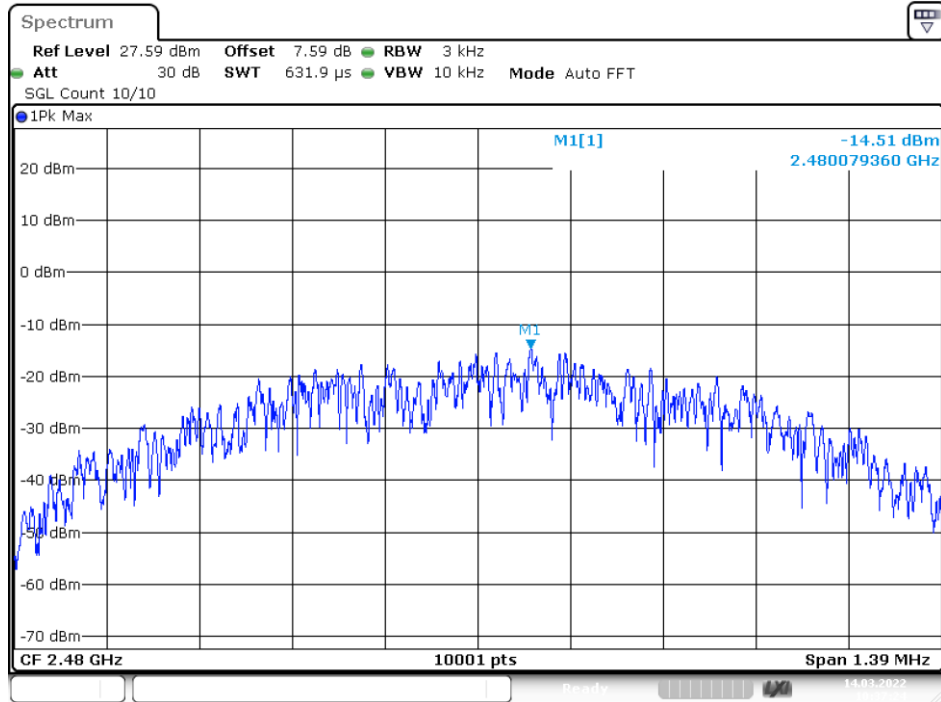

Date: 14.MAR.2022 10:37:24

11. Band EDGE test

11.1 Measurement Procedure

For Conducted Test

1. The transmitter output is connected to a spectrum analyzer. The resolution bandwidth is set to 100KHz. The video bandwidth is set to 300KHz.
2. The spectrum from 30MHz to 26 GHz is investigated with the transmitter set to the lowest, middle, and highest channels.

| EMI Test Receiver | Setting |
|-------------------|----------|
| Attenuation | Auto |
| RBW | 100KHz |
| VBW | 300KHz |
| Detector | Peak |
| Trace | Max hold |

For Radiated emission Test

The EUT was placed on a styrofoam table which is 1.5m above ground plane.

The measurement procedure at the ban edges was simplified by performing the measurement in just one plot. Both, the in-band-emission and the unwanted emission were be encompassed by the span. After trace stabilization, the maximum peak was be determined by a peak detector and the value was marked by an appropriate limit line. The second limit line, which is 20dB below the first, marks the limit for the emissions in the unrestricted band. A maximum-peak-detector marks the highest emission in the unrestricted band next to the band edge.

The measurements were performed at the lower end of the 2.4GHz band.

Use the following spectrum analyzer settings:

For Restricted Band, When spectrum scanned above 1GHz setting resolution bandwidth 1MHz, video bandwidth 3MHz:

| EMI Test Receiver | Setting |
|-------------------|----------|
| Attenuation | Auto |
| RBW | 1MHz |
| VBW | 3MHz |
| Detector | Peak |
| Trace | Max hold |

For Non-Restricted Band, When spectrum scanned above 1GHz setting resolution bandwidth 100KHz, video bandwidth 300KHz:

| EMI Test Receiver | Setting |
|-------------------|----------|
| Attenuation | Auto |
| RBW | 100KHz |
| VBW | 300KHz |
| Detector | Peak |
| Trace | Max hold |

11.2 Test SET-UP (Block Diagram of Configuration)

For Conducted Test

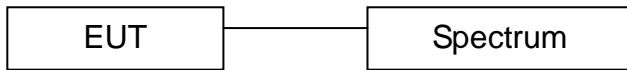

For Radiated emission Test

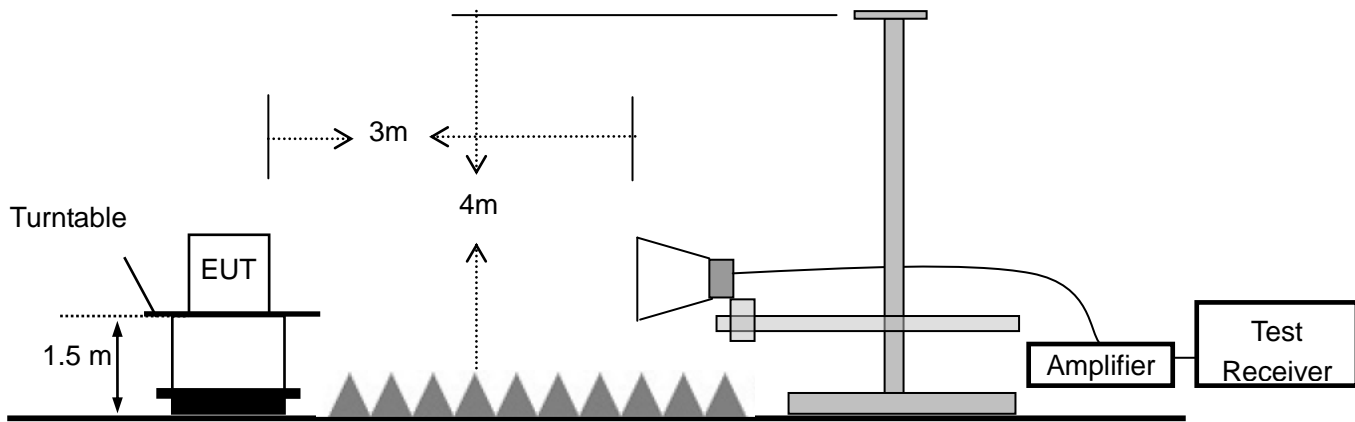

11.3 Measurement Equipment Used:

For Conducted Test

| EQUIPMENT TYPE | MFR | MODEL NUMBER | SERIAL NUMBER | CALIBRATED UNTIL |
|-------------------|--------------------|--------------|---------------|------------------|
| Spectrum Analyzer | Rohde & Schwarz | FSV40 | US40240623 | 2022-11-13 |
| Coaxial Cable | Gigalink Microwave | ZT40 | 19022092 | 2022-11-13 |
| Antenna Connector | ARTHUR-YANG | 2244-N1TG1 | N/A | 2022-11-13 |

Remark: The temporary antenna connector is soldered on the PCB board in order to perform conducted tests and this temporary antenna connector is listed in the equipment list.

For Radiated emission Test

| Item | Equipment | Manufacturer | Model No. | Serial No. | Calibrated Until |
|------|------------------------------|--------------------|-----------------------|-----------------|------------------|
| 1 | Signal Analyzer | Rohde & Schwarz | FSV40 | US40240623 | 2022-11-13 |
| 2 | Broadband RF Power Amplifier | AEROFLEX | AEROFLEX100KHz-40G Hz | J1013130524 001 | 2022-11-13 |
| 3 | DRG Horn Antenna | A.H.SYSTEMS | SAS-574 | J2031090612 123 | 2022-11-13 |
| 4 | RF Cable | Gigalink Microwave | ZT40-2.92J-2.92J-2m | N/A | 2022-05-22 |
| 5 | RF Cable | Gigalink Microwave | ZT40-2.92J-2.92J-0.3m | N/A | 2022-05-22 |



11.4 Measurement Results:

Refer to attached data chart.

| | | | |
|--------------------|------|---------------|------------|
| Spectrum Detector: | PK | Test Date : | 2022-03-14 |
| Test By: | Best | Temperature : | 24 °C |
| Test Result: | PASS | Humidity : | 53 % |

1. Conducted Test

| Frequency (MHz) | Peak Power Output(dBm) | Emission(dBm) | Result of Band edge(dBc) | Band edge Limit(dBc) |
|-----------------|------------------------|---------------|--------------------------|----------------------|
| 2386.8 | -0.89 | -42.07 | 41.18 | >20dBc |
| 2484.3 | -0.78 | -42.69 | 41.91 | >20dBc |

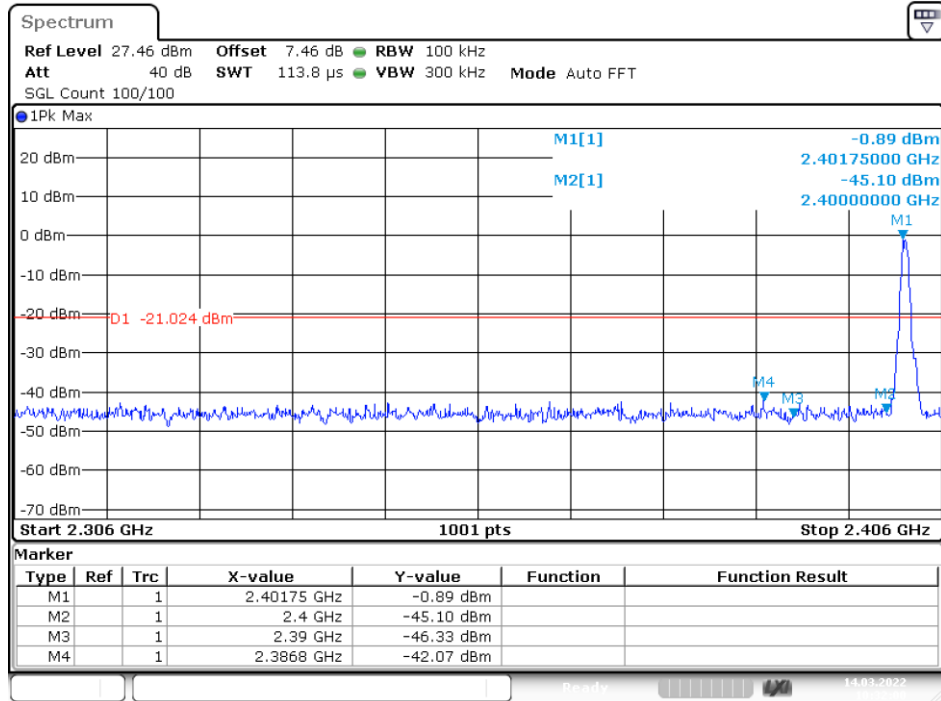

Date: 14.MAR.2022 10:31:59

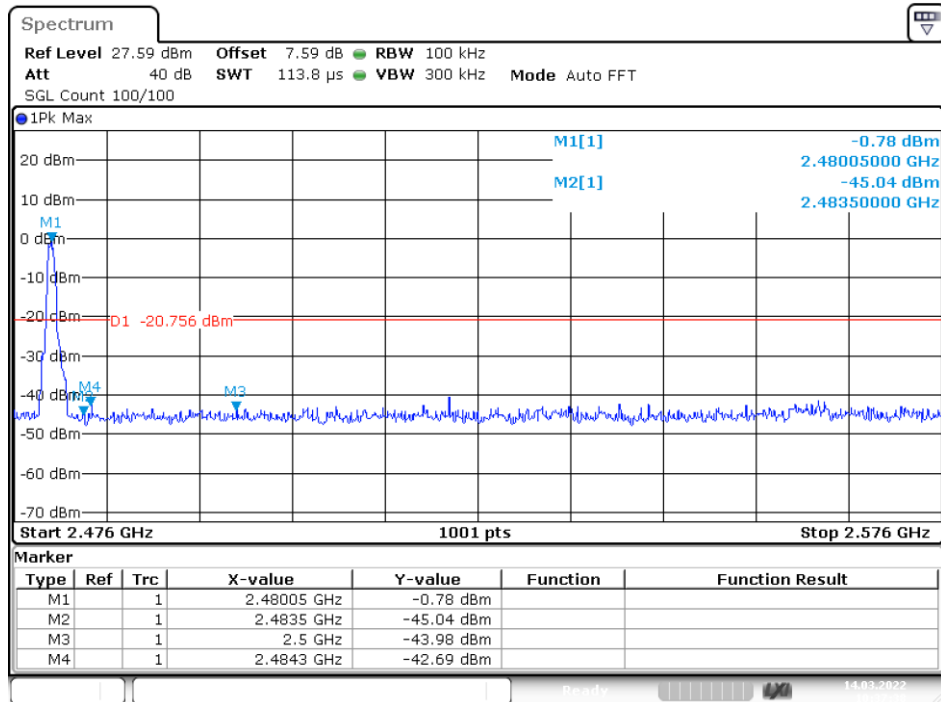

Date: 14.MAR.2022 10:37:38



Report No.: E01A22030366F00201

42 of 50

2. Radiated emission Test

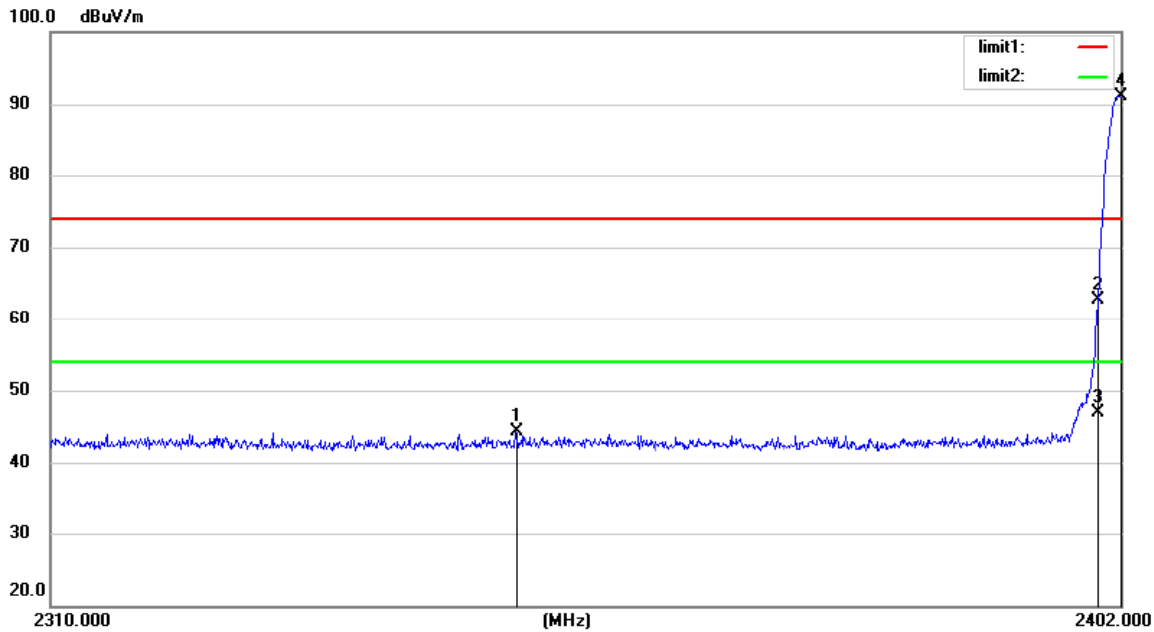

Site Chamber #1

Polarization: **Horizontal**

Temperature: 25

Limit: (RE)FCC PART 15 C 3m_PEAK

Power: AC 120V/60Hz

Humidity: 55 %

Mode: TX2402

Note:

| No. | Mk. | Freq. MHz | Reading Level dBuV | Correct Factor dB | Measure- ment dBuV/m | Limit dBuV/m | Over dB | Detector | Antenna Height cm | Table Degree degree | Comment |
|-----|-----|--------------|--------------------------|-------------------------|----------------------------|-----------------|------------|----------|-------------------------|---------------------------|---------|
| 1 | | 2349.560 | 55.98 | -11.74 | 44.24 | 74.00 | -29.76 | peak | | | |
| 2 | | 2400.000 | 74.31 | -11.63 | 62.68 | 74.00 | -11.32 | peak | | | |
| 3 | | 2400.000 | 58.55 | -11.63 | 46.92 | 54.00 | -7.08 | AVG | | | |
| 4 | * | 2402.000 | 102.83 | -11.63 | 91.20 | 74.00 | 17.20 | peak | | | |



Report No.: E01A22030366F00201

43 of 50

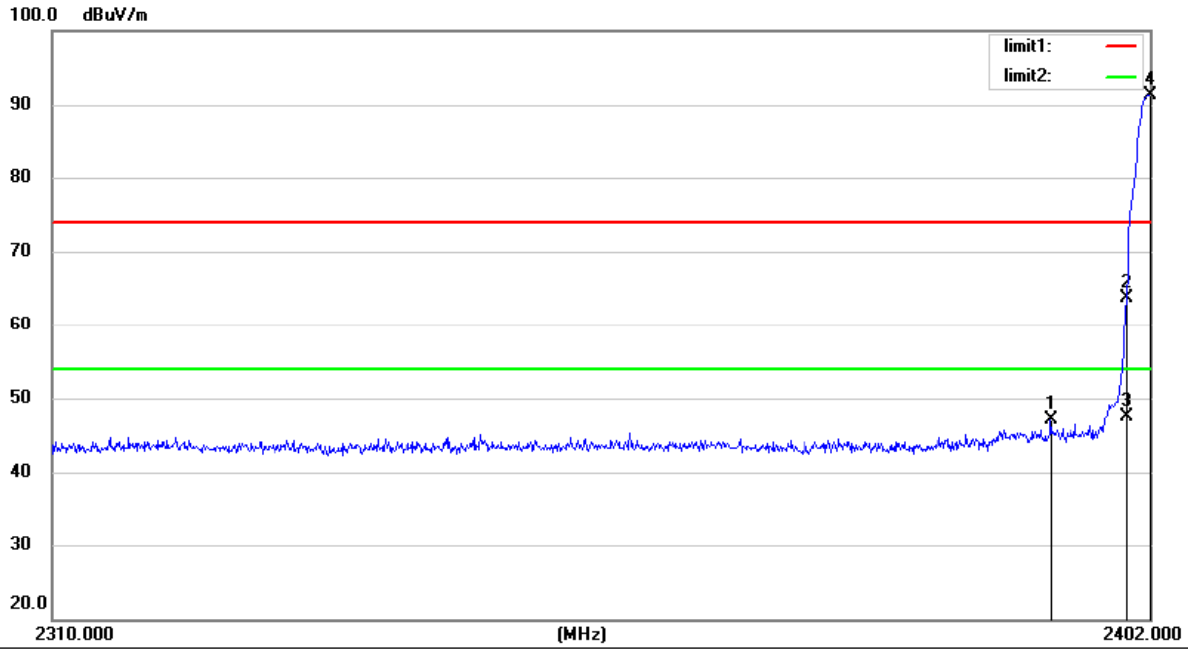

Site Chamber #1 Polarization: **Vertical** Temperature: 25
 Limit: (RE)FCC PART 15 C 3m_PEAK Power: AC 120V/60Hz Humidity: 55 %
 Mode: TX2402
 Note:

| No. | Mk. | Freq. MHz | Reading Level dBuV | Correct Factor dB | Measure- ment dBuV/m | Limit dBuV/m | Over dB | Detector | Antenna Height cm | Table Degree | Comment |
|-----|-----|--------------|--------------------------|-------------------------|----------------------------|-----------------|------------|----------|-------------------------|-----------------|---------|
| 1 | | 2393.536 | 57.52 | -10.51 | 47.01 | 74.00 | -26.99 | peak | | | |
| 2 | | 2400.000 | 74.15 | -10.47 | 63.68 | 74.00 | -10.32 | peak | | | |
| 3 | | 2400.000 | 57.98 | -10.47 | 47.51 | 54.00 | -6.49 | AVG | | | |
| 4 | * | 2402.000 | 101.84 | -10.46 | 91.38 | 74.00 | 17.38 | peak | | | |



Report No.: E01A22030366F00201

44 of 50

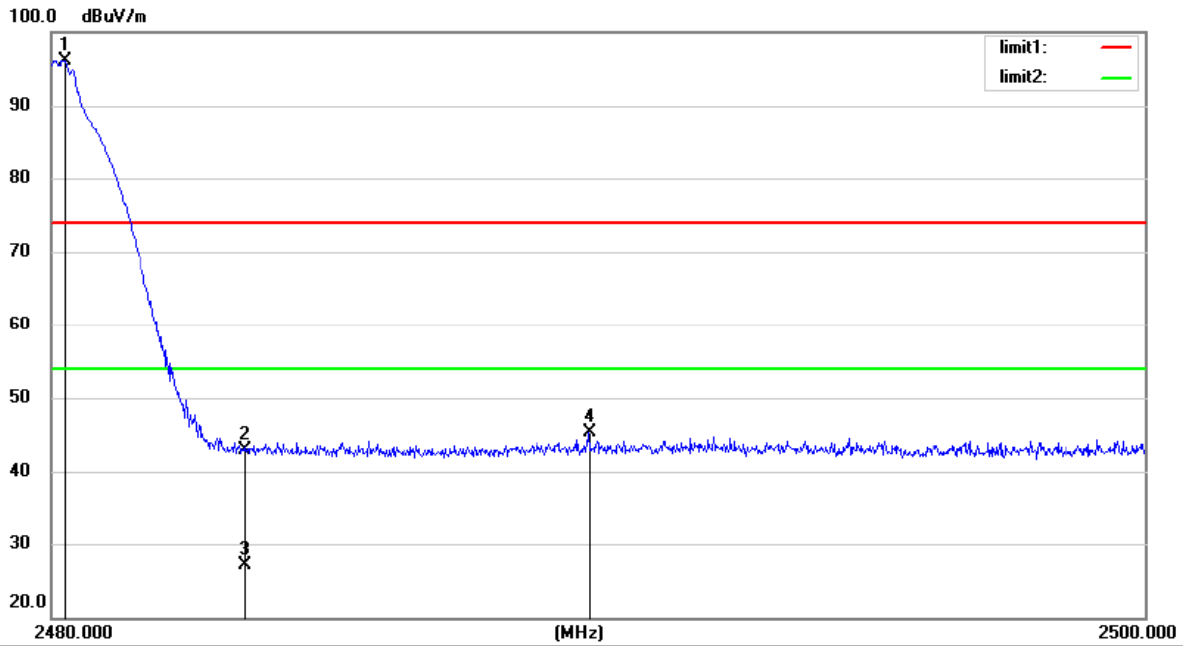

Site Chamber #1 Polarization: **Horizontal** Temperature: 25
 Limit: (RE)FCC PART 15 C 3m_PEAK Power: AC 120V/60Hz Humidity: 55 %
 Mode: TX2480
 Note:

| No. | Mk. | Freq. | Reading Level | Correct Factor | Measurement | Limit | Over | Antenna Height | Table Degree | Comment |
|-----|-----|----------|---------------|----------------|-------------|--------|--------|----------------|--------------|---------|
| | | MHz | dBuV | dB | dBuV/m | dBuV/m | dB | cm | degree | |
| 1 | * | 2480.220 | 107.51 | -11.45 | 96.06 | 74.00 | 22.06 | peak | | |
| 2 | | 2483.500 | 54.44 | -11.46 | 42.98 | 74.00 | -31.02 | peak | | |
| 3 | | 2483.500 | 38.66 | -11.46 | 27.20 | 54.00 | -26.80 | AVG | | |
| 4 | | 2489.800 | 56.70 | -11.44 | 45.26 | 74.00 | -28.74 | peak | | |



Report No.: E01A22030366F00201

45 of 50

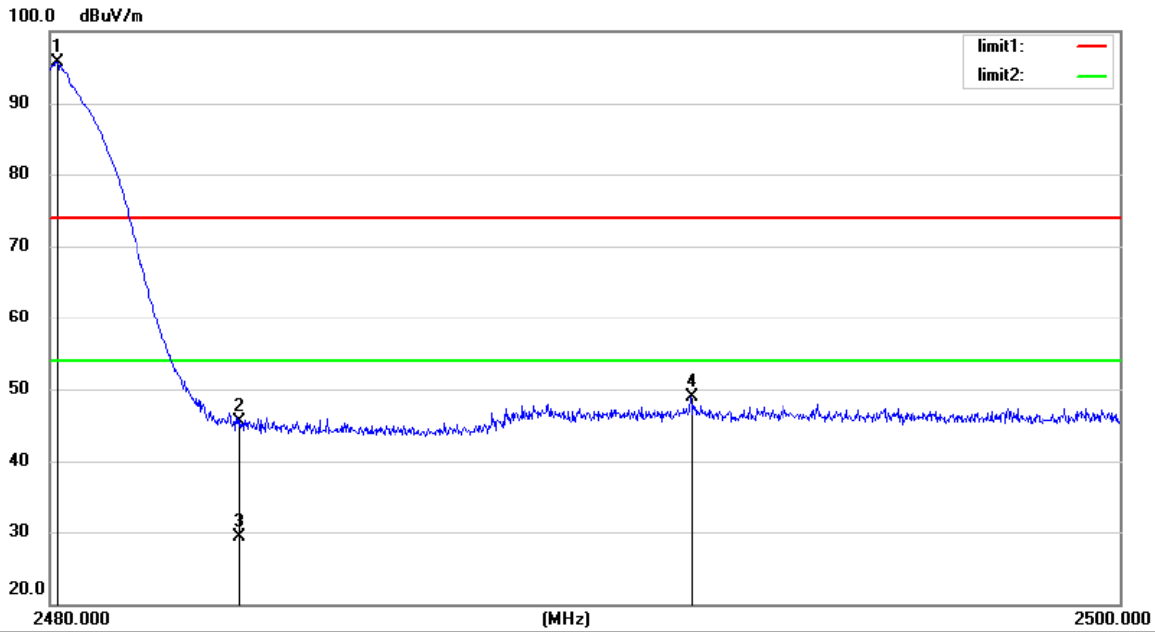

Site Chamber #1 Polarization: **Vertical** Temperature: 25
 Limit: (RE)FCC PART 15 C 3m_PEAK Power: AC 120V/60Hz Humidity: 55 %
 Mode: TX2480

Note:

| No. | Mk. | Freq. MHz | Reading Level dBuV | Correct Factor dB | Measure- ment dBuV/m | Limit dBuV/m | Over dB | Antenna Height cm | Table Degree | Detector | Comment |
|-----|-----|--------------|--------------------------|-------------------------|----------------------------|-----------------|------------|-------------------------|-----------------|----------|---------|
| 1 | * | 2480.120 | 105.77 | -10.02 | 95.75 | 74.00 | 21.75 | | | peak | |
| 2 | | 2483.500 | 55.55 | -10.01 | 45.54 | 74.00 | -28.46 | | | peak | |
| 3 | | 2483.500 | 39.25 | -10.01 | 29.24 | 54.00 | -24.76 | | | AVG | |
| 4 | | 2491.980 | 58.86 | -9.95 | 48.91 | 74.00 | -25.09 | | | peak | |



12 Antenna Application

12.1 Antenna requirement

The EUT'S antenna is met the requirement of FCC part 15C section 15.203 and 15.247.

FCC part 15C section 15.247 requirements:

Systems operating in the 2402-2480MHz band that are used exclusively for fixed, point-to-point operations may employ transmitting antennas with directional gain greater than 6dBi provided the maximum peak output power of the intentional radiator is reduced by 1dB for every 3dB that the directional gain of the antenna exceeds 6dBi.

12.2 Result

The EUT'S antenna is an FPC antenna. The antenna's gain is 0.1dBi and meets the requirement.

13 Photos of EUT

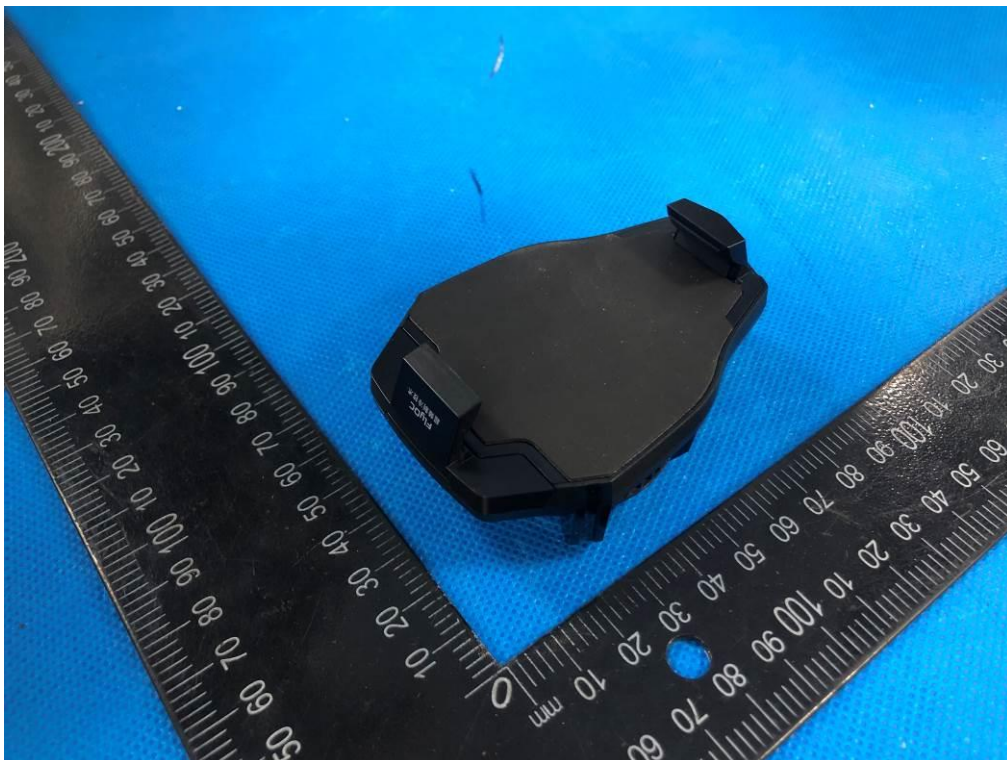

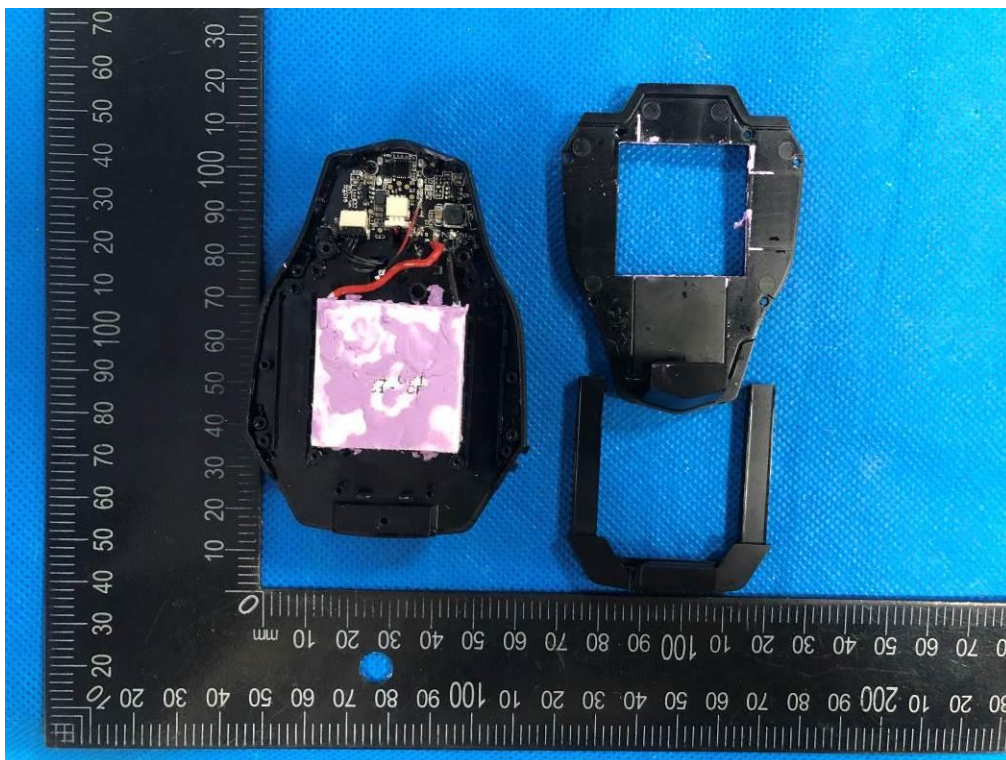

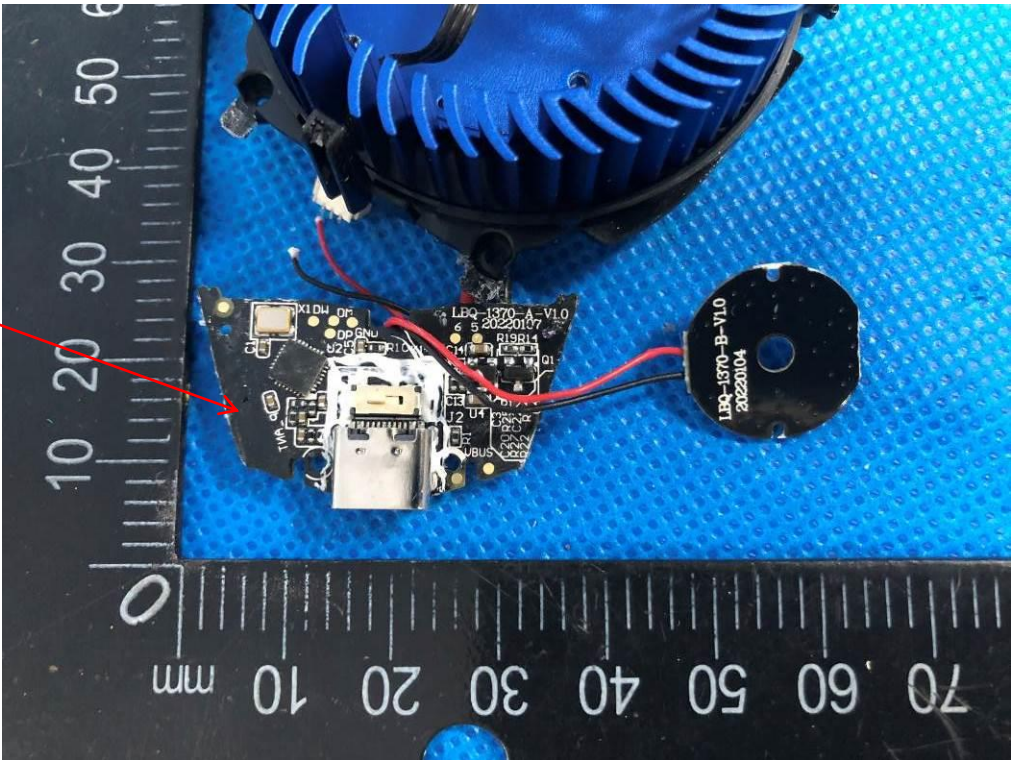

BT ANT

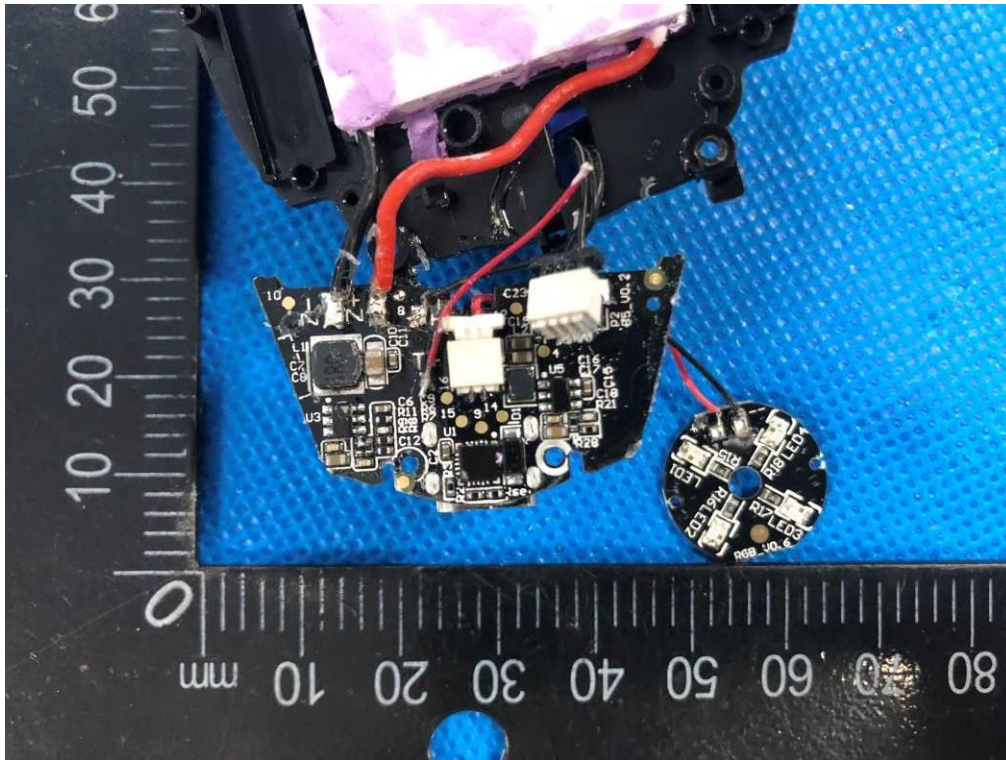

-----The end of report-----