

TEST REPORT

Applicant: Nuvvyo Inc.

Address of Applicant: 555 Legget Drive Tower B Suite 836 Kanata, ON K2K2X3, Canada

Manufacturer: Nuvvyo Inc.

Address of Manufacturer: 555 Legget Drive Tower B Suite 836 Kanata, ON K2K2X3, Canada

Factory: Shenzhen Giec Digital Co., Ltd

Address of Factory: 1st&3rd Building, No.26 Puzai Road, Pingdi, Longgang District, Shenzhen, China

Equipment Under Test (EUT)

Product Name: OTA streamer

Model No.: Tablo, TF1282B-01-CN, TF1282B-AB-01-CN, TFNS2B-01-CN, TFNS2B-AB-01-CN, TF1282B-02-CN, TF1282B-AB-02-CN, TFNS2B-02-CN, TFNS2B-AB-02-CN

FCC ID: 2AOR7-TABLO020

Applicable standards: FCC CFR Title 47 Part 15 Subpart E Section 15.407

Date of sample receipt: December 02, 2022

Date of Test: December 02-16, 2022

Date of report issued: December 16, 2022

Test Result : PASS *

* In the configuration tested, the EUT complied with the standards specified above.

Authorized Signature:



Robinson Luo
Laboratory Manager

This results shown in this test report refer only to the sample(s) tested, this test report cannot be reproduced, except in full, without prior written permission of the company. The report would be invalid without specific stamp of test institute and the signatures of compiler and approver.

2 Version

Version No.	Date	Description
00	December 16, 2022	Original

Prepared By:

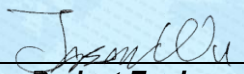
Project Engineer

Date:

December 16, 2022

Check By:

Reviewer

Date:

December 16, 2022

3 Contents

	Page
1 COVER PAGE.....	1
2 VERSION.....	2
3 CONTENTS	3
4 TEST SUMMARY	4
4.1 MEASUREMENT UNCERTAINTY	4
5 GENERAL INFORMATION.....	5
5.1 GENERAL DESCRIPTION OF EUT	5
5.2 TEST MODE	7
5.3 DESCRIPTION OF SUPPORT UNITS	7
5.4 TEST FACILITY.....	7
5.5 TEST LOCATION	7
5.6 ADDITIONAL INSTRUCTIONS.....	7
6 TEST INSTRUMENTS LIST	8
7 TEST RESULTS AND MEASUREMENT DATA.....	10
7.1 ANTENNA REQUIREMENT	10
7.2 CONDUCTED EMISSIONS	11
7.3 MAXIMUM CONDUCTED OUTPUT POWER.....	14
7.4 CHANNEL BANDWIDTH AND 99% OCCUPIED BANDWIDTH	15
7.5 POWER SPECTRAL DENSITY	16
7.6 BAND EDGE.....	17
7.6.1 Radiated Emission Method.....	17
7.7 SPURIOUS EMISSION.....	25
7.7.1 Radiated Emission Method.....	25
7.8 FREQUENCY STABILITY	36
8 TEST SETUP PHOTO.....	37
9 EUT CONSTRUCTIONAL DETAILS	37

4 Test Summary

Test Item	Section	Result
Antenna requirement	FCC part 15.203	Pass
AC Power Line Conducted Emission	FCC part 15.207	Pass
Maximum Conducted Output Power	FCC part 15.407(a)(3)	Pass
Channel Bandwidth and 99% Occupied Bandwidth	FCC part 15.407(e)	Pass
Power Spectral Density	FCC part 15.407(a)(3)	Pass
Band Edge	FCC part 15.407(b)(4)	Pass
Spurious Emission	FCC part 15.205/15.209/15.407(b)(4)	Pass
Frequency Stability	FCC part 15.407(g)	Pass

Remarks:

1. Pass: The EUT complies with the essential requirements in the standard.
2. Test according to ANSI C63.10:2013.

4.1 Measurement Uncertainty

Test Item	Frequency Range	Measurement Uncertainty	Notes
Radiated Emission	9kHz-30MHz	3.1dB	(1)
Radiated Emission	30MHz-200MHz	3.8039dB	(1)
Radiated Emission	200MHz-1GHz	3.9679dB	(1)
Radiated Emission	1GHz-18GHz	4.29dB	(1)
Radiated Emission	18GHz-40GHz	3.30dB	(1)
AC Power Line Conducted Emission	0.15MHz ~ 30MHz	3.44dB	(1)

Note (1): The measurement uncertainty is for coverage factor of k=2 and a level of confidence of 95%.

5 General Information

5.1 General Description of EUT

Product Name:	OTA streamer
Model No.:	Tablo, TF1282B-01-CN, TF1282B-AB-01-CN, TFNS2B-01-CN, TFNS2B-AB-01-CN, TF1282B-02-CN, TF1282B-AB-02-CN, TFNS2B-02-CN, TFNS2B-AB-02-CN
Test Model No.:	Tablo
Remark:All above models are identical in the same PCB layout, interior structure and electrical circuits. The differences are the manufacturer of EMCC (the manufacturers are Samsung and Longsys) and model name for commercial purpose.	
Test sample(s) ID:	GTS202212000003-1
Sample(s) Status:	Engineer sample
S/N:	5087B8502774
Operation Frequency:	802.11a/802.11n(HT20)/802.11ac(HT20): 5745MHz ~ 5825MHz 802.11n(HT40)/ 802.11ac(HT40): 5755MHz ~ 5795MHz 802.11ac(HT80): 5775MHz
Channel numbers:	802.11a/802.11n(HT20)/802.11ac(HT20): 5 802.11n(HT40)/ 802.11ac(HT40): 2 802.11ac(HT80): 1
Channel bandwidth:	802.11a/802.11n(HT20)/802.11ac(HT20): 20MHz 802.11n(HT40)/802.11ac(HT40): 40MHz 802.11ac(HT80): 80MHz
Modulation technology:	Orthogonal Frequency Division Multiplexing (OFDM)
Antenna Type:	Integral Antenna
Antenna gain:	ANT 1: 2.16dBi ANT 2: 2.16dBi
Power supply:	AC ADAPTER MODEL: TEKA-TC120150US INPUT: AC 100-240V, 50/60Hz, 0.5A MAX OUTPUT: DC 12.0V, 1.5A

Operation Frequency each of channel							
Channel	Frequency	Channel	Frequency	Channel	Frequency	Channel	Frequency
149	5745MHz	151	5755MHz	153	5765MHz	155	5775MHz
157	5785MHz	159	5795MHz	161	5805MHz	163	5815MHz
165	5825MHz						

Note:

In section 15.31(m), regards to the operating frequency range over 10 MHz, the Lowest frequency, the middle frequency, and the highest frequency of channel were selected to perform the test, and the selected channel see below:

Test channel	Frequency (MHz)		
	802.11 a/n/ac(HT20)	802.11 n/ac(HT40)	802.11ac(HT80)
Lowest channel	5745	5755	5765
Middle channel	5785	5795	5775
Highest channel	5825	5795	5805

5.2 Test mode

Transmitting mode	Keep the EUT in continuously transmitting mode
-------------------	--

We have verified the construction and function in typical operation. All the test modes were carried out with the EUT in transmitting operation, which was shown in this test report and defined as follows:

Per-scan all kind of data rate in lowest channel, and found the follow list which it was worst case.

Mode	Data rate	Mode	Data rate
802.11a	6Mbps	802.11n/ac(HT40)	13Mbps
802.11n/ac(HT20)	6.5Mbps	802.11ac(HT80)	29.3Mbps

5.3 Description of Support Units

None.

5.4 Test Facility

The test facility is recognized, certified, or accredited by the following organizations:

- **FCC —Registration No.: 381383**

Designation Number: CN5029

Global United Technology Services Co., Ltd., Shenzhen EMC Laboratory has been registered and fully described in a report filed with the (FCC) Federal Communications Commission. The acceptance letter from the FCC is maintained in files.

- **IC —Registration No.: 9079A**

CAB identifier: CN0091

The 3m Semi-anechoic chamber of Global United Technology Services Co., Ltd. has been registered by Certification and Engineering Bureau of Industry Canada for radio equipment testing.

- **NVLAP (LAB CODE:600179-0)**

Global United Technology Services Co., Ltd., is accredited by the National Voluntary Laboratory Accreditation Program (NVLAP).

5.5 Test Location

All tests were performed at:

Global United Technology Services Co., Ltd.

Address: No. 123-128, Tower A, Jinyuan Business Building, No.2, Laodong Industrial Zone, Xixiang Road, Baoan District, Shenzhen, Guangdong, China 518102

Tel: 0755-27798480

Fax: 0755-27798960

5.6 Additional Instructions

Test Software	test command provided by manufacturer
Power level setup	Default

6 Test Instruments list

Radiated Emission:						
Item	Test Equipment	Manufacturer	Model No.	Inventory No.	Cal.Date (mm-dd-yy)	Cal.Due date (mm-dd-yy)
1	3m Semi- Anechoic Chamber	ZhongYu Electron	9.2(L)*6.2(W)* 6.4(H)	GTS250	July 02, 2020	July 01, 2025
2	Control Room	ZhongYu Electron	6.2(L)*2.5(W)* 2.4(H)	GTS251	N/A	N/A
3	EMI Test Receiver	Rohde & Schwarz	ESU26	GTS203	April 22, 2022	April 21, 2023
4	BiConiLog Antenna	SCHWARZBECK MESS-ELEKTRONIK	VULB9168	GTS640	March 21, 2022	March 20, 2023
5	Double -ridged waveguide horn	SCHWARZBECK MESS-ELEKTRONIK	BBHA 9120 D	GTS208	June 12, 2022	June 11, 2023
6	Horn Antenna	ETS-LINDGREN	3160	GTS217	June 23, 2022	June 22, 2023
7	EMI Test Software	AUDIX	E3	N/A	N/A	N/A
8	Coaxial Cable	GTS	N/A	GTS213	April 22, 2022	April 21, 2023
9	Coaxial Cable	GTS	N/A	GTS211	April 22, 2022	April 21, 2023
10	Coaxial cable	GTS	N/A	GTS210	April 22, 2022	April 21, 2023
11	Coaxial Cable	GTS	N/A	GTS212	April 22, 2022	April 21, 2023
12	Amplifier(100kHz-3GHz)	HP	8347A	GTS204	April 22, 2022	April 21, 2023
13	Amplifier (18-26GHz)	Rohde & Schwarz	AFS33-18002 650-30-8P-44	GTS218	June 23, 2022	June 22, 2023
14	Band filter	Amindeon	82346	GTS219	June 23, 2022	June 22, 2023
15	Power Meter	Anritsu	ML2495A	GTS540	June 23, 2022	June 22, 2023
16	Power Sensor	Anritsu	MA2411B	GTS541	June 23, 2022	June 22, 2023
17	Wideband Radio Communication Tester	Rohde & Schwarz	CMW500	GTS575	April 22, 2022	April 21, 2023
18	Splitter	Agilent	11636B	GTS237	June 23, 2022	June 22, 2023
19	Loop Antenna	ZHINAN	ZN30900A	GTS534	Nov. 29, 2022	Nov. 28, 2023
20	Broadband Preamplifier	SCHWARZBECK	BBV9718	GTS535	April 22, 2022	April 21, 2023
21	Breitband hornantenna	SCHWARZBECK	BBHA 9170	GTS579	Oct. 16, 2022	Oct. 15, 2023
22	Amplifier	TDK	PA-02-02	GTS574	Oct. 16, 2022	Oct. 15, 2023
23	Amplifier	TDK	PA-02-03	GTS576	Oct. 16, 2022	Oct. 15, 2023
24	PSA Series Spectrum Analyzer	Rohde & Schwarz	FSP	GTS578	June 23, 2022	June 22, 2023
25	Amplifier(1GHz-26.5GHz)	HP	8449B	GTS601	April 22, 2022	April 21, 2023

Conducted Emission						
Item	Test Equipment	Manufacturer	Model No.	Inventory No.	Cal.Date (mm-dd-yy)	Cal.Due date (mm-dd-yy)
1	Shielding Room	ZhongYu Electron	7.3(L)x3.1(W)x2.9(H)	GTS252	May 14, 2022	May 13, 2025
2	EMI Test Receiver	R&S	ESCI 7	GTS552	April 24, 2022	April 23, 2023
3	Coaxial Switch	ANRITSU CORP	MP59B	GTS225	June 23, 2022	June 22, 2023
4	ENV216 2-L-V-NETZNACHB.DE	ROHDE&SCHWARZ	ENV216	GTS226	April 22, 2022	April 21, 2023
5	Coaxial Cable	GTS	N/A	GTS227	N/A	N/A
6	EMI Test Software	AUDIX	E3	N/A	N/A	N/A
7	Thermo meter	JINCHUANG	GSP-8A	GTS639	April 28, 2022	April 27, 2023
8	Absorbing clamp	Elektronik-Feinmechanik	MDS21	GTS229	April 15, 2022	April 14, 2023
9	ISN	SCHWARZBECK	NTFM 8158	GTS565	April 22, 2022	April 21, 2023
10	High voltage probe	SCHWARZBECK	TK9420	GTS537	April 22, 2022	April 21, 2023

RF Conducted Test:						
Item	Test Equipment	Manufacturer	Model No.	Serial No.	Cal.Date (mm-dd-yy)	Cal.Due date (mm-dd-yy)
1	MXA Signal Analyzer	Agilent	N9020A	GTS566	April 22, 2022	April 21, 2023
2	EMI Test Receiver	R&S	ESCI 7	GTS552	April 22, 2022	April 21, 2023
3	Spectrum Analyzer	Agilent	E4440A	GTS536	April 22, 2022	April 21, 2023
4	MXG vector Signal Generator	Agilent	N5182A	GTS567	April 22, 2022	April 21, 2023
5	ESG Analog Signal Generator	Agilent	E4428C	GTS568	April 22, 2022	April 21, 2023
6	USB RF Power Sensor	DARE	RPR3006W	GTS569	April 22, 2022	April 21, 2023
7	RF Switch Box	Shongyi	RFSW3003328	GTS571	April 22, 2022	April 21, 2023
8	Programmable Constant Temp & Humi Test Chamber	WEWON	WHTH-150L-40-880	GTS572	April 22, 2022	April 21, 2023

General used equipment:						
Item	Test Equipment	Manufacturer	Model No.	Inventory No.	Cal.Date (mm-dd-yy)	Cal.Due date (mm-dd-yy)
1	Humidity/ Temperature Indicator	KTJ	TA328	GTS243	April 25, 2022	April 24, 2023
2	Barometer	KUMAO	SF132	GTS647	July 26, 2022	July 25, 2023

7 Test results and Measurement Data

7.1 Antenna requirement

Standard requirement:	FCC Part15 C Section 15.203
<i>15.203 requirement:</i> An intentional radiator shall be designed to ensure that no antenna other than that furnished by the responsible party shall be used with the device. The use of a permanently attached antenna or of an antenna that uses a unique coupling to the intentional radiator, the manufacturer may design the unit so that a broken antenna can be replaced by the user, but the use of a standard antenna jack or electrical connector is prohibited.	
E.U.T Antenna:	
The antenna is integral antenna, reference to the appendix II for details	

7.2 Conducted Emissions

Test Requirement:	FCC Part15 C Section 15.207					
Test Method:	ANSI C63.10					
Test Frequency Range:	150KHz to 30MHz					
Receiver setup:	RBW=9KHz, VBW=30KHz, Sweep time=auto					
Limit:	Frequency range (MHz)		Limit (dBuV)			
			Quasi-peak		Average	
	0.15-0.5		66 to 56*		56 to 46*	
	0.5-5		56		46	
5-30		60		50		
* Decreases with the logarithm of the frequency.						
Test setup:	<p>Remark: E.U.T: Equipment Under Test LISN: Line Impedance Stabilization Network Test table height=0.8m</p>					
Test procedure:	<ol style="list-style-type: none"> 1. The E.U.T and simulators are connected to the main power through a line impedance stabilization network (L.I.S.N.). This provides a 50ohm/50uH coupling impedance for the measuring equipment. 2. The peripheral devices are also connected to the main power through a LISN that provides a 50ohm/50uH coupling impedance with 50ohm termination. (Please refer to the block diagram of the test setup and photographs). 3. Both sides of A.C. line are checked for maximum conducted interference. In order to find the maximum emission, the relative positions of equipment and all of the interface cables must be changed according to ANSI C63.10 on conducted measurement. 					
Test Instruments:	Refer to section 6.0 for details					
Test mode:	Refer to section 5.2 for details					
Test environment:	Temp.:	25 °C	Humid.:	52%	Press.:	1012mbar
Test voltage:	AC 120V, 60Hz					
Test results:	Pass					

Measurement data

All antennas have test, only the worst case ANT 1 report.

Test mode :wifi mode

Line:

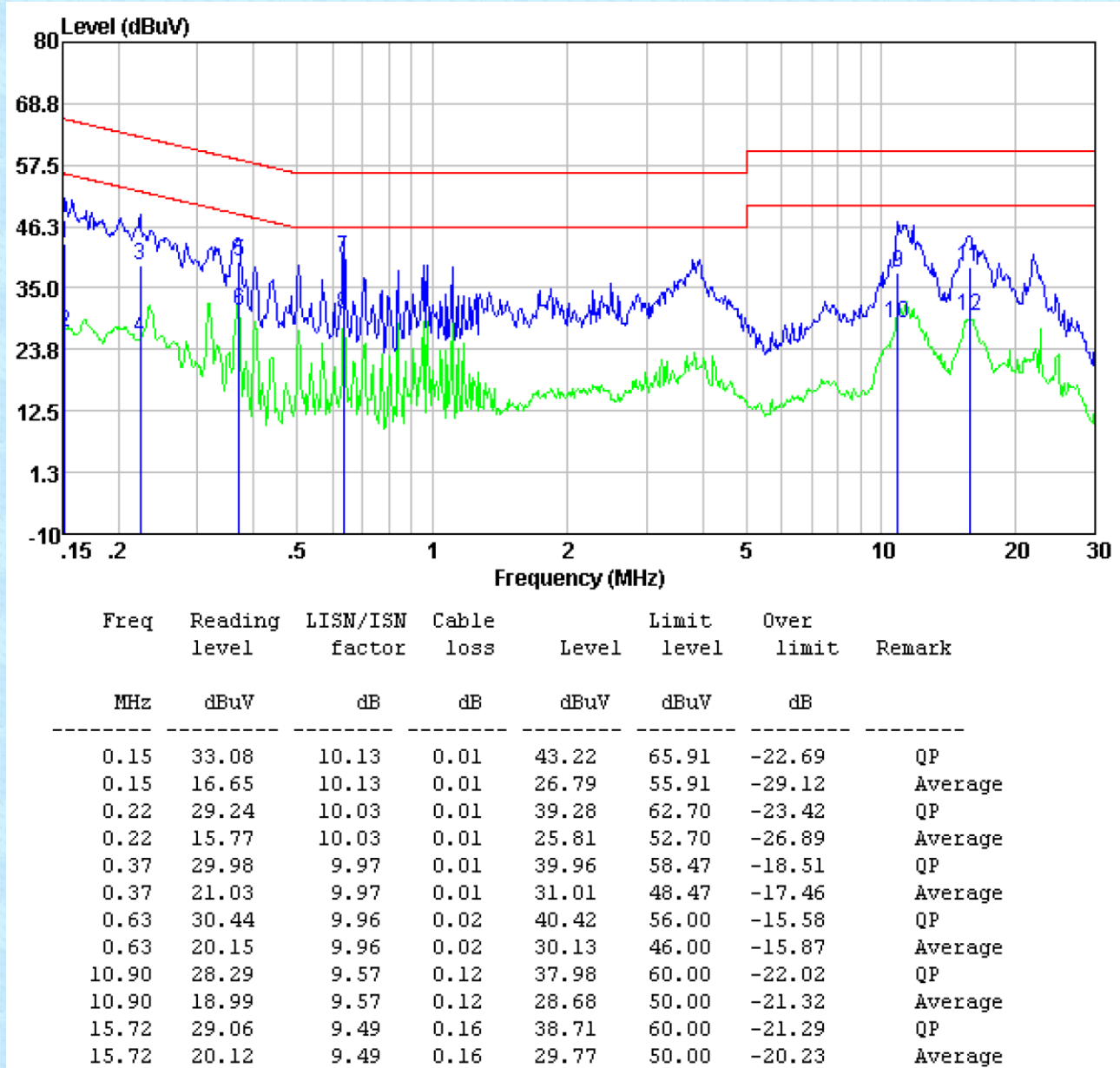

Neutral:

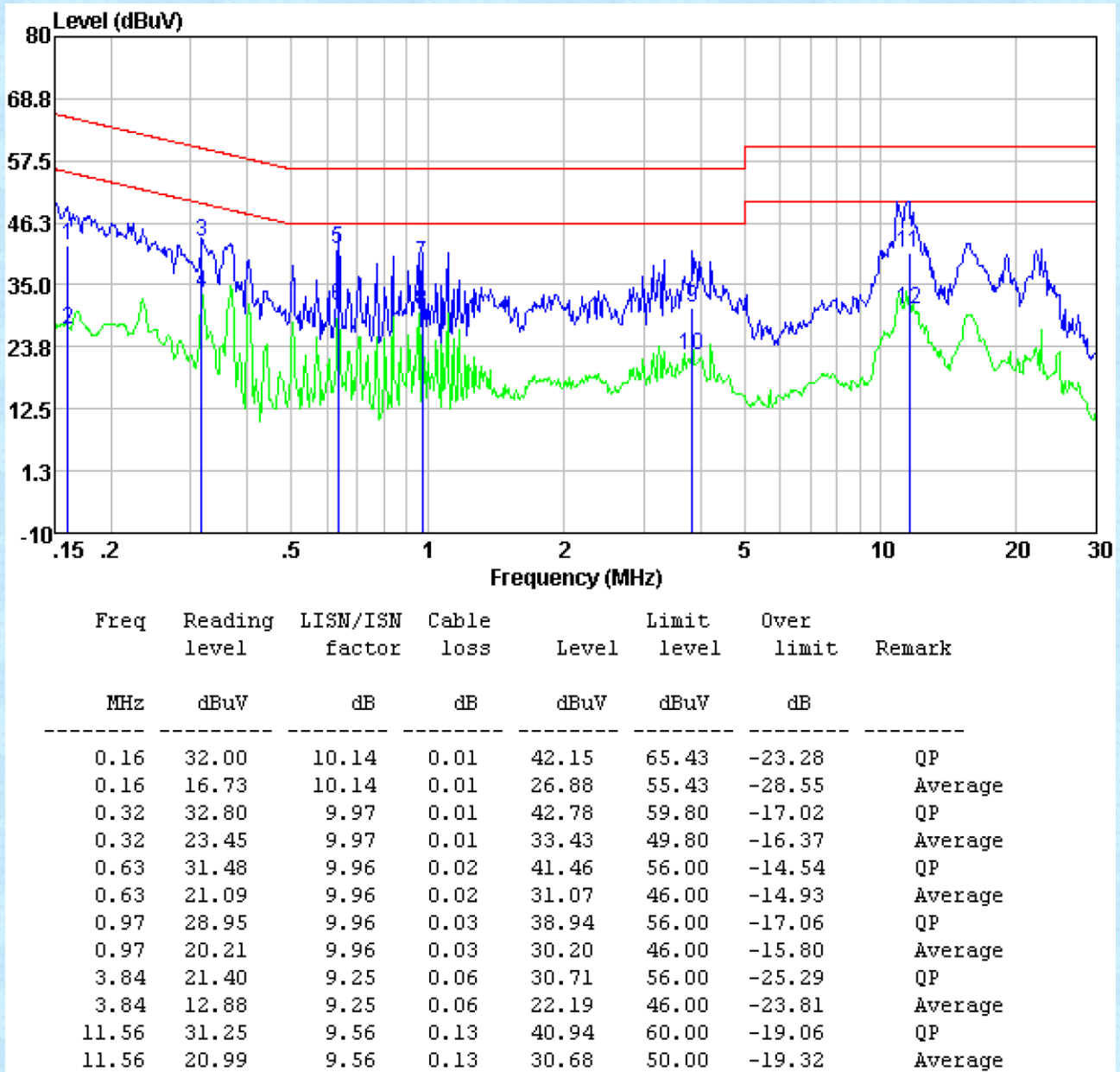

Notes:

1. An initial pre-scan was performed on the line and neutral lines with peak detector.
2. Quasi-Peak and Average measurement were performed at the frequencies with maximized peak emission.
3. Final Level = Receiver Read level + LISN Factor + Cable Loss
4. If the average limit is met when using a quasi-peak detector receiver, the EUT shall be deemed to meet both limits and measurement with the average detector receiver is unnecessary.

7.3 Maximum Conducted Output Power

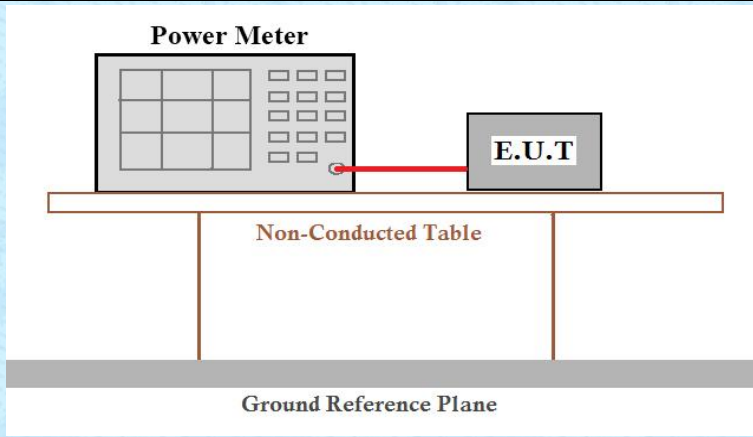
Test Requirement:	FCC Part15 E Section 15.407(a)(3)
Test Method:	ANSI C63.10:2013 and KDB 789033 D02 General U-NII Test Procedures New Rules v02r01
Limit:	30dBm
Duty Cycle set up:	RBW=VBW=8MHz
Test setup:	 <p>The diagram illustrates the test setup. A Power Meter is connected to an E.U.T. (Equipment Under Test) via a red cable. Both are placed on a Non-Conducted Table, which is supported by a Ground Reference Plane.</p>
Test Instruments:	Refer to section 6.0 for details
Test mode:	Refer to section 5.2 for details
Test results:	Pass

Measurement Data: The detailed test data see Appendix.

7.4 Channel Bandwidth and 99% Occupied Bandwidth

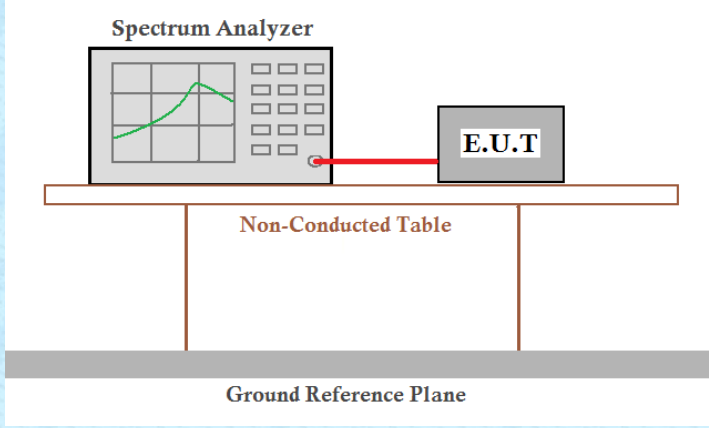
Test Requirement:	FCC Part15 E Section 15.407(e)
Test Method:	ANSI C63.10:2013 and KDB 789033 D02 General U-NII Test Procedures New Rules v02r01
Limit:	>500KHz
Test setup:	 <p>The diagram illustrates the test setup. A Spectrum Analyzer is connected to an E.U.T. (Equipment Under Test) via a red cable. Both are placed on a Non-Conducted Table, which is supported by a Ground Reference Plane.</p>
Test Instruments:	Refer to section 6.0 for details
Test mode:	Refer to section 5.2 for details
Test results:	Pass

Measurement Data: The detailed test data see Appendix.

7.5 Power Spectral Density

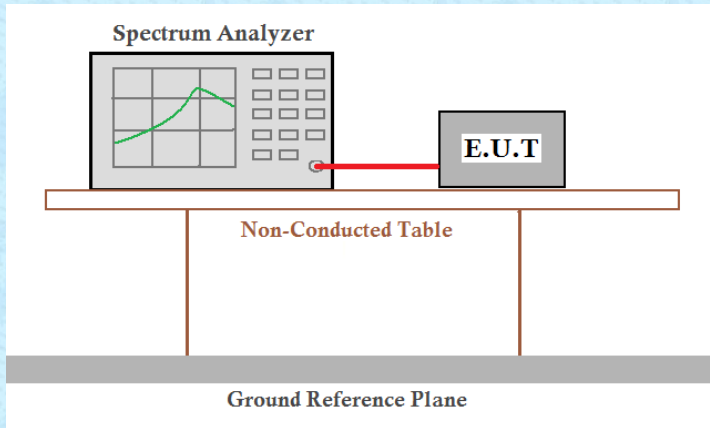
Test Requirement:	FCC Part15 E Section 15.407(a)(3)
Test Method:	ANSI C63.10:2013 and KDB 789033 D02 General U-NII Test Procedures New Rules v02r01
Limit:	30dBm/500kHz
Test setup:	 <p>The diagram illustrates the test setup. A Spectrum Analyzer is connected to an E.U.T. (Equipment Under Test) via a red cable. Both are placed on a Non-Conducted Table, which sits on a Ground Reference Plane.</p>
Test Instruments:	Refer to section 6.0 for details
Test mode:	Refer to section 5.2 for details
Test results:	Pass

Measurement Data: The detailed test data see Appendix.

7.6 Band edge

7.6.1 Radiated Emission Method

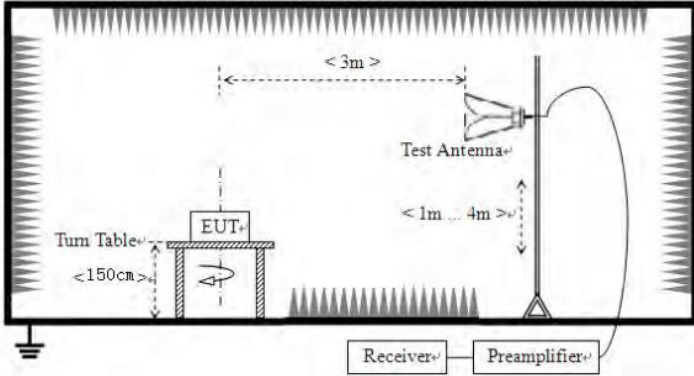
Test Requirement:	FCC Part15 C Section 15.209 and 15.205				
Test Method:	ANSI C63.10: 2013				
Test Frequency Range:	9kHz to 40GHz, only worse case is reported				
Test site:	Measurement Distance: 3m				
Receiver setup:	Frequency	Detector	RBW	VBW	Value
	Above 1GHz	Peak RMS	1MHz 1MHz	3MHz 3MHz	Peak RMS
Limit:	All emissions shall be limited to a level of -27 dBm/MHz at 75 MHz or more above or below the band edge increasing linearly to 10 dBm/MHz at 25 MHz above or below the band edge, and from 25 MHz above or below the band edge increasing linearly to a level of 15.6 dBm/MHz at 5 MHz above or below the band edge, and from 5 MHz above or below the band edge increasing linearly to a level of 27 dBm/MHz at the band edge.				
Test setup:					
Test Procedure:	<ol style="list-style-type: none"> 1. The EUT was placed on the top of a rotating table 1.5 meters above the ground at a 3 meter camber. The table was rotated 360 degrees to determine the position of the highest radiation. 2. The EUT was set 3 meters away from the interference-receiving antenna, which was mounted on the top of a variable-height antenna tower. 3. The antenna height is varied from one meter to four meters above the ground to determine the maximum value of the field strength. Both horizontal and vertical polarizations of the antenna are set to make the measurement. 4. For each suspected emission, the EUT was arranged to its worst case and then the antenna was tuned to heights from 1 meter to 4 meters and the rota table was turned from 0 degrees to 360 degrees to find the maximum reading. 5. The test-receiver system was set to Peak Detect Function and Specified Bandwidth with Maximum Hold Mode. 6. If the emission level of the EUT in peak mode was 10dB lower than the limit specified, then testing could be stopped and the peak values of the EUT would be reported. Otherwise the emissions that did not have 10dB margin would be re-tested one by one using peak, quasi-peak or average method as specified and then reported in a data sheet. 7. The radiation measurements are performed in X, Y, Z axis positioning. And found the X axis positioning which it is worse case, only the test 				

	worst case mode is recorded in the report.
Test Instruments:	Refer to section 6.0 for details
Test mode:	Refer to section 5.2 for details
Test results:	Pass

Remarks:

1. *Final Level = Receiver Read level + Antenna Factor + Cable Loss – Preamplifier Factor*
2. *The emission levels of other frequencies are very lower than the limit and not show in test report.*
3. *The pre-test were performed on lowest, middle and highest frequencies, only the worst case's (lowest and highest frequencies) data was showed.*
4. *According to KDB 789033 D02v02r01 section G) 1) d), for measurements above 1000 MHz @3m distance, the limit of field strength is computed as follows:*

$$E[\text{dBuV/m}] = \text{EIRP}[\text{dBm}] + 95.2;$$

$$E[\text{dBuV/m}] = -27 + 95.2 = 68.2\text{dBuV/m}.$$

$$E[\text{dBuV/m}] = 10 + 95.2 = 105.2\text{dBuV/m}.$$

$$E[\text{dBuV/m}] = 15.6 + 95.2 = 110.8\text{dBuV/m}.$$

$$E[\text{dBuV/m}] = 27 + 95.2 = 122.2\text{dBuV/m}$$

Measurement data:

All antennas have test, only the worst case ANT 1 report.

IEEE 802.11a								
Peak value:								
Frequency (MHz)	Read Level (dBuV)	Antenna Factor (dB/m)	Cable Loss (dB)	Preamp Factor (dB)	Level (dBuV/m)	Limit Line (dBuV/m)	Over Limit (dB)	Polarization
5650	34.68	32.36	9.72	23.83	52.93	68.20	-15.27	Horizontal
5700	32.57	32.5	9.79	23.84	51.02	105.20	-54.18	Horizontal
5720	28.72	32.53	9.81	23.85	47.21	110.80	-63.59	Horizontal
5725	32.28	32.53	9.83	23.86	50.78	122.20	-71.42	Horizontal
5850	33.69	32.7	9.99	23.87	52.51	122.20	-69.69	Horizontal
5855	30.05	32.72	9.99	23.88	48.88	110.80	-61.92	Horizontal
5875	32.76	32.74	10.04	23.89	51.65	105.20	-53.55	Horizontal
5925	30.43	32.8	10.11	23.9	49.44	68.20	-18.76	Horizontal
5650	30.92	32.36	9.72	23.83	49.17	68.20	-19.03	Vertical
5700	27.59	32.5	9.79	23.84	46.04	105.20	-59.16	Vertical
5720	31.09	32.53	9.81	23.85	49.58	110.80	-61.22	Vertical
5725	32.10	32.53	9.83	23.86	50.60	122.20	-71.60	Vertical
5850	28.60	32.7	9.99	23.87	47.42	122.20	-74.78	Vertical
5855	33.45	32.72	9.99	23.88	52.28	110.80	-58.52	Vertical
5875	29.52	32.74	10.04	23.89	48.41	105.20	-56.79	Vertical
5925	31.09	32.8	10.11	23.9	50.10	68.20	-18.10	Vertical

IEEE 802.11n HT20								
Peak value:								
Frequency (MHz)	Read Level (dBuV)	Antenna Factor (dB/m)	Cable Loss (dB)	Preamp Factor (dB)	Level (dBuV/m)	Limit Line (dBuV/m)	Over Limit (dB)	Polarization
5650	28.78	32.36	9.72	23.83	47.03	68.20	-21.17	Horizontal
5700	27.73	32.5	9.79	23.84	46.18	105.20	-59.02	Horizontal
5720	29.11	32.53	9.81	23.85	47.60	110.80	-63.20	Horizontal
5725	29.86	32.53	9.83	23.86	48.36	122.20	-73.84	Horizontal
5850	34.18	32.7	9.99	23.87	53.00	122.20	-69.20	Horizontal
5855	30.32	32.72	9.99	23.88	49.15	110.80	-61.65	Horizontal
5875	33.64	32.74	10.04	23.89	52.53	105.20	-52.67	Horizontal
5925	33.47	32.8	10.11	23.9	52.48	68.20	-15.72	Horizontal
5650	33.27	32.36	9.72	23.83	51.52	68.20	-16.68	Vertical
5700	32.58	32.5	9.79	23.84	51.03	105.20	-54.17	Vertical
5720	32.97	32.53	9.81	23.85	51.46	110.80	-59.34	Vertical
5725	30.71	32.53	9.83	23.86	49.21	122.20	-72.99	Vertical
5850	32.46	32.7	9.99	23.87	51.28	122.20	-70.92	Vertical
5855	33.65	32.72	9.99	23.88	52.48	110.80	-58.32	Vertical
5875	28.46	32.74	10.04	23.89	47.35	105.20	-57.85	Vertical
5925	34.58	32.8	10.11	23.9	53.59	68.20	-14.61	Vertical

IEEE 802.11ac HT20								
Peak value:								
Frequency (MHz)	Read Level (dBuV)	Antenna Factor (dB/m)	Cable Loss (dB)	Preamp Factor (dB)	Level (dBuV/m)	Limit Line (dBuV/m)	Over Limit (dB)	Polarization
5650	31.65	32.36	9.72	23.83	49.90	68.20	-18.30	Horizontal
5700	31.54	32.5	9.79	23.84	49.99	105.20	-55.21	Horizontal
5720	33.00	32.53	9.81	23.85	51.49	110.80	-59.31	Horizontal
5725	32.92	32.53	9.83	23.86	51.42	122.20	-70.78	Horizontal
5850	31.85	32.7	9.99	23.87	50.67	122.20	-71.53	Horizontal
5855	32.69	32.72	9.99	23.88	51.52	110.80	-59.28	Horizontal
5875	32.92	32.74	10.04	23.89	51.81	105.20	-53.39	Horizontal
5925	31.96	32.8	10.11	23.9	50.97	68.20	-17.23	Horizontal
5650	29.86	32.36	9.72	23.83	48.11	68.20	-20.09	Vertical
5700	28.16	32.5	9.79	23.84	46.61	105.20	-58.59	Vertical
5720	29.26	32.53	9.81	23.85	47.75	110.80	-63.05	Vertical
5725	32.58	32.53	9.83	23.86	51.08	122.20	-71.12	Vertical
5850	28.35	32.7	9.99	23.87	47.17	122.20	-75.03	Vertical
5855	28.51	32.72	9.99	23.88	47.34	110.80	-63.46	Vertical
5875	32.01	32.74	10.04	23.89	50.90	105.20	-54.30	Vertical
5925	31.77	32.8	10.11	23.9	50.78	68.20	-17.42	Vertical

IEEE 802.11n HT40								
Peak value:								
Frequency (MHz)	Read Level (dBuV)	Antenna Factor (dB/m)	Cable Loss (dB)	Preamp Factor (dB)	Level (dBuV/m)	Limit Line (dBuV/m)	Over Limit (dB)	Polarization
5650	31.56	32.36	9.72	23.83	49.81	68.20	-18.39	Horizontal
5700	30.75	32.5	9.79	23.84	49.20	105.20	-56.00	Horizontal
5720	31.09	32.53	9.81	23.85	49.58	110.80	-61.22	Horizontal
5725	31.98	32.53	9.83	23.86	50.48	122.20	-71.72	Horizontal
5850	28.48	32.7	9.99	23.87	47.30	122.20	-74.90	Horizontal
5855	33.34	32.72	9.99	23.88	52.17	110.80	-58.63	Horizontal
5875	29.86	32.74	10.04	23.89	48.75	105.20	-56.45	Horizontal
5925	31.13	32.8	10.11	23.9	50.14	68.20	-18.06	Horizontal
5650	33.66	32.36	9.72	23.83	51.91	68.20	-16.29	Vertical
5700	30.10	32.5	9.79	23.84	48.55	105.20	-56.65	Vertical
5720	29.79	32.53	9.81	23.85	48.28	110.80	-62.52	Vertical
5725	30.91	32.53	9.83	23.86	49.41	122.20	-72.79	Vertical
5850	34.30	32.7	9.99	23.87	53.12	122.20	-69.08	Vertical
5855	29.80	32.72	9.99	23.88	48.63	110.80	-62.17	Vertical
5875	29.98	32.74	10.04	23.89	48.87	105.20	-56.33	Vertical
5925	33.68	32.8	10.11	23.9	52.69	68.20	-15.51	Vertical

IEEE 802.11ac HT40								
Peak value:								
Frequency (MHz)	Read Level (dBuV)	Antenna Factor (dB/m)	Cable Loss (dB)	Preamp Factor (dB)	Level (dBuV/m)	Limit Line (dBuV/m)	Over Limit (dB)	Polarization
5650	32.73	32.36	9.72	23.83	50.98	68.20	-17.22	Horizontal
5700	33.52	32.5	9.79	23.84	51.97	105.20	-53.23	Horizontal
5720	31.72	32.53	9.81	23.85	50.21	110.80	-60.59	Horizontal
5725	30.06	32.53	9.83	23.86	48.56	122.20	-73.64	Horizontal
5850	34.09	32.7	9.99	23.87	52.91	122.20	-69.29	Horizontal
5855	31.35	32.72	9.99	23.88	50.18	110.80	-60.62	Horizontal
5875	27.91	32.74	10.04	23.89	46.80	105.20	-58.40	Horizontal
5925	28.48	32.8	10.11	23.9	47.49	68.20	-20.71	Horizontal
5650	27.88	32.36	9.72	23.83	46.13	68.20	-22.07	Vertical
5700	33.08	32.5	9.79	23.84	51.53	105.20	-53.67	Vertical
5720	30.01	32.53	9.81	23.85	48.50	110.80	-62.30	Vertical
5725	34.13	32.53	9.83	23.86	52.63	122.20	-69.57	Vertical
5850	30.43	32.7	9.99	23.87	49.25	122.20	-72.95	Vertical
5855	32.21	32.72	9.99	23.88	51.04	110.80	-59.76	Vertical
5875	32.98	32.74	10.04	23.89	51.87	105.20	-53.33	Vertical
5925	29.76	32.8	10.11	23.9	48.77	68.20	-19.43	Vertical

IEEE 802.11ac HT80								
Peak value:								
Frequency (MHz)	Read Level (dBuV)	Antenna Factor (dB/m)	Cable Loss (dB)	Preamp Factor (dB)	Level (dBuV/m)	Limit Line (dBuV/m)	Over Limit (dB)	Polarization
5650	33.81	32.36	9.72	23.83	52.06	68.20	-16.14	Horizontal
5700	27.72	32.5	9.79	23.84	46.17	105.20	-59.03	Horizontal
5720	34.47	32.53	9.81	23.85	52.96	110.80	-57.84	Horizontal
5725	27.47	32.53	9.83	23.86	45.97	122.20	-76.23	Horizontal
5850	32.68	32.7	9.99	23.87	51.50	122.20	-70.70	Horizontal
5855	27.54	32.72	9.99	23.88	46.37	110.80	-64.43	Horizontal
5875	27.80	32.74	10.04	23.89	46.69	105.20	-58.51	Horizontal
5925	32.23	32.8	10.11	23.9	51.24	68.20	-16.96	Horizontal
5650	28.06	32.36	9.72	23.83	46.31	68.20	-21.89	Vertical
5700	32.88	32.5	9.79	23.84	51.33	105.20	-53.87	Vertical
5720	33.62	32.53	9.81	23.85	52.11	110.80	-58.69	Vertical
5725	32.06	32.53	9.83	23.86	50.56	122.20	-71.64	Vertical
5850	30.79	32.7	9.99	23.87	49.61	122.20	-72.59	Vertical
5855	29.81	32.72	9.99	23.88	48.64	110.80	-62.16	Vertical
5875	28.38	32.74	10.04	23.89	47.27	105.20	-57.93	Vertical
5925	30.42	32.8	10.11	23.9	49.43	68.20	-18.77	Vertical

7.7 Spurious Emission

7.7.1 Radiated Emission Method

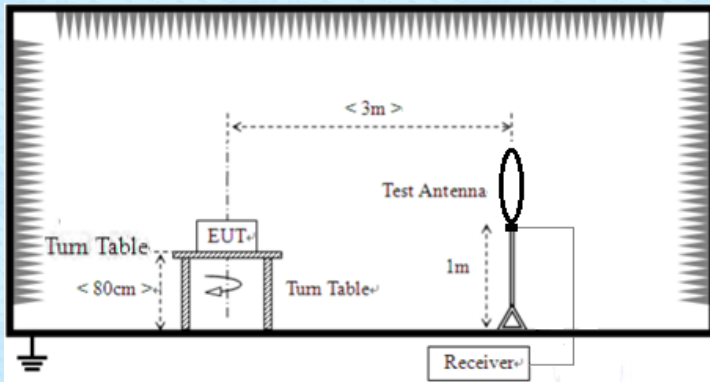
Test Requirement:	FCC Part15 C Section 15.209, Part 15E Section 15.407(b)(4)																												
Test Method:	ANSI C63.10:2013																												
Test Frequency Range:	9kHz to 40GHz																												
Test site:	Measurement Distance: 3m																												
Receiver setup:	Frequency	Detector	RBW	VBW	Value																								
	9kHz-150kHz	Quasi-peak	200Hz	1kHz	Quasi-peak Value																								
	150kHz-30MHz	Quasi-peak	9kHz	30kHz	Quasi-peak Value																								
	30MHz-1GHz	Quasi-peak	120kHz	300kHz	Quasi-peak Value																								
	Above 1GHz	Peak	1MHz	3MHz	Peak Value																								
AV		1MHz	3MHz	Average Value																									
Limit:	<table border="1"> <thead> <tr> <th>Frequency (MHz)</th> <th>Field strength (microvolts/meter)</th> <th>Measurement distance (meters)</th> </tr> </thead> <tbody> <tr> <td>0.009-0.490</td> <td>2400/F(kHz)</td> <td>300</td> </tr> <tr> <td>0.490-1.705</td> <td>24000/F(kHz)</td> <td>30</td> </tr> <tr> <td>1.705-30.0</td> <td>30</td> <td>30</td> </tr> <tr> <td>30-88</td> <td>100**</td> <td>3</td> </tr> <tr> <td>88-216</td> <td>150**</td> <td>3</td> </tr> <tr> <td>216-960</td> <td>200**</td> <td>3</td> </tr> <tr> <td>Above 960</td> <td>500</td> <td>3</td> </tr> </tbody> </table>		Frequency (MHz)	Field strength (microvolts/meter)	Measurement distance (meters)	0.009-0.490	2400/F(kHz)	300	0.490-1.705	24000/F(kHz)	30	1.705-30.0	30	30	30-88	100**	3	88-216	150**	3	216-960	200**	3	Above 960	500	3	<p>The emission limits shown in the above table are based on measurements employing a CISPR quasi-peak detector except for the frequency bands 9-90 kHz, 110-490 kHz and above 1000 MHz. Radiated emission limits in these three bands are based on measurements employing an average detector.</p>		
	Frequency (MHz)	Field strength (microvolts/meter)	Measurement distance (meters)																										
0.009-0.490	2400/F(kHz)	300																											
0.490-1.705	24000/F(kHz)	30																											
1.705-30.0	30	30																											
30-88	100**	3																											
88-216	150**	3																											
216-960	200**	3																											
Above 960	500	3																											
Test setup:	<p>For radiated emissions from 9kHz to 30MHz</p>  <p>For radiated emissions from 30MHz to 1GHz</p>																												

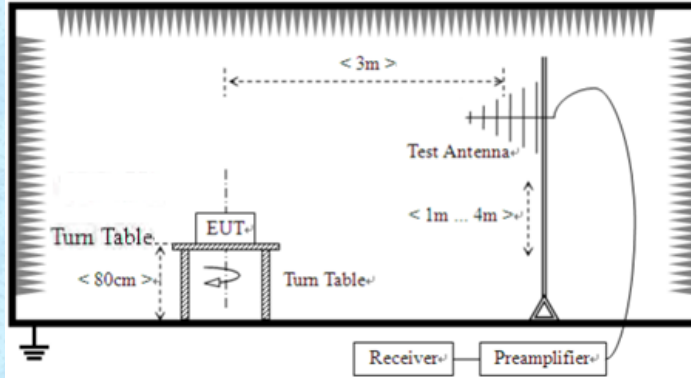

For radiated emissions above 1GHz

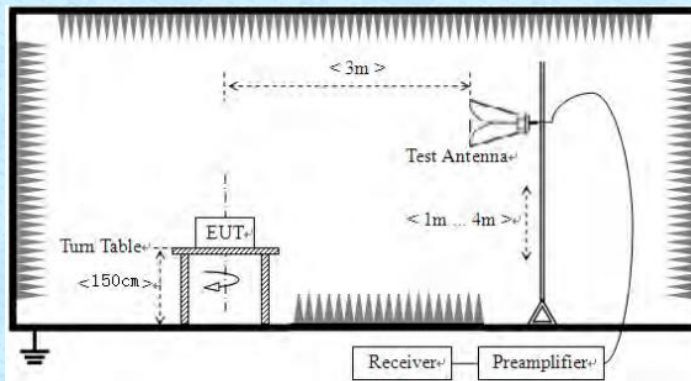

Test Procedure:

1. The EUT was placed on the top of a rotating table (0.8m for below 1GHz and 1.5 meters for above 1GHz) above the ground at a 3 meter camber. The table was rotated 360 degrees to determine the position of the highest radiation.
2. The EUT was set 3 meters away from the interference-receiving antenna, which was mounted on the top of a variable-height antenna tower.
3. The antenna height is varied from one meter to four meters above the ground to determine the maximum value of the field strength. Both horizontal and vertical polarizations of the antenna are set to make the measurement.
4. For each suspected emission, the EUT was arranged to its worst case and then the antenna was tuned to heights from 1 meter to 4 meters and the rota table was turned from 0 degrees to 360 degrees to find the maximum reading.
5. The test-receiver system was set to Peak Detect Function and Specified Bandwidth with Maximum Hold Mode.
6. If the emission level of the EUT in peak mode was 10dB lower than the limit specified, then testing could be stopped and the peak values of the EUT would be reported. Otherwise the emissions that did not have 10dB margin would be re-tested one by one using peak, quasi-peak or average method as specified and then reported in a data sheet.
7. The radiation measurements are performed in X, Y, Z axis positioning. And found the X axis positioning which it is worse case, only the test worst case mode is recorded in the report.

Test Instruments:	Refer to section 6.0 for details					
Test mode:	Refer to section 5.2 for details					
Test environment:	Temp.:	25 °C	Humid.:	52%	Press.:	1012mbar
Test voltage:	AC 120V, 60Hz					
Test results:	Pass					

Remarks:

1. *Pre-scan all kind of the place mode (X-axis, Y-axis, Z-axis), and found the Y-axis which it is worse case.*

Measurement Data:

9 kHz ~ 30 MHz

The low frequency, which started from 9 kHz to 30 MHz, was pre-scanned and the result which was 20 dB lower than the limit line per 15.31(o) was not reported.

Below 1GHz

Pre-scan all test modes, found worst case at 802.11a 5745MHz(ANT 1), and so only show the test result of it.

EMMC of Samsung:

Horizontal:

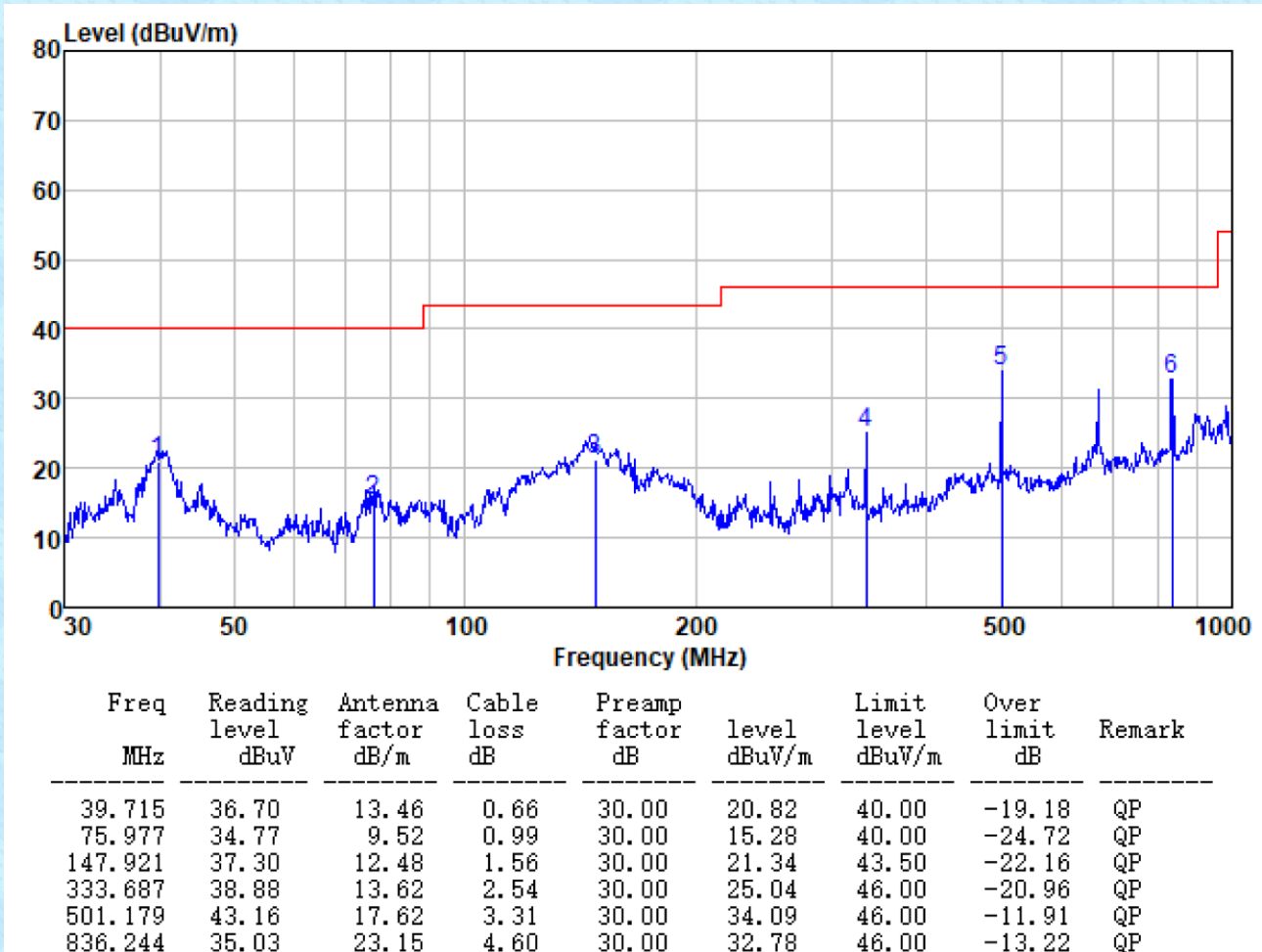

Vertical:

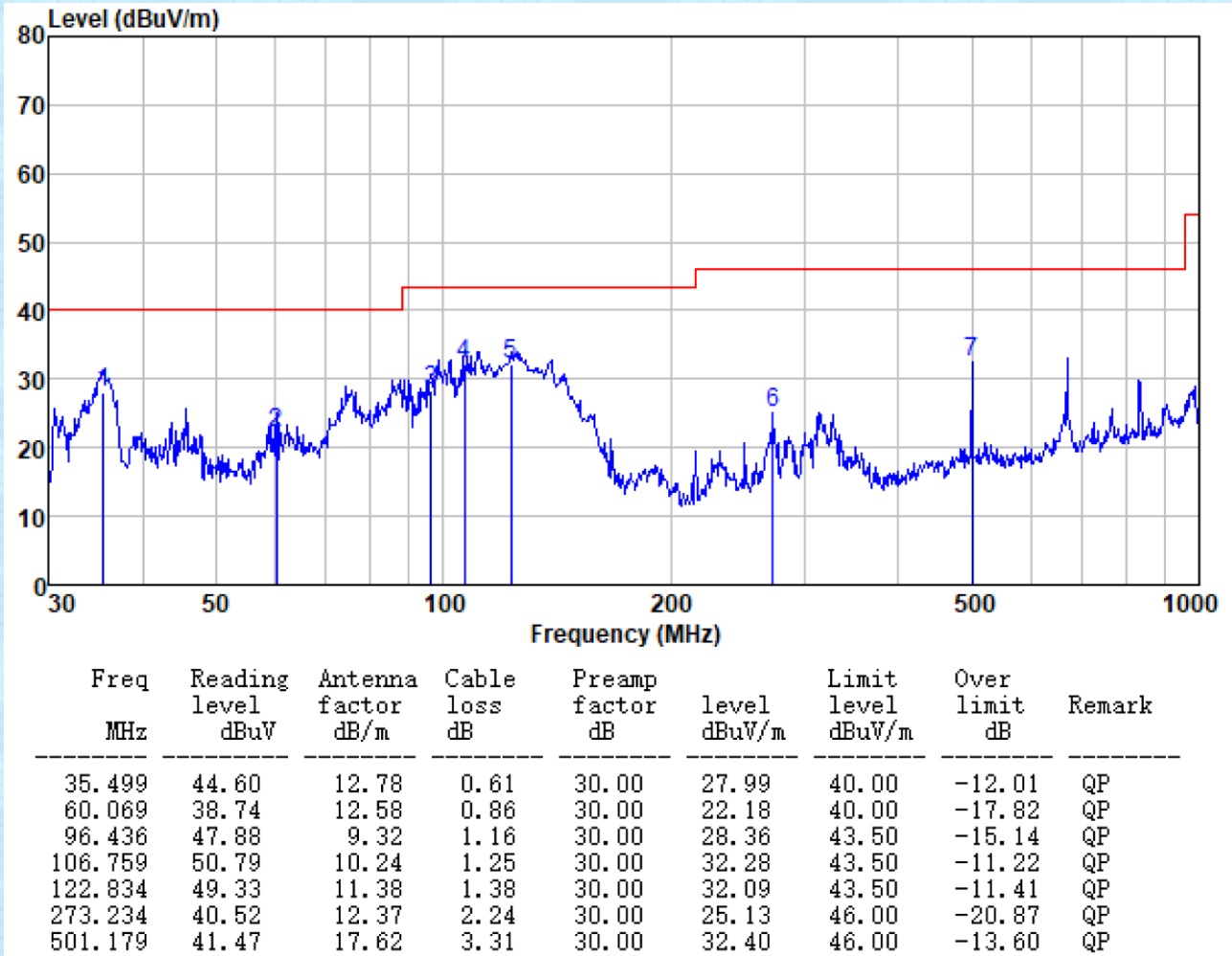

EMMC of Longsys:

Horizontal:

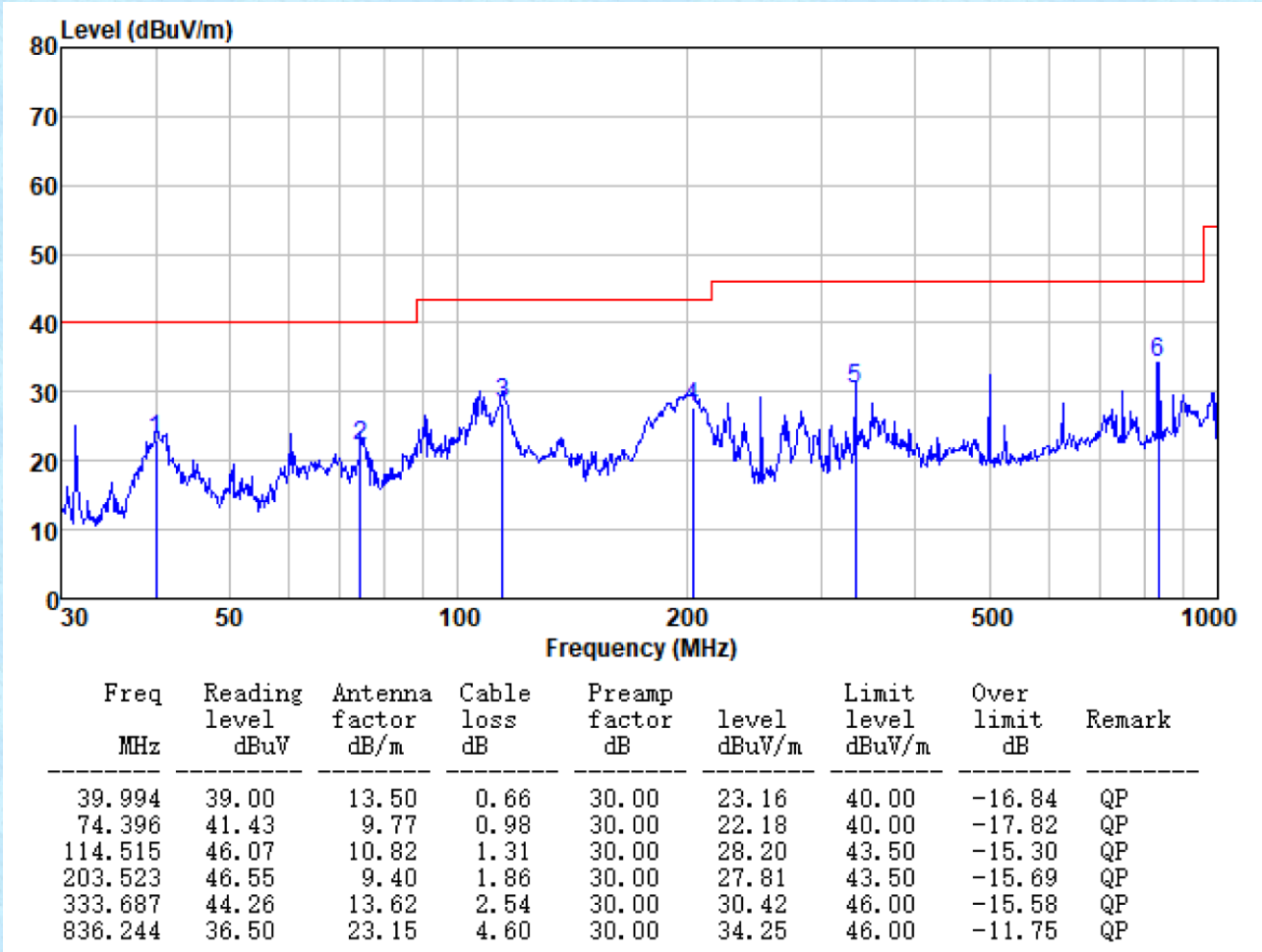

Vertical:

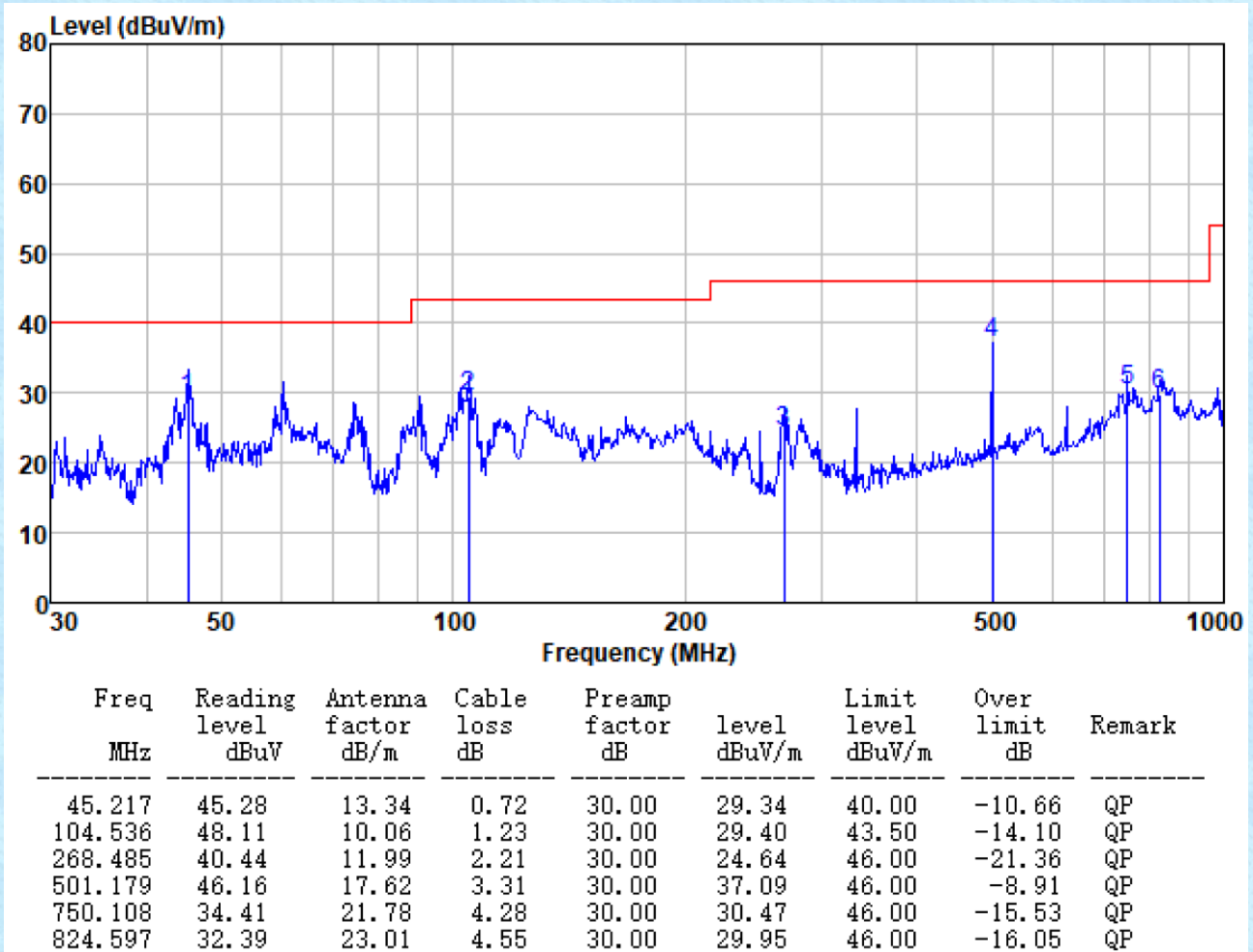

Above 1GHz:

802.11a					Test Frequency: 5745MHz			
Frequency (MHz)	Read Level (dBuV)	Antenna Factor (dB/m)	Cable Loss (dB)	Preamp Factor (dB)	Level (dBuV/m)	Limit Line (dBuV/m)	Over Limit (dB)	Polarization
11490	28.70	39.40	8.73	36.30	40.53	68.20	-27.67	Horizontal
17235	29.22	41.00	11.37	36.28	45.31	68.20	-22.89	Horizontal
11490	30.10	39.40	8.73	36.30	41.93	68.20	-26.27	Vertical
17235	28.96	41.00	11.37	36.28	45.05	68.20	-23.15	Vertical

802.11a					Test Frequency: 5785MHz			
Frequency (MHz)	Read Level (dBuV)	Antenna Factor (dB/m)	Cable Loss (dB)	Preamp Factor (dB)	Level (dBuV/m)	Limit Line (dBuV/m)	Over Limit (dB)	Polarization
11570	27.64	39.28	8.77	36.29	39.40	68.20	-28.80	Horizontal
17355	31.24	41.52	11.48	36.26	47.98	68.20	-20.22	Horizontal
11570	32.03	39.28	8.77	36.29	43.79	68.20	-24.41	Vertical
17355	26.33	41.52	11.48	36.26	43.07	68.20	-25.13	Vertical

802.11a					Test Frequency: 5825MHz			
Frequency (MHz)	Read Level (dBuV)	Antenna Factor (dB/m)	Cable Loss (dB)	Preamp Factor (dB)	Level (dBuV/m)	Limit Line (dBuV/m)	Over Limit (dB)	Polarization
11650	31.27	39.16	8.79	36.27	42.67	68.20	-25.53	Horizontal
17475	27.09	42.30	11.58	36.25	44.20	68.20	-24	Horizontal
11650	30.13	39.16	8.79	36.27	41.46	68.20	-26.74	Vertical
17475	26.67	42.30	11.58	36.25	44.04	68.20	-24.16	Vertical

802.11n(HT20)					Test Frequency: 5745MHz			
Frequency (MHz)	Read Level (dBuV)	Antenna Factor (dB/m)	Cable Loss (dB)	Preamp Factor (dB)	Level (dBuV/m)	Limit Line (dBuV/m)	Over Limit (dB)	Polarization
11490	33.03	39.40	8.73	36.30	44.32	68.20	-23.88	Horizontal
17235	30.07	41.00	11.37	36.28	45.82	68.20	-22.38	Horizontal
11490	27.62	39.40	8.73	36.30	39.21	68.20	-28.99	Vertical
17235	31.35	41.00	11.37	36.28	46.99	68.20	-21.21	Vertical

802.11n(HT20)					Test Frequency: 5785MHz			
Frequency (MHz)	Read Level (dBuV)	Antenna Factor (dB/m)	Cable Loss (dB)	Preamp Factor (dB)	Level (dBuV/m)	Limit Line (dBuV/m)	Over Limit (dB)	Polarization
11570	32.87	39.28	8.77	36.29	45.33	68.20	-22.87	Horizontal
17355	30.26	41.52	11.48	36.26	46.78	68.20	-21.42	Horizontal
11570	32.87	39.28	8.77	36.29	45.13	68.20	-23.07	Vertical
17355	26.33	41.52	11.48	36.26	42.74	68.20	-25.46	Vertical

802.11n(HT20)					Test Frequency: 5825MHz			
Frequency (MHz)	Read Level (dBuV)	Antenna Factor (dB/m)	Cable Loss (dB)	Preamp Factor (dB)	Level (dBuV/m)	Limit Line (dBuV/m)	Over Limit (dB)	Polarization
11650	33.11	39.16	8.79	36.27	44.56	68.20	-23.64	Horizontal
17475	30.74	42.30	11.58	36.25	47.94	68.20	-20.26	Horizontal
11650	30.60	39.16	8.79	36.27	41.99	68.20	-26.21	Vertical
17475	30.09	42.30	11.58	36.25	47.50	68.20	-20.7	Vertical

802.11n(HT40)					Test Frequency: 5755MHz			
Frequency (MHz)	Read Level (dBuV)	Antenna Factor (dB/m)	Cable Loss (dB)	Preamp Factor (dB)	Level (dBuV/m)	Limit Line (dBuV/m)	Over Limit (dB)	Polarization
11510	29.02	39.40	8.74	36.30	39.93	68.20	-28.27	Horizontal
17265	28.33	41.26	11.40	36.27	44.13	68.20	-24.07	Horizontal
11510	31.45	39.40	8.74	36.30	42.87	68.20	-25.33	Vertical
17265	26.37	41.26	11.40	36.27	41.98	68.20	-26.22	Vertical

802.11n(HT40)					Test Frequency: 5795MHz			
Frequency (MHz)	Read Level (dBuV)	Antenna Factor (dB/m)	Cable Loss (dB)	Preamp Factor (dB)	Level (dBuV/m)	Limit Line (dBuV/m)	Over Limit (dB)	Polarization
11590	31.39	39.22	8.77	36.28	42.59	68.20	-25.61	Horizontal
17385	28.08	41.78	11.51	36.26	44.72	68.20	-23.48	Horizontal
11590	31.13	39.22	8.77	36.28	41.98	68.20	-26.22	Vertical
17385	29.70	41.78	11.51	36.26	46.16	68.20	-22.04	Vertical

802.11ac(HT20)					Test Frequency: 5745MHz			
Frequency (MHz)	Read Level (dBuV)	Antenna Factor (dB/m)	Cable Loss (dB)	Preamp Factor (dB)	Level (dBuV/m)	Limit Line (dBuV/m)	Over Limit (dB)	Polarization
11490	30.92	39.40	8.73	36.30	42.35	68.20	-25.85	Horizontal
17235	28.32	41.00	11.37	36.28	43.67	68.20	-24.53	Horizontal
11490	30.32	39.40	8.73	36.30	41.65	68.20	-26.55	Vertical
17235	30.98	41.00	11.37	36.28	46.70	68.20	-21.5	Vertical

802.11ac(HT20)					Test Frequency: 5785MHz			
Frequency (MHz)	Read Level (dBuV)	Antenna Factor (dB/m)	Cable Loss (dB)	Preamp Factor (dB)	Level (dBuV/m)	Limit Line (dBuV/m)	Over Limit (dB)	Polarization
11570	30.51	39.28	8.77	36.29	41.90	68.20	-26.3	Horizontal
17355	27.81	41.52	11.48	36.26	44.45	68.20	-23.75	Horizontal
11570	27.66	39.28	8.77	36.29	39.36	68.20	-28.84	Vertical
17355	31.15	41.52	11.48	36.26	47.52	68.20	-20.68	Vertical

802.11ac(HT20)					Test Frequency: 5825MHz			
Frequency (MHz)	Read Level (dBuV)	Antenna Factor (dB/m)	Cable Loss (dB)	Preamp Factor (dB)	Level (dBuV/m)	Limit Line (dBuV/m)	Over Limit (dB)	Polarization
11650	31.15	39.16	8.79	36.27	42.74	68.20	-25.46	Horizontal
17475	29.00	42.30	11.58	36.25	46.57	68.20	-21.63	Horizontal
11650	27.77	39.16	8.79	36.27	39.41	68.20	-28.79	Vertical
17475	25.93	42.30	11.58	36.25	43.48	68.20	-24.72	Vertical

802.11ac(HT40)					Test Frequency: 5755MHz			
Frequency (MHz)	Read Level (dBuV)	Antenna Factor (dB/m)	Cable Loss (dB)	Preamp Factor (dB)	Level (dBuV/m)	Limit Line (dBuV/m)	Over Limit (dB)	Polarization
11510	28.14	39.40	8.74	36.30	39.05	68.20	-29.15	Horizontal
17265	30.46	41.26	11.40	36.27	46.26	68.20	-21.94	Horizontal
11510	33.44	39.40	8.74	36.30	44.86	68.20	-23.34	Vertical
17265	31.32	41.26	11.40	36.27	46.93	68.20	-21.27	Vertical

802.11ac(HT40)					Test Frequency: 5795MHz			
Frequency (MHz)	Read Level (dBuV)	Antenna Factor (dB/m)	Cable Loss (dB)	Preamp Factor (dB)	Level (dBuV/m)	Limit Line (dBuV/m)	Over Limit (dB)	Polarization
11590	33.95	39.22	8.77	36.28	45.29	68.20	-22.91	Horizontal
17385	25.61	41.78	11.51	36.26	42.56	68.20	-25.64	Horizontal
11590	30.69	39.22	8.77	36.28	42.35	68.20	-25.85	Vertical
17385	26.71	41.78	11.51	36.26	43.70	68.20	-24.5	Vertical

802.11ac(HT80)					Test Frequency: 5775MHz			
Frequency (MHz)	Read Level (dBuV)	Antenna Factor (dB/m)	Cable Loss (dB)	Preamp Factor (dB)	Level (dBuV/m)	Limit Line (dBuV/m)	Over Limit (dB)	Polarization
11550	28.52	39.34	8.76	36.29	40.17	68.20	-28.03	Horizontal
17325	27.84	41.52	11.45	36.26	44.45	68.20	-23.75	Horizontal
11550	27.78	39.34	8.76	36.29	39.52	68.20	-28.68	Vertical
17325	25.83	41.52	11.45	36.26	42.41	68.20	-25.79	Vertical

Notes:

1. Level = Read Level + Antenna Factor+ Cable loss- Preamp Factor
2. The test trace is same as the ambient noise (the test frequency range: 18GHz~40GHz), therefore no data appear in the report.
3. If the test result on peak is lower than the limit more than 20dB, then average measurement needn't be performed.

7.8 Frequency stability

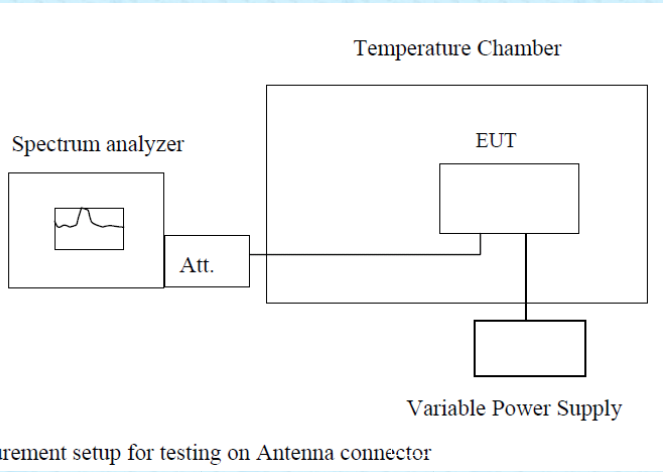
Test Requirement:	FCC Part15 C Section 15.407(g)
Test Method:	ANSI C63.10:2013, FCC Part 2.1055
Limit:	Manufactures of U-NII devices are responsible for ensuring frequency stability such that an emission is maintained within the band of operation under all conditions of normal operation as specified
Test Procedure:	The EUT was setup to ANSI C63.4, 2003; tested to 2.1055 for compliance to FCC Part 15.407(g) requirements.
Test setup:	 <p>Note : Measurement setup for testing on Antenna connector</p>
Test Instruments:	Refer to section 6 for details
Test mode:	Refer to section 5.2 for details
Test results:	Pass

Measurement Data: The detailed test data see Appendix.

8 Test Setup Photo

Reference to the **appendix I** for details.

9 EUT Constructional Details

Reference to the **appendix II** for details.

-----END-----