

2.4GHz 2012Chip Antenna: ANT2012R24005KL2

Application:

WLAN, 802.11b/g, Bluetooth, etc...

Features

SMD, high reliability, ultra compact, Omni-directional...

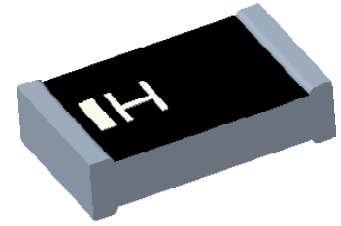

Part number

ANT 2012 R 2400 5K L2
 (1) (2) (3) (4) (5)

(1)Size Code	2.0x1.2mm
(2) Packing	Tape and reel
(3) Frequency	2.4GHz
(4) Packing Number	5K
(5)Code	L2

Electrical Specification

Working Frequency Range	2400 ~2484 MHz
Peak Gain	0.8dBi (Typ.)
Impedance	50 Ohm
VSWR	2.5(Max)
Polarization	Linear
Azimuth Beamwidth	Omni-directional
Operation Temperature(°C)	-40 ~85°C

The specification is defined on HEK EVB.

Dimension and Terminal Configuration

Top

Side

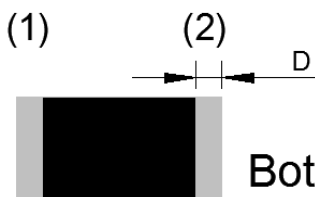
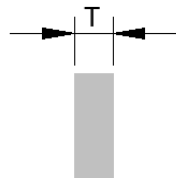
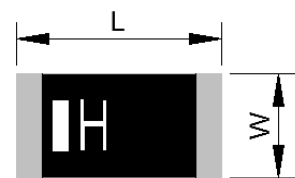

Dimension (mm)	
L	2.00±0.15
W	1.20±0.15
T	0.50±0.10
D	0.20±0.15

No.	Terminal Name
1	Feeding
2	Ground

Bottom

PCB Dimension

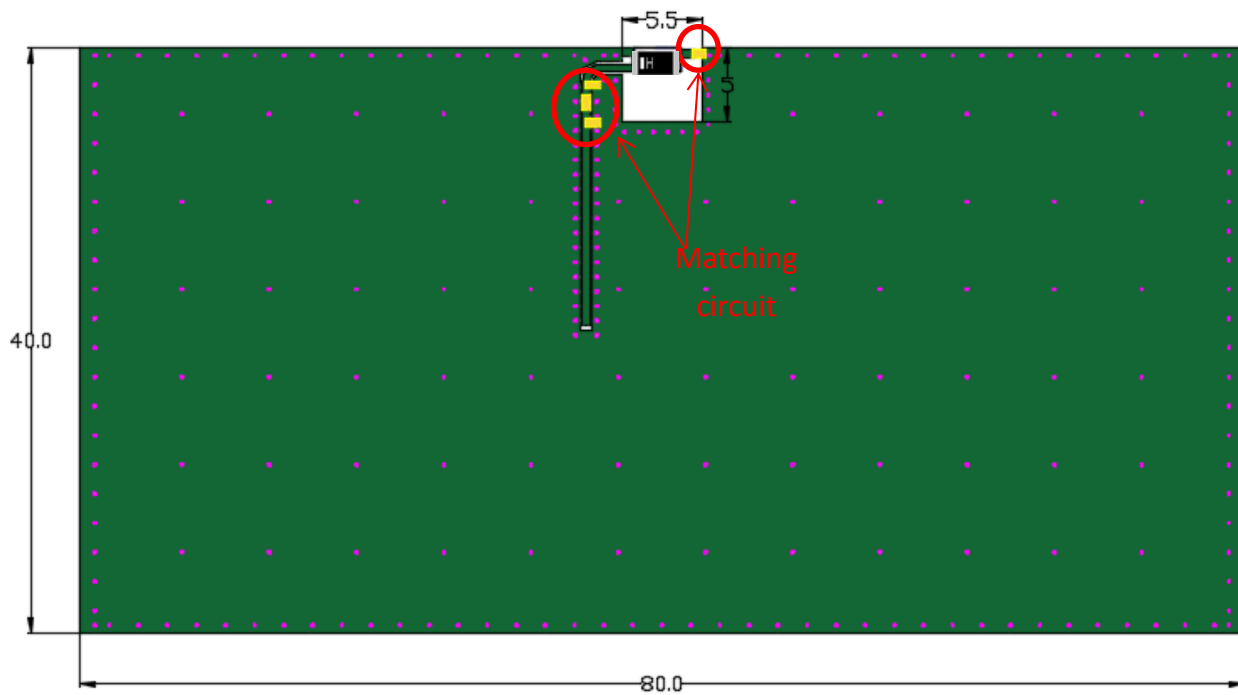

Antenna Layout Reference

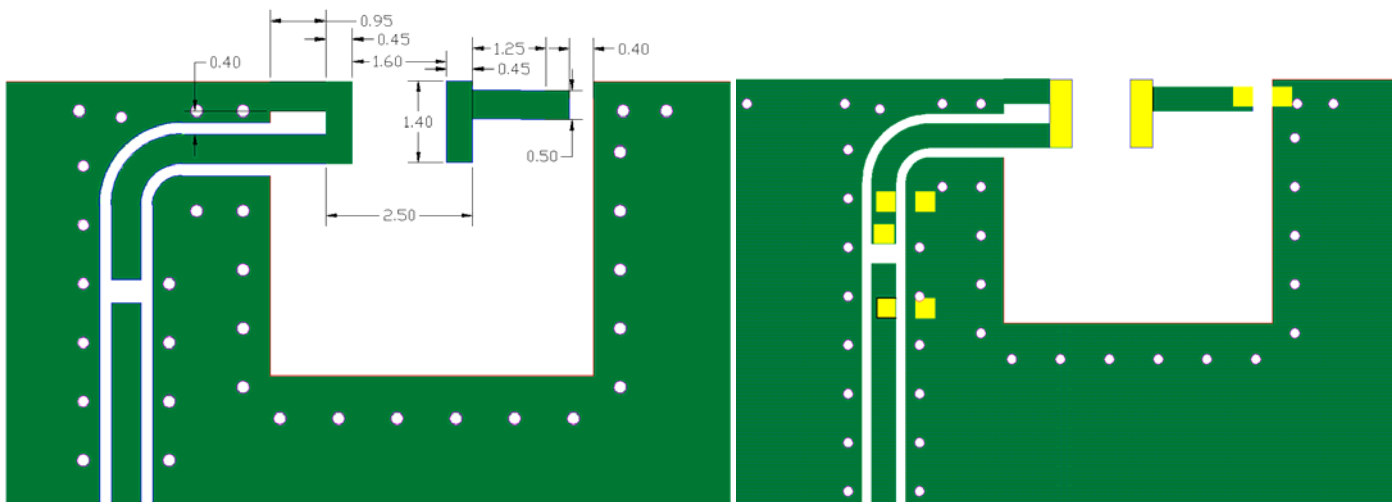

Unit : mm

: Chip Antenna

: Land Pattern

Electrical Characteristics

VSWR&Efficiency

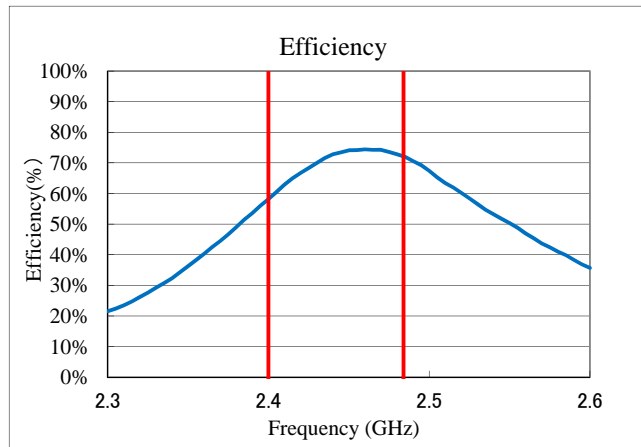
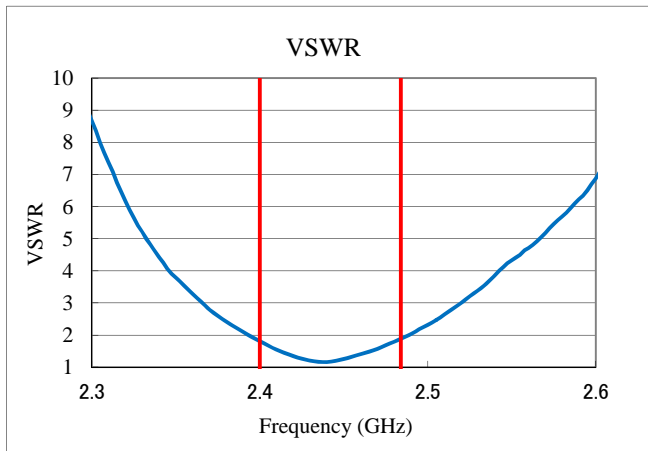

Radiation Pattern

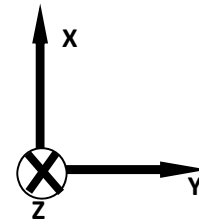
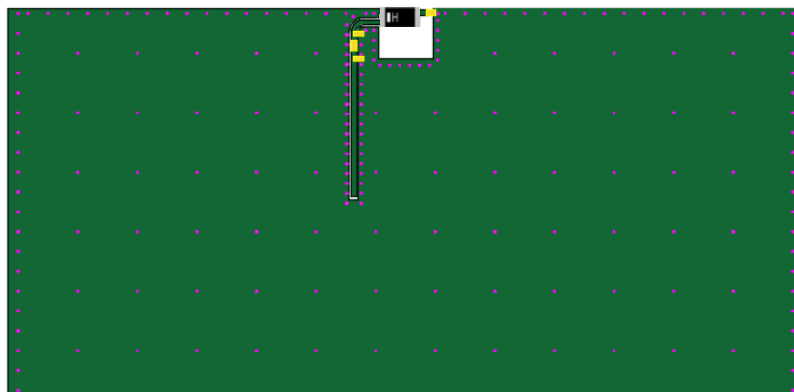

ZX-Plane

频率frequency (MHz)	GAIN (dBi)	efficiency (%)
2402	0.80	78.6
2440	0.71	75.1
2480	0.76	72.3

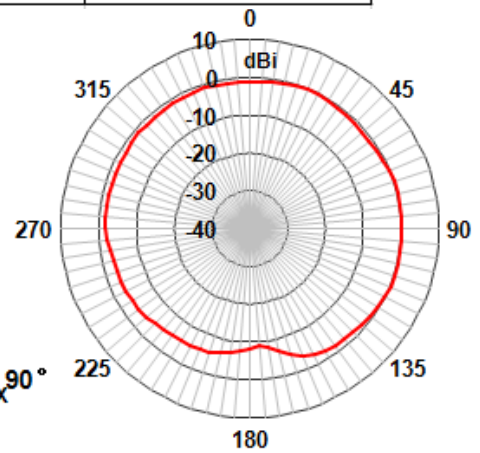
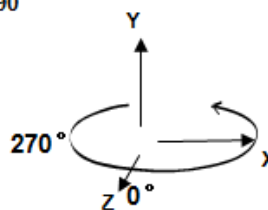
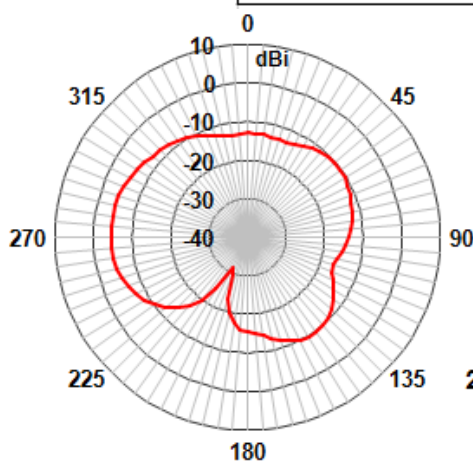

ZY-Plane

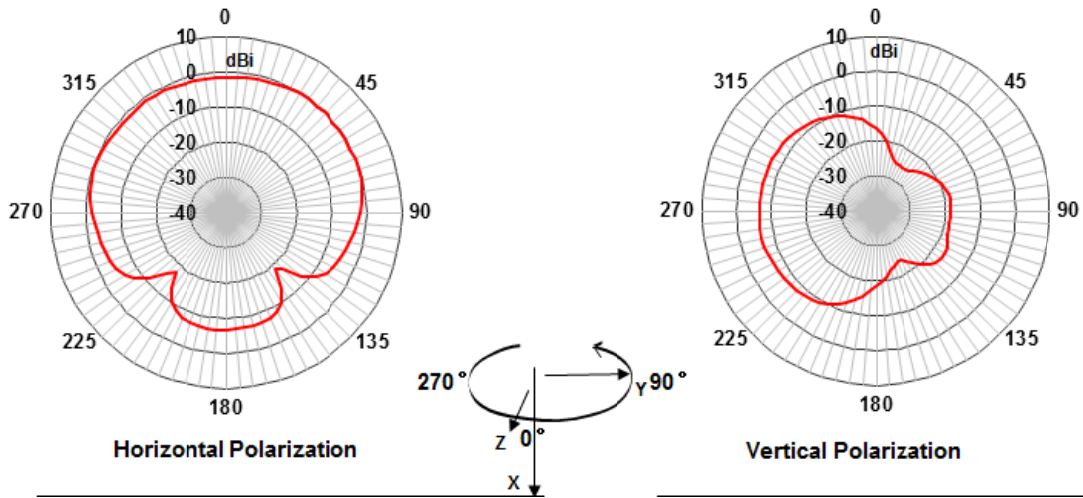

XY-Plane

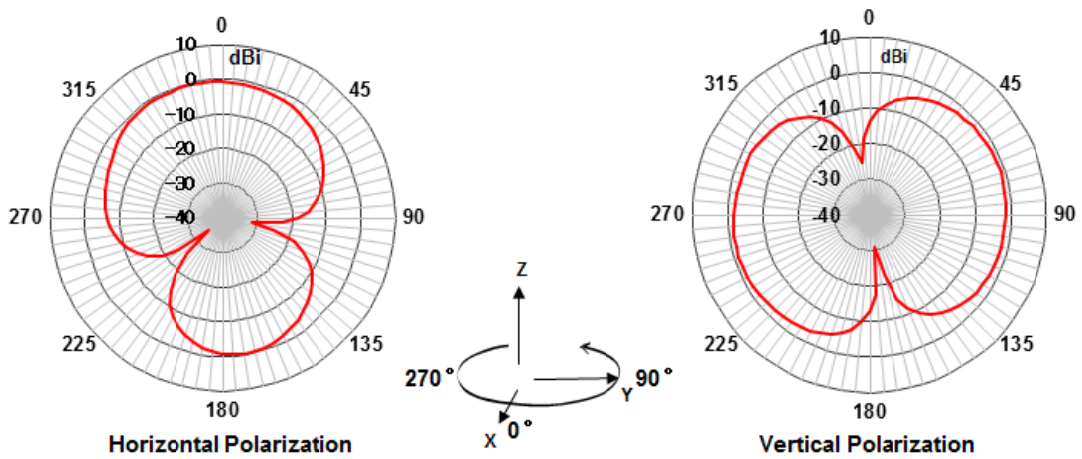

Taping Specifications

Reel and Taping Specification

Reel Specification

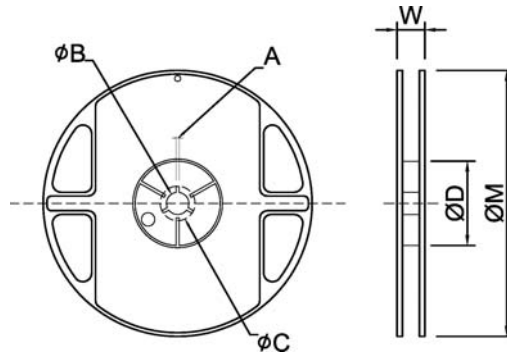

TYPE	SIZE	A	ϕB	ϕC	ϕD	W	ϕM	
2012	7"	5K/Reel	2.0±0.5	13.5±1.0	21±1.0	60±1.0	11.5±2.0	178±2.0

Taping Specification

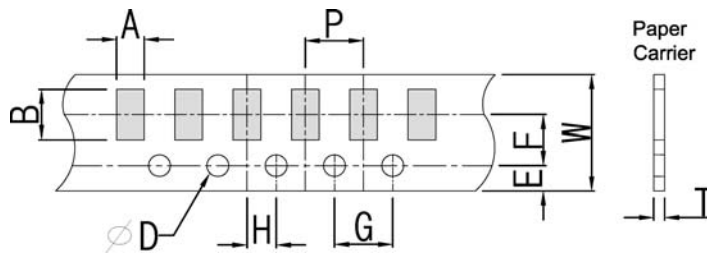

Packaging	Type	A	B	W	E	F	G	H	T	ϕD	P
Paper Type	2012	1.50±0.20	2.30±0.20	8.0±0.20	1.75±0.10	3.5±0.05	4.0±0.10	2.0±0.05	0.75±0.10	1.50 +0.10 -0	4.0±0.1

Recommended Reflow Profile

Pb free solder

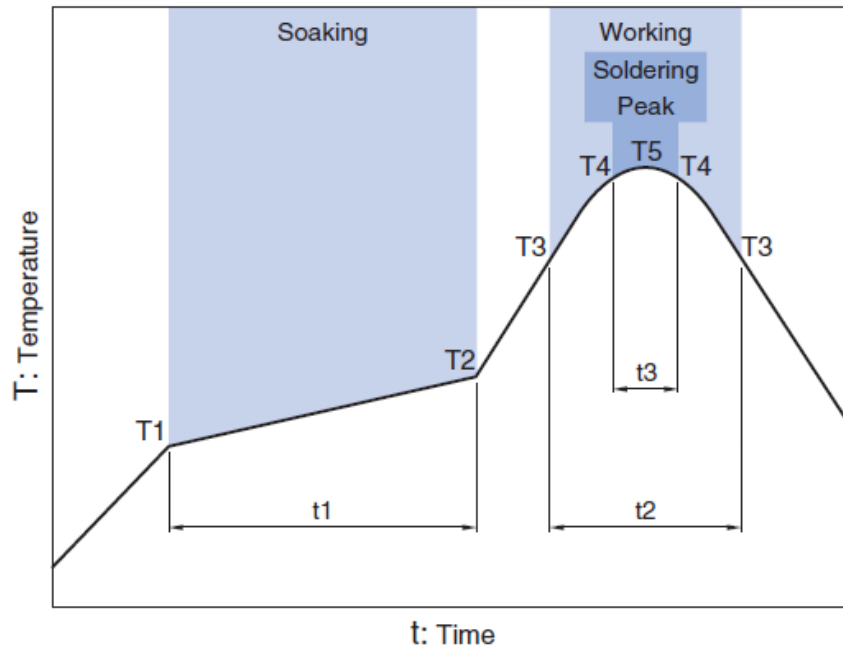

Soaking		Working		Soldering		Peak	
Temp.	Time	Temp.	Time	Temp.	Time	Temp.	
T1	T2	t1	T3	t2	T4	t3	T5
150°C	180°C	60 to 120sec	230°C	more than 30sec	247 to 253°C	within 10sec	260°C Max.

Apr. 2022 Ver.H02