

S

T

S

L

A

B



RADIO TEST REPORT

Report No.: STS2102009W19

Issued for

Shenzhen UniStrong Science & Technology Co.,Ltd.

B,4-4Factory, Zhengcheng Road, FuyongBaoan District,
Shenzhen, China

Product Name:	Rugged Smart Phone
Brand Name:	N/A
Model Name:	UT12P
Series Model:	N/A
FCC ID:	2AOPD-UT12P
Test Standard:	FCC Part 15.225

Any reproduction of this document must be done in full. No single part of this document may be reproduced without permission from STS, all test data presented in this report is only applicable to presented test sample.

Shenzhen STS Test Services Co., Ltd.
A 1/F, Building B, Zhuoke Science Park, No.190 Chongqing Road, HepingShequ,
Fuyong Sub-District, Bao'an District, Shenzhen, Guang Dong, China
TEL: +86-755 3688 6288 FAX: +86-755 3688 6277 E-mail:sts@stsapp.com





TEST REPORT CERTIFICATION

Applicant's Name : Shenzhen UniStrong Science & Technology Co.,Ltd.
Address..... : B,4-4Factory, Zhengcheng Road, FuyongBaoan District, Shenzhen, China
Manufacturer's Name : Shenzhen UniStrong Science & Technology Co.,Ltd.
Address..... : B,4-4Factory, Zhengcheng Road, FuyongBaoan District, Shenzhen, China

Product Description

Product Name : Rugged Smart Phone
Brand Name : N/A
Model Name..... : UT12P
Series Model..... : N/A

Test Standards : FCC Part15.225

Test Procedure.....: ANSI C63.10: 2013

This device described above has been tested by STS, the test results show that the equipment under test (EUT) is in compliance with the FCC requirements. And it is applicable only to the tested sample identified in the report.

This report shall not be reproduced except in full, without the written approval of STS, this document only be altered or revised by STS, personal only, and shall be noted in the revision of the document.

Date of Test

Date of receipt of test item: 01 Feb. 2021
Date (s) of performance of tests.....: 01 Feb. 2021 ~ 03 Mar. 2021
Date of Issue: 03 Mar. 2021

Test Result.....: **Pass**

Testing Engineer :

(Chris Chen)

Technical Manager :

(Sean she)

Authorized Signatory :

(Vita Li)





TABLE OF CONTENTS	Page
1. SUMMARY OF TEST RESULTS	5
1.1 TEST FACTORY	5
1.2 MEASUREMENT UNCERTAINTY	5
2. GENERAL INFORMATION	6
2.1 GENERAL DESCRIPTION OF THE EUT	6
2.2 DESCRIPTION OF THE TEST MODES	7
2.3 BLOCK DIAGRAM SHOWING THE CONFIGURATION OF SYSTEM TESTED	8
2.4 DESCRIPTION OF NECESSARY ACCESSORIES AND SUPPORT UNITS	9
2.5 EQUIPMENTS LIST FOR ALL TEST ITEMS	10
3. EMC EMISSION TEST	12
3.1 CONDUCTED EMISSION MEASUREMENT	12
3.2 TEST PROCEDURE	13
3.3 TEST SETUP	13
3.4 EUT OPERATING CONDITIONS	13
3.5 TEST RESULTS	14
4. RADIATED EMISSION MEASUREMENT	16
4.1 RADIATED EMISSION LIMITS	16
4.2 TEST PROCEDURE	18
4.3 TEST SETUP	19
4.4 EUT OPERATING CONDITIONS	19
4.5 FIELD STRENGTH CALCULATION	20
4.6 TEST RESULTS	21
5. FREQUENCY TOLERANCE	26
5.1 LIMIT	26
5.2 TEST PROCEDURE	26
5.3 TEST SETUP	26
5.4 EUT OPERATION CONDITIONS	26
5.5 TEST RESULTS	27
6. 20DB BANDWIDTH	28
6.1 LIMIT	28
6.2 TEST PROCEDURE	28
6.3 TEST SETUP	28



TABLE OF CONTENTS	Page
6.4 EUT OPERATION CONDITIONS	28
6.5 TEST RESULTS	29
7. ANTENNA REQUIREMENT	30
7.1 STANDARD REQUIREMENT	30
7.2 EUT ANTENNA	30
APPENDIX 1- PHOTOS OF TEST SETUP	31





1. SUMMARY OF TEST RESULTS

Test procedures according to the technical standards:

FCC Part15 15.225 , Subpart C			
Standard Section	Test Item	Judgment	Remark
15.207	Conducted Emission	PASS	--
15.209 15.225(a)(b)(c)(d)	Radiated Emission	PASS	--
15.225(e)	Frequency Tolerance	PASS	--
15.203	Antenna Requirement	PASS	--
15.215	20dB Bandwidth	PASS	--

NOTE: (1) 'N/A' denotes test is not applicable in this Test Report.

(2) All tests are according to ANSI C63.10-2013.

1.1 TEST FACTORY

SHENZHEN STS TEST SERVICES CO., LTD

Add. : A 1/F, Building B, Zhuoke Science Park, No.190 Chongqing Road, HepingShequ, Fuyong Sub-District, Bao'an District, Shenzhen, Guang Dong, China

FCC test Firm Registration Number: 625569

IC test Firm Registration Number: 12108A

A2LA Certificate No.: 4338.01

1.2 MEASUREMENT UNCERTAINTY

The reported uncertainty of measurement $y \pm U$, where expanded uncertainty U is based on a standard uncertainty multiplied by a coverage factor of $k=2$, providing a level of confidence of approximately **95** %.

No.	Item	Uncertainty
1	RF output power, conducted	$\pm 0.68\text{dB}$
2	Unwanted Emissions, conducted	$\pm 2.988\text{dB}$
3	All emissions, radiated 9K-30MHz	$\pm 2.68\text{dB}$
4	All emissions, radiated 30M-1GHz	$\pm 4.39\text{dB}$
5	All emissions, radiated 1G-6GHz	$\pm 5.10\text{dB}$
6	All emissions, radiated >6G	$\pm 5.48\text{dB}$
7	Conducted Emission (9KHz-150KHz)	$\pm 2.79\text{dB}$
8	Conducted Emission (150KHz-30MHz)	$\pm 2.80\text{dB}$



2. GENERAL INFORMATION

2.1 GENERAL DESCRIPTION OF THE EUT

Product Name	Rugged Smart Phone								
Trade Name	N/A								
Model Name	UT12P								
Serial Model	N/A								
Model Difference	N/A								
Product Description	<p>The EUT is a Rugged Smart Phone</p> <table border="1"> <tr> <td>Operation Frequency:</td> <td>13.56MHz</td> </tr> <tr> <td>Modulation Type:</td> <td>FSK</td> </tr> <tr> <td>Antenna Designation:</td> <td>Please see Note 2.</td> </tr> <tr> <td>Antenna Gain (dBi)</td> <td>0dBi</td> </tr> </table>	Operation Frequency:	13.56MHz	Modulation Type:	FSK	Antenna Designation:	Please see Note 2.	Antenna Gain (dBi)	0dBi
Operation Frequency:	13.56MHz								
Modulation Type:	FSK								
Antenna Designation:	Please see Note 2.								
Antenna Gain (dBi)	0dBi								
Adapter	Input: AC 100-240V 50/60Hz 0.7A Output: DC 5V 3A or 9V 2A or 12V 1.5A								
Battery	Rated Voltage:3.8V Charge Limit Voltage:4.35V Capacity: 8000mAh								
Hardware version number	C602_MB_PCB_V102								
Software version number	RP00.53.84.08								
Connecting I/O Port(s)	Please see Note 1.								

Note:

- For a more detailed features description, please refer to the manufacturer's specifications or the User Manual.
- Table for filed Antenna

Ant.	Brand	Model Name	Antenna Type	Connector	Gain (dBi)	NOTE
A	N/A	UT12P	Coil Antenna	N/A	0dBi	ANT

Note: The antenna information refer the manufacturer provide report, applicable only to the tested sample identified in the report.



2.2 DESCRIPTION OF THE TEST MODES

To investigate the maximum EMI emission characteristics generated from EUT, the test system was pre-scanning tested based on the consideration of following EUT operation mode or test configuration mode which possibly have effect on EMI emission level. Each of these EUT operation mode(s) or test configuration mode(s) mentioned above was evaluated respectively.

Pretest Mode	Description
Mode 1	TX Mode

For Conducted Test	
Final Test Mode	Description
Mode 1	TX Mode

For Radiated Emission	
Final Test Mode	Description
Mode 1	TX Mode

Note:

- (1) We have been tested for all available U.S. voltage and frequencies (For 120V, 50/60Hz and 240V, 50/60Hz) for which the device is capable of operation.
- (2) The battery is fully-charged during the radiated and RF conducted test.

2.3 BLOCK DIAGRAM SHOWING THE CONFIGURATION OF SYSTEM TESTED

Radiated Spurious Emission Test

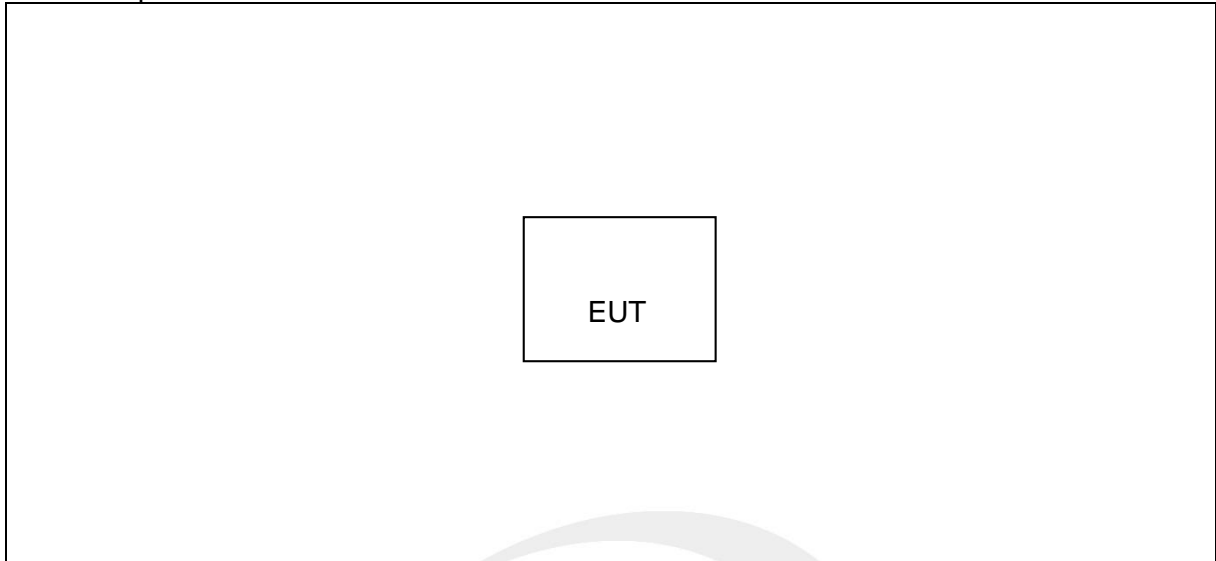

Conducted Emission Test

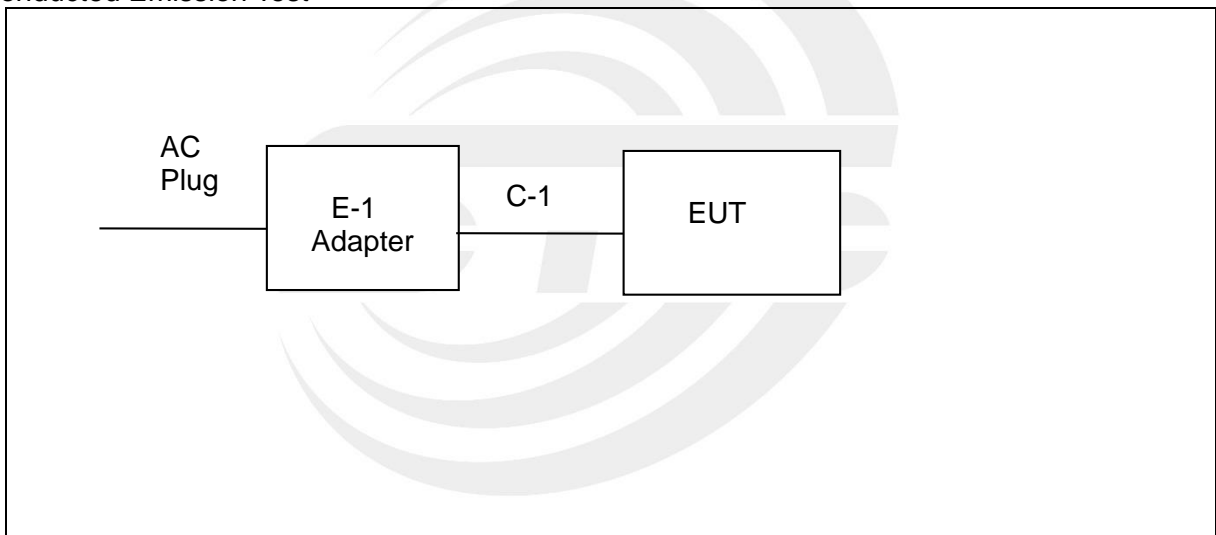



2.4 DESCRIPTION OF NECESSARY ACCESSORIES AND SUPPORT UNITS

The EUT has been tested as an independent unit together with other necessary accessories or support units. The following support units or accessories were used to form a representative test configuration during the tests.

Necessary accessories

Item	Equipment	Mfr/Brand	Model/Type No.	Length	Note
E-1	Adapter	Aquilstar	ASUC71w-050912300	N/A	N/A
C-1	USB Cable	N/A	N/A	100cm	YES

Support units

Item	Equipment	Mfr/Brand	Model/Type No.	Length	Note
N/A	N/A	N/A	N/A	N/A	N/A

Note:

- (1) For detachable type I/O cable should be specified the length in cm in 『Length』 column.
- (2) “YES” is means “with core”; “NO” is means “without core”.



2.5 EQUIPMENTS LIST FOR ALL TEST ITEMS

Radiation Test equipment

Kind of Equipment	Manufacturer	Type No.	Serial No.	Last calibration	Calibrated until
Test Receiver	R&S	ESCI	101427	2020.10.12	2021.10.11
Signal Analyzer	R&S	FSV 40-N	101823	2020.10.10	2021.10.09
Active loop Antenna	ZHINAN	ZN30900C	16035	2019.07.11	2021.07.10
Bilog Antenna	TESEQ	CBL6111D	34678	2020.10.12	2022.10.11
Horn Antenna	SCHWARZBECK	BBHA 9120D	02014	2019.10.15	2021.10.14
SHF-EHF Horn Antenna (18G-40GHz)	A-INFO	LB-180400-KF	J211020657	2020.10.12	2022.10.11
Pre-Amplifier (0.1M-3GHz)	EM	EM330	060665	2020.10.12	2021.10.11
Pre-Amplifier (1G-18GHz)	SKET	LNPA-01018G-45	SK2018080901	2020.10.12	2021.10.11
Pre-Amplifier (18G-40GHz)	SKET	LNPA-1840-50	SK2018101801	2020.10.10	2021.10.09
Temperature & Humidity	HH660	Mieo	N/A	2020.10.13	2021.10.12
Turn table	EM	SC100_1	60531	N/A	N/A
Antenna mast	EM	SC100	N/A	N/A	N/A
Test SW	FARAD	EZ-EMC(Ver.STSLAB-03A1 RE)			

Conduction Test equipment

Kind of Equipment	Manufacturer	Type No.	Serial No.	Last calibration	Calibrated until
Test Receiver	R&S	ESCI	101427	2020.10.12	2021.10.11
LISN	R&S	ENV216	101242	2020.10.12	2021.10.11
LISN	EMCO	3810/2NM	23625	2020.10.12	2021.10.11
Temperature & Humidity	HH660	Mieo	N/A	2020.10.13	2021.10.12
Test SW	FARAD	EZ-EMC(Ver.STSLAB-03A1 CE)			



RF Connected Test

Kind of Equipment	Manufacturer	Type No.	Serial No.	Last calibration	Calibrated until
Power Sensor	Keysight	U2021XA	MY55520005	2020.10.10	2021.10.09
			MY55520006	2020.10.10	2021.10.09
			MY56120038	2020.10.10	2021.10.09
			MY56280002	2020.10.10	2021.10.09
Signal Analyzer	Agilent	N9020A	MY51110105	2020.03.05	2021.03.04
Temperature & Humidity	HH660	Mieo	N/A	2020.10.13	2021.10.12
Test SW	FARAD	LZ-RF /LzRf-3A3			





3. EMC EMISSION TEST

3.1 CONDUCTED EMISSION MEASUREMENT

3.1.1 POWER LINE CONDUCTED EMISSION LIMITS

The radio frequency voltage that is conducted back onto the AC power line on any frequency or frequencies, within the band 150 kHz to 30 MHz, shall not exceed the limits in the following table.

FREQUENCY (MHz)	Class B (dBuV)		Standard
	Quasi-peak	Average	
0.15 -0.5	66 - 56 *	56 - 46 *	CISPR
0.50 -5.0	56.00	46.00	CISPR
5.0 -30.0	60.00	50.00	CISPR

0.15 -0.5	66 - 56 *	56 - 46 *	FCC
0.50 -5.0	56.00	46.00	FCC
5.0 -30.0	60.00	50.00	FCC

Note:

- (1) The tighter limit applies at the band edges.
- (2) The limit of " * " marked band means the limitation decreases linearly with the logarithm of the frequency in the range.

The following table is the setting of the receiver

Receiver Parameters	Setting
Attenuation	10 dB
Start Frequency	0.15 MHz
Stop Frequency	30 MHz
IF Bandwidth	9 kHz

3.2 TEST PROCEDURE

- a. The EUT is 0.8 m from the horizontal ground plane and 0.4 m from the vertical ground plane with EUT being connected to the power mains through a line impedance stabilization network (LISN). All other support equipments are powered from additional LISN(s). The LISN provides 50 Ohm/ 50uH of coupling impedance for the measuring instrument.
- b. Interconnecting cables that hang closer than 40 cm to the ground plane shall be folded back and forth in the center forming a bundle 30 to 40 cm long.
- c. I/O cables that are not connected to a peripheral shall be bundled in the center. The end of the cable may be terminated, if required, using the correct terminating impedance. The overall length shall not exceed 1 m.
- d. LISN at least 80 cm from nearest part of EUT chassis.
- e. For the actual test configuration, please refer to the related Item –EUT Test Photos.

3.3 TEST SETUP

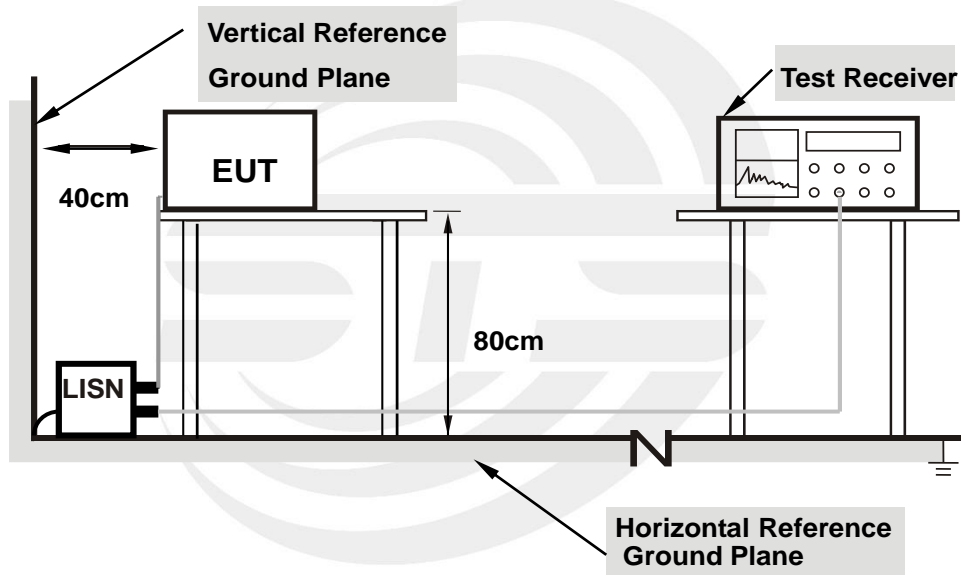

- Note:**
- 1.Support units were connected to second LISN.
 - 2.Both of LISNs (AMN) are 80 cm from EUT and at least 80 cm from other units and other metal planes support.

3.4 EUT OPERATING CONDITIONS

The EUT was configured for testing in a typical fashion (as a customer would normally use it). The EUT has been programmed to continuously transmit during test. This operating condition was tested and used to collect the included data.



3.5 TEST RESULTS

Temperature:	26.8(C)	Relative Humidity:	66%RH
Test Voltage:	AC 120V/60Hz	Phase:	L
Test Mode:	Mode 1		

No.	Frequen cy (MHz)	Reading (dBuV)	Correct Factor(d B)	Result (dBuV)	Limit (dBuV)	Margin (dB)	Remark
1	0.1500	28.39	20.19	48.58	66.00	-17.42	QP
2	0.1500	14.33	20.19	34.52	56.00	-21.48	AVG
3	0.5620	29.21	20.38	49.59	56.00	-6.41	QP
4	0.5620	15.54	20.38	35.92	46.00	-10.08	AVG
5	1.3860	24.86	20.16	45.02	56.00	-10.98	QP
6	1.3860	8.62	20.16	28.78	46.00	-17.22	AVG
7	2.2780	25.83	20.13	45.96	56.00	-10.04	QP
8	2.2780	9.65	20.13	29.78	46.00	-16.22	AVG
9	4.6380	24.90	20.03	44.93	56.00	-11.07	QP
10	4.6380	10.60	20.03	30.63	46.00	-15.37	AVG
11	20.8860	17.05	20.65	37.70	60.00	-22.30	QP
12	20.8860	5.56	20.65	26.21	50.00	-23.79	AVG

Remark:

1. All readings are Quasi-Peak and Average values
2. Margin = Result (Result =Reading + Factor)–Limit
3. Factor=LISN factor+Cable loss+Limiter (10dB)

100.0 dBuV

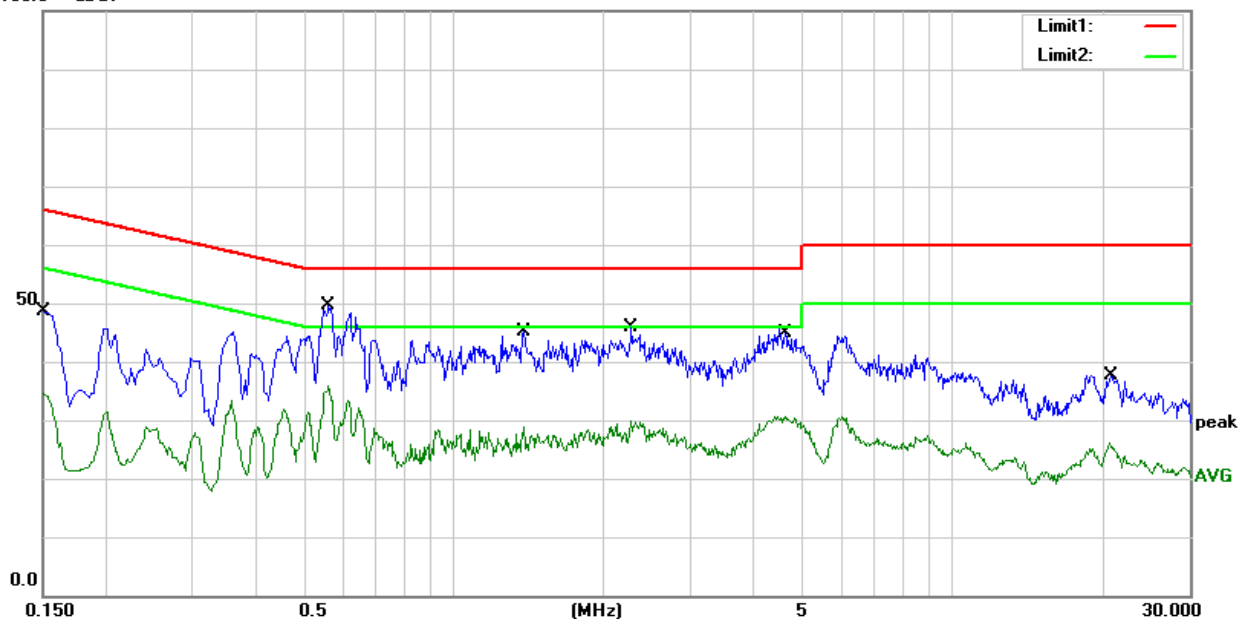



Temperature:	26.8(C)	Relative Humidity:	66%RH
Test Voltage:	AC 120V/60Hz	Phase:	N
Test Mode:	Mode 1		

No.	Frequen cy (MHz)	Reading (dBuV)	Correct Factor(d B)	Result (dBuV)	Limit (dBuV)	Margin (dB)	Remark
1	0.1500	28.28	20.19	48.47	66.00	-17.53	QP
2	0.1500	11.07	20.19	31.26	56.00	-24.74	AVG
3	0.5540	25.09	20.39	45.48	56.00	-10.52	QP
4	0.5540	12.54	20.39	32.93	46.00	-13.07	AVG
5	1.4820	23.13	20.15	43.28	56.00	-12.72	QP
6	1.4820	7.54	20.15	27.69	46.00	-18.31	AVG
7	3.9220	21.40	20.06	41.46	56.00	-14.54	QP
8	3.9220	6.64	20.06	26.70	46.00	-19.30	AVG
9	10.5380	17.82	19.86	37.68	60.00	-22.32	QP
10	10.5380	4.13	19.86	23.99	50.00	-26.01	AVG
11	20.5780	16.99	20.64	37.63	60.00	-22.37	QP
12	20.5780	4.79	20.64	25.43	50.00	-24.57	AVG

Remark:

1. All readings are Quasi-Peak and Average values
2. Margin = Result (Result =Reading + Factor)–Limit
3. Factor=LISN factor+Cable loss+Limiter (10dB)

100.0 dBuV

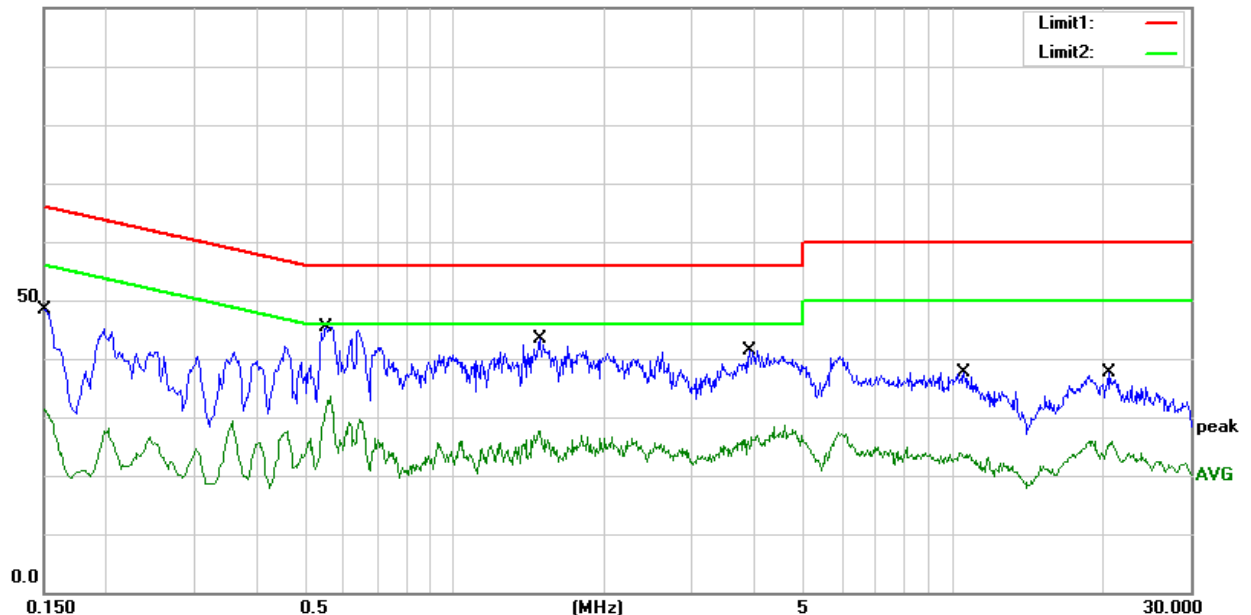



4. RADIATED EMISSION MEASUREMENT

4.1 RADIATED EMISSION LIMITS

- (a) The field strength of any emissions within the band 13.553-13.567 MHz shall not exceed 15,848 microvolts/meter at 30 meters.
- (b) Within the bands 13.410-13.553 MHz and 13.567-13.710 MHz, the field strength of any emissions shall not exceed 334 microvolts/meter at 30 meters.
- (c) Within the bands 13.110-13.410 MHz and 13.710-14.010 MHz the field strength of any emissions shall not exceed 106 microvolts/meter at 30 meters.
- (d) The field strength of any emissions appearing outside of the 13.110-14.010 MHz band shall not exceed the general radiated emission limits in §15.209.

(Radiated Emission <30MHz (9KHz-30MHz, H-field)

According to FCC section 15.225, for <30MHz, Radiated emissions were measured according to ANSIC63.4. The EUT was set to transmit at the highest output power. The EUT was set 30 meter away from the measuring antenna. The loop antenna was positioned 1 meter above the ground from the center of the loop. The measuring bandwidth was set to 10KHz. (Note: During testing the receive antenna was rotated about its axis to maximize the emission from the EUT)

There was no detected Restricted bands and Radiated suprious emission below 30MHz. The 30m limit was converted to 3m Limit using square factor(x) as it was found by measurements as follows;

$$3 \text{ m Limit(dBuV/m)} = 20\log(X)+40\log(30/3)= 20\log(15,848)+40\log(30/3) =124\text{dBuV}$$

$$3 \text{ m Limit(dBuV/m)} = 20\log(X)+40\log(30/3)= 20\log(334)+40\log(30/3) =90.47\text{dBuV}$$

$$3 \text{ m Limit(dBuV/m)} = 20\log(X)+40\log(30/3)= 20\log(106)+40\log(30/3) =80.506\text{dBuV}$$

$$3 \text{ m Limit(dBuV/m)} = 20\log(X)+40\log(30/3)= 20\log(30)+40\log(30/3) =69.54\text{dBuV}$$

Except as provided elsewhere in this Subpart, the emissions from an intentional radiator shall not exceed the field strength levels specified in the following table:

LIMITS OF RADIATED EMISSION MEASUREMENT (Frequency Range 9kHz-1000MHz)

Frequency range (KHz)	Frequency (KHz)	Field Strength@300m		Field Strength@3m
		$\mu\text{V/m}$	$\text{dB}\mu\text{V/m}$	$\text{dB}\mu\text{V/m}$
9 ~ 490	9	266.67	48.52	128.52
	150	16.00	24.08	104.08
	490	4.90	13.80	93.80

Frequency range (KHz)	Frequency (KHz)	Field Strength@30m		Field Strength@3m
		$\mu\text{V/m}$	$\text{dB}\mu\text{V/m}$	$\text{dB}\mu\text{V/m}$
490 ~ 1705	490	48.98	33.80	73.80
	1705	14.08	22.97	62.97

Frequency range (KHz)	Frequency (KHz)	Field Strength@30m		Field Strength@3m
		$\mu\text{V/m}$	$\text{dB}\mu\text{V/m}$	$\text{dB}\mu\text{V/m}$
1705 ~ 30000	1705	30.00	29.54	69.54
	30000	30.00	29.54	69.54



Frequency range (MHz)	Field Strength@30m		Field Strength@3m
	μV/m	dBμV/m	dBμV/m
13.110 ~ 13.410	106	40.5	80.5
13.410 ~ 13.553	334	50.5	90.5
13.553 ~13.567	15.848	84	124.0
13.567 ~ 13.710	334	50.5	90.5
13.710 ~14.010	106	40.5	80.5

NOTE:

- a) Field Strength (dBμV/m) = 20*log[Field Strength (μV/m)].
- b) In the emission tables above, the tighter limit applies at the Band edge.
 Radiated Emission >30MHz (30MHz-1GHz, E-field)
 According to FCC section 15.205, the field strength of radiated emissions from intentional radiators at a distance of 3 meters shall not exceed the following values:

Frequencies (MHz)	Field Strength (micorvolts/meter)	Measurement Distance (meters)
30~88	100	3
88~216	150	3
216~960	200	3
Above 960	500	3

Receiver Parameter	Setting
Attenuation	Auto
Start ~ Stop Frequency	9kHz~90kHz / RB 200Hz for PK & AV
Start ~ Stop Frequency	90kHz~110kHz / RB 200Hz for QP
Start ~ Stop Frequency	110kHz~490kHz / RB 200Hz for PK & AV
Start ~ Stop Frequency	490kHz~30MHz / RB 9kHz for QP
Start ~ Stop Frequency	30MHz~1000MHz / RB 120kHz for QP



4.2 TEST PROCEDURE

- a. The test is performed in a 3m Semi-Anechoic Chamber; the antenna factor, cable loss and so on of the site (factors) is calculated to correct the reading. The EUT is placed on a 0.8m high insulating Turn Table, and keeps 3m away from the Test Antenna, which is mounted on a variable-height antenna master tower. For the test Antenna
- b. In the frequency range of 9KHz to 30MHz, magnetic field is measured with Loop Test Antenna. The Test Antenna is positioned with its plane vertical at 1m distance from the EUT. The center of the Loop Test Antenna is 1m above the ground. During the measurement the Loop Test Antenna rotates about its vertical axis for maximum response at each azimuth about the EUT.
- c. In the frequency range above 30MHz, Bi-Log Test Antenna (30MHz to 1GHz) used. Test Antenna is 3m away from the EUT. Test Antenna height is varied from 1m to 4m above the ground to determine the maximum value of the field strength. The emission levels at both horizontal and vertical polarizations should be tested.
- f. The initial step in collecting conducted emission data is a spectrum analyzer peak detector mode pre-scanning the measurement frequency range. Significant peaks are then marked and then Quasi Peak detector mode re-measured.
- g. If the Peak Mode measured value compliance with and lower than Quasi Peak Mode Limit, the EUT shall be deemed to meet QP Limits and then no additional QP Mode measurement performed.
- h. For the actual test configuration, please refer to the related Item –EUT Test Photos.

NOTE:

Both horizontal and vertical antenna polarities were tested and performed pretest to three orthogonal axis. The worst case emissions were reported

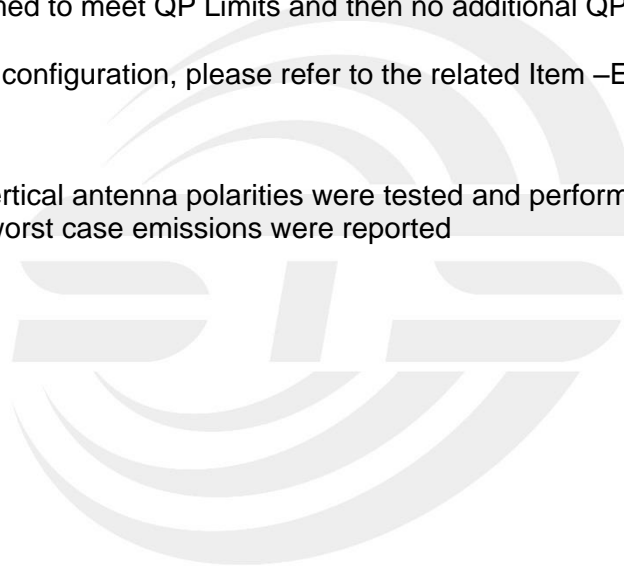

4.3 TEST SETUP

(A) Radiated Emission Test-Up Frequency Below 30MHz

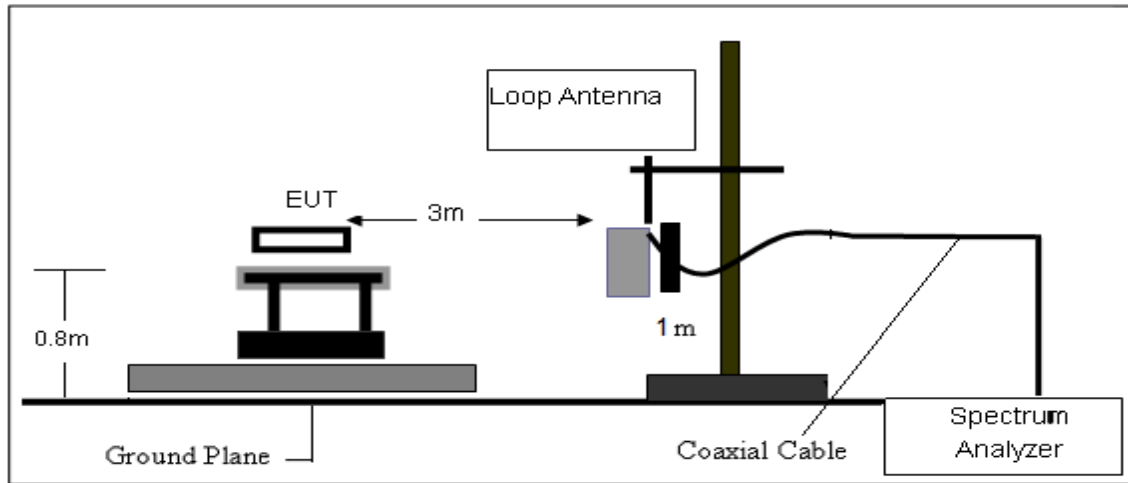

(B) Radiated Emission Test-Up Frequency 30MHz~1GHz

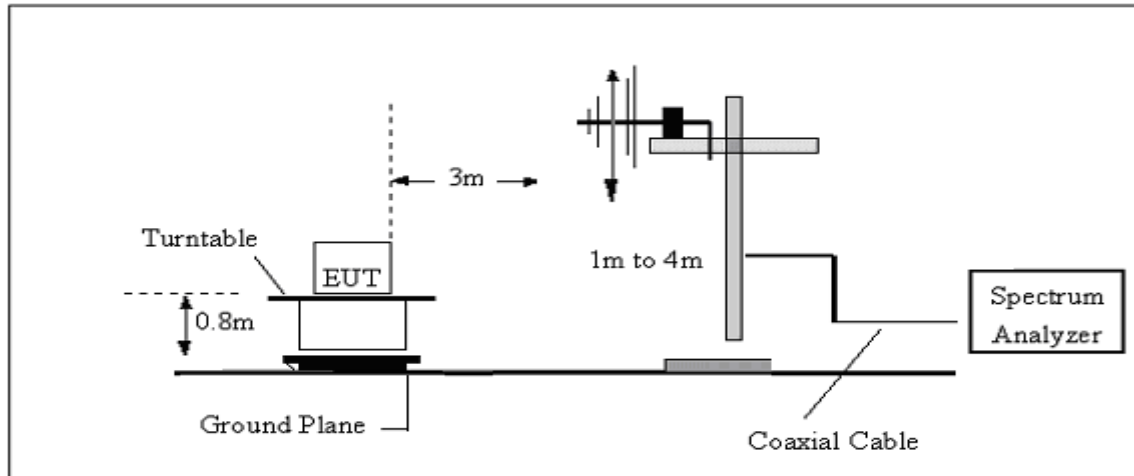

4.4 EUT OPERATING CONDITIONS

Please refer to section 3.4 of this report.



4.5 FIELD STRENGTH CALCULATION

The field strength is calculated by adding the Antenna Factor and Cable Factor and subtracting the Amplifier Gain and Duty Cycle Correction Factor (if any) from the measured reading. The basic equation with a sample calculation is as follows:

$$FS = RA + AF + CL - AG$$

Where

FS = Field Strength

CL = Cable Attenuation Factor (Cable Loss)

RA = Reading Amplitude

AG = Amplifier Gain

AF = Antenna Factor

For example

Frequency	FS	RA	AF	CL	AG	Factor
(MHz)	(dBμV/m)	(dBμV/m)	(dB)	(dB)	(dB)	(dB)
300	40	58.1	12.2	1.6	31.9	-18.1

$$\text{Factor} = \text{AF} + \text{CL} - \text{AG}$$





4.6 TEST RESULTS

(Radiated Emission<30MHz (9KHz-30MHz, H-field))

9KHz-150KHz

Temperature:	23.1(C)	Relative Humidity:	60%RH
Test Voltage:	DC 3.8V	Test Mode:	Mode 1

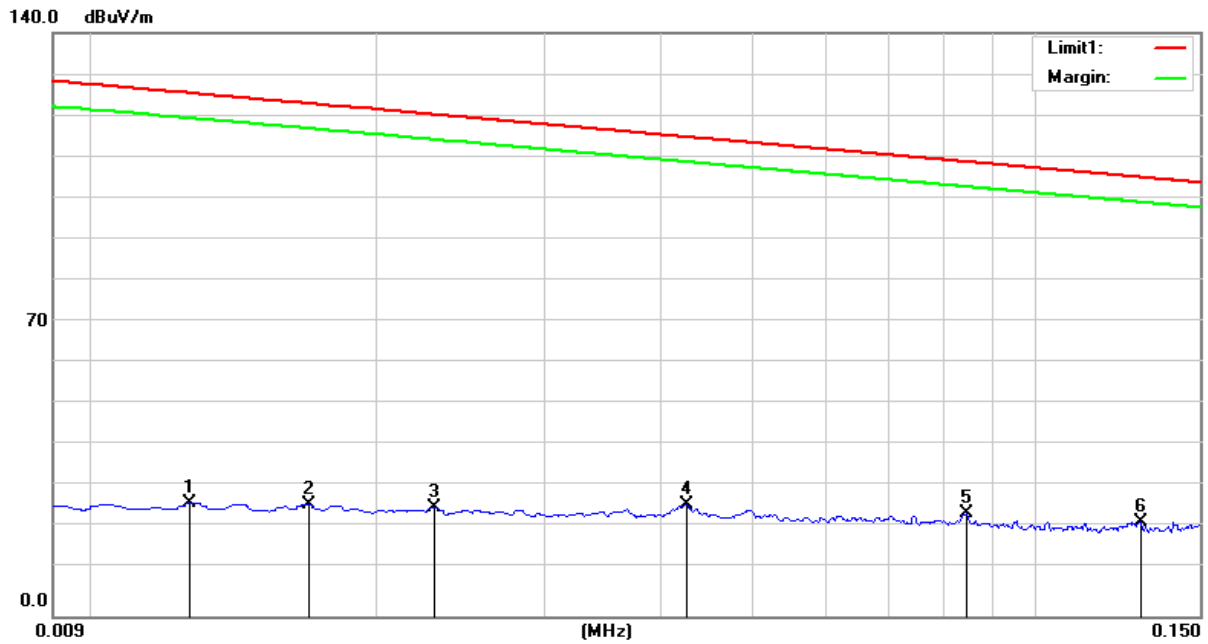

No.	Frequency (KHz)	Reading (dBuV)	Correct Factor(dB/m)	Result (dBuV/m)	Limit (dBuV/m)	Margin (dB)	Remark
1	0.0126	7.68	19.56	27.24	125.60	-98.36	QP
2	0.0167	6.85	19.86	26.71	123.15	-96.44	QP
3	0.0230	5.98	20.04	26.02	120.37	-94.35	QP
4	0.0425	7.28	19.65	26.93	115.04	-88.11	QP
5	0.0846	6.23	18.34	24.57	109.06	-84.49	QP
6	0.1297	5.17	17.54	22.71	105.35	-82.64	QP



150KHz-30MHz

Temperature:	23.1(C)	Relative Humidity:	60%RH
Test Voltage:	DC 3.8V	Test Mode:	Mode 1

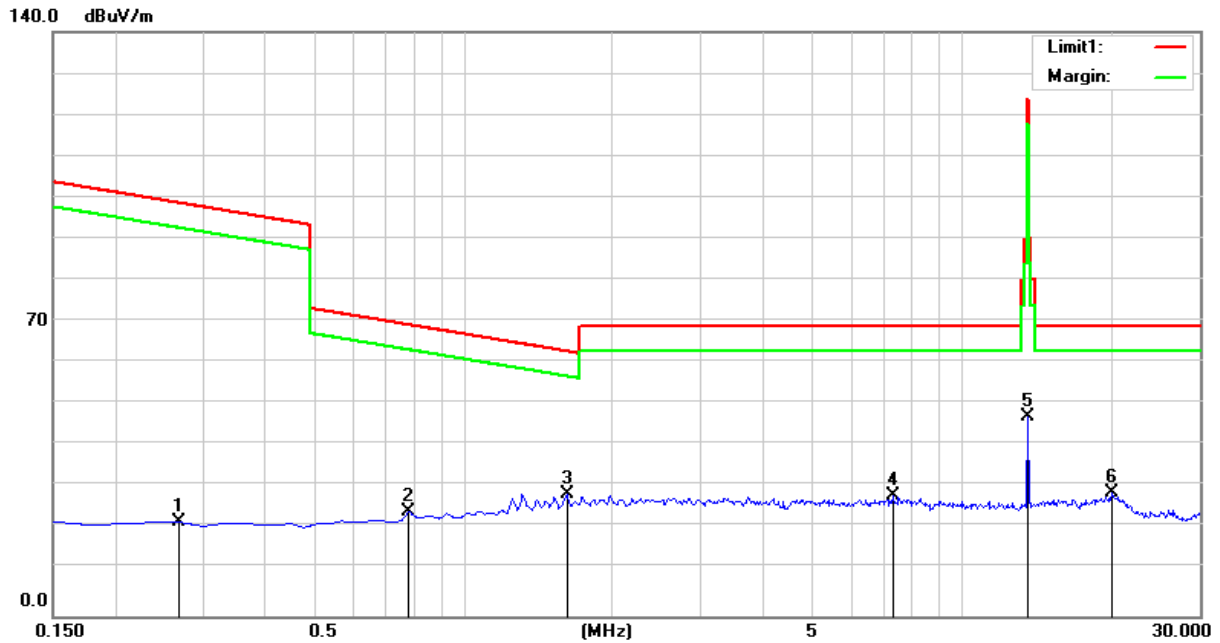

No.	Frequency (MHz)	Reading (dBuV)	Correct Factor(dB/m)	Result (dBuV/m)	Limit (dBuV/m)	Margin (dB)	Remark
1	0.2694	2.42	20.11	22.53	99.00	-76.47	QP
2	0.7768	4.73	20.29	25.02	69.80	-44.78	QP
3	1.6126	8.97	20.32	29.29	63.45	-34.16	QP
4	7.2543	8.68	20.36	29.04	69.50	-40.46	QP
5	13.5600	26.90	20.91	47.81	90.50	-42.68	peak
6	20.0003	7.04	22.50	29.54	69.50	-39.96	QP



Band-edge

No.	Frequency (MHz)	Reading (dBuV)	Correct Factor(dB/m)	Result (dBuV/m)	Limit (dBuV/m)	Margin (dB)	Remark
1	13.1100	3.63	20.88	24.51	69.50	-44.99	QP
2	13.4100	3.15	20.95	24.10	80.50	-56.40	QP
3	13.5530	4.04	20.98	25.02	90.50	-65.48	QP
4	13.5600	26.90	20.98	47.88	124.00	-76.12	peak
5	13.5670	4.19	20.98	25.17	90.50	-65.33	QP
6	13.7100	2.72	21.02	23.74	80.50	-56.76	QP
7	14.0100	2.02	21.08	23.10	69.50	-46.40	QP

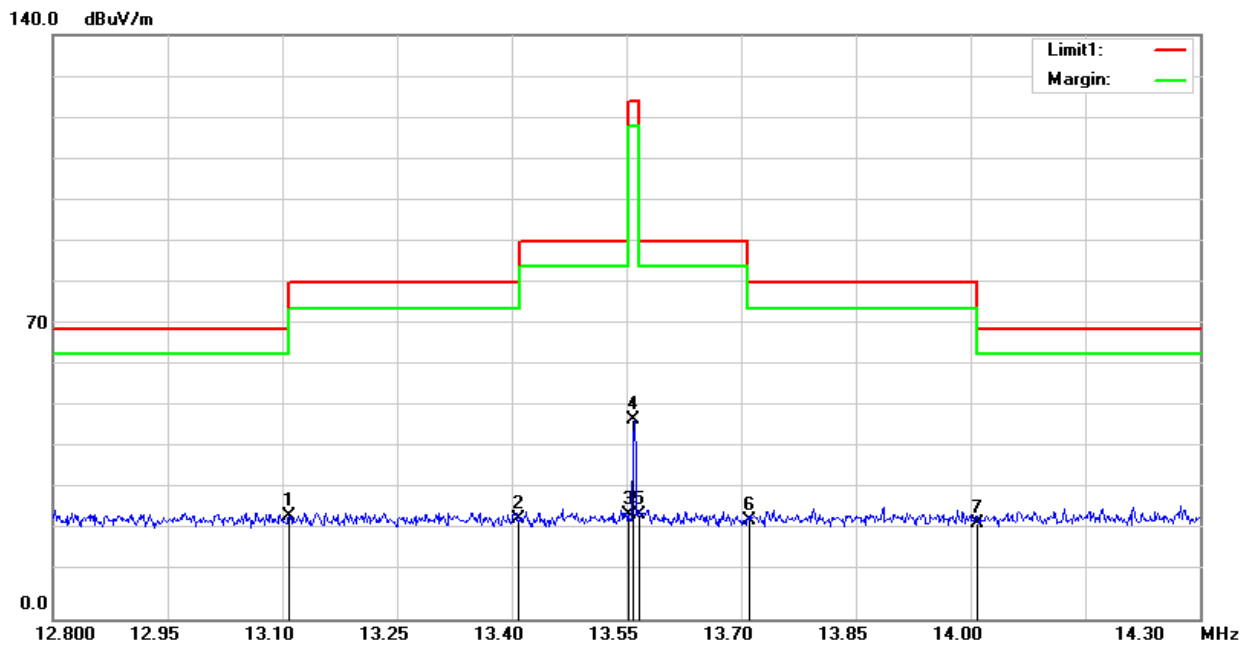



Between 30-1000MHz

Temperature:	23.1(C)	Relative Humidity:	60%RH
Test Voltage:	DC 3.8V	Phase:	Horizontal
Test Mode:	Mode 1		

No.	Frequency (MHz)	Reading (dBuV)	Correct Factor(dB/m)	Result (dBuV/m)	Limit (dBuV/m)	Margin (dB)	Remark
1	33.8800	27.46	-14.80	12.66	40.00	-27.34	QP
2	293.8400	28.48	-15.02	13.46	46.00	-32.54	QP
3	566.4100	27.68	-5.57	22.11	46.00	-23.89	QP
4	733.2500	29.40	-2.35	27.05	46.00	-18.95	QP
5	843.8300	26.88	-0.49	26.39	46.00	-19.61	QP
6	978.6600	26.51	2.58	29.09	54.00	-24.91	QP

Remark:

1. Margin = Result (Result =Reading + Factor)-Limit
2. Factor= Antenna factor+Cable attenuation factor(cable loss)-Amplifier gain

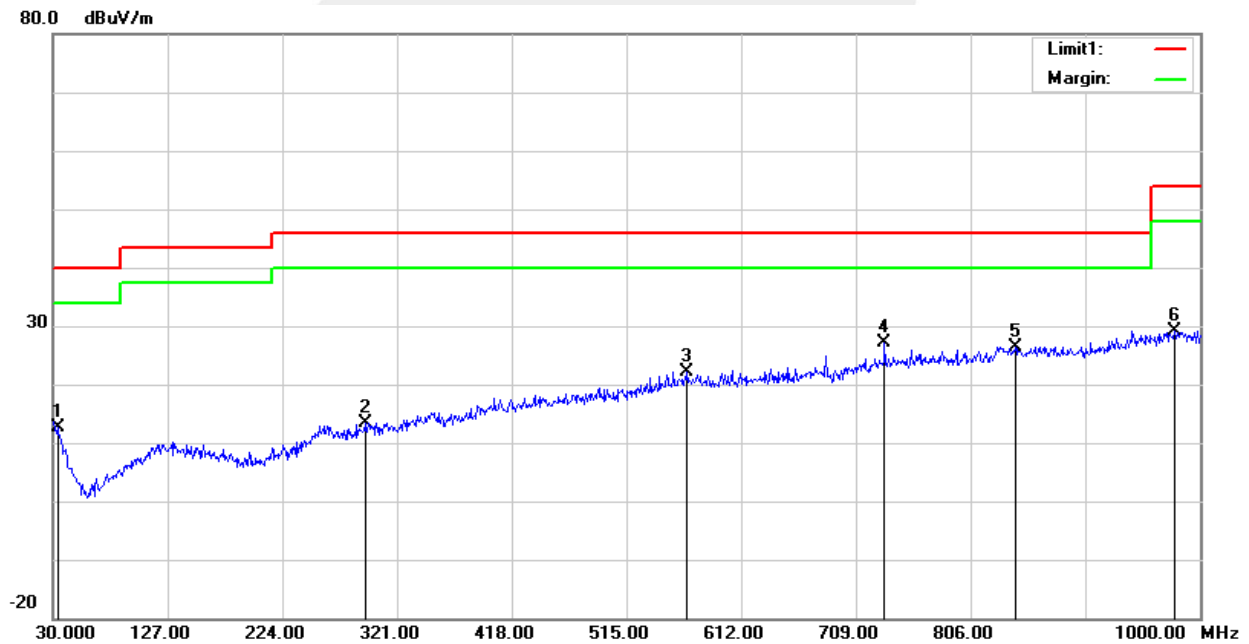



Temperature:	23.1(C)	Relative Humidity:	60%RH
Test Voltage:	DC 3.8V	Phase:	Vertical
Test Mode:	Mode 1		

No.	Frequency (MHz)	Reading (dBuV)	Correct Factor (dB/m)	Result (dBuV/m)	Limit (dBuV/m)	Margin (dB)	Remark
1	34.8500	28.73	-15.34	13.39	40.00	-26.61	QP
2	263.7700	28.57	-14.75	13.82	46.00	-32.18	QP
3	421.8800	29.53	-10.10	19.43	46.00	-26.57	QP
4	633.3400	29.77	-4.98	24.79	46.00	-21.21	QP
5	830.2500	27.39	-0.74	26.65	46.00	-19.35	QP
6	964.1100	27.57	1.86	29.43	54.00	-24.57	QP

Remark:

- Margin = Result (Result = Reading + Factor) - Limit
- Factor = Antenna factor + Cable attenuation factor (cable loss) - Amplifier gain

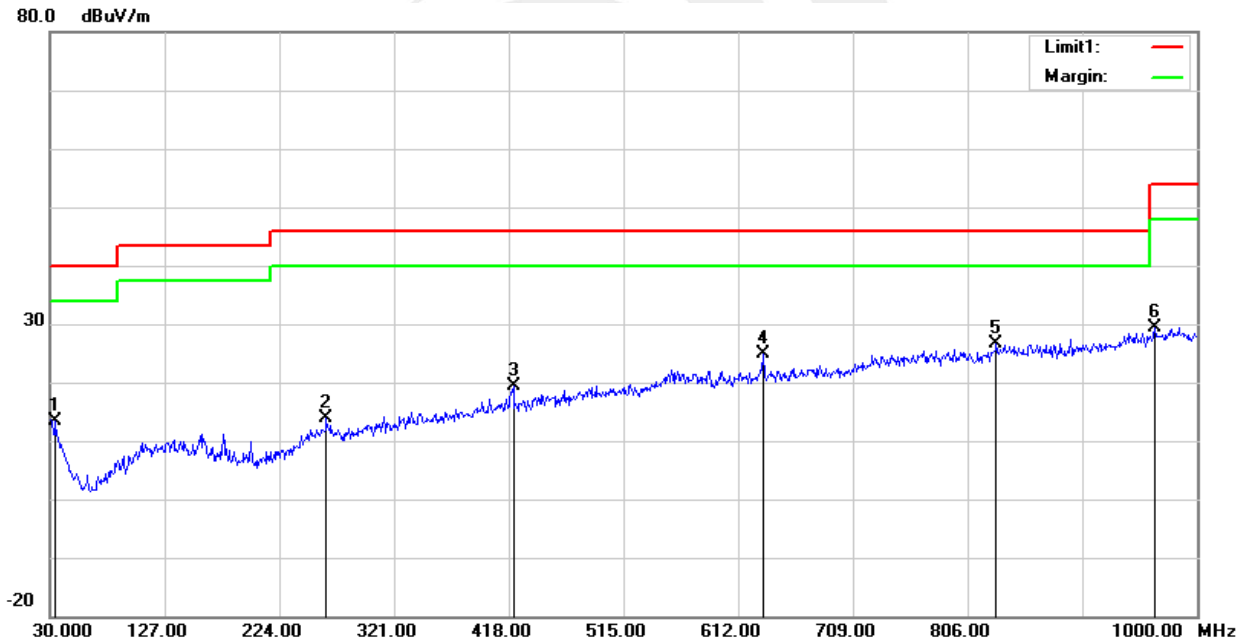

5. FREQUENCY TOLERANCE

5.1 LIMIT

According to FCC section 15.225, the devices operating in the 13.553-13.567 MHz shall maintain the carrier frequency within 0.01% of the operating frequency over the temperature variation of -20°C to +50°C using an environmental chamber. The primary supply voltage is varied from 85% to 115% of the voltage normally at the input to the device or at the power supply terminals if cables are not normally supplied.

5.2 TEST PROCEDURE

According to FCC section 15.225(e), The frequency tolerance of the carrier signal shall be maintained within $\pm 0.01\%$ of the operating frequency over a temperature variation of -20 degrees to + 50 degrees C at normal supply voltage, and for a variation in the primary supply voltage from 85% to 115% of the rated supply voltage at a temperature of 20 degrees C. For battery operated equipment, the equipment tests shall be performed using a new battery.

5.3 TEST SETUP

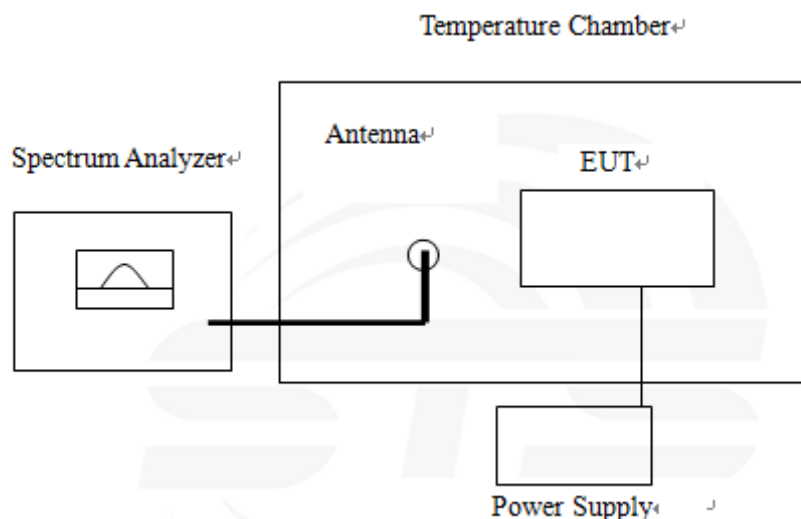

The EUT which is powered by the Battery, is coupled to the Spectrum Analyzer; the RF load attached to the EUT antenna terminal is 50Ohm; the path loss as the factor is calibrated to correct the reading.

5.4 EUT OPERATION CONDITIONS

Please refer to section 3.4 of this report.



5.5 TEST RESULTS

Temperature:	25 °C	Relative Humidity:	50%
Test Voltage:	DC 3.8V	Test Mode:	TX Mode

13.56MHz

VOLTAGE(%)	Test Conditions		Frequency(Hz)	Deviation(%)	Limit	Verdict
	Power (VDC)	Temperature (°C)				
100	3.8	+20°C(Ref)	13560753	0.00555	±0.01%	PASS
100		-20	13560754	0.00556	±0.01%	
100		-10	13560755	0.00557	±0.01%	
100		0	13560755	0.00557	±0.01%	
100		10	13560754	0.00556	±0.01%	
100		20	13560753	0.00555	±0.01%	
100		25	13560754	0.00556	±0.01%	
100		30	13560753	0.00555	±0.01%	
100		40	13560752	0.00555	±0.01%	
100		50	13560751	0.00554	±0.01%	
Battery End Point		4.35	20	13560754	0.00556	
115	3.7	20	13560752	0.00555	±0.01%	

6. 20DB BANDWIDTH

6.1 LIMIT

According to FCC section 15.215(c), the 20dB bandwidth should be contained within the frequency band designated in the rule section under which the EUT is operated, it was measured with a spectrum analyzer connected the EUT while the EUT is operating in transmission mode.

6.2 TEST PROCEDURE

Intentional radiators operating under the alternative provisions to the general emission limits, as contained in §13.553-13.567 MHz and in subpart E of this part, must be designed to ensure that the 20 dB bandwidth of the emission, or whatever bandwidth may otherwise be specified in the specific rule section under which the equipment operates, is contained within the frequency band designated in the rule section under which the equipment is operated. In the case of intentional radiators operating under the provisions of subpart E, the emission bandwidth may span across multiple contiguous frequency bands identified in that subpart. The requirement to contain the designated bandwidth of the emission within the specified frequency band includes the effects from frequency sweeping, frequency hopping and other modulation techniques that may be employed as well as the frequency stability of the transmitter over expected variations in temperature and supply voltage. If a frequency stability is not specified in the regulations, it is recommended that the fundamental emission be kept within at least the central 80% of the permitted band in order to minimize the possibility of out-of-band operation.

1. Set RBW = 1 kHz.
2. Set the video Mobile Phonewidth (VBW) ≥ 3 RBW.
3. Detector = Peak.
4. Trace mode = max hold.
5. Sweep = auto couple.
6. Allow the trace to stabilize.
7. Measure the maximum width of the emission that is constrained by the frequencies associated with the two outermost amplitude points (upper and lower frequencies) that are attenuated by 6 dB relative to the maximum level measured in the fundamental emission.

6.3 TEST SETUP

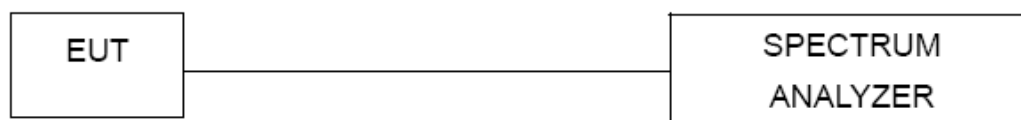

6.4 EUT OPERATION CONDITIONS

Please refer to section 3.4 of this report.



6.5 TEST RESULTS

Temperature:	25 °C	Relative Humidity:	60%
Test Voltage:	DC 3.8V	Test Mode:	TX Mode

13.56MHz

Centre Frequency	Measurement		
	20dB Bandwidth (KHz)	99% Bandwidth (KHz)	Frequency Range (MHz)
13.56MHz	0.251	0.216	13.553-13.567

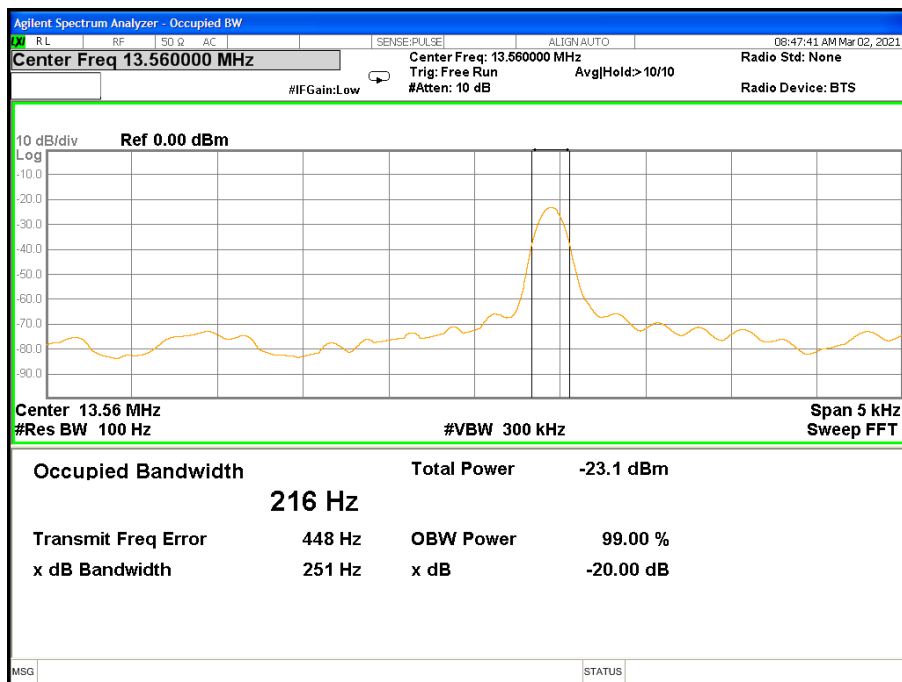



7. ANTENNA REQUIREMENT

7.1 STANDARD REQUIREMENT

15.203 requirement: For intentional device, according to 15.203: an intentional radiator shall be designed to ensure that no antenna other than that furnished by the responsible party shall be used with the device.

7.2 EUT ANTENNA

The EUT antenna is coil Antenna. It comply with the standard requirement.





APPENDIX 1- PHOTOS OF TEST SETUP

Note: See test photos in setup photo document for the actual connections between Product and support equipment.

*****END OF THE REPORT*****

