



**Shenzhen CTA Testing Technology Co., Ltd.**

Room 106, Building 1, Yibaolai Industrial Park, Qiaotou Community, Fuhai Street, Bao'an District, Shenzhen, China

# TEST REPORT

**47 CFR FCC Part 15 Subpart B (Class B)**

**Radio Frequency Devices – Unintentional Radiators – Limits and methods of measurement**

**ANSI C63.4: 2014**

**American National Standard for Methods of Measurement of Radio-Noise Emissions from Low-Voltage Electrical and Electronic Equipment in the Range of 9 kHz to 40 GHz**

Report Reference No.....: **CTA22113000301**

FCC ID..... : **2AONQ-16146**

Compiled by

( position+printed name+signature)..: File administrators Zoey Cao

Supervised by

( position+printed name+signature)..: Project Engineer Amy Wen

Approved by

( position+printed name+signature)..: RF Manager Eric Wang

*Zoey Cao*

*Amy Wen*

*Eric Wang*

Date of issue.....: Dec. 14, 2022

Testing Laboratory Name .....: **Shenzhen CTA Testing Technology Co., Ltd.**

Address.....: Room 106, Building 1, Yibaolai Industrial Park, Qiaotou Community, Fuhai Street, Bao'an District, Shenzhen, China

Applicant's name .....: **Stage10 GmbH**

Address.....: Oranienburgerstr. 45 10117 Berlin Germany

Test specification ..... :

Standard.....: **47 CFR FCC Part 15 Subpart B (Class B)**  
**ANSI C63.4: 2014**

**Shenzhen CTA Testing Technology Co., Ltd. All rights reserved.**

This publication may be reproduced in whole or in part for non-commercial purposes as long as the Shenzhen CTA Testing Technology Co., Ltd. is acknowledged as copyright owner and source of the material. Shenzhen CTA Testing Technology Co., Ltd. takes no responsibility for and will not assume liability for damages resulting from the reader's interpretation of the reproduced material due to its placement and context.

Equipment description.....: **PetTec Plush Pet Toy Brown Squirrel**

Trade Mark .....: PetTec

Manufacturer .....: PetFolio (Nanjing) Intelligence Technology Co., LTD.

Model/Type reference.....: 16146

List Model .....: N/A

Ratings.....: DC 3.7V From Battery and DC 5.0V From external circuit

Result.....: **PASS**

**Shenzhen CTA Testing Technology Co., Ltd.**

Room 106, Building 1, Yibaolai Industrial Park, Qiaotou Community, Fuhai Street, Bao'an District, Shenzhen, China  
Tel:+86-755 2322 5875 E-mail:cta@cta-test.cn Web:http://www.cta-test.cn

**TEST REPORT**

Equipment under Test : PetTec Plush Pet Toy Brown Squirrel

Model /Type : 16146

Listed Models : N/A

**Applicant** : **Stage10 GmbH**

Address : Oranienburgerstr. 45 10117 Berlin Germany

**Manufacturer** : **PetFolio (Nanjing) Intelligence Technology Co., LTD.**

Address : Room 507, Building 03, Xingguang Mingzuo Plaza, No. 998  
Chengxin Avenue, Moling Street, Jiangning District, Nanjing,  
China

**Test Result:****PASS**

The test report merely corresponds to the test sample.  
It is not permitted to copy extracts of these test result without the written permission of the test laboratory.

## Contents

<b>1.</b>	<b><u>TEST STANDARDS</u></b> .....	<b>4</b>
<b>2.</b>	<b><u>SUMMARY</u></b> .....	<b>5</b>
2.1.	General Remarks	5
2.2.	Product Description	5
2.3.	EUT operation mode	5
2.4.	EUT configuration	5
2.5.	Modifications	5
<b>3.</b>	<b><u>TEST ENVIRONMENT</u></b> .....	<b>6</b>
3.1.	Address of the test laboratory	6
3.2.	Test Facility	6
3.3.	Environmental conditions	6
3.4.	Test Description	6
3.5.	Statement of the measurement uncertainty	6
3.6.	Equipments Used during the Test	7
<b>4.</b>	<b><u>TEST CONDITIONS AND RESULTS</u></b> .....	<b>9</b>
4.1.	<b>EMISSION</b>	<b>9</b>
4.1.1.	LIMITS OF DISTURBANCE (CLASS B) .....	9
4.1.2.	TEST CONFIGURATION .....	9
4.1.3.	TEST PROCEDURE .....	9
4.1.4.	TEST RESULTS .....	10
4.2.	<b>Conducted Emission</b>	<b>14</b>
4.2.1.	LIMITS OF DISTURBANCE (CLASS B) .....	14
4.2.2.	TEST CONFIGURATION .....	14
4.2.3.	TEST PROCEDURE .....	14
4.2.4.	TEST RESULTS .....	14
<b>5.</b>	<b><u>TEST SET-UP PHOTOS OF THE EUT</u></b> .....	<b>17</b>
<b>6.</b>	<b><u>EXTERNAL AND INTERNAL PHOTOS OF THE EUT</u></b> .....	<b>18</b>

## 1. TEST STANDARDS

The tests were performed according to following standards:

[47 CFR FCC Part 15 Subpart B \(Class B\)](#) Radio Frequency Devices – Unintentional Radiators – Limits and methods of measurement

[ANSI C63.4: 2014](#) American National Standard for Methods of Measurement of Radio-Noise Emissions from Low-Voltage Electrical and Electronic Equipment in the Range of 9 kHz to 40 GHz.

## 2. SUMMARY

### 2.1. General Remarks

Date of receipt of test sample	:	Nov. 30, 2022
Testing commenced on	:	Nov. 30, 2022
Testing concluded on	:	Dec. 14, 2022

### 2.2. Product Description

Product Name:	PetTec Plush Pet Toy Brown Squirrel
Model/Type reference:	16146
Listed Model:	N/A
Power supply:	DC 3.7V From Battery and DC 5.0V From external circuit
Adapter information (Auxiliary test supplied by test Lab) :	Model: EP-TA20CBC Input: AC 100-240V 50/60Hz Output: DC 5V 2A

### 2.3. EUT operation mode

As the function of the EUT, test mode selected to test as below to conform this standard:

Operation mode	Description
Mode 1	Charging+Working

Test item	Test mode
Conducted emission	Mode 1
Radiated emission	Mode 1

### 2.4. EUT configuration

The following peripheral devices(Supplied by the testing Lab) and interface cables were connected during the measurement:

Item	Name	Description	Model	Certificate	Note
1 <sup>Note1</sup>	/	/	/	/	/
2 <sup>Note1</sup>	/	/	/	/	/

Note1: This Auxiliary used during the test is provided by the test laboratory.

### 2.5. Modifications

No modifications were implemented to meet testing criteria

### 3. TEST ENVIRONMENT

#### 3.1. Address of the test laboratory

**Shenzhen CTA Testing Technology Co., Ltd.**

Room 106, Building 1, Yibaolai Industrial Park, Qiaotou Community, Fuhai Street, Bao' an District, Shenzhen, China

#### 3.2. Test Facility

The test facility is recognized, certified, or accredited by the following organizations:

**FCC-Registration No.: 517856 Designation Number: CN1318**

Shenzhen CTA Testing Technology Co., Ltd. has been listed on the US Federal Communications Commission list of test facilities recognized to perform electromagnetic emissions measurements.

**A2LA-Lab Cert. No.: 6534.01**

Shenzhen CTA Testing Technology Co., Ltd. has been listed by American Association for Laboratory Accreditation to perform electromagnetic emission measurement.

The 3m-Semi anechoic test site fulfils CISPR 16-1-4 according to ANSI C63.10 and CISPR 16-1-4:2010.

#### 3.3. Environmental conditions

During the measurement the environmental conditions were within the listed ranges:

Normal Temperature:	15-35 ° C
Lative Humidity	30-60 %
Air Pressure	950-1050mbar

#### 3.4. Test Description

Emission Measurement		
Radiated Emission	47 CFR FCC Part 15 Subpart B Class B ANSI C63.4 2014	PASS
Conducted Emission	47 CFR FCC Part 15 Subpart B Class B ANSI C63.4 2014	PASS

Remark:1. N/A means "not applicable".

2.The measurement uncertainty is not included in the test result.

#### 3.5. Statement of the measurement uncertainty

The data and results referenced in this document are true and accurate. The reader is cautioned that there may be errors within the calibration limits of the equipment and facilities. The measurement uncertainty was calculated for all measurements listed in this test report acc. to TR-100028-01" Electromagnetic compatibility and Radio spectrum Matters (ERM);Uncertainties in the measurement of mobile radio equipment characteristics; Part 1" and TR-100028-02 "Electromagnetic compatibility and Radio spectrum Matters (ERM);Uncertainties in the measurement of mobile radio equipment characteristics; Part 2 " and is documented in the Shenzhen CTA Testing Technology Co., Ltd. quality system acc. to DIN EN ISO/IEC 17025. Furthermore, component and process variability of devices similar to that tested may result in additional deviation. The manufacturer has the sole responsibility of continued compliance of the device.

Hereafter the best measurement capability for Shenzhen CTA Testing Technology Co., Ltd. :

**Shenzhen CTA Testing Technology Co., Ltd.**

Room 106, Building 1, Yibaolai Industrial Park, Qiaotou Community, Fuhai Street, Bao'an District, Shenzhen, China  
Tel:+86-755 2322 5875 E-mail:cta@cta-test.cn Web:http://www.cta-test.cn

Test	Range	Measurement Uncertainty	Notes
Radiated Emission	30~1000MHz	4.06 dB	(1)
Radiated Emission	1~18GHz	5.14 dB	(1)
Conducted Disturbance	0.15~30MHz	2.14 dB	(1)

(1) This uncertainty represents an expanded uncertainty expressed at approximately the 95% confidence level using a coverage factor of k=2.

### 3.6. Equipments Used during the Test

Radiated Emission						
Item	Test Equipment	Manufacturer	Model No.	Equipment No.	Last Cal.	Cal.Due
1	ULTRA-BROADBAND ANTENNA	Schwarzbeck	VULB9163	CTA-310	2021/08/07	2024/08/06
2	EMI Test Receiver	ROHDE & SCHWARZ	ESCI	CTA-306	2022/08/03	2023/08/02
3	Horn Antenna	Schwarzbeck	BBHA 9120D	CTA-309	2021/08/07	2024/08/06
4	Universal Radio Communication	CMW500	R&S	CTA-302	2022/08/03	2023/08/02
5	Band-reject filter	Xi'an Xingbo Technology Co.,Ltd	XBLBQ-DZA66	CTA-410	2022/08/03	2023/08/02
6	Band-reject filter	Xi'an Xingbo Technology Co.,Ltd	XBLBQ-DZA64	CTA-411	2022/08/03	2023/08/02
7	Band-reject filter	Xi'an Xingbo Technology Co.,Ltd	XBLBQ-DZA63	CTA-411	2022/08/03	2023/08/02
8	High-pass filter	Xi'an Xingbo Technology Co.,Ltd	XBLBQ-GTA10	CTA-412	2022/08/03	2023/08/02
9	High-pass filter	Xi'an Xingbo Technology Co.,Ltd	XBLBQ-GTA18	CTA-402	2022/08/03	2023/08/02
10	EMI Test Software	Tonscend	TS@JS32-RE	N/A	N/A	N/A

Conducted Emission						
Item	Test Equipment	Manufacturer	Model No.	Equipment No.	Last Cal.	Cal.Due
1	EMI Test Receiver	R&S	ESPI	CTA-307	2022/08/03	2023/08/02
2	Artificial Mains	R&S	ENV-216	CTA-308	2022/08/03	2023/08/02
3	Artificial Mains	R&S	ENV-216	CTA-314	2022/08/03	2023/08/02
4	ISN	Schwarzbeck	NTFM8158	CTA-407	2022/08/03	2023/08/02
5	ISN	Schwarzbeck	CAT58158	CTA-408	2022/08/03	2023/08/02
6	ISN	Schwarzbeck	CAT38158	CTA-409	2022/08/03	2023/08/02
7	Universal Radio Communication	R&S	CMW500	CTA-302	2022/08/03	2023/08/02
8	EMI Test Software	Tonscend	TS@JS32-CE	N/A	N/A	N/A



## 4. TEST CONDITIONS AND RESULTS

### 4.1. EMISSION

#### 4.1.1. LIMITS OF DISTURBANCE (CLASS B)

Frequency (MHz)	Distance (Meters)	Field Strengths Limits (dB $\mu$ V/m)
30 ~ 88	3	40
88~216	3	43.5
216 ~ 960	3	46
Above 960(AV)	3	54
Above 960(PK)	3	74

Note: (1) The tighter limit shall apply at the edge between two frequency bands.

(2) Distance refers to the distance in meters between the test instrument antenna and the closest point of any part of the E.U.T.

#### 4.1.2. TEST CONFIGURATION

a) Radiated emission test set-up, frequency below 1000MHz:

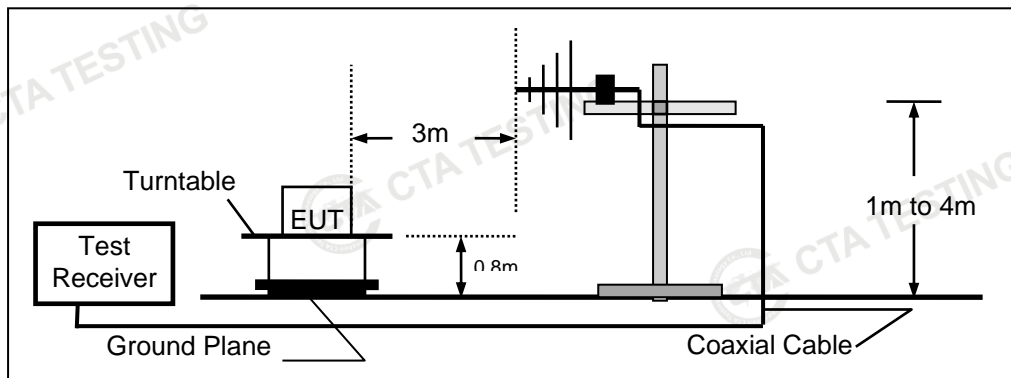

b) Radiated emission test set-up, frequency above 1000MHz

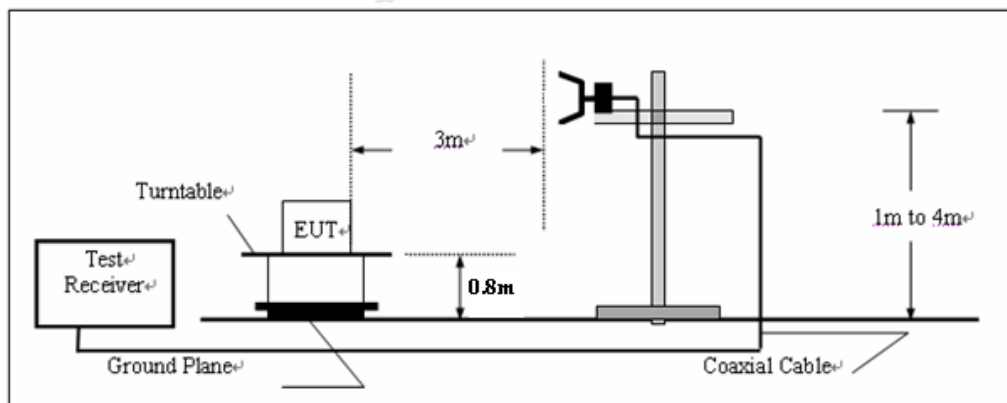

#### 4.1.3. TEST PROCEDURE

EUT is tested in Semi-Anechoic Chamber. EUT is placed on a nonmetal table which is 0.8 meter above a grounded turntable. The turntable can rotate 360 degrees to determine the azimuth of the maximum emission level. EUT is set 3 meters away from the center of receiving antenna. The antenna can move up and down from 1 to 4 meter to find out the maximum emission level. Both horizontal and vertical polarizations of the antenna are set on the test.

Shenzhen CTA Testing Technology Co., Ltd.

Room 106, Building 1, Yibaolai Industrial Park, Qiaotou Community, Fuhai Street, Bao'an District, Shenzhen, China  
 Tel:+86-755 2322 5875 E-mail:cta@cta-test.cn Web:http://www.cta-test.cn

4.1.4. TEST RESULTS

Passed

Please refer to the below test data:

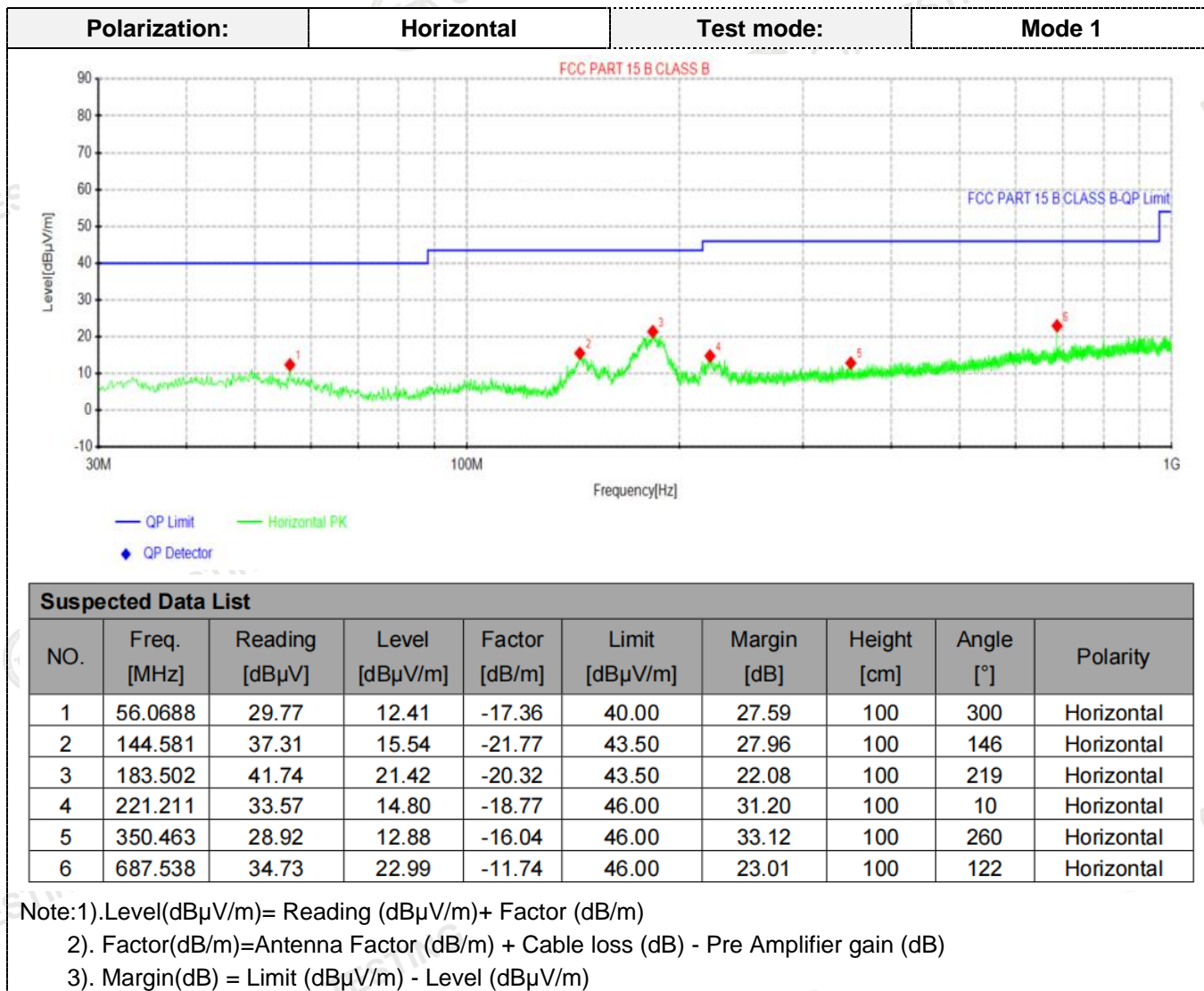

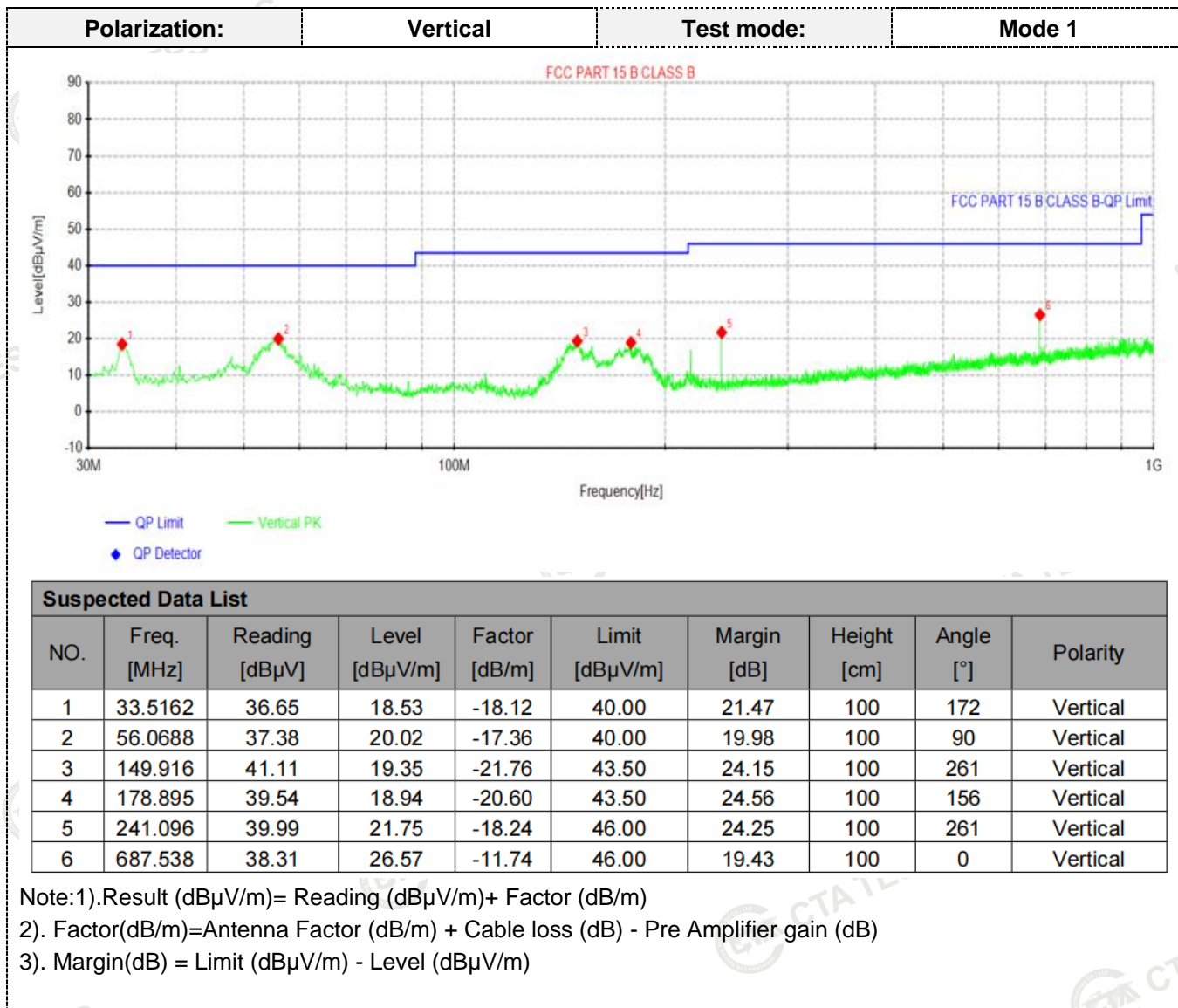

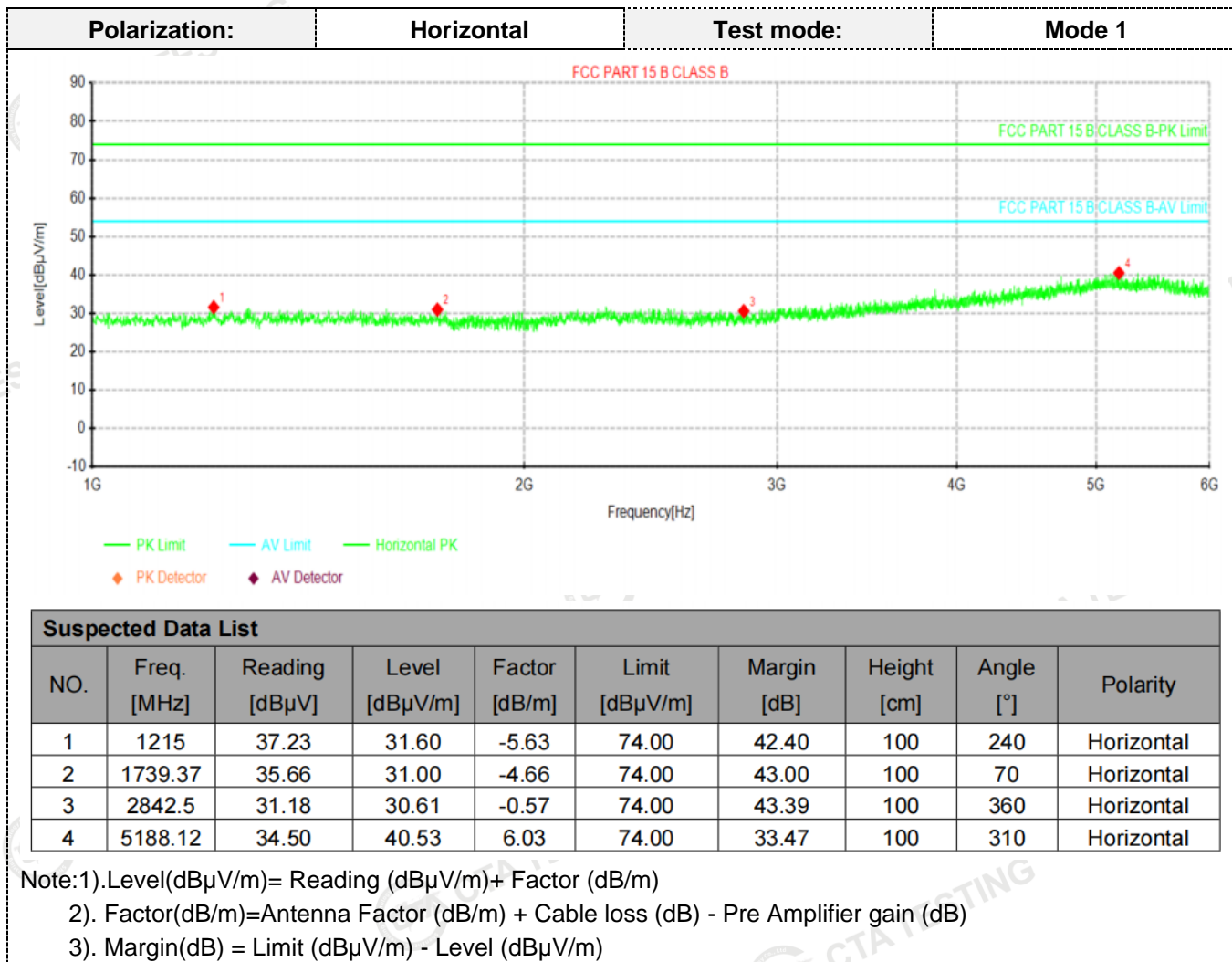

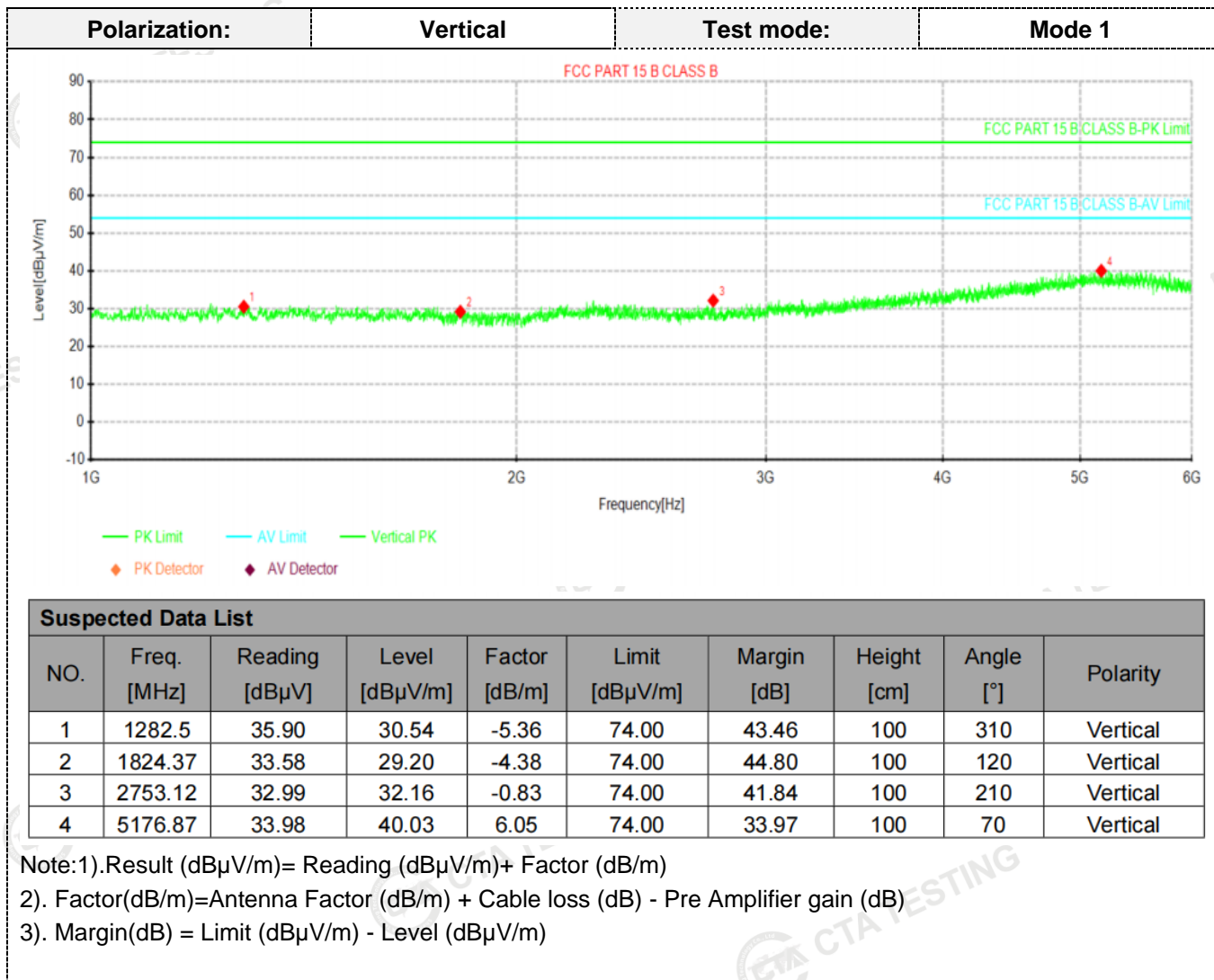

## 4.2. Conducted Emission

### 4.2.1. LIMITS OF DISTURBANCE (CLASS B)

Frequency Range (MHz)	Limits (dBuV)	
	Quasi-Peak	Average
0.150~0.500	66~56	56~46
0.500~5.000	56	46
5.000~30.000	60	50

Note: (1) The tighter limit shall apply at the edge between two frequency bands.

### 4.2.2. TEST CONFIGURATION

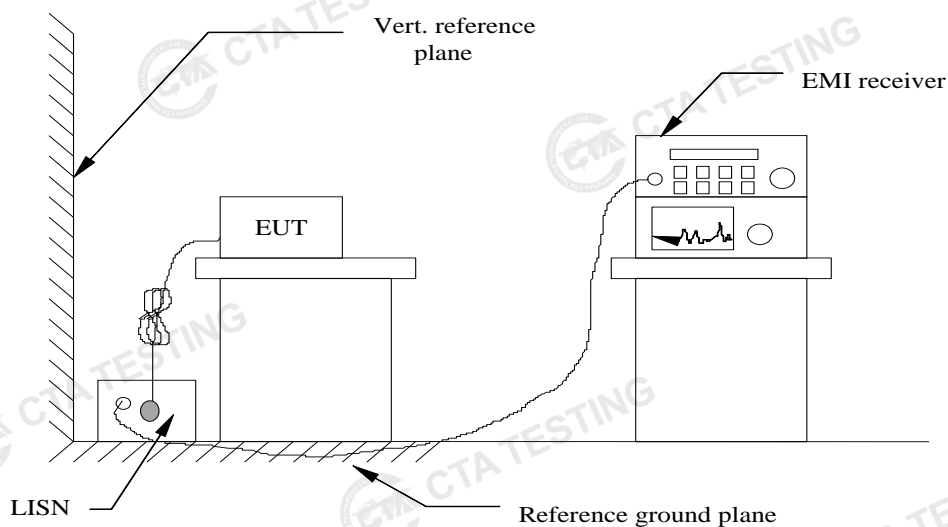

### 4.2.3. TEST PROCEDURE

EUT is placed on a nonmetal table which is 0.8 meter (or 0.1 meter for floor-stood equipments) above the grounded reference plane. Connect the power line of the EUT to the LISN. Voltage of the power supply is varied over a range of 0.9 to 1.1 times of the rated voltage in order to check whether the level of disturbance varies considerably with the supply voltage at the selected frequency about 160KHz. Perform an initial measurement on each line with peak detector to identify the frequencies where the maximum disturbances may occur. Then measure and record the maximum disturbances with quasi-peak and average detector.

### 4.2.4. TEST RESULTS

Passed

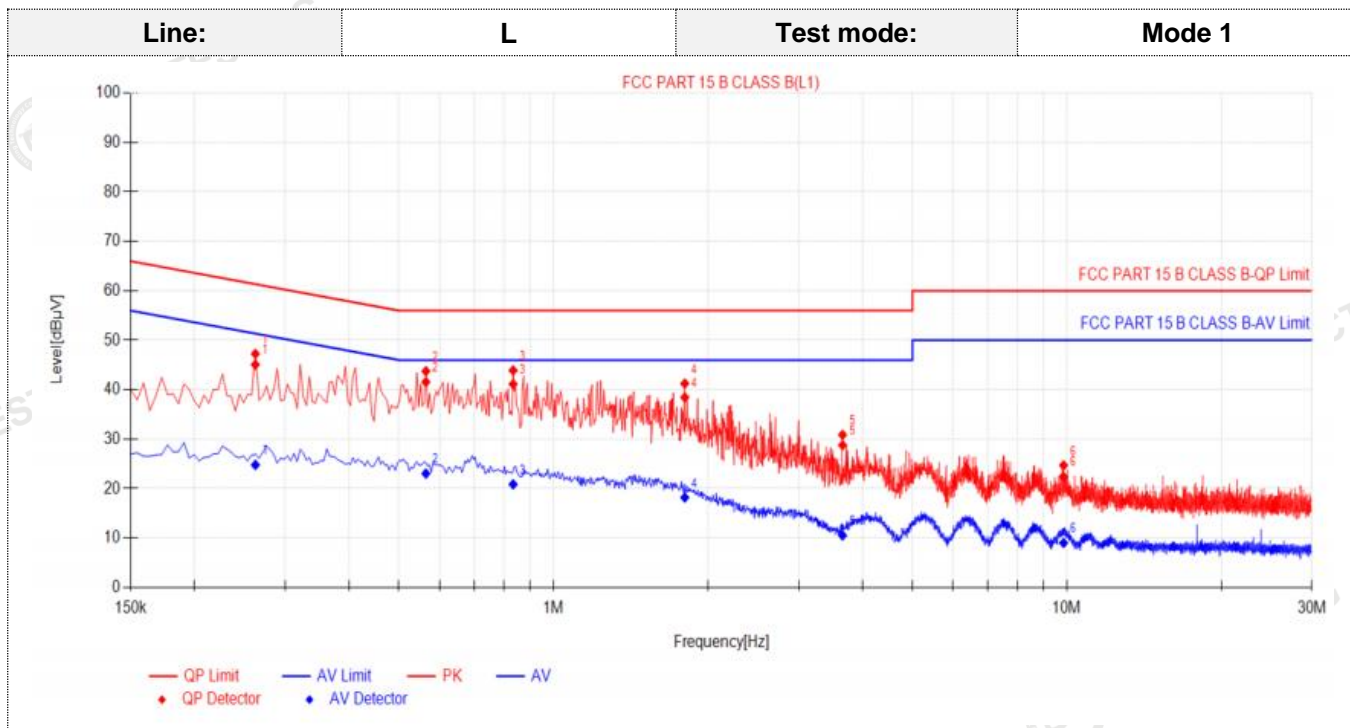

### Final Data List

NO.	Freq. [MHz]	Factor [dB]	QP Reading[dB µV]	QP Value [dBµV]	QP Limit [dBµV]	QP Margin [dB]	AV Reading [dBµV]	AV Value [dBµV]	AV Limit [dBµV]	AV Margin [dB]	Verdict
1	0.2625	10.50	34.57	45.07	61.35	16.28	14.29	24.79	51.35	26.56	PASS
2	0.564	10.50	31.06	41.56	56.00	14.44	12.53	23.03	46.00	22.97	PASS
3	0.834	10.50	30.62	41.12	56.00	14.88	10.35	20.85	46.00	25.15	PASS
4	1.8015	10.50	27.95	38.45	56.00	17.55	7.68	18.18	46.00	27.82	PASS
5	3.6555	10.50	18.27	28.77	56.00	27.23	0.01	10.51	46.00	35.49	PASS
6	9.852	10.50	11.89	22.39	60.00	37.61	-1.50	9.00	50.00	41.00	PASS

Note:1).Result (dBµV/m)= Reading (dBµV/m)+ Factor (dB/m)  
 2). Factor(dB/m)=Cable loss (dB) + LISN Factor (dB)

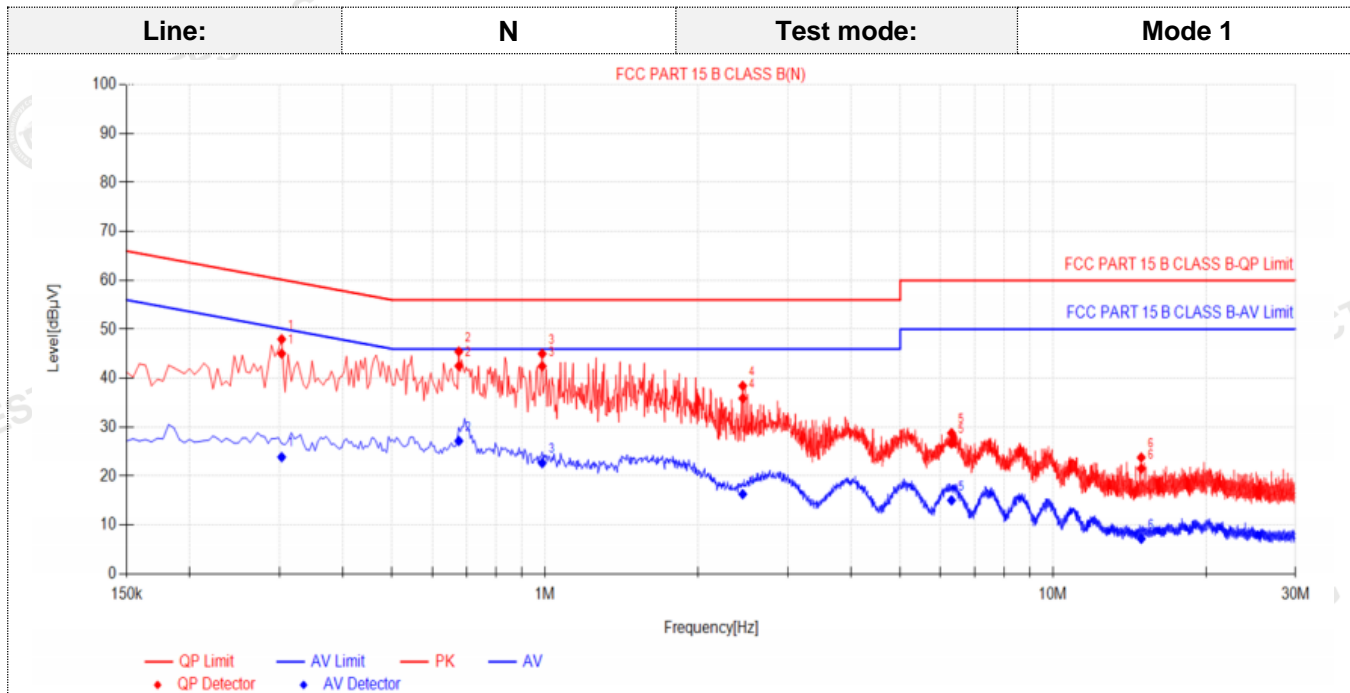

**Final Data List**

NO.	Freq. [MHz]	Factor [dB]	QP Reading [dBµV]	QP Value [dBµV]	QP Limit [dBµV]	QP Margin [dB]	AV Reading [dBµV]	AV Value [dBµV]	AV Limit [dBµV]	AV Margin [dB]	Verdict
1	0.303	10.50	34.53	45.03	60.16	15.13	13.37	23.87	50.16	26.29	PASS
2	0.6765	10.50	32.02	42.52	56.00	13.48	16.67	27.17	46.00	18.83	PASS
3	0.987	10.50	31.96	42.46	56.00	13.54	12.16	22.66	46.00	23.34	PASS
4	2.4495	10.50	25.39	35.89	56.00	20.11	5.80	16.30	46.00	29.70	PASS
5	6.3105	10.50	16.14	26.64	60.00	33.36	4.54	15.04	50.00	34.96	PASS
6	14.9145	10.50	11.02	21.52	60.00	38.48	-3.33	7.17	50.00	42.83	PASS

Note:1).Result (dBµV/m)= Reading (dBµV/m)+ Factor (dB/m)  
 2). Factor(dB/m)=Cable loss (dB) + LISN Factor (dB)



### 5. Test Set-up Photos of the EUT

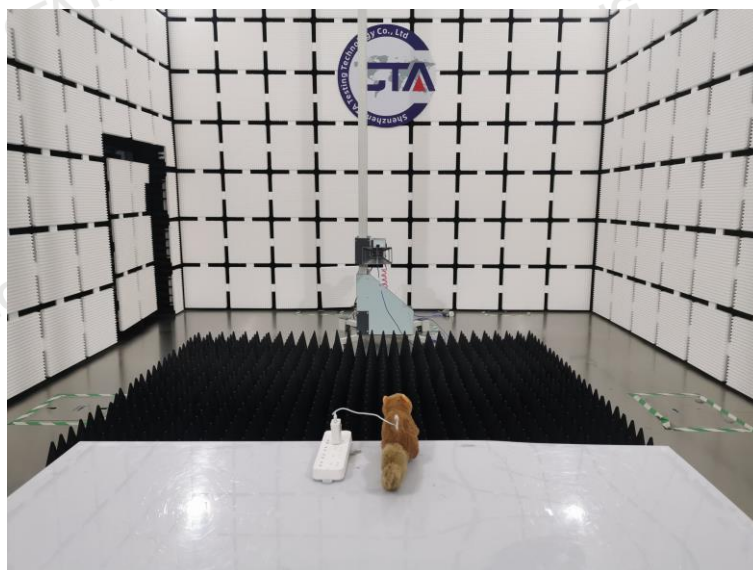

**Shenzhen CTA Testing Technology Co., Ltd.**

Room 106, Building 1, Yibaolai Industrial Park, Qiaotou Community, Fuhai Street, Bao'an District, Shenzhen, China  
Tel:+86-755 2322 5875 E-mail:cta@cta-test.cn Web:http://www.cta-test.cn

## 6. External and Internal Photos of the EUT



Shenzhen CTA Testing Technology Co., Ltd.

Room 106, Building 1, Yibaolai Industrial Park, Qiaotou Community, Fuhai Street, Bao'an District, Shenzhen, China

Tel:+86-755 2322 5875 E-mail:cta@cta-test.cn Web:http://www.cta-test.cn

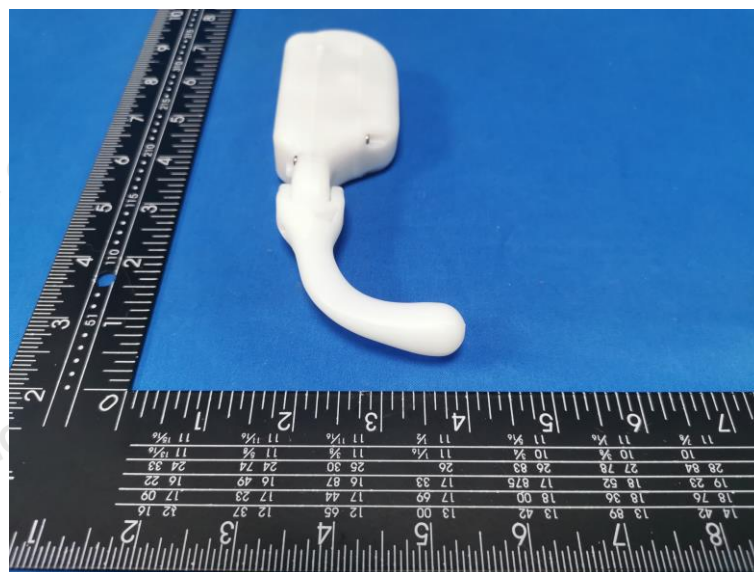



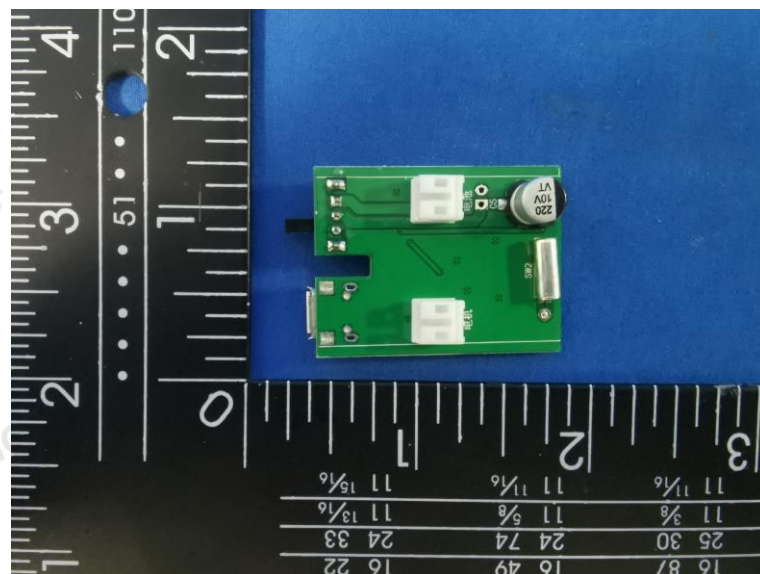
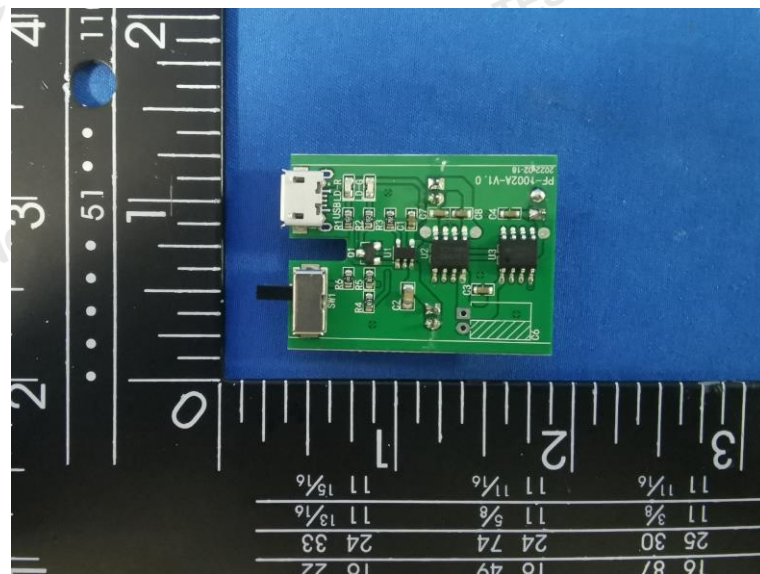
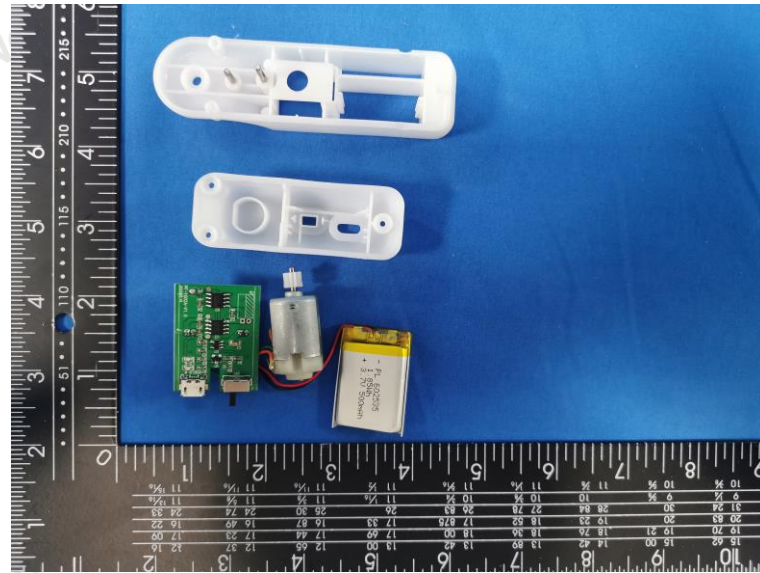

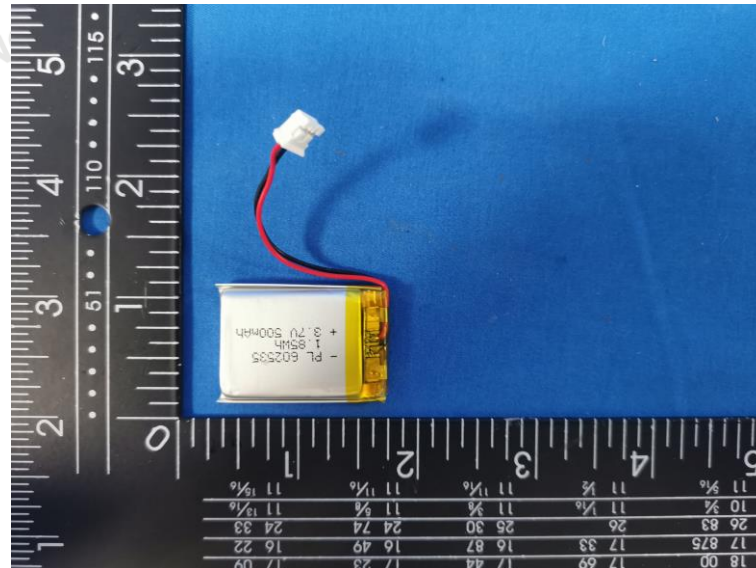

\*\*\*\*\*End of Report\*\*\*\*\*