

4

3

2

1

Label Artwork and Location

Model: 8806

Size and Location:

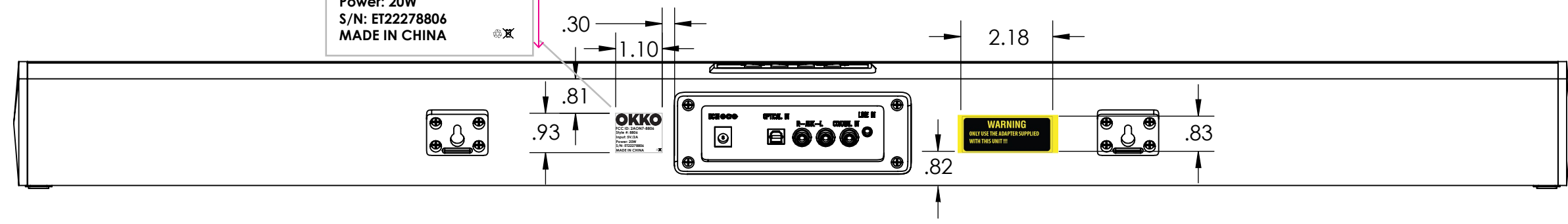
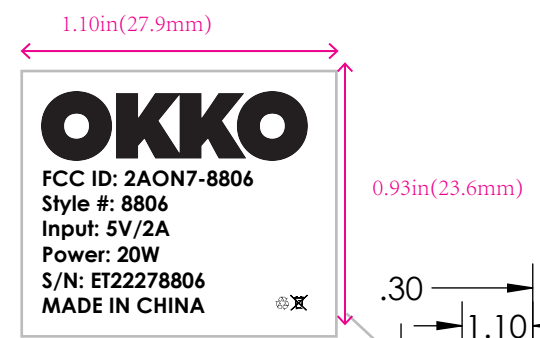

B

A

A

4

3

2

1

4

3

2

1

B

B

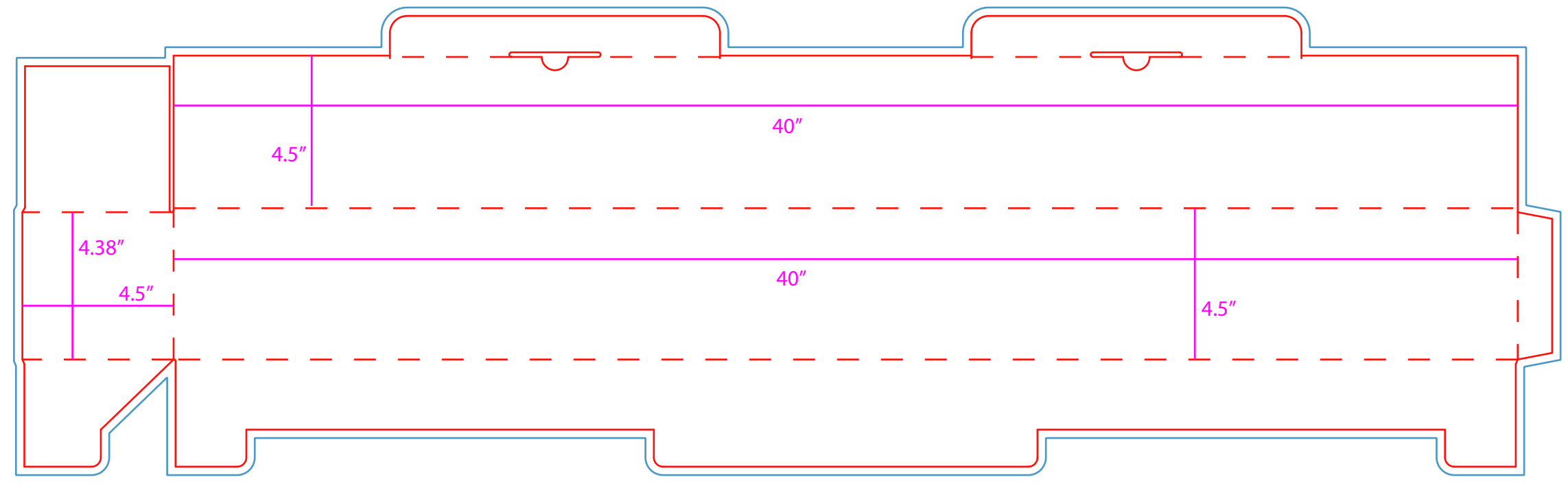

A

A

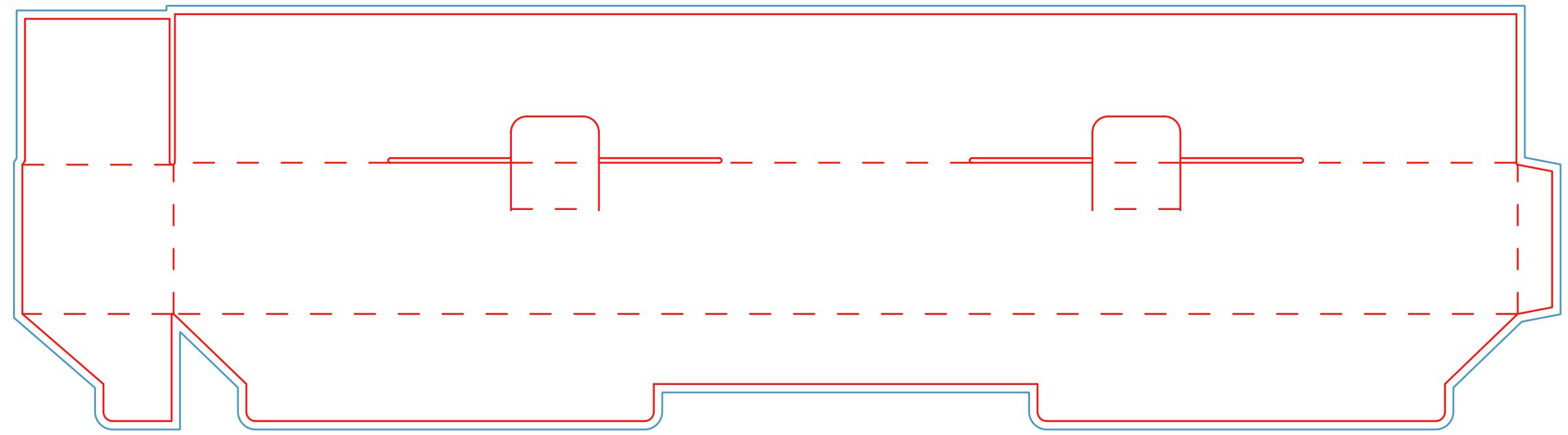

4

3

2

1



PROPRIETARY AND CONFIDENTIAL
 THE INFORMATION CONTAINED IN THIS DRAWING IS THE SOLE PROPERTY OF TZUMI ELECTRONICS. ANY REPRODUCTION IN PART OR AS A WHOLE WITHOUT THE WRITTEN PERMISSION OF TZUMI ELECTRONICS IS PROHIBITED.

UNLESS OTHERWISE SPECIFIED:		NAME	DATE
DIMENSIONS ARE IN INCHES TOLERANCES: FRACTIONAL ± ANGULAR: MACH ± BEND ± TWO PLACE DECIMAL ± THREE PLACE DECIMAL ±	DRAWN		6/16/2022
	CHECKED		
	ENG APPR.		
	MFG APPR.		
	Q.A.		
COMMENTS:			
MATERIAL			
FINISH			
DO NOT SCALE DRAWING			

TITLE:
8806_OKKO_Soundbar_DIMS

SIZE	DWG. NO.	REV
B		
WEIGHT:		SHEET 1 OF 1

4

3

2

1

B

B

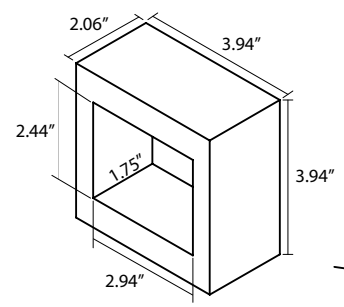

Foam End caps for unit inside packaging

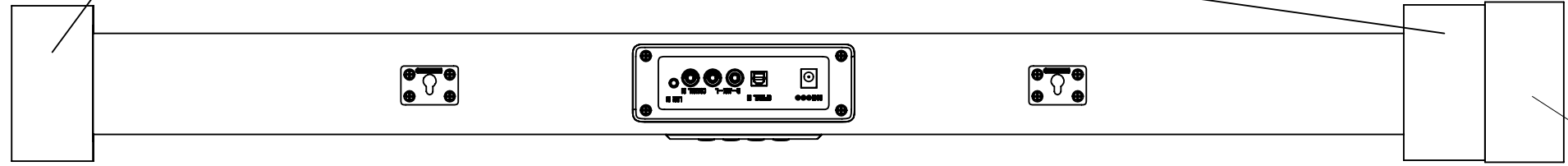

Box for remote and adapter

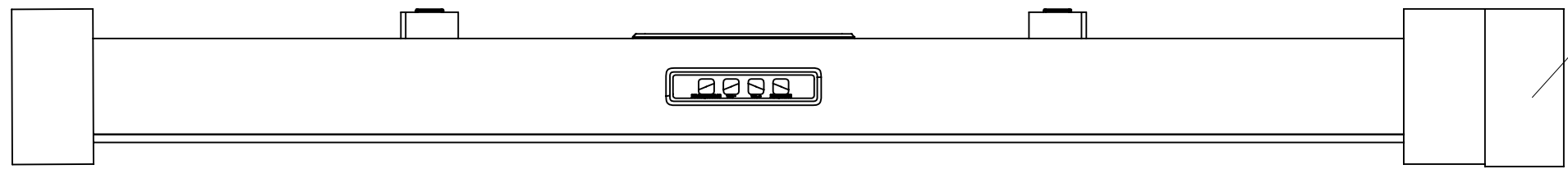

PROPRIETARY AND CONFIDENTIAL
 THE INFORMATION CONTAINED IN THIS DRAWING IS THE SOLE PROPERTY OF TZUMI ELECTRONICS. ANY REPRODUCTION IN PART OR AS A WHOLE WITHOUT THE WRITTEN PERMISSION OF TZUMI ELECTRONICS IS PROHIBITED.

UNLESS OTHERWISE SPECIFIED:		NAME	DATE
DIMENSIONS ARE IN INCHES	DRAWN		6/22/2022
TOLERANCES:	CHECKED		
FRACTIONAL ±	ENG APPR.		
ANGULAR: MACH ± BEND ±	MFG APPR.		
TWO PLACE DECIMAL ±	Q.A.		
THREE PLACE DECIMAL ±	COMMENTS:		

MATERIAL

FINISH

DO NOT SCALE DRAWING

TITLE:
 8806_OKKO_Soundbar_DIMS

SIZE	DWG. NO.	REV
B		

SCALE: 1:4 WEIGHT: SHEET 1 OF 1

4

3

2

1

A

A