



TEST REPORT

Applicant Name : TZUMI Electronics, LLC
 Address : 16 EAST 34TH STREET 16TH FLOOR, NEW YORK, New York,
 United States,10016
 Report Number : SZNS1220418-14554E-RF
 FCC ID: 2AON7-8226

Test Standard (s)
 FCC PART 15.247

Sample Description

Product Type: Bluetooth Speaker
 Tested Model: 8226
 Trade Mark: Tzumi
 Date Received: 2022-04-18
 Date of Test: 2022-04-19 to 2022-04-25
 Report Date: 2022-04-27

Test Result:	Pass*
--------------	-------

* In the configuration tested, the EUT complied with the standards above.

Prepared and Checked By:

Black Ding

Black Ding
 EMC Engineer

Approved By:

Candy Li

Candy Li
 EMC Engineer

Note: This report may contain data that are not covered by the A2LA accreditation and are marked with an asterisk “★”.

Shenzhen Accurate Technology Co., Ltd. is not responsible for the authenticity of any test data provided by the applicant. Data included from the applicant that may affect test results are marked with an asterisk “★”. Customer model name, addresses, names, trademarks etc. are not considered data.

This report cannot be reproduced except in full, without prior written approval of the Company. Unless otherwise stated the results shown in this test report refer only to the sample(s) tested. This report is valid only with a valid digital signature. The digital signature may be available only under the Adobe software above version 7.0.

Shenzhen Accurate Technology Co., Ltd.

1/F., Building A, Changyuan New Material Port, Science & Industry Park, Nanshan District, Shenzhen, Guangdong, P.R. China
 Tel: +86 755-26503290 Fax: +86 755-26503396 Web: www.atc-lab.com

TABLE OF CONTENTS

GENERAL INFORMATION	4
PRODUCT DESCRIPTION FOR EQUIPMENT UNDER TEST (EUT)	4
OBJECTIVE	4
TEST METHODOLOGY	4
MEASUREMENT UNCERTAINTY	5
TEST FACILITY	5
SYSTEM TEST CONFIGURATION	6
DESCRIPTION OF TEST CONFIGURATION	6
EUT EXERCISE SOFTWARE	6
SPECIAL ACCESSORIES	6
EQUIPMENT MODIFICATIONS	6
SUPPORT EQUIPMENT LIST AND DETAILS	6
BLOCK DIAGRAM OF TEST SETUP	7
SUMMARY OF TEST RESULTS	8
TEST EQUIPMENT LIST	9
FCC §1.1310 & §2.1091 –MAXIMUM PERMISSIBLE EXPOSURE (MPE)	10
TEST RESULT:	10
FCC §15.203 – ANTENNA REQUIREMENT	11
APPLICABLE STANDARD	11
ANTENNA CONNECTOR CONSTRUCTION	11
FCC §15.207 (a) – AC LINE CONDUCTED EMISSIONS	12
APPLICABLE STANDARD	12
EUT SETUP	12
EMI TEST RECEIVER SETUP	12
TEST PROCEDURE	13
FACTOR & MARGIN CALCULATION	13
TEST DATA	13
FCC §15.205, §15.209 & §15.247(d) – RADIATED EMISSIONS	16
APPLICABLE STANDARD	16
EUT SETUP	16
EMI TEST RECEIVER & SPECTRUM ANALYZER SETUP	17
TEST PROCEDURE	17
FACTOR & MARGIN CALCULATION	17
TEST DATA	17
FCC §15.247(a) (1)-CHANNEL SEPARATION TEST	23
APPLICABLE STANDARD	23
TEST PROCEDURE	23
TEST DATA	23
FCC §15.247(a) (1) – 20 dB EMISSION BANDWIDTH & 99% OCCUPIED BANDWIDTH	26
APPLICABLE STANDARD	26
TEST PROCEDURE	26
TEST DATA	27
FCC §15.247(a) (1) (iii)-QUANTITY OF HOPPING CHANNEL TEST	37
APPLICABLE STANDARD	37

TEST PROCEDURE	37
TEST DATA	37
FCC §15.247(a) (1) (iii) - TIME OF OCCUPANCY (DWELL TIME).....	40
APPLICABLE STANDARD	40
TEST PROCEDURE	40
TEST DATA	40
FCC §15.247(b) (1) - PEAK OUTPUT POWER MEASUREMENT.....	50
APPLICABLE STANDARD	50
TEST PROCEDURE	50
TEST DATA	50
FCC §15.247(d) - BAND EDGES TESTING	56
APPLICABLE STANDARD	56
TEST PROCEDURE	56
TEST DATA	56

GENERAL INFORMATION

Product Description for Equipment under Test (EUT)

Product	Bluetooth Speaker
Tested Mode	8226
Frequency Range	2402~2480MHz
Maximum conducted Peak output power	4.58dBm
Modulation Technique	BDR(GFSK)/EDR(π /4-DQPSK)/EDR(8DPSK)
Antenna Specification*	Internal PCB Antenna:-0.68dBi(provided by the applicant)
Voltage Range	DC3.7V from battery or DC 5V from USB port
Sample number	SZNS1220418-14554E-RF-S1
Sample/EUT Status	Good condition

Objective

This test report is in accordance with Part 2-Subpart J, Part 15-Subparts A and C of the Federal Communication Commission rules.

The tests were performed in order to determine compliance with FCC Part 15, Subpart C, section 15.203, 15.205, 15.207, 15.209 and 15.247 rules.

Test Methodology

All measurements contained in this report were conducted with ANSI C63.10-2013, American National Standard of Procedures for Compliance Testing of Unlicensed Wireless Devices.

All emissions measurement was performed at Shenzhen Accurate Technology Co., Ltd. The radiated testing was performed at an antenna-to-EUT distance of 3 meters.

Measurement Uncertainty

Parameter		Uncertainty
Occupied Channel Bandwidth		5%
RF output power, conducted		0.73dB
Unwanted Emission, conducted		1.6dB
AC Power Lines Conducted Emissions		2.72dB
Emissions, Radiated	30MHz - 1GHz	4.28dB
	1GHz - 18GHz	4.98dB
	18GHz - 26.5GHz	5.06dB
Temperature		1°C
Humidity		6%
Supply voltages		0.4%

Note: The extended uncertainty given in this report is obtained by combining the standard uncertainty times the coverage factor K with the 95% confidence interval. Otherwise required by the applicant or Product Regulations, Decision Rule in this report did not consider the uncertainty.

Test Facility

The test site used by Shenzhen Accurate Technology Co., Ltd. to collect test data is located on the 1/F., Building A, Changyuan New Material Port, Science & Industry Park, Nanshan District, Shenzhen, Guangdong, P.R. China.

The test site has been approved by the FCC under the KDB 974614 D01 and is listed in the FCC Public Access Link (PAL) database, FCC Registration No.: 708358, the FCC Designation No.: CN1189. Accredited by American Association for Laboratory Accreditation (A2LA) The Certificate Number is 429 7.01.

Listed by Innovation, Science and Economic Development Canada (ISED), the Registration Number is 5077A.

SYSTEM TEST CONFIGURATION

Description of Test Configuration

The system was configured for testing in an engineering mode.

EUT Exercise Software

Software "BT_Tool"* was used during testing and the power level was Power level 0*.

Special Accessories

N/A.

Equipment Modifications

No modification was made to the EUT tested.

Support Equipment List and Details

Manufacturer	Description	Model	Serial Number
HUAWEI	Adapter	HW-050100C01	H779KBK6V19398
Lenovo	Lenovo Mobile Phone	Lenovo A7020a48	0560
Unknown	U Disk	Unknown	Unknown

External I/O Cable

Cable Description	Length (m)	From/Port	To
Un-shielding Detachable USB Cable	0.5	EUT	Adapter
Un-shielding Detachable AUX IN Cable	0.5	EUT	Phone

Block Diagram of Test Setup

For conducted emission:

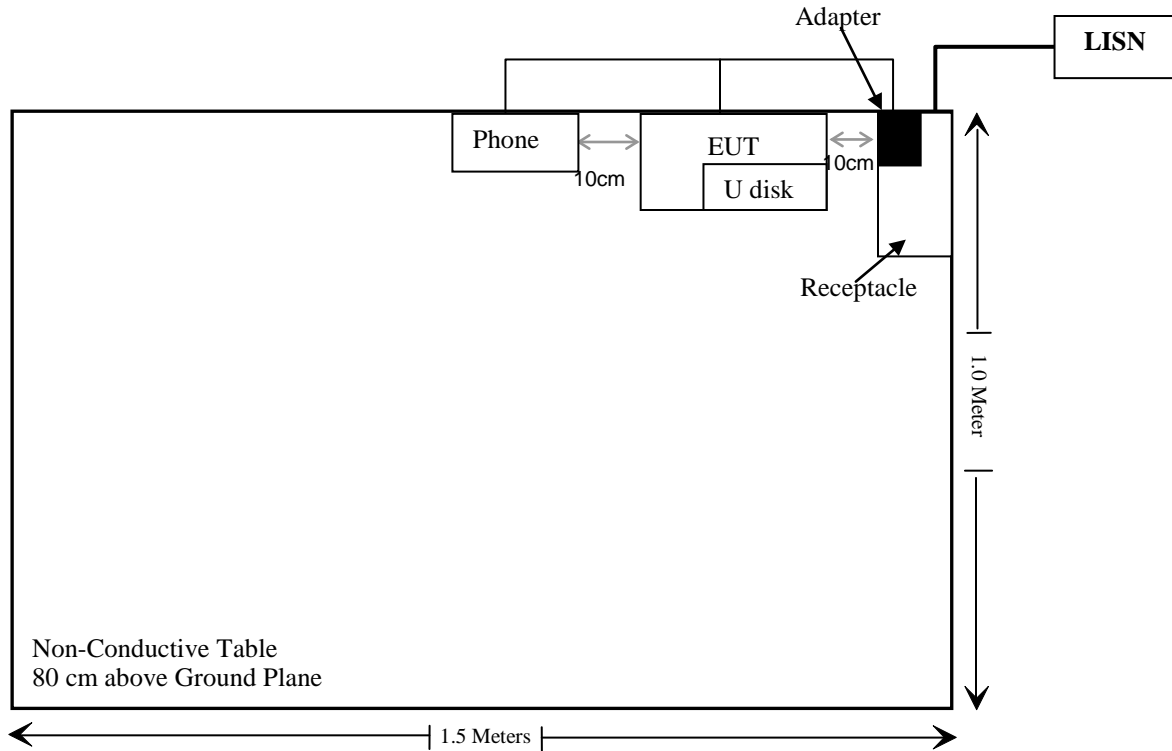

For radiated emission:

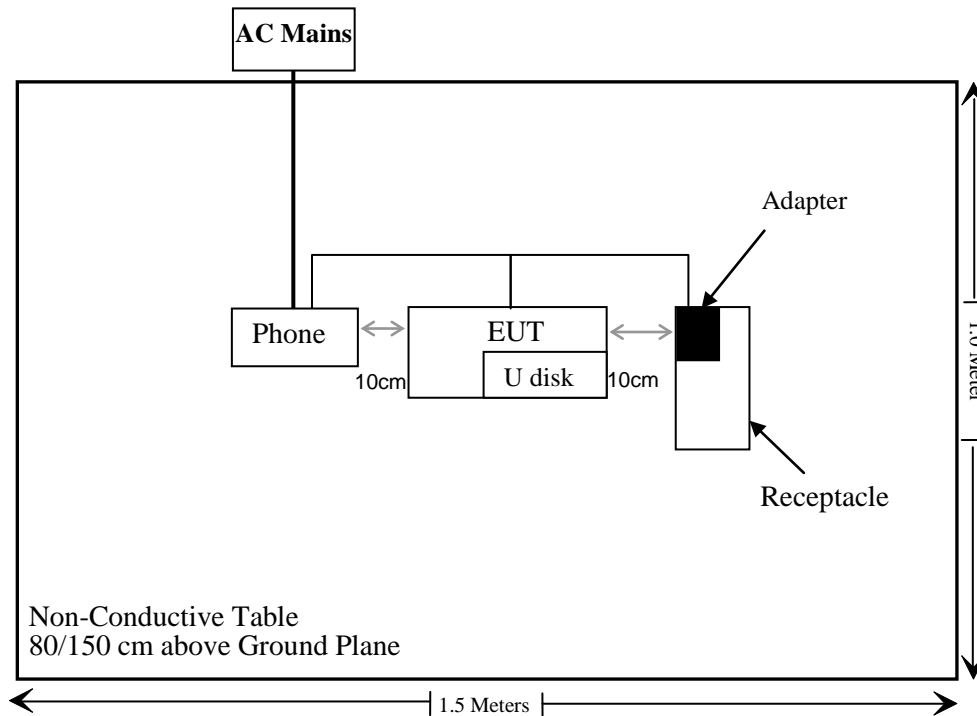

SUMMARY OF TEST RESULTS

FCC Rules	Description of Test	Result
§1.1310, §2.1091	Maximum Permissible Exposure (MPE)	Compliant
§15.203	Antenna Requirement	Compliant
§15.207(a)	AC Line Conducted Emissions	Compliant
§15.205, §15.209 & §15.247(d)	Radiated Emissions	Compliant
§15.247(a)(1)	20 dB Emission Bandwidth & 99% Occupied Bandwidth	Compliant
§15.247(a)(1)	Channel Separation Test	Compliant
§15.247(a)(1)(iii)	Time of Occupancy (Dwell Time)	Compliant
§15.247(a)(1)(iii)	Quantity of hopping channel Test	Compliant
§15.247(b)(1)	Peak Output Power Measurement	Compliant
§15.247(d)	Band edges	Compliant

TEST EQUIPMENT LIST

Manufacturer	Description	Model	Serial Number	Calibration Date	Calibration Due Date
Conducted Emissions Test					
Rohde & Schwarz	EMI Test Receiver	ESCI	100784	2021/12/13	2022/12/12
Rohde & Schwarz	L.I.S.N.	ENV216	101314	2021/12/13	2022/12/12
Anritsu Corp	50 Coaxial Switch	MP59B	6100237248	2021/12/13	2022/12/12
Unknown	RF Coaxial Cable	No.17	N0350	2021/12/14	2022/12/13
Conducted Emission Test Software: e3 19821b (V9)					
Radiated Emissions Test					
Rohde & Schwarz	Test Receiver	ESR	102725	2021/12/13	2022/12/12
Rohde & Schwarz	Spectrum Analyzer	FSV40	101949	2021/12/13	2022/12/12
SONOMA INSTRUMENT	Amplifier	310 N	186131	2021/11/09	2022/11/08
A.H. Systems, inc.	Preamplifier	PAM-0118P	135	2021/11/09	2022/11/08
Quinstar	Amplifier	QLW-184055 36-J0	15964001002	2021/11/11	2022/11/10
Schwarzbeck	Bilog Antenna	VULB9163	9163-323	2021/07/06	2024/07/05
Schwarzbeck	Horn Antenna	BBHA9120D	9120D-1067	2020/01/05	2023/01/04
Schwarzbeck	HORN ANTENNA	BBHA9170	9170-359	2020/01/05	2023/01/04
Wainwright	High Pass Filter	WHKX3.6/18 G-10SS	5	2021/12/14	2022/12/13
Unknown	RF Coaxial Cable	No.10	N050	2021/12/14	2022/12/13
Unknown	RF Coaxial Cable	No.11	N1000	2021/12/14	2022/12/13
Unknown	RF Coaxial Cable	No.12	N040	2021/12/14	2022/12/13
Unknown	RF Coaxial Cable	No.13	N300	2021/12/14	2022/12/13
Unknown	RF Coaxial Cable	No.14	N800	2021/12/14	2022/12/13
Unknown	RF Coaxial Cable	No.15	N600	2021/12/14	2022/12/13
Unknown	RF Coaxial Cable	No.16	N650	2021/12/14	2022/12/13
Radiated Emission Test Software: e3 19821b (V9)					
RF Conducted Test					
Rohde & Schwarz	Spectrum Analyzer	FSV-40	101495	2021/12/13	2022/12/12
Rohde & Schwarz	Open Switch and Control Unit	OSP120 + OSP-B157	101244 + 100866	2021/12/13	2022/12/12
WEINSCHHEL	10dB Attenuator	5324	AU 3842	2021/12/14	2022/12/13
Unknown	RF Coaxial Cable	No.31	RF-01	Each time	

*** Statement of Traceability:** Shenzhen Accurate Technology Co., Ltd. attests that all calibrations have been performed in accordance to requirements that traceable to National Primary Standards and International System of Units (SI).

FCC §1.1310 & §2.1091 –MAXIMUM PERMISSIBLE EXPOSURE (MPE)**Applicable Standard**

According to subpart §2.1091 and subpart §1.1310, systems operating under the provisions of this section shall be operated in a manner that ensures that the public is not exposed to radio frequency energy level in excess of the Commission's guidelines.

Limits for Maximum Permissible Exposure (MPE) (§1.1310, §2.1091)

(B) Limits for General Population/Uncontrolled Exposure				
Frequency Range (MHz)	Electric Field Strength (V/m)	Magnetic Field Strength (A/m)	Power Density (mW/cm²)	Averaging Time (minutes)
0.3-1.34	614	1.63	*(100)	30
1.34-30	824/f	2.19/f	*(180/f ²)	30
30-300	27.5	0.073	0.2	30
300-1500	/	/	f/1500	30
1500-100,000	/	/	1.0	30

f = frequency in MHz; * = Plane-wave equivalent power density;

According to §1.1310 and §2.1091 RF exposure is calculated.

Calculated Formulary:

Predication of MPE limit at a given distance

$S = PG/4\pi R^2$ = power density (in appropriate units, e.g. mW/cm²);

P = power input to the antenna (in appropriate units, e.g., mW);

G = power gain of the antenna in the direction of interest relative to an isotropic radiator, the power gain factor, is normally numeric gain;

R = distance to the center of radiation of the antenna (appropriate units, e.g., cm);

Test Result:

For worst case:

Frequency (MHz)	Maximum Antenna Gain		Tune up conducted power		Evaluation Distance (cm)	Power Density (mW/cm²)	MPE Limit (mW/cm²)
	(dBi)	(numeric)	(dBm)	(mW)			
2402-2480	-0.68	0.86	5	3.16	20	0.0005	1

To maintain compliance with the FCC's RF exposure guidelines, place the equipment at least 20cm from nearby persons.

Result: Compliant.

FCC §15.203 – ANTENNA REQUIREMENT

Applicable Standard

According to FCC § 15.203, an intentional radiator shall be designed to ensure that no antenna other than that furnished by the responsible party shall be used with the device. The use of a permanently attached antenna or of an antenna that uses a unique coupling to the intentional radiator shall be considered sufficient to comply with the provisions of this Section. The manufacturer may design the unit so that a broken antenna can be replaced by the user, but the use of a standard antenna jack or electrical connector is prohibited.

Antenna Connector Construction

The EUT has one internal PCB Antenna arrangement, which was permanently attached and the antenna gain is -0.68 dBi, fulfill the requirement of this section. Please refer to the EUT photos.

Result: Compliant.

FCC §15.207 (a) – AC LINE CONDUCTED EMISSIONS

Applicable Standard

FCC §15.207(a)

EUT Setup

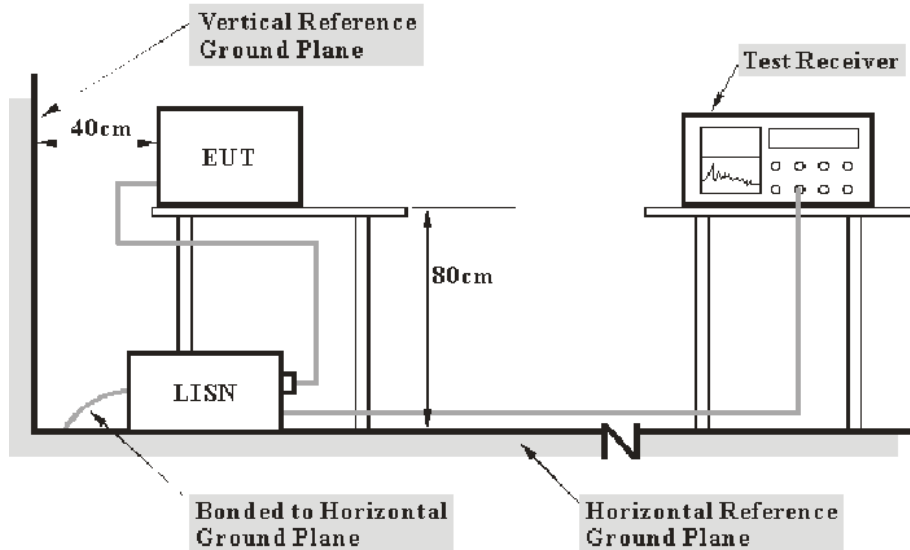

- Note: 1. Support units were connected to second LISN.
 2. Both of LISNs (AMN) 80 cm from EUT and at the least 80 cm from other units and other metal planes support units.

The measurement procedure of EUT setup is according with ANSI C63.10-2013. The related limit was specified in FCC Part 15.207.

The spacing between the peripherals was 10 cm.

EMI Test Receiver Setup

The EMI test receiver was set to investigate the spectrum from 150 kHz to 30 MHz.

During the conducted emission test, the EMI test receiver was set with the following configurations:

Frequency Range	IF B/W
150 kHz – 30 MHz	9 kHz

Test Procedure

During the conducted emission test, the adapter was connected to the outlet of the LISN.

Maximizing procedure was performed on the six (6) highest emissions of the EUT.

All final data was recorded in the Quasi-peak and average detection mode.

Factor & Margin Calculation

The factor is calculated by adding LISN VDF (Voltage Division Factor) and Cable Loss. The basic equation is as follows:

$$\text{Factor} = \text{LISN VDF} + \text{Cable Loss}$$

The “**Over limit**” column of the following data tables indicates the degree of compliance with the applicable limit. For example, an Over limit of -7 dB means the emission is 7 dB below the limit. The equation for calculation is as follows:

$$\begin{aligned}\text{Over Limit} &= \text{Level} - \text{Limit} \\ \text{Level} &= \text{Read Level} + \text{Factor}\end{aligned}$$

Test Data

Environmental Conditions

Temperature:	25 °C
Relative Humidity:	60 %
ATM Pressure:	101.0 kPa

The testing was performed by Caro Hu on 2022-04-25.

EUT operation mode: BT transmitting

AC 120V/60 Hz, Line

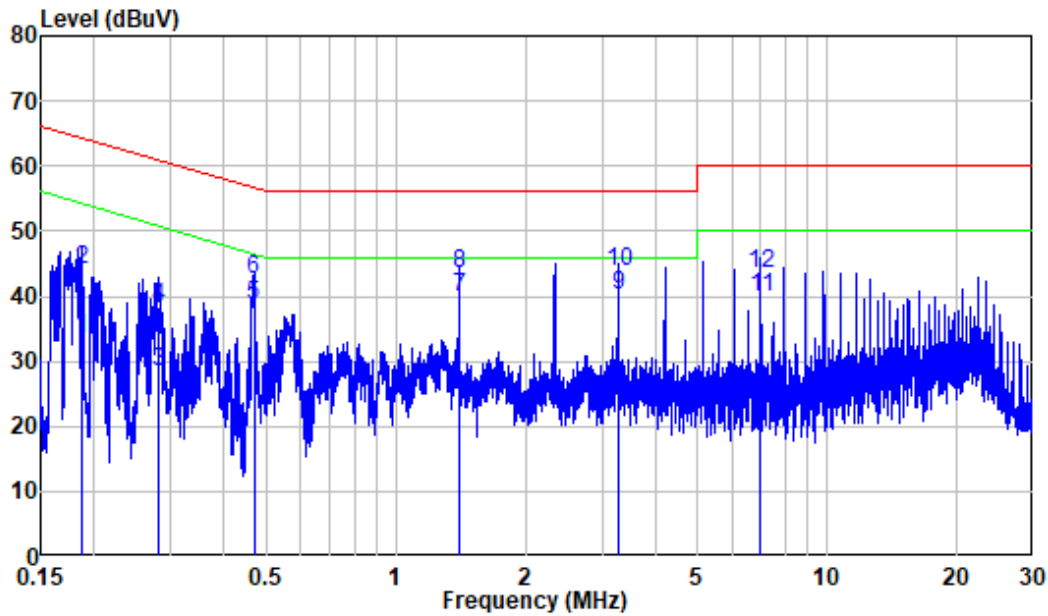

Site : Shielding Room
 Condition: Line
 Job No. : SZNS1220418-14554E-RF
 Mode : BT Transmitting
 Model : 8226

	Freq	Factor	Read Level	Level	Limit Line	Over Limit	Remark
	MHz	dB	dBuV	dBuV	dBuV	dB	
1	0.187	9.80	23.61	33.41	54.18	-20.77	Average
2	0.187	9.80	34.35	44.15	64.18	-20.03	QP
3	0.282	9.80	18.44	28.24	50.77	-22.53	Average
4	0.282	9.80	28.51	38.31	60.77	-22.46	QP
5	0.468	9.80	28.96	38.76	46.54	-7.78	Average
6	0.468	9.80	32.72	42.52	56.54	-14.02	QP
7	1.401	9.81	30.12	39.93	46.00	-6.07	Average
8	1.401	9.81	33.55	43.36	56.00	-12.64	QP
9	3.269	9.83	30.35	40.18	46.00	-5.82	Average
10	3.269	9.83	33.83	43.66	56.00	-12.34	QP
11	7.006	9.87	29.94	39.81	50.00	-10.19	Average
12	7.006	9.87	33.45	43.32	60.00	-16.68	QP

AC 120V/60 Hz, Neutral

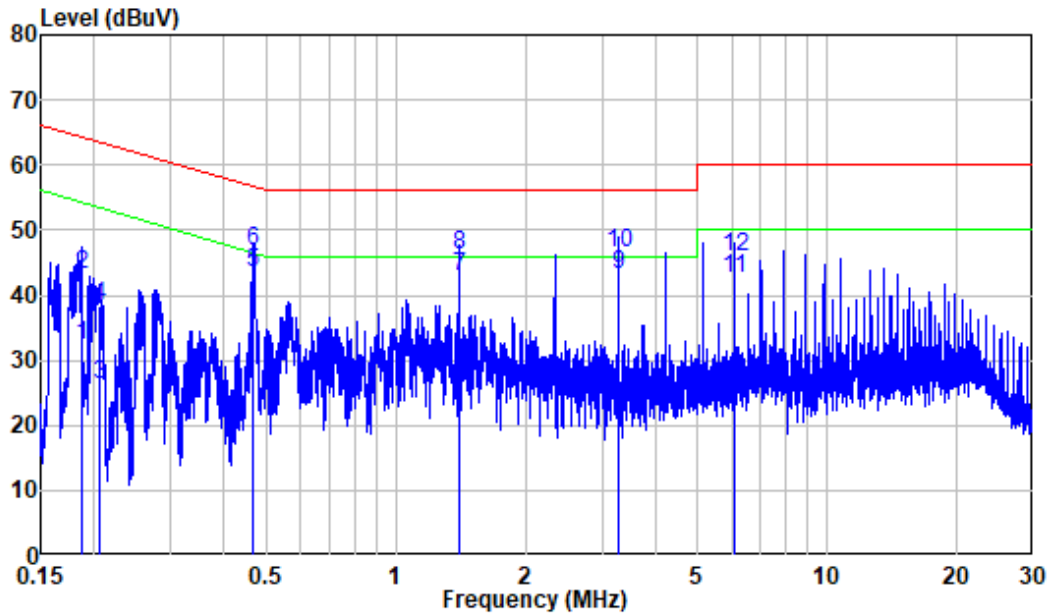

Site : Shielding Room
 Condition: Neutral
 Job No. : SZNS1220418-14554E-RF
 Mode : BT Transmitting
 Model : 8226

	Freq	Factor	Read Level	Limit Level	Limit Line	Over Limit	Remark
	MHz	dB	dBuV	dBuV	dBuV	dB	
1	0.187	9.80	22.53	32.33	54.19	-21.86	Average
2	0.187	9.80	33.48	43.28	64.19	-20.91	QP
3	0.205	9.80	16.60	26.40	53.40	-27.00	Average
4	0.205	9.80	28.50	38.30	63.40	-25.10	QP
5	0.467	9.80	33.60	43.40	46.57	-3.17	Average
6	0.467	9.80	36.94	46.74	56.57	-9.83	QP
7	1.400	9.81	32.91	42.72	46.00	-3.28	Average
8	1.400	9.81	36.36	46.17	56.00	-9.83	QP
9	3.271	9.83	33.41	43.24	46.00	-2.76	Average
10	3.271	9.83	36.78	46.61	56.00	-9.39	QP
11	6.076	9.93	32.77	42.70	50.00	-7.30	Average
12	6.076	9.93	35.92	45.85	60.00	-14.15	QP

FCC §15.205, §15.209 & §15.247(d) – RADIATED EMISSIONS**Applicable Standard**

FCC §15.205; §15.209; §15.247(d)

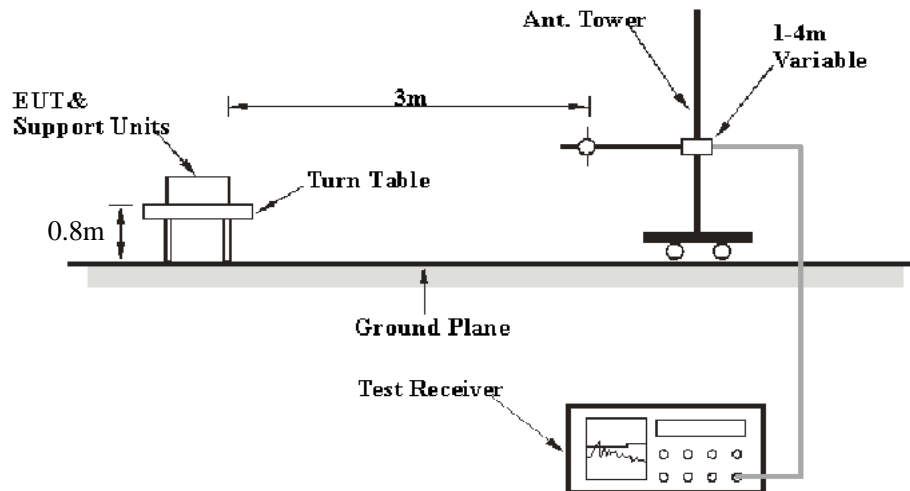
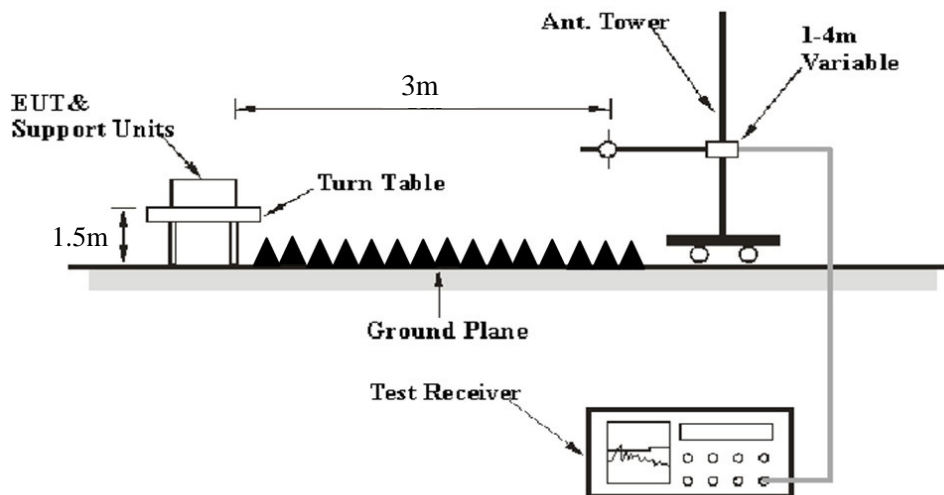
EUT Setup**Below 1 GHz:****Above 1GHz:**

The radiated emission performed in the 3 meters, using the setup accordance with the ANSI C63.10-2013. The specification used was the FCC 15.209, FCC 15.247 limits.

EMI Test Receiver & Spectrum Analyzer Setup

The EMI test receiver & Spectrum Analyzer Setup were set with the following configurations:

Frequency Range	RBW	Video B/W	IF B/W	Measurement
30 MHz – 1000 MHz	100 kHz	300 kHz	120 kHz	QP
Above 1 GHz	1 MHz	3 MHz	/	PK
	1 MHz	10 Hz	/	Average

Test Procedure

Maximizing procedure was performed on the highest emissions to ensure that the EUT complied with all installation combinations.

All final data was recorded in Quasi-peak detection mode for frequency range of 30 MHz -1 GHz and peak and Average detection modes for frequencies above 1 GHz.

If the maximized peak measured value complies with the limit, then it is unnecessary to perform QP/Average measurement.

Factor & Margin Calculation

The Factor is calculated by adding the Antenna Factor and Cable Loss, and subtracting the Amplifier Gain. The basic equation is as follows:

$$\text{Factor} = \text{Antenna Factor} + \text{Cable Loss} - \text{Amplifier Gain}$$

The “**Over Limit/Margin**” column of the following data tables indicates the degree of compliance with the applicable limit. For example, an Over Limit/margin of -7dB means the emission is 7dB below the limit. The equation for calculation is as follows:

$$\begin{aligned} \text{Over Limit/Margin} &= \text{Level} / \text{Corrected Amplitude} - \text{Limit} \\ \text{Level} / \text{Corrected Amplitude} &= \text{Read Level} + \text{Factor} \end{aligned}$$

Test Data

Environmental Conditions

Temperature:	22~28 °C
Relative Humidity:	56~60 %
ATM Pressure:	101.0~101.3 kPa

The testing was performed by Nick Fang from 2022-04-19 to 2022-04-20.

EUT operation mode: BT Transmitting

(Scan with GFSK, $\pi/4$ -DQPSK, 8DPSK mode at X axis, Y axis, Z axis, the worst case is 8DPSK Mode at Y axis)

Below 1GHz: 8DPSK Middle Channel

Horizontal

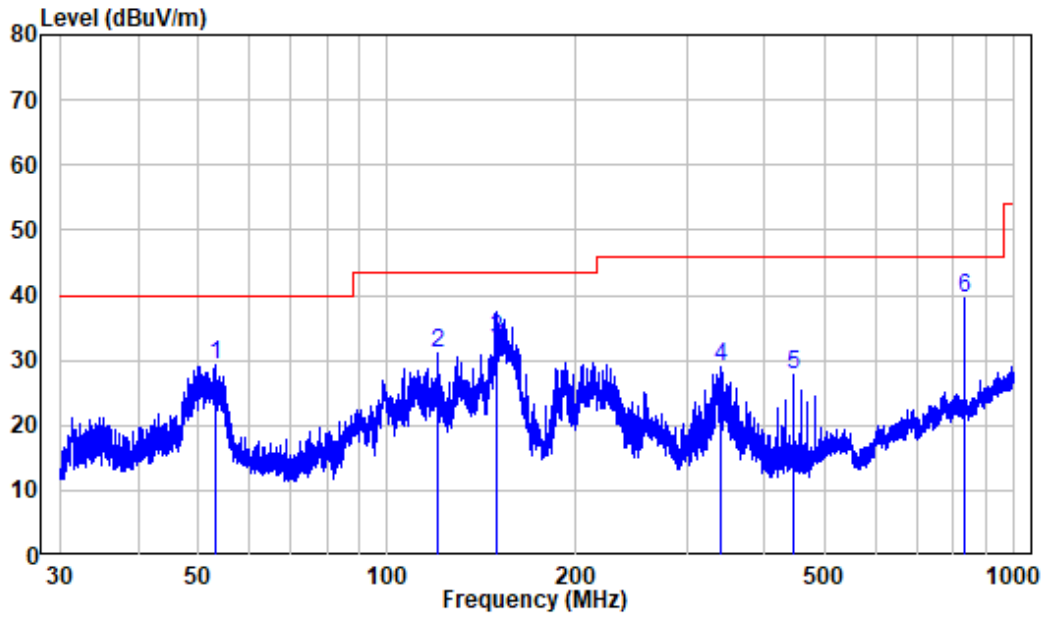

Site : chamber
 Condition: 3m HORIZONTAL
 Job No. : SZNS1220418-14554E-RF
 Test Mode: BT Transmitting

	Freq	Factor	Read Level	Limit Level	Limit Line	Over Limit	Remark
	MHz	dB/m	dBuV	dBuV/m	dBuV/m	dB	
1	53.061	-10.17	39.52	29.35	40.00	-10.65	Peak
2	120.646	-13.66	44.64	30.98	43.50	-12.52	Peak
3	148.897	-15.34	48.70	33.36	43.50	-10.14	QP
4	339.440	-7.45	36.40	28.95	46.00	-17.05	Peak
5	444.851	-5.64	33.32	27.68	46.00	-18.32	Peak
6	833.317	0.14	39.53	39.67	46.00	-6.33	Peak

Vertical

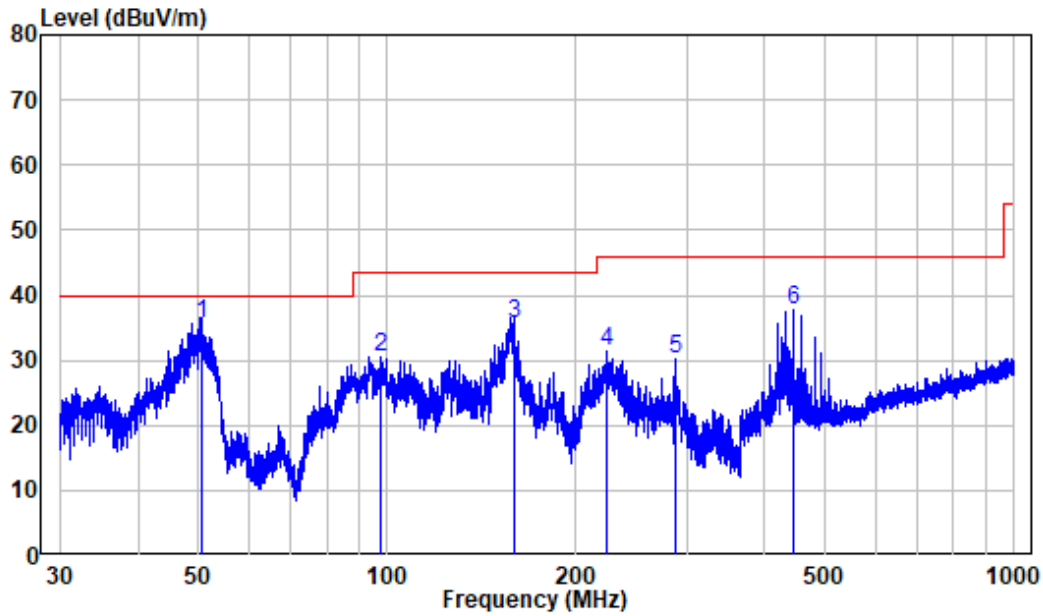

Site : chamber
 Condition: 3m VERTICAL
 Job No. : SZNS1220418-14554E-RF
 Test Mode: BT Transmitting

	Freq	Factor	Read Level	Limit Level	Over Limit	Remark
	MHz	dB/m	dBuV	dBuV/m	dBuV/m	dB
1	50.475	-9.92	45.40	35.48	40.00	-4.52 QP
2	97.755	-12.26	42.72	30.46	43.50	-13.04 Peak
3	158.946	-14.36	50.02	35.66	43.50	-7.84 QP
4	223.244	-11.32	42.62	31.30	46.00	-14.70 Peak
5	288.117	-9.36	39.61	30.25	46.00	-15.75 Peak
6	444.657	-5.64	43.52	37.88	46.00	-8.12 Peak

Above 1GHz (worst case for 8DPSK):

Frequency (MHz)	Receiver		Turntable Angle Degree	Rx Antenna		Factor (dB/m)	Absolute Level (dBuV/m)	Limit (dBuV/m)	Margin (dB)
	Reading (dBuV)	PK/AV		Height	Polar				
			(m)	(H/V)					
Low Channel									
2310	43.93	PK	275	1.1	H	-7.23	36.7	74	-37.3
2310	50.1	PK	158	1.8	V	-7.23	42.87	74	-31.13
2390	42.89	PK	245	2.1	H	-7.21	35.68	74	-38.32
2390	46.94	PK	289	1.6	V	-7.21	39.73	74	-34.27
4804	61.84	PK	230	1.6	H	-3.52	58.32	74	-15.68
4804	49.26	AV	230	1.6	H	-3.52	45.74	54	-8.26
4804	61.24	PK	242	1.4	V	-3.52	57.72	74	-16.28
4804	48	AV	242	1.4	V	-3.52	44.48	54	-9.52
Middle Channel									
4882	62.25	PK	186	1.7	H	-3.37	58.88	74	-15.12
4882	49.48	AV	186	1.7	H	-3.37	46.11	54	-7.89
4882	61.29	PK	333	1.5	V	-3.37	57.92	74	-16.08
4882	49.12	AV	333	1.5	V	-3.37	45.75	54	-8.25
High Channel									
2483.5	49.68	PK	133	1.8	H	-7.2	42.48	74	-31.52
2483.5	51.12	PK	249	1.7	V	-7.2	43.92	74	-30.08
2500	44.36	PK	224	2.1	H	-7.18	37.18	74	-36.82
2500	46	PK	106	1.3	V	-7.18	38.82	74	-35.18
4960	60.42	PK	50	2.1	H	-3.01	57.41	74	-16.59
4960	47.15	AV	50	2.1	H	-3.01	44.14	54	-9.86
4960	61.86	PK	158	1.8	V	-3.01	58.85	74	-15.15
4960	48.5	AV	158	1.8	V	-3.01	45.49	54	-8.51

Note:

Factor = Antenna factor (RX) + Cable Loss – Amplifier Factor

Absolute Level (Corrected Amplitude) = Factor + Reading

Margin = Absolute Level - Limit

The other spurious emission which is in the noise floor level was not recorded.

For above 1GHz, the test result of peak was 20dB below to the limit of peak, which can be compliant to the average limit, so just peak value was recorded.

1 GHz - 18 GHz: (Pre-Scan plots)

Worst case for 8DPSK Middle Channel:

Horizontal

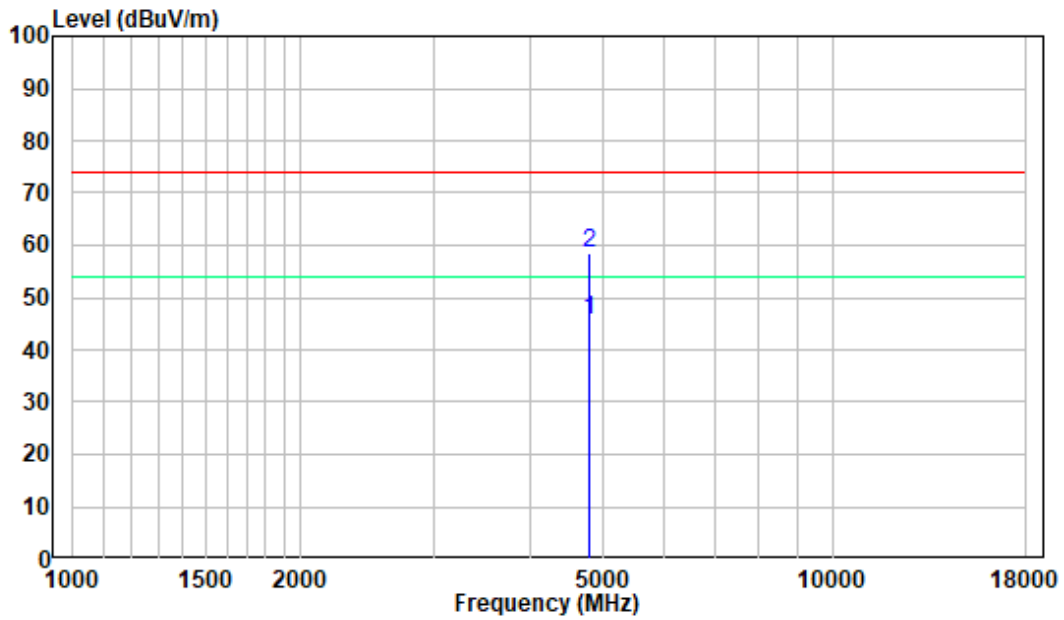

Vertical

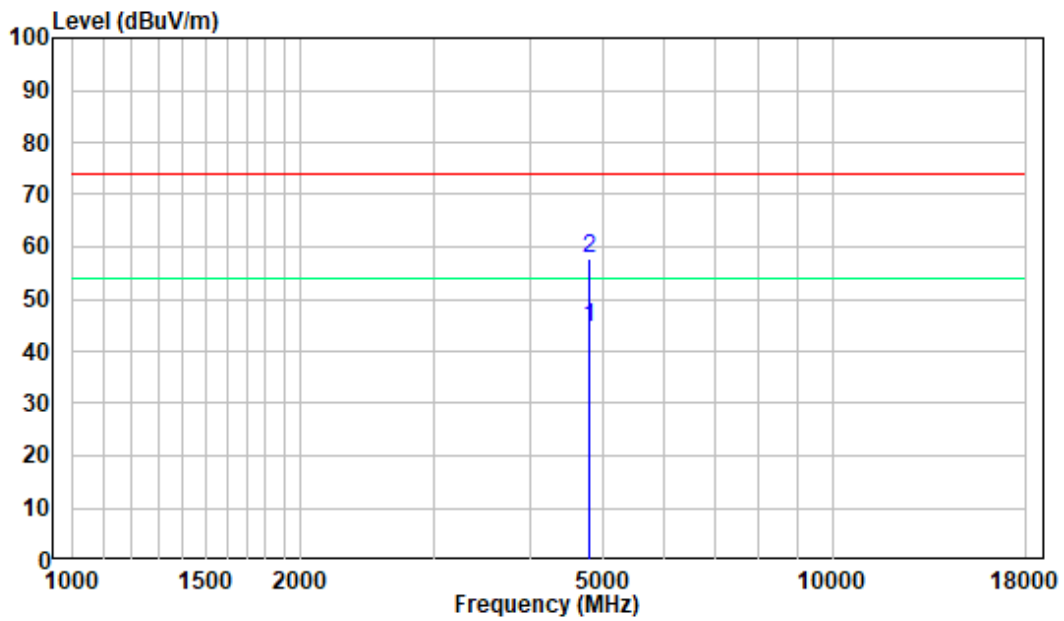

18-25GHz: (Pre-Scan plots)

Worst case for 8DPSK Middle Channel:

Horizontal

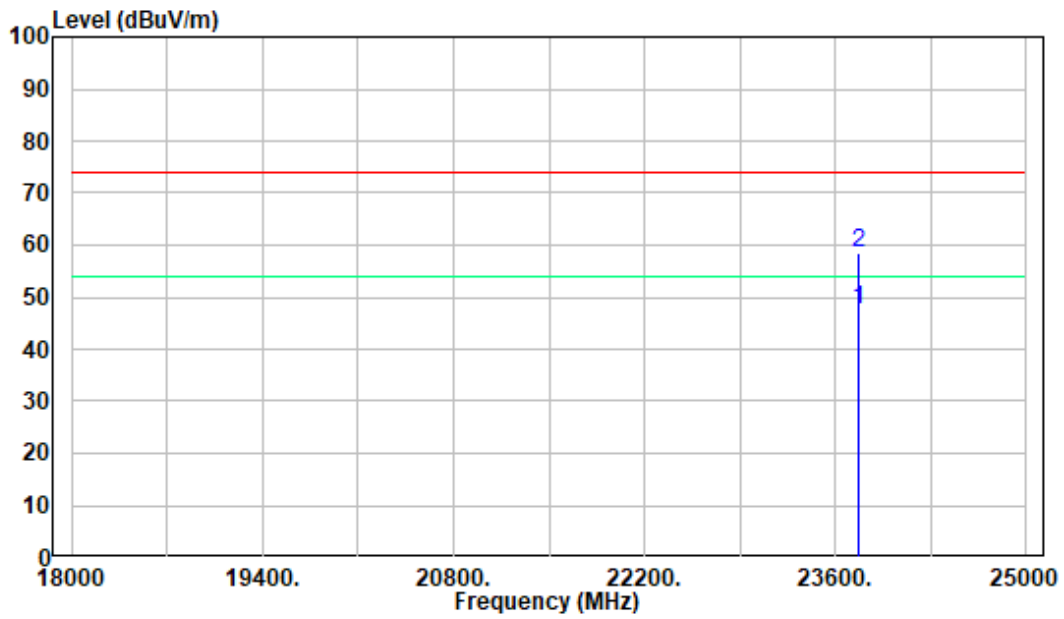

Vertical

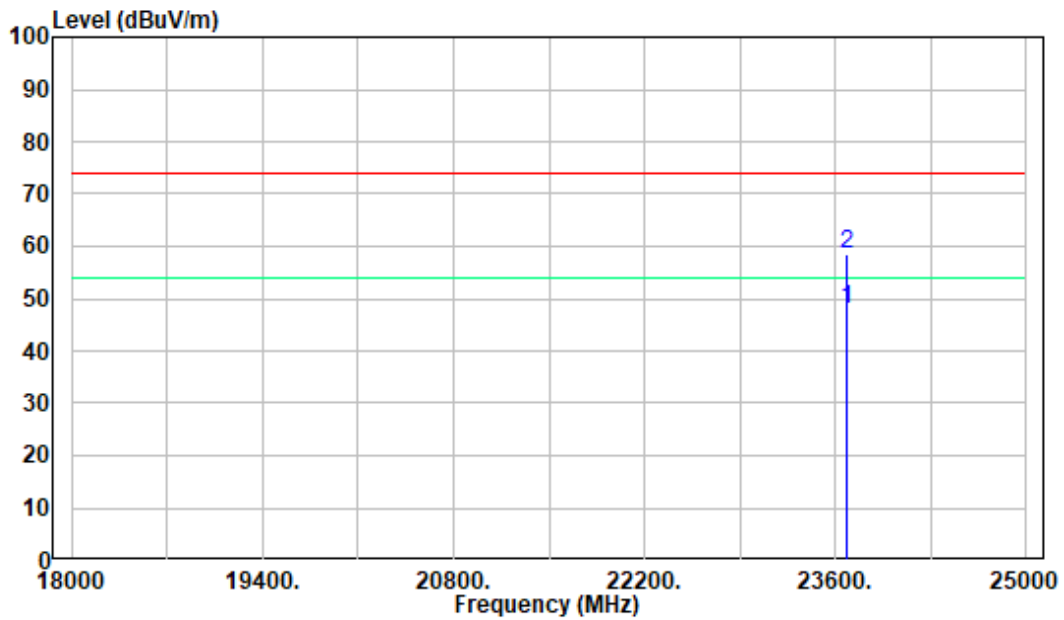

FCC §15.247(a) (1)-CHANNEL SEPARATION TEST

Applicable Standard

Frequency hopping systems shall have hopping channel carrier frequencies separated by a minimum of 25 kHz or the 20 dB bandwidth of the hopping channel, whichever is greater. Alternatively, frequency hopping systems operating in the 2400-2483.5 MHz band may have hopping channel carrier frequencies that are separated by 25 kHz or two-thirds of the 20 dB bandwidth of the hopping channel, whichever is greater provided the systems operate with an output power no greater than 125 mW. The system shall hop to channel frequencies that are selected at the system hopping rate from a pseudo randomly ordered list of hopping frequencies. Each frequency must be used equally on the average by each transmitter. The system receivers shall have input bandwidths that match the hopping channel bandwidths of their corresponding transmitters and shall shift frequencies in synchronization with the transmitted signals.

Test Procedure

1. Set the EUT in transmitting mode, maxhold the channel.
2. Set the adjacent channel of the EUT and maxhold another trace.
3. Measure the channel separation.

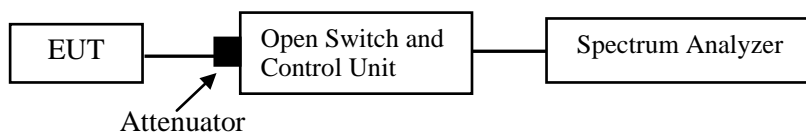

Test Data

Environmental Conditions

Temperature:	23 °C
Relative Humidity:	51 %
ATM Pressure:	101.1 kPa

The testing was performed by Key.Pei on 2022-04-25.

EUT operation mode: Transmitting

Test Result: Compliant.

TestMode	Antenna	Channel	Result[MHz]	Limit[MHz]	Verdict
BDR(GFSK)	Ant1	Hop	1	≥ 0.556	PASS
EDR($\pi/4$ DQPSK)	Ant1	Hop	1	≥ 0.840	PASS
ERD(8DPSK)	Ant1	Hop	1.003	≥ 0.830	PASS

Note: The limit = (2/3) * 20dB bandwidth

Please refer to the below plots:

GFSK_Ant1_Hop

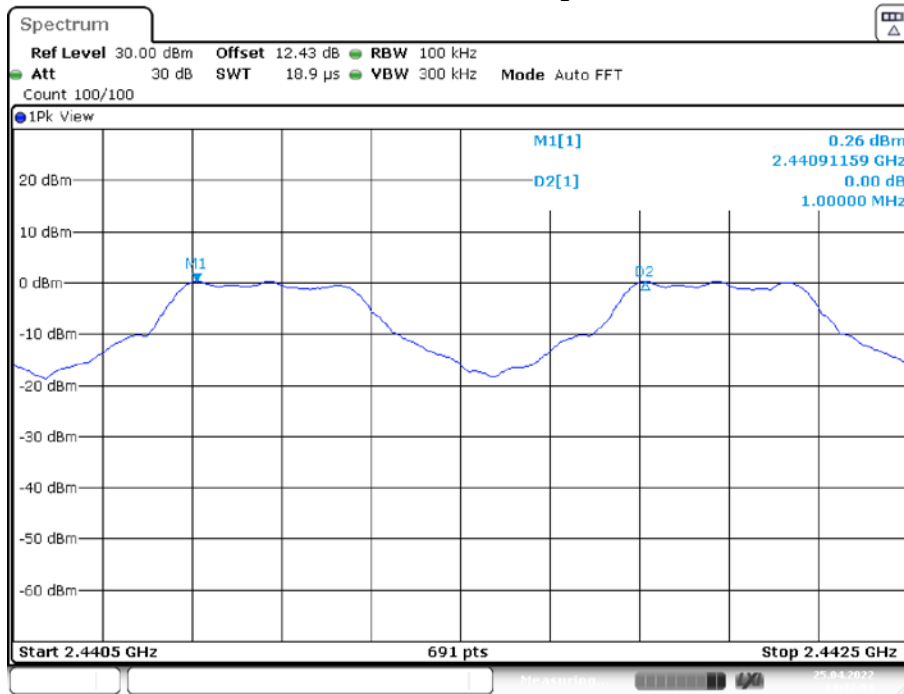

EDR($\pi/4$ DQPSK)_Ant1_Hop

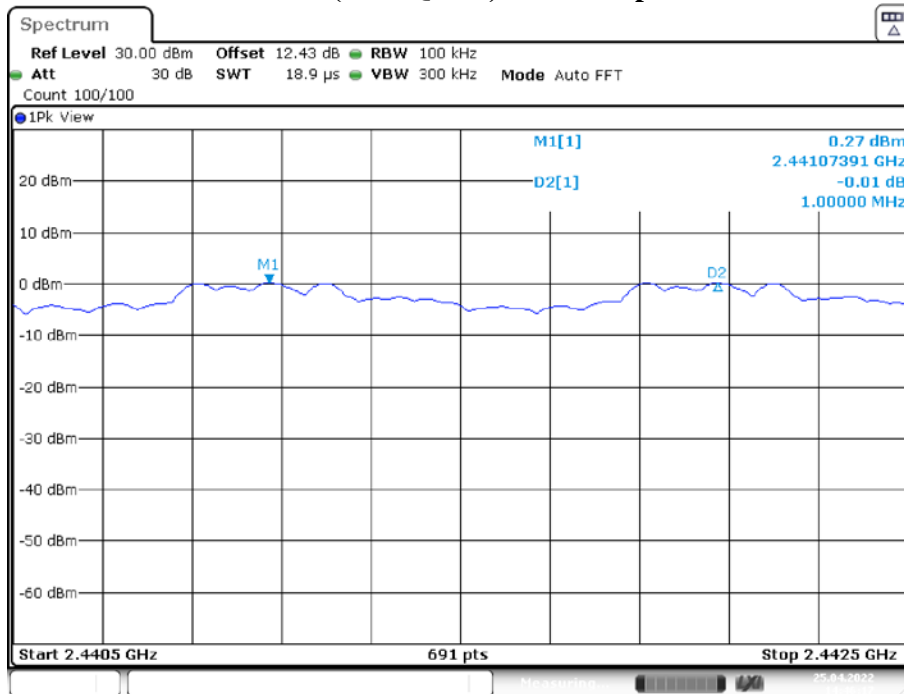

ERD(8DPSK)_Ant1_Hop

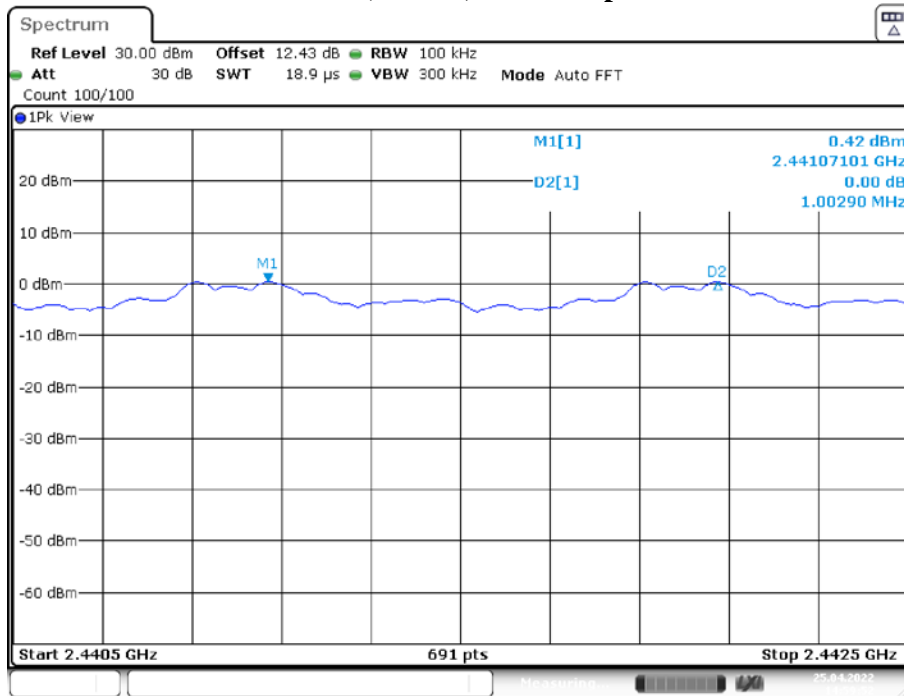

FCC §15.247(a) (1) – 20 dB EMISSION BANDWIDTH & 99% OCCUPIED BANDWIDTH

Applicable Standard

Alternatively, frequency hopping systems operating in the 2400–2483.5 MHz band may have hopping channel carrier frequencies that are separated by 25 kHz or two-thirds of the 20 dB bandwidth of the hopping channel, whichever is greater, provided the systems operate with an output power no greater than 125 mW.

Test Procedure

The following conditions shall be observed for measuring the occupied bandwidth and 20 dB bandwidth:

- The transmitter shall be operated at its maximum carrier power measured under normal test conditions.
- The span of the spectrum analyzer shall be set large enough to capture all products of the modulation process, including the emission skirts, around the carrier frequency, but small enough to avoid having other emissions (e.g. on adjacent channels) within the span.
- The detector of the spectrum analyzer shall be set to “Sample”. However, a peak, or peak hold, may be used in place of the sampling detector since this usually produces a wider bandwidth than the actual bandwidth (worst-case measurement). Use of a peak hold (or “Max Hold”) may be necessary to determine the occupied / 20 dB bandwidth if the device is not transmitting continuously.
- The resolution bandwidth (RBW) shall be in the range of 1% to 5% of the actual occupied / 20 dB bandwidth and the video bandwidth (VBW) shall not be smaller than three times the RBW value. Video averaging is not permitted.

Note: It may be necessary to repeat the measurement a few times until the RBW and VBW are in compliance with the above requirement.

For the 99% emission bandwidth, the trace data points are recovered and directly summed in linear power level terms. The recovered amplitude data points, beginning at the lowest frequency, are placed in a running sum until 0.5% of the total is reached, and that frequency recorded. The process is repeated for the highest frequency data points (starting at the highest frequency, at the right side of the span, and going down in frequency). This frequency is then recorded. The difference between the two recorded frequencies is the occupied bandwidth (or the 99% emission bandwidth).

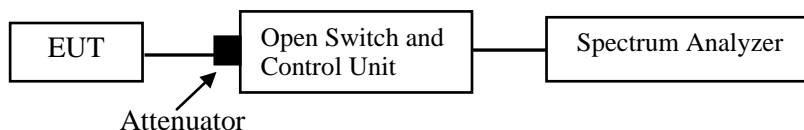

Test Data**Environmental Conditions**

Temperature:	23 °C
Relative Humidity:	51 %
ATM Pressure:	101.1 kPa

The testing was performed by Key.Pei on 2022-04-25.

EUT operation mode: Transmitting

Test Result: Compliant.

TestMode	Antenna	Channel	20db EBW[MHz]	99% OCCUPIED BANDWIDTH[MHz]	Verdict
BDR(GFSK)	Ant1	2402	0.831	0.818	PASS
		2441	0.834	0.815	PASS
		2480	0.831	0.818	PASS
EDR ($\pi/4$ DQPSK)	Ant1	2402	1.260	1.169	PASS
		2441	1.257	1.169	PASS
		2480	1.260	1.166	PASS
ERD(8DPSK)	Ant1	2402	1.218	1.163	PASS
		2441	1.215	1.163	PASS
		2480	1.245	1.163	PASS

Please refer to the below plots:

BDR(GFSK):

20 dB EMISSION BANDWIDTH _Ant1_2402

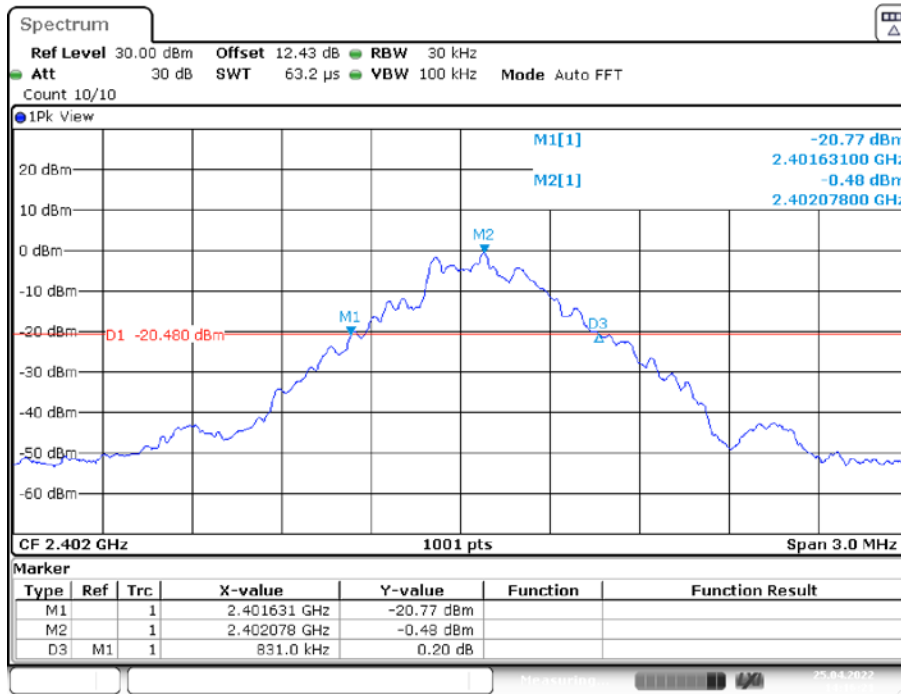

99% OCCUPIED BANDWIDTH _Ant1_2402

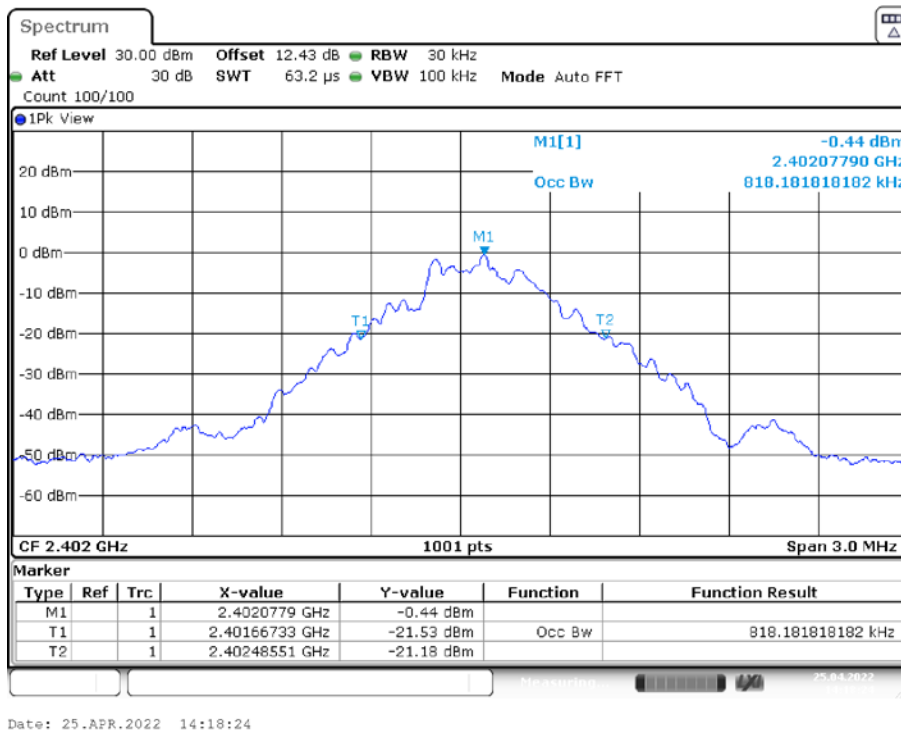

20 dB EMISSION BANDWIDTH _Ant1_2441

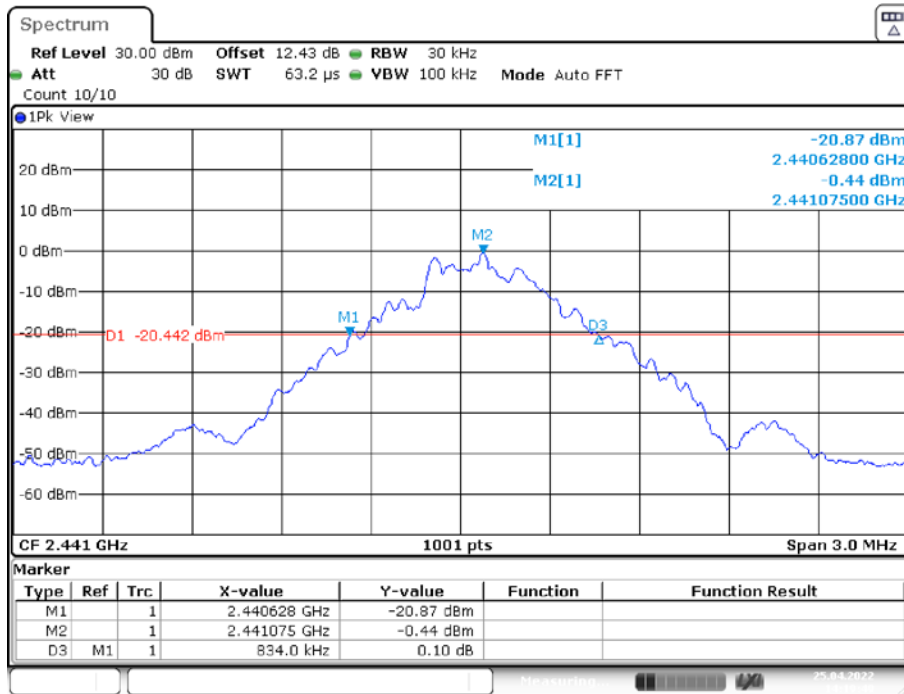

99% OCCUPIED BANDWIDTH _Ant1_2441

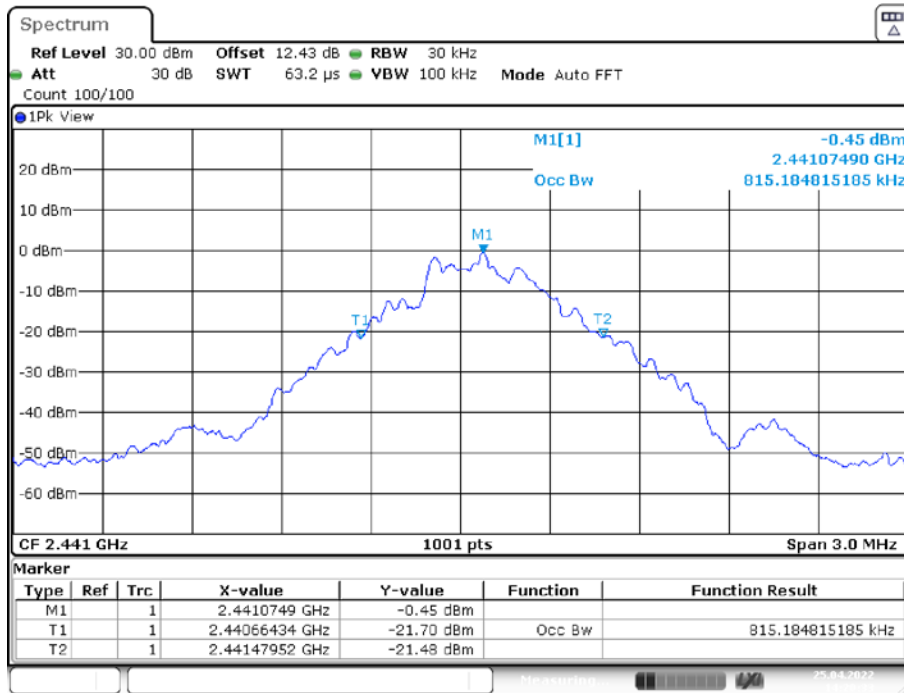

20 dB EMISSION BANDWIDTH _Ant1_2480

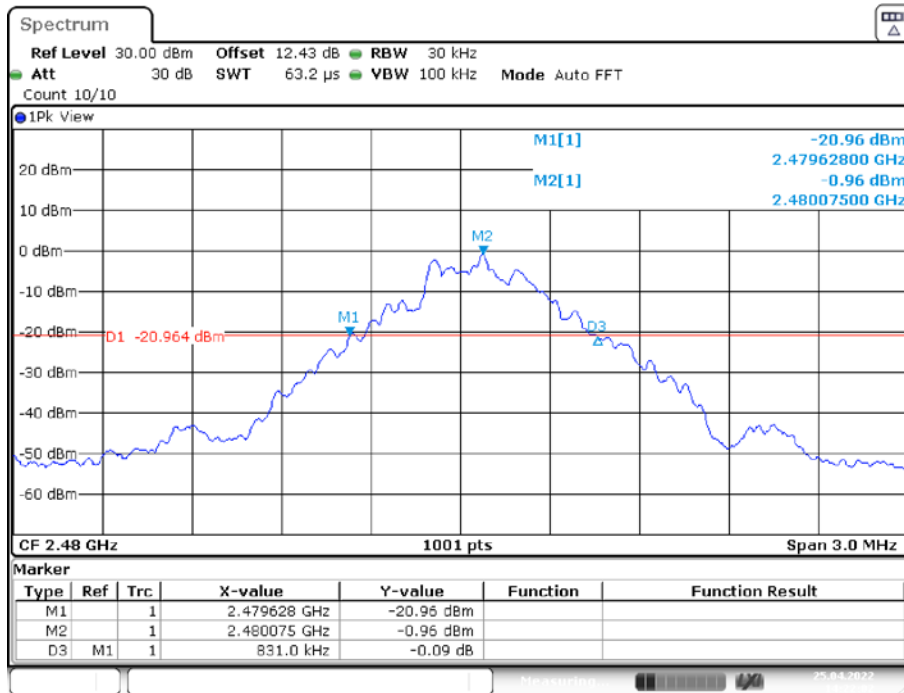

Date: 25.APR.2022 14:22:03

99% OCCUPIED BANDWIDTH _Ant1_2480

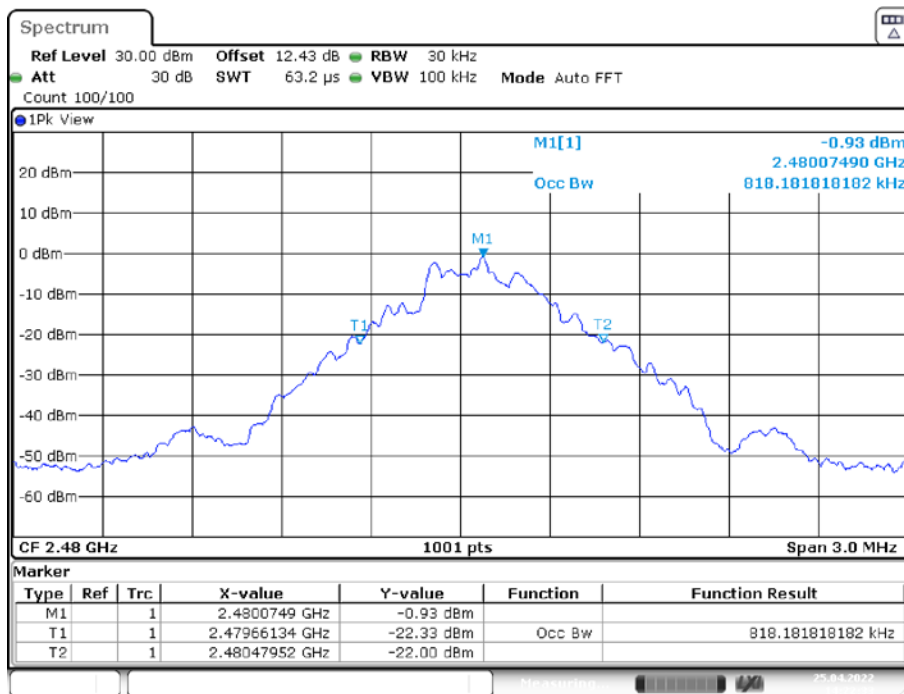

Date: 25.APR.2022 14:22:33

EDR($\pi/4$ DQPSK):

20 dB EMISSION BANDWIDTH _Ant1_2402



Date: 25.APR.2022 14:24:10

99% OCCUPIED BANDWIDTH _Ant1_2402

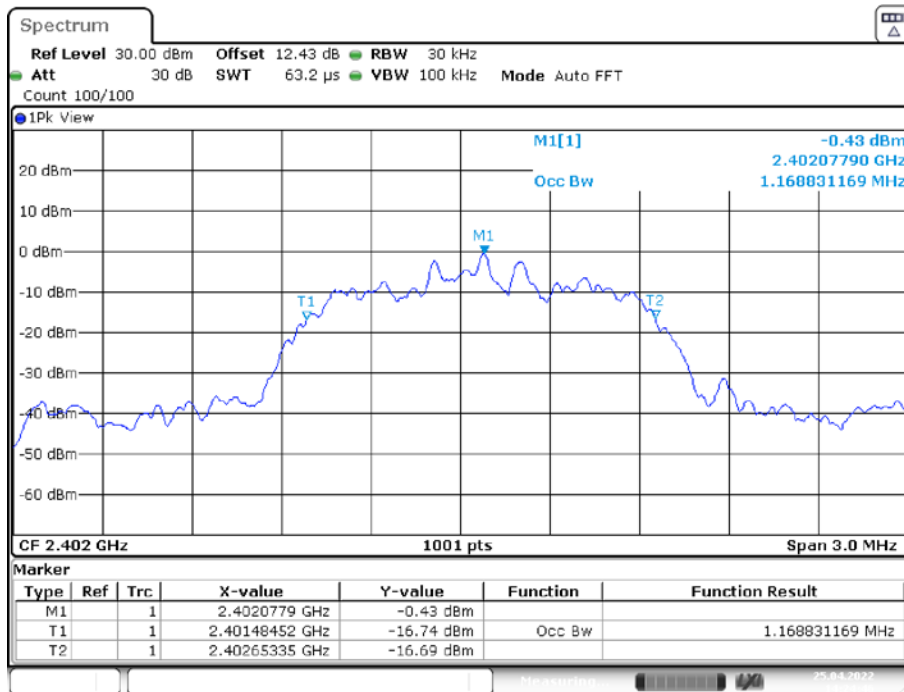

Date: 25.APR.2022 14:24:46

20 dB EMISSION BANDWIDTH _Ant1_2441

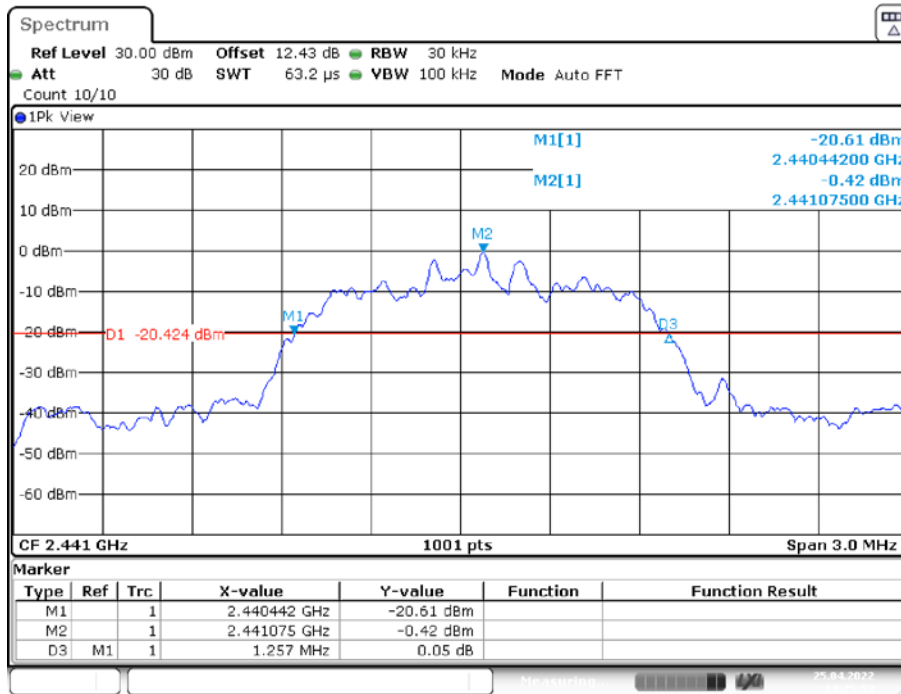

Date: 25.APR.2022 14:25:54

99% OCCUPIED BANDWIDTH _Ant1_2441



Date: 25.APR.2022 14:26:24

20 dB EMISSION BANDWIDTH _Ant1_2480



Date: 25.APR.2022 14:27:18

99% OCCUPIED BANDWIDTH _Ant1_2480



Date: 25.APR.2022 14:27:45

ERD(8DPSK):

20 dB EMISSION BANDWIDTH _Ant1_2402

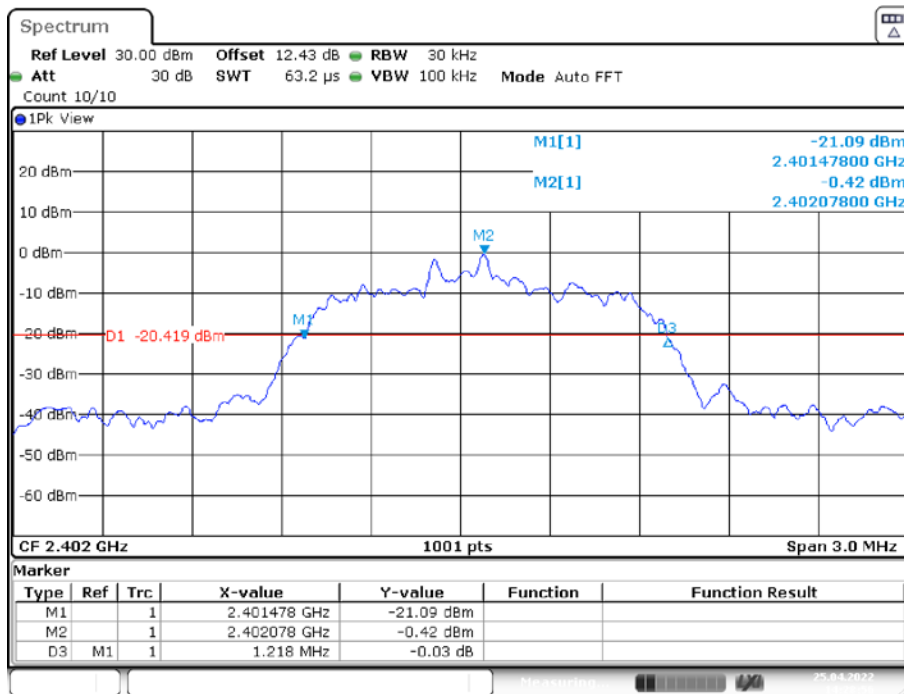

Date: 25.APR.2022 14:28:57

99% OCCUPIED BANDWIDTH _Ant1_2402



Date: 25.APR.2022 14:29:27

20 dB EMISSION BANDWIDTH _Ant1_2441



Date: 25.APR.2022 14:32:29

99% OCCUPIED BANDWIDTH _Ant1_2441



Date: 25.APR.2022 14:33:10

20 dB EMISSION BANDWIDTH _Ant1_2480

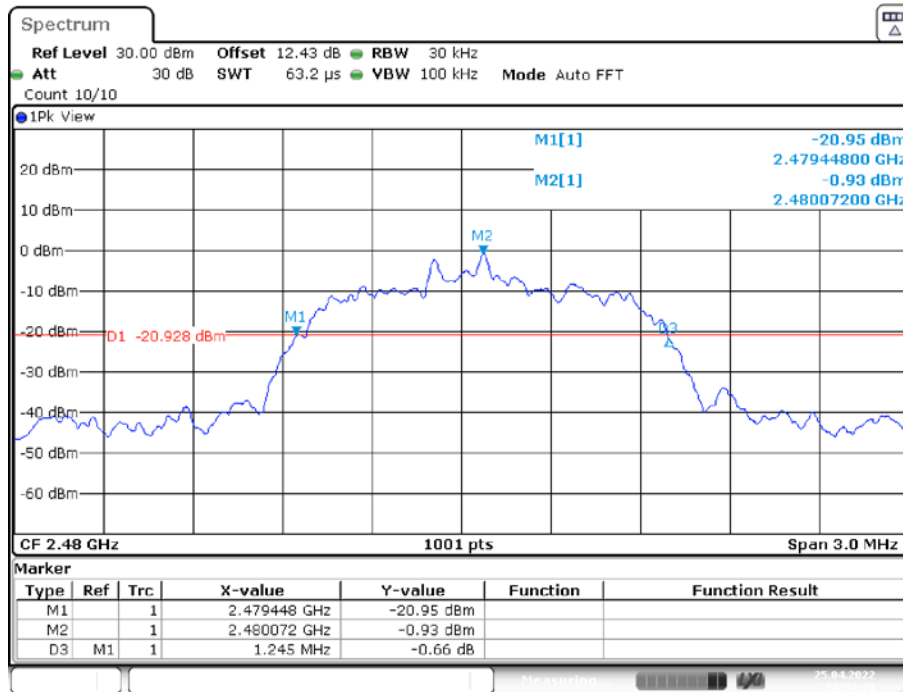

Date: 25.APR.2022 14:34:21

99% OCCUPIED BANDWIDTH _Ant1_2480

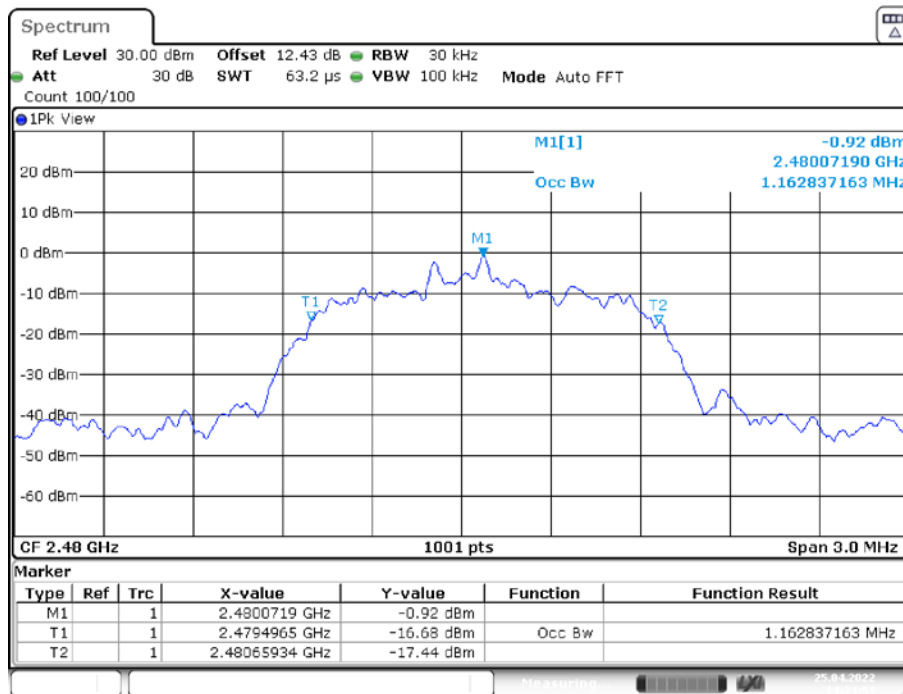

Date: 25.APR.2022 14:34:55

FCC §15.247(a) (1) (iii)-QUANTITY OF HOPPING CHANNEL TEST**Applicable Standard**

Frequency hopping systems in the 2400–2483.5 MHz band shall use at least 15 channels. The average time of occupancy on any channel shall not be greater than 0.4 seconds within a period of 0.4 seconds multiplied by the number of hopping channels employed. Frequency hopping systems may avoid or suppress transmissions on a particular hopping frequency provided that a minimum of 15 channels are used.

Test Procedure

1. Check the calibration of the measuring instrument (SA) using either an internal calibrator or a known signal from an external generator.
2. Set the EUT in hopping mode from first channel to last.
3. By using the max-hold function record the quantity of the channel.

Test Data**Environmental Conditions**

Temperature:	23°C
Relative Humidity:	51%
ATM Pressure:	101.1 kPa

The testing was performed by Key.Pei on 2022-04-25.

EUT operation mode: Transmitting

Test Result: Compliant.

TestMode	Antenna	Channel	Result[Num]	Limit[Num]	Verdict
BDR(GFSK)	Ant1	Hop	79	>=15	PASS
EDR($\pi/4$ DQPSK)	Ant1	Hop	79	>=15	PASS
ERD(8DPSK)	Ant1	Hop	79	>=15	PASS

Please refer to the below plots:

BDR(GFSK) _Ant1_Hop

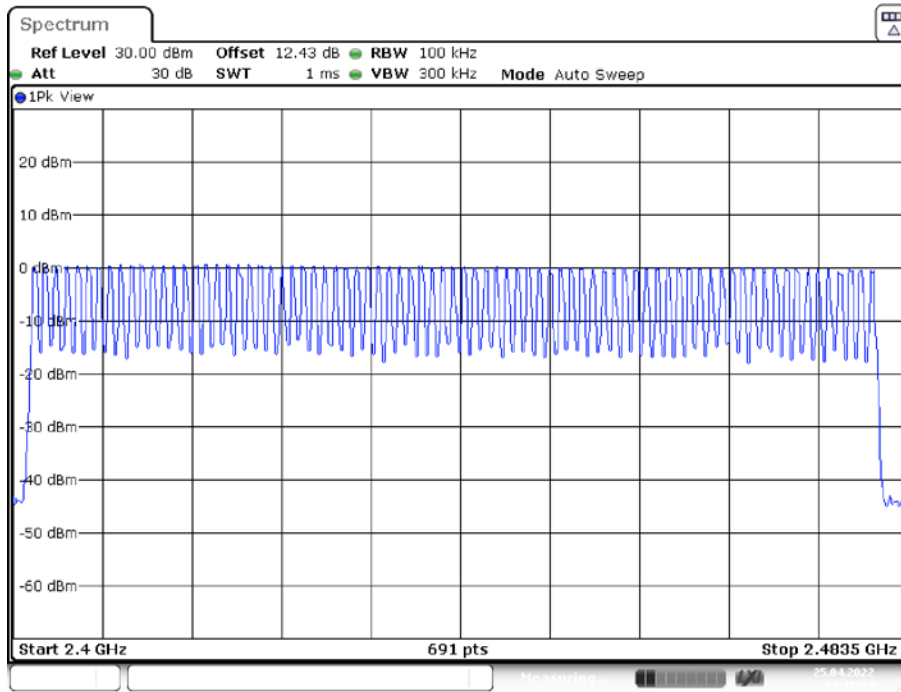

Date: 25.APR.2022 14:38:13

EDR($\pi/4$ DQPSK) _Ant1_Hop

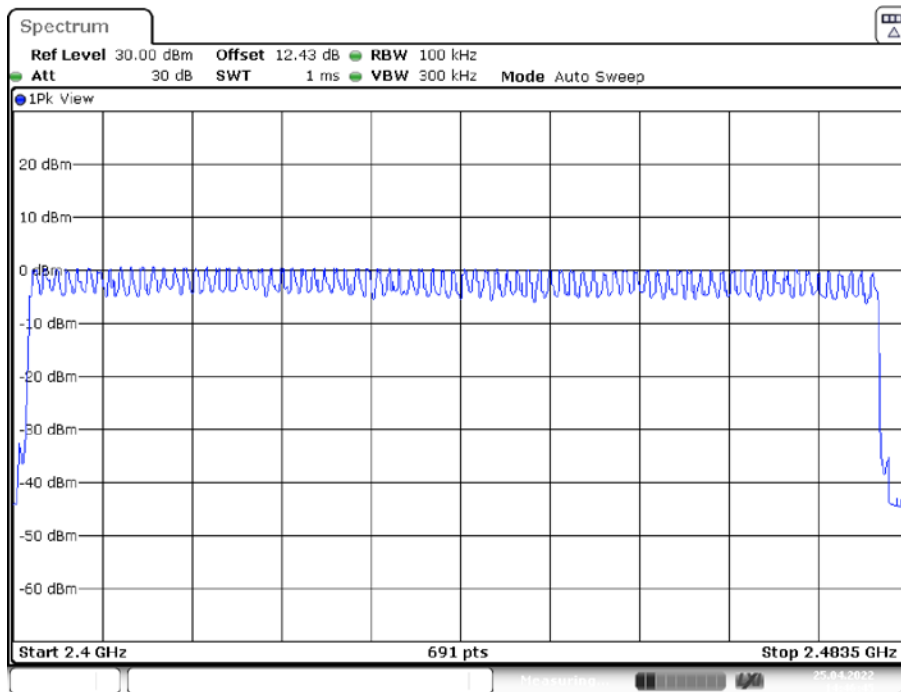

Date: 25.APR.2022 14:46:45

EDR(8DPSK) _Ant1_ Hop

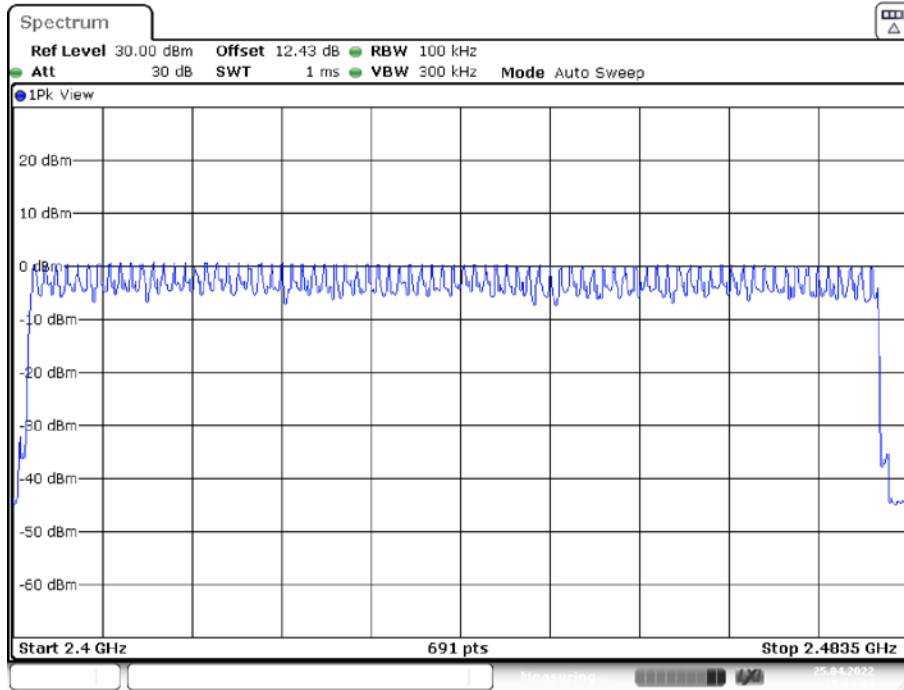

Date: 25.APR.2022 15:04:05

FCC §15.247(a) (1) (iii) - TIME OF OCCUPANCY (DWELL TIME)**Applicable Standard**

Frequency hopping systems in the 2400-2483.5 MHz shall use at least 15 channels. The average time of occupancy on any channel shall not be greater than 0.4 seconds within a period of 0.4 seconds multiplied by the number of hopping channels employed. Frequency hopping systems may avoid or suppress transmissions on a particular hopping frequency provided that a minimum of 15 channels are used.

Test Procedure

1. The EUT was worked in channel hopping.
2. Set the RBW to: 1MHz.
3. Set the VBW $\geq 3 \times$ RBW.
4. Set the span to 0Hz.
5. Detector = peak.
6. Sweep time = auto couple.
7. Trace mode = max hold.
8. Allow trace to fully stabilize.
9. Recorded the time of single pulses

Test Data**Environmental Conditions**

Temperature:	23 °C
Relative Humidity:	51 %
ATM Pressure:	101.1 kPa

The testing was performed by Key.Pei on 2022-04-25.

EUT operation mode: Transmitting

Test Result: Compliant.

TestMode	Antenna	Channel	BurstWidth [ms]	TotalHops [Num]	Result[s]	Limit[s]	Verdict
DH1	Ant1	Hop	0.41	320	0.13	≤ 0.4	PASS
DH3	Ant1	Hop	1.66	190	0.314	≤ 0.4	PASS
DH5	Ant1	Hop	2.90	120	0.348	≤ 0.4	PASS
2DH1	Ant1	Hop	0.42	330	0.138	≤ 0.4	PASS
2DH3	Ant1	Hop	1.66	180	0.299	≤ 0.4	PASS
2DH5	Ant1	Hop	2.90	120	0.348	≤ 0.4	PASS
3DH1	Ant1	Hop	0.42	320	0.134	≤ 0.4	PASS
3DH3	Ant1	Hop	1.66	190	0.316	≤ 0.4	PASS
3DH5	Ant1	Hop	2.91	120	0.349	≤ 0.4	PASS

Note 1: A period time= $0.4 \times 79 = 31.6$ (s), Result=Burst Width*Total Hops

Note 2: Total Hops =Hopping Number in $3.16s \times 10$

Note 3: Hopping Number in $3.16s =$ Total of highest signals in $3.16s$ (Second high signals were other channel)

BDR(GFSK):

DH1_Ant1_Hop

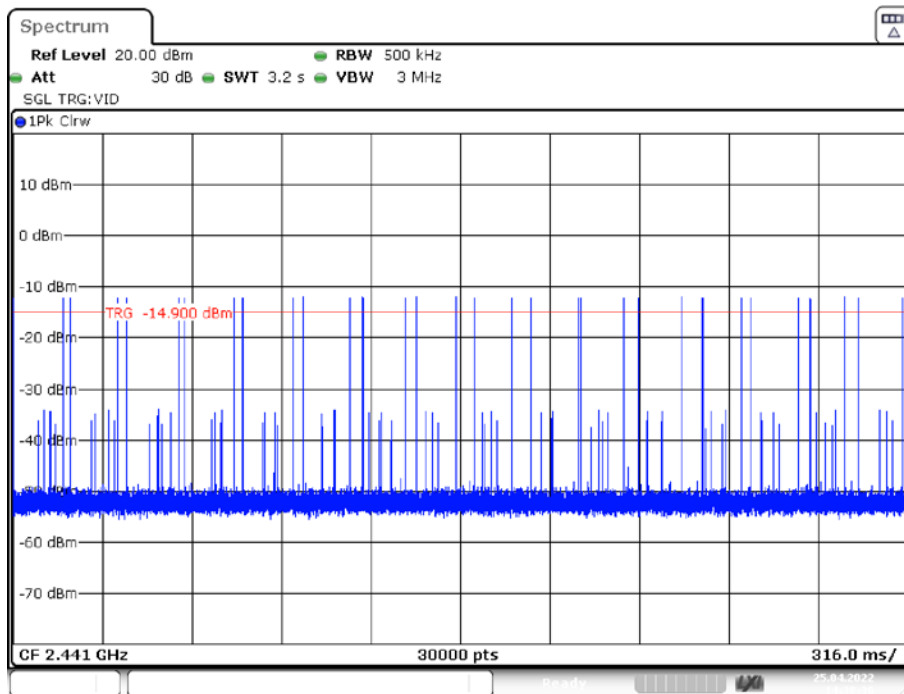
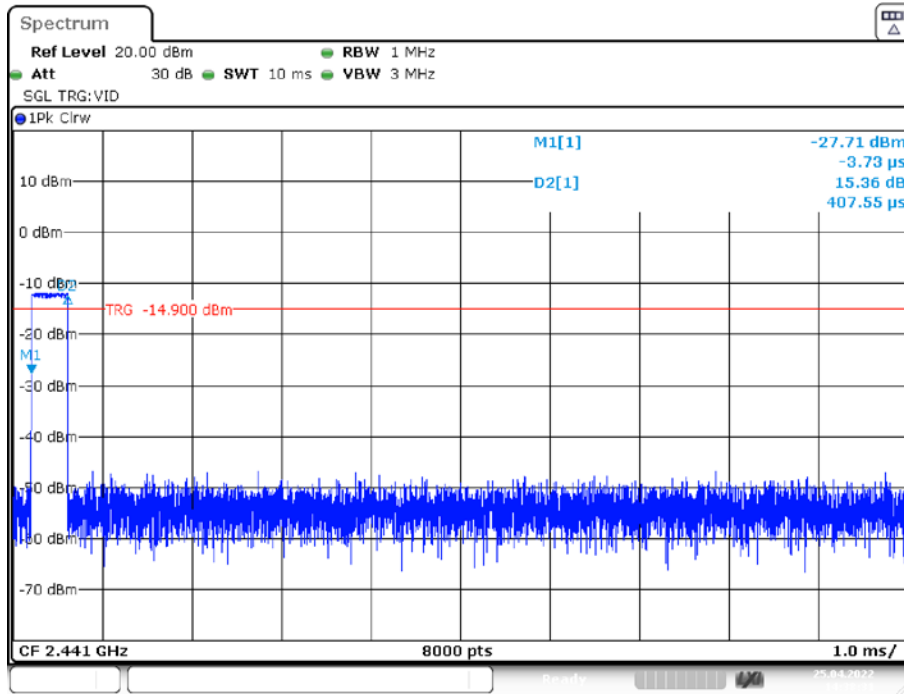

DH3_Ant1_Hop

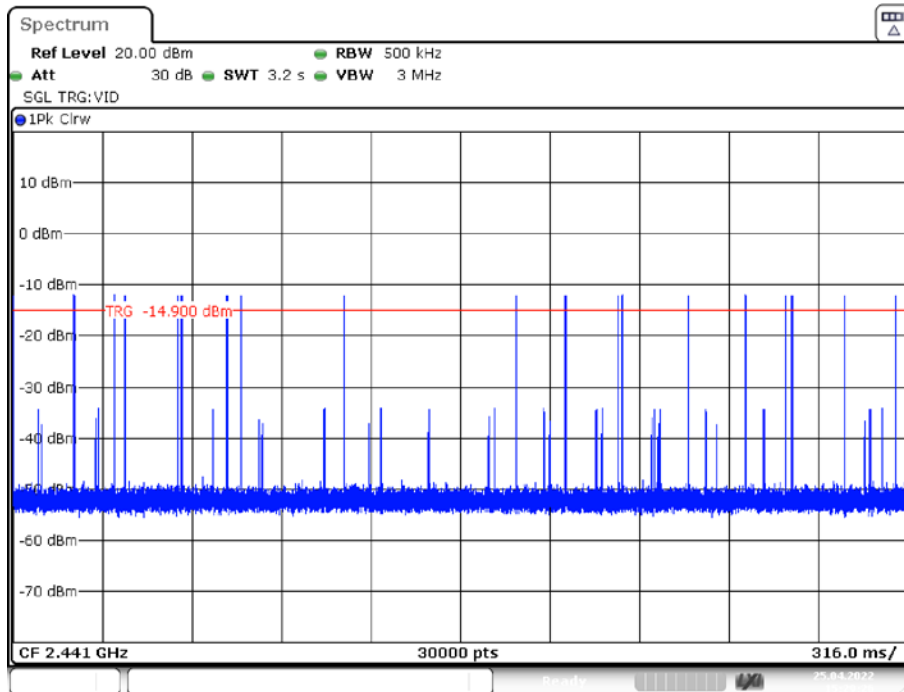
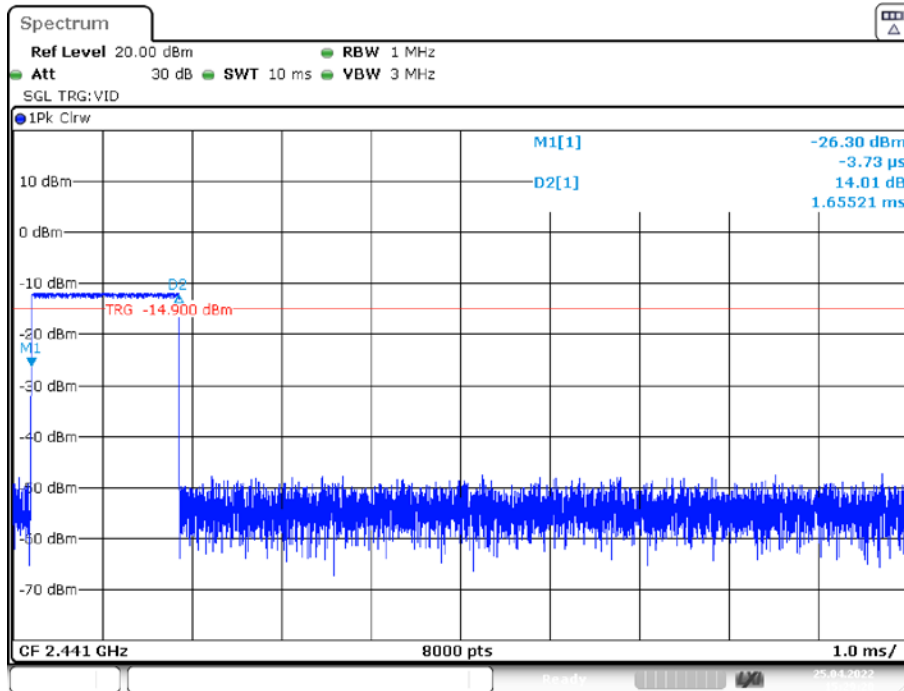

DH5_Ant1_Hop

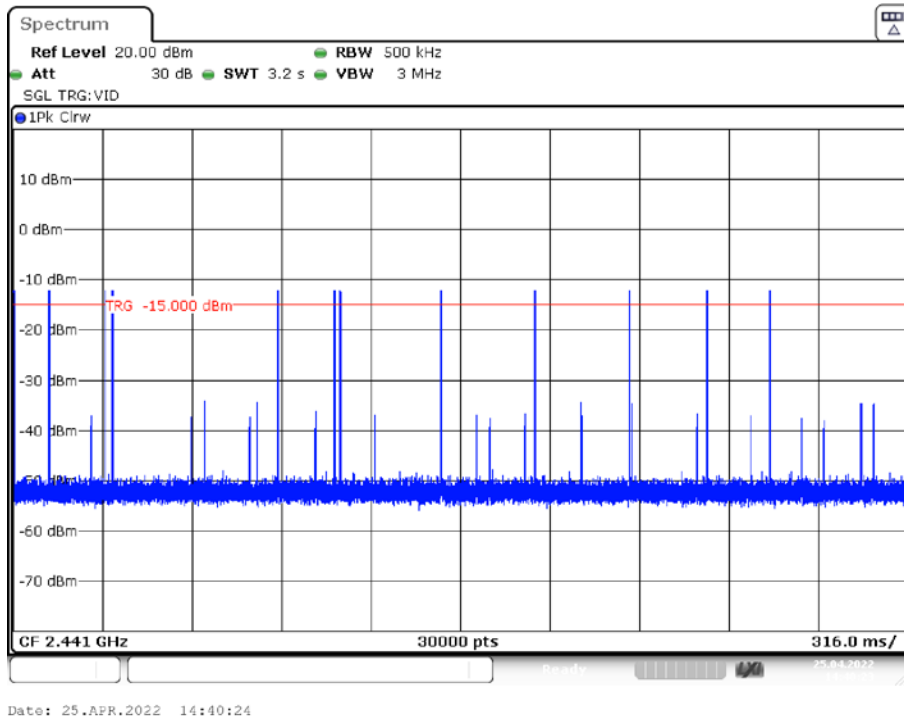
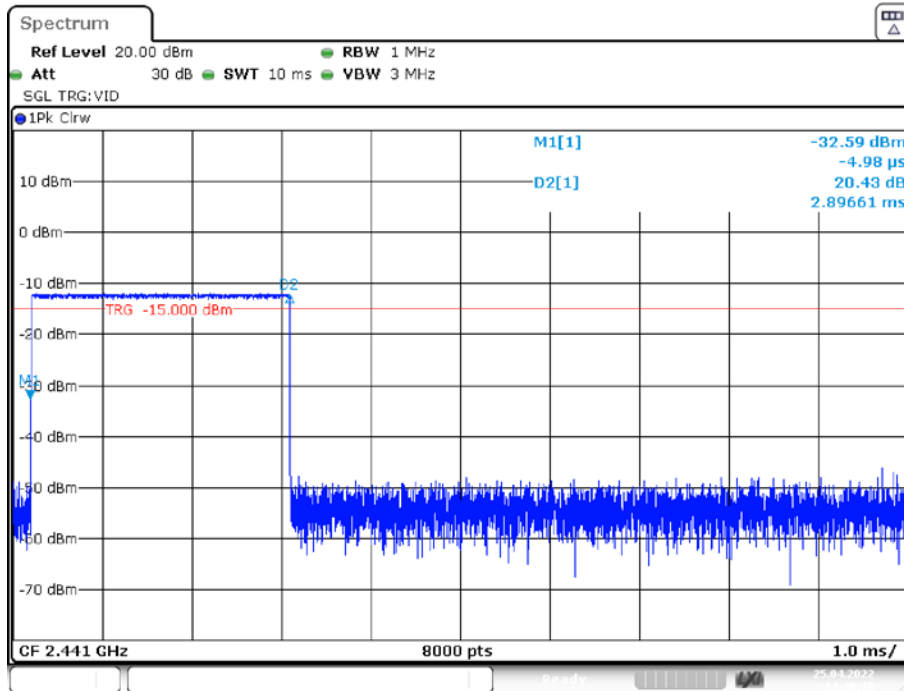

EDR($\pi/4$ -DQPSK):

2DH1_Ant1_Hop

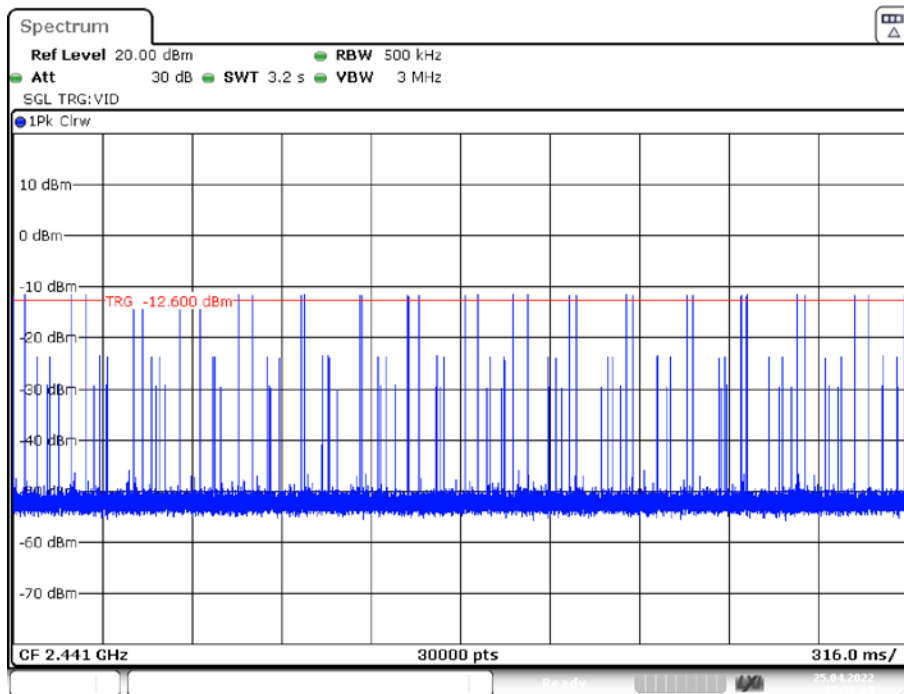
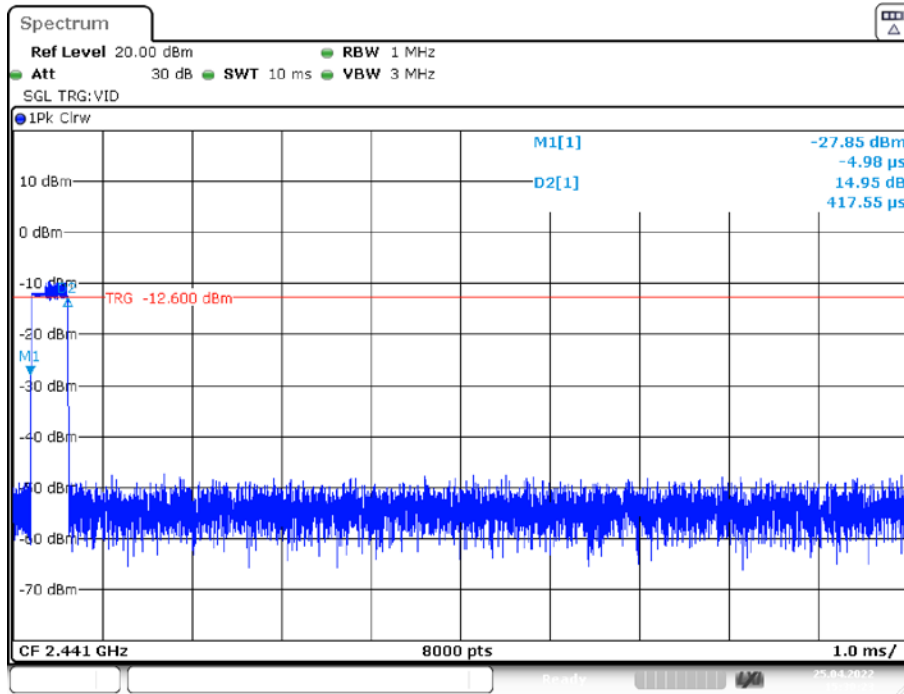

2DH3_Ant1_Hop

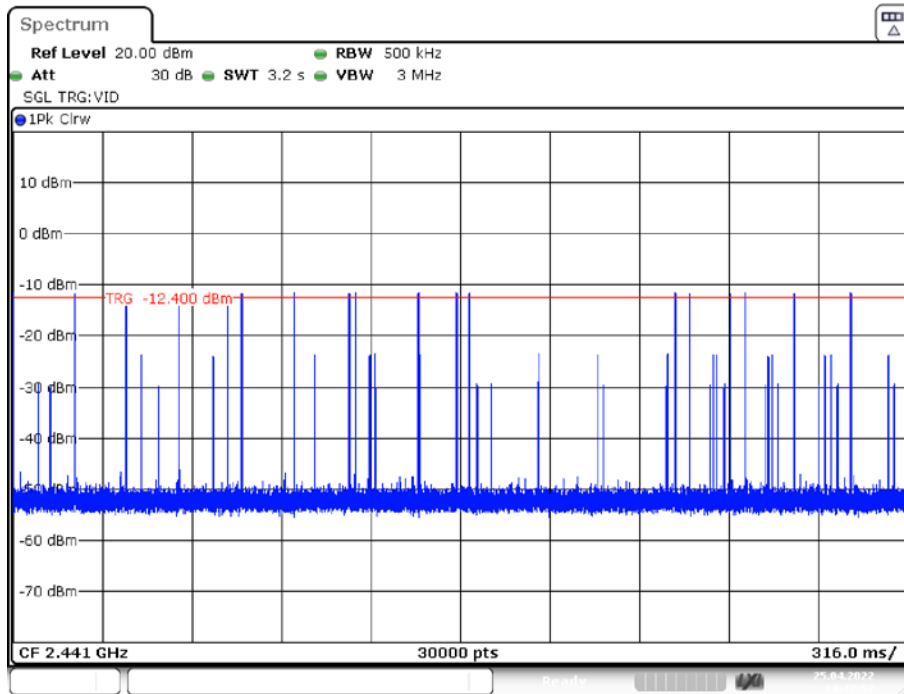
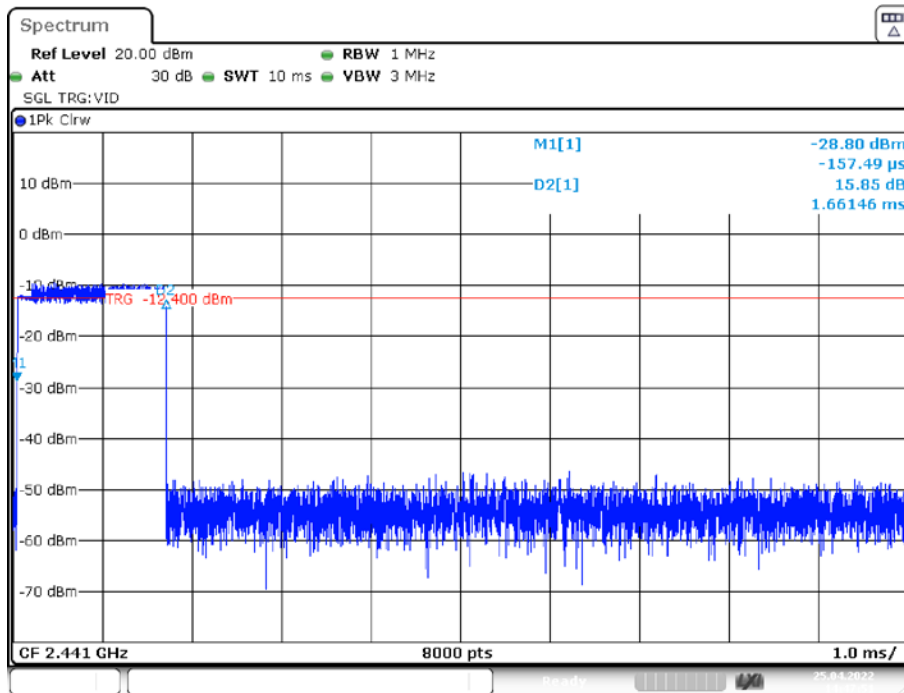

2DH5_Ant1_Hop

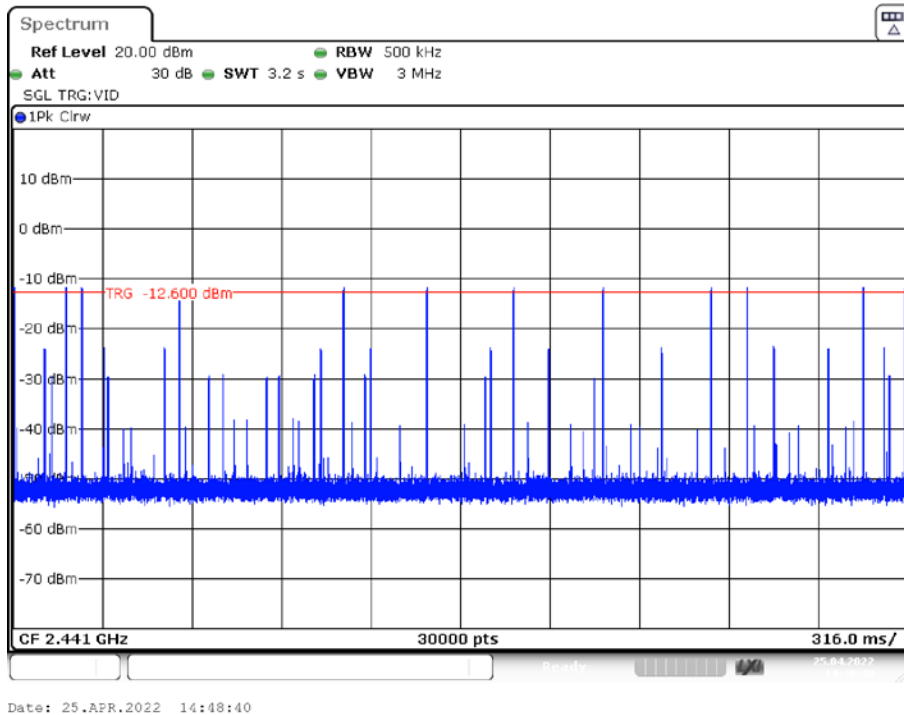
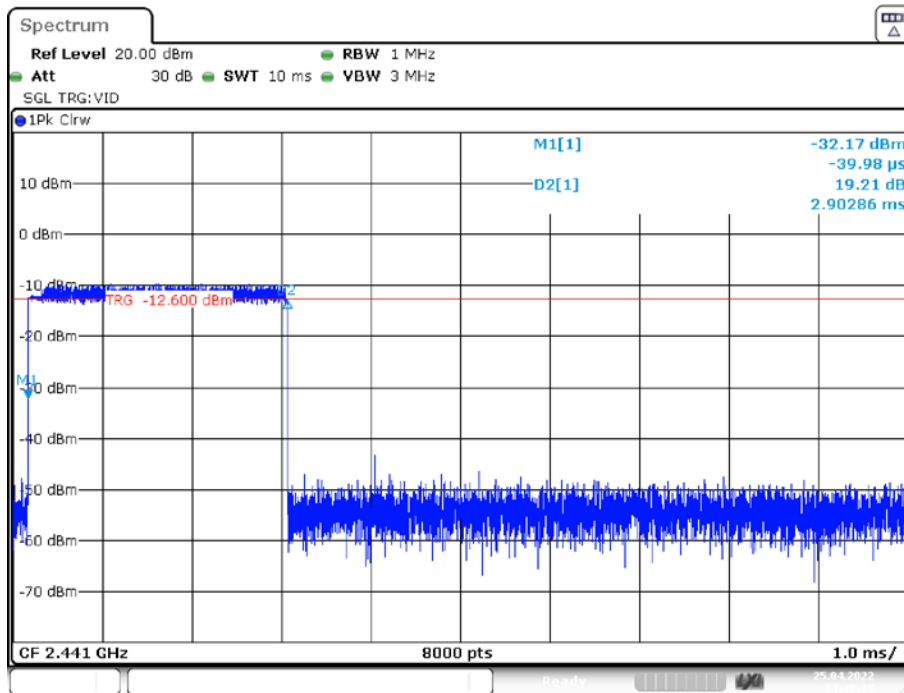

EDR(8DPSK):

3DH1_Ant1_Hop

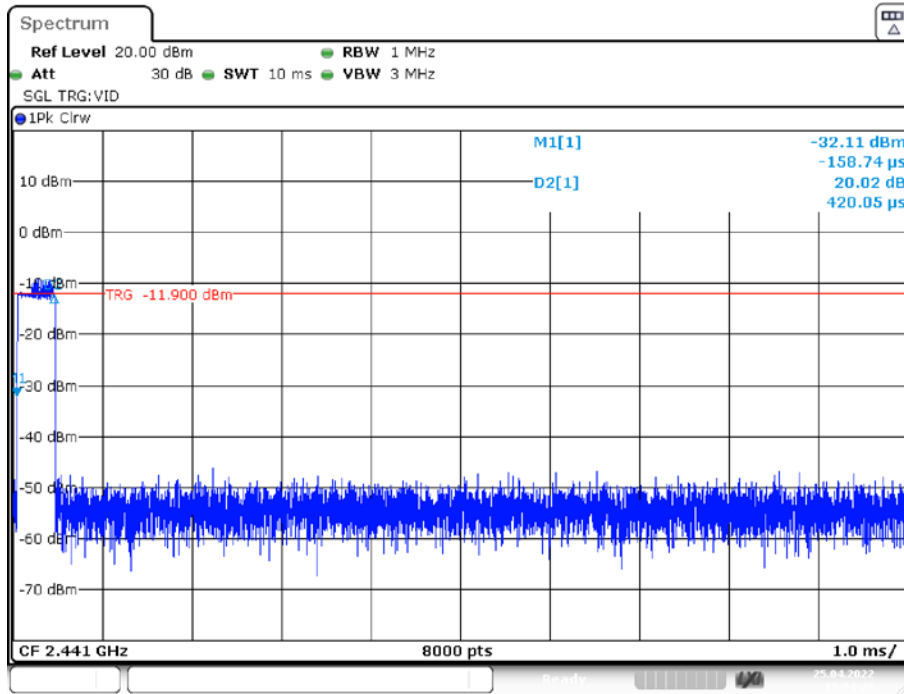

Date: 25.APR.2022 15:04:29

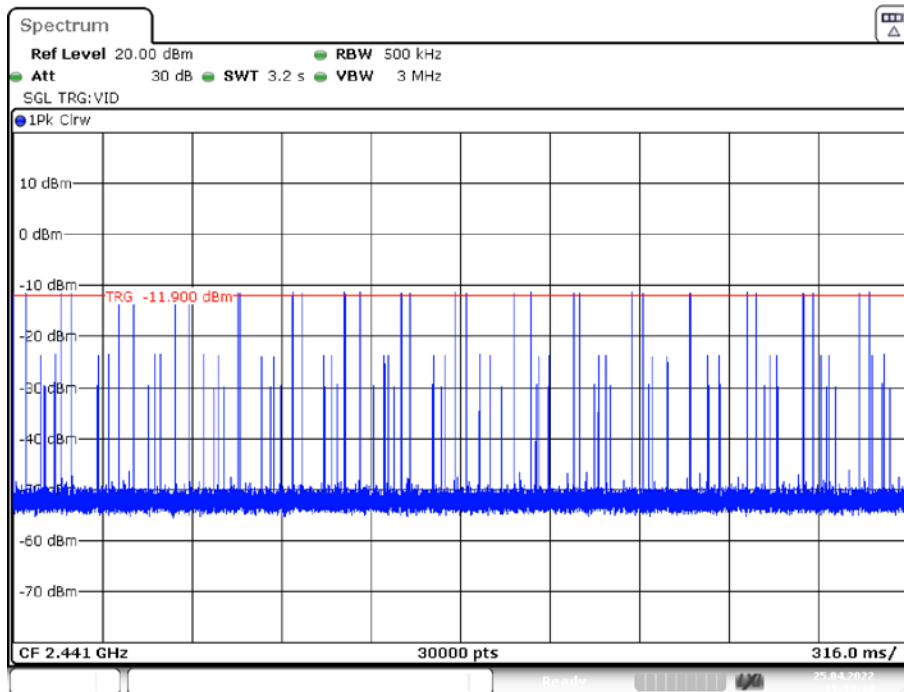

Date: 25.APR.2022 15:04:34

3DH3_Ant1_Hop

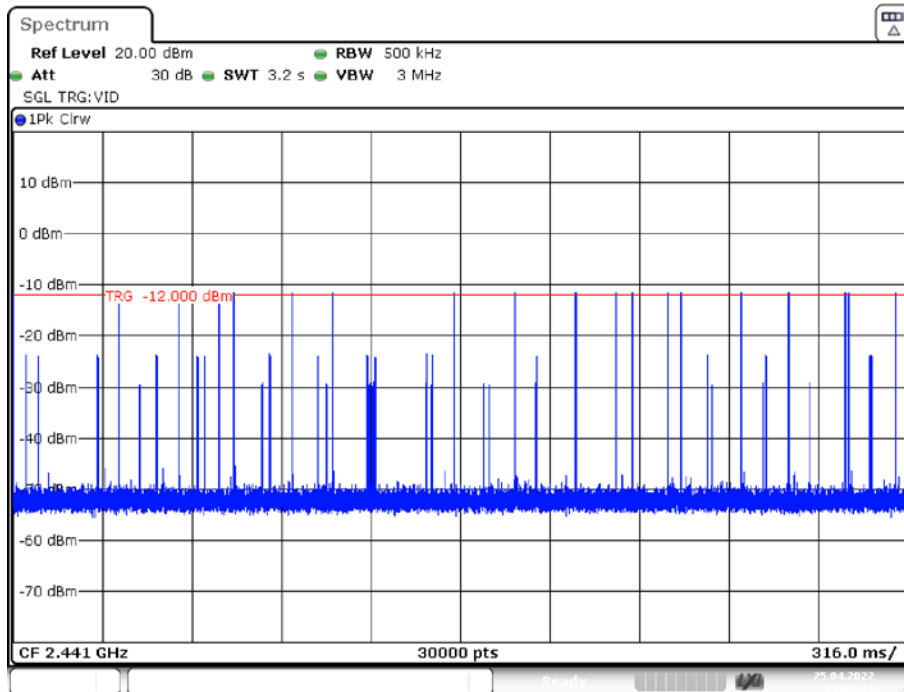
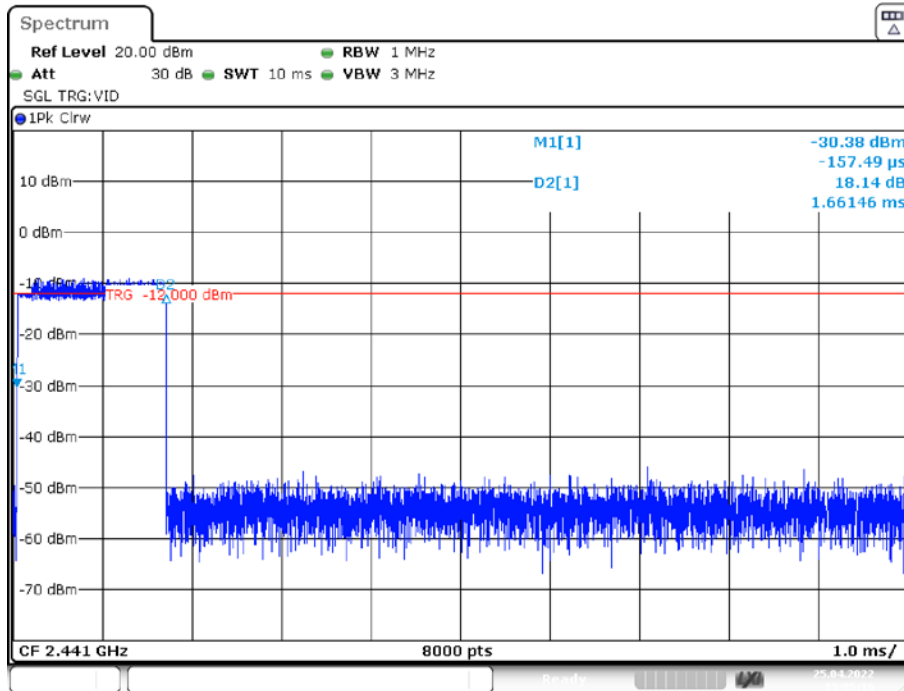

3DH5_Ant1_Hop

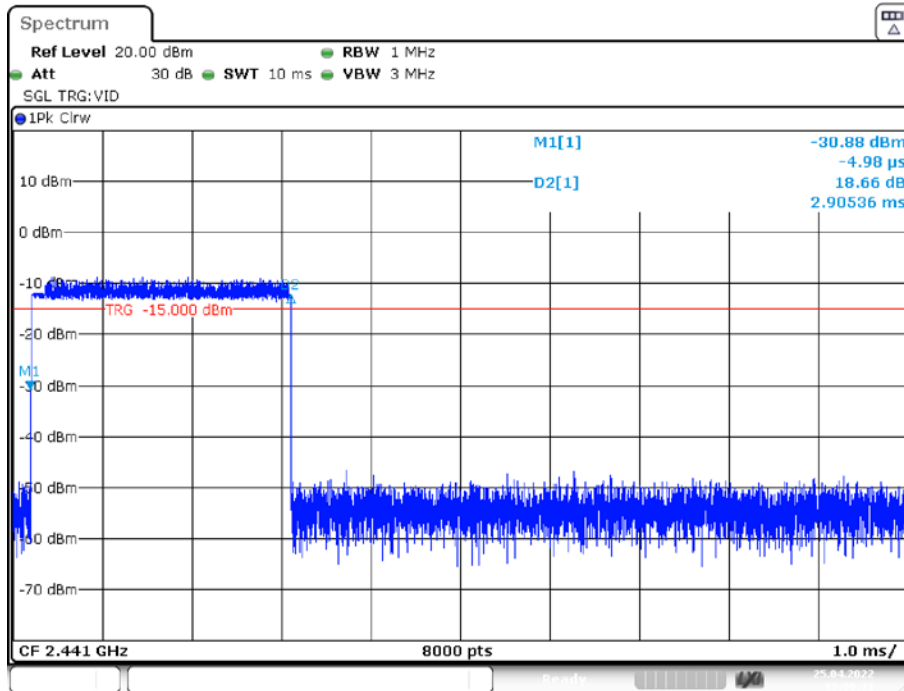

Date: 25.APR.2022 15:09:31

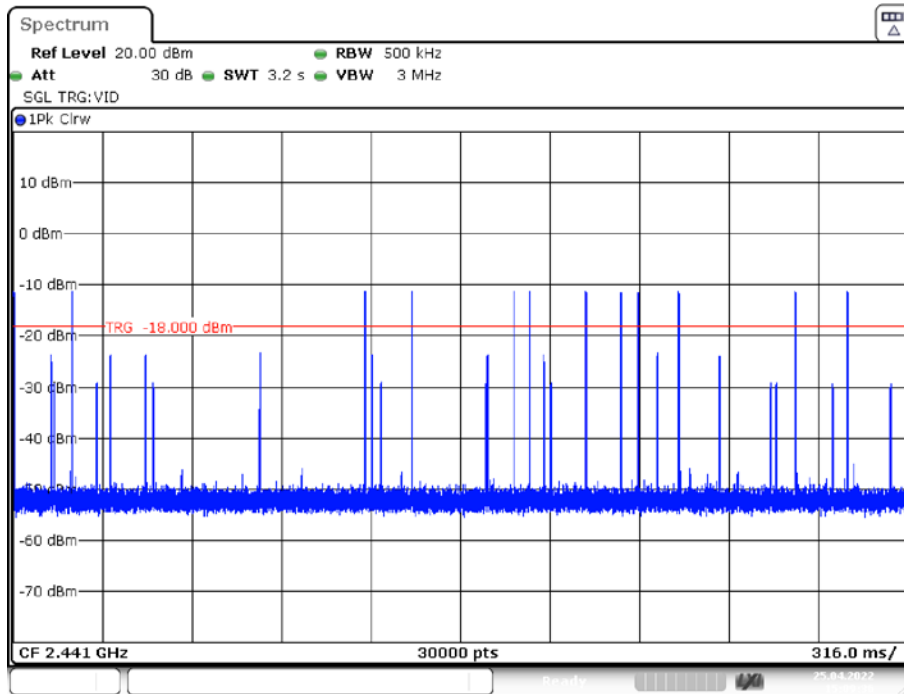

Date: 25.APR.2022 15:09:37

FCC §15.247(b) (1) - PEAK OUTPUT POWER MEASUREMENT

Applicable Standard

According to §15.247(b) (1), for frequency hopping systems operating in the 2400–2483.5 MHz band employing at least 75 non-overlapping hopping channels, and all frequency hopping systems in the 5725-5850 MHz band: 1 watt. And for all other frequency hopping systems in the 2400–2483.5 MHz band: 0.125 watts.

Test Procedure

1. Place the EUT on a bench and set in transmitting mode.
2. Remove the antenna from the EUT and then connect a low loss RF cable from the antenna port to one test equipment.
3. Add a correction factor to the display.

Test Data

Environmental Conditions

Temperature:	20°C
Relative Humidity:	45 %
ATM Pressure:	101.2 kPa

The testing was performed by Key.Pei on 2022-04-25.

EUT operation mode: Transmitting

Test Result: Compliant.

TestMode	Antenna	Channel	Conducted peak output power [dBm]	Limit[dBm]	Verdict
BDR(GFSK)	Ant1	2402	0.77	≤20.97	PASS
		2441	0.73	≤20.97	PASS
		2480	0.22	≤20.97	PASS
EDR($\pi/4$ DQPSK)	Ant1	2402	3.67	≤20.97	PASS
		2441	3.55	≤20.97	PASS
		2480	2.83	≤20.97	PASS
EDR (8DPSK)	Ant1	2402	4.58	≤20.97	PASS
		2441	4.34	≤20.97	PASS
		2480	3.57	≤20.97	PASS

Please refer to the below plots:

BDR(GFSK):

Low Channel

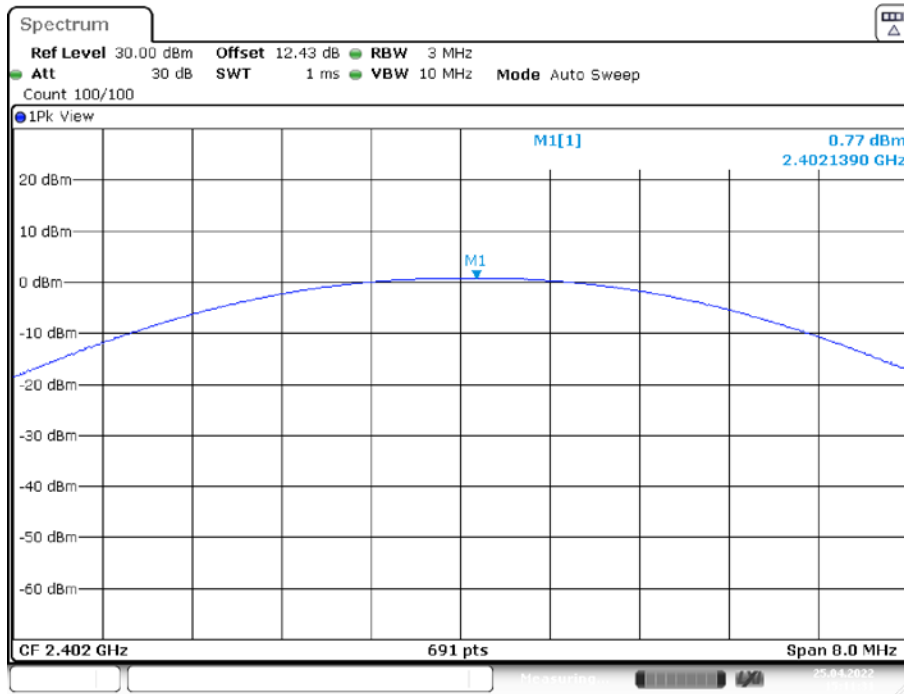

Date: 25.APR.2022 15:11:32

Middle Channel

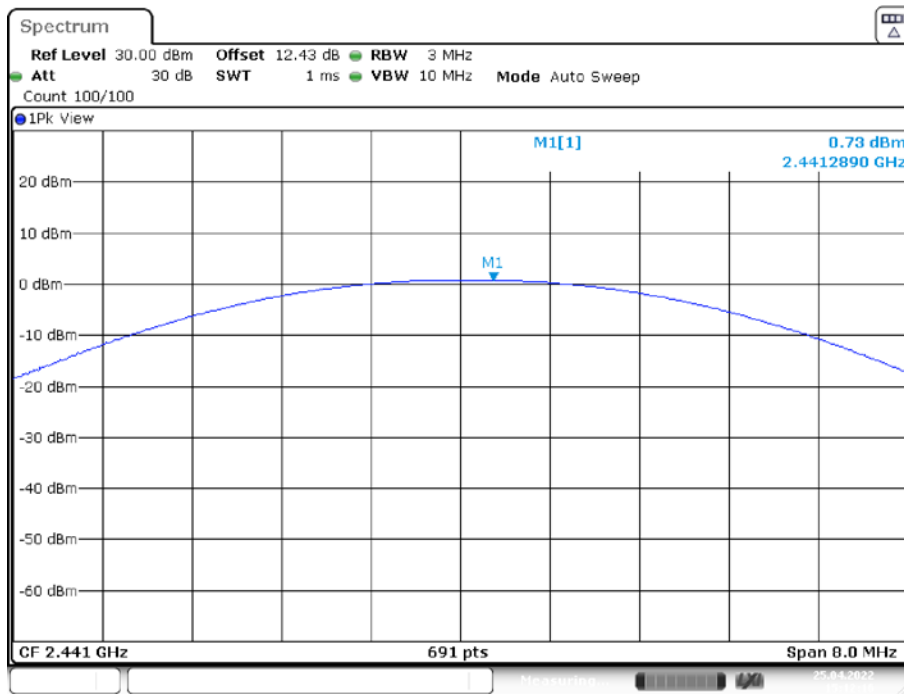

Date: 25.APR.2022 15:12:17

High Channel

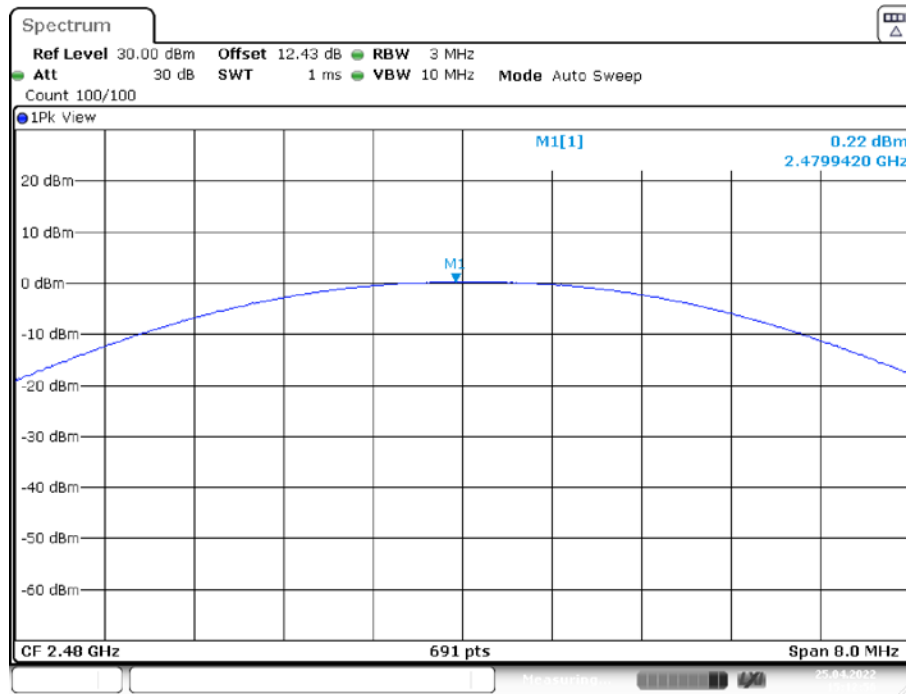

Date: 25.APR.2022 15:12:57

EDR($\pi/4$ DQPSK):

Low Channel

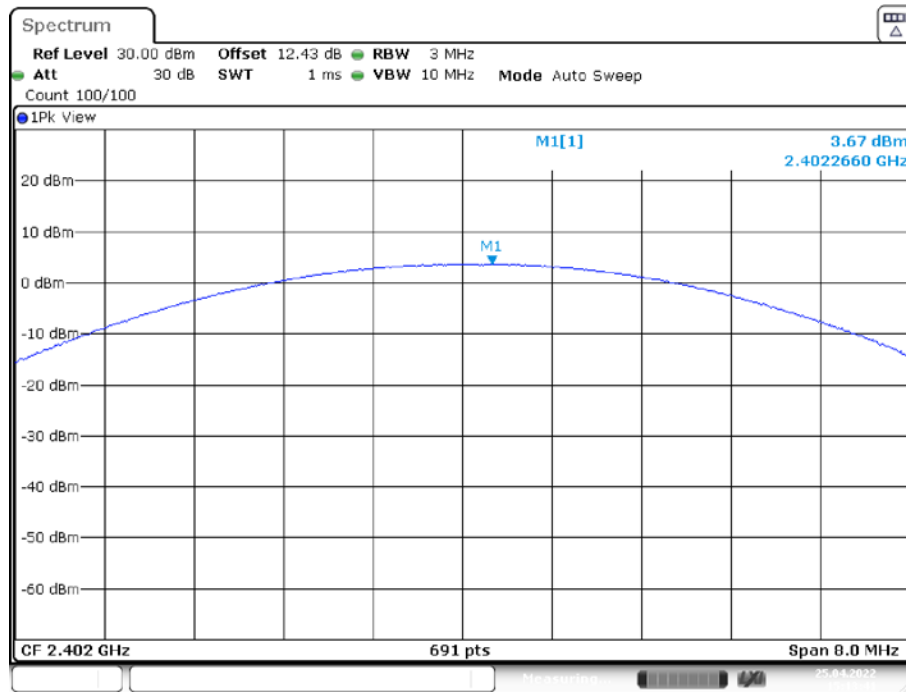

Date: 25.APR.2022 15:13:41

Middle Channel

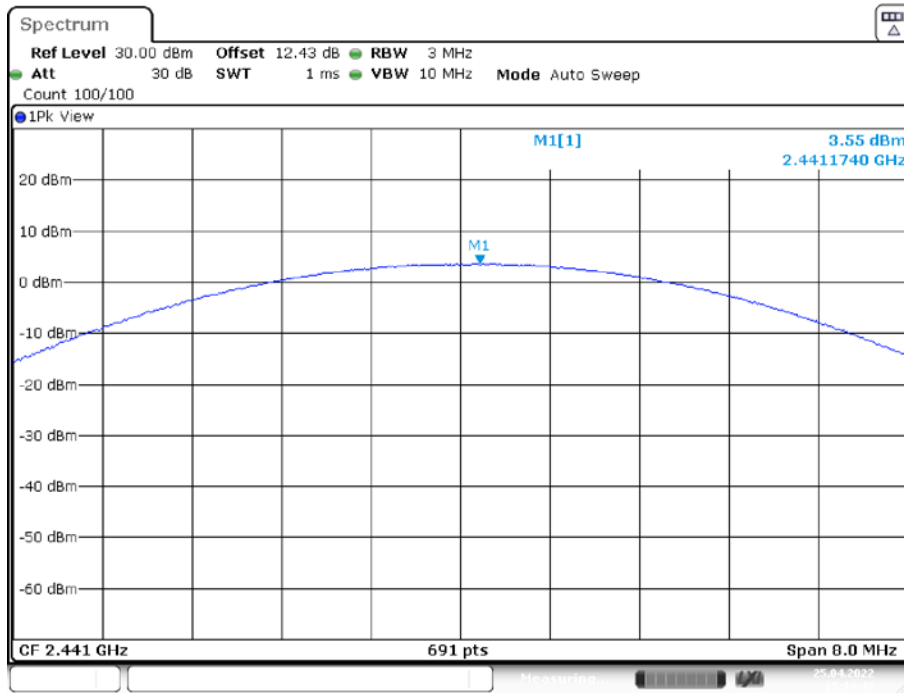

Date: 25.APR.2022 15:14:42

High Channel

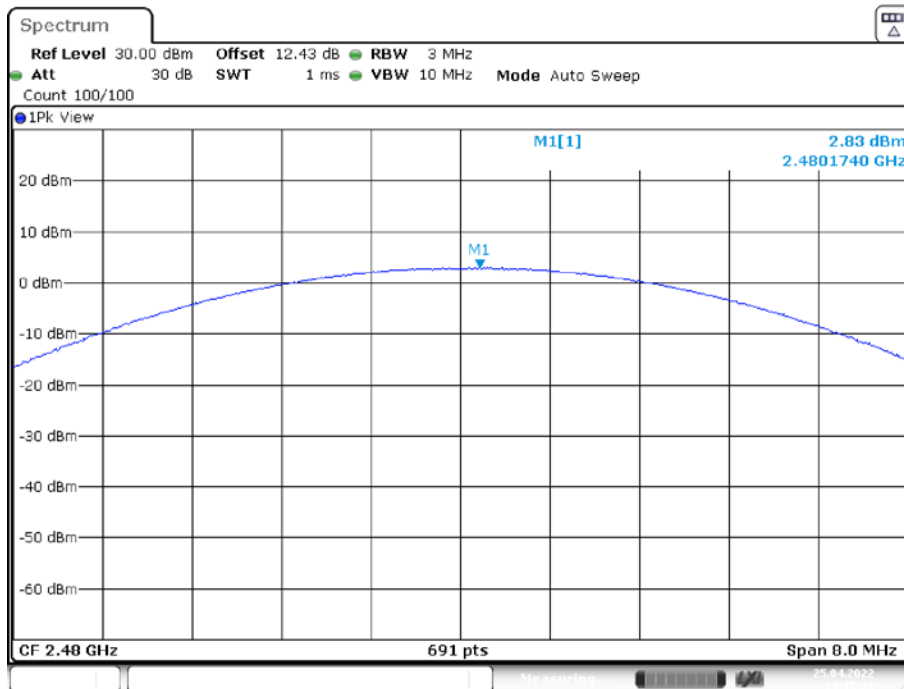

Date: 25.APR.2022 15:15:20

EDR(8DPSK):

Low Channel

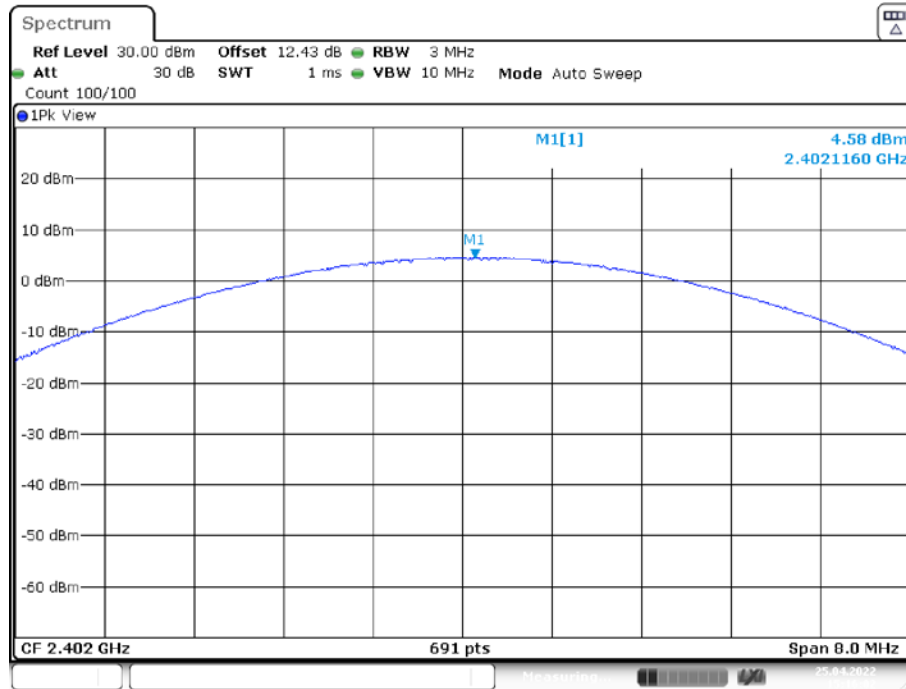

Date: 25.APR.2022 15:16:02

Middle Channel

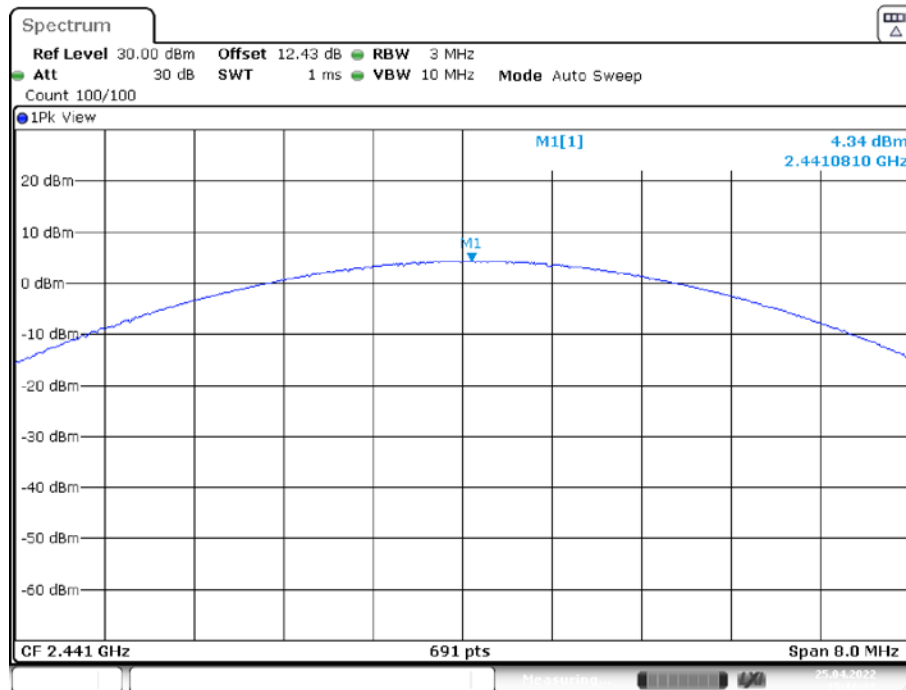

Date: 25.APR.2022 15:16:33

High Channel

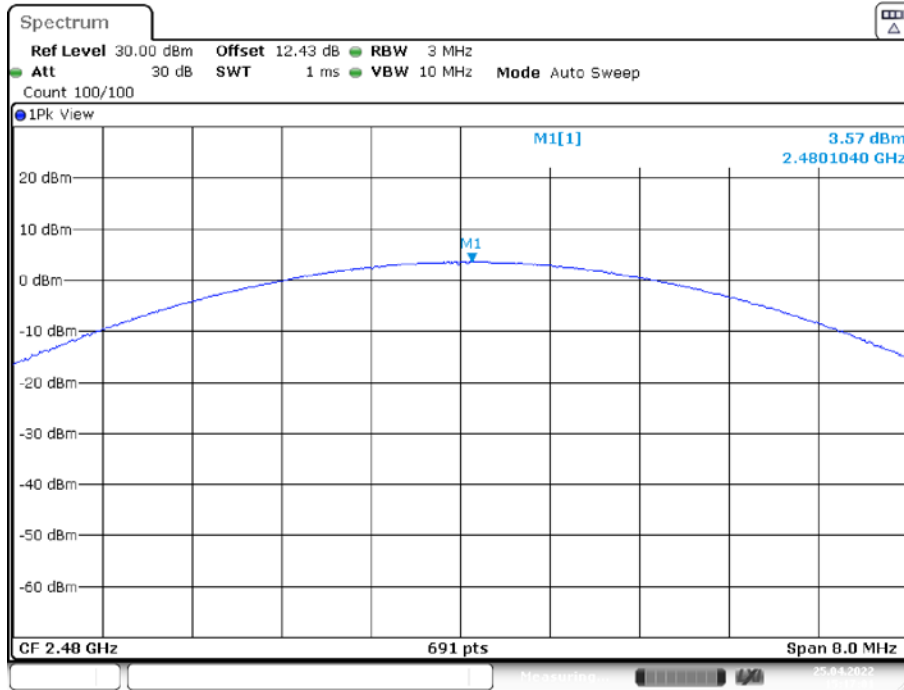

Date: 25.APR.2022 15:17:02

FCC §15.247(d) - BAND EDGES TESTING

Applicable Standard

In any 100 kHz bandwidth outside the frequency band in which the spread spectrum or digitally modulated intentional radiator is operating, the radio frequency power that is produced by the intentional radiator shall be at least 20 dB below that in the 100 kHz bandwidth within the band that contains the highest level of the desired power, based on either an RF conducted or a radiated measurement, provided the transmitter demonstrates compliance with the peak conducted power limits. If the transmitter complies with the conducted power limits based on the use of RMS averaging over a time interval, as permitted under paragraph (b)(3) of this section, the attenuation required under this paragraph shall be 30 dB instead of 20 dB. Attenuation below the general limits specified in §15.209(a) is not required. In addition, radiated emissions which fall in the restricted bands, as defined in §15.205(a), must also comply with the radiated emission limits specified in §15.209(a) (see §15.205(c)).

Test Procedure

1. Check the calibration of the measuring instrument using either an internal calibrator or a known signal from an external generator.
2. Remove the antenna from the EUT and then connect to a low loss RF cable from the antenna port to a EMI test receiver, then turn on the EUT and make it operate in transmitting mode. Then set it to Low Channel and High Channel within its operating range, and make sure the instrument is operated in its linear range.
3. Set RBW of spectrum analyzer to 100 kHz with a convenient frequency span including 100 kHz bandwidth from band edge.
4. Measure the highest amplitude appearing on spectral display and set it as a reference level. Plot the graph with marking the highest point and edge frequency.
5. Repeat above procedures until all measured frequencies were complete.

Test Data

Environmental Conditions

Temperature:	23°C
Relative Humidity:	51 %
ATM Pressure:	101.1kPa

The testing was performed by Key.Pei on 2022-04-25.

EUT operation mode: Transmitting

Test Result: Compliant

Please refer to the below plots:

BDR(GFSK):

BDR(GFSK): Band Edge-Left Side Hopping

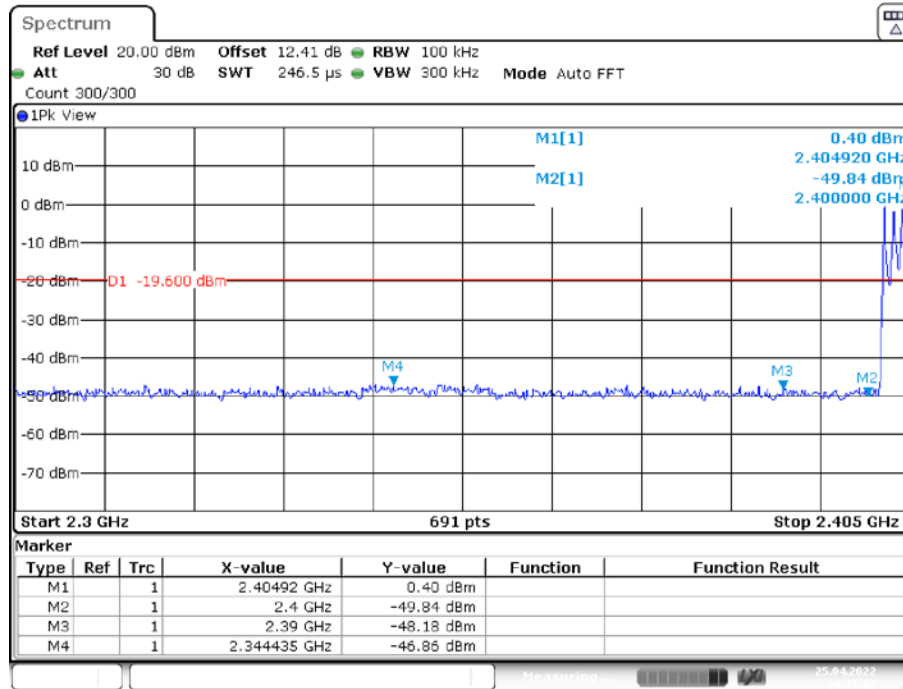

Date: 25.APR.2022 14:37:02

Single

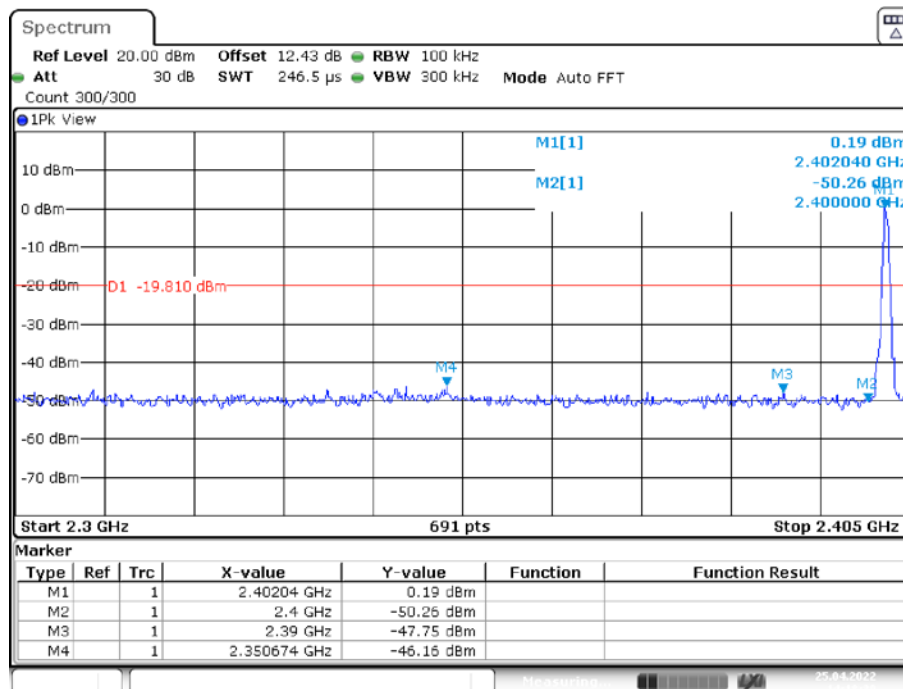

Date: 25.APR.2022 14:18:40

BDR(GFSK): Band Edge- Right Side Hopping

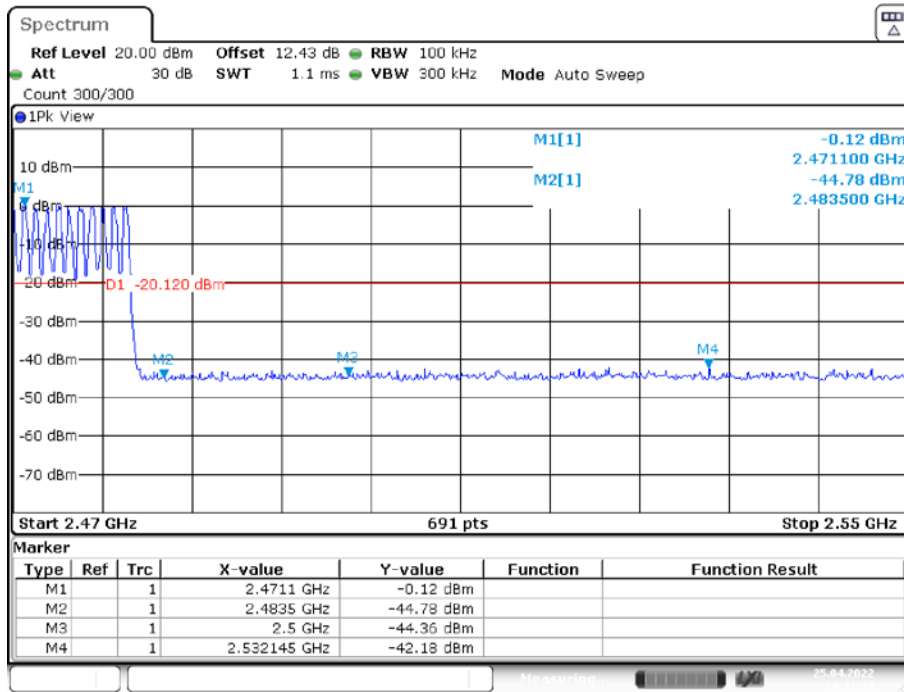

Single

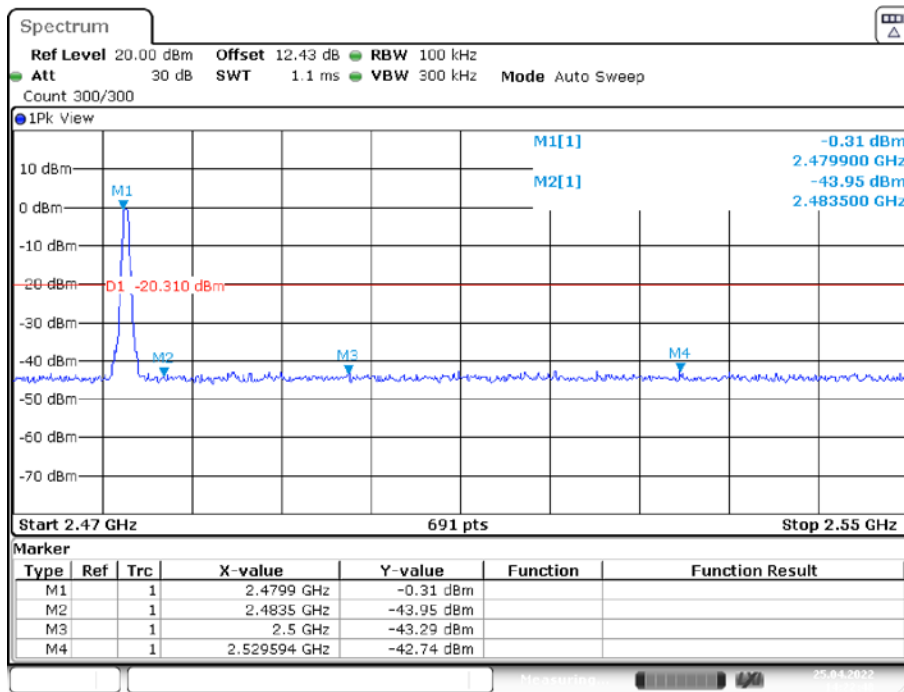

EDR ($\pi/4$ DQPSK):

EDR ($\pi/4$ DQPSK): Band Edge-Left Side Hopping

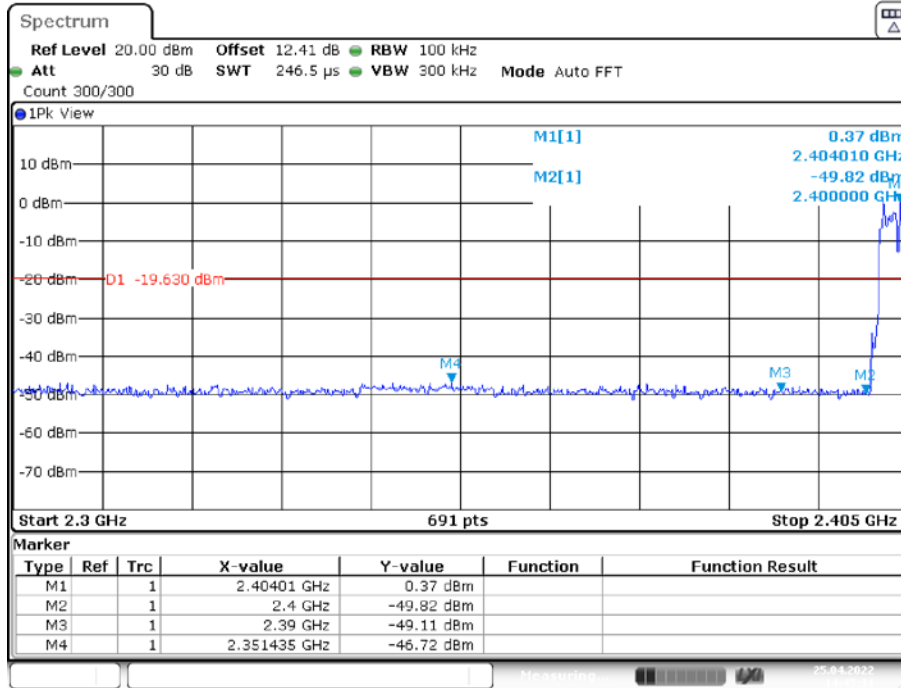

Date: 25.APR.2022 14:45:31

Single

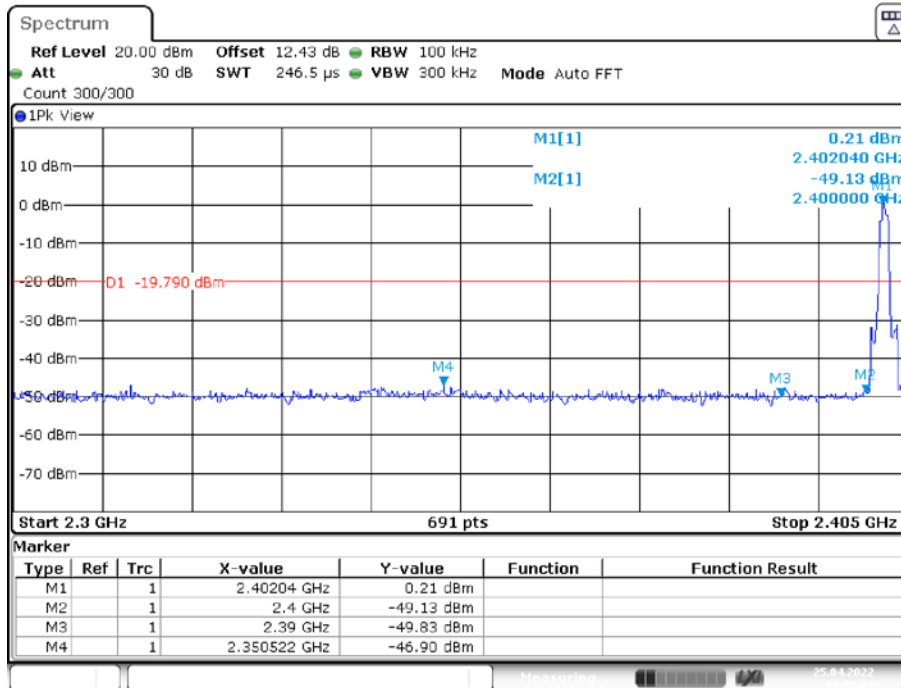

Date: 25.APR.2022 14:25:02

EDR ($\pi/4$ DQPSK): Band Edge- Right Side Hopping

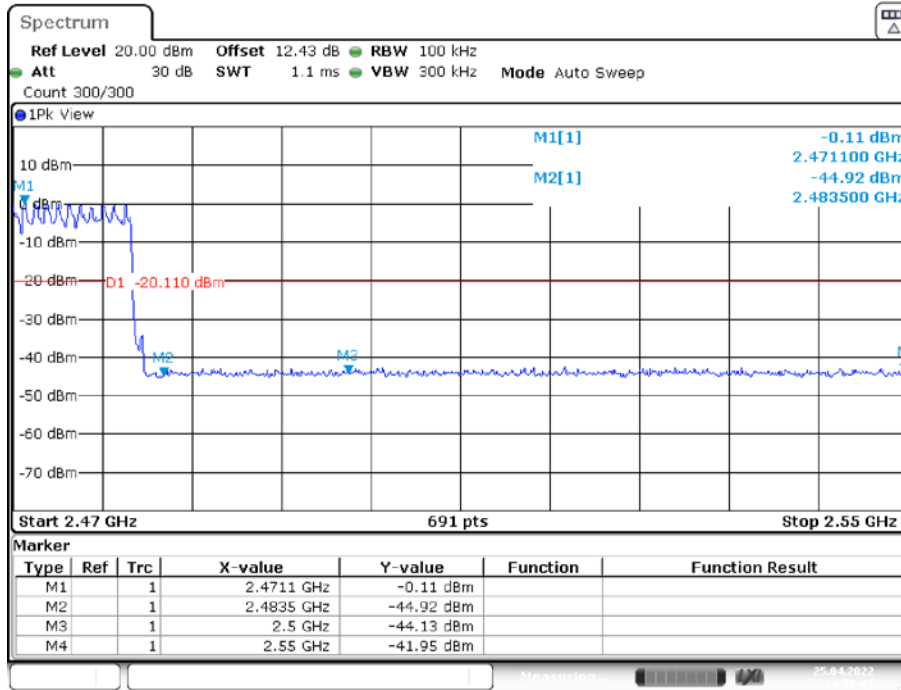

Date: 25.APR.2022 14:50:02

Single

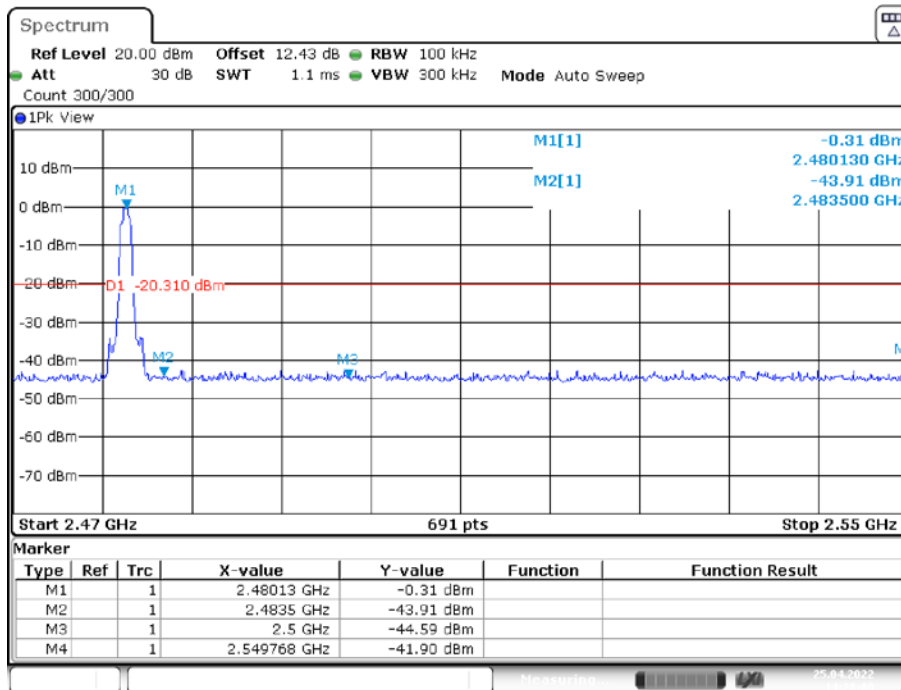

Date: 25.APR.2022 14:28:00

EDR (8DPSK):

EDR (8DPSK): Band Edge-Left Side Hopping

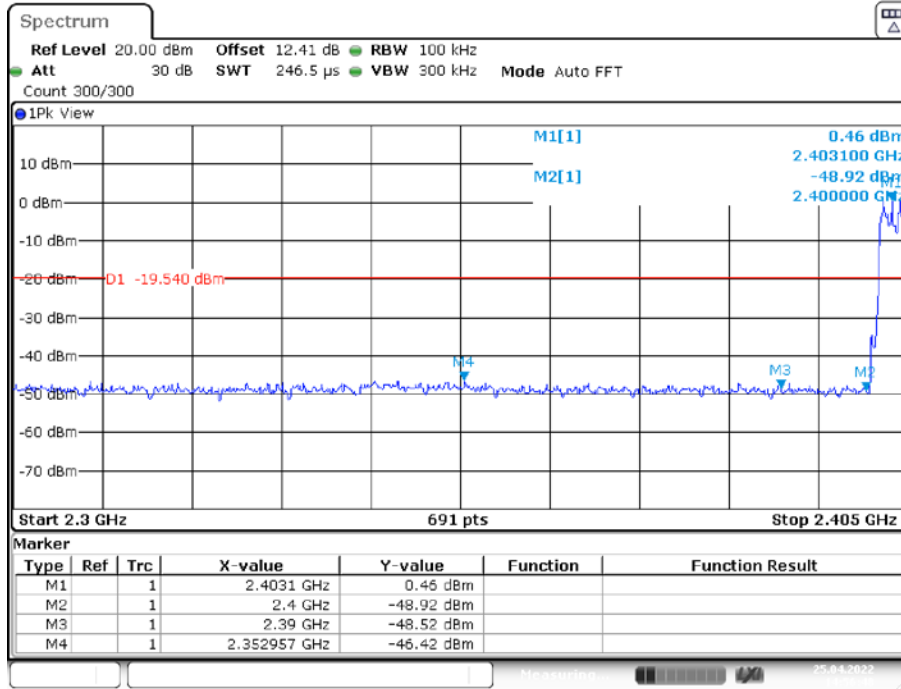

Date: 25.APR.2022 14:56:48

Single

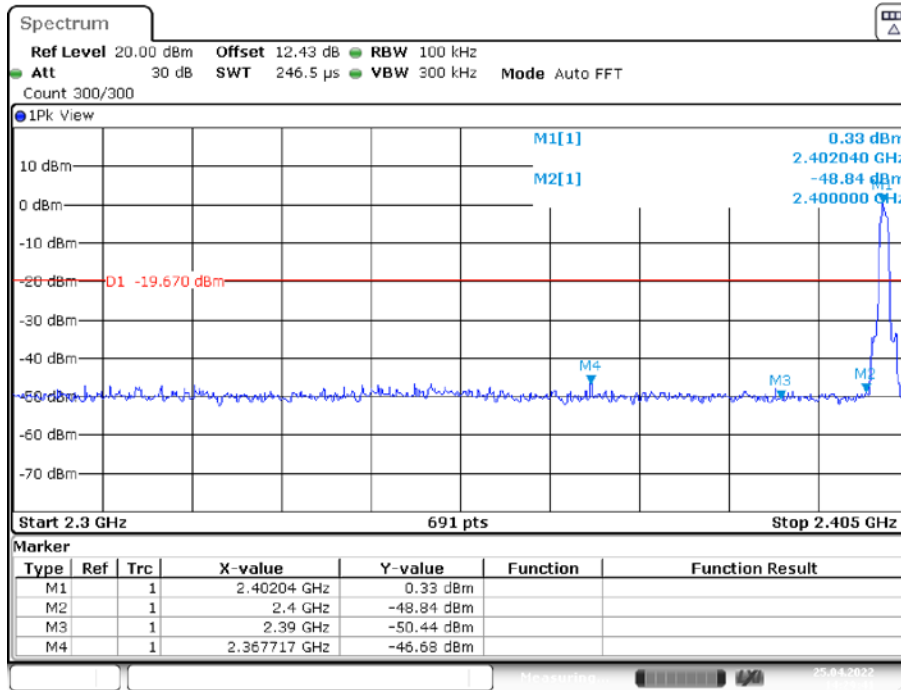

Date: 25.APR.2022 14:29:42

EDR (8DPSK): Band Edge- Right Side Hopping

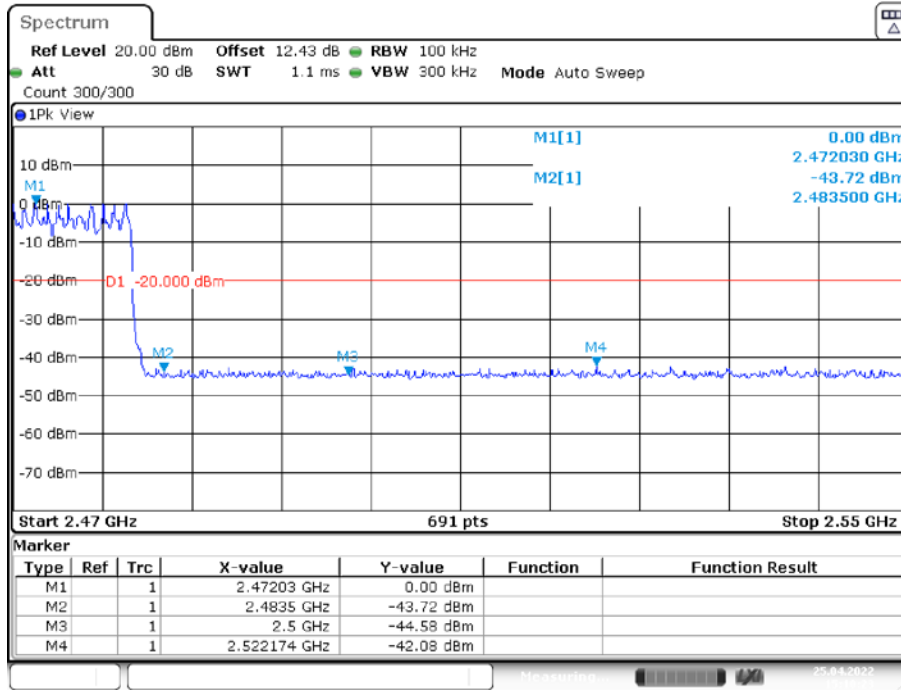

Date: 25.APR.2022 15:10:24

Single

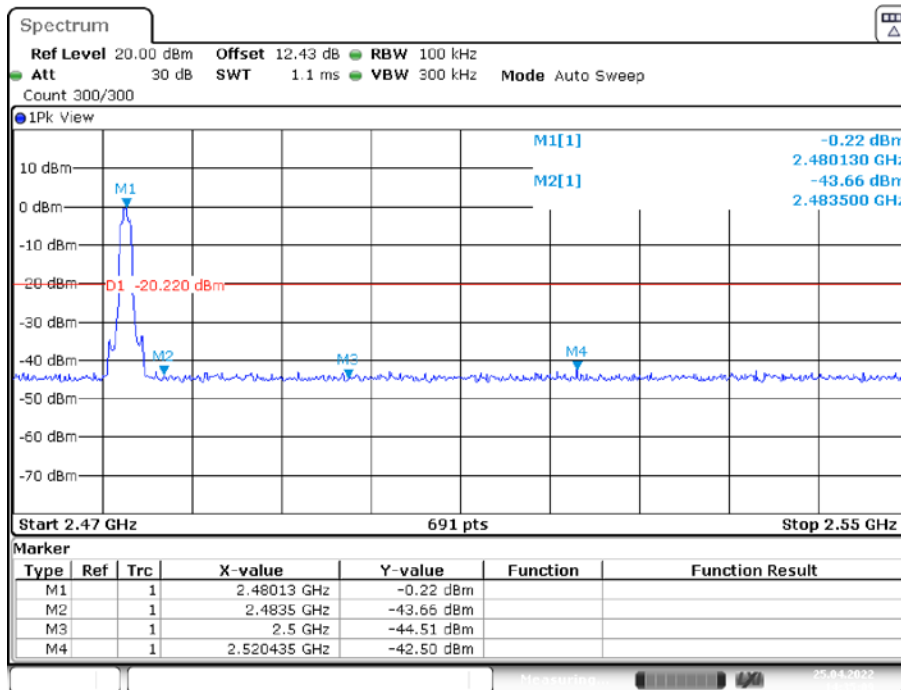

Date: 25.APR.2022 14:35:10

**** END OF REPORT ****