



FCC TEST REPORT
For
TZUMI Electronics, LLC
Wireless Charging Pad
Test Model: 5352
Additional Model No.: 5352HD

Prepared for : TZUMI Electronics, LLC
Address : 16 EAST 34TH STREET 16TH FLOOR NEW YORK, NY 10016
United States

Prepared by : Shenzhen LCS Compliance Testing Laboratory Ltd.
Address : 101, 201 Bldg A & 301 Bldg C, Juji Industrial Park
Yabianxueziwei, Shajing Street, Baoan District, Shenzhen,
518000, China
Tel : (+86)755-82591330
Fax : (+86)755-82591332
Web : www.LCS-cert.com
Mail : webmaster@LCS-cert.com

Date of receipt of test sample : April 14, 2022
Number of tested samples : 2
Serial number : 220413063A-1, 220413063A-2
Date of Test : April 14, 2022 ~ May 13, 2022
Date of Report : May 16, 2022





FCC TEST REPORT FCC CFR 47 PART 15C	
Report Reference No.	LCS220413063AEA
Date Of Issue	May 16, 2022
Testing Laboratory Name	Shenzhen LCS Compliance Testing Laboratory Ltd.
Address	101, 201 Bldg A & 301 Bldg C, Juji Industrial Park Yabianxueziwei, Shajing Street, Baoan District, Shenzhen, 518000, China
Testing Location/ Procedure	Full application of Harmonised standards <input checked="" type="checkbox"/> Partial application of Harmonised standards <input type="checkbox"/> Other standard testing method <input type="checkbox"/>
Applicant's Name	TZUMI Electronics, LLC
Address	16 EAST 34TH STREET 16TH FLOOR NEW YORK, NY 10016 United States
Test Specification	
Standard	FCC CFR 47 PART 15C
Test Report Form No.	LCSEMC-1.0
TRF Originator	Shenzhen LCS Compliance Testing Laboratory Ltd.
Master TRF	Dated 2011-03
Shenzhen LCS Compliance Testing Laboratory Ltd. All rights reserved. This publication may be reproduced in whole or in part for non-commercial purposes as long as the Shenzhen LCS Compliance Testing Laboratory Ltd. is acknowledged as copyright owner and source of the material. Shenzhen LCS Compliance Testing Laboratory Ltd. takes no responsibility for and will not assume liability for damages resulting from the reader's interpretation of the reproduced material due to its placement and context.	
Test Item Description	Wireless Charging Pad
Trade Mark	TZUMI
Test Model	5352
Power Supply	Input: DC 5V, 1-3A; DC 9V, 2A Wireless Output: 15W
Result	Positive

Compiled by:

Supervised by:

Approved by:

Lh Li/ Administrator

Jin Wang/ Technique principal

Gavin Liang/ Manager





FCC TEST REPORT

Test Report No. : LCS220413063AEA	<u>May 16, 2022</u> Date of issue
---	--------------------------------------

Test Model.....	: 5352
EUT.....	: Wireless Charging Pad
Applicant.....	: TZUMI Electronics, LLC
Address.....	: 16 EAST 34TH STREET 16TH FLOOR NEW YORK, NY 10016 United States
Telephone.....	: /
Fax.....	: /
Manufacturer.....	: Zhongshan Chao Feng Opto electronic technology co, Ltd.
Address.....	: 3 / F, Building B, Xiaobailong Industrial Park, 92 Shunxing North Road, Yongxing Industrial Zone, Henglan Town, Zhongshan City, Guangdong Province, China
Telephone.....	: /
Fax.....	: /
Factory.....	: Zhongshan Chao Feng Opto electronic technology co, Ltd.
Address.....	: 3 / F, Building B, Xiaobailong Industrial Park, 92 Shunxing North Road, Yongxing Industrial Zone, Henglan Town, Zhongshan City, Guangdong Province, China
Telephone.....	: /
Fax.....	: /

Test Result	Positive
--------------------	-----------------

The test report merely corresponds to the test sample.
It is not permitted to copy extracts of these test result without the written permission of the test laboratory.





Revision History

Report Version	Issue Date	Revision Content	Revised By
000	May 16, 2022	Initial Issue	---



Shenzhen LCS Compliance Testing Laboratory Ltd.
Add: 101, 201 Bldg A & 301 Bldg C, Juji Industrial Park Yabianxueziwei, Shajing Street, Baoan District, Shenzhen, 518000, China
Tel: +(86) 0755-82591330 | E-mail: webmaster@lcs-cert.com | Web: www.lcs-cert.com
Scan code to check authenticity



TABLE OF CONTENTS

- 1. GENERAL INFORMATION 6**
 - 1.1 Description of Device (EUT) 6
 - 1.2 Support equipment List 6
 - 1.3 External I/O Cable 6
 - 1.4 Description of Test Facility 6
 - 1.5 Statement of the Measurement Uncertainty 7
 - 1.6 Measurement Uncertainty 7
 - 1.7 Description of Test Modes 7
- 2. TEST METHODOLOGY 8**
 - 2.1 EUT Configuration 8
 - 2.2 EUT Exercise 8
 - 2.3 General Test Procedures 8
 - 2.3.1 Conducted Emissions 8
 - 2.3.2 Radiated Emissions 8
- 3. SYSTEM TEST CONFIGURATION 9**
 - 3.1 Justification 9
 - 3.2 EUT Exercise Software 9
 - 3.3 Special Accessories 9
 - 3.4 Block Diagram/Schematics 9
 - 3.5 Equipment Modifications 9
 - 3.6 Test Setup 9
- 4. SUMMARY OF TEST EQUIPMENT 10**
- 5. SUMMARY OF TEST RESULT 11**
- 6. POWER LINE CONDUCTED MEASUREMENT 12**
- 7. RADIATED EMISSION MEASUREMENT 15**
 - 7.1. Block Diagram of Test Setup 15
 - 7.2. Radiated Emission Limit 16
 - 7.3. EUT Configuration on Measurement 16
 - 7.4. Operating Condition of EUT 16
 - 7.5. Measuring Setting 17
 - 7.6. Test Procedure 17
 - 7.7. Test Results 18
- 9. PHOTOGRAPHS OF TEST SETUP 23**
- 10. EXTERNAL PHOTOGRAPHS OF THE EUT 23**
- 11. INTERNAL PHOTOGRAPHS OF THE EUT 23**





1. GENERAL INFORMATION

1.1 Description of Device (EUT)

EUT : Wireless Charging Pad

Test Model : 5352

Additional Model No. : 5352HD

Model Declaration : PCB board, structure and internal of these model(s) are the same, So no additional models were tested

Power Supply : Input: DC 5V, 1-3A; DC 9V, 2A
Wireless Output: 15W

Hardware Version : /

Software Version : /

Wireless Charging :

Operating Frequency : 111.0~205.0KHz

Modulation Type : ASK

Antenna Type : Coil Antenna

1.2 Support equipment List

Manufacturer	Description	Model	Serial Number	Certificate
Apple	Phone	ipone 11	--	FCC
OPPO	Adapter	OP52KAUH	--	FCC

Note: Auxiliary equipment is provided by the laboratory.

1.3 External I/O Cable

I/O Port Description	Quantity	Cable
Type-C USB Port	1	USB Cable: 1.2m, unshielded

1.4 Description of Test Facility

NVLAP Accreditation Code is 600167-0.

FCC Designation Number is CN5024

CAB identifier is CN0071.

CNAS Registration Number is L4595.

Test Firm Registration Number: 254912

The 3m-Semi anechoic test site fulfils CISPR 16-1-4 according to ANSI C63.4:2014 and CISPR 16-1-4:2010 SVSWR requirement for radiated emission above 1GHz.





1.5 Statement of the Measurement Uncertainty

The data and results referenced in this document are true and accurate. The reader is cautioned that there may be errors within the calibration limits of the equipment and facilities. The measurement uncertainty was calculated for all measurements listed in this test report acc. To CISPR 16 – 4 “Specification for radio disturbance and immunity measuring apparatus and methods – Part 4: Uncertainty in EMC Measurements” and is documented in the LCS quality system acc. To DIN EN ISO/IEC 17025. Furthermore, component and process variability of devices similar to that tested may result in additional deviation. The manufacturer has the sole responsibility of continued compliance of the device.

1.6 Measurement Uncertainty

Test Item	Frequency Range	Uncertainty	Note
Radiation Uncertainty	9KHz~30MHz	3.10dB	(1)
	30MHz~200MHz	2.96dB	(1)
	200MHz~1000MHz	3.10dB	(1)
	1GHz~26.5GHz	3.80dB	(1)
	26.5GHz~40GHz	3.90dB	(1)
Conduction Uncertainty	150kHz~30MHz	1.63dB	(1)
Power disturbance	30MHz~300MHz	1.60dB	(1)

(1). This uncertainty represents an expanded uncertainty expressed at approximately the 95% confidence level using a coverage factor of k=2.

1.7 Description of Test Modes

Equipment under test was operated during the measurement under the following conditions:

Charging and communication mode

Modulation Type: CW (ASK)

Test Modes		
Mode 1	AC/DC Adapter (5V/3A)+EUT+Mobile Phone (Battery Status: <1%)	Record
Mode 2	AC/DC Adapter (5V/3A)+EUT+Mobile Phone (Battery Status: <50%)	Pre-tested
Mode 3	AC/DC Adapter (5V/3A)+EUT+Mobile Phone(Battery Status: <100%)	Pre-tested

Note: All test modes were pre-tested, but we only recorded the worst case in this report.

For AC conducted emission, pre-test at both AC 120V/60Hz and AC 240V/50Hz, recorded worst case;

For AC conducted emission, pre-test at both AC charge from power adapter modes, recorded worst case.





2. TEST METHODOLOGY

The tests documented in this report were performed in accordance with ANSI C63.10-2013, FCC CFR PART 15C 15.207 and DA 00-705.

2.1 EUT Configuration

The EUT configuration for testing is installed on RF field strength measurement to meet the Commissions requirement and operating in a manner that intends to maximize its emission characteristics in a continuous normal application.

2.2 EUT Exercise

The EUT was operated in the normal operating mode for Hopping Numbers and Dwell Time test and a continuous transmits mode for other tests.

According to its specifications, the EUT must comply with the requirements of the Section 15.207 under the FCC Rules Part 15 Subpart C.

2.3 General Test Procedures

2.3.1 Conducted Emissions

The EUT is placed on the turntable, which is 0.8 m above ground plane. According to the requirements in Section 6.2.1 of ANSI C63.10-2013 Conducted emissions from the EUT measured in the frequency range between 0.15 MHz and 30MHz using Quasi-peak and average detector modes.

2.3.2 Radiated Emissions

The EUT is placed on a turn table, which is 0.8 m above ground plane below 1GHz and 1.5 m above ground plane above 1GHz. The turntable shall rotate 360 degrees to determine the position of maximum emission level. EUT is set 3m away from the receiving antenna, which varied from 1m to 4m to find out the highest emission. And also, each emission was to be maximized by changing the polarization of receiving antenna both horizontal and vertical. In order to find out the maximum emissions, exploratory radiated emission measurements were made according to the requirements in Section 6.3 of ANSI C63.10-2013



Shenzhen LCS Compliance Testing Laboratory Ltd.

Add: 101, 201 Bldg A & 301 Bldg C, Juji Industrial Park Yabianxueziwei, Shajing Street, Baoan District, Shenzhen, 518000, China

Tel: +(86) 0755-82591330 | E-mail: webmaster@lcs-cert.com | Web: www.lcs-cert.com

Scan code to check authenticity



3. SYSTEM TEST CONFIGURATION

3.1 Justification

The system was configured for testing in a normal condition.

3.2 EUT Exercise Software

N/A.

3.3 Special Accessories

N/A.

3.4 Block Diagram/Schematics

Please refer to the related document.

3.5 Equipment Modifications

Shenzhen LCS Compliance Testing Laboratory Ltd. has not done any modification on the EUT.

3.6 Test Setup

Please refer to the test setup photo.





4. SUMMARY OF TEST EQUIPMENT

Item	Equipment	Manufacturer	Model No.	Serial No.	Cal Date	Due Date
1	MXA Signal Analyzer	Agilent	N9020A	MY49100040	2021-06-17	2022-06-16
2	SPECTRUM ANALYZER	R&S	FSP40	100503	2021-11-16	2022-11-15
3	3m Semi Anechoic Chamber	SIDT FRANKONIA	SAC-3M	03CH03-HY	2021-09-25	2022-09-24
4	Positioning Controller	MF	MF-7082	/	2021-06-21	2022-06-20
5	EMI Test Software	EZ	EZ-EMC	/	N/A	N/A
6	EMI Test Receiver	R&S	ESR 7	101181	2021-06-21	2022-06-20
7	Active Loop Antenna	SCHWARZBECK	FMZB 1519B	00005	2021-06-30	2024-07-01
8	By-log Antenna	SCHWARZBECK	VULB9163	9163-470	2021-06-30	2024-07-01
9	Horn Antenna	SCHWARZBECK	BBHA 9120D	9120D-1925	2021-06-30	2024-07-01
10	RF Cable-R03m	Jye Bao	RG142	CB021	2021-06-21	2022-06-20
11	RF Cable-HIGH	SUHNER	SUCOFLEX 106	03CH03-HY	2021-06-21	2022-06-20
12	EMI Test Receiver	R&S	ESPI	101840	2021-06-21	2022-06-20
13	Artificial Mains	R&S	ENV216	101288	2021-06-21	2022-06-20
14	10dB Attenuator	SCHWARZBECK	MTS-IMP-136	261115-001-0032	2021-06-21	2022-06-20
15	Broadband Preampifier	SCHWARZBECK	BBV9745	9719-025	2021-06-21	2022-06-20



Shenzhen LCS Compliance Testing Laboratory Ltd.

Add: 101, 201 Bldg A & 301 Bldg C, Juji Industrial Park Yabianxueziwei, Shajing Street, Baoan District, Shenzhen, 518000, China

Tel: +(86) 0755-82591330 | E-mail: webmaster@lcs-cert.com | Web: www.lcs-cert.com

Scan code to check authenticity



5. SUMMARY OF TEST RESULT

FCC Rules	Description of Test	Test Sample	Result
§15.207(a)	AC Conducted Emissions	Sample 1	Compliant
§15.209	Radiated Spurious Emissions	Sample 1	Compliant

Remark: The measurement uncertainty is not included in the test result.
N/A – Not Applicable!!!





6. POWER LINE CONDUCTED MEASUREMENT

6.1. Block Diagram of Test Setup

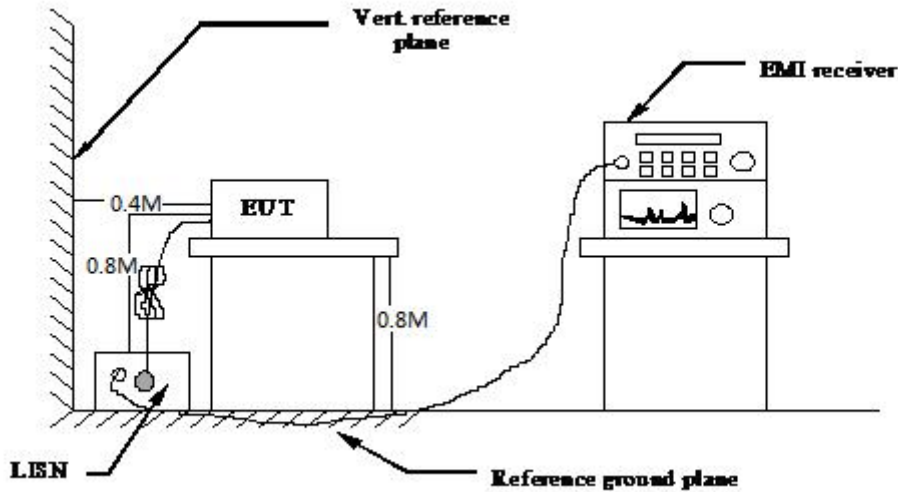

6.2. Standard Applicable

According to §15.207: For all the consumer devices which is designed to be connected to the public utility (AC) power line, the radio frequency voltage that is conducted back onto the AC power line on any frequency or frequencies within the band 150 kHz to 30 MHz shall not exceed 250 microvolts (The limit decreases linearly with the logarithm of the frequency in the range 0.15 MHz to 0.50 MHz). The limits at specific frequency range are listed as follows:

Frequency Range (MHz)	Limits (dBµV)	
	Quasi-peak	Average
0.15 to 0.50	66 to 56	56 to 46
0.50 to 5	56	46
5 to 30	60	50

* Decreasing linearly with the logarithm of the frequency

6.3 Test Results

PASS

The test data please refer to following page.

Temperature	22.7°C	Humidity	53.7%
Test Engineer	Nick Peng	Configurations	Transmit



Shenzhen LCS Compliance Testing Laboratory Ltd.

Add: 101, 201 Bldg A & 301 Bldg C, Juji Industrial Park Yabianxueziwei, Shajing Street, Baoan District, Shenzhen, 518000, China

Tel: +(86) 0755-82591330 | E-mail: webmaster@lcs-cert.com | Web: www.lcs-cert.com

Scan code to check authenticity



AC Power Line Conducted Emission (Power input to adapter @ AC 120V/60Hz (Worst Case))

Line

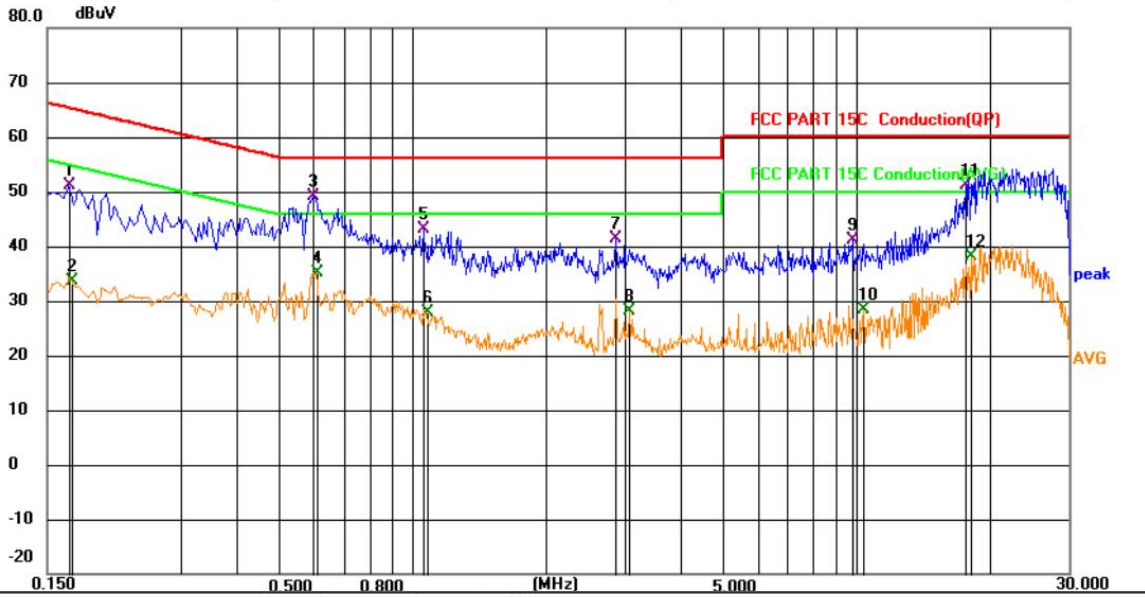

No.	Mk.	Freq. MHz	Reading Level dBuV	Correct Factor dB	Measure- ment dBuV	Limit dBuV	Margin dB	Detector	Comment
1		0.1681	31.44	19.63	51.07	65.05	-13.98	QP	
2		0.1703	13.89	19.63	33.52	54.95	-21.43	AVG	
3	*	0.5955	29.51	19.66	49.17	56.00	-6.83	QP	
4		0.6046	15.49	19.66	35.15	46.00	-10.85	AVG	
5		1.0546	23.36	19.65	43.01	56.00	-12.99	QP	
6		1.0726	8.16	19.65	27.81	46.00	-18.19	AVG	
7		2.8771	21.71	19.68	41.39	56.00	-14.61	QP	
8		3.0841	8.44	19.70	28.14	46.00	-17.86	AVG	
9		9.7711	21.39	19.84	41.23	60.00	-18.77	QP	
10		10.3696	8.56	19.85	28.41	50.00	-21.59	AVG	
11		17.6236	30.91	20.11	51.02	60.00	-8.98	QP	
12		18.0780	18.01	20.16	38.17	50.00	-11.83	AVG	





Neutral

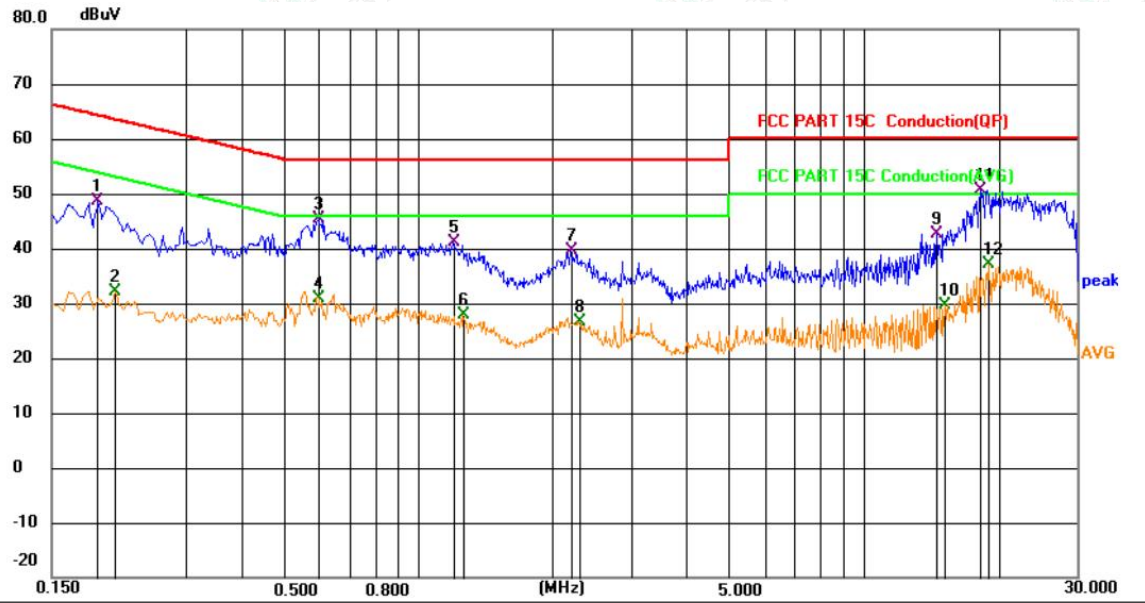

No.	Mk.	Freq. MHz	Reading Level dBuV	Correct Factor dB	Measure- ment dBuV	Limit dBuV	Margin dB	Detector	Comment
1		0.1906	29.09	19.63	48.72	64.01	-15.29	QP	
2		0.2086	12.50	19.63	32.13	53.26	-21.13	AVG	
3		0.5955	25.61	19.66	45.27	56.00	-10.73	QP	
4		0.5955	11.30	19.66	30.96	46.00	-15.04	AVG	
5		1.1941	21.58	19.66	41.24	56.00	-14.76	QP	
6		1.2571	8.18	19.66	27.84	46.00	-18.16	AVG	
7		2.1931	19.91	19.69	39.60	56.00	-16.40	QP	
8		2.2876	7.01	19.69	26.70	46.00	-19.30	AVG	
9		14.5321	22.85	19.86	42.71	60.00	-17.29	QP	
10		15.2206	9.72	19.88	29.60	50.00	-20.40	AVG	
11	*	18.3211	30.56	20.16	50.72	60.00	-9.28	QP	
12		19.0276	17.01	20.19	37.20	50.00	-12.80	AVG	

***Note: Pre-scan all modes and recorded the worst case results in this report.
Margin=Reading level + Correct - Limit





7. RADIATED EMISSION MEASUREMENT

7.1. Block Diagram of Test Setup

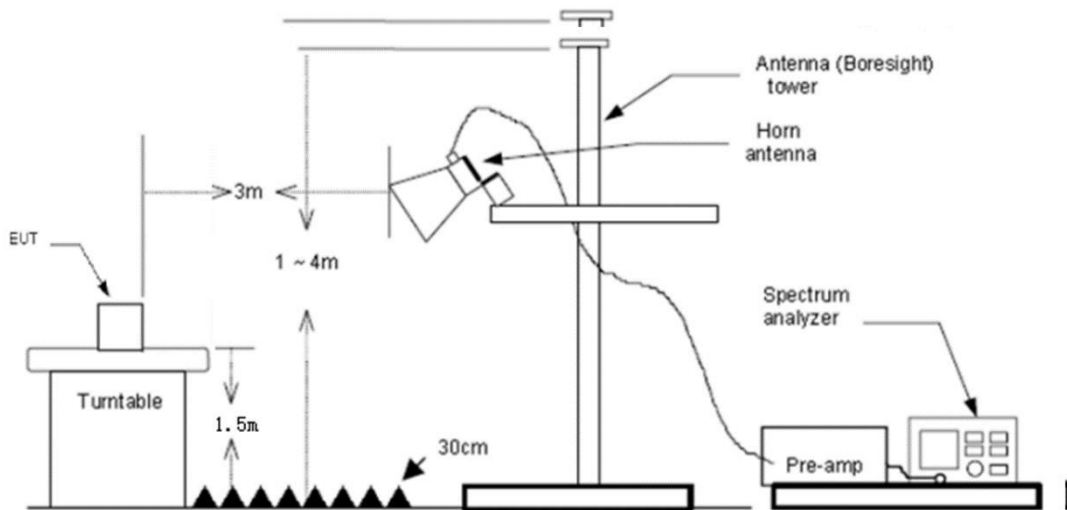
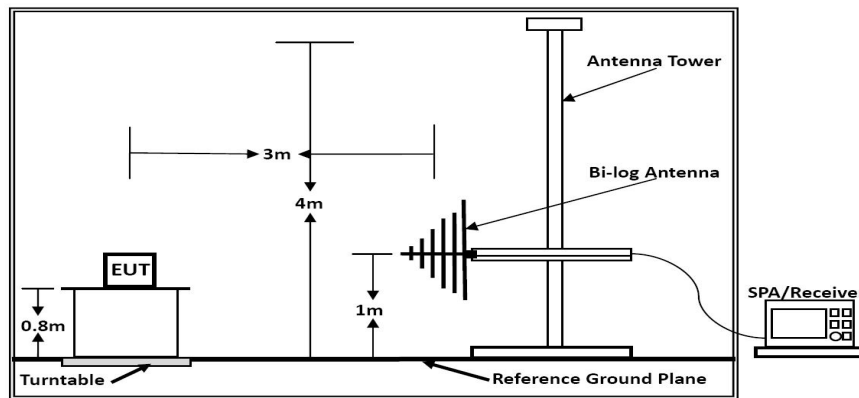
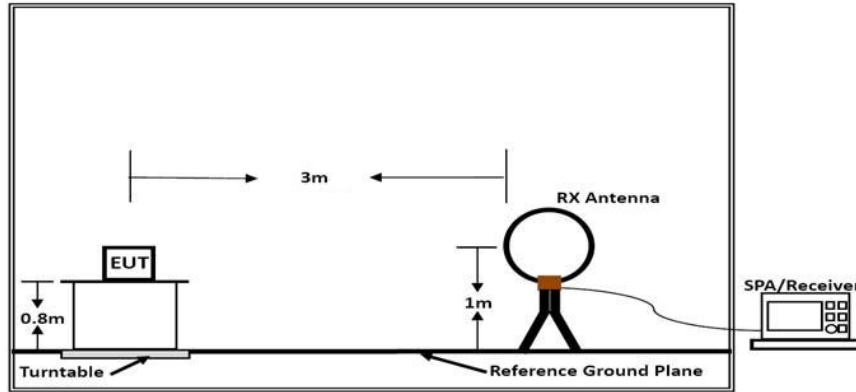

Shenzhen LCS Compliance Testing Laboratory Ltd.

Add: 101, 201 Bldg A & 301 Bldg C, Juji Industrial Park Yabianxueziwei, Shajing Street, Baoan District, Shenzhen, 518000, China

Tel: +(86) 0755-82591330 | E-mail: webmaster@lcs-cert.com | Web: www.lcs-cert.com

Scan code to check authenticity



7.2. Radiated Emission Limit

15.205 (a) Except as shown in paragraph (d) of this section, only spurious emissions are permitted in any of the frequency bands listed below:

MHz	MHz	MHz	GHz
0.090-0.110	16.42-16.423	399.9-410	4.5-5.15
\1\ 0.495-0.505	16.69475-16.69525	608-614	5.35-5.46
2.1735-2.1905	16.80425-16.80475	960-1240	7.25-7.75
4.125-4.128	25.5-25.67	1300-1427	8.025-8.5
4.17725-4.17775	37.5-38.25	1435-1626	9.0-9.2
4.20725-4.20775	73-74.6	1645.5-1646.5	9.3-9.5
6.215-6.218	74.8-75.2	1660-1710	10.6-12.7
6.26775-6.26825	108-121.94	1718.8-1722.2	13.25-13.4
6.31175-6.31225	123-138	2200-2300	14.47-14.5
8.291-8.294	149.9-150.05	2310-2390	15.35-16.2
8.362-8.366	156.52475-156.52525	2483.5-2500	17.7-21.4
8.37625-8.38675	156.7-156.9	2690-2900	22.01-23.12
8.41425-8.41475	162.0125-167.17	3260-3267	23.6-24.0
12.29-12.293	167.72-173.2	3332-3339	31.2-31.8
12.51975-12.52025	240-285	3345.8-3358	36.43-36.5
12.57675-12.57725	322-335.4	3600-4400	(\2\)
13.36-13.41			

\1\ Until February 1, 1999, this restricted band shall be 0.490-0.510 MHz.

\2\ Above 38.6

According to §15.247 (d): 20dBc in any 100 kHz bandwidth outside the operating frequency band. In case the emission fall within the restricted band specified on 15.205(a), then the 15.209(a) limit in the table below has to be followed.

Frequencies (MHz)	Field Strength (microvolts/meter)	Measurement Distance (meters)
0.009~0.490	2400/F(KHz)	300
0.490~1.705	24000/F(KHz)	30
1.705~30.0	30	30
30~88	100	3
88~216	150	3
216~960	200	3
Above 960	500	3

7.3. EUT Configuration on Measurement

The following equipment are installed on Radiated Emission Measurement to meet the commission requirements and operating regulations in a manner which tends to maximize its emission characteristics in normal application.

7.4. Operating Condition of EUT

(1) Setup the EUT as shown in Section 7.1.





7.5. Measuring Setting

The following table is the setting of spectrum analyzer and receiver.

Receiver Parameter	Setting
Attenuation	Auto
Start ~ Stop Frequency	9kHz~150kHz / RB 200Hz for QP/Average
Start ~ Stop Frequency	150kHz~30MHz / RB 9kHz for QP/Average
Start ~ Stop Frequency	30MHz~1000MHz / RB 100kHz for QP

7.6. Test Procedure

1) Sequence of testing 9 kHz to 30 MHz

Setup:

- The equipment was set up to simulate a typical usage like described in the user manual or described by manufacturer.
- If the EUT is a tabletop system, a rotatable table with 0.8 m height is used.
- If the EUT is a floor standing device, it is placed on the ground.
- Auxiliary equipment and cables were positioned to simulate normal operation conditions.
- The AC power port of the EUT (if available) is connected to a power outlet below the turntable.
- The measurement distance is 3 meter.
- The EUT was set into operation.

Premeasurement:

- The turntable rotates from 0° to 315° using 45° steps.
- The antenna height is 1 meter.
- At each turntable position the analyzer sweeps with peak detection to find the maximum of all emissions

Final measurement:

- Identified emissions during the premeasurement the software maximizes by rotating the turntable position (0° to 360°) and by rotating the elevation axes (0° to 360°).
- The final measurement will be done in the position (turntable and elevation) causing the highest emissions with QPK detector.
- The final levels, frequency, measuring time, bandwidth, turntable position, correction factor, margin to the limit and limit will be recorded. Also a plot with the graph of the premeasurement and the limit will be stored.



Shenzhen LCS Compliance Testing Laboratory Ltd.

Add: 101, 201 Bldg A & 301 Bldg C, Juji Industrial Park Yabianxueziwei, Shajing Street, Baoan District, Shenzhen, 518000, China

Tel: +(86) 0755-82591330 | E-mail: webmaster@lcs-cert.com | Web: www.lcs-cert.com

Scan code to check authenticity



2) Sequence of testing 30 MHz to 1 GHz

Setup:

- The equipment was set up to simulate a typical usage like described in the user manual or described by manufacturer.
- If the EUT is a tabletop system, a table with 0.8 m height is used, which is placed on the ground plane.
- If the EUT is a floor standing device, it is placed on the ground plane with insulation between both.
- Auxiliary equipment and cables were positioned to simulate normal operation conditions
- The AC power port of the EUT (if available) is connected to a power outlet below the turntable.
- The measurement distance is 3 meter.
- The EUT was set into operation.

Premeasurement:

- The turntable rotates from 0° to 315° using 45° steps.
- The antenna is polarized vertical and horizontal.
- The antenna height changes from 1 to 3 meter.
- At each turntable position, antenna polarization and height the analyzer sweeps three times in peak to find the maximum of all emissions.

Final measurement:

- The final measurement will be performed with minimum the six highest peaks.
- According to the maximum antenna and turntable positions of premeasurement the software maximize the peaks by changing turntable position ($\pm 45^\circ$) and antenna movement between 1 and 4 meter.
- The final measurement will be done with QP detector with an EMI receiver.
- The final levels, frequency, measuring time, bandwidth, antenna height, antenna polarization, turntable angle, correction factor, margin to the limit and limit will be recorded. Also a plot with the graph of the premeasurement with marked maximum final measurements and the limit will be stored.

7.7. Test Results

PASS.

Only report the worst test data mode 1 in test report;

The test data please refer to following page:

Temperature	23.8°C	Humidity	52.5%
Test Engineer	Nick Peng	Configurations	Transmit

0.009 MHz – 30 MHz



Shenzhen LCS Compliance Testing Laboratory Ltd.
 Add: 101, 201 Bldg A & 301 Bldg C, Juji Industrial Park Yabianxueziwei, Shajing Street, Baoan District, Shenzhen, 518000, China
 Tel: +(86) 0755-82591330 | E-mail: webmaster@lcs-cert.com | Web: www.lcs-cert.com
 Scan code to check authenticity



Horizontal

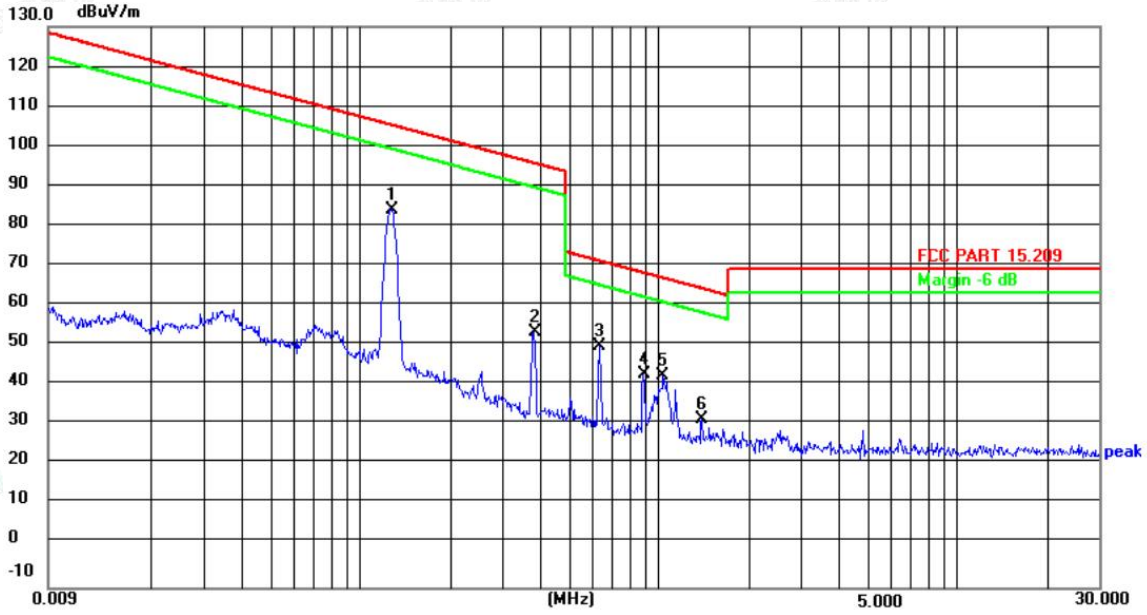

No.	Frequency (MHz)	Reading (dBuV)	Factor (dB/m)	Level (dBuV/m)	Limit (dBuV/m)	Margin (dB)	Detector
1	0.1266	93.82	-9.48	84.34	105.49	-21.15	peak
2	0.3817	62.62	-8.76	53.86	95.96	-42.10	peak
3	0.6363	58.69	-8.18	50.51	71.53	-21.02	peak
4	0.8875	50.95	-7.53	43.42	68.64	-25.22	peak
5	1.0354	50.18	-7.17	43.01	67.30	-24.29	peak
6	1.3977	38.56	-6.49	32.07	64.70	-32.63	peak



Shenzhen LCS Compliance Testing Laboratory Ltd.

Add: 101, 201 Bldg A & 301 Bldg C, Juji Industrial Park Yabianxueziwei, Shajing Street, Baoan District, Shenzhen, 518000, China

Tel: +(86) 0755-82591330 | E-mail: webmaster@lcs-cert.com | Web: www.lcs-cert.com

Scan code to check authenticity



Vertical

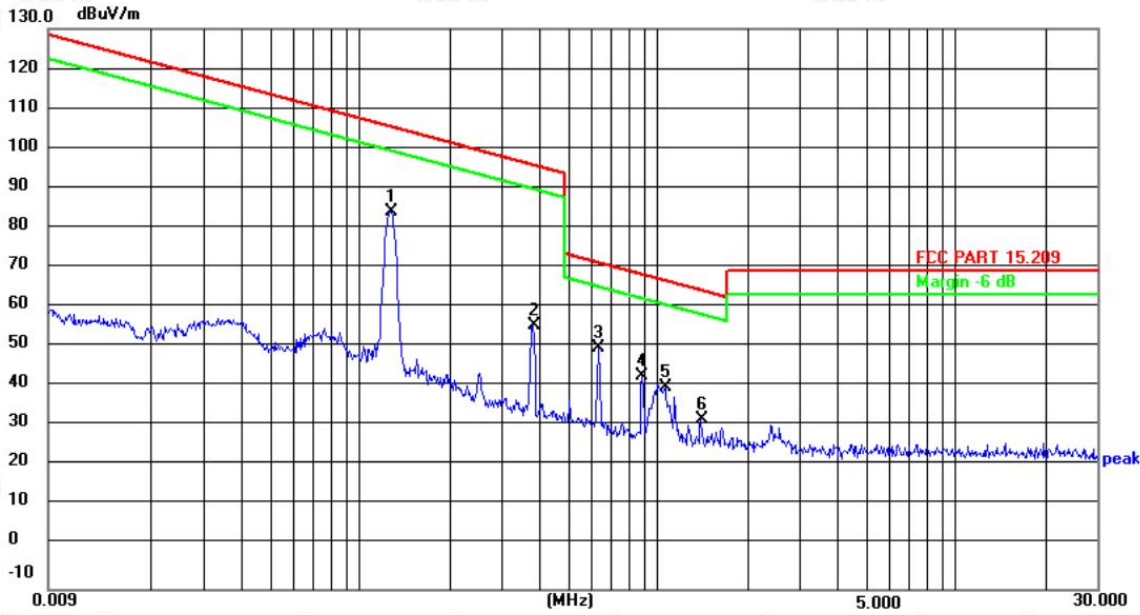

No.	Frequency (MHz)	Reading (dBuV)	Factor (dB/m)	Level (dBuV/m)	Limit (dBuV/m)	Margin (dB)	Detector
1	0.1267	93.84	-9.48	84.36	105.52	-21.16	peak
2	0.3818	64.89	-8.76	56.13	95.96	-39.83	peak
3	0.6313	58.64	-8.20	50.44	71.60	-21.16	peak
4	0.8875	50.95	-7.53	43.42	68.64	-25.22	peak
5	1.0610	47.76	-7.14	40.62	67.09	-26.47	peak
6	1.3979	38.88	-6.49	32.39	64.69	-32.30	peak

Remark: 1). Measured at antenna position 0 degree and 90 degree.
 2). Corrected Reading: Antenna Factor + Cable Loss + Read Level - Preamp Factor = Level.





Below 1GHz

Temperature	23.5°C	Humidity	52.2%
Test Engineer	Nick Peng	Configurations	Transmit

Horizontal

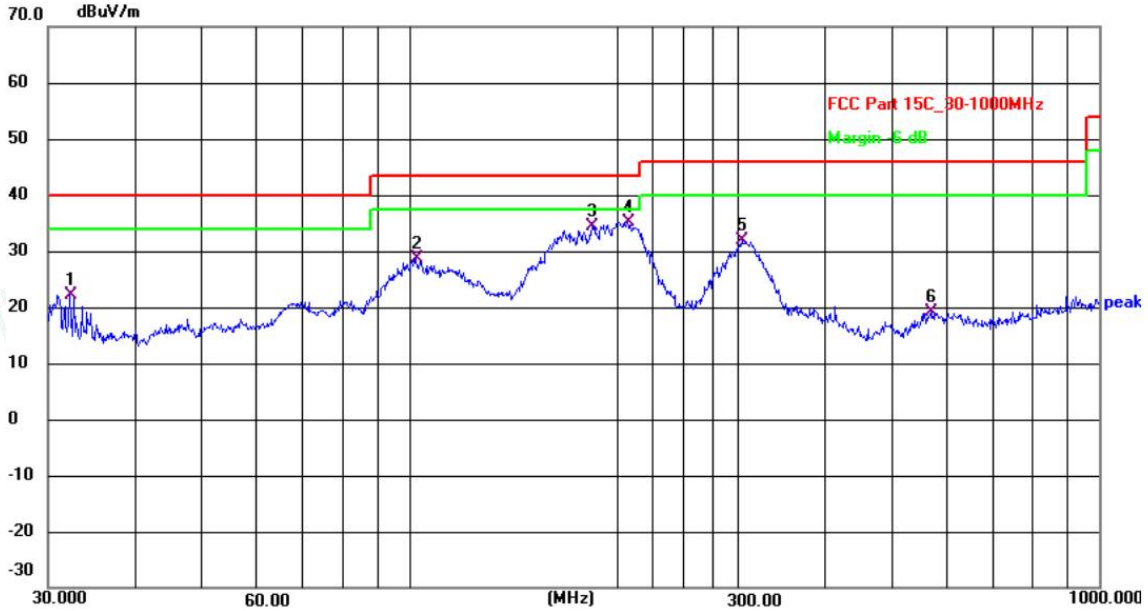

No.	Frequency (MHz)	Reading (dBuV)	Factor (dB/m)	Level (dBuV/m)	Limit (dBuV/m)	Margin (dB)	Detector
1	32.2925	40.37	-18.15	22.22	40.00	-17.78	QP
2	102.3597	47.02	-18.38	28.64	43.50	-14.86	QP
3	184.4898	52.57	-18.09	34.48	43.50	-9.02	QP
4	207.1226	52.35	-17.21	35.14	43.50	-8.36	QP
5	303.5437	47.32	-15.42	31.90	46.00	-14.10	QP
6	570.6100	30.19	-11.03	19.16	46.00	-26.84	QP





Vertical

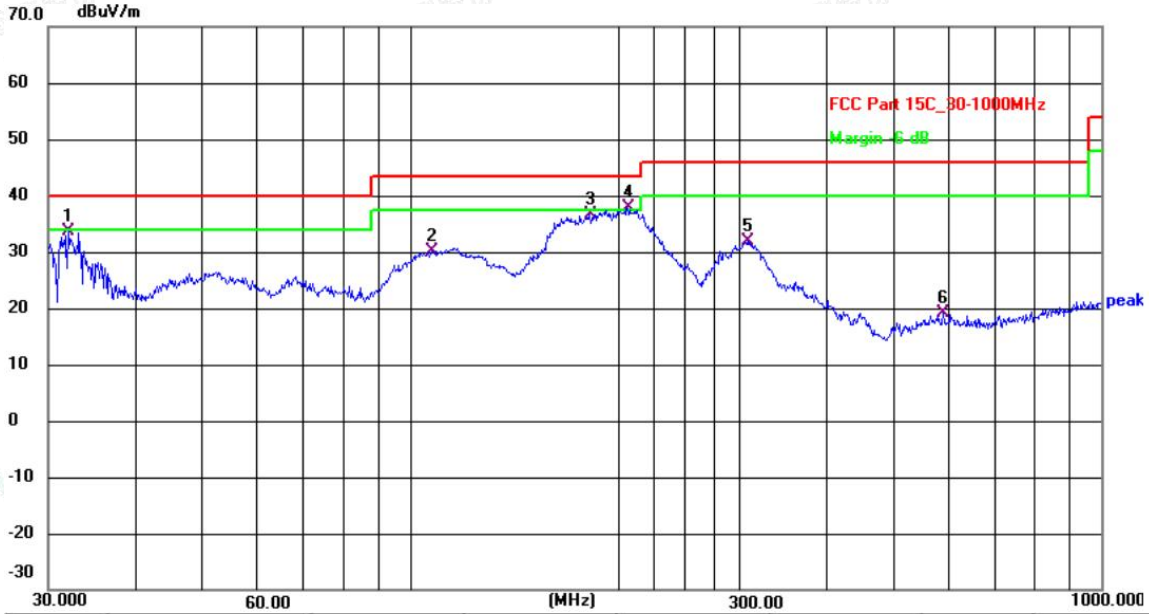

No.	Frequency (MHz)	Reading (dBuV)	Factor (dB/m)	Level (dBuV/m)	Limit (dBuV/m)	Margin (dB)	Detector
1	32.0667	51.80	-18.17	33.63	40.00	-6.37	QP
2	107.5101	49.06	-18.84	30.22	43.50	-13.28	QP
3	181.9202	55.26	-18.61	36.65	43.50	-6.85	QP
4	206.3976	55.00	-17.23	37.77	43.50	-5.73	QP
5	307.8313	47.09	-15.18	31.91	46.00	-14.09	QP
6	590.9737	29.65	-10.58	19.07	46.00	-26.93	QP

1). Emission level (dBuV/m) = 20 log Emission level (uV/m).

2). Corrected Reading: Antenna Factor + Cable Loss + Read Level - Preamp Factor = Level.





9. PHOTOGRAPHS OF TEST SETUP

Please refer to separated files for Test Setup Photos of the EUT.

10. EXTERNAL PHOTOGRAPHS OF THE EUT

Please refer to separated files for External Photos of the EUT.

11. INTERNAL PHOTOGRAPHS OF THE EUT

Please refer to separated files for Internal Photos of the EUT.

-----THE END OF REPORT-----

