



243 Jubug-Ri, Yangji-Myeon, Yongin-Si, Gyeonggi-Do, Korea 17159
 Tel: +82-31-323-6008 Fax: +82-31-323-6010
<http://www.ltalab.com>

Dates of Tests: August 10 2022 ~ September 30, 2022
 Test Report S/N: LR500112211D
 Test Site : LTA CO., LTD.

CERTIFICATION OF COMPLIANCE

FCC ID

2AON5A811-L

APPLICANT

Apulsetech Co., Ltd.

Equipment Class	:	Part 15 Spread Spectrum Transmitter (DSS)
Manufacturing Description	:	RFID Reader
Manufacturer	:	Apulsetech Co., Ltd.
Model name	:	a811-L
Test Device Serial No.:	:	Identical prototype
Rule Part(s)	:	FCC Part 15.247 Subpart C ; ANSI C63.10 - 2013
Frequency Range	:	2402 ~ 2480 MHz
RF power	:	Max -8.24 dBm - Conducted
Data of issue	:	October 08, 2022

This test report is issued under the authority of:

The test was supervised by:

JaBeom.Koo

Eun-Hwan Jung

Ja-Beom Koo, Manager

Eun-Hwan Jung, Test Engineer

This test result only responds to the tested sample. It is not allowed to copy this report even partly without the allowance of the test laboratory. The report must not be used by the client to claim product certification, approval, or endorsement by NVLAP, NIST, or any agency of the Federal Government.



NVLAP LAB Code.: 200723-0

TABLE OF CONTENTS

1. GENERAL INFORMATION	3
2. INFORMATION ABOUT TEST ITEM	4
3. TEST REPORT	5
3.1 SUMMARY OF TESTS	5
3.2 FREQUENCY HOPPING SYSTEM REQUIREMENTS	6
3.3 TECHNICAL CHARACTERISTICS TEST	7
3.3.1 CARRIER FREQUENCY SEPARATION	7
3.3.2 NUMBER OF HOPPING FREQUENCIES	9
3.3.3 20 dB BANDWIDTH	11
3.3.4 TIME OF OCCUPANCY (Dwell Time)	18
3.3.5 TRANSMITTER OUTPUT POWER	21
3.3.6 BAND EDGE	25
3.3.7 CONDUCTED SPURIOUS EMISSIONS	28
3.3.8 RADIATED SPURIOUS EMISSIONS	31
APPENDIX	
APPENDIX TEST EQUIPMENT USED FOR TESTS	41

1. General information

1-1 Test Performed

Company name : LTA Co., Ltd.
 Address : 243, Jubug-ri, Yangji-Myeon, Youngin-Si, Kyunggi-Do, Korea. 449-822
 Web site : <http://www.ltalab.com>
 E-mail : chahn@ltalab.com
 Telephone : +82-31-323-6008
 Facsimile : +82-31-323-6010

Quality control in the testing laboratory is implemented as per ISO/IEC 17025 which is the “General requirements for the competents of calibration and testing laboratory”.

1-2 Accredited agencies

LTA Co., Ltd. is approved to perform EMC testing by the following agencies:

Agency	Country	Accreditation No.	Validity	Reference
NVLAP	U.S.A	200723-0	2022-09-28	ECT accredited Lab.
RRA	KOREA	KR0049	-	EMC accredited Lab.
FCC	U.S.A	649054	2023-01-25	FCC CAB
VCCI	JAPAN	C-4948,	2023-09-10	VCCI registration
VCCI	JAPAN	T-2416,	2023-09-10	VCCI registration
VCCI	JAPAN	R-4483(10 m),	2023-08-15	VCCI registration
VCCI	JAPAN	G-847	2022-12-13	VCCI registration
IC	CANADA	5799A-1	2022-10-18	IC filing

2. Information about test item

2-1 Client & Manufacturer

Client Company name : Apulsetech Co., Ltd.
 Address : C-1211, Gwangmyeongtechnopark, 60, Haan-ro, Gwangmyeong-si, Gyeonggi-do, Republic of Korea
 Tel / Fax : +82-10-9573-2073 / +82-70-4222-5686
 Manufacturer : Apulsetech Co., Ltd.
 Address : C-1211, Gwangmyeongtechnopark, 60, Haan-ro, Gwangmyeong-si, Gyeonggi-do, Republic of Korea
 Tel / Fax : +82-10-9573-2073 / +82-70-4222-5686

2-2 Equipment Under Test (EUT)

Model name : a811-L
 Serial number : Identical prototype
 Date of receipt : August 10 2022
 EUT condition : Pre-production, not damaged
 Antenna type : PIFA Antenna (Max Gain : 2.2 dBi)
 Frequency Range : 2402 ~ 2480MHz
 RF output power : Max -8.24 dBm – Conducted
 Type of Modulation : Pi/4 DQPSK, 8DPSK
 Power Source : DC 3.7 V
 Firmware Version : V0.1

2-3 Tested frequency

Bluetooth	LOW	MID	HIGH
Frequency (MHz) BDR, EDR	2402	2441	2480

2-4 Ancillary Equipment

Equipment	Model No.	Serial No.	Manufacturer
Notebook	-	MS-1736	MSI

3. Test Report

3.1 Summary of tests

FCC Part Section(s)	Parameter	Limit	Test Condition	Status (note 1)
15.247(a)	Carrier Frequency Separation	$\geq 2/3$ of 20dB BW	Conducted	C
15.247(a)	Number of Hopping Frequencies	≥ 15 channels		C
15.247(a)	20 dB Bandwidth 99% Bandwidth	–		C
15.247(a)	Dwell Time	≤ 0.4 seconds		C
15.247(b)	Transmitter Output Power	≤ 1 W for 1Mbps ≤ 125 mW for 2,3Mbps		C
15.247(d)	Conducted Spurious emission	> 20 dBc		C
15.247(d)	Band Edge	> 20 dBc		C
15.249 / 15.209	Field Strength of Harmonics	< 54 dBuV (at 3m)	Radiated	C
15.109	Field Strength	–		C
15.207 /15.107	AC Conducted Emissions	EN 55022	Line Conducted	N/A
15.203	Antenna requirement	–	–	C

Note 1: C=Complies NC=Not Complies NT=Not Tested NA=Not Applicable

Note 2: This product operates only with battery and does not operate during charging.

Note 1: Antenna Requirement

Apulsetech Co., Ltd. FCC ID: 2AON5A811-L unit complies with the requirement of §15.203.

The antenna type is FPCB Antenna

3.2 Frequency Hopping System Requirements

3.2.1 Standard Applicable

According to FCC Part 15.247(a)(1), The system shall hop to channel frequencies that are selected at the system hopping rate from a pseudo randomly ordered list of hopping frequencies. Each frequency must be used equally on the average by each transmitter. The system receivers shall have input bandwidths that match the hopping channel bandwidths of their corresponding transmitters and shall shift frequencies in synchronization with the transmitted signals.

(g) Frequency hopping spread spectrum systems are not required to employ all available hopping channels during each transmission. However, the system, consisting of both the transmitter and the receiver, must be designed to comply with all of the regulations in this section should the transmitter be presented with a continuous data (or information) stream. In addition, a system employing short transmission bursts must comply with the definition of a frequency hopping system and must distribute its transmissions over the minimum number of hopping channels specified in this section.

(h) The incorporation of intelligence within a frequency hopping spread spectrum system that permits the system to recognize other users within the spectrum band so that it individually and independently chooses and adapts its hopsets to avoid hopping on occupied channels is permitted. The coordination of frequency hopping systems in any other manner for the express purpose of avoiding the simultaneous occupancy of individual hopping frequencies by multiple transmitters is not permitted.

3.3 TECHNICAL CHARACTERISTIC TEST

3.3.1 Carrier Frequency Separation

Procedure:

The test follows ANSI C63.10. The carrier frequency separation was measured with a spectrum analyzer connected to the antenna terminal, while EUT had its hopping function enabled.

After the trace being stable, the reading value between the peaks of the adjacent channels using the marker-delta function was recorded as the measurement results.

The spectrum analyzer is set to:

Span = 2~ 3 MHz (wide enough to capture the peaks of two adjacent channels)

RBW = 100 kHz (1% of the span or more) Sweep = auto

VBW = 100 kHz Detector function = peak

Trace = max hold

Measurement Data:

Test Results	
Carrier Frequency Separation (MHz)	Result
2.001 (BDR)	Complies
2.001 (EDR)	

- See next pages for actual measured spectrum plots.

Minimum Standard:

The EUT shall have hopping channel carrier frequencies separated by a minimum of 25 kHz or two-thirds of 20 dB bandwidth of the hopping channel, whichever is greater.

Measurement Setup

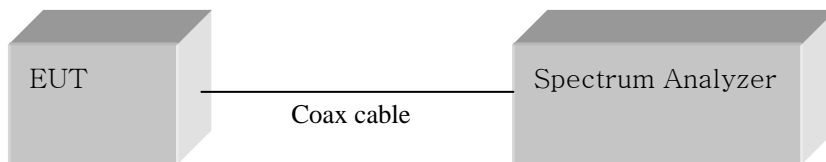
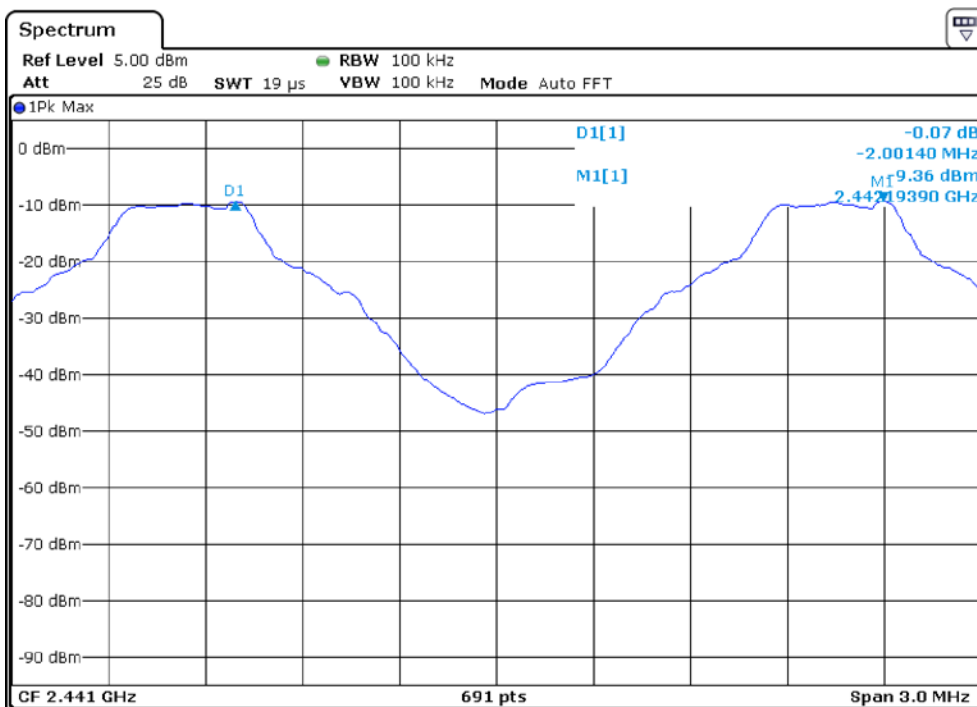

Figure 1: Measurement setup for the carrier frequency separation

Carrier Frequency Separation

BDR Mode



EDR Mode

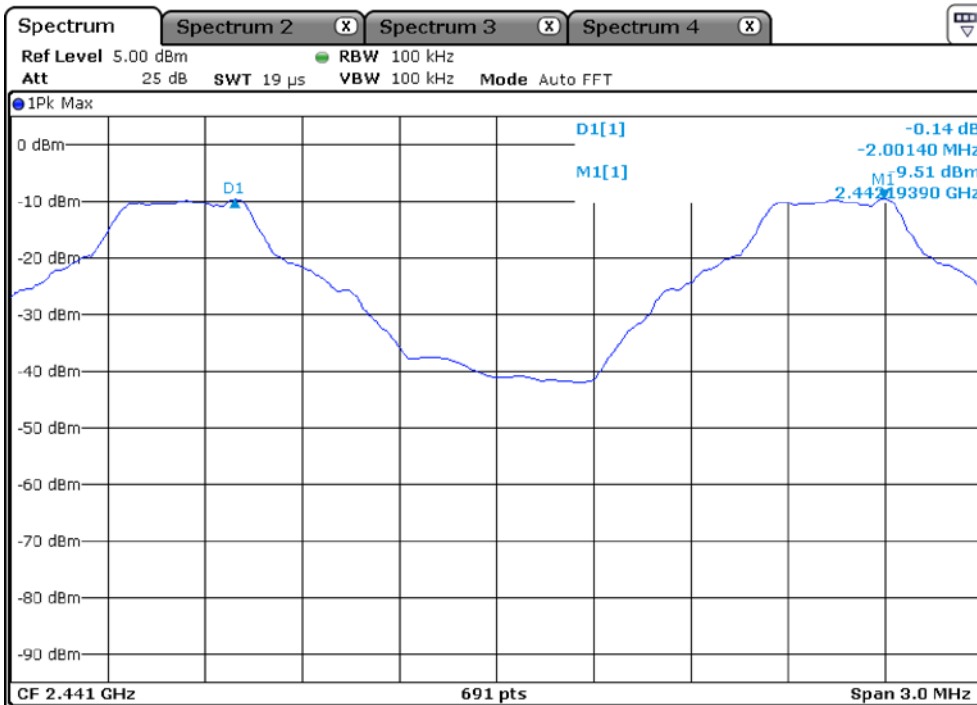

3.3.2 Number of Hopping Frequencies

Procedure:

The test follows ANSI C63.10. The number of hopping frequencies was measured with a spectrum analyzer connected to the antenna terminal, while EUT had its hopping function enabled.

To get higher resolution, four frequency ranges within the 2400 ~ 2483.5 MHz FH band were examined.

The spectrum analyzer is set to (Bluetooth):

Frequency range Start = 2400.0 MHz, Stop = 2483.5 MHz
 RBW = 100 kHz (1% of the span or more) Sweep = auto
 VBW = 100 kHz (VBW ≥ RBW) Detector function = peak
 Trace = max hold Span > 40 MHz

Measurement Data : Complies

Total number of Hopping Channels	79 (Basic, EDR)
---	-----------------

- See next pages for actual measured spectrum plots.

Minimum Standard:

At least 15 channels

Measurement Setup

Same as the Chapter 3.3.1 (Figure 1)

Number of Hopping Frequencies (BDR, EDR)

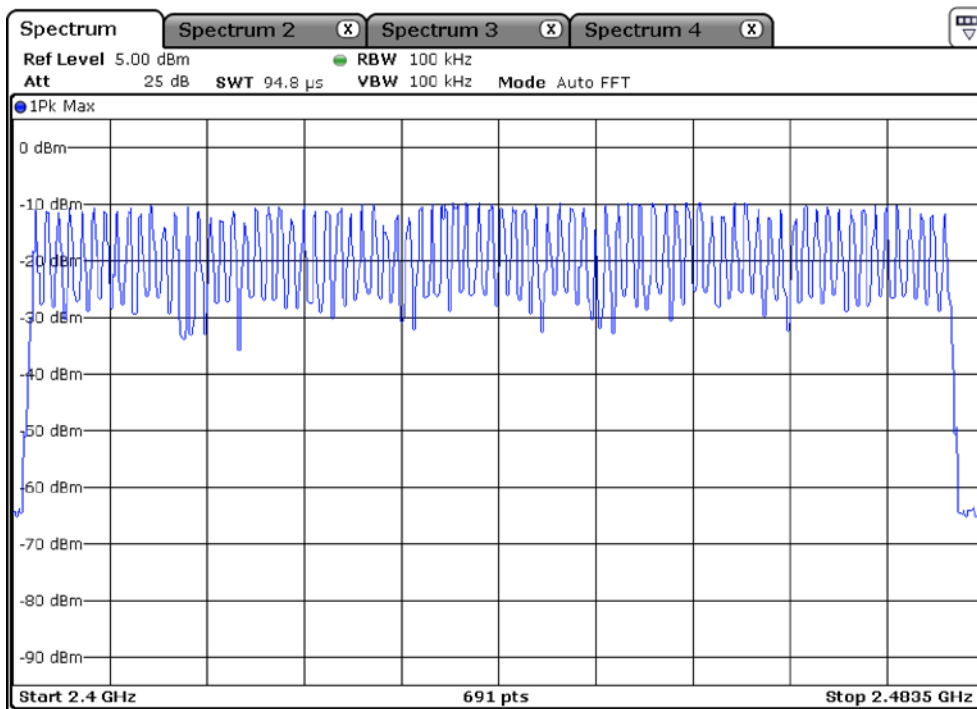
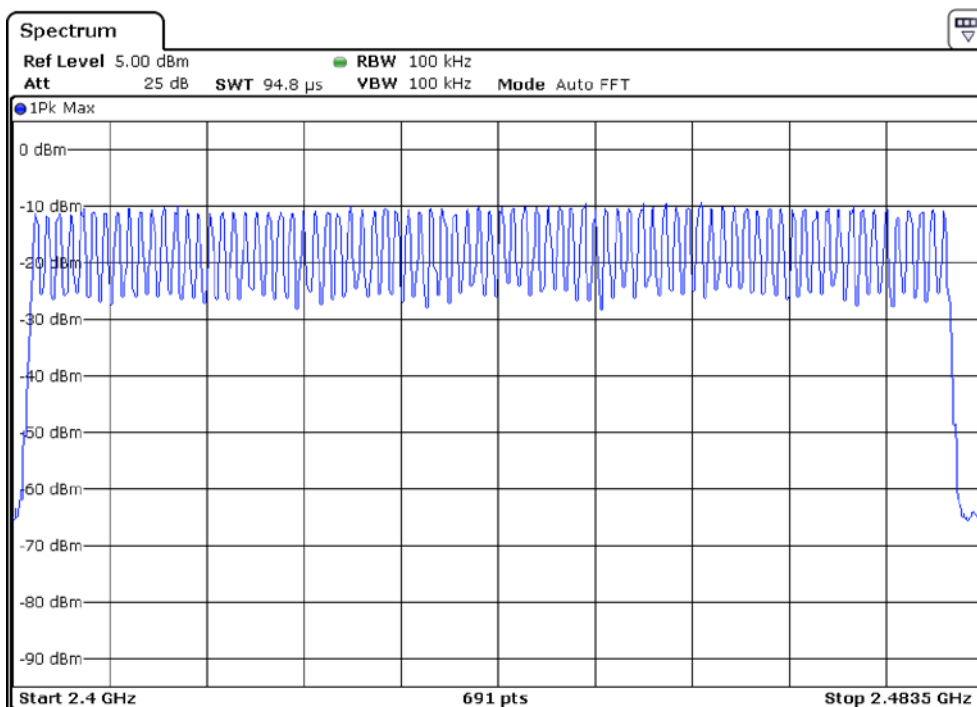

3.3.3 20 dB Bandwidth

Procedure:

The bandwidth at 20 dB below the highest inband spectral density was measured with a spectrum analyzer connected to the antenna terminal, while EUT had its hopping function disabled at the highest, middle and the lowest available channels..

After the trace being stable, Use the marker-to-peak function to set the marker to the peak of the emission. Use the marker-delta function to measure 20 dB down one side of the emission. Reset the marker-delta function, and move the marker to the other side of the emission, until it is (as close as possible to) even with the reference marker level. The marker-delta reading at this point is the 20 dB bandwidth of the emission.

The spectrum analyzer is set to (Bluetooth):

Center frequency = the highest, middle and the lowest channels

Span = 3 MHz (approximately 2 or 3 times of the 20 dB bandwidth)

RBW = 30 kHz

Sweep = auto

VBW = 30 kHz (VBW \geq RBW)

Detector function = peak

Trace = max hold

Measurement Data:

BDR Mode

Frequency (MHz)	Channel No.	Test Results(MHz)	
		20dB Bandwidth	99% Bandwidth
2402	0	1.038	0.912
2441	39	1.051	0.912
2480	78	1.081	0.907

EDR Mode

Frequency (MHz)	Channel No.	Test Results(MHz)	
		20dB Bandwidth	99% Bandwidth
2402	0	1.346	1.203
2441	39	1.346	1.203
2480	78	1.350	1.203

- See next pages for actual measured spectrum plots.

Minimum Standard:

N/A

Measurement Setup

Same as the Chapter 3.3.1 (Figure 1)

Channel 1 of BDR mode

20 dB Bandwidth

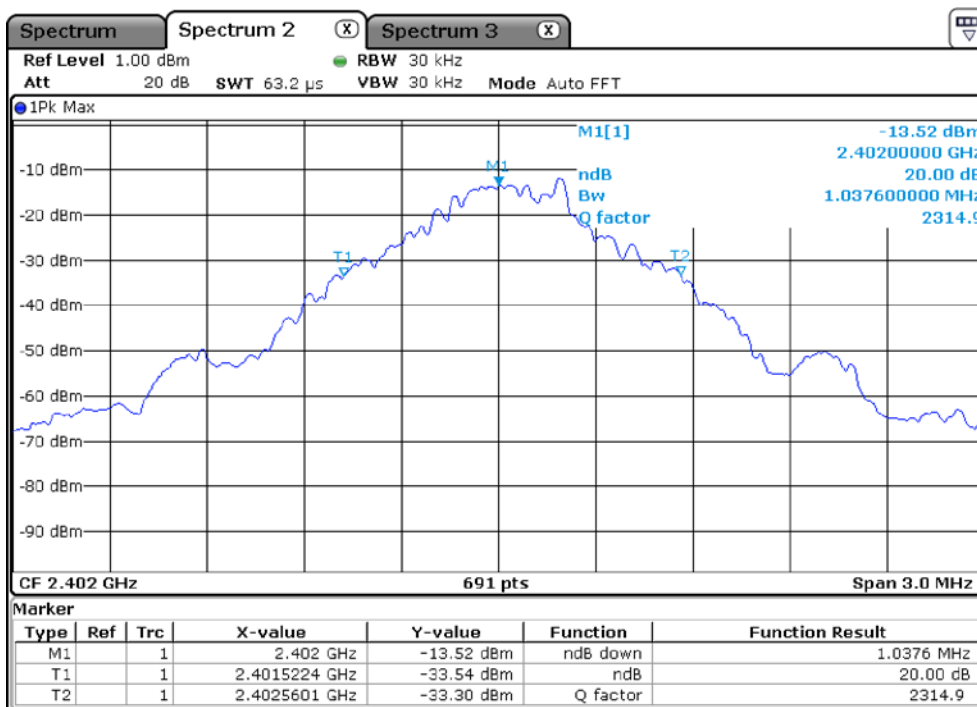

99% Bandwidth

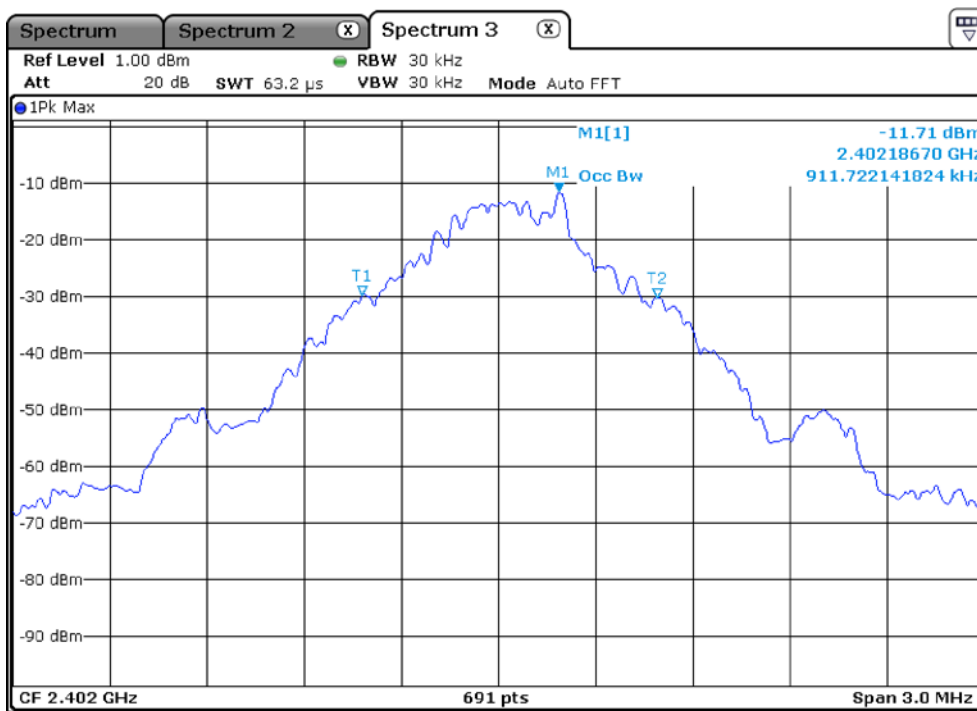

Channel 40 of BDR mode

20 dB Bandwidth

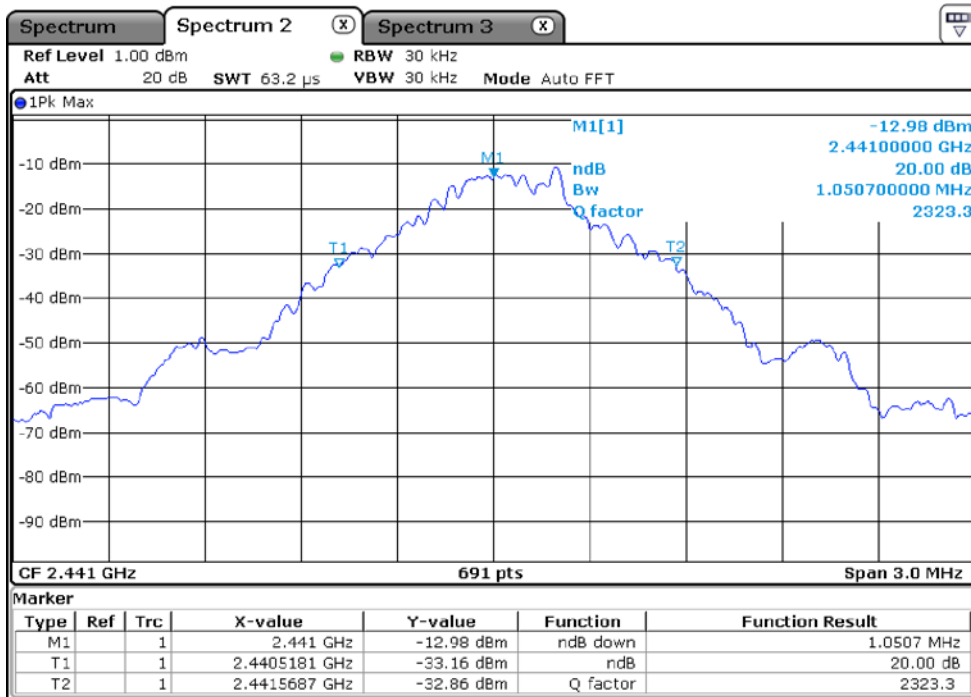

99% Bandwidth

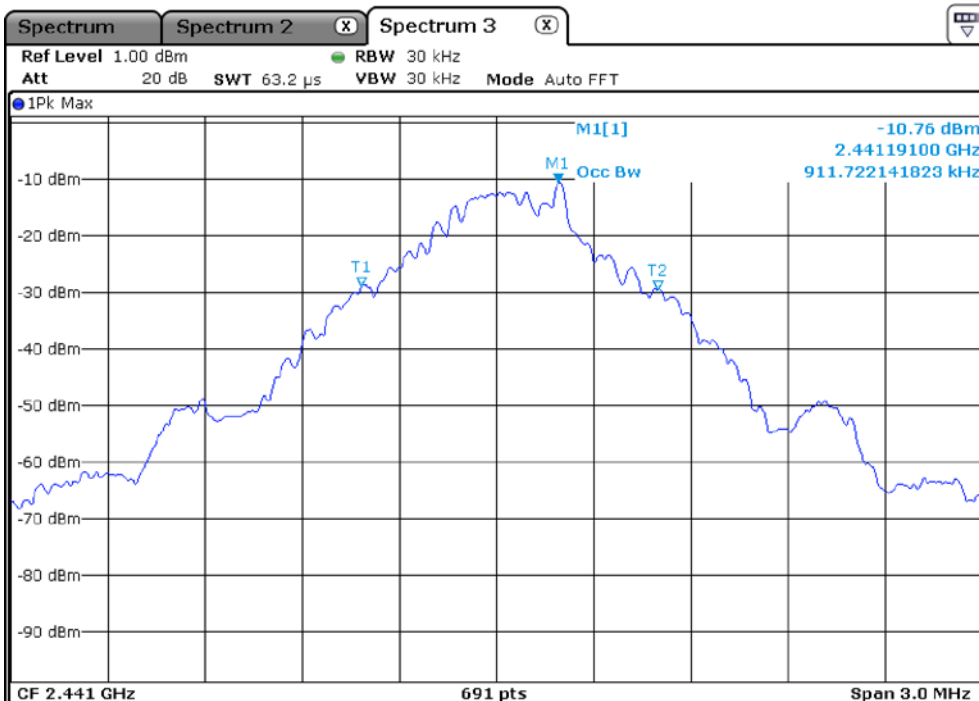

Channel 79 of BDR mode

20 dB Bandwidth

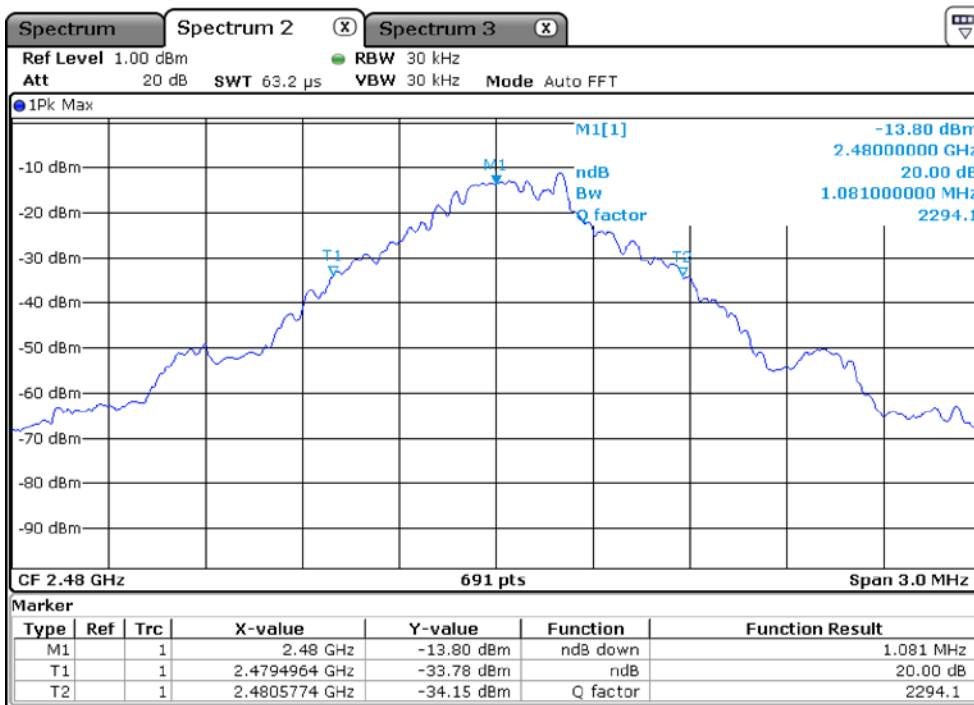

99% Bandwidth

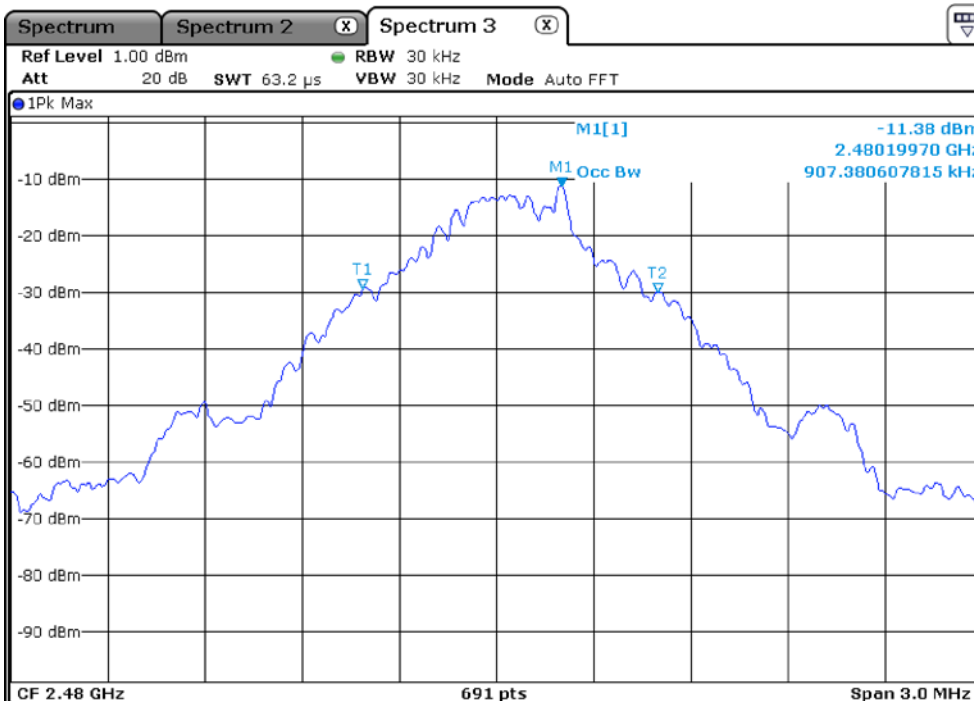

Channel 1 of EDR mode

20 dB Bandwidth

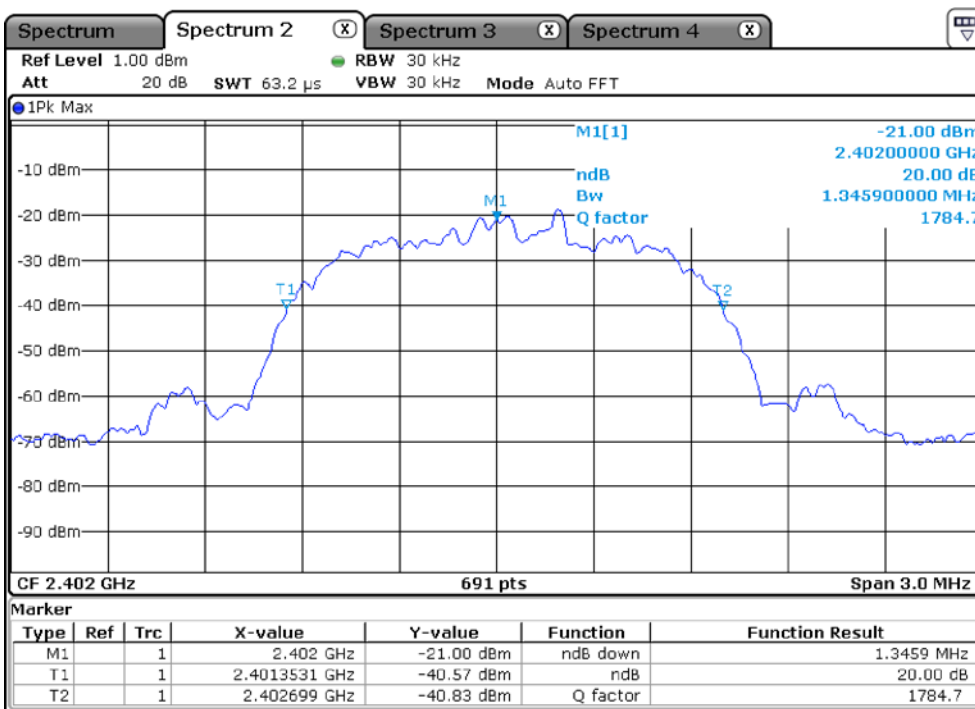

99% Bandwidth

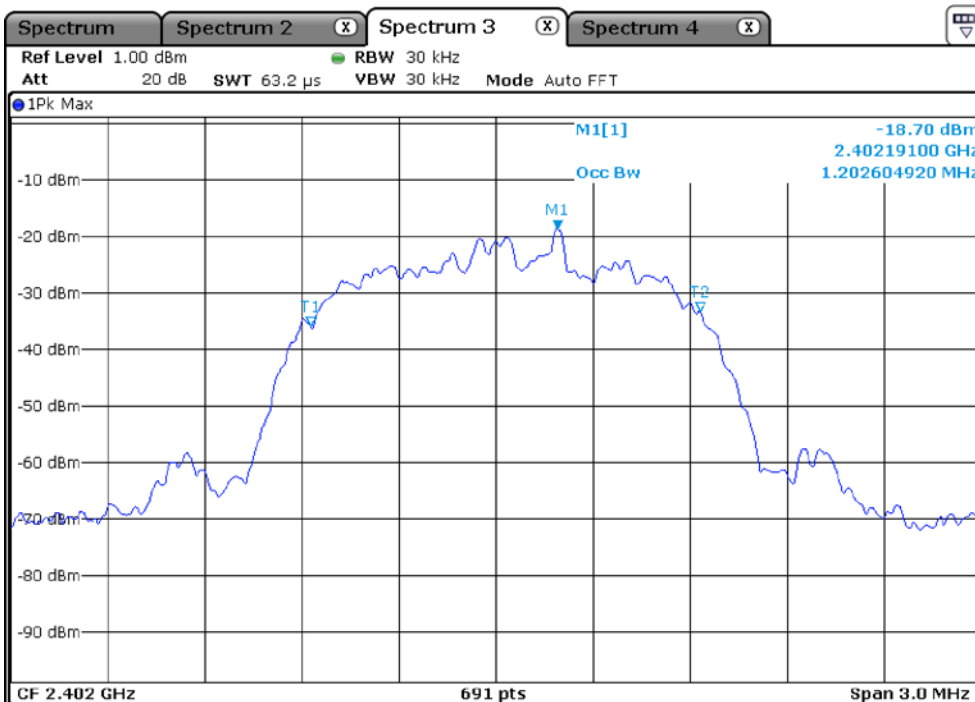

Channel 40 of EDR mode

20 dB Bandwidth

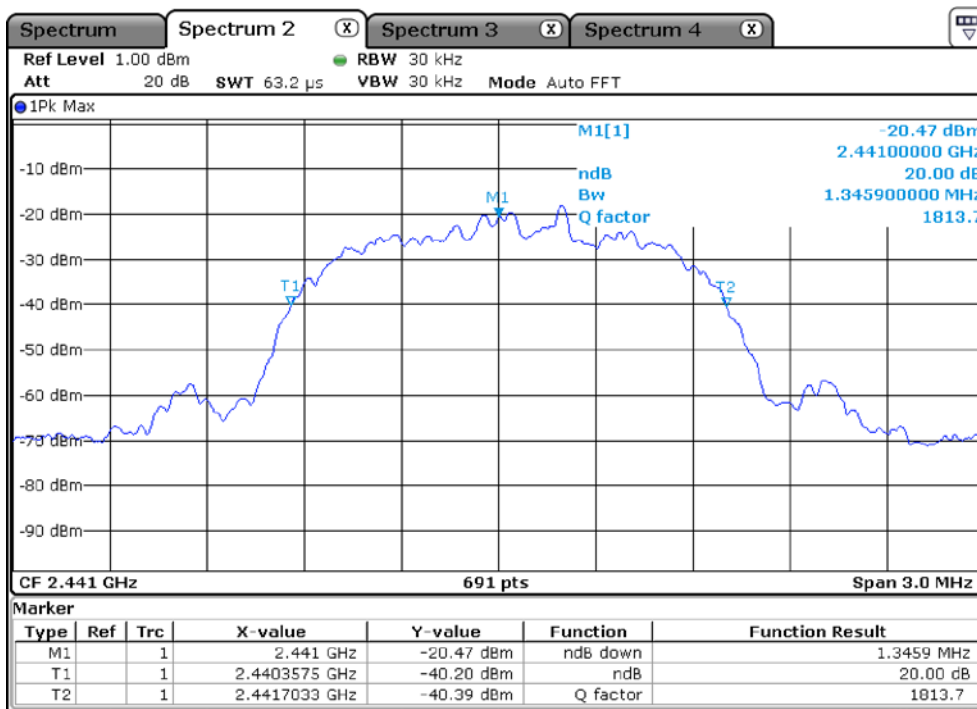

99% Bandwidth

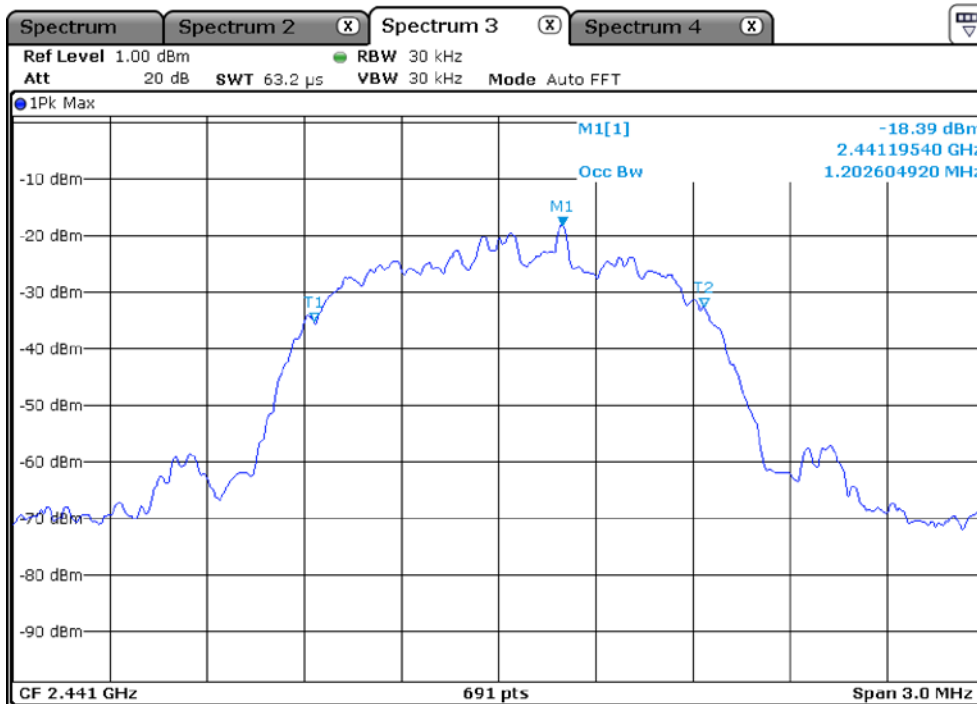

Channel 79 of EDR mode

20 dB Bandwidth

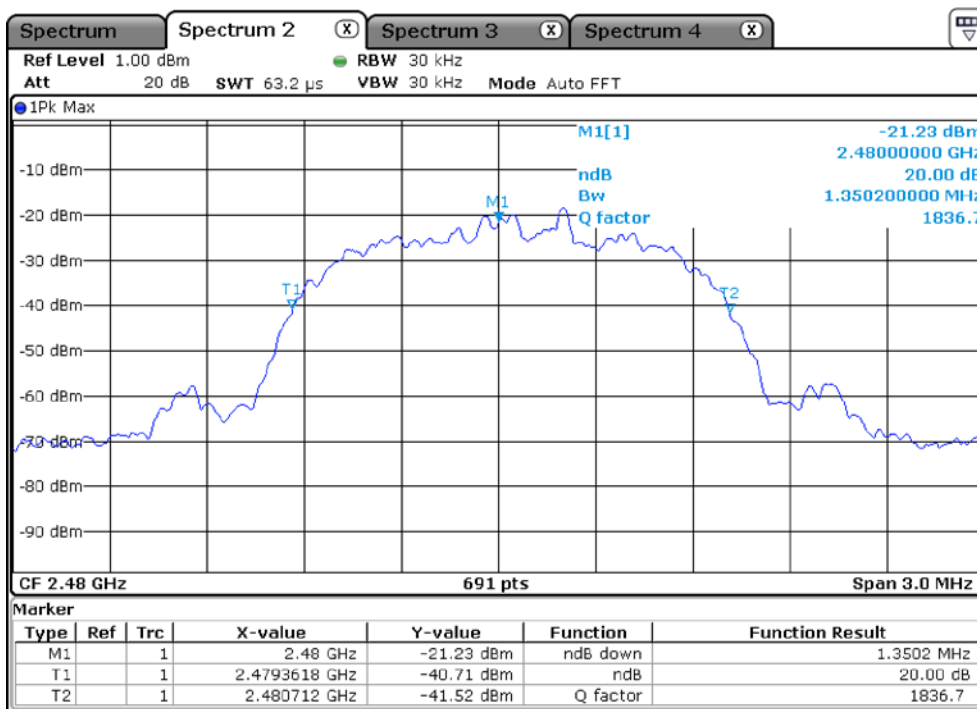

99% Bandwidth

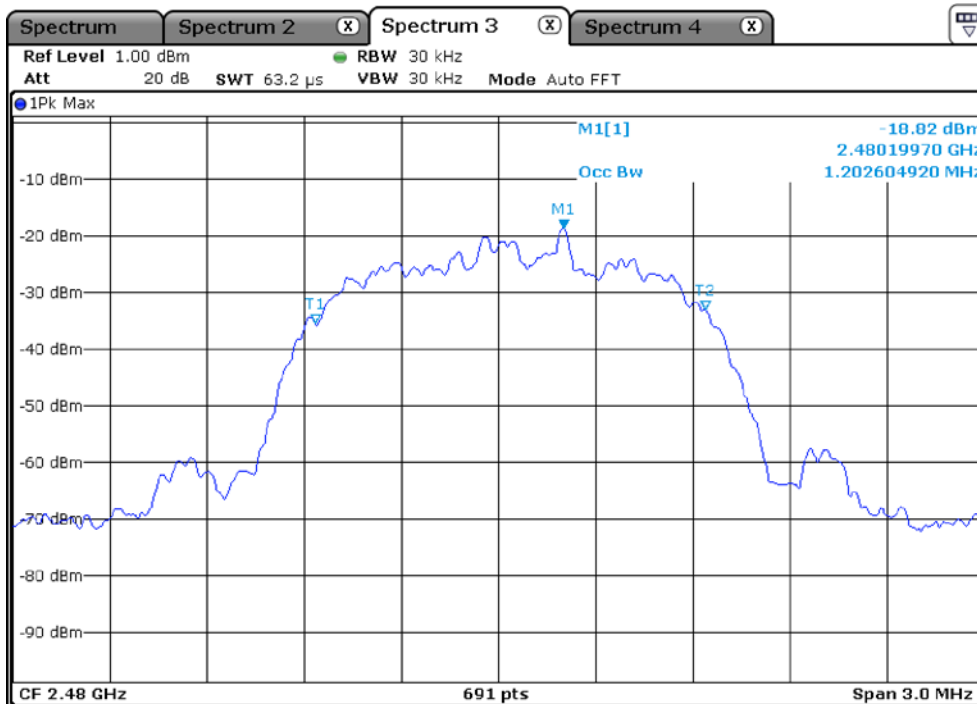

3.3.4 Time of Occupancy (Dwell Time)

Procedure:

The test follows ANSI C63.10. The dwell time was measured with a spectrum analyzer connected to the antenna terminal, while EUT had its hopping function enabled.

The spectrum analyzer is set to :

- Center frequency = 2441 MHz
- Span = zero
- RBW = 1 MHz
- VBW = 1 MHz (VBW ≥ RBW)
- Trace = max hold
- Detector function = peak

Measurement Data (Basic,EDR):

Mode	Number of transmission in a 31.6s (79Hopping*0.4)	Length of Transmission Time (msec)	Result (msec)	Limit (msec)
DH5	8(Times / 3sec) *10.533 = 84.264	2.870	241.838	400
3-DH5	4(Times / 3sec) *10.533 = 42.132	2.855	120.287	

- See next pages for actual measured spectrum plots.
- dwell time = {(number of hopping per second / number of slot) x duration time per channel} x 0.4 ms

Minimum Standard:

0.4 seconds within a period of 0.4 seconds multiplied by the number of hopping channels employed

Measurement Setup

Same as the Chapter 3.3.1 (Figure 1)

DH5 at BDR mode

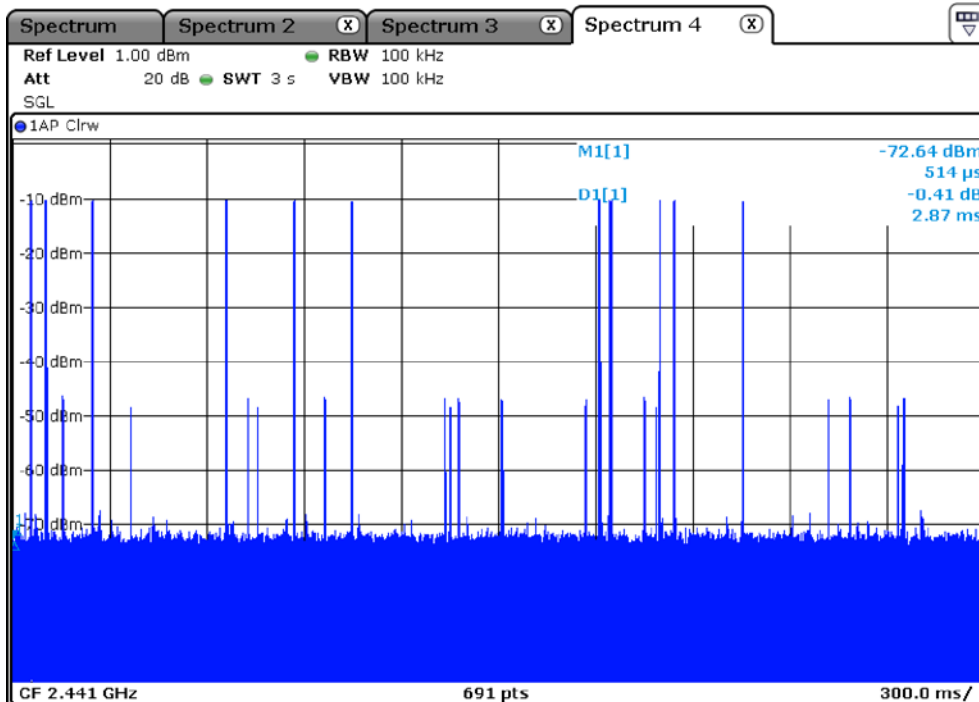
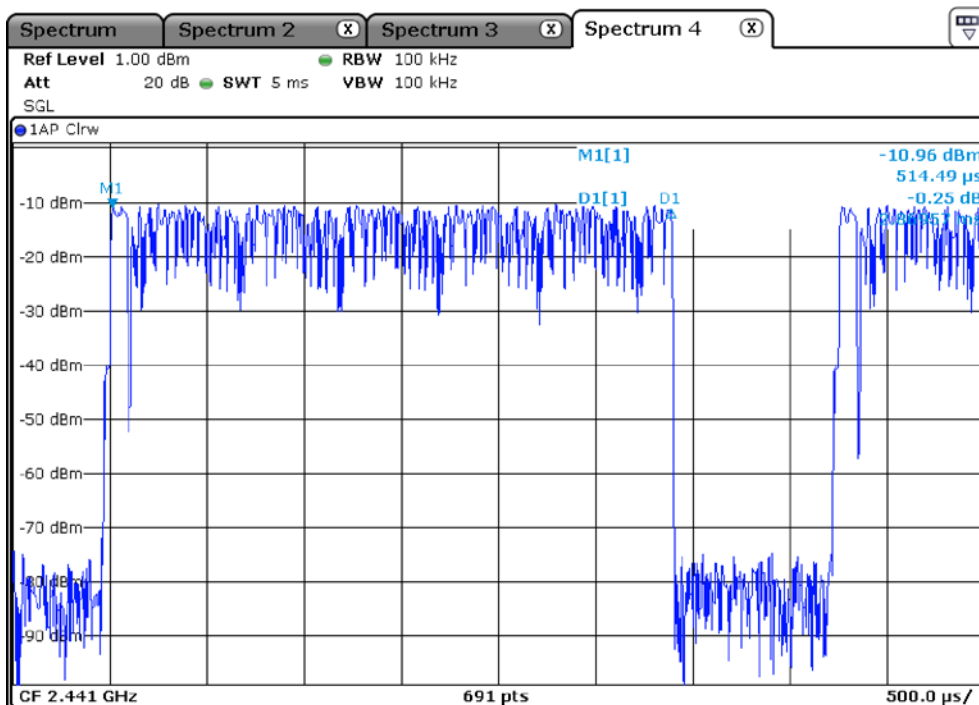

3-DH5 at EDR mode

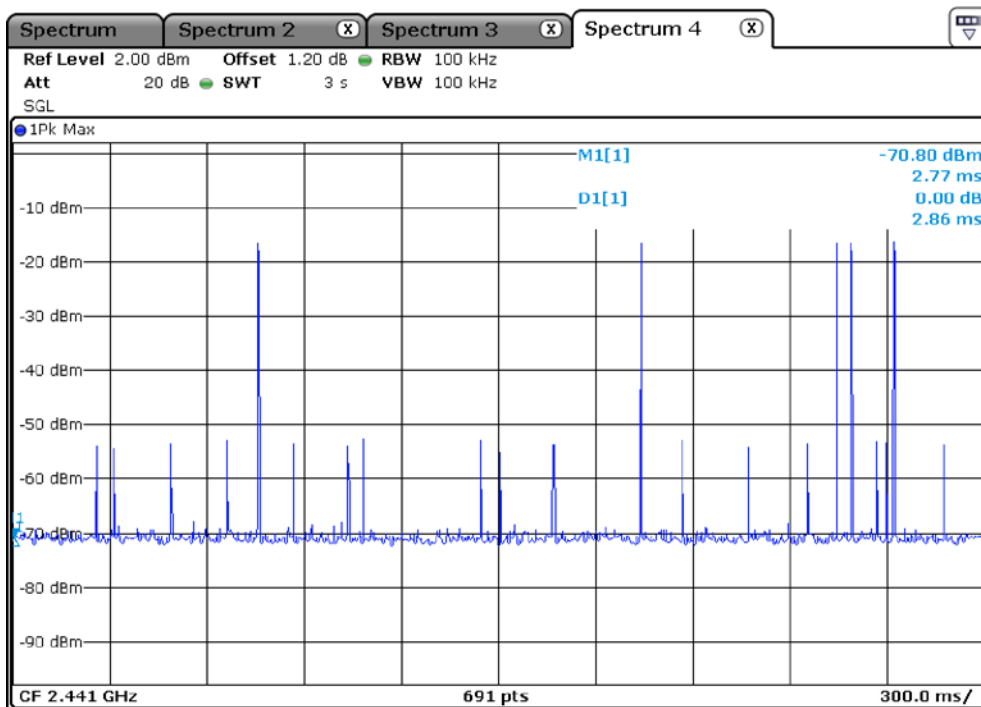
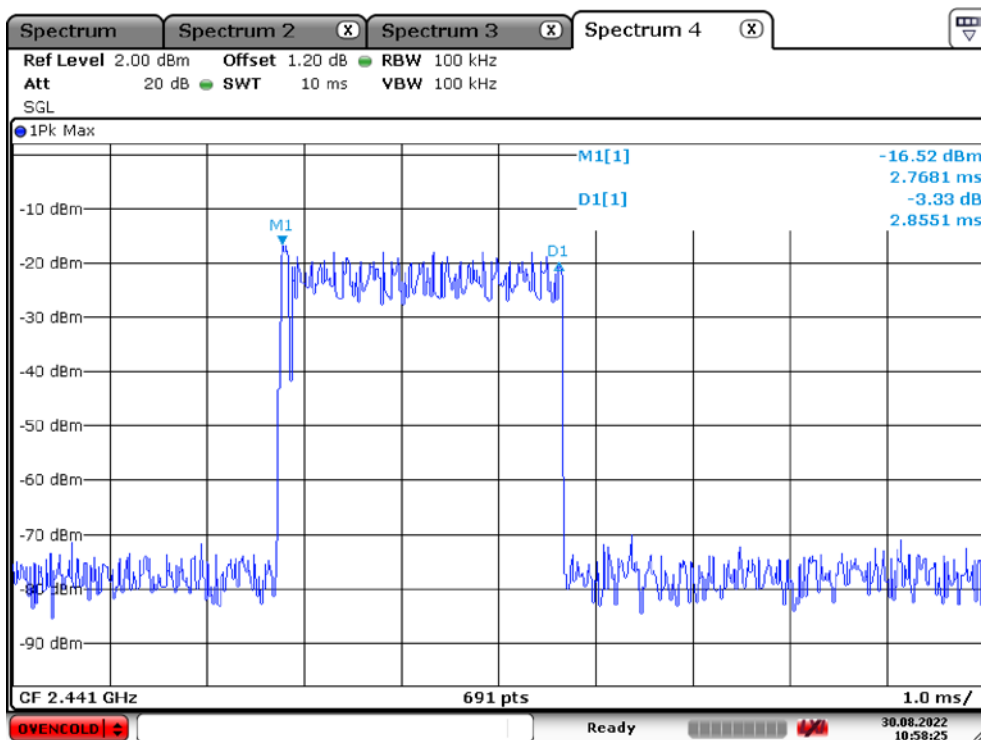

3.3.5 Transmitter Output Power

Procedure:

The test follows ANSI C63.10. The peak output power was measured with a spectrum analyzer connected to the antenna terminal, while EUT had its hopping function disabled at the highest, middle and the lowest available channels..

After the trace being stable, Use the marker-to-peak function to set the marker to the peak of the emission. The indicated level is the peak output power.

The spectrum analyzer is set to :

Center frequency = the highest, middle and the lowest channels

Span = 10 MHz (approximately 5 times of the 20 dB bandwidth)

RBW = 3 MHz (greater than the 20 dB bandwidth of the emission being measured)

VBW = 3 MHz (VBW \geq RBW)

Detector function = peak

Trace = max hold

Sweep = auto

Measurement Data :

BDR Mode

Frequency (MHz)	Ch.	Test Results	
		dBm	Result
2402	1	-9.22	Complies
2441	40	-8.24	Complies
2480	79	-8.85	Complies

EDR Mode

Frequency (MHz)	Ch.	Test Results	
		dBm	Result
2402	1	-13.15	Complies
2441	40	-12.79	Complies
2480	79	-12.61	Complies

- See next pages for actual measured spectrum plots.

Minimum Standard:	For frequency hopping systems with at least 75 non-overlapping hopping channels: 1 watt. For all other frequency hopping systems: 0.125 W.
--------------------------	--

Measurement Setup

Same as the Chapter 3.3.1 (Figure 1)

Channel 1
BDR mode

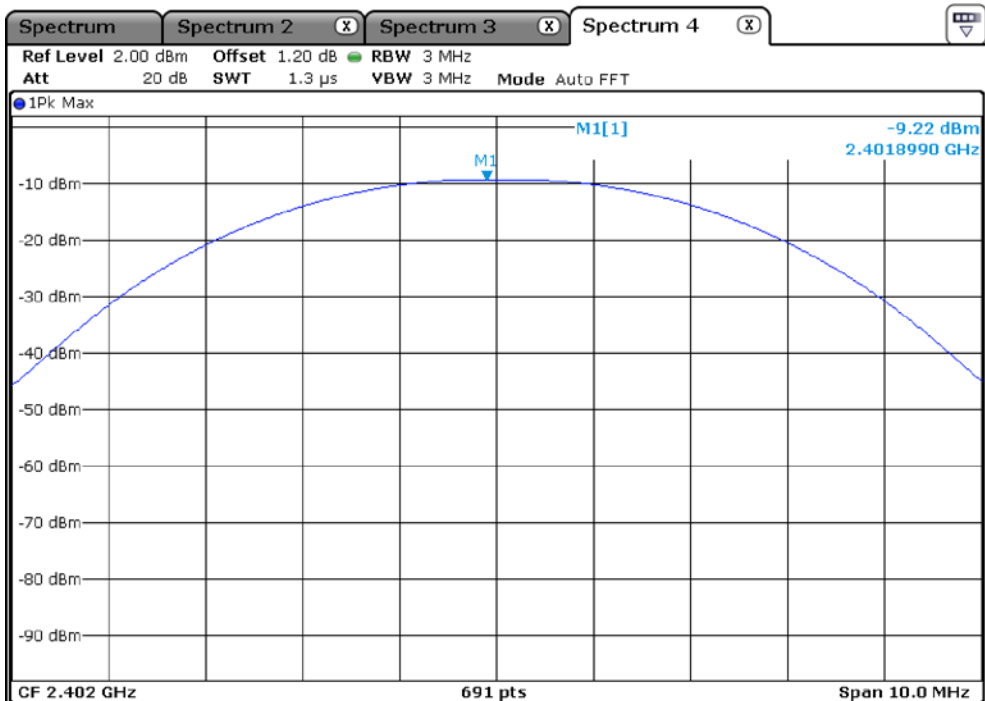

Channel 40
BDR mode

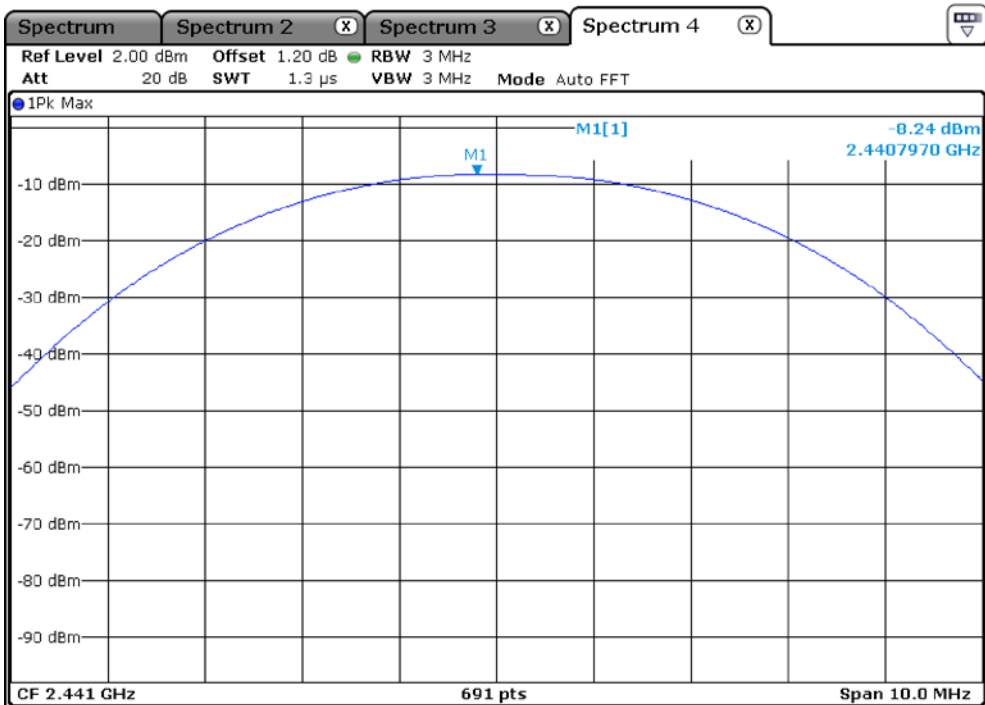

Channel 79
BDR mode

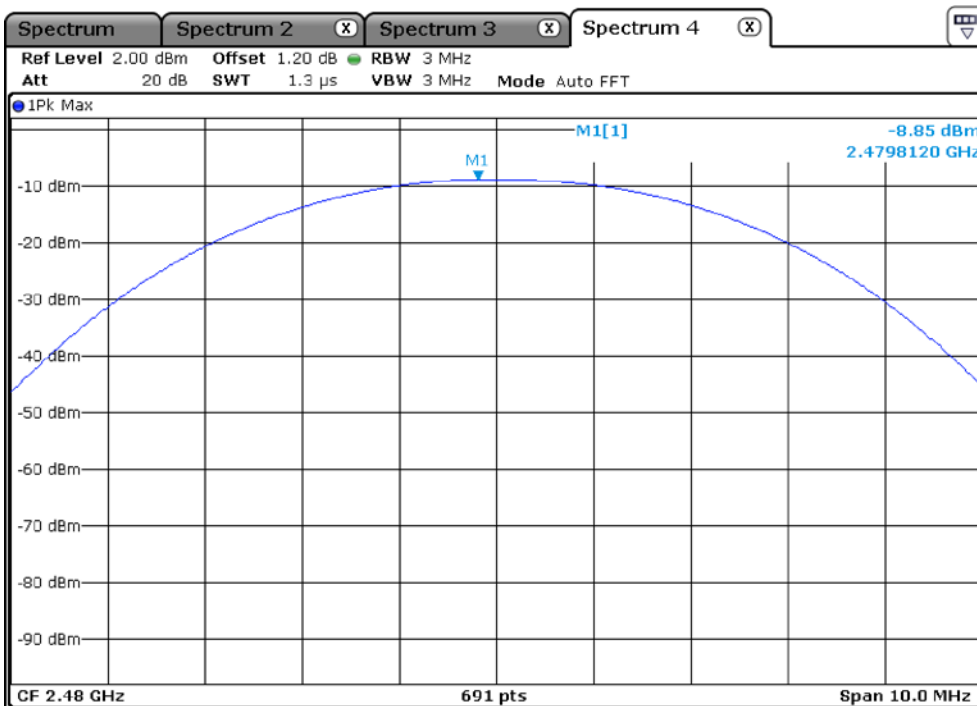

Channel 1
EDR mode

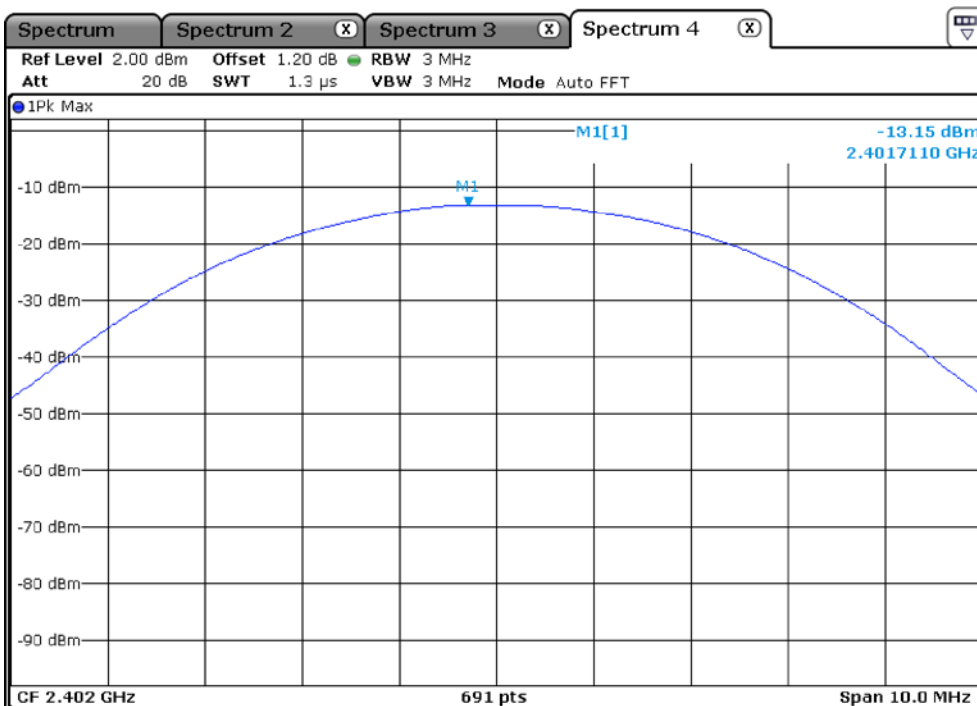

Channel 40
EDR mode

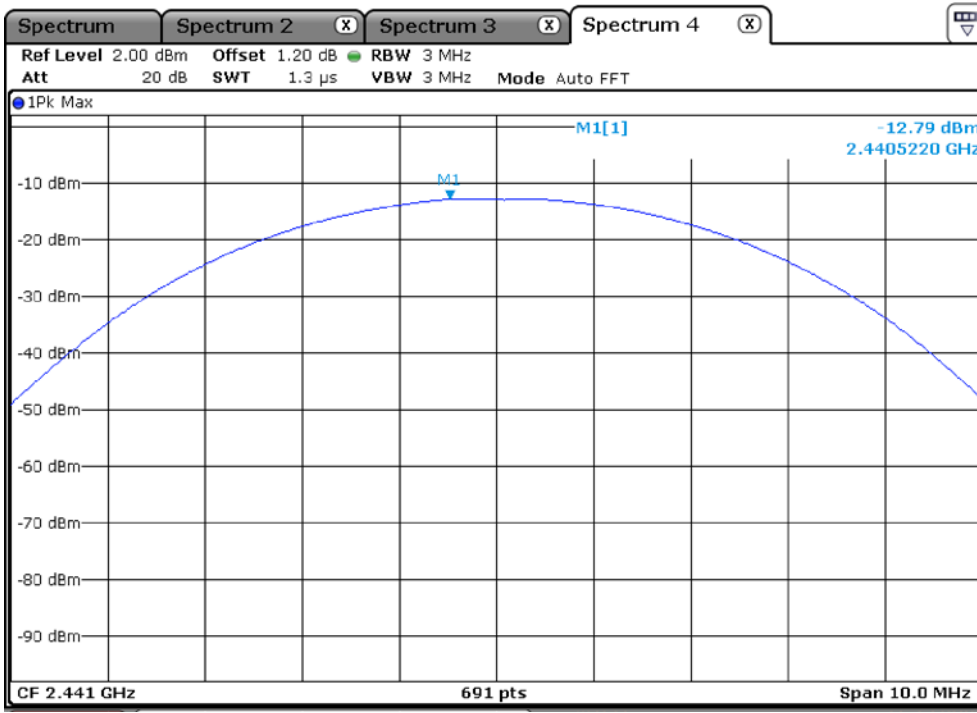

Channel 79
EDR mode

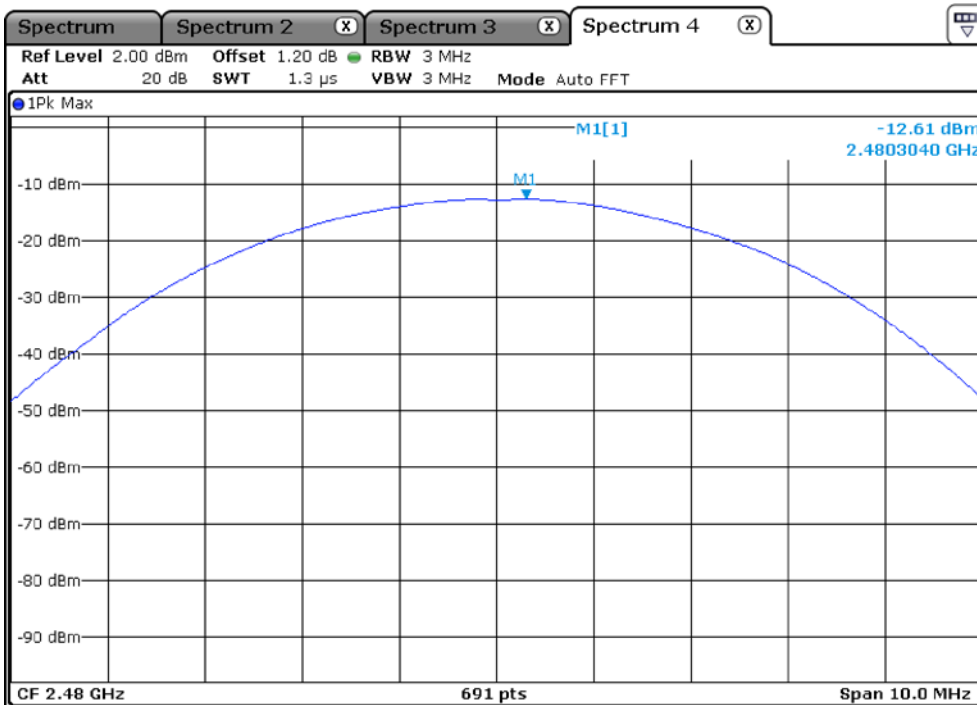

3.3.6 Band Edge

Procedure:

The bandwidth at 20 dB down from the highest inband spectral density is measured with a spectrum analyzer connected to the antenna terminal, while EUT had its hopping function disabled at the highest, middle and the lowest available channels.

After the trace being stable, Use the marker-to-peak function to measure 20 dB down both sides of the intentional emission.

The spectrum analyzer is set to:

Center frequency = the highest, middle and the lowest channels

RBW = 100 kHz

VBW = 100 kHz

Span = 10~30 MHz

Detector function = peak

Trace = max hold

Sweep = auto

Measurement Data: Complies

Frequency (MHz)	Test Results	
	dBc	Result
Low edge	56.61	Complies
High edge	59.46	Complies

Frequency (MHz)	Test Results	
	dBc	Result
Low edge	54.15	Complies
High edge	56.39	Complies

- All conducted emission in any 100 kHz bandwidth outside of the spread spectrum band was at least 20 dB lower than the highest inband spectral density. Therefore the applying equipment meets the requirement.
- See next pages for actual measured spectrum plots.

Minimum Standard:	> 20 dBc
--------------------------	----------

Measurement Setup

Same as the Chapter 3.3.1 (Figure 1)

BDR

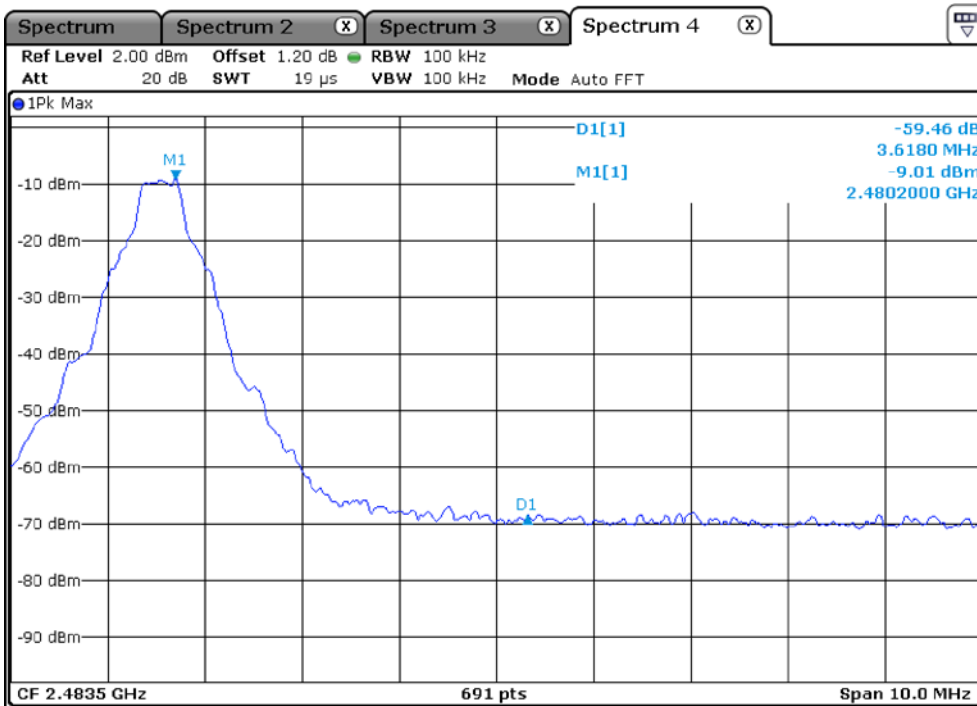
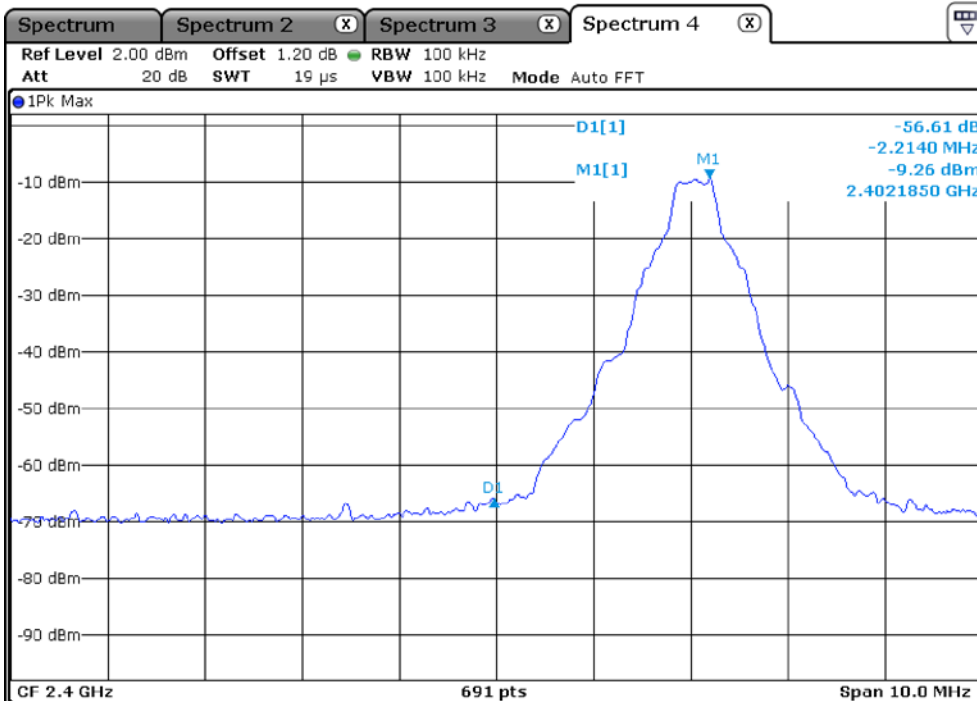

EDR

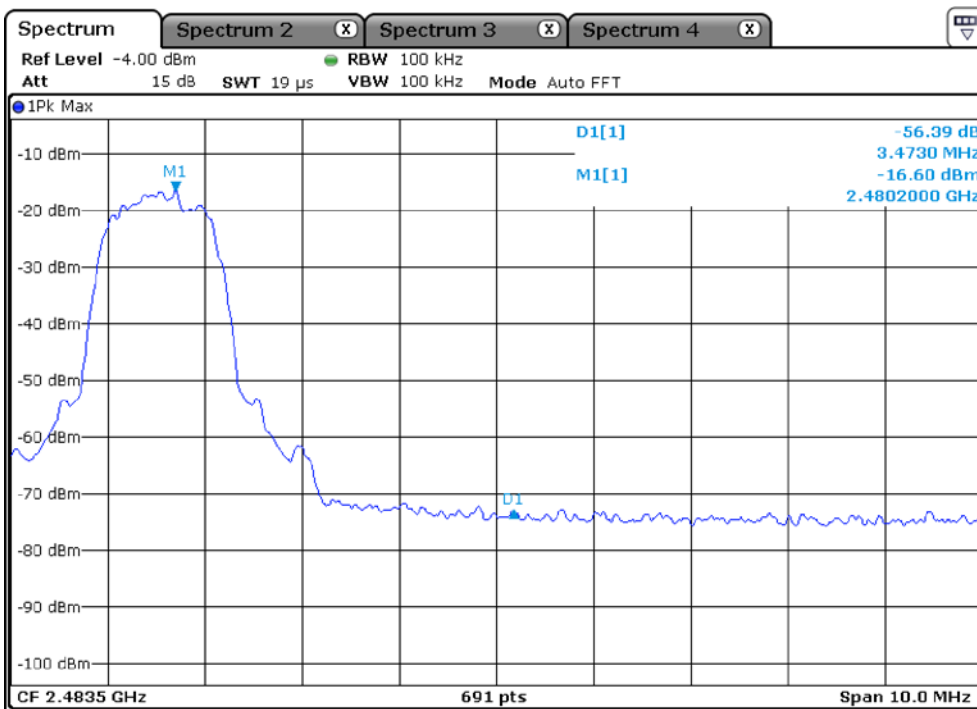
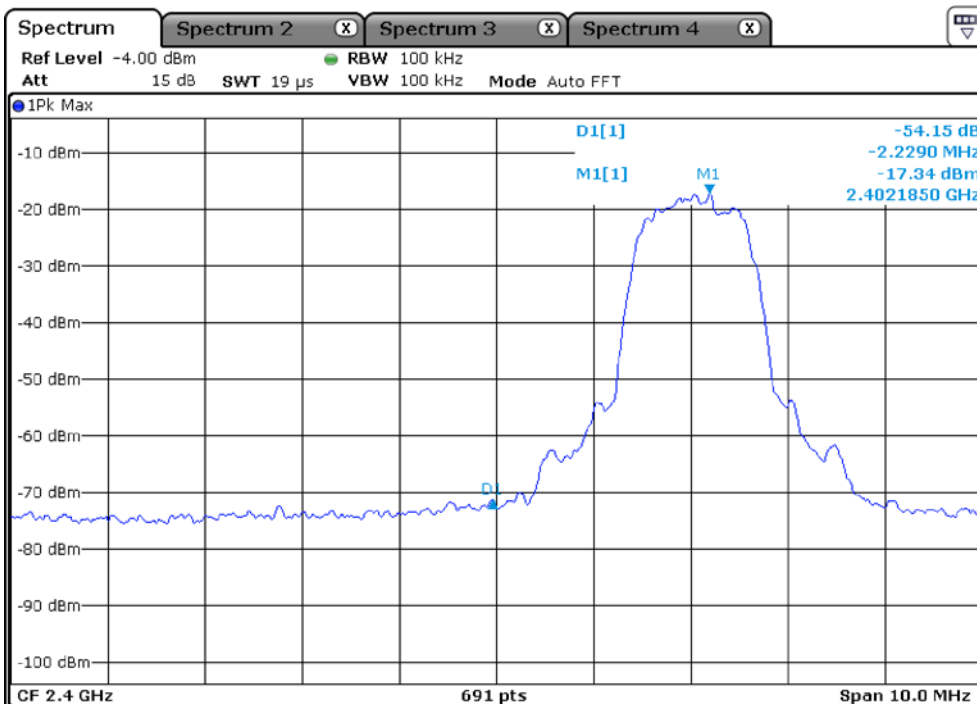

3.3.7 Conducted Spurious Emissions

Procedure:

The test follows ANSI C63.10. The conducted spurious emissions were measured with a spectrum analyzer connected to the antenna terminal, while EUT had its hopping function disabled at the highest, middle and the lowest available channels..

After the trace being stable, set the marker on the peak of any spurious emission recorded.

The spectrum analyzer is set to:

- Span = wide enough to capture the peak level of the in-band emission and all spurious emissions
- RBW = 100 kHz Sweep = auto
- VBW = 100 kHz Detector function = peak
- Trace = max hold

Measurement Data: Complies

Frequency (MHz)	Test Results	
	dBc	Result
2402	52.40	Complies
2442	53.35	Complies
2480	52.87	Complies

Frequency (MHz)	Test Results	
	dBc	Result
2402	51.71	Complies
2442	54.11	Complies
2480	51.95	Complies

- All conducted emission in any 100 kHz bandwidth outside of the spread spectrum band was at least 20 dB lower than the highest inband spectral density. Therefore the applying equipment meets the requirement.
- See next pages for actual measured spectrum plots.

Minimum Standard:	> 20 dBc
--------------------------	----------

Measurement Setup

Same as the Chapter 3.3.1 (Figure 1)

Unwanted Emission BDR – Low, Middle, High
Frequency Range = 30 MHz ~ 26.5 GHz

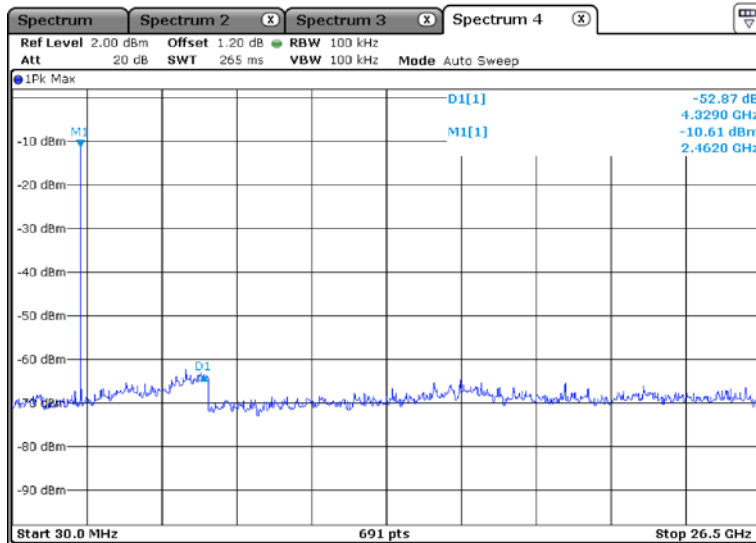
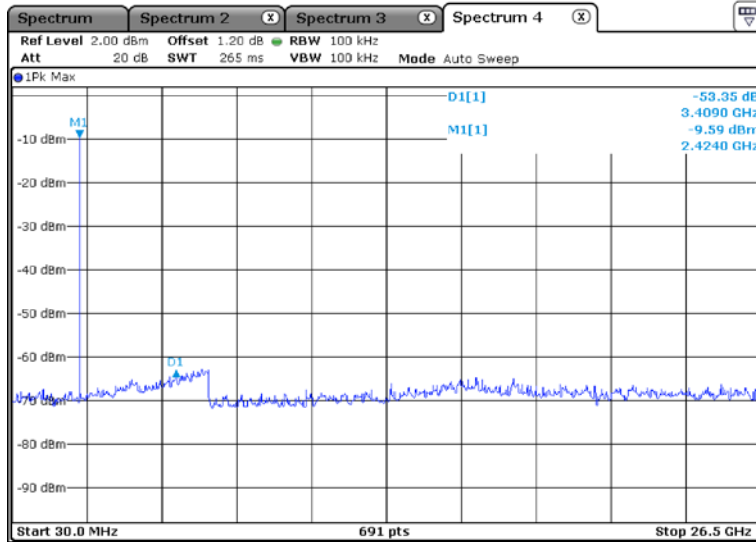
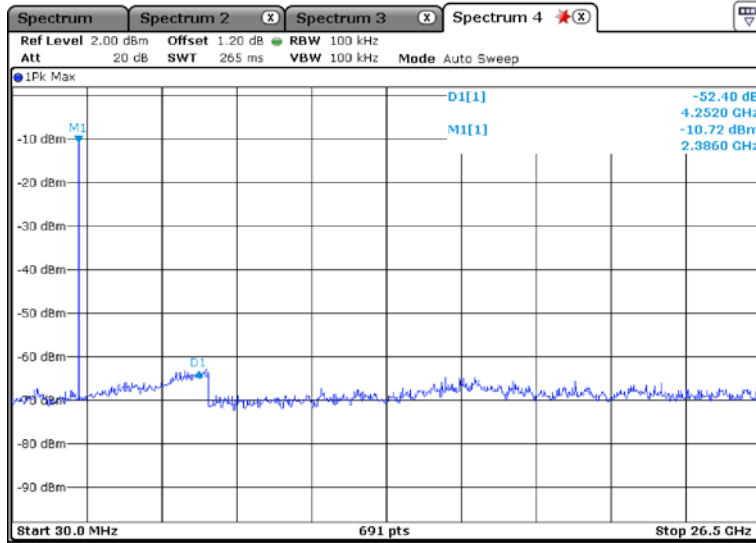

Unwanted Emission EDR – Low, Middle, High
Frequency Range = 30 MHz ~ 26.5 GHz

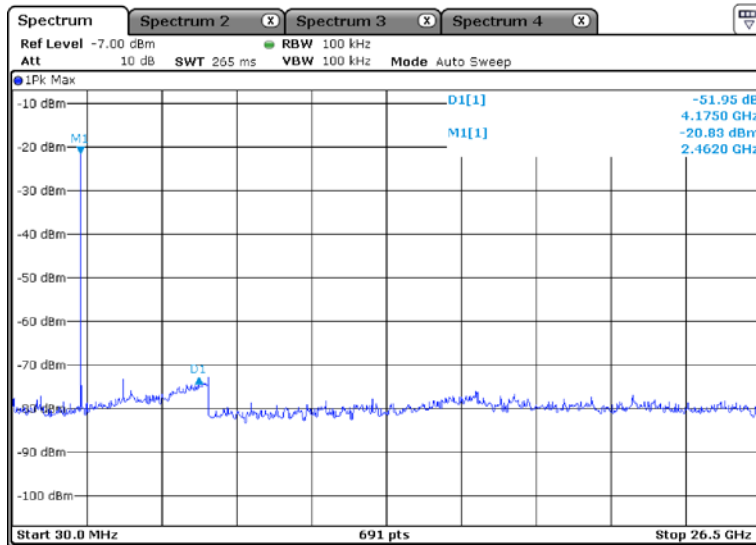
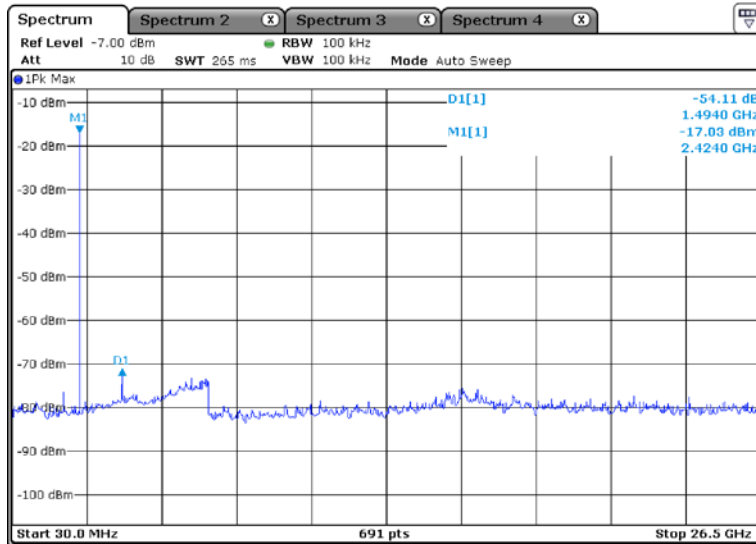
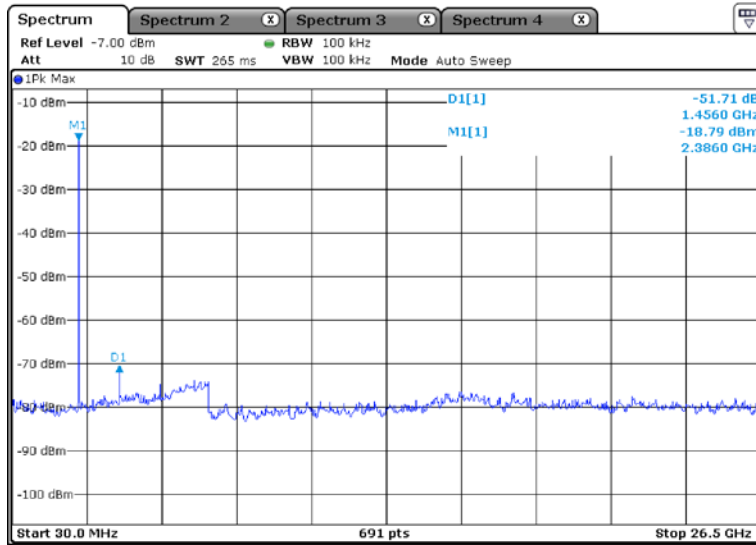

3.3.8 Radiated Spurious Emissions

Procedure:

Radiated emissions from the EUT were measured according to the dictates of ANSI C63.10. The EUT was placed on a 0.8 m high wooden table inside a shielded enclosure. An antenna was placed near the EUT and measurements of frequencies and amplitudes of field strengths were recorded for reference during final measurements. For final radiated testing, measurements were performed in OATS. Measurements were performed with the EUT oriented in 3 orthogonal axis and rotated 360 degrees to determine worst-case orientation for maximum emissions.

- (a) In the frequency range of 9 kHz to 30 MHz, magnetic field is measured with Loop Test Antenna. The Test Antenna is positioned with its plane vertical at 3 m distance from the EUT. The center of the Loop Test Antenna is 1m above the ground. During the measurement the Loop Test Antenna rotates about its vertical axis for maximum response at each azimuth about the EUT.
- (b) In the frequency range above 30 MHz, Bi-Log Test Antenna (30 MHz to 1 GHz) and Horn Test Antenna (above 1 GHz) are used. Test Antenna is 3 m away from the EUT. Test Antenna height is carried from 1 m to 4m above the ground to determine the maximum value of the field strength. The emission levels at both horizontal and vertical polarizations should be tested.

The spectrum analyzer is set to:

Center frequency = the worst channel

Frequency Range = 9 kHz ~ 10th harmonic.

RBW = 120 kHz (30 MHz ~ 1 GHz) VBW \geq RBW
= 1 MHz (1 GHz ~ 10th harmonic)

Span = 100 MHz Detector function = peak

Trace = max hold Sweep = auto

below 30 MHz

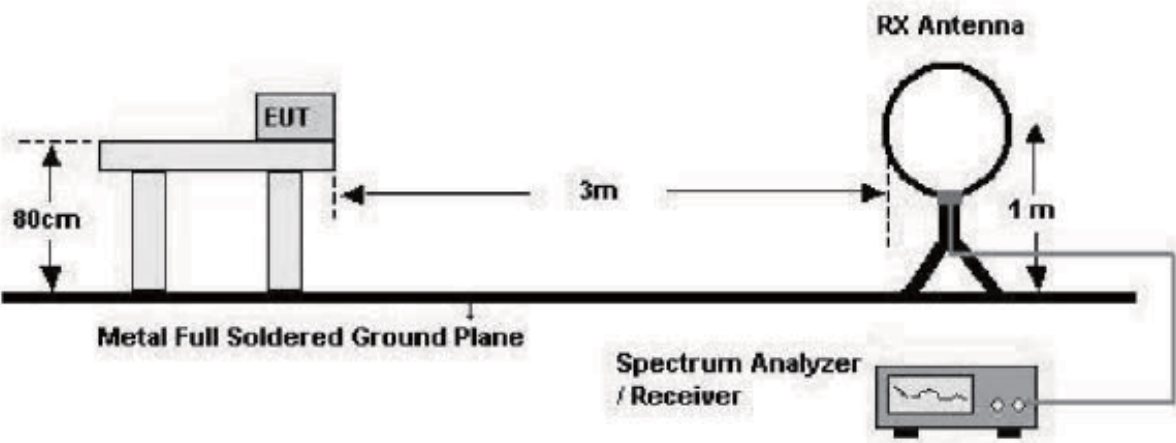

below 1 GHz (30 MHz to 1 GHz)

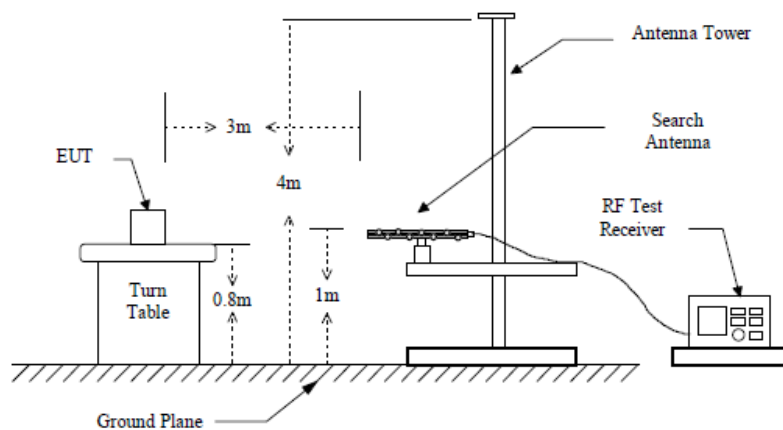

above 1 GHz

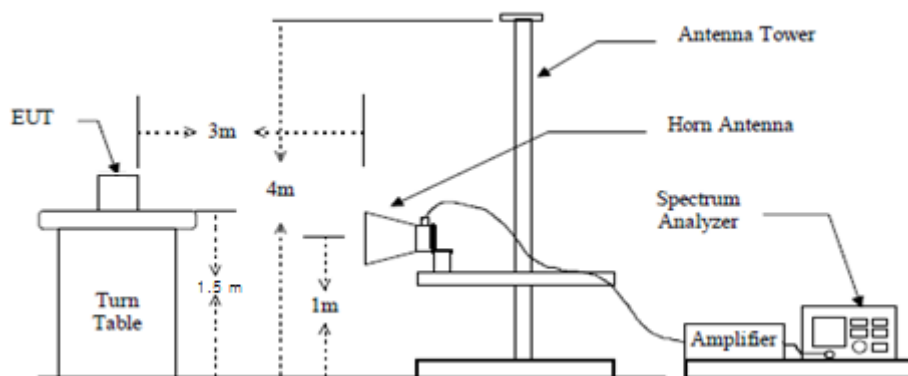

Measurement Data: Complies

- See next pages for actual measured data.
- No other emissions were detected at a level greater than 20 dB below limit include from 9 kHz to 30 MHz.
- The test results for the worst of the various operating modes are presented in accordance with 6.3.4 of ANSI C63.10.
- Checked with a red circle is the fundamental frequency.

Minimum Standard: FCC Part 15.209(a)

Frequency (MHz)	Limit (uV/m) @ 3m
0.009 ~ 0.490	2400/F(kHz) (@ 300m)
0.490 ~ 1.705	24000/F(kHz) (@ 30m)
1.705 ~ 30	30(@ 30m)
30 ~ 88	100 **
88 ~ 216	150 **
216 ~ 960	200 **
Above 960	500

** Except as provided in 15.209(g), fundamental emissions from intentional radiators operating under this Section shall not be located in the frequency bands 54-72 MHz, 76-88 MHz, 174-216 MHz or 470-806 MHz. However, operation within these frequency bands is permitted under other sections of this Part, e.g. 15.231 and 15.241.

Radiated Emissions-BDR

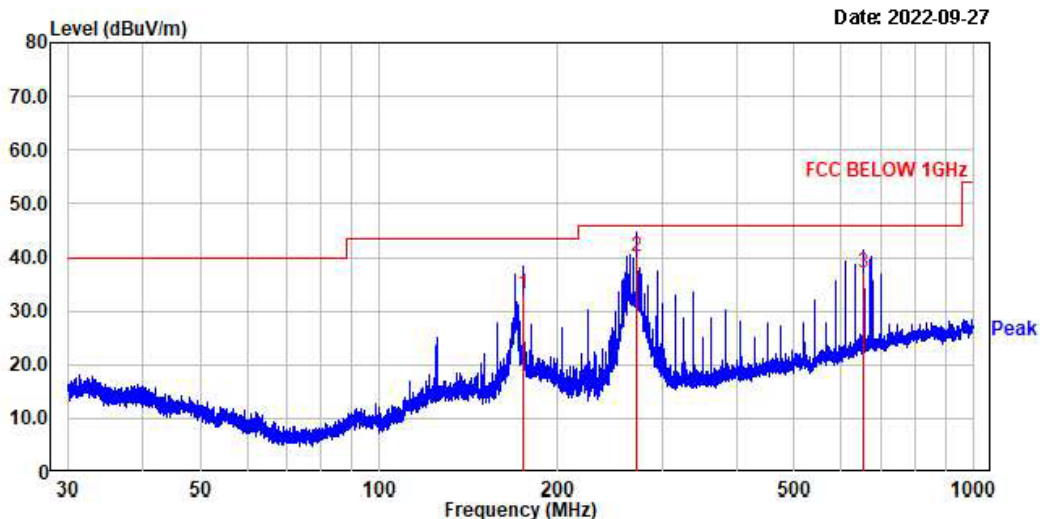

Trace:								
No.	Freq	Reading	C.F	Result	Limit	Margin	Height	Angle Polarity
	MHz	dBμV	dB	dBμV/m	dBμV/m	dB	cm	deg
1.	175.04	42.39	-9.07	33.32	43.50	10.18	223	360 horizontal
2.	270.97	50.60	-10.47	40.13	46.00	5.87	100	360 horizontal
3.	654.81	40.40	-3.27	37.13	46.00	8.87	160	360 horizontal

Remarks: C.F (Correction Factor) = Antenna factor + Cable loss - Preamp gain

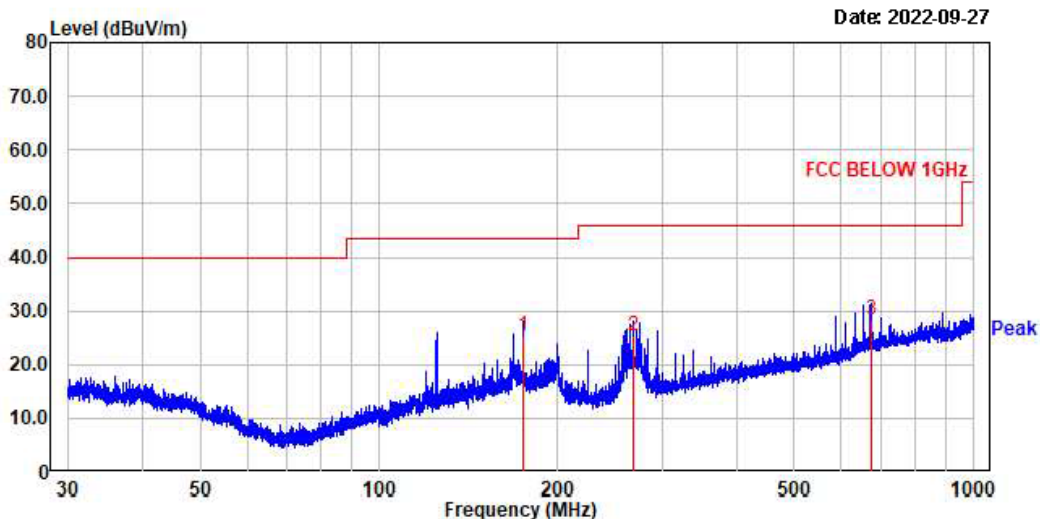

Trace:								
No.	Freq	Reading	C.F	Result	Limit	Margin	Height	Angle Polarity
	MHz	dBμV	dB	dBμV/m	dBμV/m	dB	cm	deg
1.	175.04	35.20	-9.78	25.42	43.50	18.08	100	90 vertical
2.	267.78	36.40	-11.03	25.37	46.00	20.63	100	43 vertical
3.	672.25	31.21	-2.69	28.52	46.00	17.48	100	243 vertical

Remarks: C.F (Correction Factor) = Antenna factor + Cable loss - Preamp gain

Date: 2022-09-27

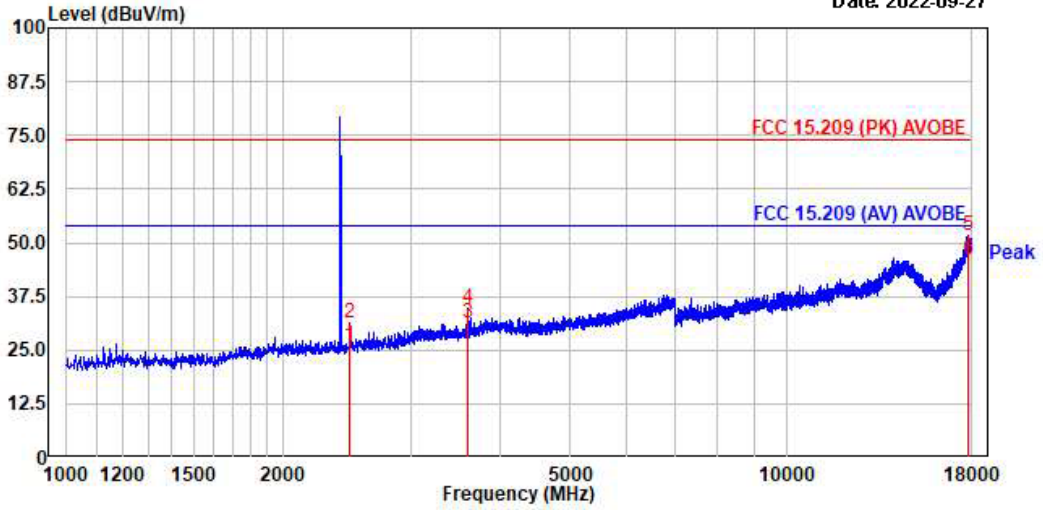

No.	Freq MHz	RD PK dBμV	RD AV dBμV	C.F dB	Result PK dBμV	Result AV dBμV	Limit PK dBμV	Limit AV dBμV	Margin PK dB	Margin AV dB	Height cm	Angle deg	Polarity
2.	2468.38	34.76	29.60	-3.56	31.20	26.84	74.00	54.00	42.80	27.96	100	356	horizontal
4.	3601.00	33.42	30.11	1.33	34.75	31.44	74.00	54.00	39.25	22.56	100	236	horizontal
5.	17870.38	25.86	-----	25.78	51.64	-----	74.00	-----	22.36	-----	100	356	horizontal
6.	17870.38	-----	20.40	25.78	-----	46.18	-----	54.00	-----	7.82	100	356	horizontal

Remarks: C.F (Correction Factor) = Antenna factor + Cable loss - Preamp gain

Date: 2022-09-27

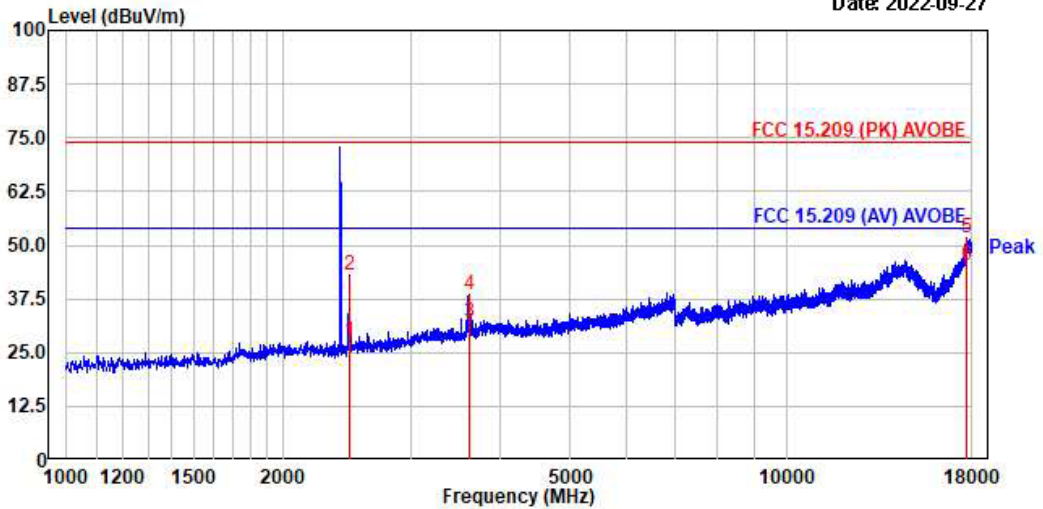

No.	Freq MHz	RD PK dBμV	RD AV dBμV	C.F dB	Result PK dBμV	Result AV dBμV	Limit PK dBμV	Limit AV dBμV	Margin PK dB	Margin AV dB	Height cm	Angle deg	Polarity
2.	2470.50	46.68	30.90	-3.53	43.15	27.37	74.00	54.00	30.85	26.63	100	0	vertical
4.	3626.50	36.91	30.69	1.49	38.40	32.18	74.00	54.00	35.60	21.82	100	11	vertical
5.	17725.88	26.76	-----	24.86	51.62	-----	74.00	-----	22.38	-----	100	327	vertical
6.	17725.88	-----	20.39	24.86	-----	45.25	-----	54.00	-----	8.75	100	327	vertical

Remarks: C.F (Correction Factor) = Antenna factor + Cable loss - Preamp gain

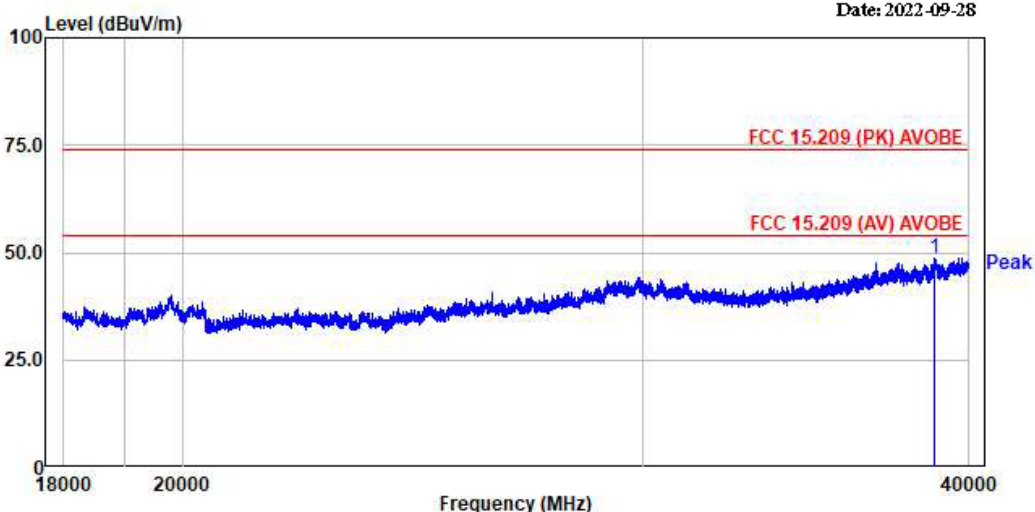

No.	Freq MHz	RD PK dBμV	RD AV dBμV	C.F dB	Result PK dBμV	Result AV dBμV	Limit PK dBμV	Limit AV dBμV	Margin PK dB	Margin AV dB	Height cm	Angle deg	Polarity
1.	38812.88	27.88	-----	21.61	48.69	-----	74.88	-----	25.31	-----	163	169	horizontal

Remarks: C.F (Correction Factor) = Antenna factor + Cable loss - Preamp gain

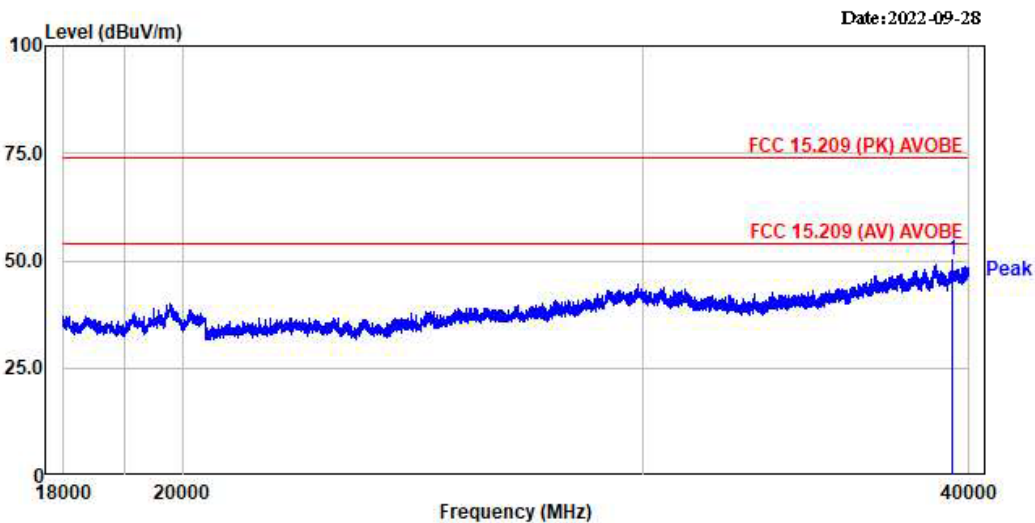

No.	Freq MHz	RD PK dBμV	RD AV dBμV	C.F dB	Result PK dBμV	Result AV dBμV	Limit PK dBμV	Limit AV dBμV	Margin PK dB	Margin AV dB	Height cm	Angle deg	Polarity
1.	39444.58	27.37	-----	22.74	58.11	-----	74.88	-----	23.89	-----	368	368	vertical

Remarks: C.F (Correction Factor) = Antenna factor + Cable loss - Preamp gain

Radiated Emissions-EDR

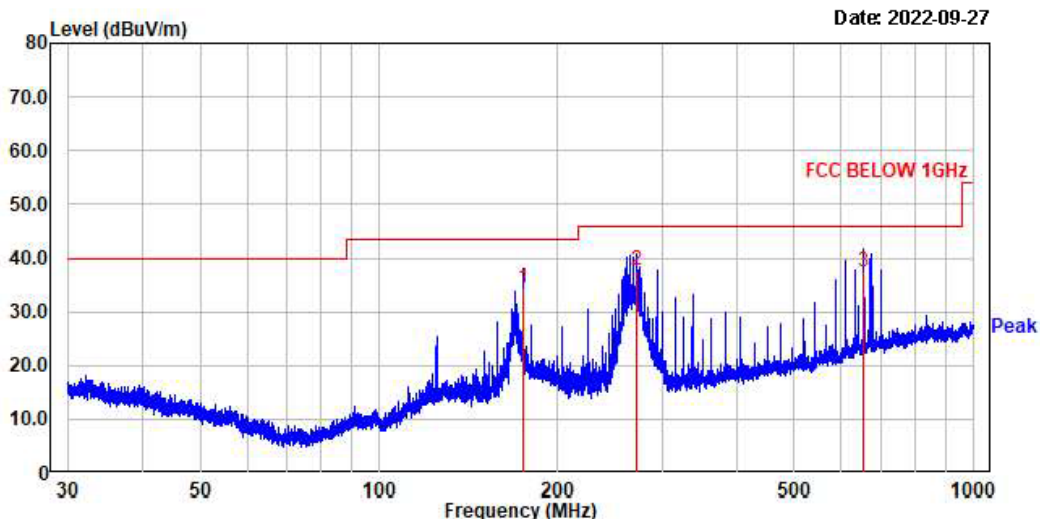

Date: 2022-09-27

Trace No.	Freq (MHz)	Reading (dBμV)	C.F (dB)	Result QP (dBμV/m)	Limit (dBμV/m)	Margin (dB)	Height (cm)	Angle (deg)	Polarity
1.	175.04	43.49	-9.07	34.42	43.50	9.08	221	360	horizontal
2.	270.97	48.20	-10.47	37.73	46.00	8.27	100	352	horizontal
3.	654.81	40.80	-3.27	37.53	46.00	8.47	140	360	horizontal

Remarks: C.F (Correction Factor) = Antenna factor + Cable loss - Preamp gain

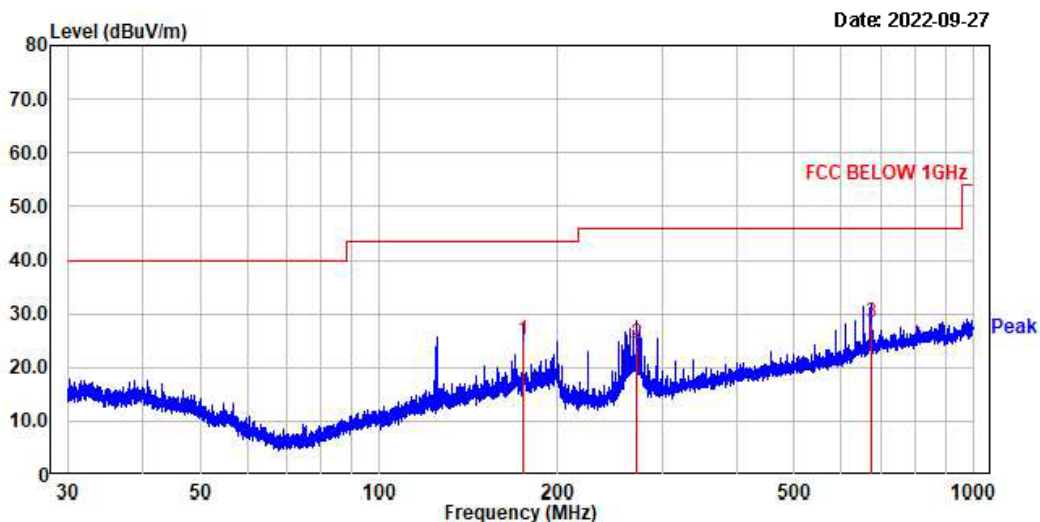

Date: 2022-09-27

Trace No.	Freq (MHz)	Reading (dBμV)	C.F (dB)	Result QP (dBμV/m)	Limit (dBμV/m)	Margin (dB)	Height (cm)	Angle (deg)	Polarity
1.	175.04	34.80	-9.78	25.02	43.50	18.48	100	224	vertical
2.	270.97	35.40	-10.95	24.45	46.00	21.55	100	54	vertical
3.	672.25	31.21	-2.69	28.52	46.00	17.48	100	122	vertical

Remarks: C.F (Correction Factor) = Antenna factor + Cable loss - Preamp gain

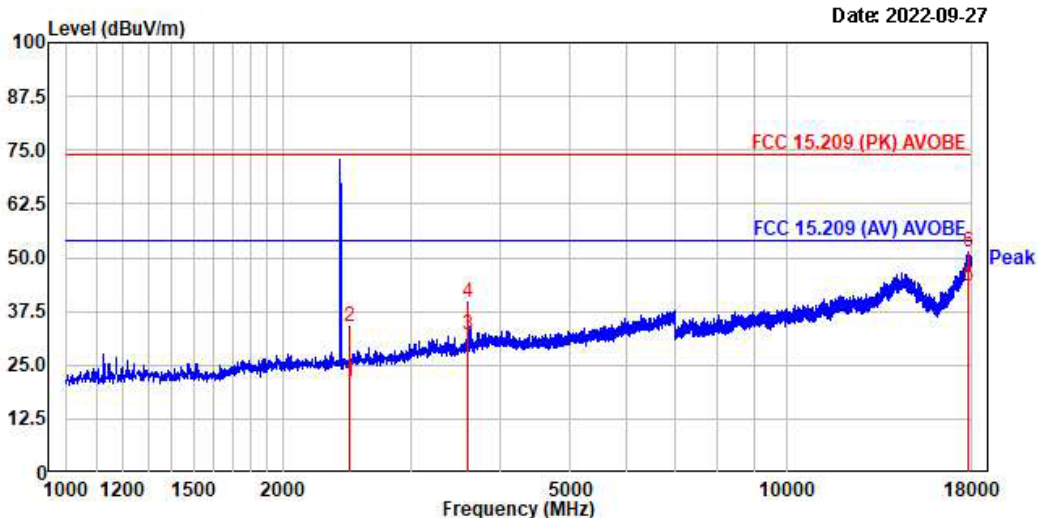

No.	Freq MHz	RD		C.F dB	Result		Limit		Margin		Height cm	Angle deg	Polarity
		PK dBμV	AV dBμV		PK dBμV	AV dBμV	PK dB	AV dB	PK dB	AV dB			
2.	2470.50	37.65	24.60	-3.53	34.12	21.07	74.00	54.00	39.88	32.93	100	75	horizontal
4.	3601.00	38.28	30.61	1.33	39.61	31.94	74.00	54.00	34.39	22.06	100	125	horizontal
6.	17859.75	25.58	17.70	25.75	51.33	43.45	74.00	54.00	22.67	10.55	100	299	horizontal

Remarks: C.F (Correction Factor) = Antenna factor + Cable loss - Preamp gain

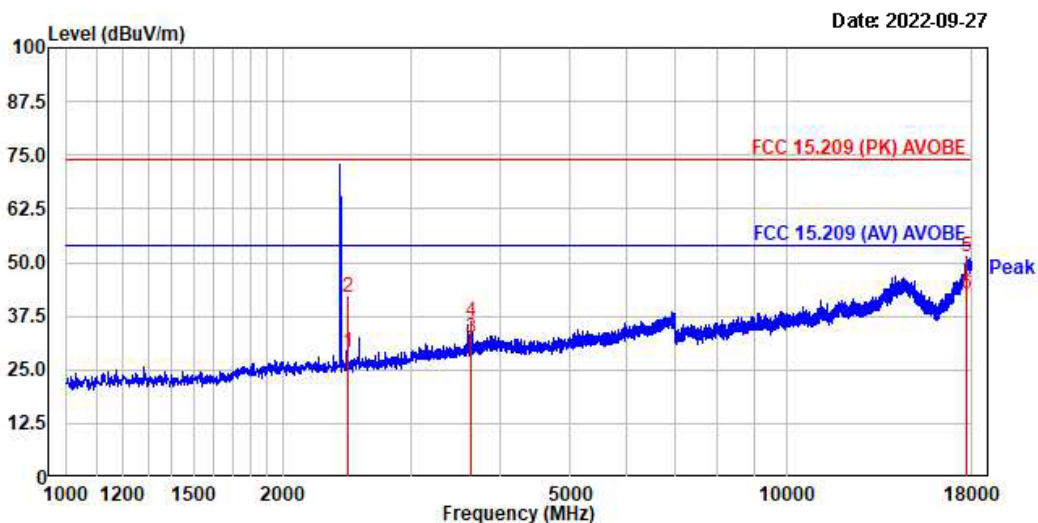

No.	Freq MHz	RD		C.F dB	Result		Limit		Margin		Height cm	Angle deg	Polarity
		PK dBμV	AV dBμV		PK dBμV	AV dBμV	PK dB	AV dB	PK dB	AV dB			
2.	2455.63	45.72	32.59	-3.68	42.04	28.91	74.00	54.00	31.96	25.09	100	0	vertical
4.	3647.75	34.70	30.70	1.60	36.30	32.30	74.00	54.00	37.70	21.70	100	105	vertical
5.	17725.88	26.34	-----	24.86	51.20	-----	74.00	-----	22.80	-----	100	360	vertical
6.	17725.88	-----	17.69	24.86	-----	42.55	-----	54.00	-----	11.45	100	360	vertical

Remarks: C.F (Correction Factor) = Antenna factor + Cable loss - Preamp gain

Date: 2022-09-28

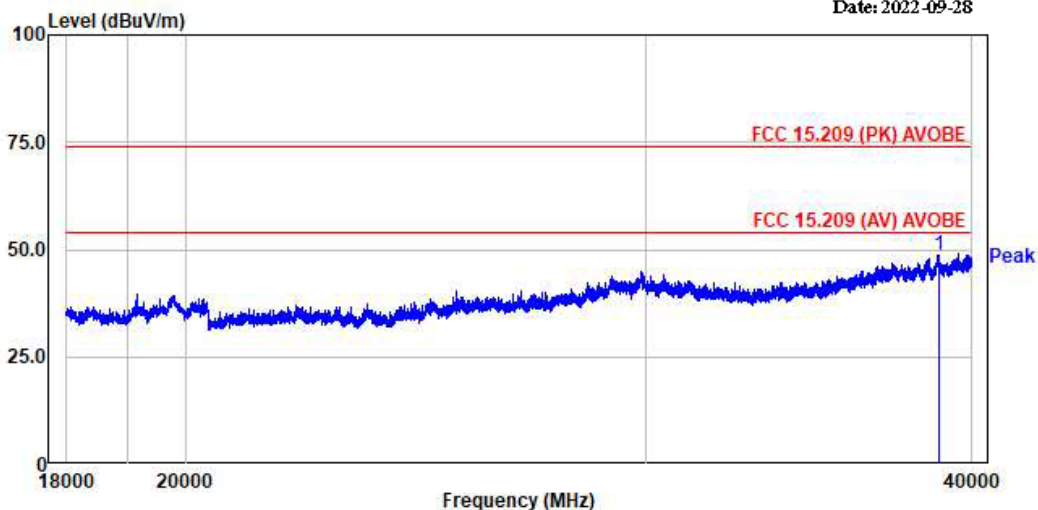

No.	Freq MHz	RD PK dBμV	RD AV dBμV	C.F dB	Result PK dBμV	Result AV dBμV	Limit PK dBμV	Limit AV dBμV	Margin PK dB	Margin AV dB	Height cm	Angle deg	Polarity
1.	38864.25	27.18	---	21.46	48.64	---	74.00	---	25.36	---	2	3	horizontal

Remarks: C.F (Correction Factor) = Antenna factor + Cable loss - Preamp gain

Date: 2022-09-28

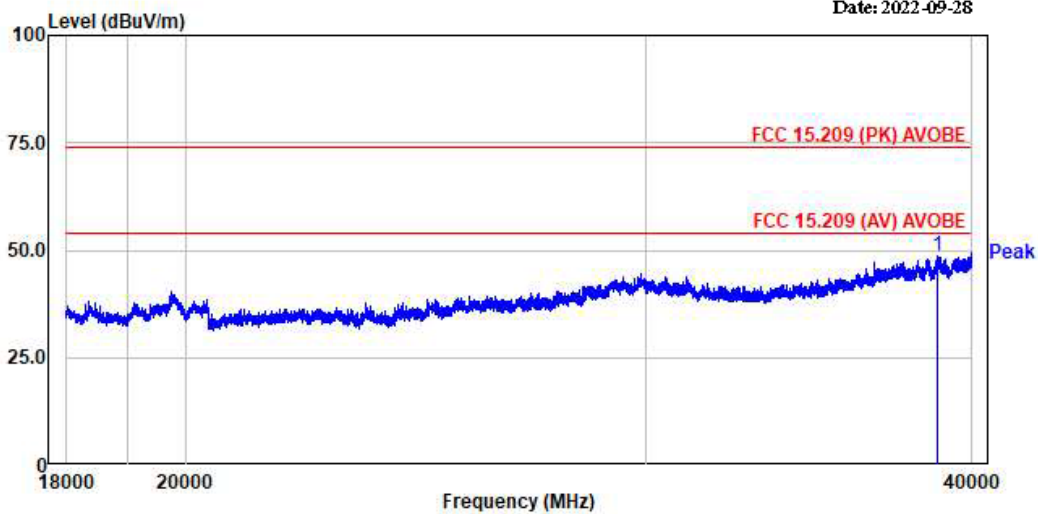

No.	Freq MHz	RD PK dBμV	RD AV dBμV	C.F dB	Result PK dBμV	Result AV dBμV	Limit PK dBμV	Limit AV dBμV	Margin PK dB	Margin AV dB	Height cm	Angle deg	Polarity
1.	38839.50	27.16	---	21.53	48.69	---	74.00	---	25.31	---	358	356	vertical

Remarks: C.F (Correction Factor) = Antenna factor + Cable loss - Preamp gain

3.3.9 AC Conducted Emissions

Procedure:

AC power line conducted emissions from the EUT were measured according to the dictates of ANSI C63.4:2003. The conducted emissions are measured in the shielded room with a spectrum analyzer in peak hold. While the measurement, EUT had its hopping function disabled at the middle channels in line with Section 15.31(m). Emissions closest to the limit are measured in the quasi-peak mode (QP) with the tuned receiver using a bandwidth of 9 kHz. The emissions are maximized further by cable manipulation and Exerciser operation. The highest emissions relative to the limit are listed.

Measurement Data: N/A

Minimum Standard: FCC Part 15.207(a)/EN 55022

Frequency Range	Quasi-Peak	Average
0.15 ~ 0.5	66 to 56 *	56 to 46 *
0.5 ~ 5	56	46
5 ~ 30	60	50

* Note: This product operates only with battery and does not operate during charging.

APPENDIX
TEST EQUIPMENT USED FOR TESTS

	Use	Description	Model No.	Serial No.	Manufacturer	Interval	Next Cal. Date
1	■	Signal Analyzer (9 kHz ~ 30 GHz)	FSV30	100757	R&S	1 year	2023-09-06
2	■	Signal Generator (~3.2 GHz)	8648C	3623A02597	HP	1 year	2023-03-16
3		SYNTHESIZED CW GENERATOR	83711B	US34490456	HP	1 year	2023-03-16
4		Attenuator (3 dB)	8491A	37822	HP	1 year	2023-09-06
5		Attenuator (10 dB)	8491A	63196	HP	1 year	2023-09-06
6	■	EMI Test Receiver (~7 GHz)	ESC17	100722	R&S	1 year	2023-09-06
7	■	RF Amplifier (~1.3 GHz)	8447D OPT 010	2944A07684	HP	1 year	2023-09-06
8	■	RF Amplifier (1~26.5 GHz)	8449B	3008A02126	HP	1 year	2023-03-16
9	■	Horn Antenna (1~18 GHz)	3115	00114105	ETS	2 year	2024-09-10
10	■	DRG Horn (Small)	3116B	81109	ETS-Lindgren	2 year	2024-03-18
11		DRG Horn (Small)	3116B	133350	ETS-Lindgren	2 year	2024-03-18
12	■	TRILOG Antenna	VULB 9160	9160-3237	SCHWARZBECK	2 year	2023-03-20
13		Temp.Humidity Data Logger	SK-L200TH II A	00801	SATO	1 year	2023-03-16
14		Splitter (SMA)	ZFSC-2-2500	SF617800326	Mini-Circuits	-	-
15	■	DC Power Supply	6674A	3637A01657	Agilent	-	-
17	■	Power Meter	EPM-441A	GB32481702	HP	1 year	2023-03-16
18	■	Power Sensor	8481A	3318A94972	HP	1 year	2023-09-06
19		Audio Analyzer	8903B	3729A18901	HP	1 year	2023-09-06
20		Modulation Analyzer	8901B	3749A05878	HP	1 year	2023-09-06
21		TEMP & HUMIDITY Chamber	YJ-500	LTAS06041	JinYoung Tech	1 year	2023-09-06
22		Stop Watch	HS-3	812Q08R	CASIO	2 year	2024-03-18
23		LISN	KNW-407	8-1430-1	Kyoritsu	1 year	2023-03-16
24		Two-Lime V-Network	ESH3-Z5	893045/017	R&S	1 year	2023-03-16
25		UNIVERSAL RADIO COMMUNICATION TESTER	CMU200	106243	R&S	1 year	2023-03-16
26		Highpass Filter	WHKX1.5/15G-10SS	74	Wainwright Instruments	1 year	2023-03-16
27		Highpass Filter	WHKX3.0/18G-10SS	118	Wainwright Instruments	1 year	2023-03-16
28		OSP120 BASE UNIT	OSP120	101230	R&S	1 year	2023-03-16
29		Signal Generator(100 kHz ~ 40 GHz)	SMB100A03	177621	R&S	1 year	2023-03-16
30		Signal Analyzer (10 Hz ~ 40 GHz)	FSV40	101367	R&S	1 year	2023-03-16
31	■	Active Loop Antenna	FMZB 1519	1519-031	SCHWARZBECK	2 year	2023-09-07