

Antenna specification

Customer name: Yawei__

| | | | |
|---------------------------|---|---|--|
| Project name | P56 | Antenna frequency band | BT |
| Specification description | <input type="checkbox"/> support+shell fragment | <input type="checkbox"/> Single shrapnel | <input type="checkbox"/> support+FPC+thimble |
| | <input checked="" type="checkbox"/> FPC | <input type="checkbox"/> FM aerial | <input type="checkbox"/> GPS aerial |
| | silk-screen: S46-1/S46-2 | | |
| | <input type="checkbox"/> coaxial-line | <input type="checkbox"/> WIFI aerial: <input type="checkbox"/> FPC+wire rod: <input type="checkbox"/> PCB+wire rod: | |
| Customer confirmation | | | |

| Supplier confirmation | Radio frequency confirmation | Structural confirmation | check |
|---|------------------------------|-------------------------|---------------|
| contacts | Wang pengchao | mobile phone | 13480925226 |
| telephone | 0755-23705212 | facsimile | 0755-23705213 |
| mailbox | szhuaxunshitong@126.com | | |
| address: F3-005, Hongfenghua Internet Creative Park, No.1 Huangtiandamen Road, Hangcheng Street, Baoan District, Shenzhen | | | |

1. Test environment

| | test project | equipment |
|------------------|-------------------------------|---|
| 1. (S-parameter) | 1. (Return Loss) 2. (VSWR) | : Agilent E5071B HP 8753D |
| 2. (Active) | 1. (TRP) 2. (TIS) | 1. ETS 7x4x3 m (3D) Chamber ETS 5x3x3 m (3D) Chamber 2.: Agilent 8960 E5515B x2 StarPoint SP6011 |
| 3. (Passive) | 1. (Gain) 2. (Efficiency) | 1. ETS 7x4x3 m (3D) Chamber ETS 5x3x3 m (3D) Chamber 2. Agilent E5071B HP 8753D |

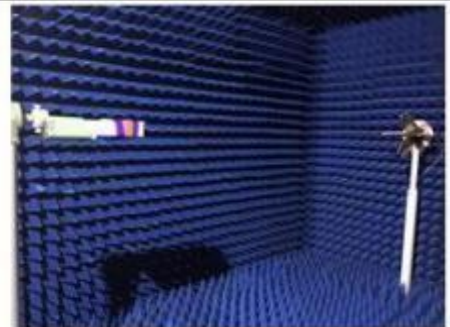

2. matching circuit-BT aerial:

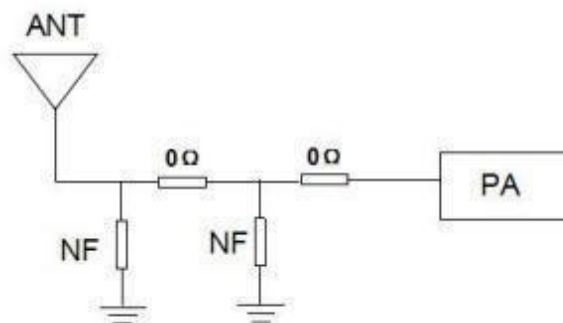

Our company has not made any modification to the matching circuit

3. Antenna position map

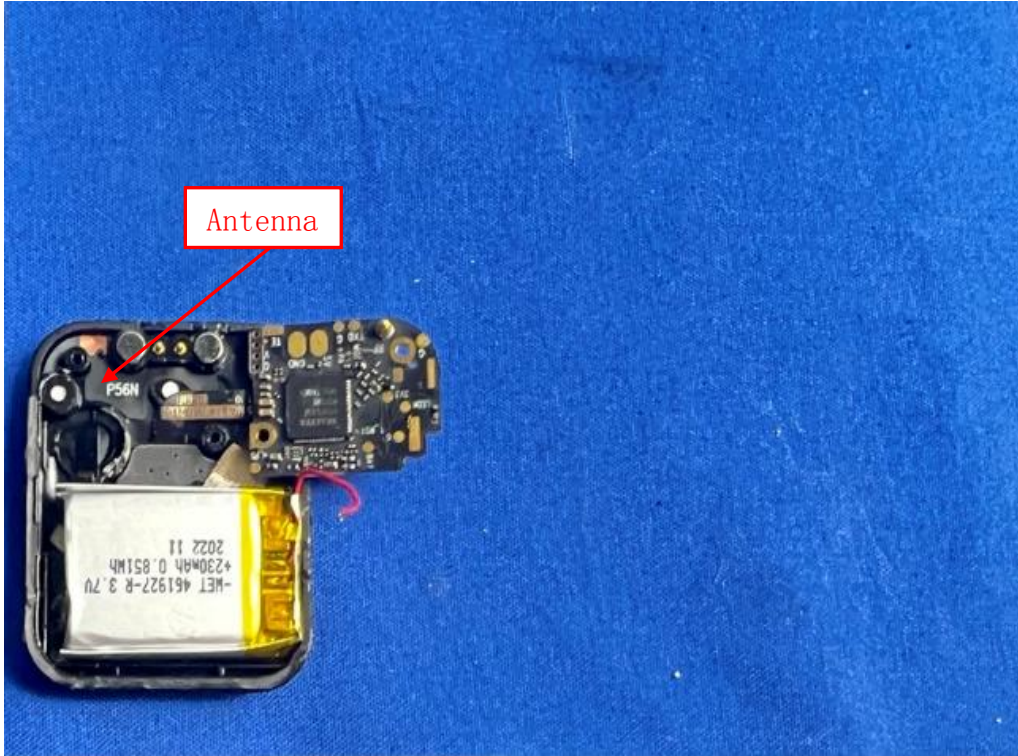

4 Efficiency and gain

| Passive Test For WIFI2.4 | | | | | | | | | | |
|--------------------------|----------|-----------|------------|------------|---------|----------|----------|----------|-------------|-------------|
| Freq (MHz) | Effi (%) | Effi (dB) | Gain (dBi) | Gain (dBd) | UHS (%) | DHIS (%) | Max (dB) | Min (dB) | Attenut Hor | Attenut Ver |
| 2400 | 53.75 | -2.7 | 1.07 | -1.08 | 29.839 | 23.915 | 1.07 | -12.36 | 52.03 | 53.99 |
| 2410 | 52.53 | -2.8 | 1.36 | -0.79 | 29.277 | 23.254 | 1.36 | -12.66 | 51.99 | 53.84 |
| 2420 | 45.27 | -3.44 | 0.93 | -1.22 | 25.085 | 20.183 | 0.93 | -13.88 | 52.04 | 53.98 |
| 2430 | 44.89 | -3.48 | 0.82 | -1.33 | 24.817 | 20.072 | 0.82 | -13.91 | 52.23 | 54.02 |
| 2440 | 56.13 | -2.51 | 1.69 | -0.46 | 31.253 | 24.876 | 1.69 | -12.48 | 52.54 | 54.25 |
| 2450 | 52.48 | -2.8 | 1.3 | -0.85 | 29.203 | 23.28 | 1.3 | -12.62 | 52.64 | 54.11 |
| 2460 | 47.47 | -3.24 | 0.88 | -1.27 | 26.704 | 20.768 | 0.88 | -12.52 | 52.59 | 54.02 |
| 2470 | 49.39 | -3.06 | 1.01 | -1.14 | 27.997 | 21.394 | 1.01 | -12.17 | 52.66 | 54.04 |
| 2480 | 57.15 | -2.43 | 1.68 | -0.47 | 32.513 | 24.636 | 1.68 | -11.84 | 53.06 | 54.43 |
| 2490 | 62.03 | -2.07 | 2.13 | -0.02 | 35.74 | 26.288 | 2.13 | -12.93 | 53.33 | 54.57 |
| 2500 | 51.26 | -2.9 | 1.45 | -0.7 | 29.748 | 21.509 | 1.45 | -13.99 | 53.11 | 54.29 |



2400.00MHz - 2500.00MHz Efficiency

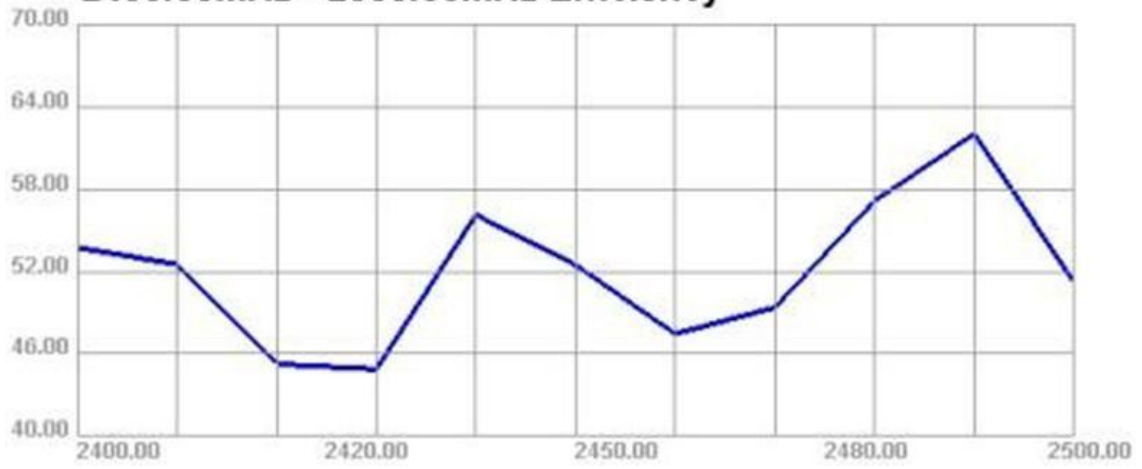

2400.000MHz

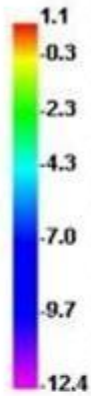
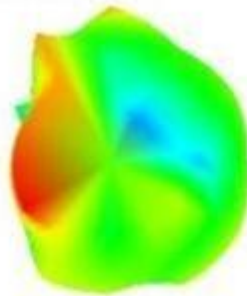

2400.000MHz H

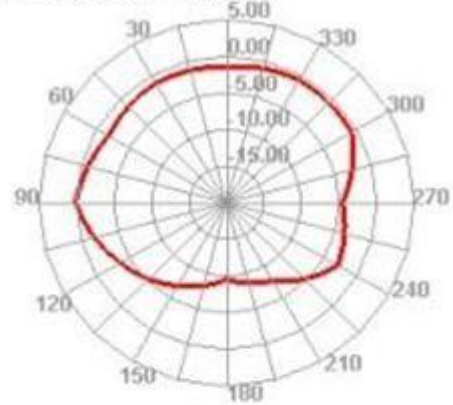

2400.000MHz E1

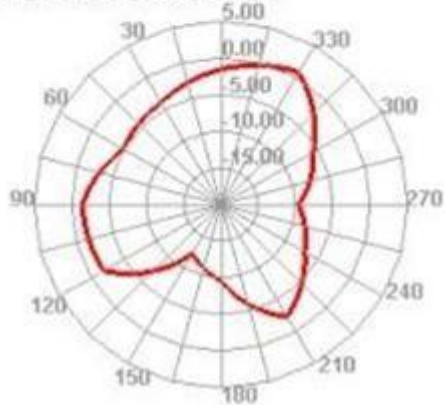

2400.000MHz E2

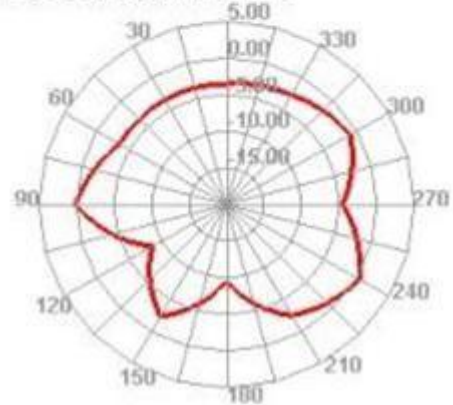

2500.000MHz

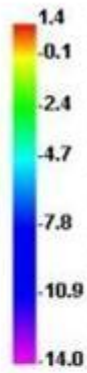
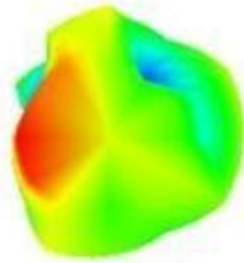

2500.000MHz H

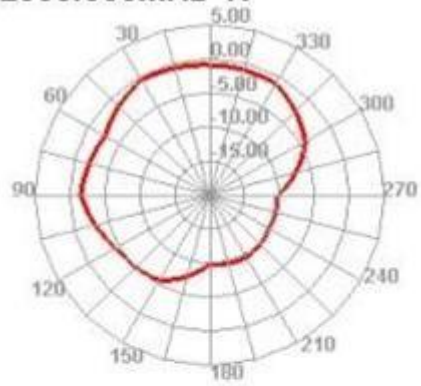

2500.000MHz E1

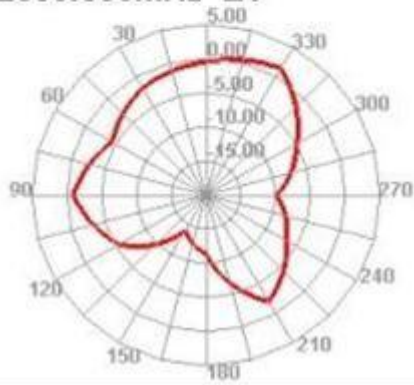

2500.000MHz E2

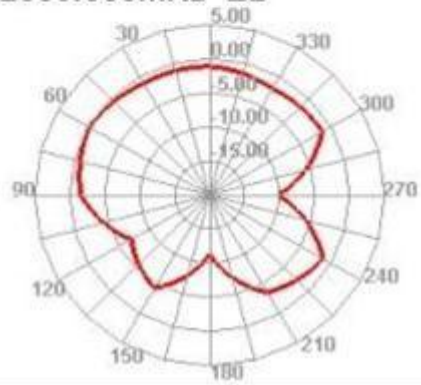

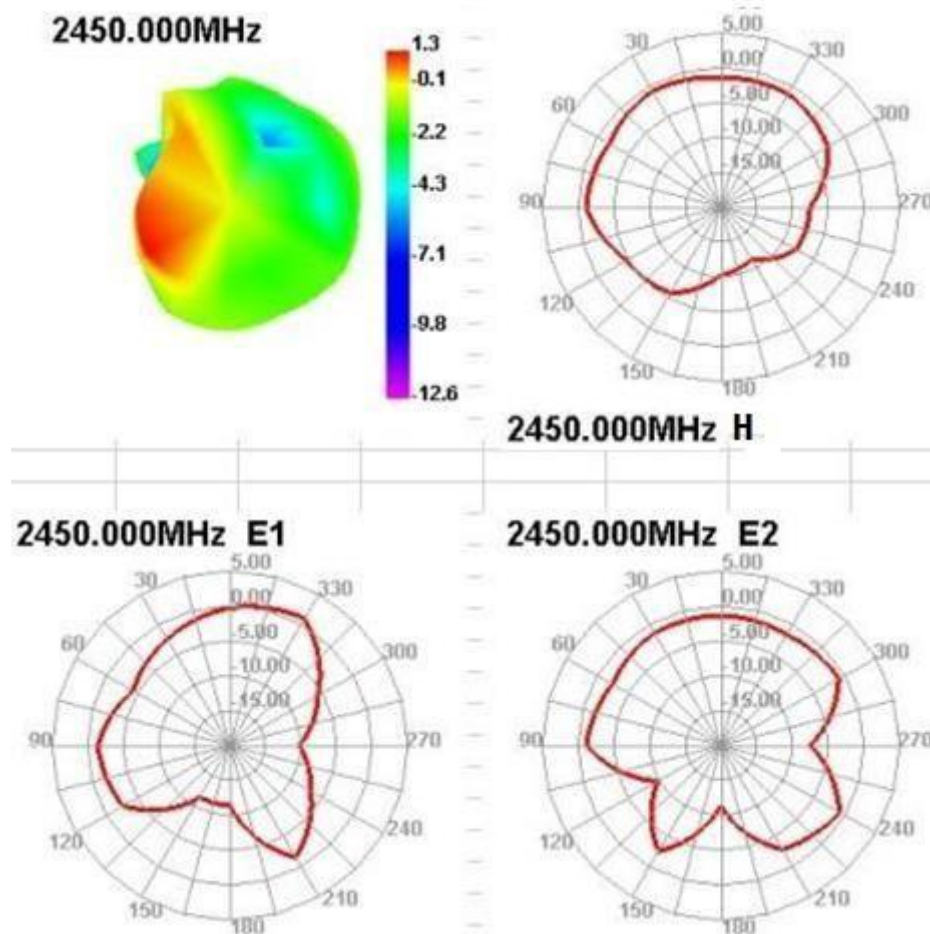

5. BT Measured effect of antenna

Testing environment: Open outdoor

Distance test: the mobile phone is connected with the bracelet and fixed on a bracket with a height of 1.4M, Wear the bracelet correctly and gradually move away from the mobile phone.

Test mobile phone: Android

1 Play music/call without being stuck: More than 18 meters

2 Connect APP to test no dropped calls: More than 18 meters

Test mobile phone: iPhone

1 Play music/call without being stuck: More than 17 meters

2 Connect APP to test no dropped calls: More than 18 meters

6. Structural drawings

