

MEASUREMENT REPORT

FCC PART 15.247 / RSS-247 Bluetooth

FCC ID: 2AOLA-P6BT
IC: 23470-P6BT
Applicant: Escape bv
Application Type: Certification
Product: Portable Indoor/Outdoor Wireless Speaker System
Model No.: Escape P6 BT
Brand Name: ESCAPE
FCC Classification: FCC Part 15 Spread Spectrum Transmitter (DSS)
FCC Rule Part(s): Part 15 Subpart C (Section 15.247)
ISED Rule(s): RSS-247 Issue 2, RSS-GEN Issue 5
Test Procedure(s): ANSI C63.10-2013
Test Date: May 14, 2020 ~ January 10, 2021

Reviewed By:



Kevin Guo

Approved By:

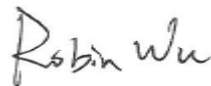

Robin Wu



The test results relate only to the samples tested.

This equipment has been shown to be capable of compliance with the applicable technical standards as indicated in the measurement report and was tested in accordance with the measurement procedures specified in ANSI C63.10-2013. Test results reported herein relate only to the item(s) tested.

The test report shall not be reproduced except in full without the written approval of MRT Technology (Suzhou) Co., Ltd.

Revision History

Report No.	Version	Description	Issue Date	Note
2005RSU006-U1	Rev. 01	Initial Report	02-10-2021	Valid

CONTENTS

Description	Page
1. GENERAL INFORMATION	6
1.1. Applicant.....	6
1.2. Manufacturer	6
1.3. Testing Facility	6
2. PRODUCT INFORMATION	7
2.1. Equipment Description.....	7
2.2. Product Specification Subjective to this Report.....	7
2.3. Operation Frequency / Channel List	8
2.4. Pseudorandom Frequency Hopping Sequence.....	9
2.5. Test Mode	9
2.6. Configuration of Test System.....	10
2.7. Test System Details.....	10
2.8. Test Software	10
2.9. Test Environment Condition	10
2.10. Duty Cycle	11
2.11. EMI Suppression Device(s) / Modifications	11
3. ANTENNA REQUIREMENTS.....	12
4. TEST EQUIPMENT CALIBRATION DATE	13
5. MEASUREMENT UNCERTAINTY.....	17
6. TEST RESULT	18
6.1. Summary	18
6.2. Bandwidth Measurement	19
6.2.1. Test Limit	19
6.2.2. Test Procedure Used	19
6.2.3. Test Setting.....	19
6.2.4. Test Setup.....	20
6.2.5. Test Result.....	21
6.3. Output Power Measurement.....	24
6.3.1. Test Limit	24
6.3.2. Test Procedure Used	24
6.3.3. Test Setting.....	24
6.3.4. Test Setup.....	24
6.3.5. Test Result.....	25
6.4. Carrier Frequency Separation Measurement	28

6.4.1.	Test Limit	28
6.4.2.	Test Procedure Used	28
6.4.3.	Test Setting.....	28
6.4.4.	Test Setup.....	28
6.4.5.	Test Result.....	29
6.5.	Number of Hopping Channels Measurement	32
6.5.1.	Test Limit	32
6.5.2.	Test Procedure Used	32
6.5.3.	Test Setting.....	32
6.5.4.	Test Setup.....	32
6.5.5.	Test Result.....	33
6.6.	Time of Occupancy Measurement	35
6.6.1.	Test Limit	35
6.6.2.	Test Procedure Used	35
6.6.3.	Test Setting.....	35
6.6.4.	Test Setup.....	35
6.6.5.	Test Result.....	36
6.7.	Band-edge Compliance Measurement.....	38
6.7.1.	Test Limit	38
6.7.2.	Test Procedure Used	38
6.7.3.	Test Setting.....	38
6.7.4.	Test Setup.....	39
6.7.5.	Test Result.....	40
6.8.	Conducted Spurious Emissions Measurement.....	43
6.8.1.	Test Limit	43
6.8.2.	Test Procedure Used	43
6.8.3.	Test Setting.....	43
6.8.4.	Test Setup.....	44
6.8.5.	Test Result.....	45
6.9.	Radiated Spurious Emission Measurement	49
6.9.1.	Test Limit	49
6.9.2.	Test Procedure Used	49
6.9.3.	Test Setting.....	50
6.9.4.	Test Setup.....	51
6.9.5.	Test Result.....	53
6.10.	Radiated Restricted Band Edge Measurement	64
6.10.1.	Test Limit	64
6.10.2.	Test Procedure Used	67
6.10.3.	Test Setting.....	67

6.10.4.	Test Setup.....	68
6.10.5.	Test Result.....	69
6.11.	AC Conducted Emissions Measurement.....	93
6.11.1.	Test Limit	93
6.11.2.	Test Setup.....	93
6.11.3.	Test Result.....	94
7.	CONCLUSION.....	96
	Appendix A - Test Setup Photograph	97
	Appendix B - EUT Photograph.....	98

2. PRODUCT INFORMATION

2.1. Equipment Description

Product Name (PMN)	Portable Indoor/Outdoor Wireless Speaker System
Model No. (HVIN)	Escape P6 BT
Brand Name	ESCAPE
Bluetooth Version	V5.0 (Single mode for BR/EDR)
Operating Temperature	0 ~ 60°C
Product Voltage	AC100-120/220-240V ~ 50/60Hz; 100W
Test Device Serial Number	P6 BT 2004P0202F8C

2.2. Product Specification Subjective to this Report

Operating Frequency	2402~2480MHz
Channel Number	79
Type of modulation	GFSK, Pi/4 DQPSK, 8DPSK
Data Rate	1Mbps (GFSK), 2Mbps (Pi/4 DQPSK), 3Mbps (8DPSK)
Antenna Type	PCB Antenna
Antenna Gain	2dBi

Note: Above antenna information is provided by applicant.

The equipment under test (EUT) is the Portable Indoor/Outdoor Wireless Speaker System. The test data contained in this report pertains only to the emissions due to the EUT's Bluetooth transmitter.

- 15.247(g): In accordance with the Bluetooth Industry Standard, the system is designed to comply with all of the regulations in Section 15.247 when the transmitter is presented with a continuous data (or information) system.
- 15.247(h): In accordance with the Bluetooth Industry Standard, the system does not coordinate its channels selection/ hopping sequence with other frequency hopping systems for the express purpose of avoiding the simultaneous occupancy of individual hopping frequencies by multiple transmitters.
- 15.247(h): The EUT employs Adaptive Frequency Hopping (AFH) which identifies sources of interference namely devices operating in 802.11 WLAN and excludes them from the list of available channels. The process of re-mapping reduces the number of test channels from 79 channels to a minimum number of 20 channels.

2.3. Operation Frequency / Channel List

Channel	Frequency	Channel	Frequency	Channel	Frequency
00	2402 MHz	01	2403 MHz	02	2404 MHz
03	2405 MHz	04	2406 MHz	05	2407 MHz
06	2408 MHz	07	2409 MHz	08	2410 MHz
09	2411 MHz	10	2412 MHz	11	2413 MHz
12	2414 MHz	13	2415 MHz	14	2416 MHz
15	2417 MHz	16	2418 MHz	17	2419 MHz
18	2420 MHz	19	2421 MHz	20	2422 MHz
21	2423 MHz	22	2424 MHz	23	2425 MHz
24	2426 MHz	25	2427 MHz	26	2428 MHz
27	2429 MHz	28	2430 MHz	29	2431 MHz
30	2432 MHz	31	2433 MHz	32	2434 MHz
33	2435 MHz	34	2436 MHz	35	2437 MHz
36	2438 MHz	37	2439 MHz	38	2440 MHz
39	2441 MHz	40	2442 MHz	41	2443 MHz
42	2444 MHz	43	2445 MHz	44	2446 MHz
45	2447 MHz	46	2448 MHz	47	2449 MHz
48	2450 MHz	49	2451 MHz	50	2452 MHz
51	2453 MHz	52	2454 MHz	53	2455 MHz
54	2456 MHz	55	2457 MHz	56	2458 MHz
57	2459 MHz	58	2460 MHz	59	2461 MHz
60	2462 MHz	61	2463 MHz	62	2464 MHz
63	2465 MHz	64	2466 MHz	65	2467 MHz
66	2468 MHz	67	2469 MHz	68	2470 MHz
69	2471 MHz	70	2472 MHz	71	2473 MHz
72	2474 MHz	73	2475 MHz	74	2476 MHz
75	2477 MHz	76	2478 MHz	77	2479 MHz
78	2480 MHz	--	--	--	--

2.4. Pseudorandom Frequency Hopping Sequence

The pseudorandom sequence may be generated in a nine-stage shift register whose 5th and 9th stage outputs are added in a modulo-two addition stage. And the result is fed back to the input of the first stage. The sequence begins with the first ONE of 9 consecutive ONES; i.e. the shift register is initialized with nine ones.

- Number of shift register stages: 9
- Length of pseudo-random sequence: $2^9 - 1 = 511$ bits
- Longest sequence of zeros: 8 (non-inverted signal)

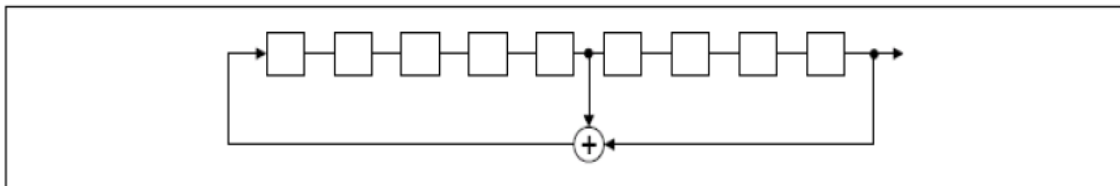

Linear Feedback Shift Register for Generation of the PRBS sequence

An example of Pseudorandom Frequency Hopping Sequence as follow:

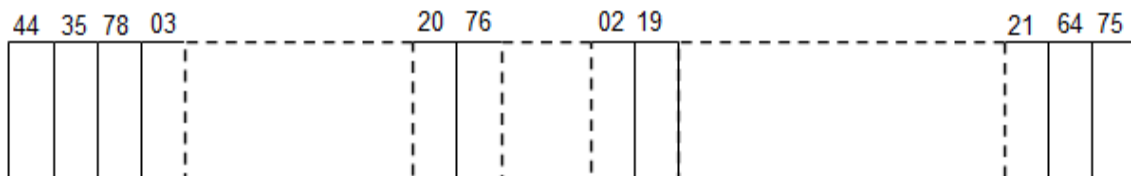

Each frequency used equally on the average by each transmitter.

The system receivers have input bandwidths that match the hopping channel bandwidths of their Corresponding transmitters and shift frequencies in synchronization with the transmitted signals.

2.5. Test Mode

Test Mode	Mode 1: Transmit by DH5
	Mode 2: Transmit by 2DH5
	Mode 3: Transmit by 3DH5
	Mode 4: Hopping Mode

2.6. Configuration of Test System

The device was tested per the guidance ANSI C63.10: 2013 was used to reference the appropriate EUT setup for radiated emissions testing and AC line conducted testing.

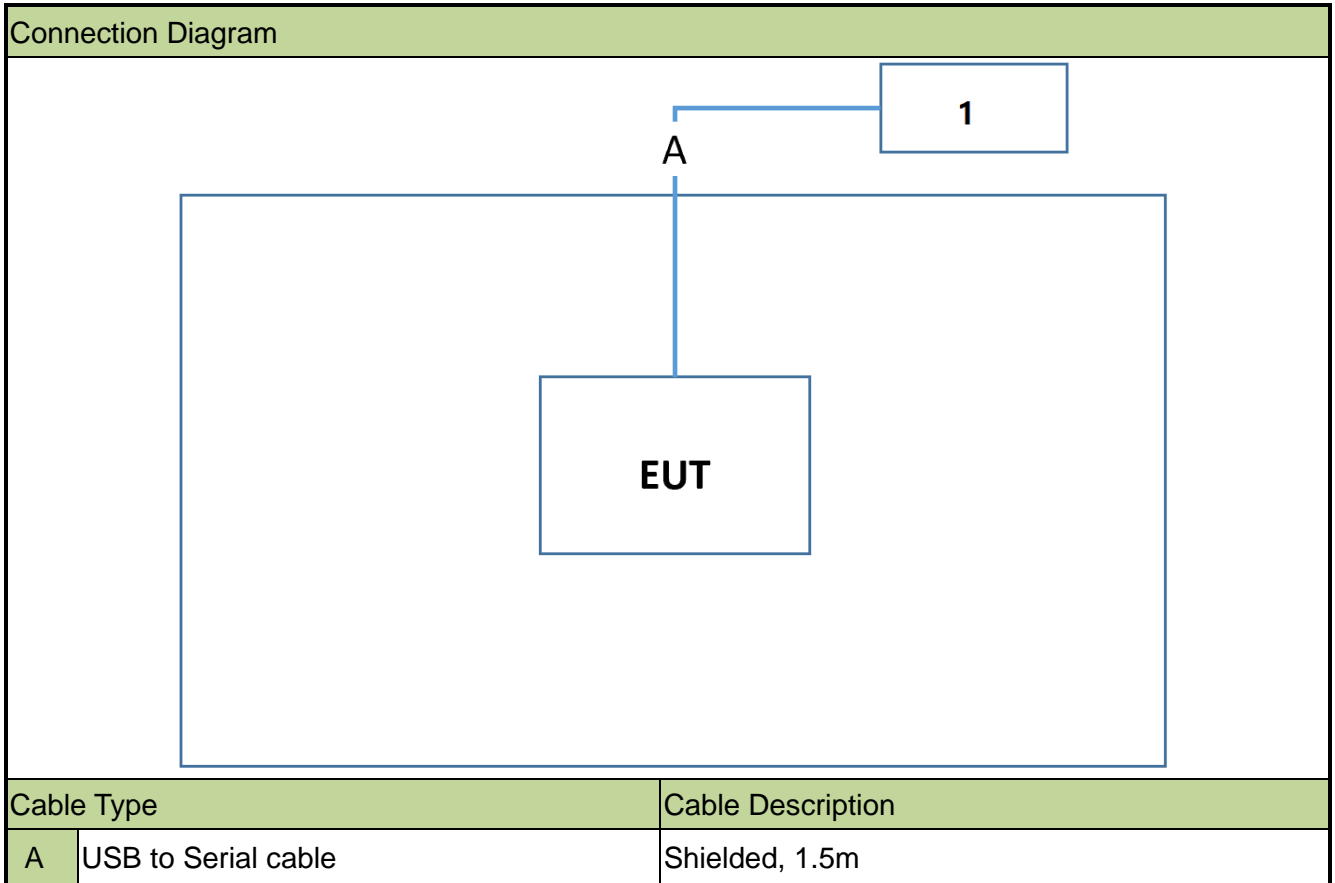

2.7. Test System Details

The types for all equipments, plus descriptions of all cables used in the tested system (including inserted cards) are:

Product	Manufacturer	Model No.
1 Notebook	DELL	Vostro 3300

2.8. Test Software

The test utility software used during testing was “BlueTest3”, and the version was “V2.6.9”.

2.9. Test Environment Condition

Ambient Temperature	15°C ~ 35°C
Relative Humidity	20%RH ~75%RH

2.10. Duty Cycle

The maximum achievable duty cycle was determined based on measurements performed on a spectrum analyzer in zero-span mode with RBW = 8MHz, VBW = 50MHz. The RBW and VBW were both greater than 50/T, where T is the minimum transmission duration, and the number of sweep points across T was greater than 100. The duty cycles are as follows:

Test Mode	Duty Cycle
DH5	76.80%
2DH5	77.07%
3DH5	77.11%

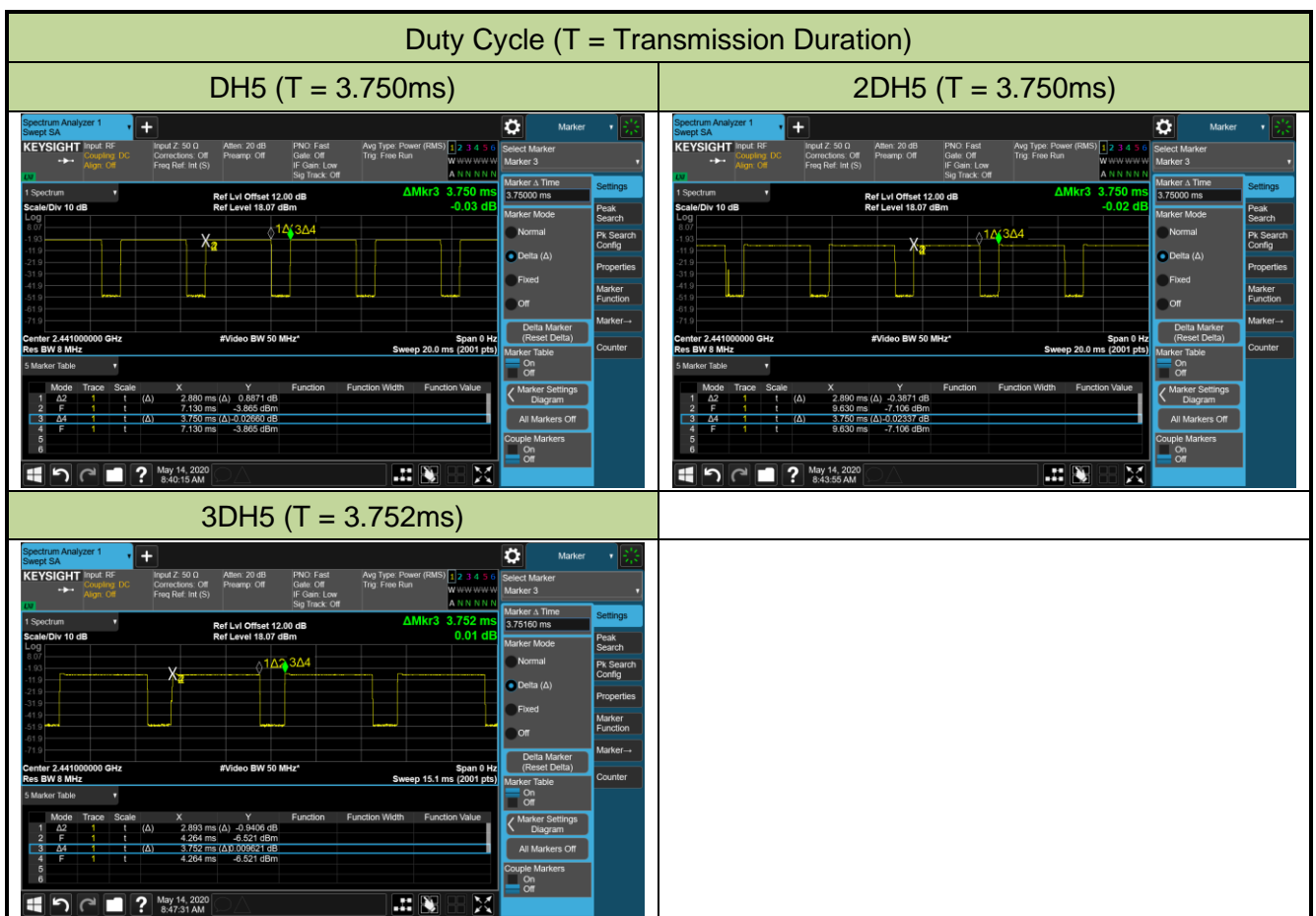

2.11. EMI Suppression Device(s) / Modifications

No EMI suppression device(s) were added and/or no modifications were made during testing.

3. ANTENNA REQUIREMENTS

Excerpt from §15.203 of the FCC Rules/Regulations:

“An intentional radiator antenna shall be designed to ensure that no antenna other than that furnished by the responsible party can be used with the device. The use of a permanently attached antenna or of an antenna that uses a unique coupling to the intentional radiator shall be considered sufficient to comply with the provisions of this section.”

- The antenna of the **device** is **permanently attached**.
- There are no provisions for connection to an external antenna.

Conclusion:

The unit complies with the requirement of §15.203.

4. TEST EQUIPMENT CALIBRATION DATE

Conducted Emission (WZ-SR2)

Instrument	Manufacturer	Type No.	Asset No.	Cali. Interval	Cali. Due Date
EMI Test Receiver	R&S	ESR3	MRTSUE06185	1 year	2022/01/12
Two-Line V-Network	R&S	ENV216	MRTSUE06002	1 year	2021/09/09
Thermal Hygrometer	testo	608-H1	MRTSUE06404	1 year	2021/07/26
Shielding Room	MIX-BEP	Chamber-SR2	MRTSUE06215	N/A	N/A

Conducted Emission (SIP-SR2)

Instrument	Manufacturer	Type No.	Asset No.	Cali. Interval	Cali. Due Date
EMI Test Receiver	R&S	ESR3	MRTSUE06613	1 year	2021/07/02
Two-Line V-Network	R&S	ENV216	MRTSUE06003	1 year	2021/09/09
Thermal Hygrometer	testo	608-H1	MRTSUE06621	1 year	2021/12/03

Radiated Emission (WZ-AC1)

Instrument	Manufacturer	Type No.	Asset No.	Cali. Interval	Cali. Due Date
EMI Test Receiver	R&S	ESR7	MRTSUE06001	1 year	2022/01/04
PXA Signal Analyzer	Keysight	N9030B	MRTSUE06395	1 year	2021/08/30
Loop Antenna	Schwarzbeck	FMZB 1519	MRTSUE06025	1 year	2021/11/08
Bilog Period Antenna	Schwarzbeck	VULB 9168	MRTSUE06172	1 year	2021/08/08
Horn Antenna	Schwarzbeck	BBHA 9120D	MRTSUE06023	1 year	2021/09/27
Horn Antenna	Schwarzbeck	BBHA9170	MRTSUE06597	1 year	2021/12/14
Microwave System Amplifier	Agilent	83017A	MRTSUE06076	1 year	2021/11/14
Preamplifier	Schwarzbeck	BBV 9721	MRTSUE06121	1 year	2021/06/11
Thermal Hygrometer	testo	608-H1	MRTSUE06403	1 year	2021/07/26
Anechoic Chamber	TDK	Chamber-AC1	MRTSUE06212	1 year	2021/04/30

Radiated Emission (WZ-AC2)

Instrument	Manufacturer	Type No.	Asset No.	Cali. Interval	Cali. Due Date
MXE EMI Receiver	Keysight	N9038A	MRTSUE06125	1 year	2021/07/02
Loop Antenna	Schwarzbeck	FMZB 1519	MRTSUE06025	1 year	2021/11/08
Bilog Period Antenna	Schwarzbeck	VULB 9162	MRTSUE06022	1 year	2021/05/26
Broad-Band Horn Antenna	Schwarzbeck	BBHA 9120D	MRTSUE06171	1 year	2021/10/25
Horn Antenna	Schwarzbeck	BBHA9170	MRTSUE06597	1 year	2021/12/14
Broadband Coaxial Preamplifier	Schwarzbeck	BBV 9718	MRTSUE06176	1 year	2021/11/14
Preamplifier	Schwarzbeck	BBV 9721	MRTSUE06121	1 year	2021/06/11
Thermal Hygrometer	Minggao	ETH529	MRTSUE06170	1 year	2021/12/08
Anechoic Chamber	RIKEN	Chamber-AC2	MRTSUE06213	1 year	2021/04/30

Radiated Emission (SIP-AC1)

Instrument	Manufacturer	Type No.	Asset No.	Cali. Interval	Cali. Due Date
EMI Test Receiver	R&S	ESR3	MRTSUE06612	1 year	2021/07/02
EXA Signal Analyzer	Keysight	N9010B	MRTSUE06559	1 year	2021/07/23
Loop Antenna	Schwarzbeck	FMZB 1519	MRTSUE06025	1 year	2021/11/08
Bilog Period Antenna	Schwarzbeck	VULB9168	MRTSUE06645	1 year	2021/08/30
Double Ridged Horn Antenna	R&S	HF907	MRTSUE06610	1 year	2021/08/30
Preamplifier	EMCI	EMC051845SE	MRTSUE06600	1 year	2021/11/12
Thermal Hygrometer	testo	608-H1	MRTSUE06620	1 year	2021/12/03
Anechoic Chamber	RIKEN	SIP-AC1	MRTSUE06554	1 year	2021/12/24

Radiated Emission (SIP-AC2)

Instrument	Manufacturer	Type No.	Asset No.	Cali. Interval	Cali. Due Date
EMI Test Receiver	R&S	ESR3	MRTSUE06613	1 year	2021/07/02
MXA Signal Analyzer	Keysight	N9020B	MRTSUE06604	1 year	2021/09/26
Loop Antenna	Schwarzbeck	FMZB 1519	MRTSUE06025	1 year	2021/11/08
Bilog Period Antenna	Schwarzbeck	VULB9168	MRTSUE06646	1 year	2021/08/30
Horn Antenna	Schwarzbeck	BBHA9120D	MRTSUE06648	1 year	2021/11/26
Horn Antenna	Schwarzbeck	BBHA9170	MRTSUE06599	1 year	2021/11/26
Preamplifier	EMCI	EMC051845SE	MRTSUE06644	1 year	2021/11/12
Preamplifier	EMCI	EMC184045SE	MRTSUE06602	1 year	2021/10/13
Thermal Hygrometer	testo	608-H1	MRTSUE06624	1 year	2021/12/03
Anechoic Chamber	RIKEN	SIP-AC2	MRTSUE06781	1 year	2021/12/24

Radiated Emission (SIP-AC3)

Instrument	Manufacturer	Type No.	Asset No.	Cali. Interval	Cali. Due Date
EMI Test Receiver	R&S	ESR3	MRTSUE06612	1 year	2021/07/02
EXA Signal Analyzer	Keysight	N9010B	MRTSUE06559	1 year	2021/07/23
Loop Antenna	Schwarzbeck	FMZB 1519	MRTSUE06025	1 year	2021/11/08
Bilog Period Antenna	Schwarzbeck	VULB9168	MRTSUE06647	1 year	2021/08/08
Double Ridged Horn Antenna	R&S	HF907	MRTSUE06611	1 year	2021/09/13
Horn Antenna	Schwarzbeck	BBHA9170	MRTSUE06598	1 year	2021/11/26
Preamplifier	EMCI	EMC012645SE	MRTSUE06642	1 year	2022/01/14
Preamplifier	EMCI	EMC184045SE	MRTSUE06641	1 year	2022/01/14
Thermal Hygrometer	testo	608-H1	MRTSUE06622	1 year	2021/12/03
Anechoic Chamber	RIKEN	SIP-AC3	MRTSUE06782	1 year	2021/12/24

Conducted Test Equipment (WZ-TR3)

Instrument	Manufacturer	Type No.	Asset No.	Cali. Interval	Cali. Due Date
EXA Signal Analyzer	Agilent	N9020A	MRTSUE06106	1 year	2021/04/14
EXA Signal Analyzer	Keysight	N9010B	MRTSUE06607	1 year	2022/01/07
Signal Analyzer	R&S	FSV40	MRTSUE06218	1 year	2021/04/14
Power Meter	Agilent	U2021XA	MRTSUE06030	1 year	2021/10/22
USB wideband power sensor	Keysight	U2021XA	MRTSUE06446	1 year	2021/08/30
USB wideband power sensor	Keysight	U2021XA	MRTSUE06447	1 year	2021/08/08
Bluetooth Test Set	Anritsu	MT8852B-042	MRTSUE06389	1 year	2021/06/11
Audio Analyzer	Agilent	U8903B	MRTSUE06143	1 year	2021/06/11
Modulation Analyzer	HP	HP8901A	MRTSUE06098	1 year	2021/09/26
Wideband Radio Communication Tester	R&S	CMW 500	MRTSUE06243	1 year	2021/10/20
Attenuator	MVE	3dB	MRTSUE06529	1 year	2021/12/12
Attenuator	MVE	6dB	MRTSUE06534	1 year	2021/12/12
Attenuator	MVE	10dB	MRTSUE06540	1 year	2021/12/12
Attenuator	MVE	20dB	MRTSUE06547	1 year	2021/12/12
DC Power Supply	GWINSTEK	DPS-3303C	MRTSUE06064	N/A	N/A
Temperature & Humidity Chamber	BAOYT	BYH-150CL	MRTSUE06051	1 year	2021/10/22
Thermal Hygrometer	testo	608-H1	MRTSUE06401	1 year	2021/07/26

Conducted Test Equipment (SIP-SR5)

Instrument	Manufacturer	Type No.	Asset No.	Cali. Interval	Cali. Due Date
Signal Analyzer	R&S	FSV40	MRTSUE06218	1 year	2021/04/14
PXA Signal Analyzer	Keysight	N9030B	MRTSUE06395	1 year	2021/08/30
USB wideband power sensor	Agilent	U2021XA	MRTSUE06595	1 year	2021/09/26
USB wideband power sensor	Agilent	U2021XA	MRTSUE06596	1 year	2021/09/26
Wideband Radio Communication Tester	R&S	CMW 500	MRTSUE06243	1 year	2021/10/20
Bluetooth Test Set	Anritsu	MT8852B-042	MRTSUE06389	1 year	2021/06/11
Attenuator	MVE	3dB	MRTSUE06530	1 year	2021/12/12
Attenuator	MVE	6dB	MRTSUE06535	1 year	2021/12/12
Attenuator	MVE	10dB	MRTSUE06541	1 year	2021/12/12
Attenuator	MVE	20dB	MRTSUE06548	1 year	2021/12/12
Temperature Chamber	BAOYT	BYG-408CS	MRTSUE06847	1 year	2022/02/23
Thermal Hygrometer	testo	622	MRTSUE06629	1 year	2021/11/25

Software	Version	Function
EMI Software	V3	EMI Test Software

5. MEASUREMENT UNCERTAINTY

Where relevant, the following test uncertainty levels have been estimated for tests performed on the EUT as specified in CISPR 16-4-2. This uncertainty represents an expanded uncertainty expressed at approximately the 95% confidence level using a coverage factor of $k = 2$.

Conducted Emission Measurement
The maximum measurement uncertainty is evaluated as: 9kHz~150kHz: 3.74dB 150kHz~30MHz: 3.44dB
Radiated Emission Measurement
The maximum measurement uncertainty is evaluated as: Horizontal: 30MHz~300MHz: 5.04dB 300MHz~1GHz: 4.95dB 1GHz~40GHz: 6.40dB Vertical: 30MHz~300MHz: 5.24dB 300MHz~1GHz: 6.03dB 1GHz~40GHz: 6.40dB
Spurious Emissions, Conducted
Measuring Uncertainty for a Level of Confidence of 95% ($U=2Uc(y)$): 0.78dB
Output Power
Measuring Uncertainty for a Level of Confidence of 95% ($U=2Uc(y)$): 1.13dB
Occupied Bandwidth
Measuring Uncertainty for a Level of Confidence of 95% ($U=2Uc(y)$): 0.28%

6. TEST RESULT

6.1. Summary

FCC Part Section(s)	ISED Section(s)	Test Description	Test Limit	Test Condition	Test Result	Reference
15.247(a)(1)	RSS-247 [5.1]	20dB Bandwidth	N/A	Conducted	Pass	Section 6.2
N/A	RSS-Gen [6.7]	99% Bandwidth	N/A		Pass	
15.247(b)(1)	RSS-247 [5.4(b)]	Peak Transmitter Output Power	<1 Watt if > 75 non- overlapping channels used. EIRP ≤ 4Watt		Pass	Section 6.3
15.247(a)(1)	RSS-247 [5.1]	Channel Separation	> 2/3 of 20 dB BW for systems with Output Power < 125mW		Pass	Section 6.4
15.247(a)(1) (iii)	RSS-247 [5.1]	Number of Channels	> 15 Channels		Pass	Section 6.5
15.247(a)(1) (iii)	RSS-247 [5.1]	Time of Occupancy	< 0.4 sec in 31.6 sec period		Pass	Section 6.6
15.247(d)	RSS-247 [5.5]	Band Edge / out-of-Band Emissions	≥ 20dBc (Peak)		Pass	Section 6.7 Section 6.8
15.205, 15.209	RSS-247 [5.5]	General Field Strength Limits (Restricted Bands and Radiated Emission Limits)	Emissions in restricted bands must meet the radiated limits detailed in 15.209	Radiated	Pass	Section 6.9 Section 6.10
15.207	RSS-Gen [8.8]	AC Conducted Emissions 150kHz - 30MHz	< FCC 15.207 limits	Line Conducted	Pass	Section 6.11

Notes:

- 1) The analyzer plots shown in this section were all taken with a correction table loaded into the analyzer. The correction table was used to account for the losses of the cables and attenuators used as part of the system to connect the EUT to the analyzer at all frequencies of interest.
- 2) "N/A" means that the test item is not applicable, and the details refer to relevant section.

6.2. Bandwidth Measurement

6.2.1. Test Limit

N/A

6.2.2. Test Procedure Used

ANSI C63.10-2013 - Section 6.9.2 (20dB Bandwidth)

ANSI C63.10-2013 - Section 6.9.3 (99% Bandwidth)

6.2.3. Test Setting

For 20dB Bandwidth

1. Set RBW \geq 1% to 5% of the 20dB bandwidth.
2. VBW = Approximately three times RBW
3. Span = Approximately 2 to 5 times the 20dB bandwidth, centered on a hopping channel
4. Detector = Peak
5. Trace mode = Max hold
6. Sweep = Auto couple
7. Allow the trace to stabilize.
8. Measure the maximum width of the emission that is constrained by the frequencies associated with the two outermost amplitude points (upper and lower frequencies) that are attenuated by 20 dB relative to the maximum level measured in the fundamental emission.

For 99% bandwidth

1. Span = 1.5 times to 5 times the OBW
2. Set RBW = 1% to 5% the OBW
3. VBW \geq 3 \times RBW
4. Detector = Peak
5. Trace mode = Max hold
6. Sweep = Auto couple
7. Allow the trace to stabilize.

6.2.4. Test Setup

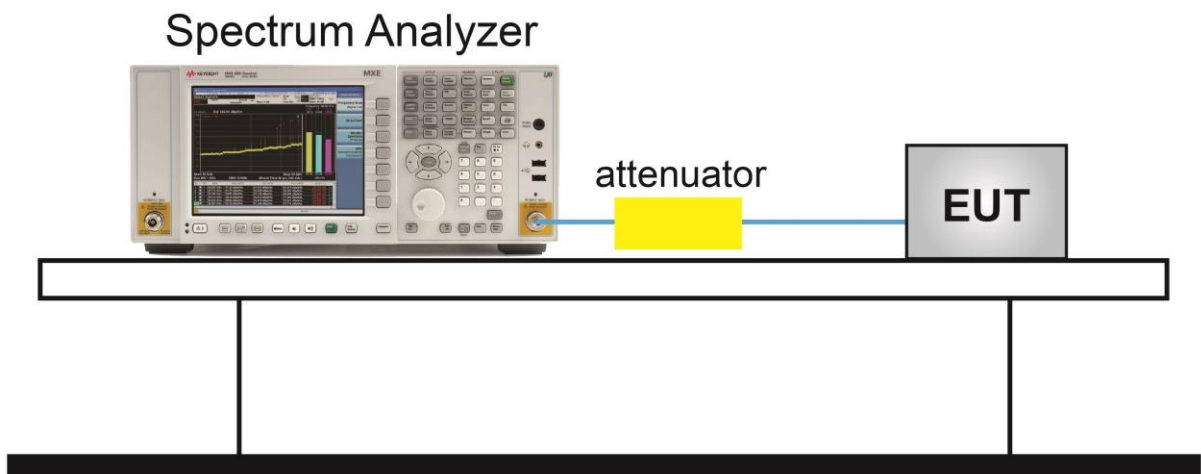

6.2.5. Test Result

Test Site	WZ-TR3	Test Engineer	Dandy Li
Test Date	2020/05/14		

Test Mode	Channel No.	Frequency (MHz)	20dB Bandwidth (kHz)	99% Bandwidth (kHz)
DH5	00	2402	922.8	851.2
DH5	39	2441	921.8	865.0
DH5	78	2480	922.8	859.7
2DH5	00	2402	1270.0	1167.3
2DH5	39	2441	1309.0	1174.6
2DH5	78	2480	1305.0	1166.4
3DH5	00	2402	1262.0	1167.6
3DH5	39	2441	1265.0	1173.1
3DH5	78	2480	1260.0	1167.1

DH5 20dB Bandwidth

Channel 00 (2402MHz)



Channel 39 (2441MHz)



Channel 78 (2480MHz)



2DH5 20dB Bandwidth

Channel 00 (2402MHz)



Channel 39 (2441MHz)



Channel 78 (2480MHz)



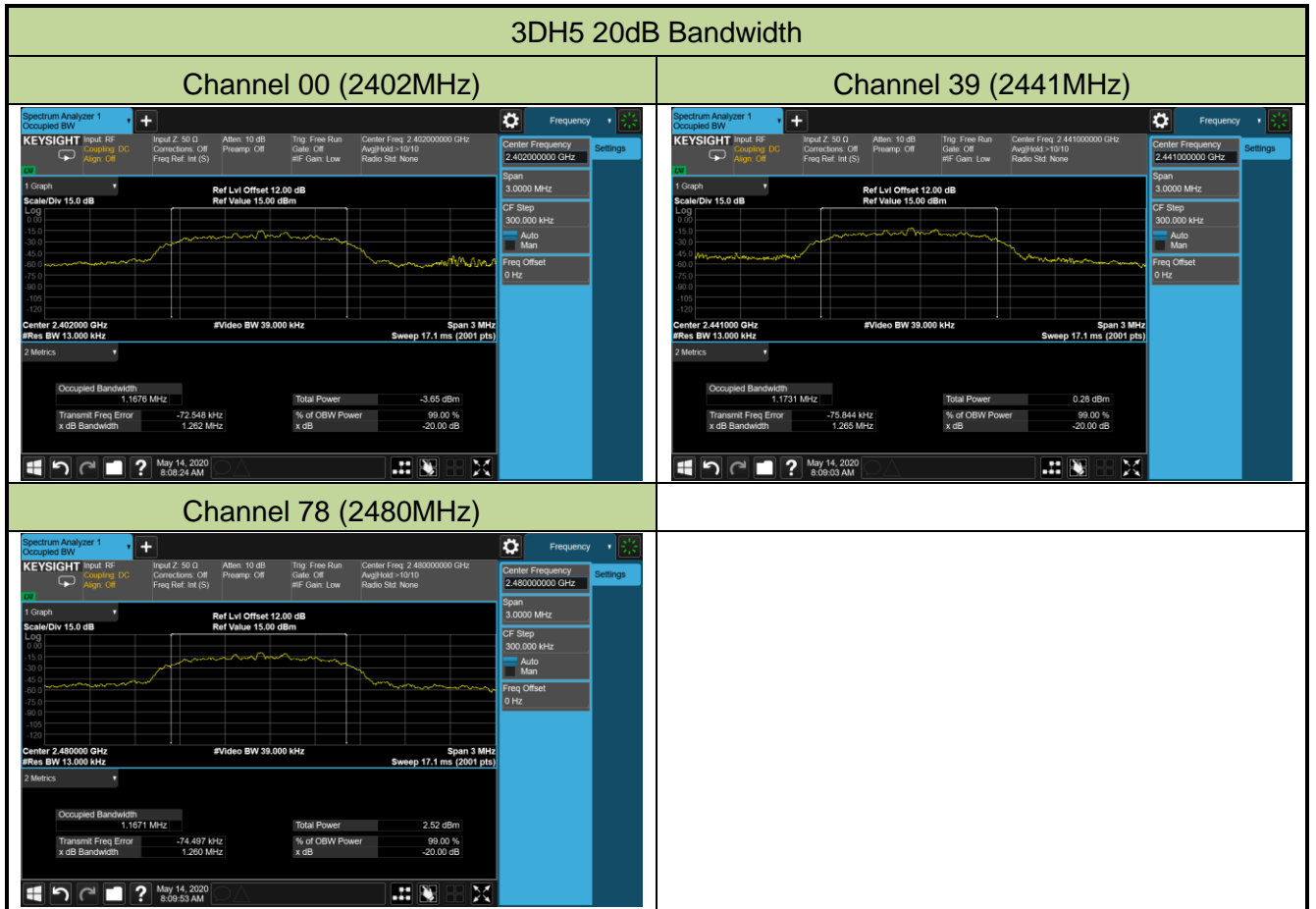

6.3. Output Power Measurement

6.3.1. Test Limit

The maximum out power permissible output power is 1 Watt for all frequency hopping systems operating in the 2400-2483.5 MHz band employing at least 75 non-overlapping hopping channels. The E.I.R.P shall not exceed 4 Watt.

6.3.2. Test Procedure Used

ANSI C63.10-2013 - Section 7.8.5

6.3.3. Test Setting

1. Set RBW \geq the 20dB bandwidth of the emission being measured.
2. VBW \geq RBW
3. Span = approximately five times the 20dB bandwidth, centered on a hopping channel
4. Detector = Peak
5. Trace mode = Max hold
6. Sweep = Auto couple
7. Allow the trace to stabilize. Use the marker-to-peak function to set the marker to the peak of the emission. The indicated level is the peak output power (don't forget added the external attenuation and cable loss)

6.3.4. Test Setup

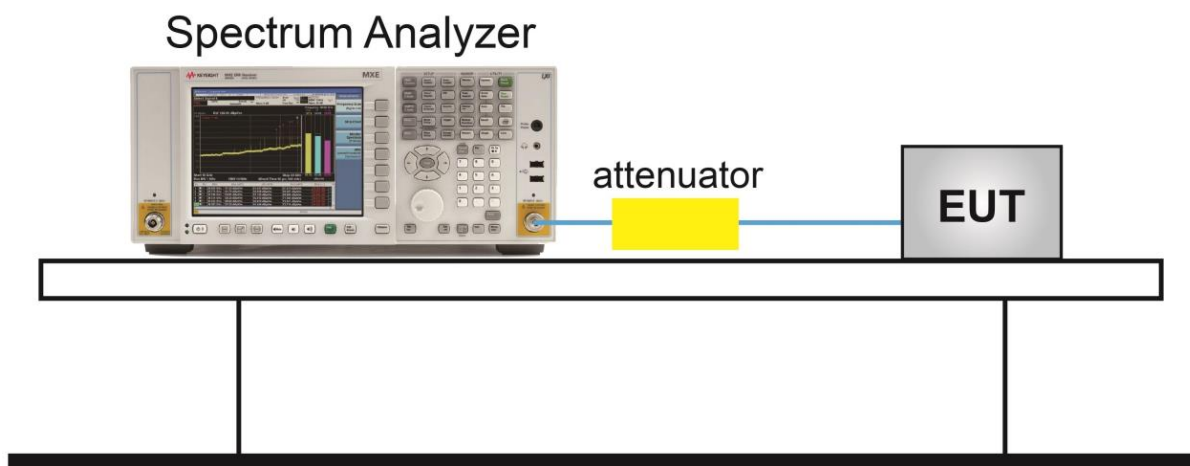

6.3.5. Test Result

Test Site	WZ-TR3	Test Engineer	Dandy Li
Test Date	2020/05/14		

Test Mode	Channel No.	Frequency (MHz)	Peak Power (dBm)	Peak Power Limit (dBm)	E.I.R.P. (dBm)	E.I.R.P. Limit (dBm)
DH5	00	2402	-6.57	≤ 30.00	-4.57	≤ 36.02
DH5	39	2441	-2.90	≤ 30.00	-0.90	≤ 36.02
DH5	78	2480	-0.57	≤ 30.00	1.43	≤ 36.02
2DH5	00	2402	-9.03	≤ 30.00	-7.03	≤ 36.02
2DH5	39	2441	-5.21	≤ 30.00	-3.21	≤ 36.02
2DH5	78	2480	-3.01	≤ 30.00	-1.01	≤ 36.02
3DH5	00	2402	-9.09	≤ 30.00	-7.09	≤ 36.02
3DH5	39	2441	-5.01	≤ 30.00	-3.01	≤ 36.02
3DH5	78	2480	-2.75	≤ 30.00	-0.75	≤ 36.02

Note: E.I.R.P. (dBm) = Peak Power (dBm) + Antenna Gain (dBi), antenna gain = 2dBi.

DH5 Output Power

Channel 00 (2402MHz)

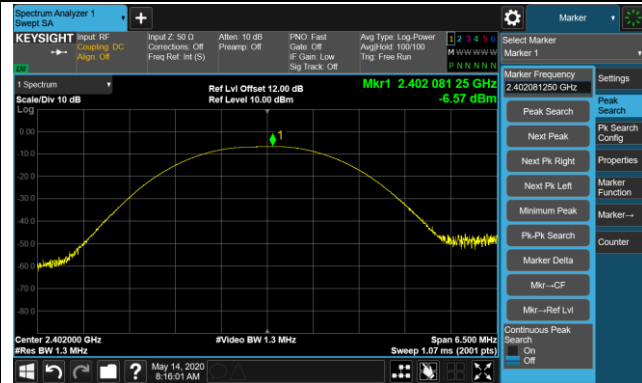

Channel 39 (2441MHz)

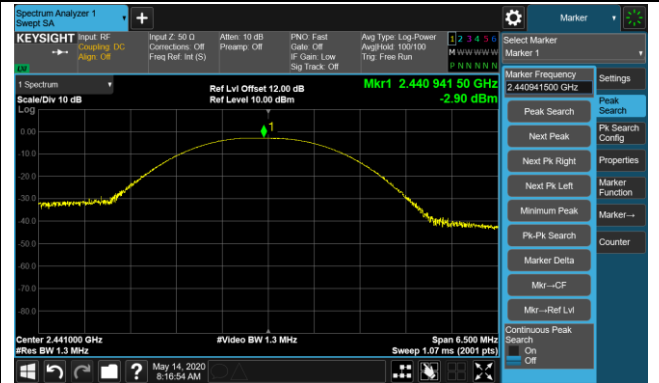

Channel 78 (2480MHz)

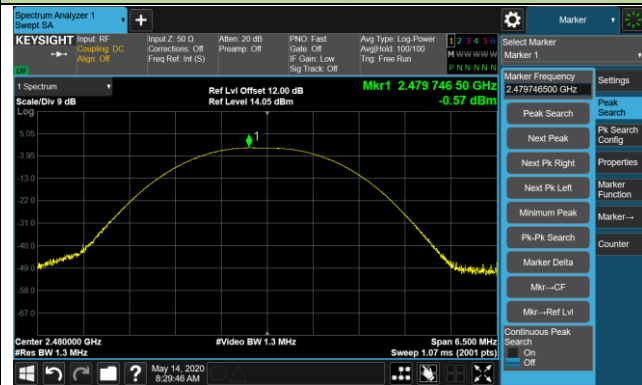

2DH5 Output Power

Channel 00 (2402MHz)

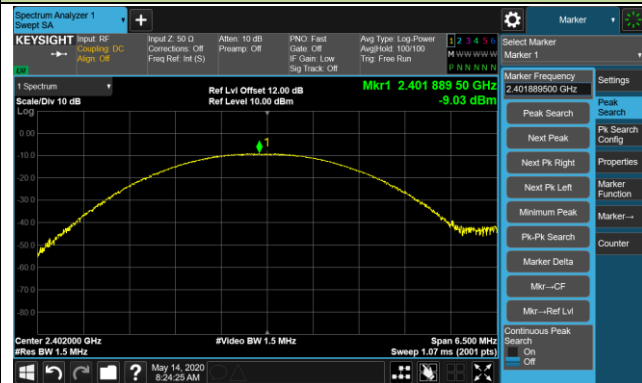

Channel 39 (2441MHz)



Channel 78 (2480MHz)

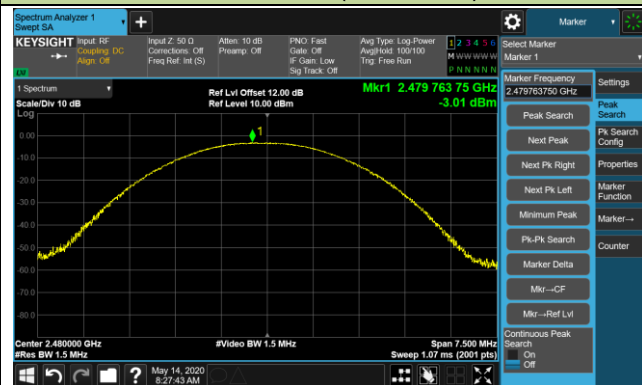

3DH5 Output Power

Channel 00 (2402MHz)

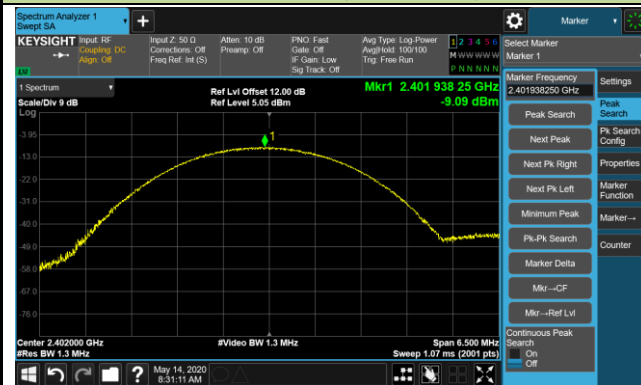

Channel 39 (2441MHz)

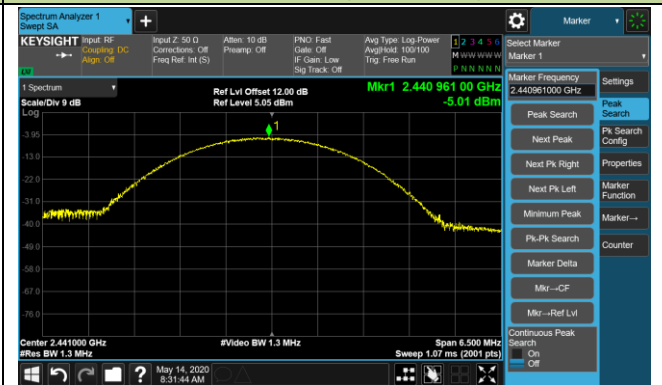

Channel 78 (2480MHz)

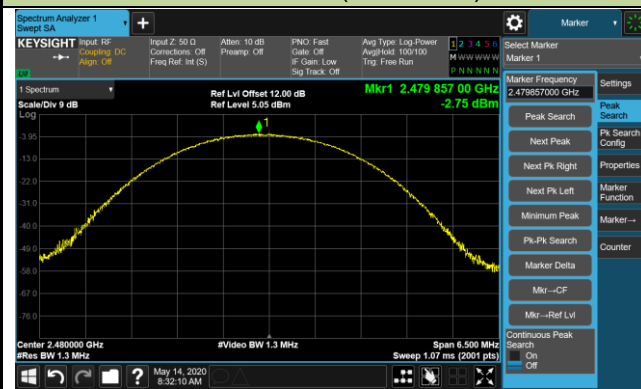

6.4. Carrier Frequency Separation Measurement

6.4.1. Test Limit

The minimum permissible channel separation for this system is $2/3$ the value of the 20dB BW.

6.4.2. Test Procedure Used

ANSI C63.10-2013 - Section 7.8.2

6.4.3. Test Setting

1. Span = Wide enough to capture the peaks of two adjacent channels.
2. Start with the RBW set to approximately 30% of the channel spacing; adjust as necessary to best identify the center of each individual channel.
3. VBW \geq RBW
4. Sweep time = Auto couple
5. Detector = Peak
6. Trace mode = Max hold
7. Allowed the trace to stabilize.
8. Use the marker-delta function to determine the separation between the peaks of the adjacent channels.

6.4.4. Test Setup

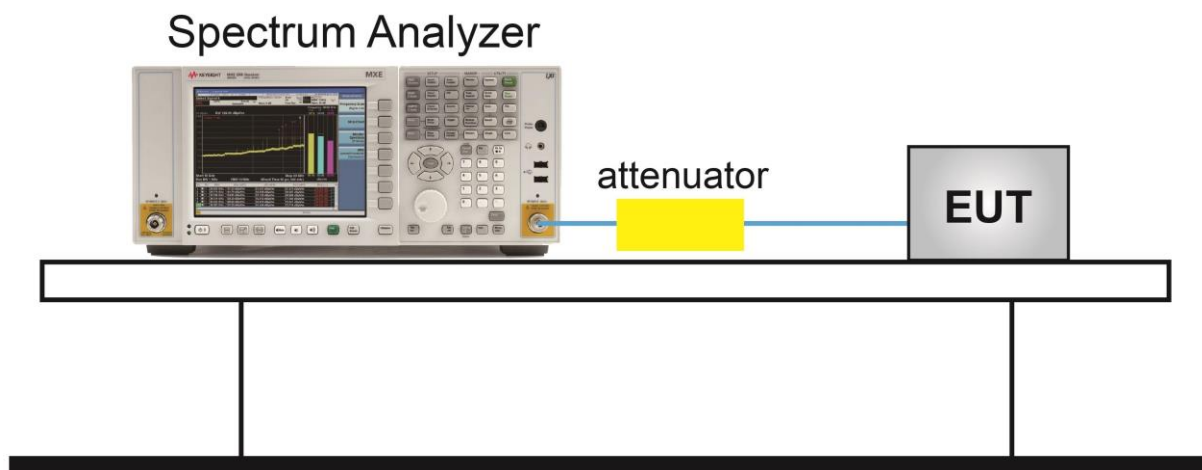

6.4.5. Test Result

Test Site	WZ-TR3	Test Engineer	Liz Yuan
Test Date	2021/01/10		

Test Mode	Channel No.	Frequency (MHz)	Limit (kHz)	Result
DH5	00	2402	≥ 615.20	Pass
DH5	39	2441	≥ 614.53	Pass
DH5	78	2480	≥ 615.20	Pass
2DH5	00	2402	≥ 846.67	Pass
2DH5	39	2441	≥ 872.67	Pass
2DH5	78	2480	≥ 870.00	Pass
3DH5	00	2402	≥ 841.33	Pass
3DH5	39	2441	≥ 843.33	Pass
3DH5	78	2480	≥ 840.00	Pass

Note: The Limit is 2/3 the value of the 20dB BW.

DH5 Carrier Frequency Separation

Channel 00 (2402MHz)

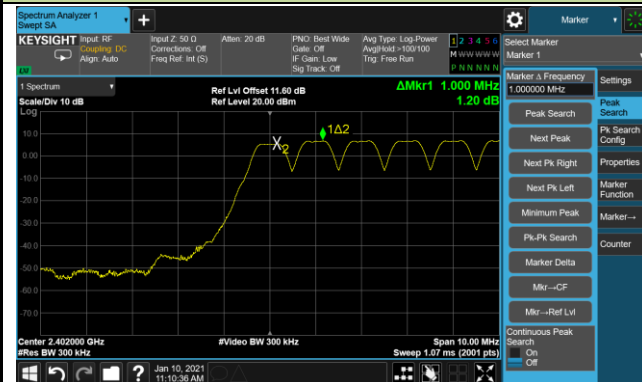

Channel 39 (2441MHz)

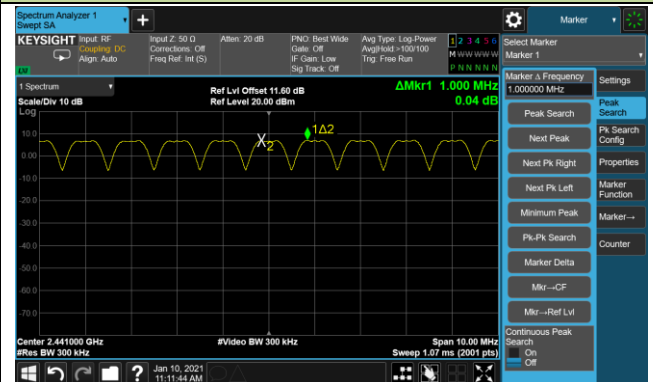

Channel 78 (2480MHz)



2DH5 Carrier Frequency Separation

Channel 00 (2402MHz)

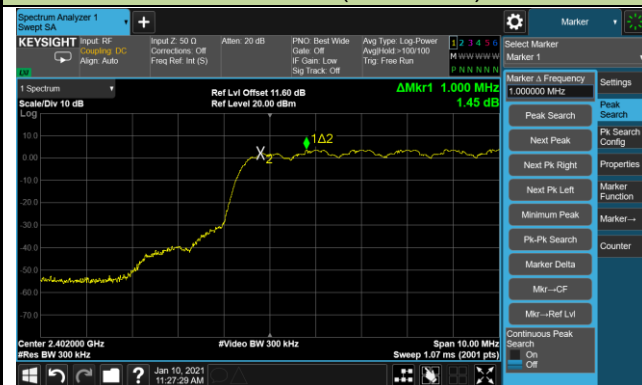

Channel 39 (2441MHz)



Channel 78 (2480MHz)



3DH5 Carrier Frequency Separation

Channel 00 (2402MHz)

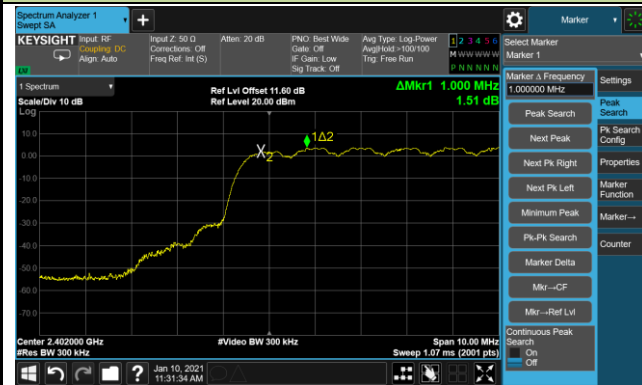

Channel 39 (2441MHz)

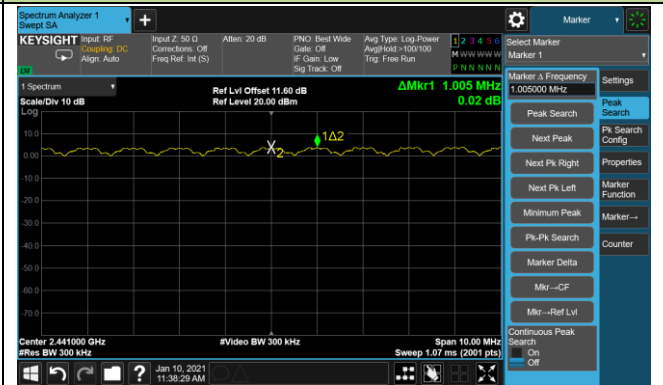

Channel 78 (2480MHz)



6.5. Number of Hopping Channels Measurement

6.5.1. Test Limit

This frequency hopping system must employ a minimum of 15 hopping channels.

6.5.2. Test Procedure Used

ANSI C63.10-2013 - Section 7.8.3

6.5.3. Test Setting

1. Span = The frequency band of operation. Depending on the number of channels the device supports, it may be necessary to divide the frequency range of operation across multiple spans, to allow the individual channels to be clearly seen.
2. RBW: To identify clearly the individual channels, set the RBW to less than 30% of the channel spacing or the 20 dB bandwidth, whichever is smaller.
3. VBW \geq RBW
4. Sweep time = Auto couple
5. Detector = Peak
6. Trace mode = Max hold
7. Allow the trace to stabilize

6.5.4. Test Setup

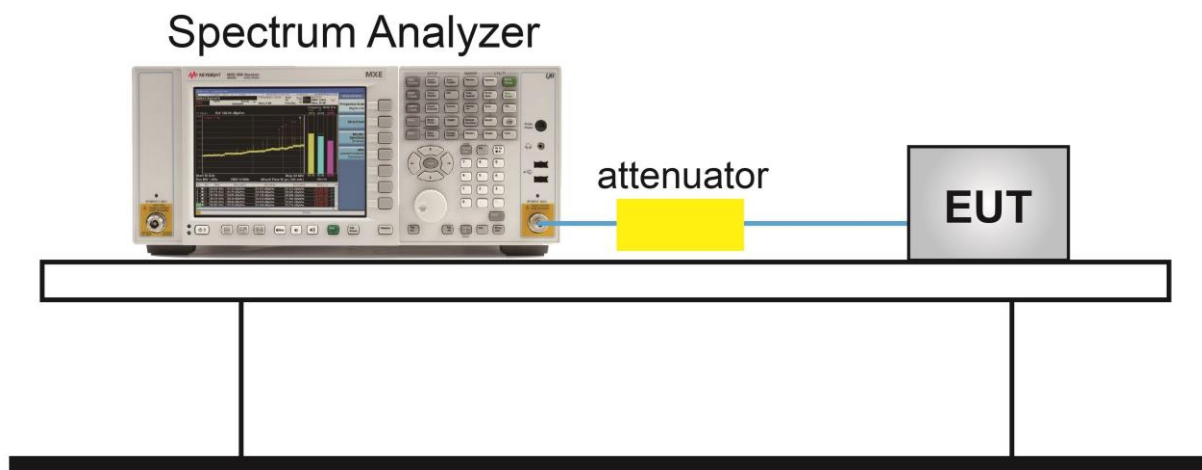

6.5.5. Test Result

Test Site	WZ-TR3	Test Engineer	Dandy Li
Test Date	2020/05/14		

Test Mode (Hopping)	Channel Numbers	Frequency (MHz)	Limit (Hopping Channels)	Result
DH5	79	2402 ~ 2480	≥ 15	Pass
2DH5	79	2402 ~ 2480	≥ 15	Pass
3DH5	79	2402 ~ 2480	≥ 15	Pass

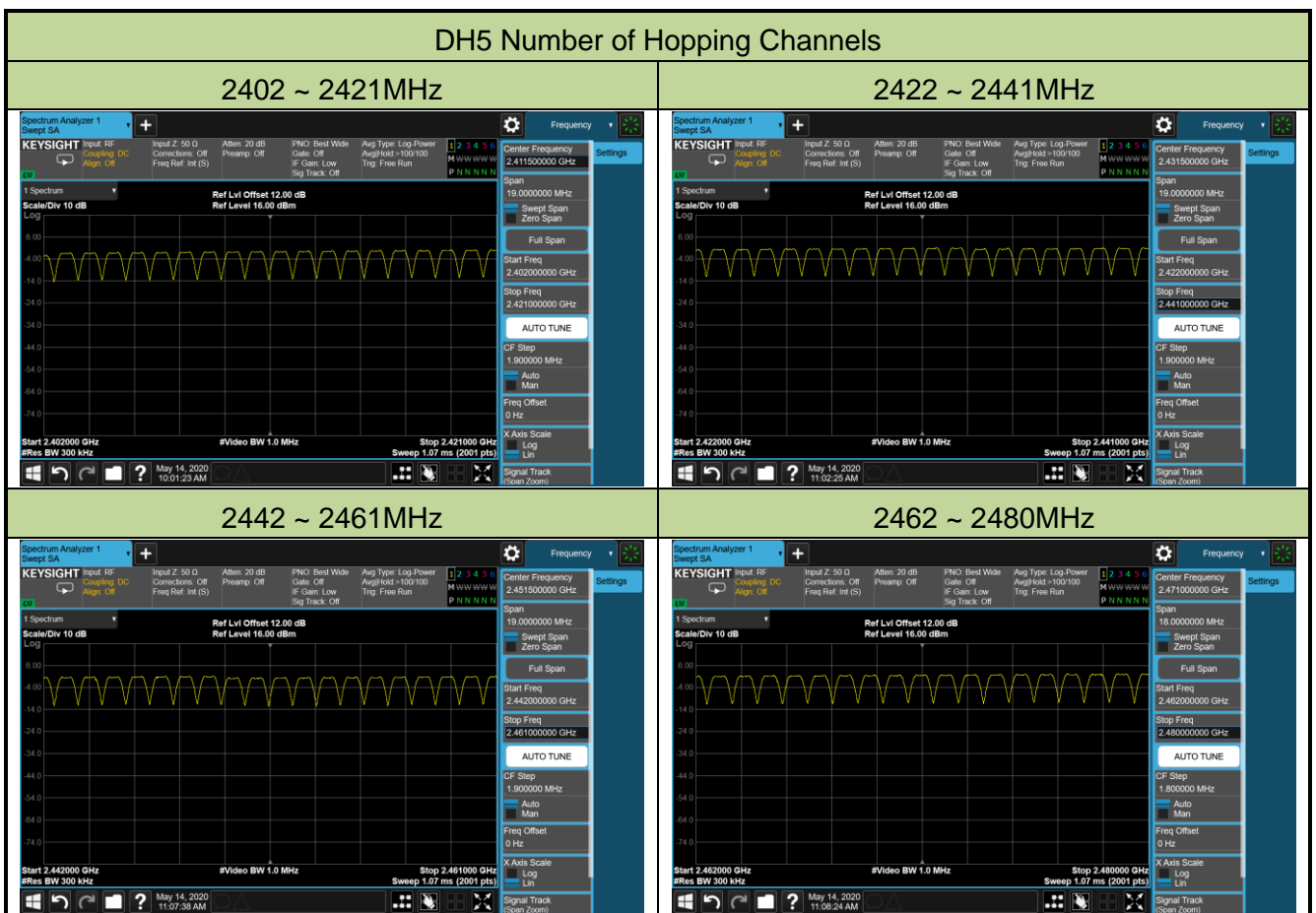

2DH5 Number of Hopping Channels

2402 ~ 2421MHz

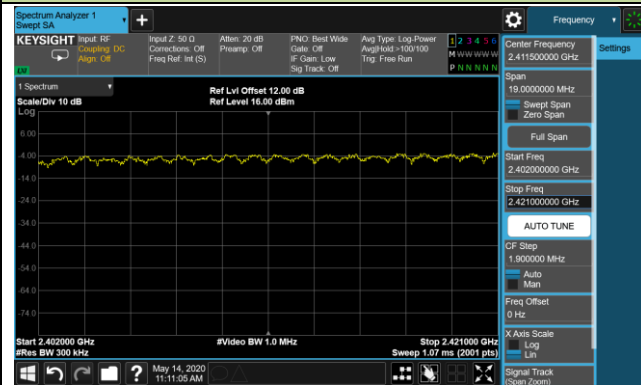

2422 ~ 2441MHz

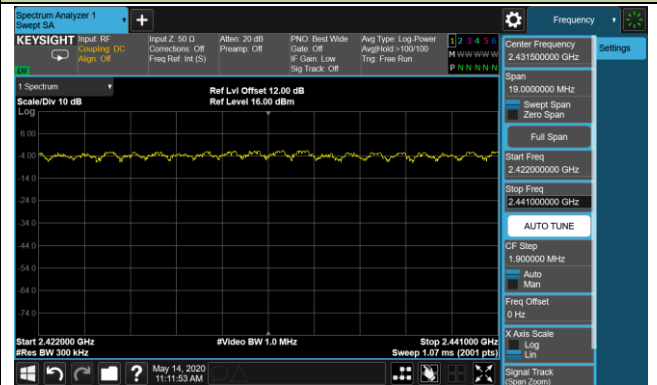

2442 ~ 2461MHz

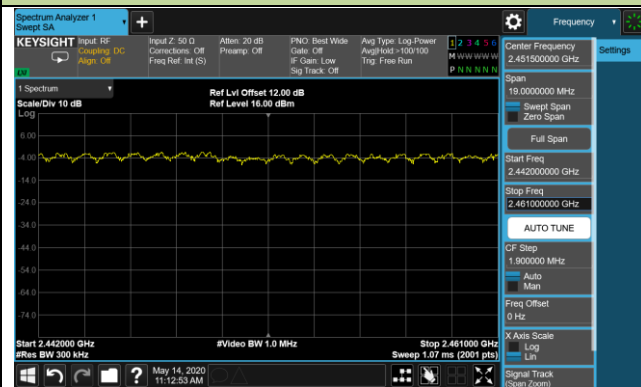

2462 ~ 2480MHz

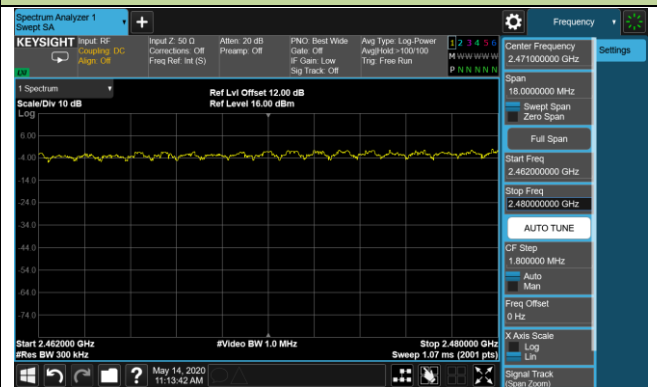

3DH5 Number of Hopping Channels

2402 ~ 2421MHz

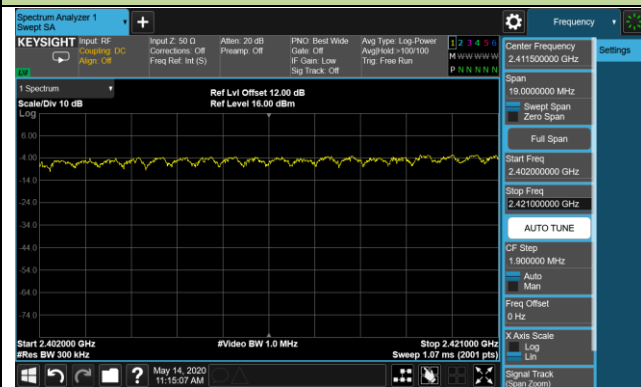

2422 ~ 2441MHz

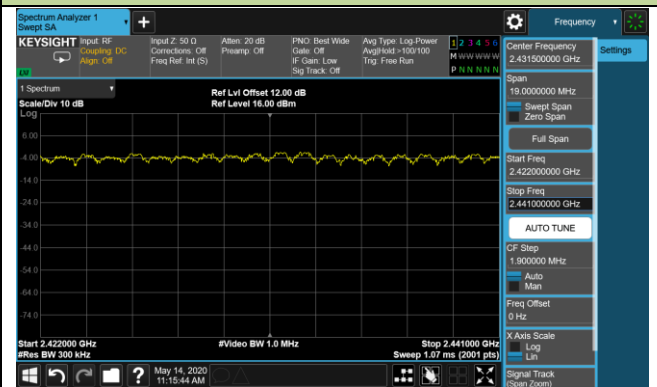

2442 ~ 2461MHz

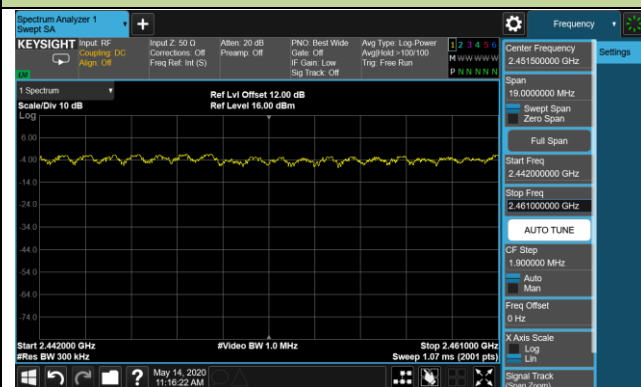

2462 ~ 2480MHz

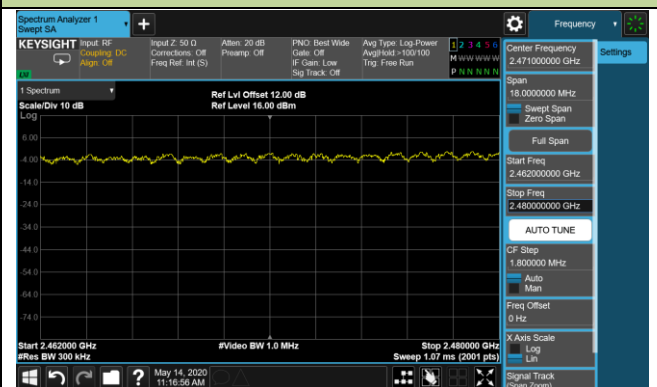

6.6. Time of Occupancy Measurement

6.6.1. Test Limit

The maximum permissible time of occupancy is 400ms within a period of 400ms multiplied by the number of hopping channels employed.

6.6.2. Test Procedure Used

ANSI C63.10-2013 - Section 7.8.4

6.6.3. Test Setting

1. Span = Zero span, centered on a hopping channel.
2. RBW shall be \leq channel spacing and where possible RBW should be set $\gg 1 / T$, where T is the expected dwell time per channel.
3. VBW \geq RBW
4. Sweep time = As necessary to capture the entire dwell time per hopping channel
5. Detector = Peak
6. Trace mode = Free run
7. Use the marker-delta function to determine the transmit time per hop. If this value varies with different modes of operation (data rate, modulation format, number of hopping channels, etc.), then repeat this test for each variation in transmit time.

6.6.4. Test Setup

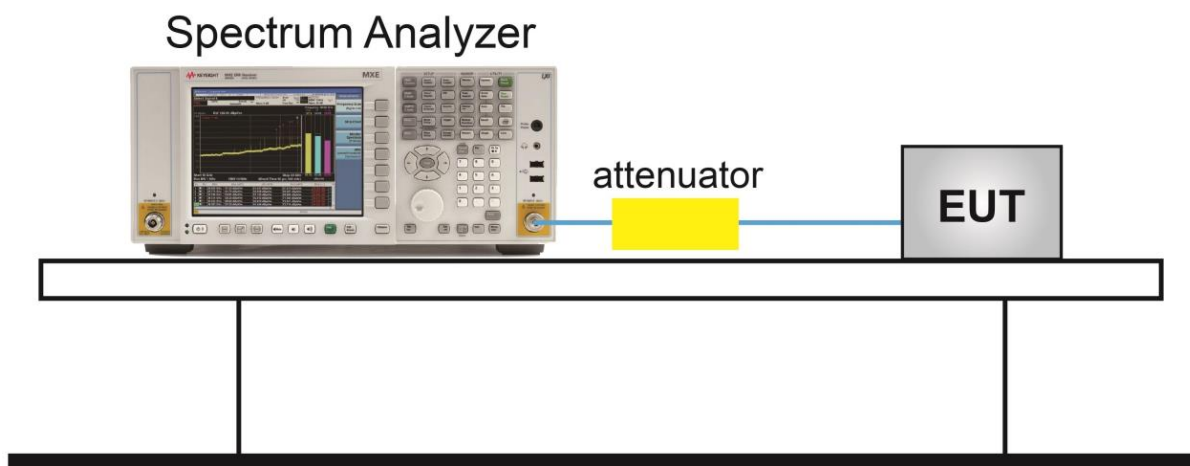

6.6.5. Test Result

Test Site	WZ-TR3	Test Engineer	Dandy Li
Test Date	2020/05/14		

Test Mode	Channel No.	Frequency (MHz)	Hops Over Occupancy Time (Hops)	Packet Transfer Time (ms)	Time of Occupancy (ms)	Limit (ms)	Result
3DH1	39	2441	320	0.39	126.11	≤ 400	Pass
3DH3	39	2441	160	1.65	264.16	≤ 400	Pass
3DH5	39	2441	107	2.90	310.30	≤ 400	Pass

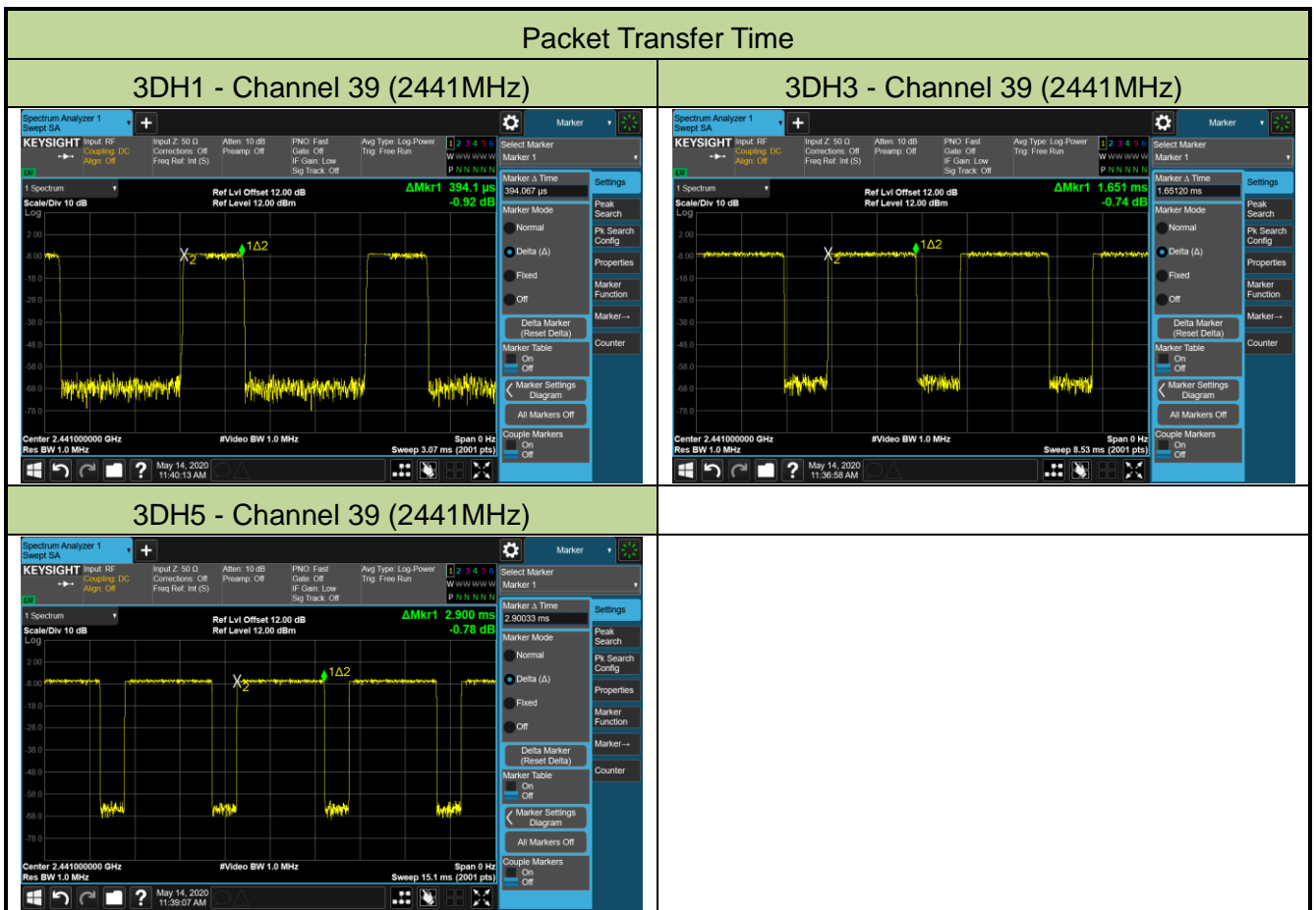

Note 1: According the Bluetooth Standard Specification, the nominal hop rate is 1600 hops/s. All Bluetooth unit participating in the piconet are time and hop synchronized to the channel.

Hops Over Occupancy Time in 31.6s for 3DH1 = $1600 / 2 / 79 * 31.6 = 320$.

Hops Over Occupancy Time in 31.6s for 3DH3 = $1600 / 4 / 79 * 31.6 = 160$.

Hops Over Occupancy Time in 31.6s for 3DH5 = $1600 / 6 / 79 * 31.6 = 107$.

Note 2: Time of Occupancy = Packet Transfer Time * Hops Over Occupancy Time in 31.6s.

6.7. Band-edge Compliance Measurement

6.7.1. Test Limit

The maximum permissible emission level is 20dBc. Any emissions were lying outside of the emission bandwidth and in authorized band edges to a field strength limit specified in Section 15.209 of the Title 47 CFR.

6.7.2. Test Procedure Used

ANSI C63.10-2013 - Section 6.10.4

6.7.3. Test Setting

1. Span = Wide enough to capture the peak level of the emission operating on the channel closest to the band edge, as well as any modulation products which fall outside of the authorized band of operation.
2. RBW = 100kHz
3. VBW = 300kHz
4. Detector = Peak
5. Sweep time = Auto couple
6. Trace mode = Max hold
7. Allow the trace to stabilize. Set the marker on the emission at the band edge, or on the highest modulation product outside of the band, if this level is greater than that at the band edge. Enable the marker-delta function, then use the marker-to-peak function to move the marker to the peak of the in-band emission.

6.7.4. Test Setup

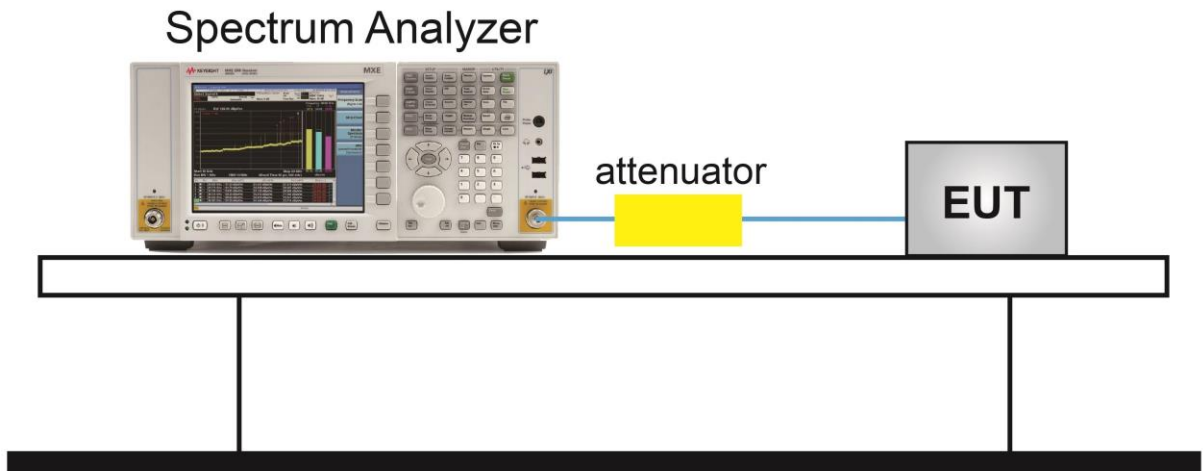

6.7.5. Test Result

Test Site	WZ-TR3	Test Engineer	Dandy Li
Test Date	2020/05/14		

Test Mode	Channel No.	Frequency (MHz)	Limit	Result
DH5	00	2402	20dBc	Pass
DH5	78	2480	20dBc	Pass
2DH5	00	2402	20dBc	Pass
2DH5	78	2480	20dBc	Pass
3DH5	00	2402	20dBc	Pass
3DH5	78	2480	20dBc	Pass
DH5	00 ~ 78	2402 ~ 2480	20dBc	Pass
2DH5	00 ~ 78	2402 ~ 2480	20dBc	Pass
3DH5	00 ~ 78	2402 ~ 2480	20dBc	Pass

Band-edge Compliance

DH5 - Channel 00 (2402MHz)

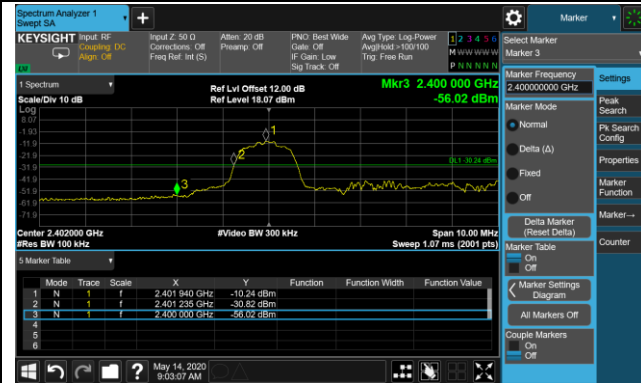

DH5 - Channel 78 (2480MHz)

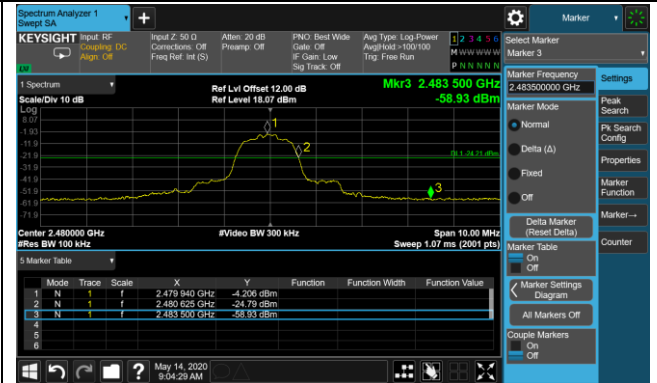

2DH5 - Channel 00 (2402MHz)

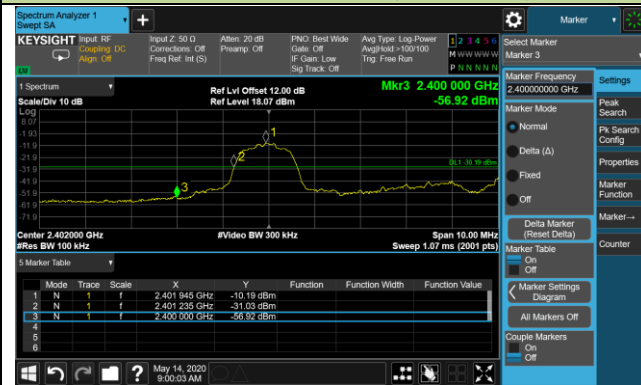

2DH5 - Channel 78 (2480MHz)

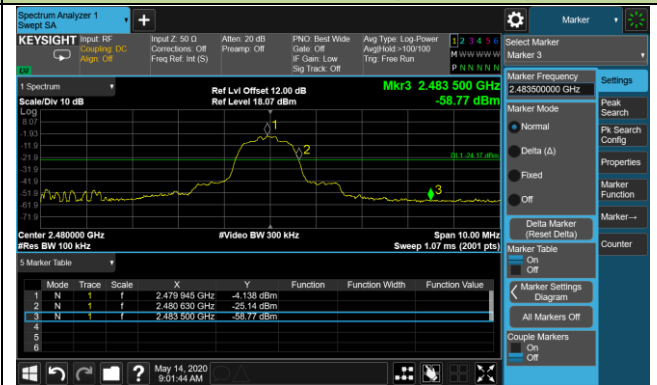

3DH5 - Channel 00 (2402MHz)



3DH5 - Channel 78 (2480MHz)

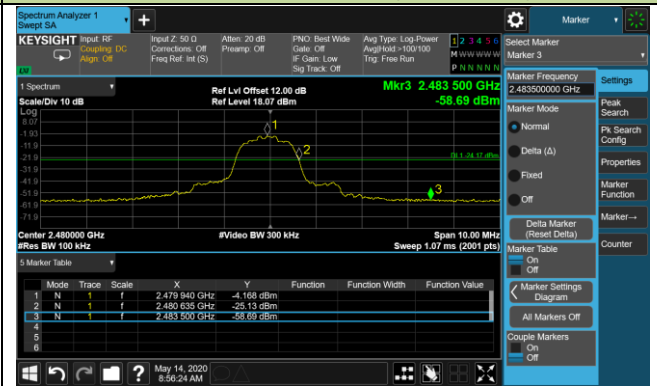

Operation Frequency Range of 20dB Bandwidth within Hopping Mode

DH5

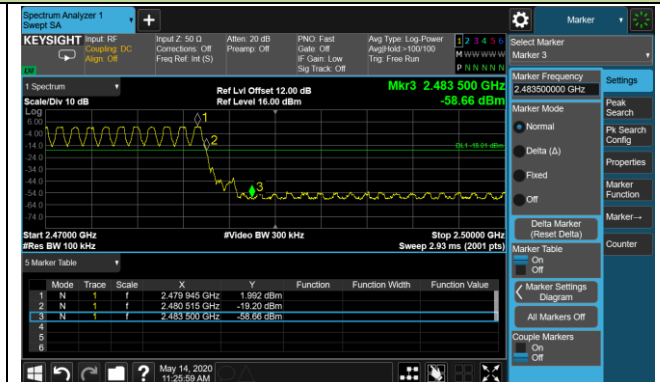
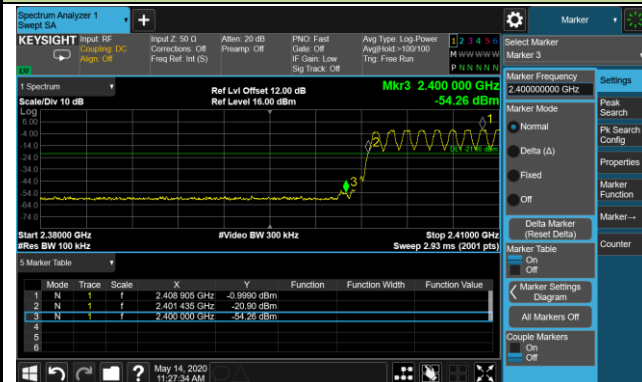

2DH5

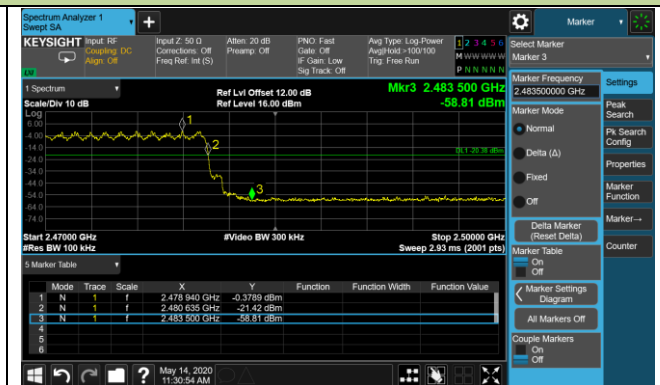
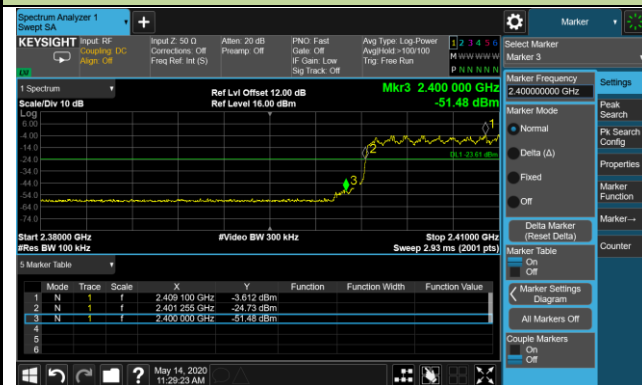

3DH5

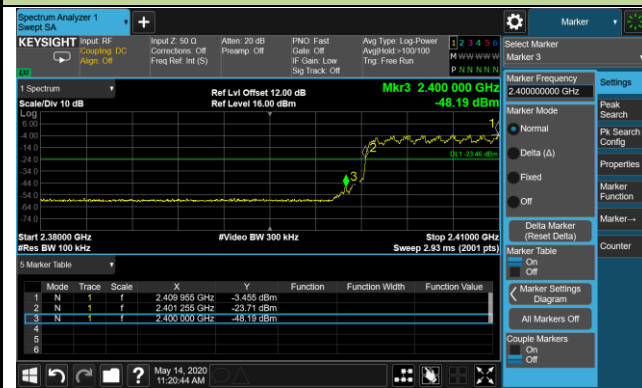

6.8. Conducted Spurious Emissions Measurement

6.8.1. Test Limit

In any 100 kHz bandwidth outside the frequency band in which the spread spectrum or digitally modulated intentional radiator is operating, the radio frequency power that is produced by the intentional radiator shall be at least 20 dB below that in the 100 kHz bandwidth within the band that contains the highest level of the desired power, based on either an RF conducted or a radiated measurement, provided the transmitter demonstrates compliance with the peak conducted or a radiated measurement, provided the transmitter demonstrates compliance with the peak conducted power limits.

6.8.2. Test Procedure Used

ANSI C63.10-2013 - Section 7.8.8

6.8.3. Test Setting

1. Span = Wide enough to capture the peak level of the in-band emission and all spurious emissions (e.g., harmonics) from the lowest frequency generated in the EUT up through the 10th harmonic. Typically, several plots are required to cover this entire span.
2. RBW = 100kHz
3. VBW = 300kHz
4. Detector = Peak
5. Sweep time = Auto couple
6. Trace mode = Max hold
7. Trace was allowed to stabilize
8. Set the marker on the peak of any spurious emission recorded. The level displayed must comply with the limit specified in this section.

6.8.4. Test Setup

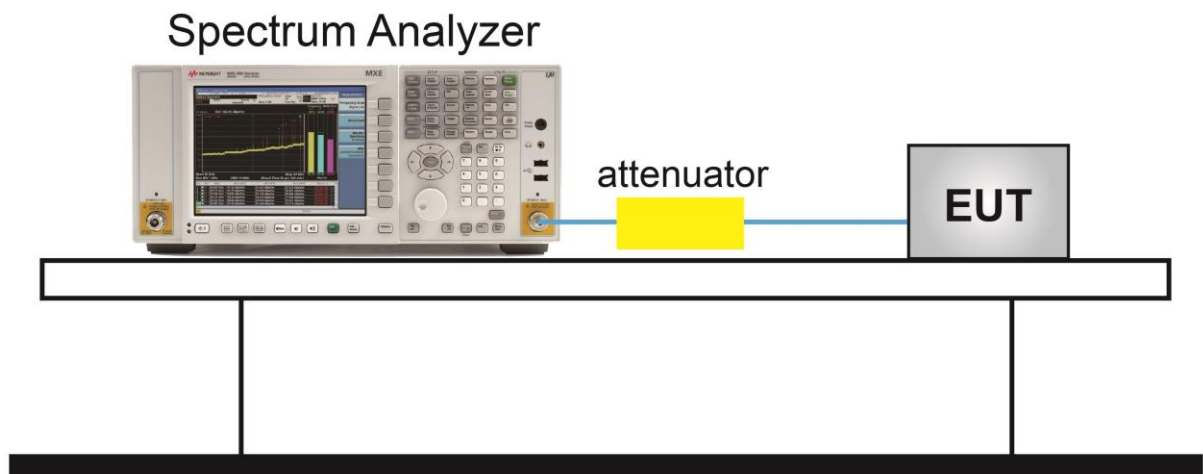

6.8.5. Test Result

Test Site	WZ-TR3	Test Engineer	Dandy Li
Test Date	2020/05/14		

Test Mode	Channel No.	Frequency (MHz)	Limit (MHz)	Result
DH5	00	2402	20dBc	Pass
DH5	39	2441	20dBc	Pass
DH5	78	2480	20dBc	Pass
2DH5	00	2402	20dBc	Pass
2DH5	39	2441	20dBc	Pass
2DH5	78	2480	20dBc	Pass
3DH5	00	2402	20dBc	Pass
3DH5	39	2441	20dBc	Pass
3DH5	78	2480	20dBc	Pass

DH5 Conducted Spurious Emissions

Channel 00 (2402MHz)

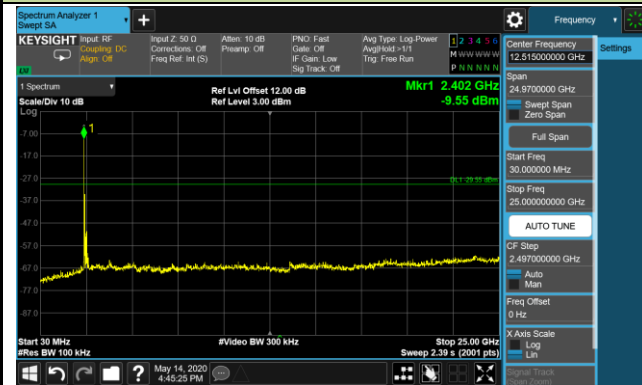

Channel 39 (2441MHz)

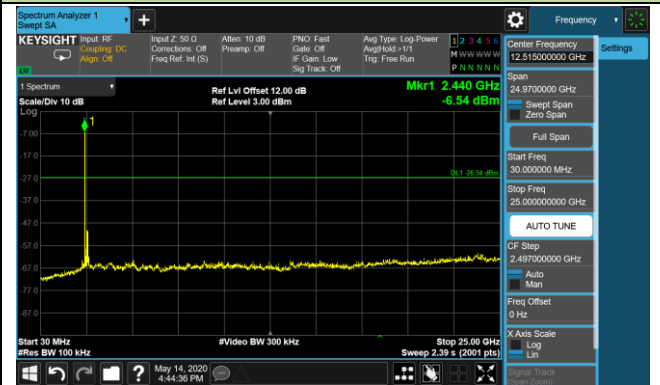

Channel 78 (2480MHz)

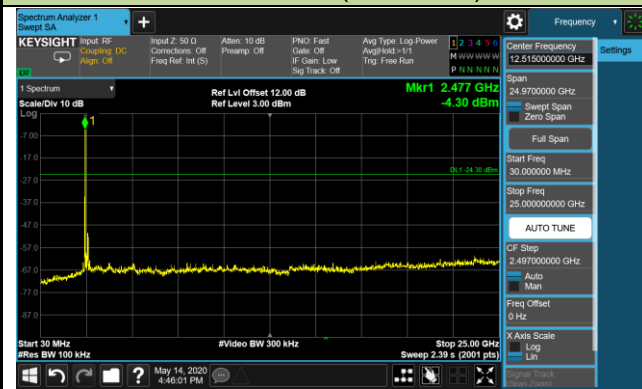

2DH5 Conducted Spurious Emissions

Channel 00 (2402MHz)

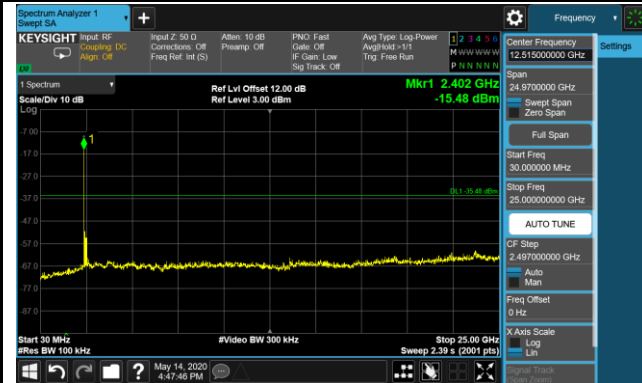

Channel 39 (2441MHz)

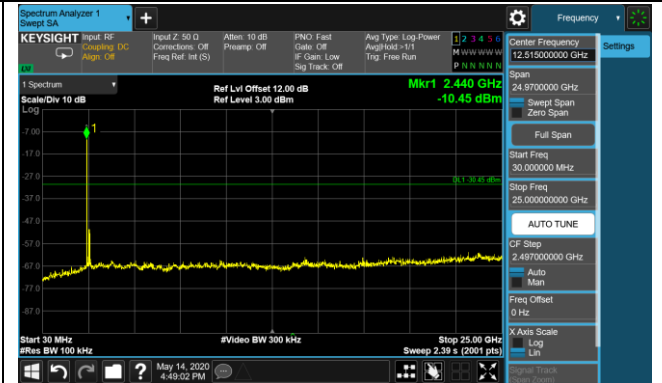

Channel 78 (2480MHz)

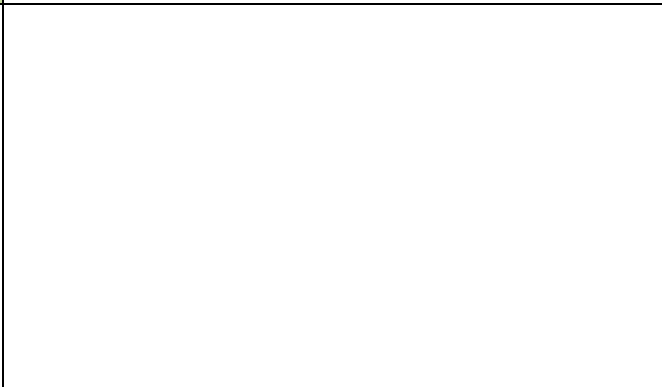
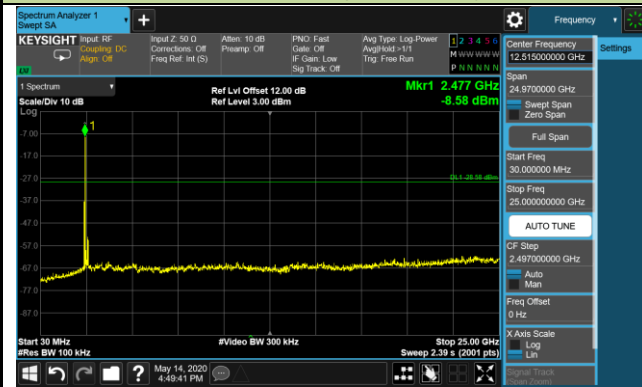

3DH5 Conducted Spurious Emissions

Channel 00 (2402MHz)

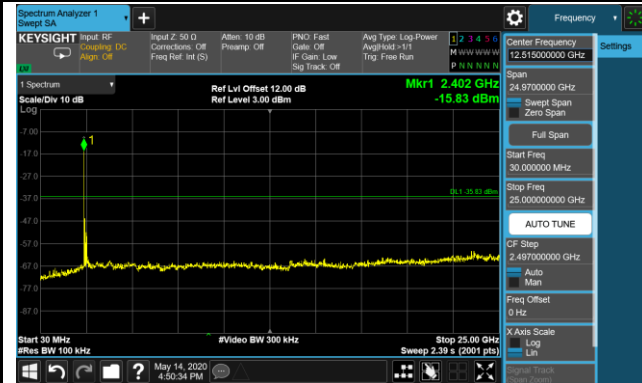

Channel 39 (2441MHz)

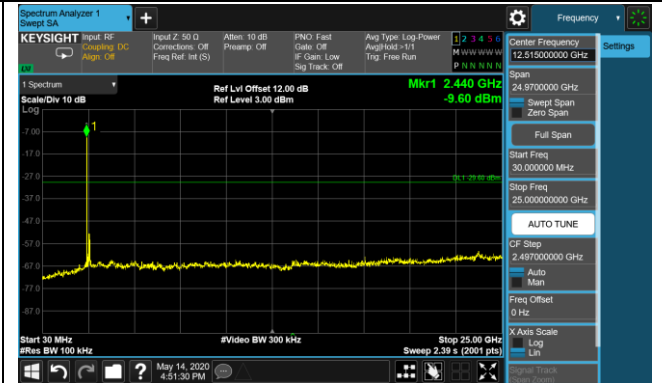

Channel 78 (2480MHz)

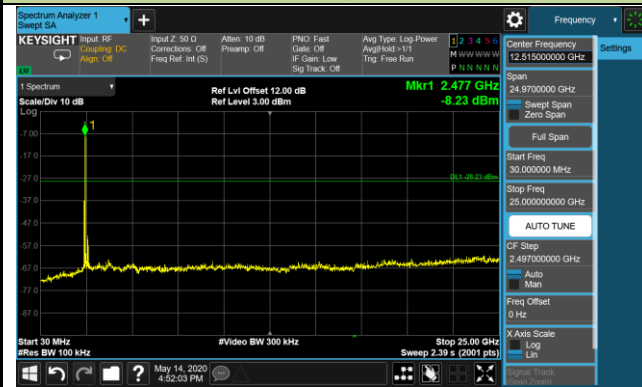

6.9. Radiated Spurious Emission Measurement

6.9.1. Test Limit

All out of band emissions appearing in a restricted band as specified in Section 15.205 of the Title 47 CFR must not exceed the limits shown in Table per Section 15.209.

FCC Part 15.209 Limit		
Frequency [MHz]	Field Strength [$\mu\text{V}/\text{m}$]	Measured Distance [Meters]
0.009 - 0.490	2400/F (kHz)	300
0.490 - 1.705	24000/F (kHz)	30
1.705 - 30	30	30
30 - 88	100	3
88 - 216	150	3
216 - 960	200	3
Above 960	500	3

All out of band emissions appearing in a restricted band as specified in Section 8.10 of the RSS-Gen must not exceed the limits shown in Table per Section 8.9.

RSS-Gen Section 8.9 Limit			
Frequency (MHz)	Field Strength ($\mu\text{V}/\text{m}$)	Magnetic Field Strength (H-Field) ($\mu\text{A}/\text{m}$)	Measured Distance (m)
0.009 - 0.490	--	6.37/F (F in kHz)	300
0.490 - 1.705	--	6.37/F (F in kHz)	30
1.705 - 30	--	0.08	30
30 - 88	100	--	3
88 - 216	150	--	3
216 - 960	200	--	3
Above 960	500	--	3

6.9.2. Test Procedure Used

ANSI C63.10-2013 - Section 6.3 (General Requirements)

ANSI C63.10-2013 - Section 6.4 (Standard test method below 30MHz)

ANSI C63.10-2013 - Section 6.5 (Standard test method above 30MHz to 1GHz)

ANSI C63.10-2013 - Section 6.6 (Standard test method above 1GHz)

6.9.3. Test Setting

Table 1 - RBW as a function of frequency

Frequency	RBW
9 ~ 150 kHz	200 ~ 300 Hz
0.15 ~ 30 MHz	9 ~ 10 kHz
30 ~ 1000 MHz	100 ~ 120 kHz
Above 1000 MHz	1 MHz

Quasi-Peak Measurements below 1GHz

1. Analyzer center frequency was set to the frequency of the radiated spurious emission of interest
2. Span was set greater than 1MHz
3. RBW = as specified in Table 1
4. Detector = CISPR quasi-peak
5. Sweep time = auto couple
6. Trace was allowed to stabilize

Peak Measurements above 1GHz

1. Analyzer center frequency was set to the frequency of the radiated spurious emission of interest
2. RBW = 1MHz
3. VBW = 3MHz
4. Detector = peak
5. Sweep time = auto couple
6. Trace mode = max hold
7. Trace was allowed to stabilize