

# FCC SAR EVALUATION REPORT

In accordance with the requirements of  
FCC 47 CFR Part 2(2.1093), ANSI/IEEE C95.1-1992 and  
IEEE Std 1528-2013

**Product Name :** TABLET

**Trademark :** HOTWAV, iHunt

**Model Name :** TAB R6 Pro

**Family Model :** P2201T, P2202T, TAB R6 Pro Max,  
TAB R6 Max, TAB R6 Plus, TAB R5 Pro,  
TAB R5 Pro Max, TAB R5 Max, TAB R5 Plus,  
Strong Tablet P15000 PRO

**FCC ID :** 2AOKUTABLET

**Report No. :** STR220907003009E

## Prepared for

SHENZHEN TUGAO INTELLIGENT CO.,LTD  
8th Floor, Bldg A, Jinggang Science&Technology Park, Fuyong, Bao'an District,  
Shenzhen, China

## Prepared by

Shenzhen NTEK Testing Technology Co., Ltd.  
1/F, Building E, Fenda Science Park, Sanwei Community, Xixiang Street,  
Bao'an District, Shenzhen 518126 P.R.China.  
Tel. 400-800-6106, 0755-2320 0050, 0755-2320 0090  
Website: <http://www.ntek.org.cn>

### TEST RESULT CERTIFICATION

**Applicant's name** .....: SHENZHEN TUGAO INTELLIGENT CO.,LTD  
Address.....: 8th Floor, Bldg A, Jinggang Science&Technology Park, Fuyong, Bao'an District, Shenzhen, China

**Manufacturer's Name**.....: SHENZHEN TUGAO INTELLIGENT CO.,LTD  
Address.....: 8th Floor, Bldg A, Jinggang Science&Technology Park, Fuyong, Bao'an District, Shenzhen, China

**Product description**

Product name.....: TABLET  
Trademark .....: HOTWAV, iHunt  
Model Name .....: TAB R6 Pro  
P2201T, P2202T, TAB R6 Pro Max, TAB R6 Max, TAB R6 Plus,  
Family Model.....: TAB R5 Pro, TAB R5 Pro Max, TAB R5 Max, TAB R5 Plus, Strong Tablet P15000 PRO

**Standards** .....: FCC 47 CFR Part 2(2.1093); ANSI/IEEE C95.1-1992  
IEEE Std 1528-2013; Published RF exposure KDB procedures

This device described above has been tested by Shenzhen NTEK. In accordance with the measurement methods and procedures specified in IEEE Std 1528-2013 and KDB 865664 D01. Testing has shown that this device is capable of compliance with localized specific absorption rate (SAR) specified in FCC 47 CFR Part 2(2.1093) and ANSI/IEEE C95.1-1992. The test results in this report apply only to the tested sample of the stated device/equipment. Other similar device/equipment will not necessarily produce the same results due to production tolerance and measurement uncertainties.

This report shall not be reproduced except in full, without the written approval of Shenzhen NTEK, this document may be altered or revised by Shenzhen NTEK, personal only, and shall be noted in the revision of the document.

Test Sample Number ..... T220907001R001

**Date of Test**

Date (s) of performance of tests .....: Sep. 20, 2022 ~ Oct. 08, 2022

Date of Issue .....: Nov. 07, 2022

Test Result.....: **Pass**

Prepared By : Jacob.chen  
(Test Engineer) : (Jacob Chen)

Approved By : Alex  
(Lab Manager) : (Alex Li)

※ ※ Revision History ※ ※

REV.	DESCRIPTION	ISSUED DATE	REMARK
Rev.1.0	Initial Test Report Release	Nov. 07, 2022	Jacob Chen

## TABLE OF CONTENTS

1.	General Information .....	6
1.1.	RF exposure limits .....	6
1.2.	Statement of Compliance.....	7
1.3.	EUT Description .....	7
1.4.	Test specification(s) .....	9
1.5.	Ambient Condition .....	9
2.	SAR Measurement System .....	10
2.1.	SATIMO SAR Measurement Set-up Diagram .....	10
2.2.	Robot .....	11
2.3.	E-Field Probe.....	12
2.3.1.	E-Field Probe Calibration.....	12
2.4.	SAM phantoms .....	13
2.4.1.	Technical Data .....	14
2.5.	Device Holder .....	15
2.6.	Test Equipment List .....	16
3.	SAR Measurement Procedures .....	18
3.1.	Power Reference.....	18
3.2.	Area scan & Zoom scan .....	18
3.3.	Description of interpolation/extrapolation scheme .....	20
3.4.	Volumetric Scan .....	20
3.5.	Power Drift .....	20
4.	System Verification Procedure.....	21
4.1.	Tissue Verification.....	21
4.1.1.	Tissue Dielectric Parameter Check Results .....	22
4.2.	System Verification Procedure .....	23
4.2.1.	System Verification Results .....	24
5.	SAR Measurement variability and uncertainty .....	25
5.1.	SAR measurement variability .....	25
5.2.	SAR measurement uncertainty.....	25
6.	RF Exposure Positions .....	26
6.1.	Tablet host platform exposure conditions .....	26
7.	RF Output Power .....	27
7.1.	GSM Conducted Power .....	27
7.2.	WCDMA Conducted Power.....	28
7.3.	LTE Conducted Power.....	29
7.4.	WLAN & Bluetooth Output Power.....	52
7.4.1.	Output Power Results Of WLAN .....	52
7.4.2.	Output Power Results Of Bluetooth .....	54
8.	Antenna Location.....	55

9. Stand-alone SAR test exclusion .....	65
10. SAR Results .....	66
10.1. SAR measurement results .....	66
10.1.1. SAR measurement Result of GSM850.....	66
10.1.2. SAR measurement Result of GSM1900.....	67
10.1.3. SAR measurement Result of WCDMA Band 2.....	67
10.1.4. SAR measurement Result of WCDMA Band 4.....	67
10.1.5. SAR measurement Result of WCDMA Band 5.....	68
10.1.6. SAR measurement Result of LTE Band 2 .....	68
10.1.7. SAR measurement Result of LTE Band 4 .....	69
10.1.8. SAR measurement Result of LTE Band 5 .....	69
10.1.9. SAR measurement Result of LTE Band 7 .....	70
10.1.10. SAR measurement Result of LTE Band 12 .....	71
10.1.11. SAR measurement Result of LTE Band 17 .....	72
10.1.12. SAR measurement Result of LTE Band 25 .....	72
10.1.13. SAR measurement Result of LTE Band 26A.....	73
10.1.14. SAR measurement Result of LTE Band 26B .....	73
10.1.15. SAR measurement Result of LTE Band 41 .....	74
10.1.16. SAR measurement Result of LTE Band 66 .....	75
10.1.17. SAR measurement Result of WLAN 2.4G.....	76
10.1.18. SAR measurement Result of WLAN 5.2G.....	76
10.1.19. SAR measurement Result of WLAN 5.8G.....	76
10.2. SAR Summation Scenario .....	76
11. Appendix A. Photo documentation.....	77
12. Appendix B. System Check Plots .....	78
13. Appendix C. Plots of High SAR Measurement .....	95
14. Appendix D. Calibration Certificate.....	134

## 1. General Information

### 1.1. RF exposure limits

(A).Limits for Occupational/Controlled Exposure (W/kg)

Whole-Body	Partial-Body	Hands, Wrists, Feet and Ankles
0.4	8.0	20.0

(B).Limits for General Population/Uncontrolled Exposure (W/kg)

Whole-Body	Partial-Body	Hands, Wrists, Feet and Ankles
0.08	1.6	4.0

NOTE: **Whole-Body SAR** is averaged over the entire body, **partial-body SAR** is averaged over any 1 gram of tissue defined as a tissue volume in the shape of a cube. **SAR for hands, wrists, feet and ankles** is averaged over any 10 grams of tissue defined as a tissue volume in the shape of a cube.

#### **Occupational/Controlled Environments:**

Are defined as locations where there is exposure that may be incurred by people who are aware of the potential for exposure, (i.e. as a result of employment or occupation).

#### **General Population/Uncontrolled Environments:**

Are defined as locations where there is the exposure of individuals who have no knowledge or control of their exposure.

NOTE  
TRUNK LIMIT  
1.6 W/kg  
APPLIED TO THIS EUT

### 1.2. Statement of Compliance

The maximum results of Specific Absorption Rate (SAR) found during testing for TAB R6 Pro are as follows.

RF Exposure Conditions		Equipment Class -Highest Reported SAR (W/kg)			
		PCT	DTS	NII	DSS
1-g Body (Separation distance of 0mm)		1.131	0.237	0.362	N/A
Max Simultaneous Tx	Body	1.493	1.368	1.493	1.465

Note: The Max Simultaneous Tx is calculated based on the same configuration and test position. This device is in compliance with Specific Absorption Rate (SAR) for general population/uncontrolled exposure limits (1.6 W/kg) specified in FCC 47 CFR Part 2(2.1093) and ANSI/IEEE C95.1-1992, and had been tested in accordance with the measurement methods and procedures specified in IEEE Std 1528-2013 & KDB 865664 D01.

### 1.3. EUT Description

Device Information	
Product Name	TABLET
Trade Name	HOTWAV, iHunt
Model Name	TAB R6 Pro
Family Model	P2201T, P2202T, TAB R6 Pro Max, TAB R6 Max, TAB R6 Plus, TAB R5 Pro, TAB R5 Pro Max, TAB R5 Max, TAB R5 Plus, Strong Tablet P15000 PRO
Model Difference	All models are the same circuit and RF module, except the model names.
FCC ID	2AOKUTABLET
Device Phase	Identical Prototype
Exposure Category	General population / Uncontrolled environment
Antenna	PIFA Antenna
Battery	DC 3.85V, 15600mAh, 60.06Wh
Hardware version	TP718_MAIN_PCB_V1.1
Software version	HOTWAV_TAB R6 Pro_V3.0_20221026
Device Operating Configurations	
Supporting Mode(s)	GSM 850/1900, WCDMA Band 2/4/5, LTE Band 2/4/5/7/12/17/25/26/41/66, WLAN 2.4G/5G, Bluetooth,NFC
Test Modulation	GSM(GMSK/8PSK), WCDMA(QPSK), LTE(QPSK/16QAM), WLAN(DSSS/OFDM), Bluetooth(GFSK, $\pi/4$ -DQPSK, 8DPSK), NFC(ASK)

Device Class	B		
Operating Frequency Range(s)	Band	Tx (MHz)	Rx (MHz)
	GSM 850	824-849	869-894
	GSM 1900	1850-1910	1930-1990
	WCDMA Band 2	1850-1910	1930-1990
	WCDMA Band 4	1710-1755	2110-2155
	WCDMA Band 5	824-849	869-894
	LTE Band 2	1850-1910	1930-1990
	LTE Band 4	1710-1755	2110-2155
	LTE Band 5	824-849	869-894
	LTE Band 7	2500-2570	2620-2690
	LTE Band 12	699-716	729-746
	LTE Band 17	704-716	734-746
	LTE Band 25	1850-1915	1930-1995
	LTE Band 26	814-849	859-894
	LTE Band 41	2535-2655	
	LTE Band 66	1710-1780	2110-2200
	WLAN 2.4G	2412-2462	
	WLAN 5.2G	5180-5240	
	WLAN 5.8G	5745-5825	
Bluetooth	2402-2480		
NFC	13.56		
GPRS Multislot Class(12)	Max Number of Timeslots in Uplink		4
	Max Number of Timeslots in Downlink		4
	Max Total Timeslot		5
EGPRS Multislot Class(12)	Max Number of Timeslots in Uplink		4
	Max Number of Timeslots in Downlink		4
	Max Total Timeslot		5
Power Class	4, tested with power level 5(GSM 850)		
	1, tested with power level 0(GSM 1900)		
	3, tested with power control "all 1"(WCDMA Band 2)		
	3, tested with power control "all 1"(WCDMA Band 4)		
	3, tested with power control "all 1"(WCDMA Band 5)		
	3, tested with power control all Max.(LTE Band 2)		
	3, tested with power control all Max.(LTE Band 4)		
	3, tested with power control all Max.(LTE Band 5)		
	3, tested with power control all Max.(LTE Band 7)		
	3, tested with power control all Max.(LTE Band 12)		
	3, tested with power control all Max.(LTE Band 17)		
	3, tested with power control all Max.(LTE Band 25)		



	3, tested with power control all Max.(LTE Band 26)
	3, tested with power control all Max.(LTE Band 41)
	3, tested with power control all Max.(LTE Band 66)

**1.4. Test specification(s)**

FCC 47 CFR Part 2(2.1093)
ANSI/IEEE C95.1-1992
IEEE Std 1528-2013
KDB 865664 D01 SAR measurement 100 MHz to 6 GHz
KDB 865664 D02 RF Exposure Reporting
KDB 447498 D01 General RF Exposure Guidance
KDB 248227 D01 802.11 Wi-Fi SAR
KDB 941225 D01 3G SAR Procedures
KDB 941225 D05 SAR for LTE Devices
KDB 616217 D04 SAR for laptop and tablets

**1.5. Ambient Condition**

Ambient temperature	20°C – 24°C
Relative Humidity	30% – 70%

## 2. SAR Measurement System

### 2.1. SATIMO SAR Measurement Set-up Diagram

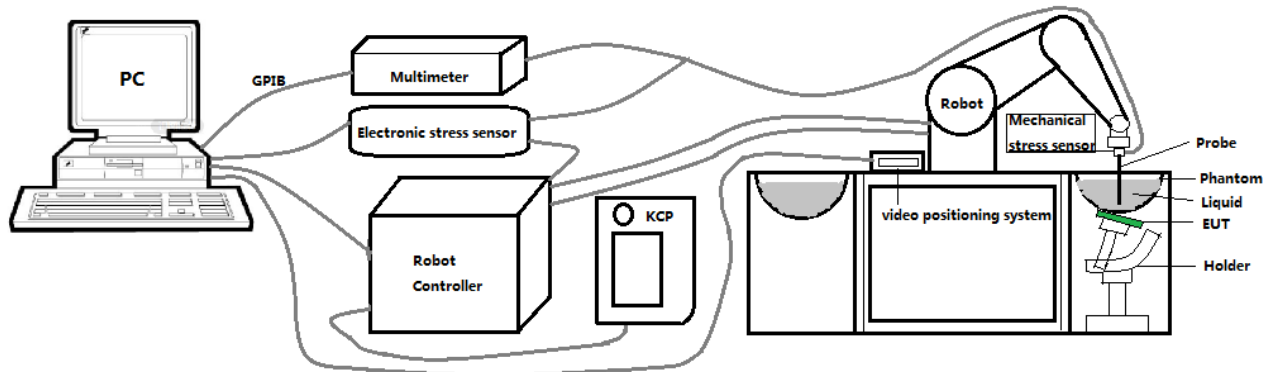

These measurements were performed with the automated near-field scanning system OPENSAR from SATIMO. The system is based on a high precision robot (working range: 901 mm), which positions the probes with a positional repeatability of better than  $\pm 0.03$  mm. The SAR measurements were conducted with dosimetric probe (manufactured by SATIMO), designed in the classical triangular configuration and optimized for dosimetric evaluation.

The first step of the field measurement is the evaluation of the voltages induced on the probe by the device under test. Probe diode detectors are nonlinear. Below the diode compression point, the output voltage is proportional to the square of the applied E-field; above the diode compression point, it is linear to the applied E-field. The compression point depends on the diode, and a calibration procedure is necessary for each sensor of the probe.

The Keithley multimeter reads the voltage of each sensor and send these three values to the PC. The corresponding E field value is calculated using the probe calibration factors, which are stored in the working directory. This evaluation includes linearization of the diode characteristics. The field calculation is done separately for each sensor. Each component of the E field is displayed on the "Dipole Area Scan Interface" and the total E field is displayed on the "3D Interface"

## 2.2. Robot

The SATIMO SAR system uses the high precision robots from KUKA. For the 6-axis controller system, the robot controller version (KUKA) from KUKA is used. The KUKA robot series have many features that are important for our application:



- High precision (repeatability  $\pm 0.03$  mm)
- High reliability (industrial design)
- Jerk-free straight movements
- Low ELF interference (the closed metallic construction shields against motor control fields)

### 2.3. E-Field Probe

This E-field detection probe is composed of three orthogonal dipoles linked to special Schottky diodes with low detection thresholds. The probe allows the measurement of electric fields in liquids such as the one defined in the IEEE and CENELEC standards.

For the measurements the Specific Dosimetric E-Field Probe SN 08/16 EPGO287 with following specifications is used



- Dynamic range: 0.01-100 W/kg
  - Tip Diameter : 2.5 mm
  - Distance between probe tip and sensor center: 1 mm
  - Distance between sensor center and the inner phantom surface: 2 mm (repeatability better than  $\pm 1$  mm).
  - Probe linearity:  $\pm 0.08$  dB
  - Axial isotropy:  $\pm 0.01$  dB
  - Hemispherical Isotropy:  $\pm 0.01$  dB
  - Calibration range: 650MHz to 5900MHz for head & body simulating liquid.
  - Lower detection limit: 8mW/kg
- Angle between probe axis (evaluation axis) and surface normal line: less than  $30^\circ$ .

#### 2.3.1. E-Field Probe Calibration

Each probe needs to be calibrated according to a dosimetric assessment procedure with accuracy better than  $\pm 10\%$ . The spherical isotropy shall be evaluated and within  $\pm 0.25$ dB. The sensitivity parameters (Norm X, Norm Y, and Norm Z), the diode compression parameter (DCP) and the conversion factor (Conv F) of the probe are tested. The calibration data can be referred to appendix D of this report.

## 2.4. SAM phantoms

Photo of SAM phantom SN 16/15 SAM119



The SAM phantom is used to measure the SAR relative to people exposed to electro-magnetic field radiated by mobile phones.

**2.4.1. Technical Data**

Serial Number	Shell thickness	Filling volume	Dimensions	Positionner Material	Permittivity	Loss Tangent
<b>SN 16/15 SAM119</b>	2 mm ±0.2 mm	27 liters	Length:1000 mm Width:500 mm Height:200 mm	Gelcoat with fiberglass	3.4	0.02

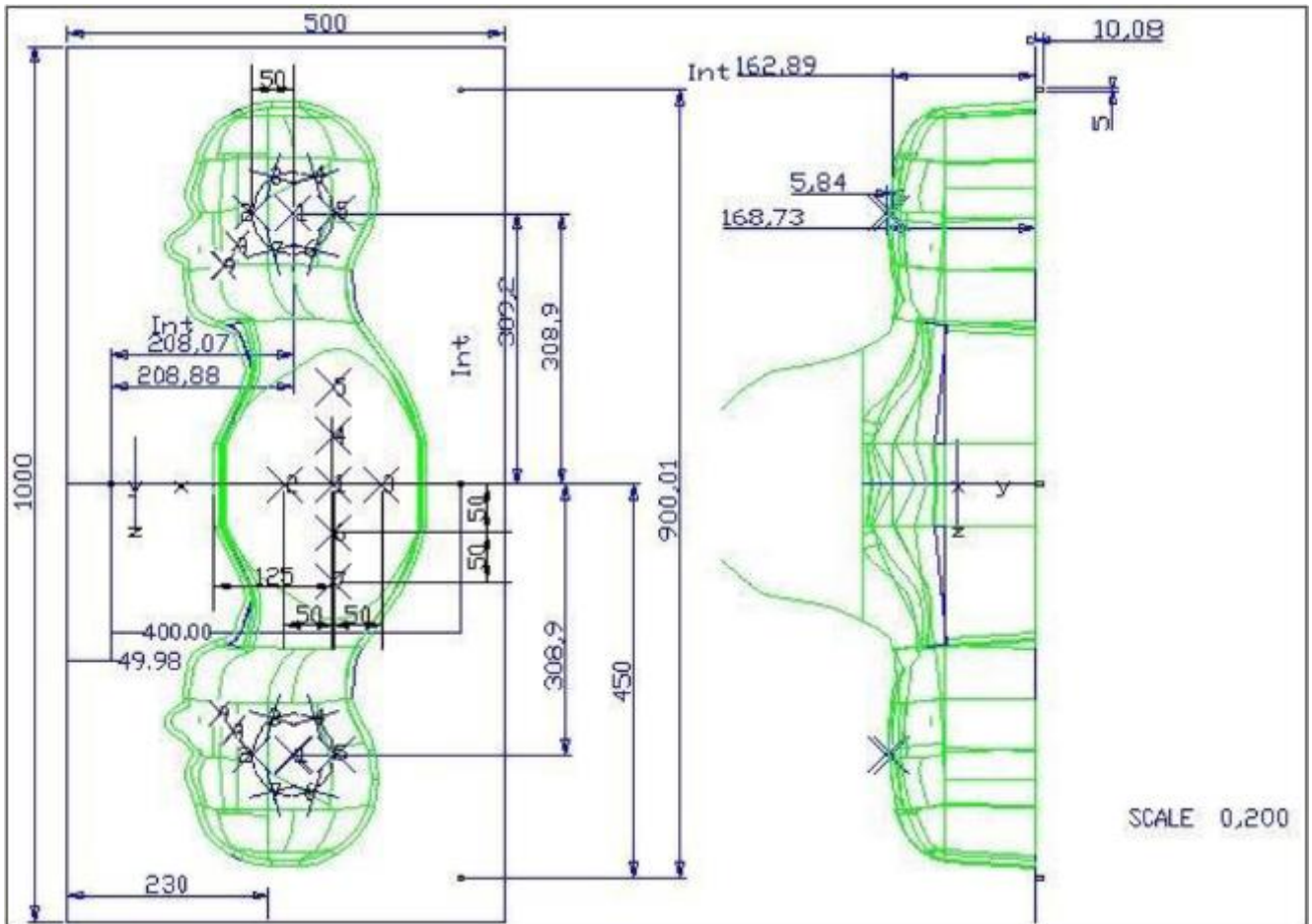

Serial Number	Left Head(mm)		Right Head(mm)		Flat Part(mm)	
	1	2	1	2	1	2
<b>SN 16/15 SAM119</b>	2	2.02	2	2.08	1	2.09
	3	2.05	3	2.06	2	2.06
	4	2.07	4	2.07	3	2.08
	5	2.08	5	2.08	4	2.10
	6	2.05	6	2.07	5	2.10
	7	2.05	7	2.05	6	2.07
	8	2.07	8	2.06	7	2.07
	9	2.08	9	2.06	-	-

The test, based on ultrasonic system, allows measuring the thickness with an accuracy of 10 µm.

## 2.5. Device Holder

The positioning system allows obtaining cheek and tilting position with a very good accuracy. In compliance with CENELEC, the tilt angle uncertainty is lower than 1 degree.

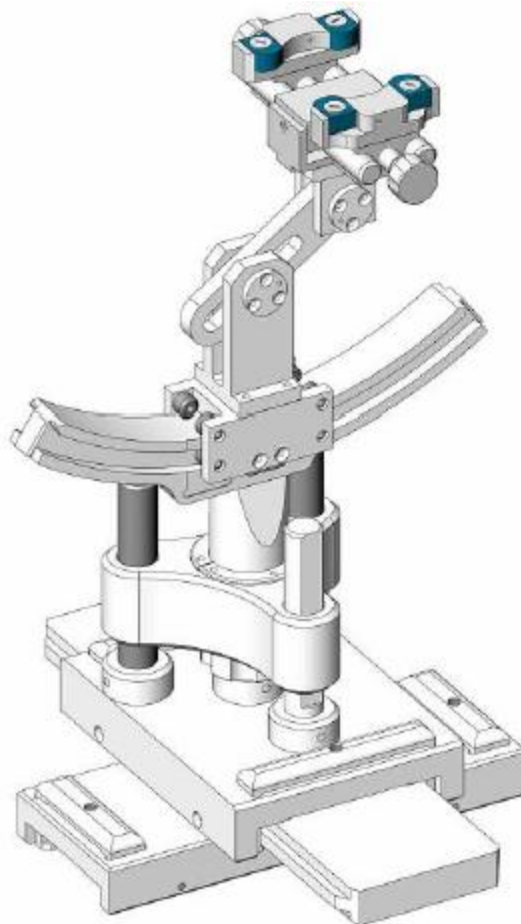

Serial Number	Holder Material	Permittivity	Loss Tangent
SN 16/15 MSH100	Delrin	3.7	0.005

## 2.6. Test Equipment List

This table gives a complete overview of the SAR measurement equipment.

Devices used during the test described are marked

	Manufacturer	Name of Equipment	Type/Model	Serial Number	Calibration	
					Last Cal.	Due Date
<input checked="" type="checkbox"/>	MVG	E FIELD PROBE	SSE2	SN 08/16 EPGO287	Feb. 01, 2022	Jan. 31, 2023
<input checked="" type="checkbox"/>	MVG	750 MHz Dipole	SID750	SN 03/15 DIP 0G750-355	Mar. 01, 2021	Feb. 28, 2024
<input checked="" type="checkbox"/>	MVG	835 MHz Dipole	SID835	SN 03/15 DIP 0G835-347	Mar. 01, 2021	Feb. 28, 2024
<input type="checkbox"/>	MVG	900 MHz Dipole	SID900	SN 03/15 DIP 0G900-348	Mar. 01, 2021	Feb. 28, 2024
<input checked="" type="checkbox"/>	MVG	1800 MHz Dipole	SID1800	SN 03/15 DIP 1G800-349	Mar. 01, 2021	Feb. 28, 2024
<input checked="" type="checkbox"/>	MVG	1900 MHz Dipole	SID1900	SN 03/15 DIP 1G900-350	Mar. 01, 2021	Feb. 28, 2024
<input type="checkbox"/>	MVG	2000 MHz Dipole	SID2000	SN 03/15 DIP 2G000-351	Mar. 01, 2021	Feb. 28, 2024
<input type="checkbox"/>	MVG	2300 MHz Dipole	SID2300	SN 03/16 DIP 2G300-358	Mar. 01, 2021	Feb. 28, 2024
<input checked="" type="checkbox"/>	MVG	2450 MHz Dipole	SID2450	SN 03/15 DIP 2G450-352	Mar. 01, 2021	Feb. 28, 2024
<input checked="" type="checkbox"/>	MVG	2600 MHz Dipole	SID2600	SN 03/15 DIP 2G600-356	Mar. 01, 2021	Feb. 28, 2024
<input checked="" type="checkbox"/>	MVG	5000 MHz Dipole	SWG5500	SN 13/14 WGA 33	Mar. 01, 2021	Feb. 28, 2024
<input checked="" type="checkbox"/>	MVG	Liquid measurement Kit	SCLMP	SN 21/15 OCPG 72	NCR	NCR
<input checked="" type="checkbox"/>	MVG	Power Amplifier	N.A	AMPLISAR_28/14_003	NCR	NCR
<input checked="" type="checkbox"/>	KEITHLEY	Millivoltmeter	2000	4072790	NCR	NCR
<input checked="" type="checkbox"/>	R&S	Universal radio communication tester	CMU200	117858	Jun. 17, 2022	Jun. 16, 2023
<input checked="" type="checkbox"/>	R&S	Wideband radio communication tester	CMW500	103917	Jun. 17, 2022	Jun. 16, 2023
<input checked="" type="checkbox"/>	HP	Network Analyzer	8753D	3410J01136	Jun. 17, 2022	Jun. 16, 2023



<input checked="" type="checkbox"/>	Agilent	MXG Vector Signal Generator	N5182A	MY47070317	Jun. 16, 2022	Jun. 15, 2023
<input checked="" type="checkbox"/>	Agilent	Power meter	E4419B	MY45102538	Jun. 17, 2022	Jun. 16, 2023
<input checked="" type="checkbox"/>	Agilent	Power sensor	E9301A	MY41495644	Jun. 17, 2022	Jun. 16, 2023
<input checked="" type="checkbox"/>	Agilent	Power sensor	E9301A	US39212148	Jun. 17, 2022	Jun. 16, 2023
<input checked="" type="checkbox"/>	MCLI/USA	Directional Coupler	CB11-20	0D2L51502	Jul. 17, 2020	Jul. 16, 2023

### 3. SAR Measurement Procedures

The measurement procedures are as follows:

<Conducted power measurement>

- (a) For WWAN power measurement, use base station simulator to configure EUT WWAN transmission in conducted connection with RF cable, at maximum power in each supported wireless interface and frequency band.
- (b) Read the WWAN RF power level from the base station simulator.
- (c) For WLAN/Bluetooth power measurement, use engineering software to configure EUT WLAN/Bluetooth continuously transmission, at maximum RF power in each supported wireless interface and frequency band.
- (d) Connect EUT RF port through RF cable to the power meter, and measure WLAN/Bluetooth output power.

<SAR measurement>

- (a) Use base station simulator to configure EUT WWAN transmission in radiated connection, and engineering software to configure EUT WLAN/Bluetooth continuously transmission, at maximum RF power, in the highest power channel.
- (b) Place the EUT in the positions as Appendix A demonstrates.
- (c) Set scan area, grid size and other setting on the OPENSAR software.
- (d) Measure SAR results for the highest power channel on each testing position.
- (e) Find out the largest SAR result on these testing positions of each band.
- (f) Measure SAR results for other channels in worst SAR testing position if the reported SAR of highest power channel is larger than 0.8 W/kg.

According to the test standard, the recommended procedure for assessing the peak spatial-average SAR value consists of the following steps:

- (a) Power reference measurement
- (b) Area scan
- (c) Zoom scan
- (d) Power drift measurement

#### 3.1. Power Reference

The Power Reference Measurement and Power Drift Measurements are for monitoring the power drift of the device under test in the batch process. The minimum distance of probe sensors to surface determines the closest measurement point to phantom surface. This distance cannot be smaller than the distance of sensor calibration points to probe tip as defined in the probe properties.

#### 3.2. Area scan & Zoom scan

The area scan is a 2D scan to find the hot spot location on the DUT. The zoom scan is a 3D scan above the hot spot to calculate the 1g and 10g SAR value.

Measurement of the SAR distribution with a grid of 8 to 16 mm \* 8 to 16 mm and a constant distance to the inner surface of the phantom. Since the sensors cannot directly measure at the inner phantom surface, the values between the sensors and the inner phantom surface are extrapolated. With these values the area of the maximum SAR is calculated by an interpolation scheme. Around this point, a cube of 30 \* 30 \* 30 mm or 32 \* 32 \* 32 mm is assessed by measuring 5 or 8 \* 5 or 8 \* 4 or 5 mm. With these data, the peak spatial-average SAR value can be calculated.

From the scanned SAR distribution, identify the position of the maximum SAR value, in addition identify the positions of any local maxima with SAR values within 2 dB of the maximum value that will not be within the zoom scan of other peaks; additional peaks shall be measured only when the primary peak is within 2 dB of the SAR compliance limit (e.g., 1 W/kg for 1,6 W/kg 1 g limit, or 1,26 W/kg for 2 W/kg, 10 g limit).

Area scan & Zoom scan scan parameters extracted from FCC KDB 865664 D01 SAR measurement 100 MHz to 6 GHz.

		≤ 3 GHz	> 3 GHz	
Maximum distance from closest measurement point (geometric center of probe sensors) to phantom surface		5 ± 1 mm	½·δ·ln(2) ± 0.5 mm	
Maximum probe angle from probe axis to phantom surface normal at the measurement location		30° ± 1°	20° ± 1°	
Maximum area scan spatial resolution: Δx <sub>Area</sub> , Δy <sub>Area</sub>		≤ 2 GHz: ≤ 15 mm 2 – 3 GHz: ≤ 12 mm	3 – 4 GHz: ≤ 12 mm 4 – 6 GHz: ≤ 10 mm	
		When the x or y dimension of the test device, in the measurement plane orientation, is smaller than the above, the measurement resolution must be ≤ the corresponding x or y dimension of the test device with at least one measurement point on the test device.		
Maximum zoom scan spatial resolution: Δx <sub>Zoom</sub> , Δy <sub>Zoom</sub>		≤ 2 GHz: ≤ 8 mm 2 – 3 GHz: ≤ 5 mm*	3 – 4 GHz: ≤ 5 mm* 4 – 6 GHz: ≤ 4 mm*	
Maximum zoom scan spatial resolution, normal to phantom surface	uniform grid: Δz <sub>Zoom</sub> (n)	≤ 5 mm	3 – 4 GHz: ≤ 4 mm 4 – 5 GHz: ≤ 3 mm 5 – 6 GHz: ≤ 2 mm	
	graded grid	Δz <sub>Zoom</sub> (1): between 1 <sup>st</sup> two points closest to phantom surface	≤ 4 mm	3 – 4 GHz: ≤ 3 mm 4 – 5 GHz: ≤ 2.5 mm 5 – 6 GHz: ≤ 2 mm
		Δz <sub>Zoom</sub> (n>1): between subsequent points	≤ 1.5·Δz <sub>Zoom</sub> (n-1)	
Minimum zoom scan volume	x, y, z	≥ 30 mm	3 – 4 GHz: ≥ 28 mm 4 – 5 GHz: ≥ 25 mm 5 – 6 GHz: ≥ 22 mm	

Note: δ is the penetration depth of a plane-wave at normal incidence to the tissue medium; see draft standard IEEE P1528-2011 for details.

\* When zoom scan is required and the *reported* SAR from the *area scan based 1-g SAR estimation* procedures of KDB 447498 is ≤ 1.4 W/kg, ≤ 8 mm, ≤ 7 mm and ≤ 5 mm zoom scan resolution may be applied, respectively, for 2 GHz to 3 GHz, 3 GHz to 4 GHz and 4 GHz to 6 GHz.

### 3.3. Description of interpolation/extrapolation scheme

The local SAR inside the phantom is measured using small dipole sensing elements inside a probe body. The probe tip must not be in contact with the phantom surface in order to minimise measurements errors, but the highest local SAR will occur at the surface of the phantom.

An extrapolation is used to determine these highest local SAR values. The extrapolation is based on a fourth-order least-square polynomial fit of measured data. The local SAR value is then extrapolated from the liquid surface with a 1 mm step.

The measurements have to be performed over a limited time (due to the duration of the battery) so the step of measurement is high. It could vary between 5 and 8 mm. To obtain an accurate assessment of the maximum SAR averaged over 10 grams and 1 gram requires a very fine resolution in the three dimensional scanned data array.

### 3.4. Volumetric Scan

The volumetric scan consists of a full 3D scan over a specific area. This 3D scan is useful for multi Tx SAR measurement. Indeed, it is possible with OpenSAR to add, point by point, several volumetric scans to calculate the SAR value of the combined measurement as it is defined in the standard IEEE1528 and IEC62209.

### 3.5. Power Drift

All SAR testing is under the EUT installed with a full charged battery and transmit maximum output power. In OpenSAR measurement software, the power reference measurement and power drift measurement procedures are used for monitoring the power drift of EUT during SAR test. Both these procedures measure the field at a specified reference position before and after the SAR testing. The software will calculate the field difference in V/m. If the power drifts more than  $\pm 5\%$ , the SAR will be retested.

## 4. System Verification Procedure

### 4.1. Tissue Verification

The following tissue formulations are provided for reference only as some of the parameters have not been thoroughly verified. The composition of ingredients may be modified accordingly to achieve the desired target tissue parameters required for routine SAR evaluation.

Ingredients (% of weight)	Head Tissue									
	750	835	900	1800	1900	2000	2450	2600	5200	5800
Frequency Band (MHz)										
Water	34.40	34.40	34.40	55.36	55.36	57.87	57.87	57.87	65.53	65.53
NaCl	0.79	0.79	0.79	0.35	0.35	0.16	0.16	0.16	0.00	0.00
1,2-Propanediol	64.81	64.81	64.81	0.00	0.00	0.00	0.00	0.00	0.00	0.00
Triton X-100	0.00	0.00	0.00	30.45	30.45	19.97	19.97	19.97	24.24	24.24
DGBE	0.00	0.00	0.00	13.84	13.84	22.00	22.00	22.00	10.23	10.23
Ingredients (% of weight)	Body Tissue									
	750	835	900	1800	1900	2000	2450	2600	5200	5800
Frequency Band (MHz)										
Water	50.30	50.30	50.30	69.91	69.91	71.88	71.88	71.88	79.54	79.54
NaCl	0.60	0.60	0.60	0.13	0.13	0.16	0.16	0.16	0.00	0.00
1,2-Propanediol	49.10	49.10	49.10	0.00	0.00	0.00	0.00	0.00	0.00	0.00
Triton X-100	0.00	0.00	0.00	9.99	9.99	19.97	19.97	19.97	11.24	11.24
DGBE	0.00	0.00	0.00	19.97	19.97	7.99	7.99	7.99	9.22	9.22

For SAR measurement of the field distribution inside the phantom, the phantom must be filled with homogeneous tissue simulating liquid to a depth of at least 15 cm. For head SAR testing, the liquid depth from the ear reference point (ERP) of the phantom to the liquid top surface is larger than 15 cm.

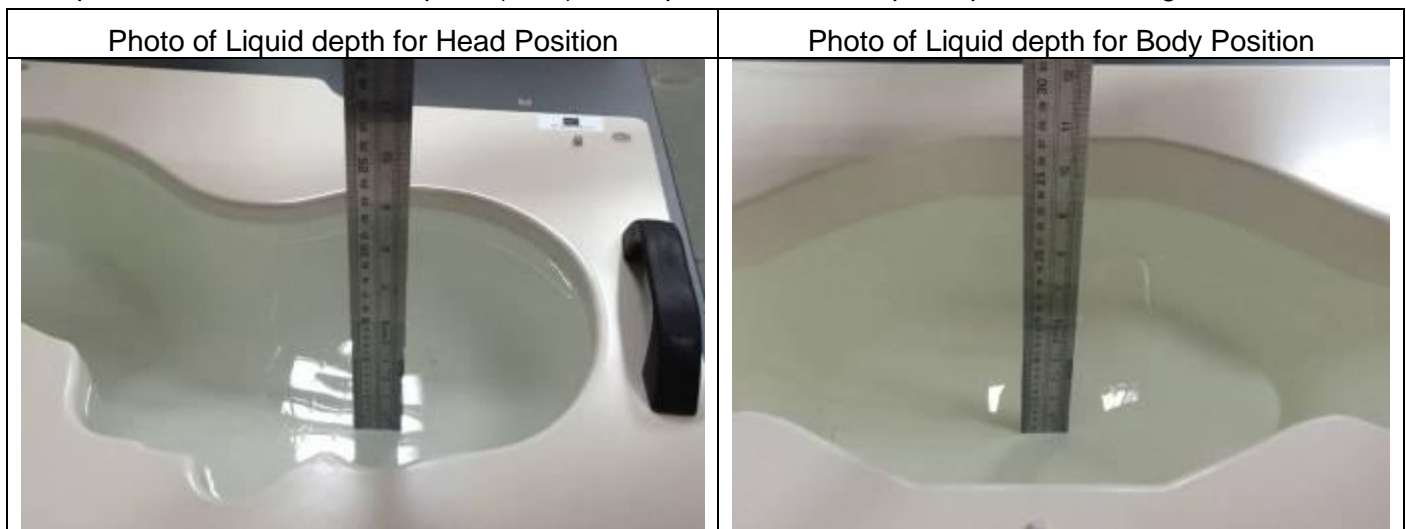

#### 4.1.1. Tissue Dielectric Parameter Check Results

The simulating liquids should be checked at the beginning of a series of SAR measurements to determine if the dielectric parameters are within the tolerances of the specified target values. The measured conductivity and relative permittivity should be within  $\pm 5\%$  of the target values.

Tissue Type	Measured Frequency (MHz)	Target Tissue		Measured Tissue		Liquid Temp.	Test Date
		$\epsilon_r$ ( $\pm 5\%$ )	$\sigma$ (S/m) ( $\pm 5\%$ )	$\epsilon_r$	$\sigma$ (S/m)		
Head 750	750	41.96 (39.86~44.06)	0.89 (0.85~0.93)	40.13	0.89	21.3 °C	Sep. 20, 2022
Head 850	835	41.50 (39.43~43.58)	0.90 (0.86~0.95)	41.37	0.92	21.5 °C	Sep. 23, 2022
Head 1800	1800	40.00 (38.00~42.00)	1.40 (1.33~1.47)	38.68	1.38	21.5 °C	Sep. 21, 2022
Head 1900	1900	40.00 (38.00~42.00)	1.40 (1.33~1.47)	38.35	1.45	21.2 °C	Oct. 08, 2022
Head 2450	2450	39.20 (37.24~41.16)	1.80 (1.71~1.89)	37.79	1.77	21.6 °C	Sep. 24, 2022
Head 2600	2600	39.01 (37.06~40.96)	1.96 (1.86~2.06)	37.69	1.91	21.2 °C	Sep. 22, 2022
Head 5200	5200	36.00 (34.20~37.80)	4.66 (4.43~4.89)	35.12	4.54	21.2 °C	Sep. 29, 2022
Head 5800	5800	35.30 (33.54~37.07)	5.27 (5.01~5.53)	34.32	5.15	21.4 °C	Sep. 30, 2022

NOTE: The dielectric parameters of the tissue-equivalent liquid should be measured under similar ambient conditions and within 2 °C of the conditions expected during the SAR evaluation to satisfy protocol requirements.

### 4.2. System Verification Procedure

The system verification is performed for verifying the accuracy of the complete measurement system and performance of the software. The dipole is connected to the signal source consisting of signal generator and amplifier via a directional coupler, N-connector cable and adaption to SMA. It is fed with a power of 100mW (below 5GHz) or 100mW (above 5GHz). To adjust this power a power meter is used. The power sensor is connected to the cable before the system verification to measure the power at this point and do adjustments at the signal generator. At the outputs of the directional coupler both return loss as well as forward power are controlled during the system verification to make sure that emitted power at the dipole is kept constant. This can also be checked by the power drift measurement after the test (result on plot).

The system verification is shown as below picture:

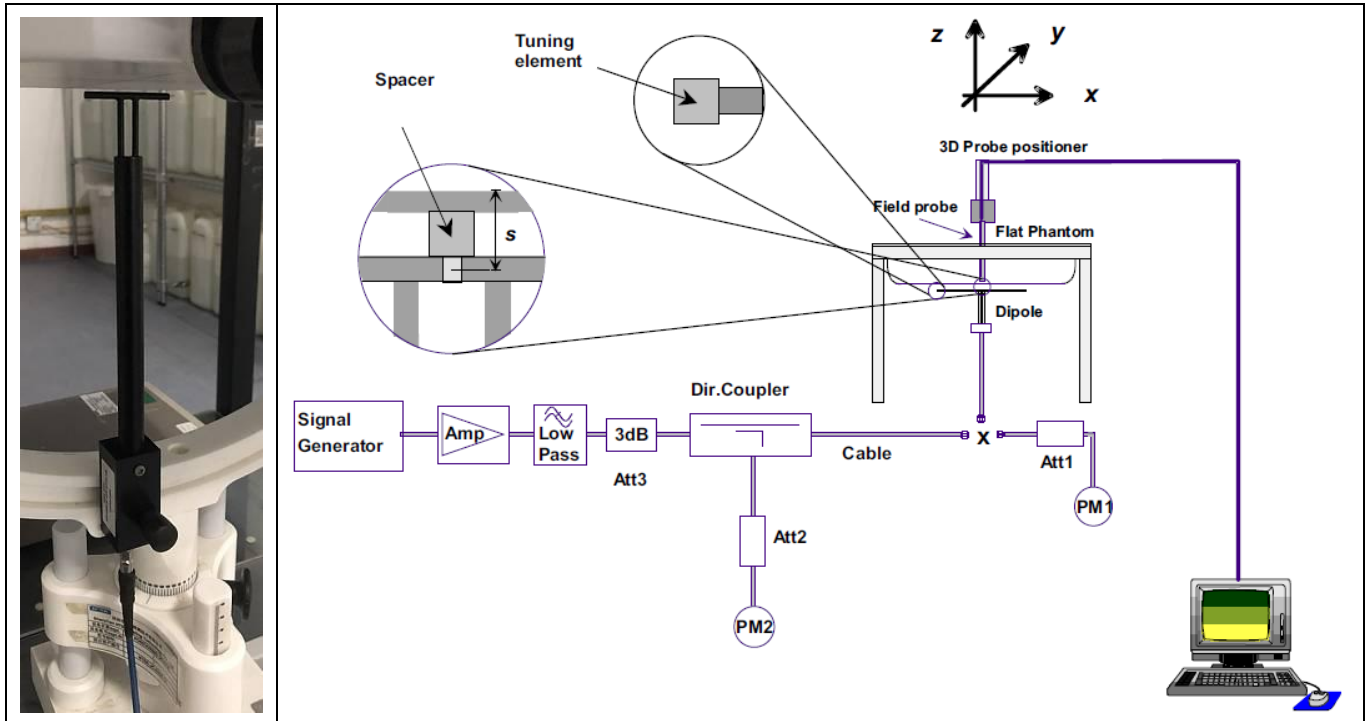

#### 4.2.1. System Verification Results

Comparing to the original SAR value provided by SATIMO, the verification data should be within its specification of  $\pm 10\%$ . Below table shows the target SAR and measured SAR after normalized to 1W input power. The table below indicates the system performance verification can meet the variation criterion and the plots can be referred to Appendix B of this report.

System Verification	Target SAR (1W) ( $\pm 10\%$ )		Measured SAR (Normalized to 1W)		Liquid Temp.	Test Date
	1-g (W/Kg)	10-g (W/Kg)	1-g (W/Kg)	10-g (W/Kg)		
750MHz	8.53 (7.68~9.38)	5.56 (5.01~6.11)	8.00	5.94	21.3 °C	Sep. 20, 2022
835MHz	9.84 (8.86~10.82)	6.22 (5.60~6.84)	10.29	6.41	21.5 °C	Sep. 23, 2022
1800MHz	37.96 (34.17~41.75)	19.81 (17.83~21.79)	34.52	18.74	21.5 °C	Sep. 21, 2022
1900MHz	40.37 (36.34~44.40)	20.48 (18.44~22.52)	40.33	19.43	21.2 °C	Oct. 08, 2022
2450MHz	53.69 (48.33~59.05)	23.94 (21.55~26.33)	50.04	25.30	21.6 °C	Sep. 24, 2022
2600MHz	55.83 (50.25~61.41)	24.19 (21.78~26.60)	57.53	23.40	21.2 °C	Sep. 22, 2022
5200MHz	162.34 (146.11~178.57)	55.42 (49.88~60.96)	155.56	55.38	21.2 °C	Sep. 29, 2022
5800MHz	178.89 (161.01~196.77)	59.32 (53.39~65.25)	189.92	58.10	21.4 °C	Sep. 30, 2022



## 5. SAR Measurement variability and uncertainty

### 5.1. SAR measurement variability

Per KDB865664 D01 SAR measurement 100 MHz to 6 GHz, SAR measurement variability must be assessed for each frequency band, which is determined by the SAR probe calibration point and tissue-equivalent medium used for the device measurements. The additional measurements are repeated after the completion of all measurements requiring the same head or body tissue-equivalent medium in a frequency band. The test device should be returned to ambient conditions (normal room temperature) with the battery fully charged before it is re-mounted on the device holder for the repeated measurement(s) to minimize any unexpected variations in the repeated results.

- 1) Repeated measurement is not required when the original highest measured SAR is  $< 0.80$  W/kg; steps 2) through 4) do not apply.
- 2) When the original highest measured SAR is  $\geq 0.80$  W/kg, repeat that measurement once.
- 3) Perform a second repeated measurement only if the ratio of largest to smallest SAR for the original and first repeated measurements is  $> 1.20$  or when the original or repeated measurement is  $\geq 1.45$  W/kg (~ 10% from the 1-g SAR limit).
- 4) Perform a third repeated measurement only if the original, first or second repeated measurement is  $\geq 1.5$  W/kg and the ratio of largest to smallest SAR for the original, first and second repeated measurements is  $> 1.20$ .

### 5.2. SAR measurement uncertainty

Per KDB865664 D01 SAR Measurement 100 MHz to 6 GHz, when the highest measured 1-g SAR within a frequency band is  $< 1.5$  W/kg, the extensive SAR measurement uncertainty analysis described in IEEE Std 1528-2013 is not required in SAR reports submitted for equipment approval. The equivalent ratio (1.5/1.6) is applied to extremity and occupational exposure conditions.

## 6. RF Exposure Positions

### 6.1. Tablet host platform exposure conditions

Refer to KDB616217 D04, when the modular approach is used, transmitters and modules must be initially tested for standalone operations in generic host conditions according to the following minimum test separation distance and antenna installation requirements for incorporation in the tablet platform. The separation distance required for incorporation in qualified hosts is described in KDB 447498; item 5) of section 4.1 and item 1) of section 5.2.2 etc.

- $\leq 5$  mm between the antenna and user for both back surface and edge exposure conditions
- the antennas used by the host must have been tested for equipment approval or qualify for SAR test exclusion
- the antenna polarization, physical orientation, rotation and installation configurations used by the host must have been tested for compliance or qualify for test exclusion
- when the *SAR Test Exclusion Threshold* in KDB 447498 applies, a *test separation distance* of 5 mm is required to determine test exclusion for the tablet platform

The antennas embedded in tablets are typically  $\leq 5$ mm from the outer housing. The required antenna to user test separation distance is a “not to exceed test” distance required to apply the modular approach. Instead of the typical zero gap tablet edge test requirement between the edge of a tablet and the user, when an antenna has been tested at  $\leq 5$  mm according to the modular approach it can be incorporated into tablets with at least twice the tested distance from the outer housing of the tablet edge; otherwise, the tablet edge zero gap test requirement applies. When the dedicated host approach is applied, the back surface and edges of the tablet should be tested for SAR compliance with the tablet touching the phantom.

## 7. RF Output Power

### 7.1. GSM Conducted Power

Band GSM850		Burst-Averaged output Power (dBm)			Frame-Averaged output Power (dBm)			
Tx Channel	Tune - up (dBm)	128	189	251	Tune -	128	189	251
Frequency (MHz)		824.2	836.4	848.8	up (dBm)	824.2	836.4	848.8
GSM (GMSK)	33.00	32.44	32.54	32.33	23.97	23.41	23.51	23.30
GPRS(GMSK, 1 TS)	32.50	32.31	32.40	32.21	23.47	23.28	23.37	23.18
GPRS(GMSK, 2 TS)	32.00	31.55	31.64	31.42	25.98	25.53	25.62	25.40
GPRS(GMSK, 3 TS)	30.00	29.81	29.89	29.68	25.74	25.55	25.63	25.42
GPRS(GMSK, 4 TS)	29.00	28.71	28.75	28.56	25.99	25.70	25.74	25.55
EGPRS(8PSK, 1 TS)	25.50	25.34	25.04	24.90	16.47	16.31	16.01	15.87
EGPRS(8PSK, 2 TS)	24.50	24.37	24.20	24.35	18.48	18.35	18.18	18.33
EGPRS(8PSK, 3 TS)	22.50	21.59	21.47	22.02	18.24	17.33	17.21	17.76
EGPRS(8PSK, 4 TS)	21.00	20.61	20.67	20.36	17.99	17.60	17.66	17.35
Band GSM1900		Burst-Averaged output Power (dBm)			Frame-Averaged output Power (dBm)			
Tx Channel	Tune - up (dBm)	512	661	810	Tune -	512	661	810
Frequency (MHz)		1850.2	1880	1909.8	up (dBm)	1850.2	1880	1909.8
GSM (GMSK)	29.50	29.24	29.11	28.90	20.47	20.21	20.08	19.87
GPRS(GMSK, 1 TS)	29.50	29.17	29.08	28.85	20.47	20.14	20.05	19.82
GPRS(GMSK, 2 TS)	28.50	28.44	28.33	28.14	22.48	22.42	22.31	22.12
GPRS(GMSK, 3 TS)	27.00	26.69	26.60	26.44	22.74	22.43	22.34	22.18
GPRS(GMSK, 4 TS)	26.00	25.56	25.50	25.34	22.99	22.55	22.49	22.33
EGPRS(8PSK, 1 TS)	25.50	24.95	24.91	25.24	16.47	15.92	15.88	16.21
EGPRS(8PSK, 2 TS)	25.00	24.23	24.44	24.67	18.98	18.21	18.42	18.65
EGPRS(8PSK, 3 TS)	22.50	22.27	22.23	22.29	18.24	18.01	17.97	18.03
EGPRS(8PSK, 4 TS)	21.50	20.86	21.10	21.46	18.49	17.85	18.09	18.45

Note: The frame-averaged power is linearly scaled the maximum burst averaged power over 8 time slots. The calculated method are shown as below:

Frame-averaged power = Maximum burst averaged power (1 Tx Slot) - 9.03 dB

Frame-averaged power = Maximum burst averaged power (2 Tx Slots) - 6.02 dB

Frame-averaged power = Maximum burst averaged power (3 Tx Slots) - 4.26 dB

Frame-averaged power = Maximum burst averaged power (4 Tx Slots) - 3.01 dB

### 7.2. WCDMA Conducted Power

WCDMA Band 2		Burst-Averaged output Power (dBm)			
Tx Channel	Tune-up (dBm)	9262	9400	9538	
Frequency (MHz)		1852.4	1880	1907.6	
RMC12.2K	23.50	22.93	23.04	23.07	
HSDPA Sub 1	22.50	21.80	22.09	22.09	
HSDPA Sub 2	22.00	21.49	21.53	21.61	
HSDPA Sub 3	21.00	20.30	20.56	20.48	
HSDPA Sub 4	21.00	20.58	20.72	20.82	
HSUPA Sub 1	22.00	21.08	21.89	21.89	
HSUPA Sub 2	22.00	21.86	22.00	21.92	
HSUPA Sub 3	21.00	20.34	20.82	20.87	
HSUPA Sub 4	22.50	21.98	22.08	22.11	
HSUPA Sub 5	21.50	20.59	21.12	21.40	
WCDMA Band 4		Burst-Averaged output Power (dBm)			
Tx Channel	Tune-up (dBm)	1312	1413	1513	
Frequency (MHz)		1712.4	1732.6	1752.6	
RMC12.2K	23.00	22.71	22.70	22.76	
HSDPA Sub 1	22.00	21.74	21.72	21.84	
HSDPA Sub 2	21.50	21.39	21.30	21.45	
HSDPA Sub 3	20.50	20.38	20.40	20.49	
HSDPA Sub 4	21.00	20.18	20.00	20.54	
HSUPA Sub 1	22.00	20.57	21.48	21.57	
HSUPA Sub 2	22.00	21.68	21.64	21.67	
HSUPA Sub 3	21.00	20.17	20.46	20.62	
HSUPA Sub 4	22.00	21.77	21.73	21.80	
HSUPA Sub 5	21.50	20.33	21.07	21.15	
WCDMA Band 5		Burst-Averaged output Power (dBm)			
Tx Channel	Tune-up (dBm)	4132	4182	4233	
Frequency (MHz)		826.4	836.4	846.6	
RMC12.2K	23.00	22.69	22.63	22.62	
HSDPA Sub 1	22.00	21.69	21.67	21.65	
HSDPA Sub 2	21.50	21.03	21.20	21.15	
HSDPA Sub 3	20.50	20.37	19.84	20.25	
HSDPA Sub 4	20.50	20.25	20.15	20.08	
HSUPA Sub 1	21.50	20.62	21.49	21.46	

HSUPA Sub 2	22.00	21.60	21.45	21.56
HSUPA Sub 3	20.50	19.79	20.39	20.25
HSUPA Sub 4	22.00	21.69	21.67	21.63
HSUPA Sub 5	21.50	20.15	21.05	20.92

### 7.3. LTE Conducted Power

Band	Band Width	Modulation	RB Configuration		Tune-up	Channel/Frequency(MHz)		
			RB Size	RB Offset		18607/1850.7	18900/1880	19193/1909.3
LTE Band 2	1.4MHz	QPSK	1	0	25.50	24.50	24.84	24.94
			1	2	25.50	24.63	24.99	25.08
			1	5	25.50	24.51	24.83	24.92
			3	0	25.50	24.64	24.94	25.05
			3	1	25.50	24.65	24.96	25.05
			3	2	25.50	24.64	24.93	25.03
		16QAM	6	0	24.50	23.67	23.96	24.12
			1	0	24.50	23.89	24.15	24.21
			1	2	24.50	23.85	24.35	24.29
			1	5	24.50	23.88	24.08	24.25
			3	0	24.50	23.65	23.96	24.07
			3	1	24.50	23.69	24.03	24.08
			3	2	24.50	23.60	23.95	24.02
			6	0	23.50	22.72	23.08	23.19
Band	Band Width	Modulation	RB Configuration		Tune-up	Channel/Frequency(MHz)		
			RB Size	RB Offset		18615/1851.5	18900/1880	19185/1908.5
LTE Band 2	3MHz	QPSK	1	0	25.50	24.55	24.88	25.01
			1	7	25.50	24.56	24.89	24.97
			1	14	25.50	24.54	24.88	24.97
			8	0	24.50	23.61	23.92	24.12
			8	4	24.50	23.64	23.97	24.10
			8	7	24.50	23.60	23.92	24.07
			15	0	24.50	23.62	23.93	24.11
		16QAM	1	0	24.50	23.85	24.25	24.36
			1	7	24.50	23.86	24.18	24.25
			1	14	24.50	23.85	24.17	24.23
			8	0	23.50	22.69	22.99	23.17

			8	4	23.50	22.71	23.02	23.17
			8	7	23.50	22.68	23.00	23.12
			15	0	23.50	22.63	22.96	23.11
Band	Band Width	Modulation	RB Configuration		Tune-up	Channel/Frequency(MHz)		
			RB Size	RB Offset		18625/1852.5	18900/1880	19175/1907.5
LTE Band 2	5MHz	QPSK	1	0	25.50	24.52	24.77	24.93
			1	12	25.50	24.57	24.90	25.02
			1	24	25.50	24.43	24.77	24.85
			12	0	24.50	23.62	23.93	24.09
			12	6	24.50	23.68	24.00	24.16
			12	11	24.50	23.62	23.94	24.06
		16QAM	25	0	24.50	23.62	23.94	24.10
			1	0	24.50	23.86	24.06	24.17
			1	12	24.50	23.77	24.20	24.23
			1	24	24.50	23.82	24.01	24.19
			12	0	23.50	22.60	22.90	23.05
			12	6	23.50	22.67	22.99	23.17
			12	11	23.50	22.59	22.94	23.04
25	0	23.50	22.62	22.93	23.08			
Band	Band Width	Modulation	RB Configuration		Tune-up	Channel/Frequency(MHz)		
			RB Size	RB Offset		18650/1855	18900/1880	19150/1905
LTE Band 2	10MHz	QPSK	1	0	25.50	24.55	24.85	24.96
			1	24	25.50	24.67	24.99	25.18
			1	49	25.50	24.52	24.83	24.96
			25	0	24.50	23.66	23.95	24.12
			25	12	24.50	23.66	24.01	24.18
			25	24	24.50	23.62	23.98	24.18
			50	0	24.50	23.65	23.96	24.18
		16QAM	1	0	24.50	23.89	24.23	24.26
			1	24	24.50	23.90	24.31	24.44
			1	49	24.50	23.87	24.08	24.15
			25	0	23.50	22.68	22.95	23.11
			25	12	23.50	22.67	23.02	23.19
			25	24	23.50	22.61	23.00	23.17
			50	0	23.50	22.65	22.96	23.15
Band	Band	Modulation	RB		Tune-up	Channel/Frequency(MHz)		

	Width		Configuration					
			RB Size	RB Offset		18675/1857.5	18900/1880	19125/1902.5
LTE Band 2	15MHz	QPSK	1	0	25.00	24.53	24.79	24.92
			1	37	25.00	24.56	24.88	24.99
			1	74	25.00	24.56	24.76	24.90
			36	0	24.50	23.64	23.91	24.12
			36	18	24.50	23.61	23.97	24.14
			36	37	24.50	23.64	23.92	24.17
			75	0	24.50	23.64	23.91	24.14
		16QAM	1	0	24.50	23.80	24.16	24.17
			1	37	24.50	23.89	24.09	24.29
			1	74	24.50	23.89	24.06	24.21
			36	0	23.50	22.60	22.89	23.09
			36	18	23.50	22.59	22.94	23.11
			36	37	23.50	22.60	22.89	23.15
			75	0	23.50	22.62	22.89	23.12

Band	Band Width	Modulation	RB Configuration		Tune-up	Channel/Frequency(MHz)		
			RB Size	RB Offset		18700/1860	18900/1880	19100/1900

LTE Band 2	20MHz	QPSK	1	0	25.50	24.48	24.68	24.85
			1	49	25.50	24.64	24.97	25.09
			1	99	25.50	24.57	24.67	24.85
			50	0	24.50	23.64	23.84	24.15
			50	24	24.50	23.65	23.94	24.15
			50	49	24.50	23.67	23.86	24.22
			100	0	24.50	23.63	23.85	24.18
		16QAM	1	0	24.50	23.71	23.92	24.08
			1	49	24.50	23.91	24.18	24.39
			1	99	24.50	23.82	24.00	24.10
			50	0	23.50	22.65	22.83	23.13
			50	24	23.50	22.66	22.94	23.12
			50	49	23.50	22.66	22.84	23.19
			100	0	23.50	22.61	22.83	23.14

Band	Band Width	Modulation	RB Configuration		Tune-up	Channel/Frequency(MHz)		
			RB Size	RB Offset		19957/1710.7	20175/1732.5	20393/1754.3

LTE Band 4	1.4MHz	QPSK	1	0	25.00	24.43	24.62	24.64
			1	2	25.00	24.55	24.74	24.75
			1	5	25.00	24.42	24.63	24.64
			3	0	25.00	24.51	24.74	24.74
			3	1	25.00	24.54	24.77	24.76
			3	2	25.00	24.52	24.76	24.74
			6	0	24.00	23.59	23.82	23.82
		16QAM	1	0	24.50	23.73	23.78	23.89
			1	2	24.50	23.77	23.96	24.02
			1	5	24.50	23.76	23.85	23.99
			3	0	24.00	23.56	23.73	23.77
			3	1	24.00	23.50	23.71	23.80
			3	2	24.00	23.53	23.72	23.79
			6	0	23.00	22.67	22.87	22.93
Band	Band Width	Modulation	RB Configuration		Tune-up	Channel/Frequency(MHz)		
			RB Size	RB Offset		19965/1711.5	20175/1732.5	20385/1753.5
LTE Band 4	3MHz	QPSK	1	0	25.00	24.49	24.70	24.67
			1	7	25.00	24.49	24.67	24.71
			1	14	25.00	24.50	24.68	24.71
			8	0	24.00	23.56	23.80	23.80
			8	4	24.00	23.60	23.83	23.83
			8	7	24.00	23.56	23.77	23.83
			15	0	24.00	23.56	23.85	23.83
		16QAM	1	0	24.50	23.76	23.97	23.97
			1	7	24.50	23.81	23.84	24.02
			1	14	24.50	23.73	23.96	24.02
			8	0	23.00	22.62	22.82	22.87
			8	4	23.00	22.65	22.87	22.89
			8	7	23.00	22.62	22.83	22.87
			15	0	23.00	22.57	22.79	22.83
Band	Band Width	Modulation	RB Configuration		Tune-up	Channel/Frequency(MHz)		
			RB Size	RB Offset		19975/1712.5	20175/1732.5	20375/1752.5
LTE Band 4	5MHz	QPSK	1	0	25.00	24.38	24.55	24.43
			1	12	25.00	24.51	24.70	24.56
			1	24	25.00	24.38	24.60	24.53
			12	0	24.00	23.57	23.80	23.68



Band	Band Width	Modulation	RB Configuration		Tune-up	Channel/Frequency(MHz)		
			RB Size	RB Offset		20000/1715	20175/1732.5	20350/1750
		16QAM	12	6	24.00	23.62	23.89	23.77
			12	11	24.00	23.60	23.81	23.75
			25	0	24.00	23.58	23.80	23.73
			1	0	24.00	23.69	23.87	23.77
			1	12	24.00	23.84	23.91	23.90
			1	24	24.00	23.64	23.80	23.73
			12	0	23.00	22.54	22.77	22.63
			12	6	23.00	22.57	22.82	22.73
			12	11	23.00	22.60	22.76	22.73
			25	0	23.00	22.57	22.80	22.72
Band	Band Width	Modulation	RB Configuration		Tune-up	Channel/Frequency(MHz)		
			RB Size	RB Offset		20025/1717.5	20175/1732.5	20325/1747.5
LTE Band 4	10MHz	QPSK	1	0	25.00	24.48	24.65	24.52
			1	24	25.00	24.65	24.80	24.69
			1	49	25.00	24.50	24.64	24.61
			25	0	24.00	23.56	23.91	23.80
			25	12	24.00	23.66	23.86	23.79
			25	24	24.00	23.74	23.84	23.84
		16QAM	50	0	24.00	23.68	23.89	23.83
			1	0	24.50	23.82	23.89	23.77
			1	24	24.50	23.96	24.07	23.87
			1	49	24.50	23.79	23.93	23.84
			25	0	23.00	22.55	22.88	22.78
			25	12	23.00	22.62	22.83	22.76
			25	24	23.00	22.74	22.83	22.80
			50	0	23.00	22.67	22.85	22.82
Band	Band Width	Modulation	RB Configuration		Tune-up	Channel/Frequency(MHz)		
			RB Size	RB Offset		20025/1717.5	20175/1732.5	20325/1747.5
LTE Band 4	15MHz	QPSK	1	0	25.00	24.43	24.61	24.48
			1	37	25.00	24.54	24.74	24.59
			1	74	25.00	24.51	24.60	24.61
			36	0	24.00	23.58	23.88	23.77
			36	18	24.00	23.67	23.87	23.78
			36	37	24.00	23.73	23.82	23.81
			75	0	24.00	23.67	23.85	23.81
		16QAM	1	0	24.00	23.72	23.89	23.73

Band	Band Width	Modulation	RB Configuration		Tune-up	Channel/Frequency(MHz)		
			RB Size	RB Offset		20050/1720	20175/1732.5	20300/1745
			1	37		24.00	23.91	23.94
			1	74	24.00	23.87	23.84	23.91
			36	0	23.00	22.55	22.85	22.72
			36	18	23.00	22.63	22.82	22.73
			36	37	23.00	22.69	22.77	22.77
			75	0	23.00	22.67	22.81	22.76
LTE Band 4	20MHz	QPSK	1	0	25.00	24.37	24.54	24.44
			1	49	25.00	24.60	24.79	24.63
			1	99	25.00	24.48	24.56	24.52
			50	0	24.00	23.48	23.88	23.90
			50	24	24.00	23.66	23.88	23.79
			50	49	24.00	23.76	23.74	23.76
			100	0	24.00	23.63	23.83	23.80
		16QAM	1	0	24.00	23.66	23.89	23.58
			1	49	24.00	23.84	23.98	23.88
			1	99	24.00	23.73	23.80	23.78
			50	0	23.00	22.47	22.83	22.86
			50	24	23.00	22.67	22.84	22.76
			50	49	23.00	22.71	22.67	22.72
			100	0	23.00	22.58	22.77	22.76

Band	Band Width	Modulation	RB Configuration		Tune-up	Channel/Frequency(MHz)		
			RB Size	RB Offset		20407/824.7	20525/836.5	20643/848.3
			1	0		24.00	23.73	23.81
LTE Band 5	1.4MHz	QPSK	1	2	24.00	23.85	23.94	23.85
			1	5	24.00	23.77	23.82	23.71
			3	0	24.00	23.83	23.89	23.84
			3	1	24.00	23.88	23.92	23.86
			3	2	24.00	23.85	23.91	23.82
			6	0	23.00	22.86	22.98	22.92
		16QAM	1	0	23.50	23.16	23.11	23.10
			1	2	23.50	23.24	23.28	23.13
			1	5	23.50	23.10	23.19	23.09
			3	0	23.00	22.89	22.92	22.88

Band	Band Width	Modulation	RB Configuration		Tune-up	Channel/Frequency(MHz)		
			RB Size	RB Offset		20415/825.5	20525/836.5	20635/847.5
			3	1	23.00	22.95	22.94	22.95
			3	2	23.00	22.87	22.98	22.85
			6	0	22.50	21.97	22.07	22.02
LTE Band 5	3MHz	QPSK	1	0	24.00	23.81	23.85	23.85
			1	7	24.00	23.80	23.87	23.79
			1	14	24.00	23.78	23.85	23.76
			8	0	23.00	22.85	22.95	22.92
			8	4	23.00	22.92	22.99	22.97
			8	7	23.00	22.86	22.96	22.90
			15	0	23.00	22.84	22.92	22.93
		16QAM	1	0	23.50	23.19	23.19	23.11
			1	7	23.50	23.20	23.12	23.19
			1	14	23.50	23.18	23.23	23.07
			8	0	22.50	21.91	22.01	21.99
			8	4	22.50	21.99	22.03	22.03
			8	7	22.50	21.94	22.01	21.96
			15	0	22.00	21.84	21.95	21.94
Band	Band Width	Modulation	RB Configuration		Tune-up	Channel/Frequency(MHz)		
			RB Size	RB Offset		20425/826.5	20525/836.5	20625/846.5
LTE Band 5	5MHz	QPSK	1	0	24.00	23.71	23.74	23.79
			1	12	24.00	23.80	23.86	23.84
			1	24	24.00	23.73	23.77	23.63
			12	0	23.00	22.86	22.97	22.99
			12	6	23.00	22.92	22.99	22.97
			12	11	23.00	22.86	22.92	22.86
			25	0	23.00	22.90	22.94	22.91
		16QAM	1	0	23.50	23.00	23.10	23.12
			1	12	23.50	23.22	23.14	23.20
			1	24	23.50	23.00	23.19	23.05
			12	0	22.00	21.88	21.95	22.00
			12	6	22.00	21.92	22.00	21.95
			12	11	22.00	21.85	21.92	21.85
			25	0	22.00	21.89	21.93	21.93
Band	Band	Modulation	RB		Tune-up	Channel/Frequency(MHz)		

	Width		Configuration					
			RB Size	RB Offset		20450/829	20525/836.5	20600/844
LTE Band 5	10MHz	QPSK	1	0	24.00	23.80	23.82	23.95
			1	24	24.00	23.92	23.98	23.93
			1	49	24.00	23.81	23.89	23.77
			25	0	23.50	22.93	22.95	23.09
			25	12	23.50	22.91	22.99	23.00
			25	24	23.50	22.99	22.93	22.84
		16QAM	50	0	23.00	22.95	22.97	22.99
			1	0	23.50	23.15	23.12	23.33
			1	24	23.50	23.29	23.15	23.23
			1	49	23.50	23.11	23.27	23.11
			25	0	22.50	21.95	21.95	22.10
			25	12	22.50	21.92	21.99	22.02
			25	24	22.50	22.00	21.99	21.90
			50	0	22.00	21.96	21.94	21.99

Band	Band Width	Modulation	RB Configuration		Tune-up	Channel/Frequency(MHz)		
			RB Size	RB Offset		20775/2502.5	21100/2535	21425/2567.5
LTE Band 7	5MHz	QPSK	1	0	25.50	25.17	25.13	25.24
			1	12	25.50	25.31	25.26	25.37
			1	24	25.50	25.22	25.16	25.25
			12	0	24.50	24.33	24.27	24.44
			12	6	24.50	24.42	24.36	24.48
			12	11	24.50	24.39	24.30	24.38
			25	0	24.50	24.37	24.29	24.44
		16QAM	1	0	25.00	24.34	24.41	24.47
			1	12	25.00	24.55	24.47	24.55
			1	24	25.00	24.52	24.41	24.46
			12	0	23.50	23.31	23.26	23.38
			12	6	23.50	23.40	23.34	23.45
			12	11	23.50	23.37	23.28	23.36
			25	0	23.50	23.37	23.31	23.39

Band	Band Width	Modulation	RB Configuration		Tune-up	Channel/Frequency(MHz)		
			RB Size	RB Offset		20800/2505	21100/2535	21400/2565

LTE Band 7	10MHz	QPSK	1	0	25.50	25.30	25.21	25.25
			1	24	25.50	25.37	25.34	25.42
			1	49	25.50	25.31	25.23	25.29
			25	0	24.50	24.43	24.33	24.43
			25	12	24.50	24.45	24.36	24.46
			25	24	24.50	24.44	24.38	24.45
			50	0	24.50	24.44	24.39	24.47
		16QAM	1	0	25.00	24.45	24.36	24.52
			1	24	25.00	24.73	24.59	24.60
			1	49	25.00	24.57	24.53	24.46
			25	0	23.50	23.42	23.30	23.39
			25	12	23.50	23.45	23.34	23.44
			25	24	23.50	23.42	23.36	23.43
			50	0	23.50	23.42	23.36	23.44
Band	Band Width	Modulation	RB Configuration		Tune-up	Channel/Frequency(MHz)		
			RB Size	RB Offset		20825/2507.5	21100/2535	21375/2562.5
LTE Band 7	15MHz	QPSK	1	0	25.50	25.24	25.16	25.16
			1	37	25.50	25.38	25.31	25.30
			1	74	25.50	25.22	25.20	25.24
			36	0	24.50	24.44	24.31	24.38
			36	18	24.50	24.48	24.36	24.44
			36	37	24.50	24.38	24.34	24.47
			75	0	24.50	24.43	24.33	24.38
		16QAM	1	0	25.00	24.47	24.37	24.32
			1	37	25.00	24.50	24.51	24.45
			1	74	25.00	24.48	24.50	24.41
			36	0	23.50	23.39	23.26	23.32
			36	18	23.50	23.42	23.34	23.38
			36	37	23.50	23.34	23.32	23.40
			75	0	23.50	23.41	23.31	23.36
Band	Band Width	Modulation	RB Configuration		Tune-up	Channel/Frequency(MHz)		
			RB Size	RB Offset		20850/2510	21100/2535	21350/2560
LTE Band 7	20MHz	QPSK	1	0	25.50	25.21	25.12	25.10
			1	49	25.50	25.40	25.37	25.33
			1	99	25.50	25.09	25.13	25.16
			50	0	24.50	24.46	24.26	24.31

			50	24	24.50	24.48	24.38	24.42
			50	49	24.50	24.26	24.29	24.43
			100	0	24.50	24.37	24.26	24.37
		16QAM	1	0	25.00	24.40	24.27	24.32
			1	49	25.00	24.67	24.51	24.59
			1	99	25.00	24.28	24.36	24.39
			50	0	23.50	23.43	23.21	23.31
			50	24	23.50	23.46	23.35	23.39
			50	49	23.50	23.27	23.30	23.42
			100	0	23.50	23.33	23.23	23.34

Band	Band Width	Modulation	RB Configuration		Tune-up	Channel/Frequency(MHz)		
			RB Size	RB Offset		23017/699.7	23095/707.5	23173/715.3
LTE Band 12	1.4MHz	QPSK	1	0	24.00	23.45	23.69	23.63
			1	2	24.00	23.72	23.79	23.71
			1	5	24.00	23.72	23.68	23.62
			3	0	24.00	23.59	23.75	23.69
			3	1	24.00	23.72	23.77	23.71
			3	2	24.00	23.76	23.79	23.72
		16QAM	6	0	23.00	22.68	22.80	22.75
			1	0	23.50	22.77	23.05	22.85
			1	2	23.50	23.05	23.12	23.05
			1	5	23.50	22.98	23.04	22.91
			3	0	23.00	22.57	22.84	22.70
			3	1	23.00	22.77	22.81	22.70
			3	2	23.00	22.77	22.78	22.68
			6	0	22.00	21.82	21.95	21.87

Band	Band Width	Modulation	RB Configuration		Tune-up	Channel/Frequency(MHz)		
			RB Size	RB Offset		23025/700.5	23095/707.5	23165/714.5
LTE Band 12	3MHz	QPSK	1	0	24.00	23.57	23.79	23.67
			1	7	24.00	23.83	23.74	23.72
			1	14	24.00	23.82	23.73	23.68
			8	0	23.00	22.72	22.80	22.74
			8	4	23.00	22.87	22.84	22.79
			8	7	23.00	22.85	22.81	22.73
			15	0	23.00	22.80	22.81	22.74

		16QAM	1	0	23.50	22.88	23.13	22.94
			1	7	23.50	23.07	23.00	23.03
			1	14	23.50	23.21	23.08	22.92
			8	0	22.00	21.87	21.89	21.86
			8	4	22.00	21.98	21.95	21.90
			8	7	22.00	21.94	21.90	21.84
			15	0	22.00	21.86	21.86	21.78
Band	Band Width	Modulation	RB Configuration		Tune-up	Channel/Frequency(MHz)		
			RB Size	RB Offset		23035/701.5	23095/707.5	23155/713.5
LTE Band 12	5MHz	QPSK	1	0	24.00	23.48	23.67	23.63
			1	12	24.00	23.86	23.78	23.71
			1	24	24.00	23.69	23.63	23.56
			12	0	23.00	22.75	22.82	22.79
			12	6	23.00	22.92	22.86	22.80
			12	11	23.00	22.85	22.83	22.63
			25	0	23.00	22.82	22.80	22.71
		16QAM	1	0	23.50	22.80	23.02	22.86
			1	12	23.50	23.10	23.10	23.06
			1	24	23.50	23.03	22.85	22.88
			12	0	22.00	21.81	21.85	21.80
			12	6	22.00	21.95	21.91	21.82
			12	11	22.00	21.88	21.86	21.68
			25	0	22.00	21.87	21.87	21.78
Band	Band Width	Modulation	RB Configuration		Tune-up	Channel/Frequency(MHz)		
			RB Size	RB Offset		23060/704	23095/707.5	23130/711
LTE Band 12	10MHz	QPSK	1	0	24.00	23.67	23.81	23.80
			1	24	24.00	23.92	23.84	23.86
			1	49	24.00	23.73	23.73	23.66
			25	0	23.00	22.86	22.90	22.78
			25	12	23.00	22.88	22.86	22.81
			25	24	23.00	22.88	22.90	22.74
			50	0	23.00	22.85	22.91	22.78
		16QAM	1	0	23.50	23.01	23.07	23.14
			1	24	23.50	23.21	23.21	23.09
			1	49	23.50	23.09	23.04	22.91
			25	0	22.00	21.93	21.96	21.83

			25	12	22.00	21.96	21.90	21.87
			25	24	22.00	21.93	21.96	21.80
			50	0	22.00	21.91	21.98	21.82

Band	Band Width	Modulation	RB Configuration		Tune-up	Channel/Frequency(MHz)		
			RB Size	RB Offset		23755/706.5	23790/710	23825/713.5
LTE Band 17	5MHz	QPSK	1	0	24.50	23.94	23.92	23.86
			1	12	24.50	24.02	24.00	23.98
			1	24	24.50	23.86	23.88	23.80
			12	0	23.50	23.07	22.98	23.00
			12	6	23.50	23.10	23.05	23.05
			12	11	23.50	23.05	23.00	22.91
		16QAM	25	0	23.50	23.05	23.02	22.95
			1	0	23.50	23.15	23.18	23.10
			1	12	23.50	23.26	23.16	23.28
			1	24	23.50	23.12	23.13	23.01
			12	0	22.50	22.08	21.99	22.00
			12	6	22.50	22.08	22.06	22.00
			12	11	22.50	22.03	22.00	21.84
			25	0	22.50	22.08	22.04	21.96

Band	Band Width	Modulation	RB Configuration		Tune-up	Channel/Frequency(MHz)		
			RB Size	RB Offset		23780/709	23790/710	23800/711

LTE Band 17	10MHz	QPSK	1	0	24.50	24.01	24.05	24.01
			1	24	24.50	24.10	24.08	24.05
			1	49	24.50	23.89	23.90	23.86
			25	0	23.50	23.07	23.05	23.01
			25	12	23.50	23.05	23.08	23.04
			25	24	23.50	23.05	23.04	22.95
			50	0	23.50	23.06	23.06	22.99
		16QAM	1	0	23.50	23.24	23.25	23.19
			1	24	23.50	23.32	23.30	23.38
			1	49	23.50	23.21	23.10	23.16
			25	0	22.50	22.10	22.06	22.01
			25	12	22.50	22.06	22.07	22.04
			25	24	22.50	22.06	22.05	21.97
			50	0	22.50	22.08	22.05	22.00



Band	Band Width	Modulation	RB Configuration		Tune-up	Channel/Frequency(MHz)		
			RB Size	RB Offset		26047/1850.7	26365/1882.5	26683/1914.3
LTE Band 25	1.4MHz	QPSK	1	0	25.50	24.68	24.92	24.96
			1	2	25.50	24.82	25.07	25.10
			1	5	25.50	24.67	24.95	24.93
			3	0	25.50	24.80	25.04	25.09
			3	1	25.50	24.81	25.04	25.11
			3	2	25.50	24.79	25.04	25.08
			6	0	24.50	23.81	24.09	24.16
		16QAM	1	0	24.50	23.95	24.28	24.15
			1	2	24.50	24.04	24.33	24.17
			1	5	24.50	23.99	24.11	24.04
			3	0	24.50	23.80	24.00	23.91
			3	1	24.50	23.87	24.06	24.00
			3	2	24.50	23.79	24.03	23.95
			6	0	23.50	22.90	23.15	23.20
Band	Band Width	Modulation	RB Configuration		Tune-up	Channel/Frequency(MHz)		
			RB Size	RB Offset		26055/1851.5	26365/1882.5	26675/1913.5
LTE Band 25	3MHz	QPSK	1	0	25.50	24.71	24.96	24.99
			1	7	25.50	24.69	24.96	25.02
			1	14	25.50	24.69	24.93	24.95
			8	0	24.50	23.79	24.04	24.12
			8	4	24.50	23.82	24.08	24.12
			8	7	24.50	23.79	24.02	24.06
			15	0	24.50	23.81	24.05	24.15
		16QAM	1	0	24.50	23.97	24.21	24.08
			1	7	24.50	23.94	24.19	24.17
			1	14	24.50	24.00	24.21	24.10
			8	0	23.50	22.85	23.11	23.16
			8	4	23.50	22.85	23.11	23.15
			8	7	23.50	22.83	23.08	23.07
			15	0	23.50	22.77	23.04	23.10
Band	Band Width	Modulation	RB Configuration		Tune-up	Channel/Frequency(MHz)		
			RB	RB		26065/1852.5	26365/1882.5	26665/1912.5

Band	Band Width	Modulation	RB Configuration		Tune-up	Channel/Frequency(MHz)		
			RB Size	RB Offset		26090/1855	26365/1882.5	26640/1910
LTE Band 25	5MHz	QPSK	1	0	25.50	24.56	24.84	24.87
			1	12	25.50	24.71	24.96	25.03
			1	24	25.50	24.53	24.79	24.83
			12	0	24.50	23.78	24.02	24.15
			12	6	24.50	23.82	24.08	24.15
			12	11	24.50	23.75	24.01	24.00
		16QAM	25	0	24.50	23.78	24.03	24.13
			1	0	24.50	23.89	24.05	24.12
			1	12	24.50	23.91	24.16	24.19
			1	24	24.50	23.83	24.05	23.97
			12	0	23.50	22.76	23.00	23.10
			12	6	23.50	22.79	23.06	23.11
			12	11	23.50	22.72	22.96	22.97
			25	0	23.50	22.76	23.01	23.10
LTE Band 25	10MHz	QPSK	1	0	25.50	24.67	24.93	25.01
			1	24	25.50	24.73	25.02	25.10
			1	49	25.50	24.66	24.89	24.94
			25	0	24.50	23.78	24.06	24.17
			25	12	24.50	23.77	24.05	24.15
			25	24	24.50	23.75	24.01	24.01
			50	0	24.50	23.81	24.05	24.10
		16QAM	1	0	24.50	23.86	24.16	24.26
			1	24	24.50	23.88	24.31	24.26
			1	49	24.50	23.84	24.05	23.95
			25	0	23.50	22.78	23.07	23.16
			25	12	23.50	22.77	23.06	23.13
			25	24	23.50	22.76	23.01	23.00
			50	0	23.50	22.78	23.03	23.10
Band	Band Width	Modulation	RB Configuration		Tune-up	Channel/Frequency(MHz)		
			RB Size	RB Offset		26115/1857.5	26365/1882.5	26615/1907.5
LTE Band 25	15MHz	QPSK	1	0	25.50	24.61	24.88	24.96
			1	37	25.50	24.68	24.92	25.01
			1	74	25.50	24.62	24.82	24.89

Band	Band Width	Modulation	RB Configuration		Tune-up	Channel/Frequency(MHz)		
			RB Size	RB Offset		26140/1860	26365/1882.5	26590/1905
LTE Band 25	20MHz	16QAM	36	0	24.50	23.78	24.06	24.14
			36	18	24.50	23.79	24.06	24.19
			36	37	24.50	23.79	23.99	24.07
			75	0	24.50	23.77	24.01	24.07
		16QAM	1	0	24.50	23.92	24.12	24.19
			1	37	24.50	23.94	24.13	24.21
			1	74	24.50	23.83	24.11	23.96
			36	0	23.50	22.74	23.03	23.07
			36	18	23.50	22.75	23.03	23.13
			36	37	23.50	22.75	22.95	23.01
			75	0	23.50	22.75	22.99	23.07
			QPSK	1	0	25.50	24.54	24.78
		1		49	25.50	24.73	24.98	25.14
		1		99	25.50	24.67	24.78	24.80
50	0	24.50		23.81	24.03	24.14		
50	24	24.50		23.84	24.06	24.18		
50	49	24.50		23.84	23.92	24.00		
100	0	24.50		23.81	23.96	24.06		
16QAM	1	0		24.50	23.81	24.08	24.07	
	1	49		24.50	24.04	24.24	24.38	
	1	99		24.50	23.89	23.97	23.94	
	50	0		23.50	22.80	22.99	23.13	
	50	24		23.50	22.83	23.05	23.14	
	50	49	23.50	22.82	22.89	23.00		
100	0	23.50	22.79	22.92	23.04			

Band	Band Width	Modulation	RB Configuration		Tune-up	Channel/Frequency(MHz)		
			RB Size	RB Offset		26697/814.7	26740/819	26783/823.3
LTE Band 26a	1.4MHz	QPSK	1	0	20.00	19.68	19.62	19.57
			1	2	20.00	19.81	19.71	19.71
			1	5	20.00	19.65	19.56	19.56
			3	0	20.00	19.78	19.68	19.65
			3	1	20.00	19.80	19.68	19.67
			3	2	20.00	19.75	19.68	19.65

Band	Band Width	Modulation	RB Configuration		Tune-up	Channel/Frequency(MHz)		
			RB Size	RB Offset		26705/818.5	26740/819	26775/822.5
		16QAM	6	0	19.00	18.75	18.67	18.64
			1	0	19.50	18.94	18.88	18.93
			1	2	19.50	19.00	19.04	19.05
			1	5	19.50	18.91	18.91	18.84
			3	0	19.00	18.75	18.65	18.71
			3	1	19.00	18.76	18.74	18.72
			3	2	19.00	18.75	18.61	18.68
			6	0	18.00	17.82	17.74	17.74
LTE Band 26a	3MHz	QPSK	1	0	20.00	19.78	19.72	19.68
			1	7	20.00	19.74	19.67	19.62
			1	14	20.00	19.71	19.66	19.66
			8	0	19.00	18.74	18.69	18.65
			8	4	19.00	18.75	18.70	18.66
			8	7	19.00	18.75	18.63	18.61
		16QAM	1	0	19.50	19.07	19.01	18.94
			1	7	19.50	19.08	18.89	18.93
			1	14	19.50	18.96	18.87	18.99
			8	0	18.00	17.81	17.73	17.72
			8	4	18.00	17.81	17.77	17.71
			8	7	18.00	17.81	17.73	17.69
			15	0	18.00	17.72	17.66	17.62
					Modulation	RB Configuration		Tune-up
RB Size	RB Offset	26715/816.5				26740/819	26765/821.5	
LTE Band 26a	5MHz	QPSK	1	0	20.00	19.68	19.63	19.58
			1	12	20.00	19.75	19.67	19.64
			1	24	20.00	19.57	19.52	19.51
			12	0	19.00	18.68	18.66	18.65
			12	6	19.00	18.78	18.72	18.71
			12	11	19.00	18.73	18.61	18.59
			25	0	19.00	18.73	18.64	18.63
		16QAM	1	0	19.50	18.89	18.93	18.79
			1	12	19.50	19.10	19.08	18.95
			1	24	19.50	18.92	18.79	18.84

Band	Band Width	Modulation	RB Configuration		Tune-up	Channel/Frequency(MHz)		
			RB Size	RB Offset		/	26740/819	/
LTE Band 26a	10MHz	QPSK	12	0	18.00	17.68	17.66	17.64
			12	6	18.00	17.78	17.71	17.69
			12	11	18.00	17.70	17.63	17.57
			25	0	18.00	17.75	17.66	17.64
			1	0	20.00	/	19.81	/
			1	24	20.00	/	19.77	/
			1	49	20.00	/	19.60	/
		16QAM	25	0	19.00	/	18.66	/
			25	12	19.00	/	18.71	/
			25	24	19.00	/	18.59	/
			50	0	19.00	/	18.63	/
			1	0	19.50	/	19.06	/
			1	24	19.50	/	19.02	/
			1	49	19.50	/	18.96	/

Band	Band Width	Modulation	RB Configuration		Tune-up	Channel/Frequency(MHz)		
			RB Size	RB Offset		26797/824.7	26915/836.5	27033/848.3
LTE Band 26b	1.4MHz	QPSK	1	0	20.00	19.55	19.69	19.64
			1	2	20.00	19.67	19.81	19.70
			1	5	20.00	19.55	19.67	19.59
			3	0	20.00	19.63	19.77	19.72
			3	1	20.00	19.67	19.78	19.70
			3	2	20.00	19.67	19.76	19.68
			6	0	19.00	18.62	18.75	18.66
		16QAM	1	0	19.50	18.79	18.85	18.85
			1	2	19.50	19.03	19.09	19.00
			1	5	19.50	18.83	19.04	18.95
			3	0	19.00	18.68	18.71	18.69
			3	1	19.00	18.70	18.74	18.72
			3	2	19.00	18.65	18.75	18.69

Band	Band Width	Modulation	RB Configuration		Tune-up	Channel/Frequency(MHz)		
			RB Size	RB Offset		26805/825.5	26915/836.5	27025/847.5
			6	0	18.00	17.73	17.81	17.77
LTE Band 26b	3MHz	QPSK	1	0	20.00	19.65	19.76	19.73
			1	7	20.00	19.67	19.77	19.74
			1	14	20.00	19.67	19.78	19.70
			8	0	19.00	18.65	18.76	18.73
			8	4	19.00	18.66	18.79	18.74
			8	7	19.00	18.68	18.79	18.69
			15	0	19.00	18.62	18.77	18.71
		16QAM	1	0	19.50	18.88	19.11	19.10
			1	7	19.50	18.91	18.96	18.93
			1	14	19.50	19.03	19.01	19.01
			8	0	18.00	17.72	17.82	17.81
			8	4	18.00	17.74	17.85	17.82
			8	7	18.00	17.72	17.81	17.79
			15	0	18.00	17.66	17.80	17.72
Band	Band Width	Modulation	RB Configuration		Tune-up	Channel/Frequency(MHz)		
			RB Size	RB Offset		26815/826.5	26915/836.5	27015/846.5
LTE Band 26b	5MHz	QPSK	1	0	20.00	19.55	19.60	19.66
			1	12	20.00	19.68	19.75	19.68
			1	24	20.00	19.54	19.68	19.55
			12	0	19.00	18.66	18.76	18.75
			12	6	19.00	18.70	18.83	18.76
			12	11	19.00	18.62	18.76	18.69
			25	0	19.00	18.66	18.76	18.73
		16QAM	1	0	19.50	18.87	18.92	18.93
			1	12	19.50	19.05	19.00	19.04
			1	24	19.50	18.77	18.97	18.82
			12	0	18.00	17.64	17.76	17.74
			12	6	18.00	17.69	17.85	17.77
			12	11	18.00	17.62	17.76	17.70
			25	0	18.00	17.65	17.80	17.73
Band	Band Width	Modulation	RB Configuration		Tune-up	Channel/Frequency(MHz)		

Band	Band Width	Modulation	RB Configuration		Tune-up	Channel/Frequency(MHz)		
			RB Size	RB Offset		26865/831.5	26915/836.5	26965/841.5
LTE Band 26b	10MHz	QPSK	1	0	20.00	26840/829	26915/836.5	26990/844
			1	24	20.00	19.65	19.72	19.80
			1	49	20.00	19.76	19.85	19.87
			25	0	19.00	19.66	19.78	19.68
			25	12	19.00	18.72	18.77	18.92
			25	24	19.00	18.70	18.84	18.80
			25	24	19.00	18.78	18.76	18.69
		16QAM	50	0	19.00	18.74	18.78	18.79
			1	0	19.50	19.01	18.99	19.07
			1	24	19.50	19.10	19.17	19.19
			1	49	19.50	18.91	19.13	18.90
			25	0	18.00	17.73	17.78	17.93
			25	12	18.00	17.68	17.85	17.80
			25	24	18.00	17.81	17.79	17.69
50	0	18.00	17.74	17.79	17.80			

Band	Band Width	Modulation	RB Configuration		Tune-up	Channel/Frequency(MHz)		
			RB Size	RB Offset		40065/2537.5	40640/2595	41215/2652.5
LTE	5MHz	QPSK	1	0	21.00	20.15	20.66	20.83

Band 41			1	12	21.00	20.29	20.77	20.91
			1	24	21.00	20.22	20.67	20.79
			12	0	20.00	19.19	19.63	19.89
			12	6	20.00	19.21	19.70	19.87
			12	11	20.00	19.22	19.70	19.83
			25	0	20.00	19.23	19.68	19.89
			25	0	20.00	19.23	19.68	19.89
		16QAM	1	0	20.50	19.34	19.84	20.02
			1	12	20.50	19.51	19.98	20.13
			1	24	20.50	19.42	19.87	19.98
			12	0	19.00	18.25	18.69	18.95
			12	6	19.00	18.32	18.75	18.97
			12	11	19.00	18.29	18.76	18.90
			25	0	19.00	18.30	18.77	18.98
Band	Band Width	Modulation	RB Configuration		Tune-up	Channel/Frequency(MHz)		
			RB Size	RB Offset		40090/2540	40640/2595	41190/2650
LTE Band 41	10MHz	QPSK	1	0	21.00	20.22	20.73	20.90
			1	24	21.00	20.38	20.83	20.99
			1	49	21.00	20.24	20.70	20.84
			25	0	20.00	19.29	19.71	20.00
			25	12	20.00	19.33	19.79	19.97
			25	24	20.00	19.33	19.79	19.88
			50	0	20.00	19.22	19.71	19.88
		16QAM	1	0	20.50	19.45	19.94	20.11
			1	24	20.50	19.58	20.08	20.23
			1	49	20.50	19.46	19.92	20.08
			25	0	19.50	18.37	18.77	19.09
			25	12	19.50	18.38	18.81	19.02
			25	24	19.50	18.39	18.84	18.97
			50	0	19.00	18.32	18.81	18.97
Band	Band Width	Modulation	RB Configuration		Tune-up	Channel/Frequency(MHz)		
			RB Size	RB Offset		40115/2542.5	40640/2595	41165/2647.5
LTE Band 41	15MHz	QPSK	1	0	21.00	20.13	20.63	20.78
			1	37	21.00	20.30	20.76	20.89
			1	74	21.00	20.18	20.60	20.76
			36	0	20.00	19.16	19.64	19.81
			36	18	20.00	19.20	19.66	19.79



Band	Band Width	Modulation	RB Configuration		Tune-up	Channel/Frequency(MHz)		
			RB Size	RB Offset		40140/2545	40640/2595	41140/2645
		16QAM	36	37	20.00	19.17	19.68	19.76
			75	0	20.00	19.15	19.64	19.79
			1	0	20.50	19.35	19.84	19.99
			1	37	20.50	19.53	19.96	20.10
			1	74	20.50	19.35	19.80	19.95
			36	0	19.00	18.17	18.64	18.82
			36	18	19.00	18.19	18.64	18.78
			36	37	19.00	18.17	18.68	18.76
			75	0	19.00	18.21	18.70	18.85
			LTE Band 41	20MHz	QPSK	1	0	21.00
1	49	21.00				20.40	20.82	20.95
1	99	21.00				20.09	20.56	20.72
50	0	20.00				19.15	19.60	19.82
50	24	20.00				19.20	19.66	19.80
50	49	20.00				19.14	19.69	19.70
16QAM	100	0			20.00	19.13	19.63	19.78
	1	0			20.50	19.33	19.77	19.98
	1	49			20.50	19.70	20.06	20.19
	1	99			20.50	19.29	19.76	19.93
	50	0			19.00	18.23	18.68	18.92
	50	24			19.00	18.30	18.77	18.90
16QAM	50	49			19.00	18.21	18.77	18.78
	100	0			19.00	18.21	18.70	18.89

Band	Band Width	Modulation	RB Configuration		Tune-up	Channel/Frequency(MHz)		
			RB Size	RB Offset		131979/1710.7	132322/1745	132665/1779.3
LTE Band 66	1.4MHz	QPSK	1	0	23.50	22.98	23.06	23.33
			1	2	23.50	23.09	23.17	23.45
			1	5	23.50	22.97	23.01	23.33
			3	0	23.50	23.09	23.12	23.43
			3	1	23.50	23.09	23.15	23.43
			3	2	23.50	23.05	23.13	23.44
			6	0	22.50	22.06	22.14	22.45
		16QAM	1	0	23.00	22.29	22.28	22.53

Band	Band Width	Modulation	RB Configuration		Tune-up	Channel/Frequency(MHz)		
			RB Size	RB Offset		131987/1711.5	132322/1745	132657/1778.5
			1	2	23.00	22.38	22.48	22.70
			1	5	23.00	22.26	22.26	22.65
			3	0	22.50	22.13	22.16	22.45
			3	1	22.50	22.07	22.12	22.49
			3	2	22.50	22.13	22.12	22.47
			6	0	22.00	21.17	21.28	21.58
LTE Band 66	3MHz	QPSK	1	0	23.50	23.10	23.14	23.34
			1	7	23.50	23.07	23.15	23.32
			1	14	23.50	23.09	23.12	23.32
			8	0	22.50	22.08	22.15	22.37
			8	4	22.50	22.10	22.17	22.40
			8	7	22.50	22.08	22.15	22.34
			15	0	22.50	22.06	22.14	22.35
		16QAM	1	0	23.00	22.41	22.46	22.67
			1	7	23.00	22.39	22.34	22.64
			1	14	23.00	22.27	22.42	22.62
			8	0	21.50	21.19	21.25	21.48
			8	4	21.50	21.21	21.29	21.49
			8	7	21.50	21.18	21.24	21.46
			15	0	21.50	21.12	21.22	21.39
Band	Band Width	Modulation	RB Configuration		Tune-up	Channel/Frequency(MHz)		
			RB Size	RB Offset		131997/1712.5	132322/1745	132647/1777.5
LTE Band 66	5MHz	QPSK	1	0	23.50	23.34	23.02	23.26
			1	12	23.50	23.32	23.14	23.36
			1	24	23.50	23.32	23.03	23.20
			12	0	22.50	22.37	22.22	22.42
			12	6	22.50	22.40	22.21	22.40
			12	11	22.50	22.34	22.14	22.33
			25	0	22.50	22.35	22.17	22.38
		16QAM	1	0	23.00	22.67	22.30	22.56
			1	12	23.00	22.64	22.48	22.61
			1	24	23.00	22.62	22.34	22.47
			12	0	21.50	21.48	21.21	21.43
			12	6	21.50	21.49	21.25	21.41

Band	Band Width	Modulation	RB Configuration		Tune-up	Channel/Frequency(MHz)		
			RB Size	RB Offset		132022/1715	132322/1745	132622/1775
			12	11	21.50	21.46	21.17	21.36
			25	0	21.50	21.39	21.20	21.41
Band	Band Width	Modulation	RB Configuration		Tune-up	Channel/Frequency(MHz)		
			RB Size	RB Offset		132022/1715	132322/1745	132622/1775
LTE Band 66	10MHz	QPSK	1	0	23.50	23.10	23.12	23.38
			1	24	23.50	23.16	23.25	23.49
			1	49	23.50	23.09	23.18	23.31
			25	0	23.00	22.08	22.29	22.58
			25	12	23.00	22.15	22.25	22.45
			25	24	23.00	22.21	22.25	22.36
			50	0	22.50	22.18	22.29	22.48
		16QAM	1	0	23.00	22.42	22.39	22.69
			1	24	23.00	22.44	22.60	22.83
			1	49	23.00	22.32	22.45	22.52
			25	0	22.00	21.15	21.33	21.60
			25	12	22.00	21.23	21.30	21.51
			25	24	22.00	21.25	21.29	21.40
			50	0	22.00	21.21	21.32	21.53
Band	Band Width	Modulation	RB Configuration		Tune-up	Channel/Frequency(MHz)		
			RB Size	RB Offset		132047/1717.5	132322/1745	132597/1772.5
LTE Band 66	15MHz	QPSK	1	0	23.50	23.04	23.09	23.27
			1	37	23.50	23.16	23.16	23.38
			1	74	23.50	23.10	23.15	23.28
			36	0	22.50	22.05	22.25	22.43
			36	18	22.50	22.12	22.27	22.44
			36	37	22.50	22.20	22.23	22.35
			75	0	22.50	22.12	22.25	22.40
		16QAM	1	0	23.00	22.21	22.41	22.59
			1	37	23.00	22.46	22.48	22.74
			1	74	23.00	22.39	22.38	22.59
			36	0	21.50	21.06	21.32	21.45
			36	18	21.50	21.15	21.23	21.45
			36	37	21.50	21.22	21.24	21.37
			75	0	21.50	21.15	21.33	21.42
Band	Band Width	Modulation	RB Configuration		Tune-up	Channel/Frequency(MHz)		
			RB Size	RB Offset		132047/1717.5	132322/1745	132597/1772.5

			RB Size	RB Offset		132072/1720	132322/1745	132572/1770
LTE Band 66	20MHz	QPSK	1	0	24.00	22.93	23.04	23.21
			1	49	24.00	23.23	23.20	23.51
			1	99	24.00	23.06	23.10	23.21
			50	0	22.50	21.96	22.32	22.40
			50	24	22.50	22.12	22.26	22.43
			50	49	22.50	22.16	22.21	22.21
			100	0	22.50	22.06	22.29	22.31
		16QAM	1	0	23.00	22.26	22.30	22.57
			1	49	23.00	22.55	22.50	22.70
			1	99	23.00	22.36	22.32	22.41
			50	0	21.50	21.00	21.36	21.46
			50	24	21.50	21.16	21.31	21.47
			50	49	21.50	21.22	21.26	21.27
			100	0	21.50	21.09	21.30	21.35

#### 7.4. WLAN & Bluetooth Output Power

##### 7.4.1. Output Power Results Of WLAN

Mode	Channel	Frequency (MHz)	Tune-up (dBm)	Output Power (dBm)
802.11b	1	2412	16.00	15.60
	6	2437	16.00	15.55
	11	2462	16.00	15.06
802.11g	1	2412	14.00	13.83
	6	2437	14.00	13.85
	11	2462	14.00	13.70
802.11n HT20	1	2412	12.50	12.10
	6	2437	12.50	12.21
	11	2462	12.50	11.95
802.11n HT40	3	2422	12.50	11.87
	6	2437	12.50	11.80
	9	2452	12.50	12.40

NOTE: Power measurement results of WLAN 2.4G.

Mode	Channel	Frequency (MHz)	Tune-up (dBm)	Output Power (dBm)
802.11a	36	5180	11.00	10.57

	40	5200	11.00	9.86
	48	5240	11.00	9.80
802.11n HT20	36	5180	10.50	9.36
	40	5200	10.50	10.42
	48	5240	10.50	9.45
802.11n HT40	38	5190	10.50	8.90
	46	5230	10.50	10.21
802.11ac VHT20	36	5180	10.50	9.33
	40	5200	10.50	10.39
	48	5240	10.50	10.10
802.11ac VHT40	38	5190	9.50	8.94
	46	5230	9.50	9.49
802.11ac VHT80	42	5210	7.50	7.05

NOTE: Power measurement results of WLAN 5.2G.

Mode	Channel	Frequency (MHz)	Tune-up (dBm)	Output Power (dBm)
802.11a	149	5745	10.50	10.03
	157	5785	10.50	9.83
	165	5825	10.50	9.12
802.11n HT20	149	5745	10.50	10.24
	157	5785	10.50	9.91
	165	5825	10.50	10.26
802.11n HT40	151	5755	9.50	9.48
	159	5795	9.50	9.06
802.11ac VHT20	149	5745	10.50	10.09
	157	5785	10.50	9.90
	165	5825	10.50	10.24
802.11ac VHT40	151	5755	10.00	9.60
	159	5795	10.00	9.72
802.11ac VHT80	155	5775	9.50	9.42

NOTE: Power measurement results of WLAN 5.8G.

**7.4.2. Output Power Results Of Bluetooth**

BR+EDR	Output Power (dBm)				
	Channel	Tune-up (dBm)	Data Rates		
			1M	2M	3M
	0CH	9.000	8.134	8.205	7.943
	39CH	9.000	8.283	8.224	8.201
	78CH	9.000	8.695	8.690	8.605

BLE	Channel	Tune-up (dBm)	Output Power (dBm)
	0CH	6.000	5.545
	19CH	6.000	5.631
	39CH	5.000	4.639

### 8. Antenna Location

Top Side

250mm

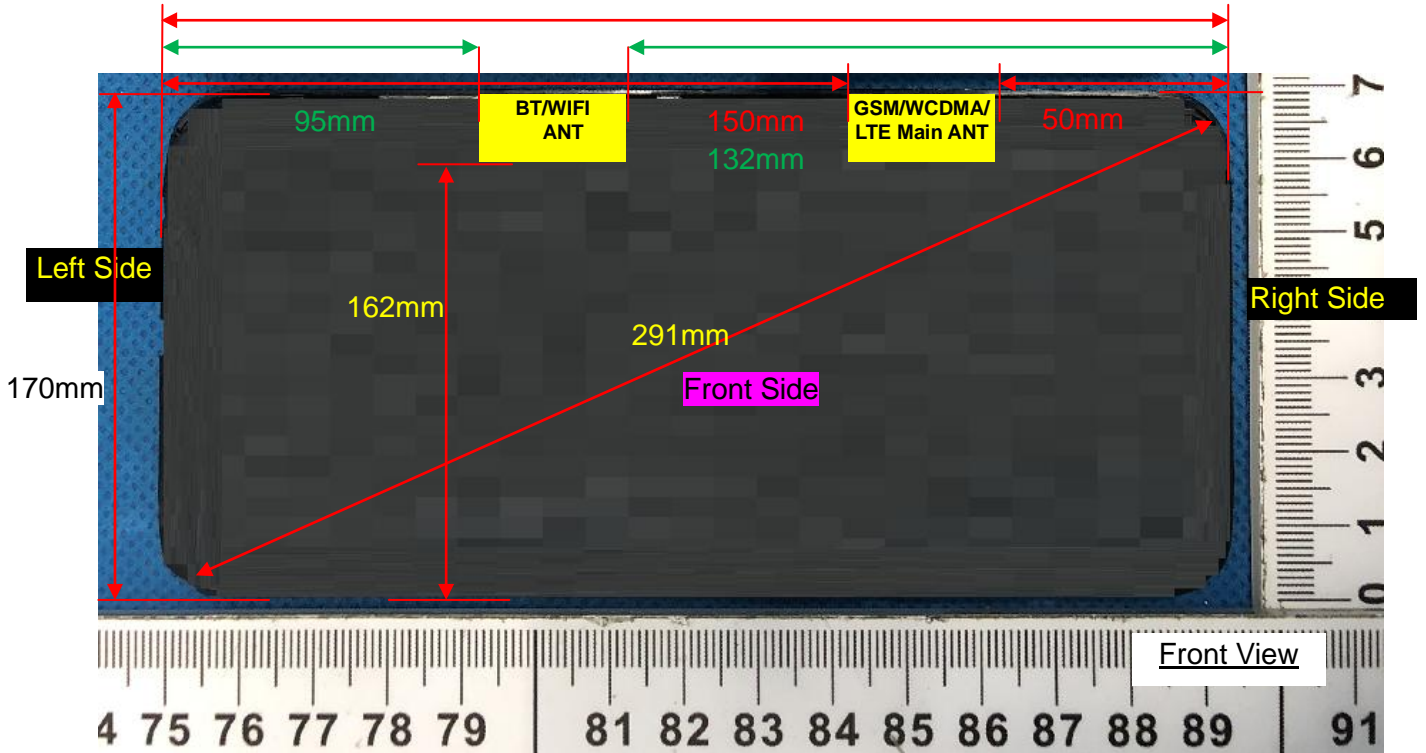

Bottom Side

Note: Since the confidentiality request of EUT, the antenna location example diagram see as above.

Distance of the Antenna to the EUT surface/edge						
Antennas	Front Side	Back Side	Left Side	Right Side	Top Side	Bottom Side
WLAN & Bluetooth	5	5	95	132	5	162
WWAN	5	5	150	50	5	162

Note: When the minimum separation distance is < 5 mm, a distance of 5 mm is applied to determine SAR test exclusion.

Positions for SAR tests		
Test separation distances ≤ 50 mm		
Exposure Positions	Tune-up Maximum power of WLAN 2.4G	
	16.00dBm	
Front Side	Antenna to user(mm)	5
	SAR exclusion threshold	12.49
	SAR testing required?	YES
Back Side	Antenna to user(mm)	5
	SAR exclusion threshold	12.49

	SAR testing required?	YES
Top Side	Antenna to user(mm)	5
	SAR exclusion threshold	12.49
	SAR testing required?	YES
Exposure Positions	Tune-up Maximum power of WLAN 5.2G	
	11.00dBm	
Front Side	Antenna to user(mm)	5
	SAR exclusion threshold	5.76
	SAR testing required?	YES
Back Side	Antenna to user(mm)	5
	SAR exclusion threshold	5.76
	SAR testing required?	YES
Top Side	Antenna to user(mm)	5
	SAR exclusion threshold	5.76
	SAR testing required?	YES
Exposure Positions	Tune-up Maximum power of WLAN 5.8G	
	10.50dBm	
Front Side	Antenna to user(mm)	5
	SAR exclusion threshold	5.42
	SAR testing required?	YES
Back Side	Antenna to user(mm)	5
	SAR exclusion threshold	5.42
	SAR testing required?	YES
Top Side	Antenna to user(mm)	5
	SAR exclusion threshold	5.42
	SAR testing required?	YES
Exposure Positions	Tune-up Maximum power of GSM 850	
	33.00dBm	
Front Side	Antenna to user(mm)	5
	SAR exclusion threshold	367.91
	SAR testing required?	YES
Back Side	Antenna to user(mm)	5
	SAR exclusion threshold	367.91
	SAR testing required?	YES
Right Side	Antenna to user(mm)	50
	SAR exclusion threshold	36.79
	SAR testing required?	YES
Top Side	Antenna to user(mm)	5
	SAR exclusion threshold	367.91
	SAR testing required?	YES



Exposure Positions	Tune-up Maximum power of GSM 1900	
	29.50dBm	
Front Side	Antenna to user(mm)	5
	SAR exclusion threshold	246.35
	SAR testing required?	YES
Back Side	Antenna to user(mm)	5
	SAR exclusion threshold	246.35
	SAR testing required?	YES
Right Side	Antenna to user(mm)	50
	SAR exclusion threshold	24.64
	SAR testing required?	YES
Top Side	Antenna to user(mm)	5
	SAR exclusion threshold	246.35
	SAR testing required?	YES
Exposure Positions	Tune-up Maximum power of WCDMA Band 2	
	23.50dBm	
Front Side	Antenna to user(mm)	5
	SAR exclusion threshold	61.88
	SAR testing required?	YES
Back Side	Antenna to user(mm)	5
	SAR exclusion threshold	61.88
	SAR testing required?	YES
Right Side	Antenna to user(mm)	50
	SAR exclusion threshold	6.19
	SAR testing required?	YES
Top Side	Antenna to user(mm)	5
	SAR exclusion threshold	61.88
	SAR testing required?	YES
Exposure Positions	Tune-up Maximum power of WCDMA Band 4	
	23.00dBm	
Front Side	Antenna to user(mm)	5
	SAR exclusion threshold	52.87
	SAR testing required?	YES
Back Side	Antenna to user(mm)	5
	SAR exclusion threshold	52.87
	SAR testing required?	YES
Right Side	Antenna to user(mm)	50
	SAR exclusion threshold	5.29
	SAR testing required?	YES
Top Side	Antenna to user(mm)	5

	SAR exclusion threshold	52.87
	SAR testing required?	YES
Exposure Positions	Tune-up Maximum power of WCDMA Band 5	
	23.00dBm	
Front Side	Antenna to user(mm)	5
	SAR exclusion threshold	36.79
	SAR testing required?	YES
Back Side	Antenna to user(mm)	5
	SAR exclusion threshold	36.79
	SAR testing required?	YES
Right Side	Antenna to user(mm)	50
	SAR exclusion threshold	3.68
	SAR testing required?	YES
Top Side	Antenna to user(mm)	5
	SAR exclusion threshold	36.79
	SAR testing required?	YES
Exposure Positions	Tune-up Maximum power of LTE Band 2	
	25.50dBm	
Front Side	Antenna to user(mm)	5
	SAR exclusion threshold	98.07
	SAR testing required?	YES
Back Side	Antenna to user(mm)	5
	SAR exclusion threshold	98.07
	SAR testing required?	YES
Right Side	Antenna to user(mm)	50
	SAR exclusion threshold	9.81
	SAR testing required?	YES
Top Side	Antenna to user(mm)	5
	SAR exclusion threshold	98.07
	SAR testing required?	YES
Exposure Positions	Tune-up Maximum power of LTE Band 4	
	25.00dBm	
Front Side	Antenna to user(mm)	5
	SAR exclusion threshold	83.79
	SAR testing required?	YES
Back Side	Antenna to user(mm)	5
	SAR exclusion threshold	83.79
	SAR testing required?	YES
Right Side	Antenna to user(mm)	50
	SAR exclusion threshold	8.38

	SAR testing required?	YES
Top Side	Antenna to user(mm)	5
	SAR exclusion threshold	83.79
	SAR testing required?	YES
Exposure Positions	Tune-up Maximum power of LTE Band 5	
	24.00dBm	
Front Side	Antenna to user(mm)	5
	SAR exclusion threshold	46.32
	SAR testing required?	YES
Back Side	Antenna to user(mm)	5
	SAR exclusion threshold	46.32
	SAR testing required?	YES
Right Side	Antenna to user(mm)	50
	SAR exclusion threshold	4.63
	SAR testing required?	YES
Top Side	Antenna to user(mm)	5
	SAR exclusion threshold	46.32
	SAR testing required?	YES
Exposure Positions	Tune-up Maximum power of LTE Band 7	
	25.50dBm	
Front Side	Antenna to user(mm)	5
	SAR exclusion threshold	113.76
	SAR testing required?	YES
Back Side	Antenna to user(mm)	5
	SAR exclusion threshold	113.76
	SAR testing required?	YES
Right Side	Antenna to user(mm)	50
	SAR exclusion threshold	11.38
	SAR testing required?	YES
Top Side	Antenna to user(mm)	5
	SAR exclusion threshold	113.76
	SAR testing required?	YES
Exposure Positions	Tune-up Maximum power of LTE Band 12	
	24.00dBm	
Front Side	Antenna to user(mm)	5
	SAR exclusion threshold	43.51
	SAR testing required?	YES
Back Side	Antenna to user(mm)	5
	SAR exclusion threshold	43.51
	SAR testing required?	YES

Right Side	Antenna to user(mm)	50
	SAR exclusion threshold	4.35
	SAR testing required?	YES
Top Side	Antenna to user(mm)	5
	SAR exclusion threshold	43.51
	SAR testing required?	YES
Exposure Positions	Tune-up Maximum power of LTE Band 17	
	24.50dBm	
Front Side	Antenna to user(mm)	5
	SAR exclusion threshold	48.82
	SAR testing required?	YES
Back Side	Antenna to user(mm)	5
	SAR exclusion threshold	48.82
	SAR testing required?	YES
Right Side	Antenna to user(mm)	50
	SAR exclusion threshold	4.88
	SAR testing required?	YES
Top Side	Antenna to user(mm)	5
	SAR exclusion threshold	48.82
	SAR testing required?	YES
Exposure Positions	Tune-up Maximum power of LTE Band 25	
	25.50dBm	
Front Side	Antenna to user(mm)	5
	SAR exclusion threshold	98.20
	SAR testing required?	YES
Back Side	Antenna to user(mm)	5
	SAR exclusion threshold	98.20
	SAR testing required?	YES
Right Side	Antenna to user(mm)	50
	SAR exclusion threshold	9.82
	SAR testing required?	YES
Top Side	Antenna to user(mm)	5
	SAR exclusion threshold	98.20
	SAR testing required?	YES
Exposure Positions	Tune-up Maximum power of LTE Band 26	
	20.00dBm	
Front Side	Antenna to user(mm)	5
	SAR exclusion threshold	18.44
	SAR testing required?	YES
Back Side	Antenna to user(mm)	5

	SAR exclusion threshold	18.44
	SAR testing required?	YES
Right Side	Antenna to user(mm)	50
	SAR exclusion threshold	1.84
	SAR testing required?	NO
Top Side	Antenna to user(mm)	5
	SAR exclusion threshold	18.44
	SAR testing required?	YES
Exposure Positions	Tune-up Maximum power of LTE Band 41	
	21.00dBm	
Front Side	Antenna to user(mm)	5
	SAR exclusion threshold	41.30
	SAR testing required?	YES
Back Side	Antenna to user(mm)	5
	SAR exclusion threshold	41.30
	SAR testing required?	YES
Right Side	Antenna to user(mm)	50
	SAR exclusion threshold	4.13
	SAR testing required?	YES
Top Side	Antenna to user(mm)	5
	SAR exclusion threshold	41.30
	SAR testing required?	YES
Exposure Positions	Tune-up Maximum power of LTE Band 66	
	24.00dBm	
Front Side	Antenna to user(mm)	5
	SAR exclusion threshold	67.03
	SAR testing required?	YES
Back Side	Antenna to user(mm)	5
	SAR exclusion threshold	67.03
	SAR testing required?	YES
Right Side	Antenna to user(mm)	50
	SAR exclusion threshold	6.70
	SAR testing required?	YES
Top Side	Antenna to user(mm)	5
	SAR exclusion threshold	67.03
	SAR testing required?	YES

NOTE: Refer to section 4.3.1 of KDB 447498 D01.

Positions for SAR tests
Test separation distances > 50 mm

Exposure Positions	Tune-up Maximum power of WLAN 2.4G	
	16.00dBm	39.81mW
Left Side	Antenna to user(mm)	95
	SAR exclusion threshold(mW)	546
	SAR testing required?	NO
Right Side	Antenna to user(mm)	132
	SAR exclusion threshold(mW)	916
	SAR testing required?	NO
Bottom Side	Antenna to user(mm)	162
	SAR exclusion threshold(mW)	1216
	SAR testing required?	NO
Exposure Positions	Tune-up Maximum power of WLAN 5.2G	
	11.00dBm	12.59mW
Left Side	Antenna to user(mm)	95
	SAR exclusion threshold(mW)	516
	SAR testing required?	NO
Right Side	Antenna to user(mm)	132
	SAR exclusion threshold(mW)	886
	SAR testing required?	NO
Bottom Side	Antenna to user(mm)	162
	SAR exclusion threshold(mW)	1186
	SAR testing required?	NO
Exposure Positions	Tune-up Maximum power of WLAN 5.8G	
	10.50dBm	11.22mW
Left Side	Antenna to user(mm)	95
	SAR exclusion threshold(mW)	512
	SAR testing required?	NO
Right Side	Antenna to user(mm)	132
	SAR exclusion threshold(mW)	882
	SAR testing required?	NO
Bottom Side	Antenna to user(mm)	162
	SAR exclusion threshold(mW)	1182
	SAR testing required?	NO
Exposure Positions	Tune-up Maximum power of GSM 850	
	33.00dBm	1995.26mW
Left Side	Antenna to user(mm)	150
	SAR exclusion threshold(mW)	721
	SAR testing required?	YES
Bottom Side	Antenna to user(mm)	162
	SAR exclusion threshold(mW)	787

	SAR testing required?	YES
Exposure Positions	Tune-up Maximum power of GSM 1900	
	29.50dBm	891.25mW
Left Side	Antenna to user(mm)	150
	SAR exclusion threshold(mW)	1109
	SAR testing required?	No
Bottom Side	Antenna to user(mm)	162
	SAR exclusion threshold(mW)	1229
	SAR testing required?	NO
Exposure Positions	Tune-up Maximum power of WCDMA Band 2	
	23.50dBm	223.87mW
Left Side	Antenna to user(mm)	150
	SAR exclusion threshold(mW)	1109
	SAR testing required?	No
Bottom Side	Antenna to user(mm)	162
	SAR exclusion threshold(mW)	1229
	SAR testing required?	NO
Exposure Positions	Tune-up Maximum power of WCDMA Band 4	
	23.00dBm	199.53mW
Left Side	Antenna to user(mm)	150
	SAR exclusion threshold(mW)	1109
	SAR testing required?	No
Bottom Side	Antenna to user(mm)	162
	SAR exclusion threshold(mW)	1229
	SAR testing required?	NO
Exposure Positions	Tune-up Maximum power of WCDMA Band 5	
	23.00dBm	199.53mW
Left Side	Antenna to user(mm)	150
	SAR exclusion threshold(mW)	721
	SAR testing required?	NO
Bottom Side	Antenna to user(mm)	162
	SAR exclusion threshold(mW)	787
	SAR testing required?	NO
Exposure Positions	Tune-up Maximum power of LTE Band 2	
	25.50dBm	354.81mW
Left Side	Antenna to user(mm)	150
	SAR exclusion threshold(mW)	1109
	SAR testing required?	No
Bottom Side	Antenna to user(mm)	162
	SAR exclusion threshold(mW)	1229

	SAR testing required?	NO
Exposure Positions	Tune-up Maximum power of LTE Band 4	
	25.00dBm	316.23mW
Left Side	Antenna to user(mm)	150
	SAR exclusion threshold(mW)	1109
	SAR testing required?	No
Bottom Side	Antenna to user(mm)	162
	SAR exclusion threshold(mW)	1229
	SAR testing required?	NO
Exposure Positions	Tune-up Maximum power of LTE Band 5	
	24.00dBm	251.19mW
Left Side	Antenna to user(mm)	150
	SAR exclusion threshold(mW)	721
	SAR testing required?	NO
Bottom Side	Antenna to user(mm)	162
	SAR exclusion threshold(mW)	787
	SAR testing required?	NO
Exposure Positions	Tune-up Maximum power of LTE Band 7	
	25.50dBm	354.81mW
Left Side	Antenna to user(mm)	150
	SAR exclusion threshold(mW)	1079
	SAR testing required?	NO
Bottom Side	Antenna to user(mm)	162
	SAR exclusion threshold(mW)	1199
	SAR testing required?	NO
Exposure Positions	Tune-up Maximum power of LTE Band 12	
	24.00dBm	251.19mW
Left Side	Antenna to user(mm)	150
	SAR exclusion threshold(mW)	721
	SAR testing required?	NO
Bottom Side	Antenna to user(mm)	162
	SAR exclusion threshold(mW)	787
	SAR testing required?	NO
Exposure Positions	Tune-up Maximum power of LTE Band 17	
	24.50dBm	281.84mW
Left Side	Antenna to user(mm)	150
	SAR exclusion threshold(mW)	721
	SAR testing required?	NO
Bottom Side	Antenna to user(mm)	162
	SAR exclusion threshold(mW)	787



	SAR testing required?	NO
Exposure Positions	Tune-up Maximum power of LTE Band 25	
	25.50dBm	354.81mW
Left Side	Antenna to user(mm)	150
	SAR exclusion threshold(mW)	1109
	SAR testing required?	No
Bottom Side	Antenna to user(mm)	162
	SAR exclusion threshold(mW)	1229
	SAR testing required?	NO
Exposure Positions	Tune-up Maximum power of LTE Band 26	
	20.00dBm	100.00mW
Left Side	Antenna to user(mm)	150
	SAR exclusion threshold(mW)	721
	SAR testing required?	NO
Bottom Side	Antenna to user(mm)	162
	SAR exclusion threshold(mW)	787
	SAR testing required?	NO
Exposure Positions	Tune-up Maximum power of LTE Band 41	
	21.00dBm	125.89mW
Left Side	Antenna to user(mm)	150
	SAR exclusion threshold(mW)	1079
	SAR testing required?	NO
Bottom Side	Antenna to user(mm)	162
	SAR exclusion threshold(mW)	1199
	SAR testing required?	NO
Exposure Positions	Tune-up Maximum power of LTE Band 66	
	24.00dBm	251.19mW
Left Side	Antenna to user(mm)	150
	SAR exclusion threshold(mW)	1109
	SAR testing required?	No
Bottom Side	Antenna to user(mm)	162
	SAR exclusion threshold(mW)	1229
	SAR testing required?	NO

NOTE: Refer to section 4.3.1 of KDB 447498 D01.

## 9. Stand-alone SAR test exclusion

Refer to FCC KDB 447498D01, the 1-g SAR and 10-g SAR test exclusion thresholds for 100 MHz to 6 GHz at test separation distances  $\leq 50$  mm are determined by:

$$[(\text{max. power of channel, including tune-up tolerance, mW}) / (\text{min. test separation distance, mm})] \cdot [\sqrt{f_{\text{GHz}}}]$$

$\leq 3.0$  for 1-g SAR and  $\leq 7.5$  for 10-g extremity SAR, where:

- $f_{(GHz)}$  is the RF channel transmit frequency in GHz
- Power and distance are rounded to the nearest mW and mm before calculation
- The result is rounded to one decimal place for comparison

When the minimum test separation distance is  $< 5$  mm, a distance of 5 mm is applied to determine SAR test exclusion.

Mode	$P_{max}$ (dBm)	$P_{max}$ (mW)	Distance (mm)	f (GHz)	Calculation Result	SAR Exclusion threshold	SAR test exclusion
Bluetooth	9.00	7.94	5	2.480	2.50	3.0	Yes

NOTE: Standalone SAR test exclusion for Bluetooth.

When standalone SAR test exclusion applies to an antenna that transmits simultaneously with other antennas, the standalone SAR must be estimated according to following to determine simultaneous transmission SAR test exclusion:

$[(\text{max. power of channel, including tune-up tolerance, mW})/(\text{min. test separation distance, mm})] * [\sqrt{f_{(GHz)}/x}] \text{ W/kg}$  for test separation distances  $\leq 50\text{mm}$ , where  $x = 7.5$  for 1-g SAR and  $x = 18.75$  for 10-g SAR.

When the minimum test separation distance is  $< 5$  mm, a distance of 5 mm is applied to determine SAR test exclusion.

Mode	Position	$P_{max}$ (dBm)	$P_{max}$ (mW)	Distance (mm)	f (GHz)	x	Estimated SAR (W/Kg)
Bluetooth	Body	9.00	7.94	5	2.48	7.5	0.334

NOTE: Estimated SAR calculation for Bluetooth

## 10. SAR Results

### 10.1. SAR measurement results

#### 10.1.1. SAR measurement Result of GSM850

Test Position of Body with 0mm	Test channel /Freq.	Mode	SAR Value (W/kg)		Power Drift(%)	Conducted Power (dBm)	Tune-up Power (dBm)	Scaled SAR 1-g (W/Kg)	Date	Plot
			1-g	10-g						
Front Side	189/836.4	GPRS(GMSK 4TS)	0.280	0.153	2.85	28.75	29.00	0.297	2022/9/23	
Back Side	189/836.4	GPRS(GMSK 4TS)	<b>0.389</b>	0.213	0.67	28.75	29.00	<b>0.412</b>	2022/9/23	1#
Left Side	189/836.4	GPRS(GMSK 4TS)	0.080	0.042	-1.81	28.75	29.00	0.085	2022/9/23	
Right Side	189/836.4	GPRS(GMSK 4TS)	0.043	0.023	-0.65	28.75	29.00	0.046	2022/9/23	

Top Side	189/836.4	GPRS(GMSK 4TS)	0.198	0.103	-3.99	28.75	29.00	0.210	2022/9/23	
Bottom Side	189/836.4	GPRS(GMSK 4TS)	0.041	0.022	2.66	28.75	29.00	0.043	2022/9/23	

NOTE: Body SAR test results of GSM850

### 10.1.2. SAR measurement Result of GSM1900

Test Position of Body with 0mm	Test channel /Freq.	Mode	SAR Value (W/kg)		Power Drift(%)	Conducted Power (dBm)	Tune-up Power (dBm)	Scaled SAR 1-g (W/Kg)	Date	Plot
			1-g	10-g						
Front Side	661/1880	GPRS(GMSK 4TS)	0.427	0.197	-1.32	25.50	26.00	0.479	2022/10/08	
Back Side	661/1880	GPRS(GMSK 4TS)	<b>0.590</b>	0.283	-3.54	25.50	26.00	<b>0.662</b>	2022/10/08	2#
Right Side	661/1880	GPRS(GMSK 4TS)	0.062	0.029	-0.36	25.50	26.00	0.070	2022/10/08	
Top Side	661/1880	GPRS(GMSK 4TS)	0.301	0.143	0.75	25.50	26.00	0.338	2022/10/08	

NOTE: Body SAR test results of GSM1900

### 10.1.3. SAR measurement Result of WCDMA Band 2

Test Position of Body with 0mm	Test channel /Freq.	Mode	SAR Value (W/kg)		Power Drift(%)	Conducted Power (dBm)	Tune-up Power (dBm)	Scaled SAR 1-g (W/Kg)	Date	Plot
			1-g	10-g						
Front Side	9400/1880	RMC12.2K	0.546	0.287	2.14	23.04	23.50	0.607	2022/10/08	
Back Side	9400/1880	RMC12.2K	<b>0.738</b>	0.392	-1.13	23.04	23.50	<b>0.820</b>	2022/10/08	3#
Right Side	9400/1880	RMC12.2K	0.077	0.039	2.87	23.04	23.50	0.086	2022/10/08	
Top Side	9400/1880	RMC12.2K	0.384	0.202	1.40	23.04	23.50	0.427	2022/10/08	
Back Side	9262/1852.4	RMC12.2K	0.598	0.318	1.25	22.93	23.50	0.682	2022/10/08	
Back Side	9538/1907.6	RMC12.2K	0.635	0.334	-0.46	23.07	23.50	0.701	2022/10/08	

NOTE: Body SAR test results of WCDMA Band 2

### 10.1.4. SAR measurement Result of WCDMA Band 4

Test Position of Body with	Test channel	Mode	SAR Value (W/kg)	Power Drift(%)	Conducted Power	Tune-up Power	Scaled SAR	Date	Plot
-------------------------------	-----------------	------	---------------------	-------------------	--------------------	------------------	---------------	------	------

Omm	/Freq		1-g	10-g		(dBm)	(dBm)	1-g (W/Kg)		
Front Side	1413/1732.6	RMC12.2K	0.707	0.348	2.23	22.70	23.00	0.758	2022/9/21	
Back Side	1413/1732.6	RMC12.2K	<b>0.970</b>	0.497	3.11	22.70	23.00	<b>1.039</b>	2022/9/21	4#
Back Side Repeated	1413/1732.6	RMC12.2K	0.967	0.494	1.20	22.70	23.00	1.036	2022/9/21	
Right Side	1413/1732.6	RMC12.2K	0.101	0.049	3.47	22.70	23.00	0.108	2022/9/21	
Top Side	1413/1732.6	RMC12.2K	0.534	0.268	2.27	22.70	23.00	0.572	2022/9/21	
Back Side	1312/1712.4	RMC12.2K	0.955	0.489	-1.92	22.71	23.00	1.021	2022/9/21	
Back Side	1513/1752.6	RMC12.2K	0.934	0.482	-1.16	22.76	23.00	0.987	2022/9/21	

NOTE: Body SAR test results of WCDMA Band 4

### 10.1.5. SAR measurement Result of WCDMA Band 5

Test Position of Body with 0mm	Test channel /Freq.	Mode	SAR Value (W/kg)		Power Drift(%)	Conducted Power (dBm)	Tune-up Power (dBm)	Scaled SAR 1-g (W/Kg)	Date	Plot
			1-g	10-g						
Front Side	4182/836.4	RMC12.2K	0.322	0.177	2.33	22.63	23.00	0.351	2022/9/23	
Back Side	4182/836.4	RMC12.2K	<b>0.437</b>	0.240	-1.38	22.63	23.00	<b>0.476</b>	2022/9/23	5#
Right Side	4182/836.4	RMC12.2K	0.046	0.025	-3.86	22.63	23.00	0.050	2022/9/23	
Top Side	4182/836.4	RMC12.2K	0.240	0.132	-0.27	22.63	23.00	0.261	2022/9/23	

NOTE: Body SAR test results of WCDMA Band 5

### 10.1.6. SAR measurement Result of LTE Band 2

Test Position of Body with 0mm	Test channel /Freq.	Mode	SAR Value (W/kg)		Power Drift(%)	Conducted Power (dBm)	Tune-up Power (dBm)	Scaled SAR 1-g (W/Kg)	Date	Plot
			1-g	10-g						
1RB										
Front Side	18900/1880	20M QPSK(1,49)	0.497	0.232	-3.26	24.97	25.50	0.562	2022/10/08	
Back Side	18900/1880	20M QPSK(1,49)	<b>0.686</b>	0.334	-0.96	24.97	25.50	<b>0.775</b>	2022/10/08	9#
Right Side	18900/1880	20M QPSK(1,49)	0.071	0.034	1.21	24.97	25.50	0.080	2022/10/08	
Top Side	18900/1880	20M QPSK(1,49)	0.377	0.180	-2.75	24.97	25.50	0.426	2022/10/08	
50%RB										
Front Side	18900/1880	20M	0.275	0.117	1.46	23.86	24.50	0.319	2022/10/08	

		QPSK(50,49)								
Back Side	18900/1880	20M QPSK(50,49)	0.375	0.184	-3.32	23.86	24.50	0.435	2022/10/08	
Right Side	18900/1880	20M QPSK(50,49)	0.043	0.019	2.36	23.86	24.50	0.050	2022/10/08	
Top Side	18900/1880	20M QPSK(50,49)	0.188	0.089	-1.18	23.86	24.50	0.218	2022/10/08	

NOTE: Body SAR test results of LTE Band 2

### 10.1.7. SAR measurement Result of LTE Band 4

Test Position of Body with 0mm	Test channel /Freq.	Mode	SAR Value (W/kg)		Power Drift(%)	Conducted Power (dBm)	Tune-up Power (dBm)	Scaled SAR 1-g (W/Kg)	Date	Plot
			1-g	10-g						
1RB										
Front Side	20175/1732.5	20M QPSK(1,49)	0.497	0.254	-2.62	24.79	25.00	0.522	2022/9/21	
Back Side	20175/1732.5	20M QPSK(1,49)	<b>0.663</b>	0.339	-1.06	24.79	25.00	<b>0.696</b>	2022/9/21	10#
Right Side	20175/1732.5	20M QPSK(1,49)	0.070	0.036	-0.68	24.79	25.00	0.073	2022/9/21	
Top Side	20175/1732.5	20M QPSK(1,49)	0.332	0.166	-1.19	24.79	25.00	0.348	2022/9/21	
50%RB										
Front Side	20175/1732.5	20M QPSK(50,0)	0.257	0.139	-1.87	23.88	24.00	0.264	2022/9/21	
Back Side	20175/1732.5	20M QPSK(50,0)	0.367	0.194	2.72	23.88	24.00	0.377	2022/9/21	
Right Side	20175/1732.5	20M QPSK(50,0)	0.038	0.019	-4.56	23.88	24.00	0.039	2022/9/21	
Top Side	20175/1732.5	20M QPSK(50,0)	0.198	0.102	2.70	23.88	24.00	0.204	2022/9/21	

NOTE: Body SAR test results of LTE Band 4

### 10.1.8. SAR measurement Result of LTE Band 5

Test Position of Body with 0mm	Test channel /Freq.	Mode	SAR Value (W/kg)		Power Drift(%)	Conducted Power (dBm)	Tune-up Power (dBm)	Scaled SAR 1-g (W/Kg)	Date	Plot
			1-g	10-g						

1RB										
Front Side	20525/836.5	10M QPSK(1,24)	0.497	0.263	-0.90	23.98	24.00	0.499	2022/9/23	
Back Side	20525/836.5	10M QPSK(1,24)	<b>0.677</b>	0.366	-1.38	23.98	24.00	<b>0.680</b>	2022/9/23	11#
Right Side	20525/836.5	10M QPSK(1,24)	0.069	0.037	2.50	23.98	24.00	0.069	2022/9/23	
Top Side	20525/836.5	10M QPSK(1,24)	0.345	0.181	1.10	23.98	24.00	0.347	2022/9/23	
50%RB										
Front Side	20525/836.5	10M QPSK(25,0)	0.287	0.155	-4.08	22.95	23.50	0.326	2022/9/23	
Back Side	20525/836.5	10M QPSK(25,0)	0.385	0.196	-3.31	22.95	23.50	0.437	2022/9/23	
Right Side	20525/836.5	10M QPSK(25,0)	0.038	0.021	2.03	22.95	23.50	0.043	2022/9/23	
Top Side	20525/836.5	10M QPSK(25,0)	0.212	0.107	-3.70	22.95	23.50	0.241	2022/9/23	

NOTE: Body SAR test results of LTE Band 5

### 10.1.9. SAR measurement Result of LTE Band 7

Test Position of Body with 0mm	Test channel /Freq.	Mode	SAR Value (W/kg)		Power Drift(%)	Conducted Power (dBm)	Tune-up Power (dBm)	Scaled SAR 1-g (W/Kg)	Date	Plot
			1-g	10-g						
1RB										
Front Side	21100/2535	20M QPSK(1,49)	0.644	0.249	-2.51	25.37	25.50	0.664	2022/9/22	
Back Side	21100/2535	20M QPSK(1,49)	0.902	0.359	-0.67	25.37	25.50	0.929	2022/9/22	
Right Side	21100/2535	20M QPSK(1,49)	0.093	0.036	2.02	25.37	25.50	0.096	2022/9/22	
Top Side	21100/2535	20M QPSK(1,49)	0.491	0.188	2.63	25.37	25.50	0.506	2022/9/22	
Back Side	20850/2510	20M QPSK(1,49)	<b>0.910</b>	0.367	-3.25	25.40	25.50	<b>0.931</b>	2022/9/22	12#
Back Side Repeated	20850/2510	20M QPSK(1,49)	0.904	0.362	1.30	25.40	25.50	0.925	2022/9/22	
Back Side	21350/2560	20M QPSK(1,49)	0.890	0.351	-1.64	25.33	25.50	0.926	2022/9/22	

50%RB										
Front Side	21100/2535	20M QPSK(50,24)	0.348	0.143	1.06	24.38	24.50	0.358	2022/9/22	
Back Side	21100/2535	20M QPSK(50,24)	0.474	0.192	-3.54	24.38	24.50	0.487	2022/9/22	
Right Side	21100/2535	20M QPSK(50,24)	0.051	0.021	4.05	24.38	24.50	0.052	2022/9/22	
Top Side	21100/2535	20M QPSK(50,24)	0.246	0.099	-0.96	24.38	24.50	0.253	2022/9/22	
100%RB										
Back Side	21100/2535	20M QPSK(100,0)	0.356	0.140	4.48	24.26	24.50	0.376	2022/9/22	

NOTE: Body SAR test results of LTE Band 7

### 10.1.10. SAR measurement Result of LTE Band 12

Test Position of Body with 0mm	Test channel /Freq.	Mode	SAR Value (W/kg)		Power Drift(%)	Conducted Power (dBm)	Tune-up Power (dBm)	Scaled SAR 1-g (W/Kg)	Date	Plot
			1-g	10-g						
1RB										
Front Side	23095/707.5	10M QPSK(1,24)	0.350	0.218	-1.18	23.84	24.00	0.363	2022/9/20	
Back Side	23095/707.5	10M QPSK(1,24)	<b>0.484</b>	0.311	-1.49	23.84	24.00	<b>0.502</b>	2022/9/20	13#
Right Side	23095/707.5	10M QPSK(1,24)	0.053	0.034	-0.60	23.84	24.00	0.055	2022/9/20	
Top Side	23095/707.5	10M QPSK(1,24)	0.261	0.168	-0.86	23.84	24.00	0.271	2022/9/20	
50%RB										
Front Side	23095/707.5	10M QPSK(25,24)	0.196	0.120	-4.26	22.90	23.00	0.201	2022/9/20	
Back Side	23095/707.5	10M QPSK(25,24)	0.276	0.164	-1.30	22.90	23.00	0.282	2022/9/20	
Right Side	23095/707.5	10M QPSK(25,24)	0.031	0.020	-3.69	22.90	23.00	0.032	2022/9/20	
Top Side	23095/707.5	10M QPSK(25,24)	0.146	0.083	-3.00	22.90	23.00	0.149	2022/9/20	

NOTE: Body SAR test results of LTE Band 12

**10.1.11. SAR measurement Result of LTE Band 17**

Test Position of Body with 0mm	Test channel /Freq.	Mode	SAR Value (W/kg)		Power Drift(%)	Conducted Power (dBm)	Tune-up Power (dBm)	Scaled SAR 1-g (W/Kg)	Date	Plot
			1-g	10-g						
1RB										
Front Side	23790/710	10M QPSK(1,24)	0.364	0.231	3.01	24.08	24.50	0.401	2022/9/20	
Back Side	23790/710	10M QPSK(1,24)	<b>0.507</b>	0.325	-0.92	24.08	24.50	<b>0.558</b>	2022/9/20	14#
Right Side	23790/710	10M QPSK(1,24)	0.055	0.034	2.81	24.08	24.50	0.061	2022/9/20	
Top Side	23790/710	10M QPSK(1,24)	0.259	0.161	3.80	24.08	24.50	0.285	2022/9/20	
50%RB										
Front Side	23790/710	10M QPSK(25,12)	0.183	0.136	3.21	23.08	23.50	0.202	2022/9/20	
Back Side	23790/710	10M QPSK(25,12)	0.290	0.168	4.63	23.08	23.50	0.319	2022/9/20	
Right Side	23790/710	10M QPSK(25,12)	0.030	0.020	2.94	23.08	23.50	0.033	2022/9/20	
Top Side	23790/710	10M QPSK(25,12)	0.135	0.079	1.21	23.08	23.50	0.149	2022/9/20	

NOTE: Body SAR test results of LTE Band 17

**10.1.12. SAR measurement Result of LTE Band 25**

Test Position of Body with 0mm	Test channel /Freq.	Mode	SAR Value (W/kg)		Power Drift(%)	Conducted Power (dBm)	Tune-up Power (dBm)	Scaled SAR 1-g (W/Kg)	Date	Plot
			1-g	10-g						
1RB										
Front Side	26365/1882.5	20M QPSK(1,49)	0.504	0.241	-1.71	24.98	25.50	0.568	2022/10/08	
Back Side	26365/1882.5	20M QPSK(1,49)	<b>0.678</b>	0.328	-1.75	24.98	25.50	<b>0.764</b>	2022/10/08	15#
Right Side	26365/1882.5	20M QPSK(1,49)	0.071	0.034	0.98	24.98	25.50	0.080	2022/10/08	



Top Side	26365/1882.5	20M QPSK(1,49)	0.366	0.170	-3.54	24.98	25.50	0.413	2022/10/08	
50%RB										
Front Side	26365/1882.5	20M QPSK(25,24)	0.277	0.132	-0.42	24.06	24.50	0.307	2022/10/08	
Back Side	26365/1882.5	20M QPSK(25,24)	0.344	0.184	-2.50	24.06	24.50	0.381	2022/10/08	
Right Side	26365/1882.5	20M QPSK(25,24)	0.037	0.020	1.93	24.06	24.50	0.041	2022/10/08	
Top Side	26365/1882.5	20M QPSK(25,24)	0.186	0.095	3.97	24.06	24.50	0.206	2022/10/08	

NOTE: Body SAR test results of LTE Band 25

### 10.1.13. SAR measurement Result of LTE Band 26A

Test Position of Body with 0mm	Test channel /Freq.	Mode	SAR Value (W/kg)		Power Drift(%)	Conducted Power (dBm)	Tune-up Power (dBm)	Scaled SAR 1-g (W/Kg)	Date	Plot
			1-g	10-g						
1RB										
Front Side	26740/819	10M QPSK(1,0)	0.483	0.253	-1.79	19.81	20.00	0.505	2022/9/23	
Back Side	26740/819	10M QPSK(1,0)	<b>0.690</b>	0.376	-0.87	19.81	20.00	<b>0.721</b>	2022/9/23	16#
Top Side	26740/819	10M QPSK(1,0)	0.345	0.182	-1.73	19.81	20.00	0.360	2022/9/23	
50%RB										
Front Side	26740/819	10M QPSK(25,12)	0.268	0.137	-3.06	18.71	19.00	0.287	2022/9/23	
Back Side	26740/819	10M QPSK(25,12)	0.406	0.222	-3.64	18.71	19.00	0.434	2022/9/23	
Top Side	26740/819	10M QPSK(25,12)	0.190	0.095	-2.73	18.71	19.00	0.203	2022/9/23	

NOTE: Body SAR test results of LTE Band 26A

### 10.1.14. SAR measurement Result of LTE Band 26B

Test Position of Body with 0mm	Test channel /Freq.	Mode	SAR Value (W/kg)		Power Drift(%)	Conducted Power (dBm)	Tune-up Power (dBm)	Scaled SAR 1-g (W/Kg)	Date	Plot
			1-g	10-g						

1RB										
Front Side	26865/831.5	15M QPSK(1,37)	0.476	0.250	2.45	19.76	20.00	0.503	2022/9/23	
Back Side	26865/831.5	15M QPSK(1,37)	<b>0.674</b>	0.369	-0.35	19.76	20.00	<b>0.712</b>	2022/9/23	17#
Top Side	26865/831.5	15M QPSK(1,37)	0.364	0.191	-2.99	19.76	20.00	0.385	2022/9/23	
50%RB										
Front Side	26865/831.5	15M QPSK(36,0)	0.253	0.131	-3.15	18.69	19.00	0.272	2022/9/23	
Back Side	26865/831.5	15M QPSK(36,0)	0.348	0.194	-3.41	18.69	19.00	0.374	2022/9/23	
Top Side	26865/831.5	15M QPSK(36,0)	0.188	0.105	-2.36	18.69	19.00	0.202	2022/9/23	

NOTE: Body SAR test results of LTE Band 26B

### 10.1.15. SAR measurement Result of LTE Band 41

Test Position of Body with 0mm	Test channel /Freq.	Mode	SAR Value (W/kg)		Power Drift(%)	Conducted Power (dBm)	Tune-up Power (dBm)	Scaled SAR 1-g (W/Kg)	Date	Plot
			1-g	10-g						
1RB										
Front Side	40640/2595	20M QPSK(1,49)	0.693	0.276	-2.19	20.82	21.00	0.722	2022/9/22	
Back Side	40640/2595	20M QPSK(1,49)	0.971	0.391	0.90	20.82	21.00	1.012	2022/9/22	
Right Side	40640/2595	20M QPSK(1,49)	0.100	0.040	3.07	20.82	21.00	0.104	2022/9/22	
Top Side	40640/2595	20M QPSK(1,49)	0.495	0.199	3.52	20.82	21.00	0.516	2022/9/22	
Back Side	40640/2595	20M QPSK(1,49)	0.985	0.432	-0.48	20.40	21.00	1.131	2022/9/22	18#
Back Side Repeated	40090/2540	20M QPSK(1,49)	0.980	0.428	1.20	20.40	21.00	1.125	2022/9/22	
Back Side	41190/2650	20M QPSK(1,49)	0.968	0.405	-1.36	20.95	21.00	0.979	2022/9/22	
50%RB										
Front Side	40640/2595	20M QPSK(50,0)	0.356	0.151	-1.22	19.60	20.00	0.390	2022/9/22	
Back Side	40640/2595	20M	0.487	0.233	-0.31	19.60	20.00	0.534	2022/9/22	

		QPSK(50,0)								
Right Side	40640/2595	20M QPSK(50,0)	0.053	0.022	-3.27	19.60	20.00	0.058	2022/9/22	
Top Side	40640/2595	20M QPSK(50,0)	0.283	0.106	-3.05	19.60	20.00	0.310	2022/9/22	
100%RB										
Back Side	40640/2595	20M QPSK(100,0)	0.390	0.165	1.44	19.63	20.00	0.425	2022/9/22	

NOTE: Body SAR test results of LTE Band 41

**10.1.16. SAR measurement Result of LTE Band 66**

Test Position of Body with 0mm	Test channel /Freq.	Mode	SAR Value (W/kg)		Power Drift(%)	Conducted Power (dBm)	Tune-up Power (dBm)	Scaled SAR 1-g (W/Kg)	Date	Plot
			1-g	10-g						
1RB										
Front Side	132322/1745	20M QPSK(1,49)	0.546	0.269	-2.05	23.20	24.00	0.656	2022/9/21	
Back Side	132322/1745	20M QPSK(1,49)	<b>0.761</b>	0.390	-1.21	23.20	24.00	<b>0.915</b>	2022/9/21	19#
Right Side	132322/1745	20M QPSK(1,49)	0.079	0.039	-3.47	23.20	24.00	0.095	2022/9/21	
Top Side	132322/1745	20M QPSK(1,49)	0.419	0.208	0.32	23.20	24.00	0.504	2022/9/21	
Back Side	132072/1720	20M QPSK(1,49)	0.639	0.327	-2.45	23.23	24.00	0.763	2022/9/21	
Back Side	132572/1770	20M QPSK(1,49)	0.677	0.340	2.23	23.51	24.00	0.758	2022/9/21	
50%RB										
Front Side	132322/1745	20M QPSK(50,24)	0.323	0.142	-2.64	22.26	22.50	0.341	2022/9/21	
Back Side	132322/1745	20M QPSK(50,24)	0.428	0.212	-1.45	22.26	22.50	0.452	2022/9/21	
Right Side	132322/1745	20M QPSK(50,24)	0.044	0.023	1.26	22.26	22.50	0.046	2022/9/21	
Top Side	132322/1745	20M QPSK(50,24)	0.223	0.109	2.15	22.26	22.50	0.236	2022/9/21	
100%RB										
Back Side	132322/1745	20M QPSK(100,0)	0.410	0.203	1.20	22.29	22.50	0.430	2022/9/21	

NOTE: Body SAR test results of LTE Band 66

**10.1.17. SAR measurement Result of WLAN 2.4G**

Test Position of Body with 0mm	Test channel /Freq.	Mode	SAR Value (W/kg)		Power Drift(%)	Conducted Power (dBm)	Tune-up Power (dBm)	Scaled SAR 1-g (W/Kg)	Date	Plot
			1-g	10-g						
Front Side	1/2412	802.11b	0.175	0.082	-2.36	15.60	16.00	0.192	2022/9/24	
Back Side	1/2412	802.11b	<b>0.216</b>	0.106	-1.03	15.60	16.00	<b>0.237</b>	2022/9/24	8#
Top Side	1/2412	802.11b	0.130	0.061	1.25	15.60	16.00	0.143	2022/9/24	

NOTE: Body SAR test results of WLAN 2.4G

**10.1.18. SAR measurement Result of WLAN 5.2G**

Test Position of Body with 0mm	Test channel /Freq	Mode	SAR Value (W/kg)		Power Drift(%)	Conducted Power (dBm)	Tune-up Power (dBm)	Scaled SAR 1-g (W/Kg)	Date	Plot
			1-g	10-g						
Front Side	36/5180	802.11a	0.217	0.088	1.98	10.57	11.00	0.240	2022/9/29	
Back Side	36/5180	802.11a	<b>0.282</b>	0.118	-0.06	10.57	11.00	<b>0.311</b>	2022/9/29	6#
Top Side	36/5180	802.11a	0.145	0.058	0.75	10.57	11.00	0.160	2022/9/29	

NOTE: Body SAR test results of WLAN 5.2G

**10.1.19. SAR measurement Result of WLAN 5.8G**

Test Position of Body with 0mm	Test channel /Freq	Mode	SAR Value (W/kg)		Power Drift(%)	Conducted Power (dBm)	Tune-up Power (dBm)	Scaled SAR 1-g (W/Kg)	Date	Plot
			1-g	10-g						
Front Side	165/5825	802.11n HT20	0.273	0.105	0.17	10.26	10.50	0.289	2022/9/30	
Back Side	165/5825	802.11n HT20	<b>0.343</b>	0.132	-4.17	10.26	10.50	<b>0.362</b>	2022/9/30	7#
Top Side	165/5825	802.11n HT20	0.190	0.069	1.91	10.26	10.50	0.201	2022/9/30	

NOTE: Body SAR test results of WLAN 5.8G

**10.2. SAR Summation Scenario**

Per KDB 447498 D01, simultaneous transmission SAR is compliant if,

- 1) Scalar SAR summation < 1.6W/kg.
- 2)  $SPLSR = (SAR_1 + SAR_2)^{1.5} / (\text{min. separation distance, mm})$ , and the peak separation distance is

determined from the square root of  $[(x_1-x_2)^2 + (y_1-y_2)^2 + (z_1-z_2)^2]$ , where  $(x_1, y_1, z_1)$  and  $(x_2, y_2, z_2)$  are the coordinates of the extrapolated peak SAR locations in the zoom scan. If  $SPLSR \leq 0.04$ , simultaneously transmission SAR measurement is not necessary.

Test Position		Scaled SAR <sub>MAX</sub>		Σ 1-g SAR (W/Kg)	SPLSR	Remark
		WWAN	DTS			
Body	Front Side	0.758	0.192	0.950	N/A	N/A
	Back Side	1.131	0.237	1.368	N/A	N/A
	Left Side	0.085	N/A	0.085	N/A	N/A
	Right Side	0.108	N/A	0.108	N/A	N/A
	Top Side	0.572	0.143	0.715	N/A	N/A
	Bottom Side	0.043	N/A	0.043	N/A	N/A

Test Position		Scaled SAR <sub>MAX</sub>		Σ 1-g SAR (W/Kg)	SPLSR	Remark
		WWAN	NII			
Body	Front Side	0.758	0.289	1.047	N/A	N/A
	Back Side	1.131	0.362	1.493	N/A	N/A
	Left Side	0.085	N/A	0.085	N/A	N/A
	Right Side	0.108	N/A	0.108	N/A	N/A
	Top Side	0.572	0.201	0.773	N/A	N/A
	Bottom Side	0.043	N/A	0.043	N/A	N/A

Test Position		Scaled SAR <sub>MAX</sub>		Σ 1-g SAR (W/Kg)	SPLSR	Remark
		WWAN	DSS			
Body	Front Side	0.758	0.334	1.092	N/A	N/A
	Back Side	1.131	0.334	1.465	N/A	N/A
	Left Side	0.085	N/A	0.085	N/A	N/A
	Right Side	0.108	N/A	0.108	N/A	N/A
	Top Side	0.572	0.334	0.906	N/A	N/A
	Bottom Side	0.043	N/A	0.043	N/A	N/A

## 11. Appendix A. Photo documentation

Refer to appendix Test Setup photo---SAR

## 12. Appendix B. System Check Plots

Table of contents
<b>MEASUREMENT 1 System Performance Check - 750MHz</b>
<b>MEASUREMENT 2 System Performance Check - 835MHz</b>
<b>MEASUREMENT 3 System Performance Check - 1800MHz</b>
<b>MEASUREMENT 4 System Performance Check - 1900MHz</b>
<b>MEASUREMENT 5 System Performance Check - 2450MHz</b>
<b>MEASUREMENT 6 System Performance Check - 2600MHz</b>
<b>MEASUREMENT 7 System Performance Check - 5200MHz</b>
<b>MEASUREMENT 8 System Performance Check - 5800MHz</b>

# MEASUREMENT 1

Date of measurement: 20/9/2022

## A. Experimental conditions.

<b>Area Scan</b>	<u>dx=15mm dy=15mm, h= 5.00 mm</u>
<b>ZoomScan</b>	<u>5x5x7, dx=8mm dy=8mm dz=5mm</u>
<b>Phantom</b>	<u>Validation plane</u>
<b>Device Position</b>	<u>Dipole</u>
<b>Band</b>	<u>CW750</u>
<b>Channels</b>	<u>Middle</u>
<b>Signal</b>	<u>CW (Crest factor: 1.0)</u>
<b>ConvF</b>	<u>1.49</u>

## B. SAR Measurement Results

<b>Frequency (MHz)</b>	750.000000
<b>Relative permittivity (real part)</b>	40.129713
<b>Relative permittivity (imaginary part)</b>	21.396098
<b>Conductivity (S/m)</b>	0.891504
<b>Variation (%)</b>	2.730000

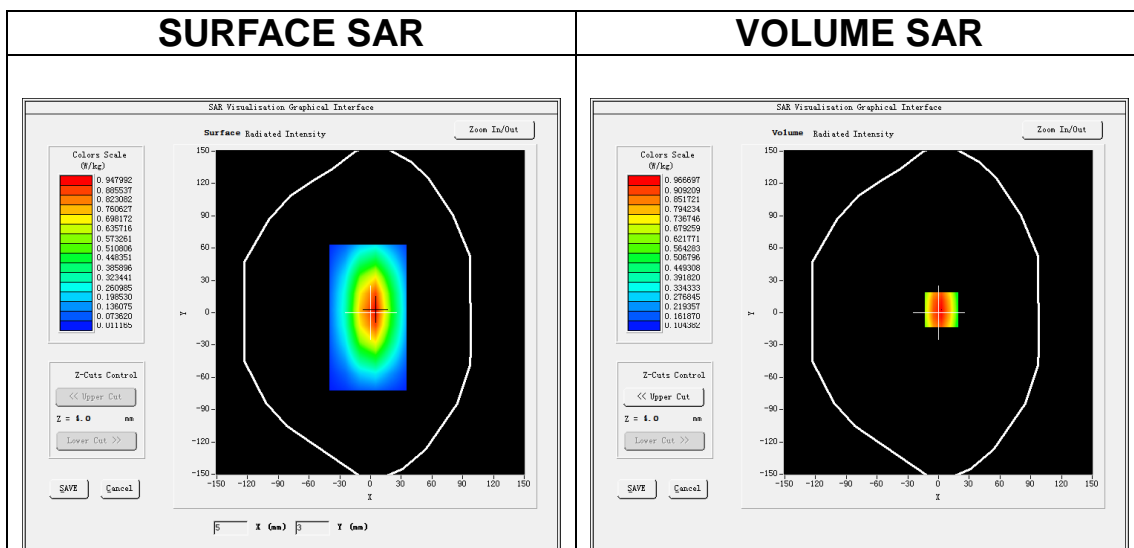

**Maximum location: X=3.00, Y=3.00**

**SAR Peak: 1.30 W/kg**

<b>SAR 10g (W/Kg)</b>	0.594332
<b>SAR 1g (W/Kg)</b>	0.800321

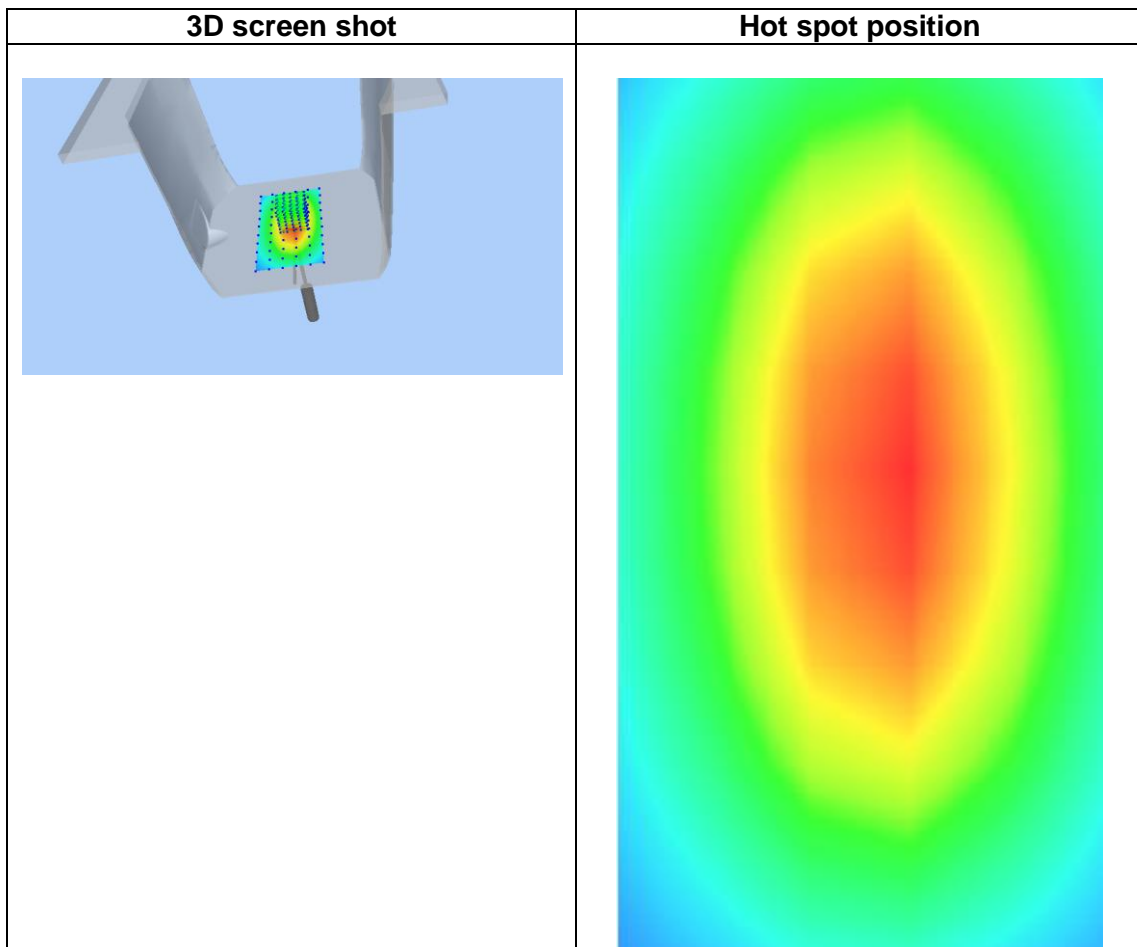
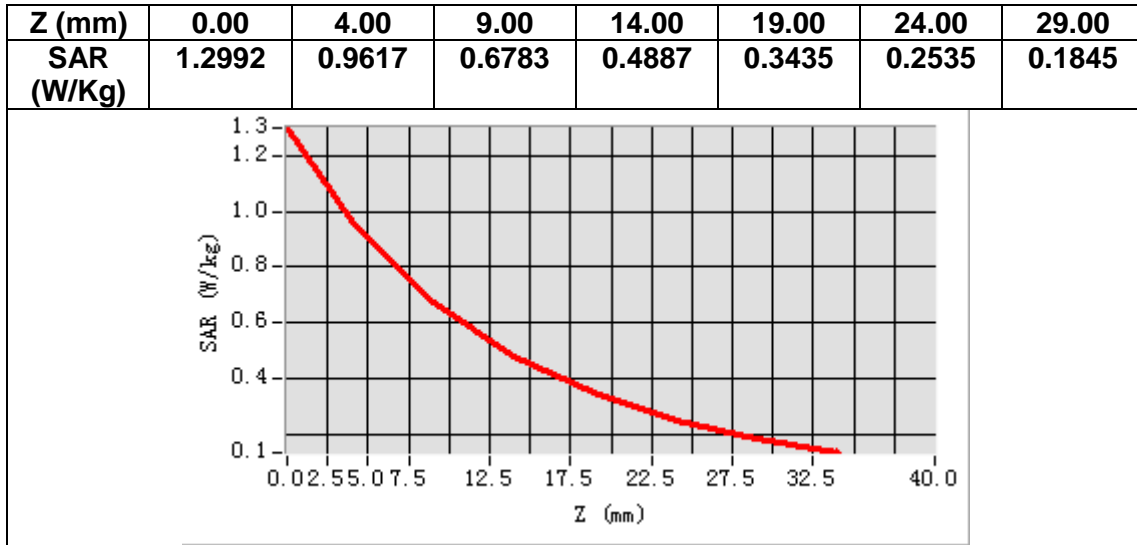



# MEASUREMENT 2

Date of measurement: 23/9/2022

## A. Experimental conditions.

<b>Area Scan</b>	<u>dx=15mm dy=15mm, h= 5.00 mm</u>
<b>ZoomScan</b>	<u>5x5x7, dx=8mm dy=8mm dz=5mm</u>
<b>Phantom</b>	<u>Validation plane</u>
<b>Device Position</b>	<u>Dipole</u>
<b>Band</b>	<u>CW835</u>
<b>Channels</b>	<u>Middle</u>
<b>Signal</b>	<u>CW (Crest factor: 1.0)</u>
<b>ConvF</b>	<u>1.50</u>

## B. SAR Measurement Results

<b>Frequency (MHz)</b>	835.000000
<b>Relative permittivity (real part)</b>	41.373150
<b>Relative permittivity (imaginary part)</b>	19.921989
<b>Conductivity (S/m)</b>	0.924159
<b>Variation (%)</b>	-2.720000

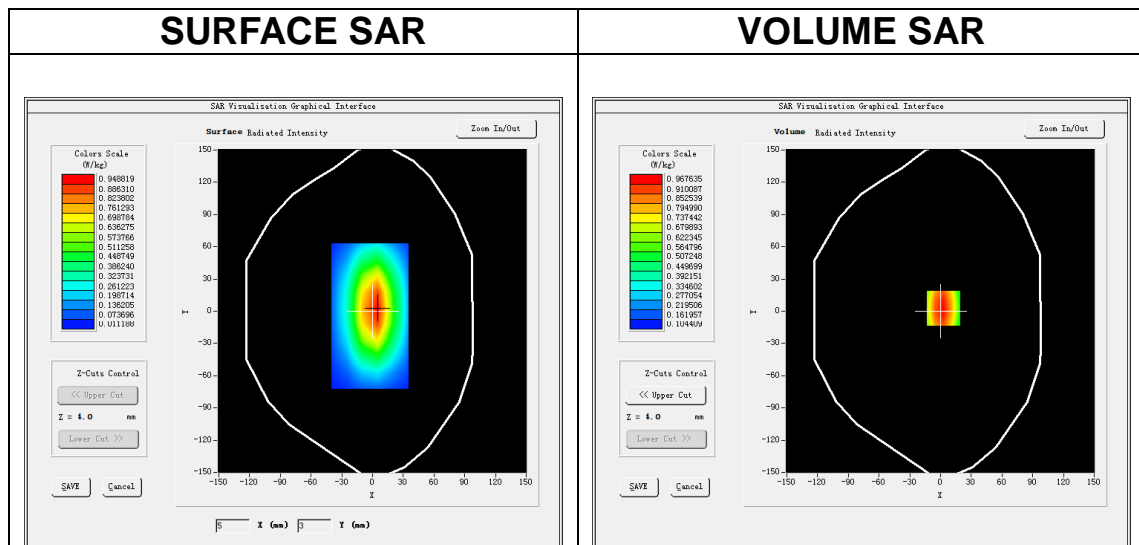

**Maximum location: X=3.00, Y=3.00**

**SAR Peak: 1.30 W/kg**

<b>SAR 10g (W/Kg)</b>	0.641333
<b>SAR 1g (W/Kg)</b>	1.029172

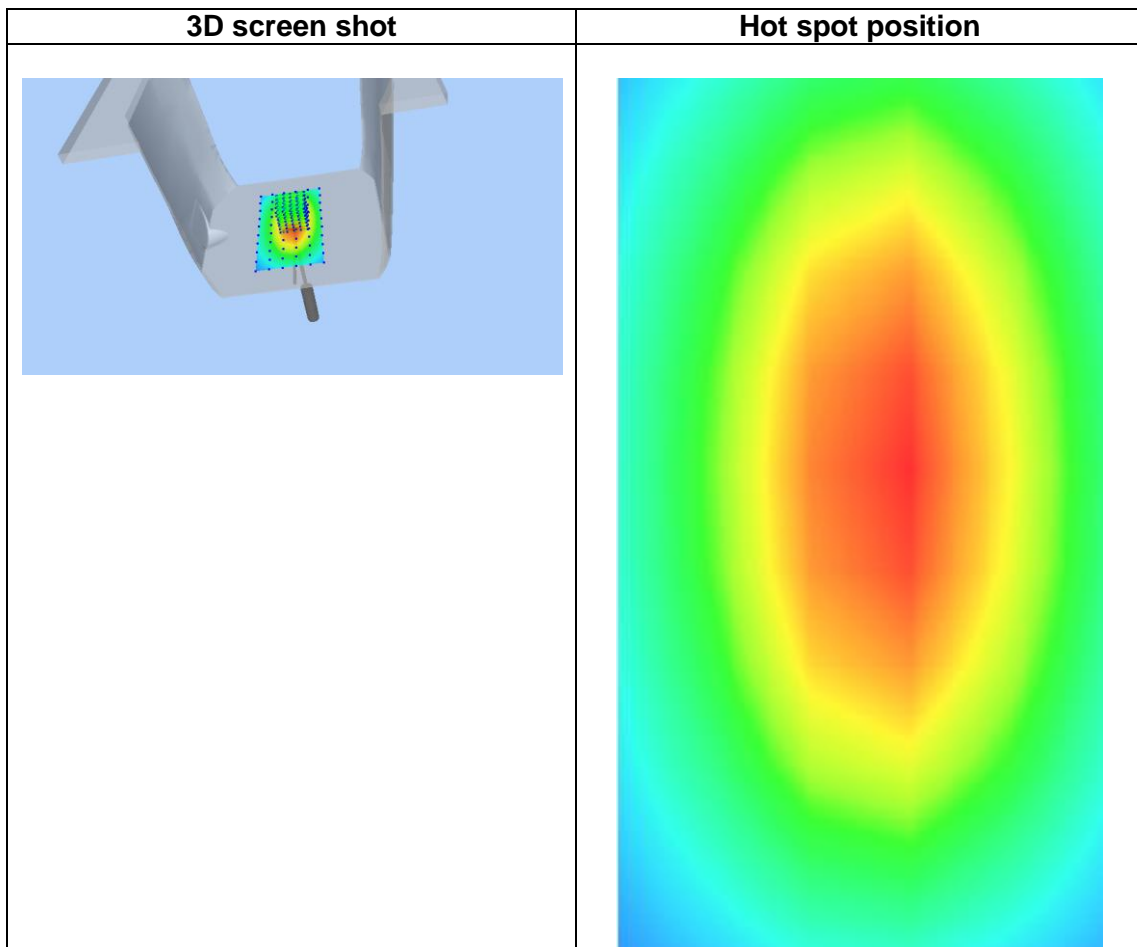
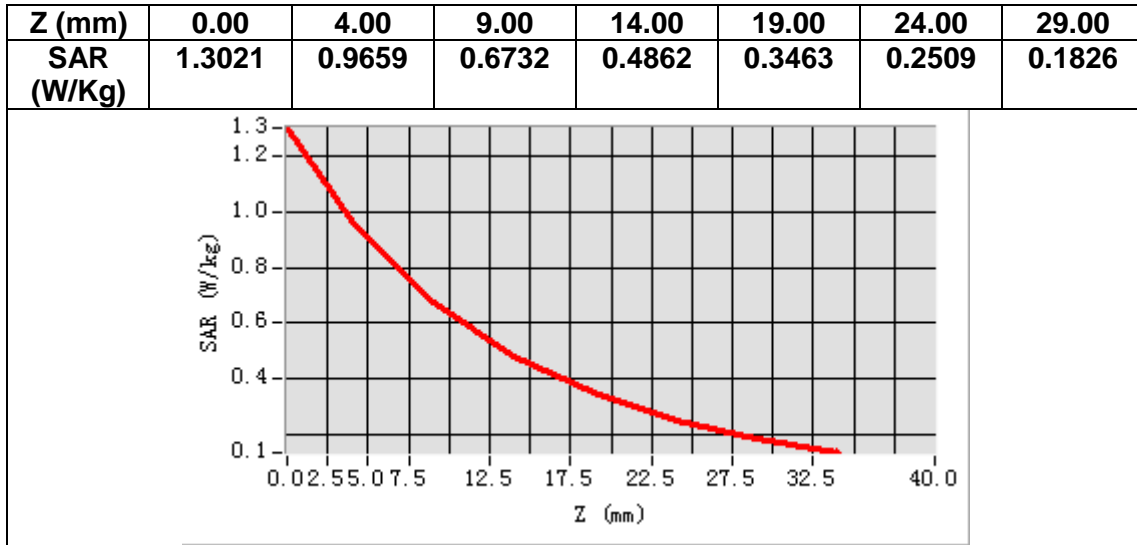

# MEASUREMENT 3

Date of measurement: 21/9/2022

## A. Experimental conditions.

<b>Area Scan</b>	<u>dx=15mm dy=15mm, h= 5.00 mm</u>
<b>ZoomScan</b>	<u>5x5x7, dx=8mm dy=8mm dz=5mm</u>
<b>Phantom</b>	<u>Validation plane</u>
<b>Device Position</b>	<u>Dipole</u>
<b>Band</b>	<u>CW1800</u>
<b>Channels</b>	<u>Middle</u>
<b>Signal</b>	<u>CW (Crest factor: 1.0)</u>
<b>ConvF</b>	<u>1.73</u>

## B. SAR Measurement Results

<b>Frequency (MHz)</b>	1800.000000
<b>Relative permittivity (real part)</b>	38.677062
<b>Relative permittivity (imaginary part)</b>	13.847581
<b>Conductivity (S/m)</b>	1.384758
<b>Variation (%)</b>	2.980000

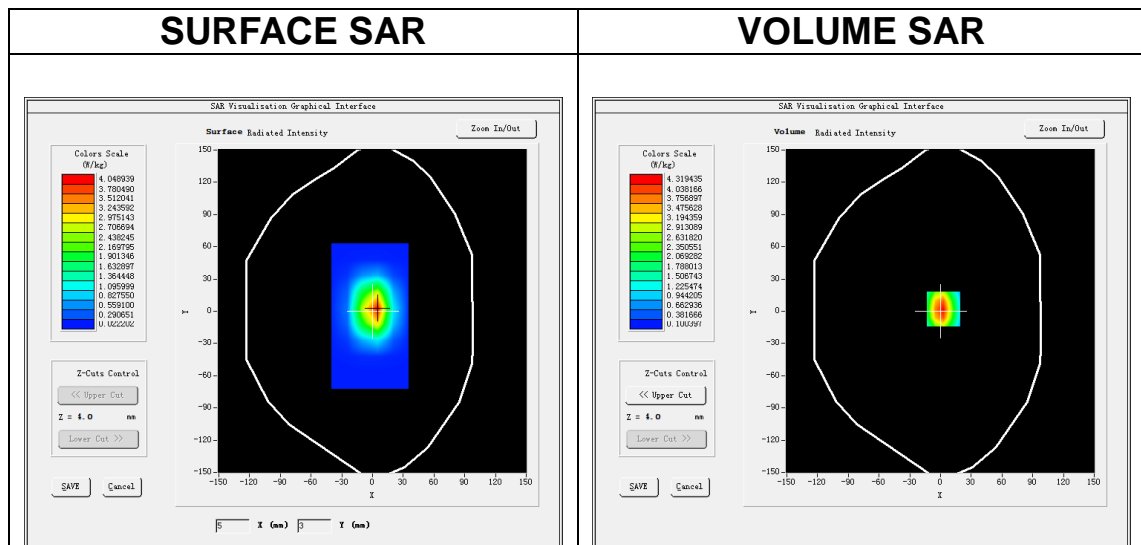

**Maximum location: X=3.00, Y=2.00**  
**SAR Peak: 6.82 W/kg**

<b>SAR 10g (W/Kg)</b>	1.874307
<b>SAR 1g (W/Kg)</b>	3.452066

Z (mm)	0.00	4.00	9.00	14.00	19.00	24.00	29.00
SAR (W/Kg)	6.7474	4.3111	2.4329	1.4203	0.8572	0.5231	0.3234

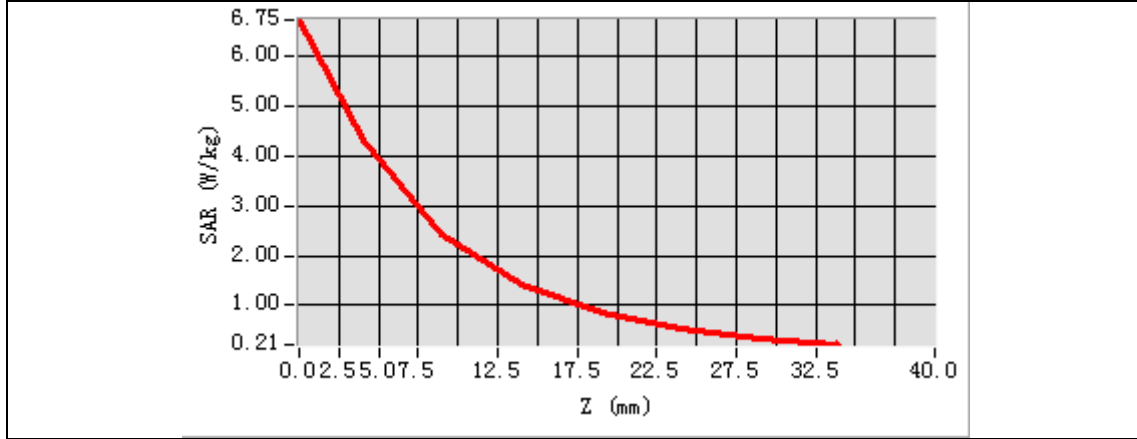

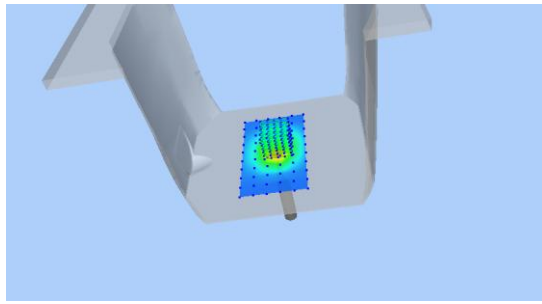
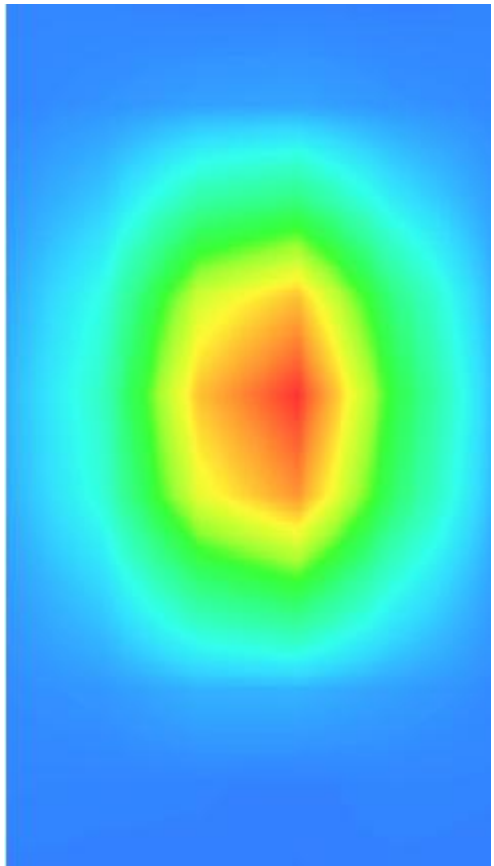
3D screen shot	Hot spot position
	

# MEASUREMENT 4

Date of measurement: 8/10/2022

## A. Experimental conditions.

<b>Area Scan</b>	<u>dx=15mm dy=15mm, h= 5.00 mm</u>
<b>ZoomScan</b>	<u>5x5x7, dx=8mm dy=8mm dz=5mm</u>
<b>Phantom</b>	<u>Validation plane</u>
<b>Device Position</b>	<u>Dipole</u>
<b>Band</b>	<u>CW1900</u>
<b>Channels</b>	<u>Middle</u>
<b>Signal</b>	<u>CW (Crest factor: 1.0)</u>
<b>ConvF</b>	<u>1.91</u>

## B. SAR Measurement Results

<b>Frequency (MHz)</b>	1900.000000
<b>Relative permittivity (real part)</b>	38.348065
<b>Relative permittivity (imaginary part)</b>	13.783294
<b>Conductivity (S/m)</b>	1.454903
<b>Variation (%)</b>	2.220000

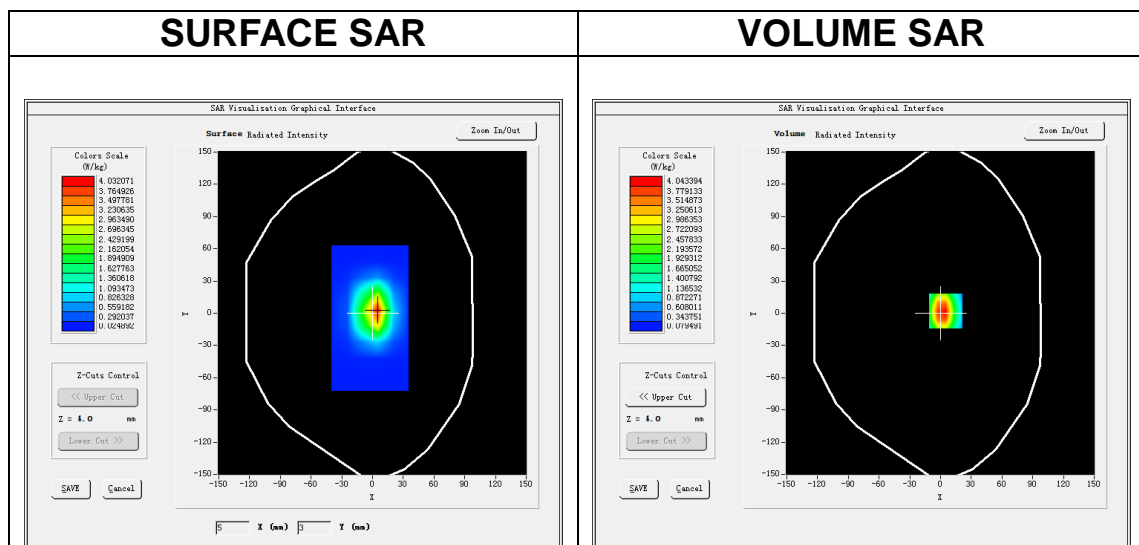

**Maximum location: X=5.00, Y=2.00**  
**SAR Peak: 6.70 W/kg**

<b>SAR 10g (W/Kg)</b>	1.943347
<b>SAR 1g (W/Kg)</b>	4.033221

Z (mm)	0.00	4.00	9.00	14.00	19.00	24.00	29.00
SAR (W/Kg)	6.3247	4.0419	2.2630	1.3026	0.7618	0.4514	0.2794

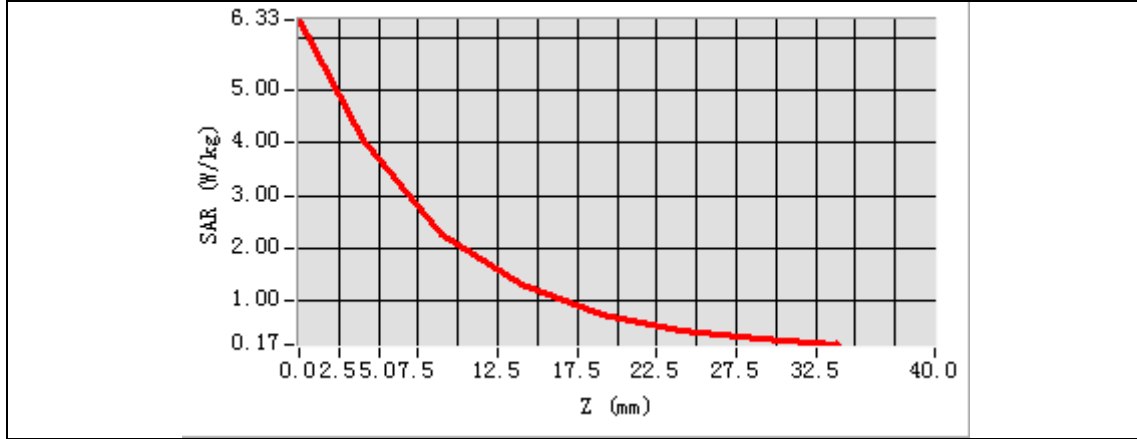

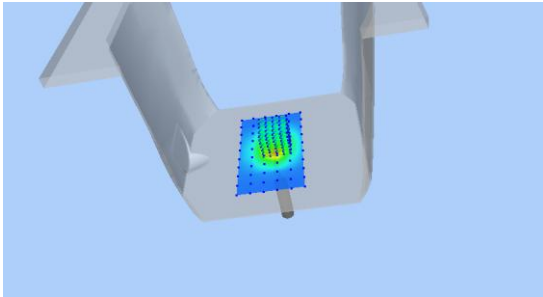
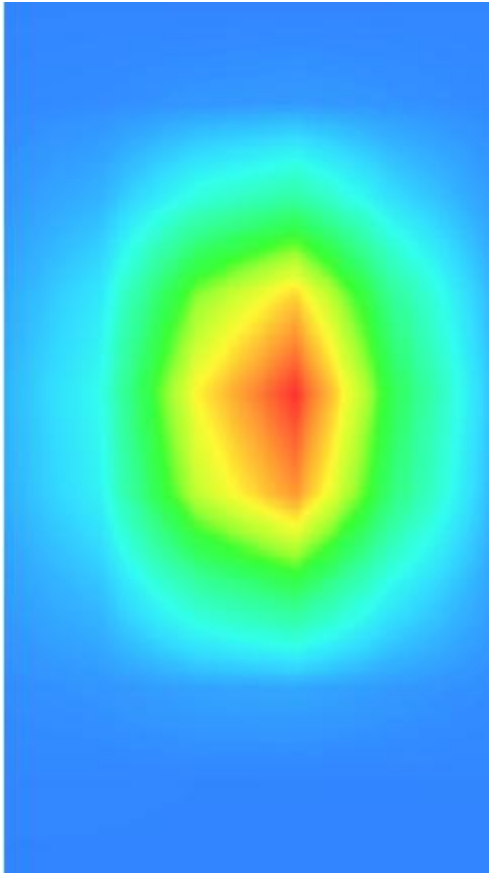
3D screen shot	Hot spot position
	

# MEASUREMENT 5

Date of measurement: 24/9/2022

## A. Experimental conditions.

<b>Area Scan</b>	<u>dx=12mm dy=12mm, h= 5.00 mm</u>
<b>ZoomScan</b>	<u>7x7x7, dx=5mm dy=5mm dz=5mm</u>
<b>Phantom</b>	<u>Validation plane</u>
<b>Device Position</b>	<u>Dipole</u>
<b>Band</b>	<u>CW2450</u>
<b>Channels</b>	<u>Middle</u>
<b>Signal</b>	<u>CW (Crest factor: 1.0)</u>
<b>ConvF</b>	<u>1.98</u>

## B. SAR Measurement Results

<b>Frequency (MHz)</b>	2450.000000
<b>Relative permittivity (real part)</b>	37.794313
<b>Relative permittivity (imaginary part)</b>	13.030085
<b>Conductivity (S/m)</b>	1.773539
<b>Variation (%)</b>	1.290000

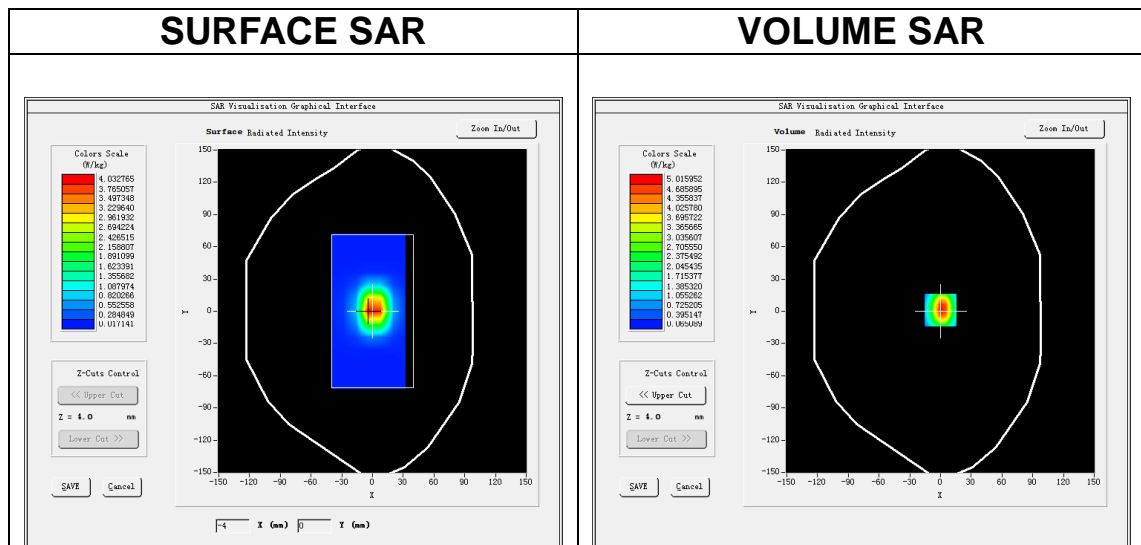

**Maximum location: X=0.00, Y=1.00**  
**SAR Peak: 8.14 W/kg**

<b>SAR 10g (W/Kg)</b>	2.530106
<b>SAR 1g (W/Kg)</b>	5.004340

Z (mm)	0.00	4.00	9.00	14.00	19.00	24.00	29.00
SAR (W/Kg)	8.0397	5.0153	2.6927	1.4826	0.8361	0.4698	0.2660

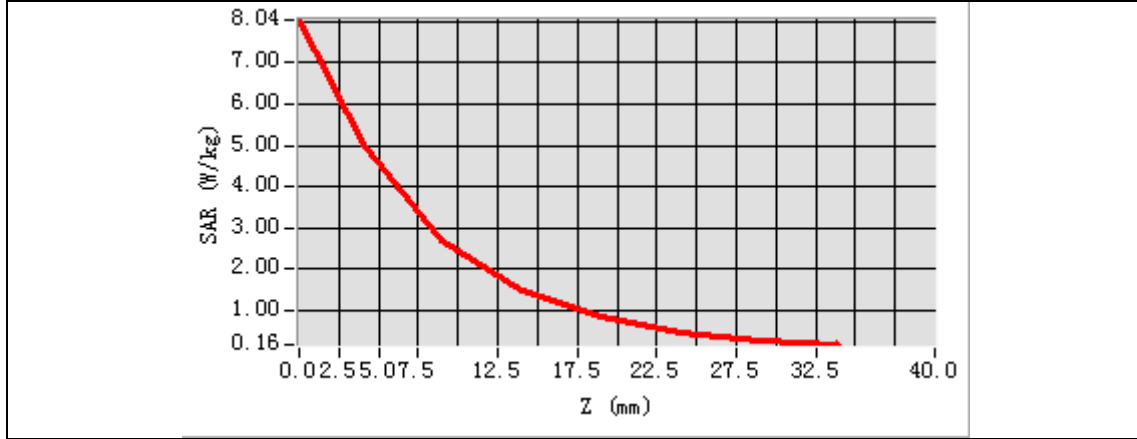

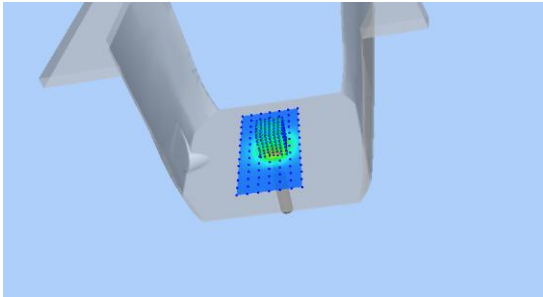
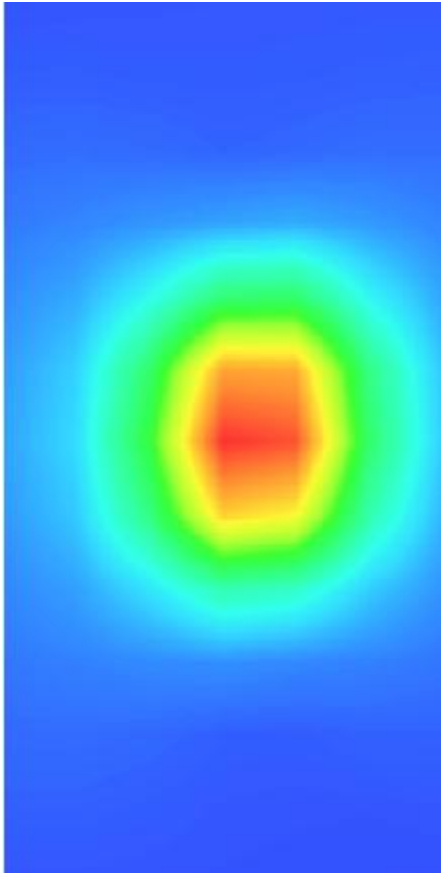
3D screen shot	Hot spot position
	



# MEASUREMENT 6

Date of measurement: 22/9/2022

## A. Experimental conditions.

<b>Area Scan</b>	<u>dx=12mm dy=12mm, h= 5.00 mm</u>
<b>ZoomScan</b>	<u>7x7x7, dx=5mm dy=5mm dz=5mm</u>
<b>Phantom</b>	<u>Validation plane</u>
<b>Device Position</b>	<u>Dipole</u>
<b>Band</b>	<u>CW2600</u>
<b>Channels</b>	<u>Middle</u>
<b>Signal</b>	<u>CW (Crest factor: 1.0)</u>
<b>ConvF</b>	<u>1.87</u>

## B. SAR Measurement Results

<b>Frequency (MHz)</b>	2600.000000
<b>Relative permittivity (real part)</b>	37.685852
<b>Relative permittivity (imaginary part)</b>	13.243335
<b>Conductivity (S/m)</b>	1.912926
<b>Variation (%)</b>	0.250000

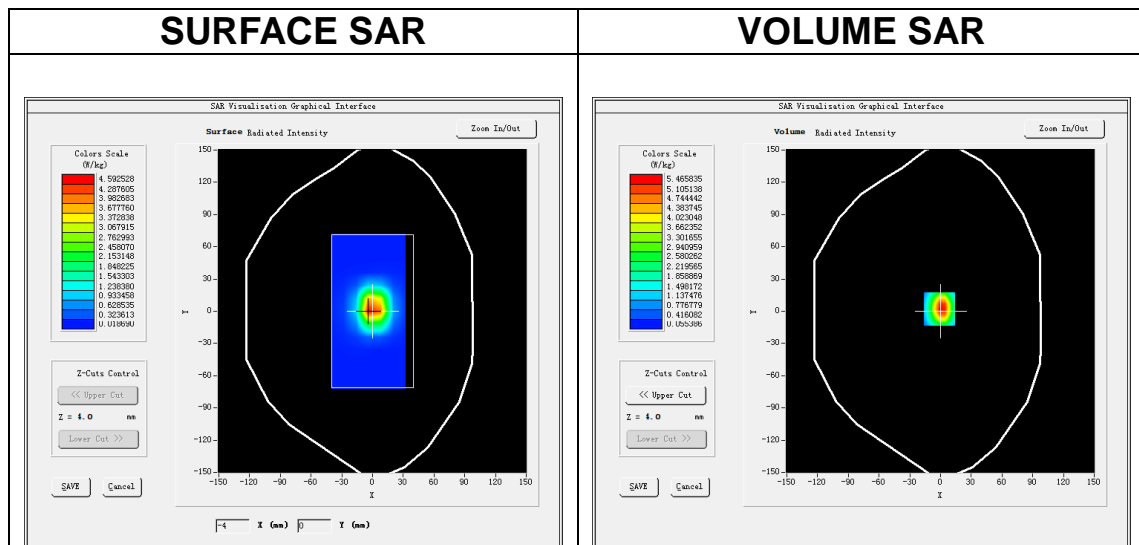

**Maximum location: X=-1.00, Y=2.00**  
**SAR Peak: 9.07 W/kg**

<b>SAR 10g (W/Kg)</b>	2.340037
<b>SAR 1g (W/Kg)</b>	5.753199

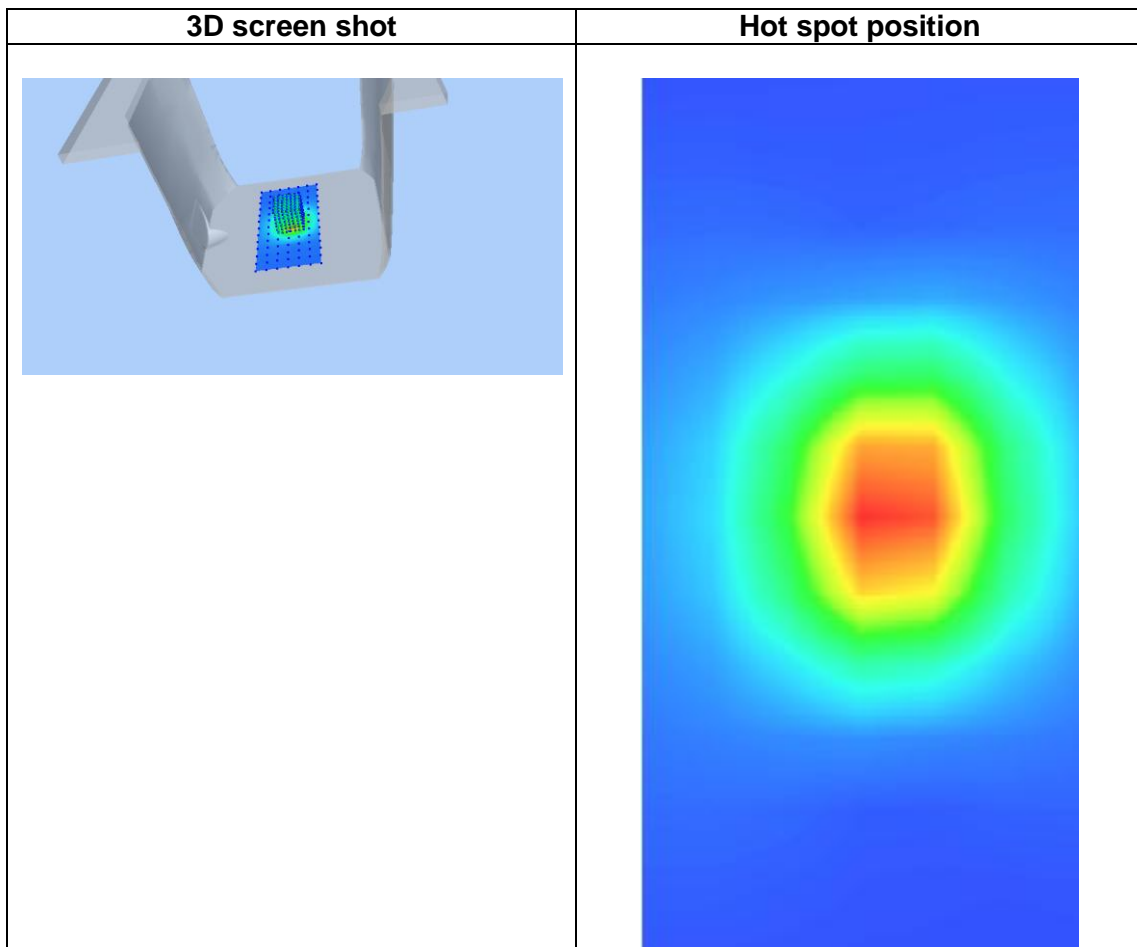
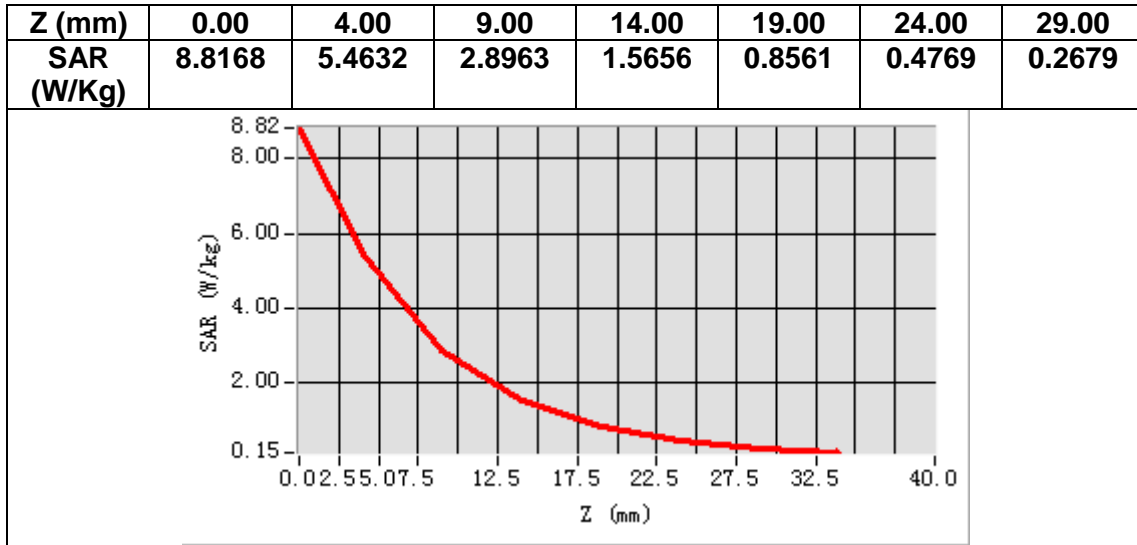

# MEASUREMENT 7

Date of measurement: 29/9/2022

## A. Experimental conditions.

<b>Area Scan</b>	<u>dx=10mm dy=10mm, h= 2.00 mm</u>
<b>ZoomScan</b>	<u>7x7x12,dx=4mm dy=4mm dz=2mm</u>
<b>Phantom</b>	<u>Validation plane</u>
<b>Device Position</b>	<u>Dipole</u>
<b>Band</b>	<u>CW5200</u>
<b>Channels</b>	<u>Middle</u>
<b>Signal</b>	<u>CW (Crest factor: 1.0)</u>
<b>ConvF</b>	<u>1.80</u>

## B. SAR Measurement Results

<b>Frequency (MHz)</b>	5200.000000
<b>Relative permittivity (real part)</b>	35.117572
<b>Relative permittivity (imaginary part)</b>	15.729181
<b>Conductivity (S/m)</b>	4.543986
<b>Variation (%)</b>	2.800000

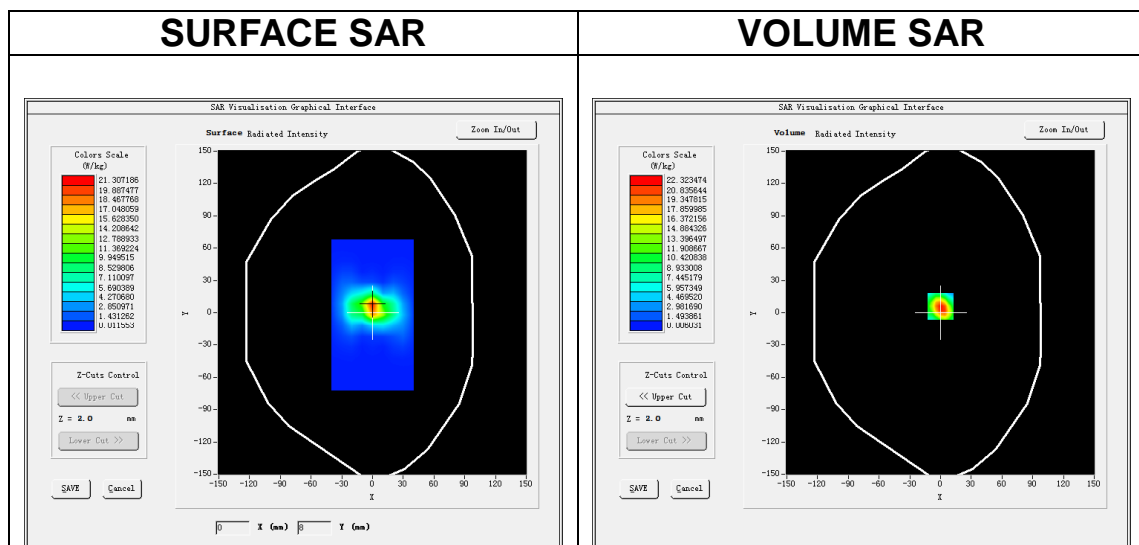

**Maximum location: X=0.00, Y=6.00**

**SAR Peak: 40.06 W/kg**

<b>SAR 10g (W/Kg)</b>	5.538162
<b>SAR 1g (W/Kg)</b>	15.556032

<b>Z (m)</b>	<b>0.00</b>	<b>2.00</b>	<b>4.00</b>	<b>6.00</b>	<b>8.00</b>	<b>10.00</b>	<b>12.00</b>	<b>14.00</b>	<b>16.00</b>	<b>18.00</b>	<b>20.00</b>	<b>22.00</b>
<b>SAR (W/Kg)</b>	<b>37.891</b>	<b>22.391</b>	<b>11.377</b>	<b>5.6694</b>	<b>2.8291</b>	<b>1.4043</b>	<b>0.7150</b>	<b>0.3637</b>	<b>0.1802</b>	<b>0.1008</b>	<b>0.0527</b>	<b>0.0397</b>

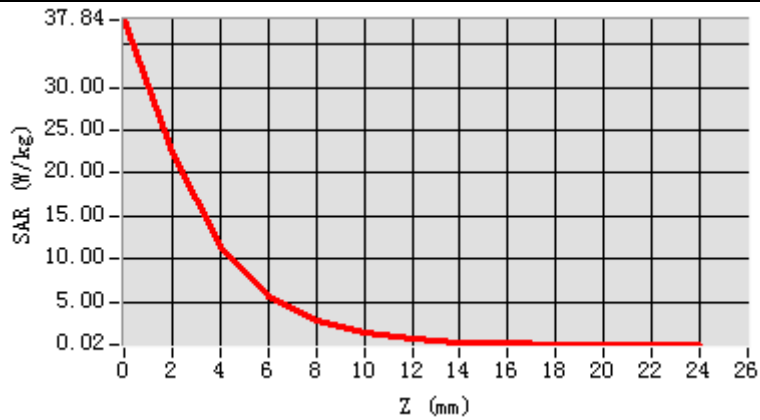

**3D screen shot**

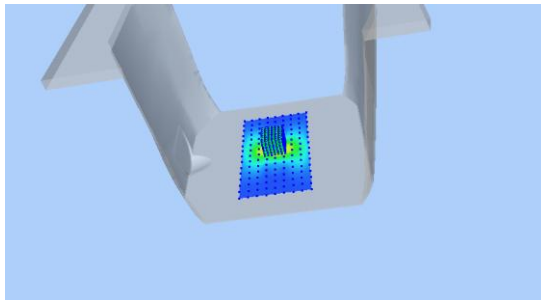

**Hot spot position**

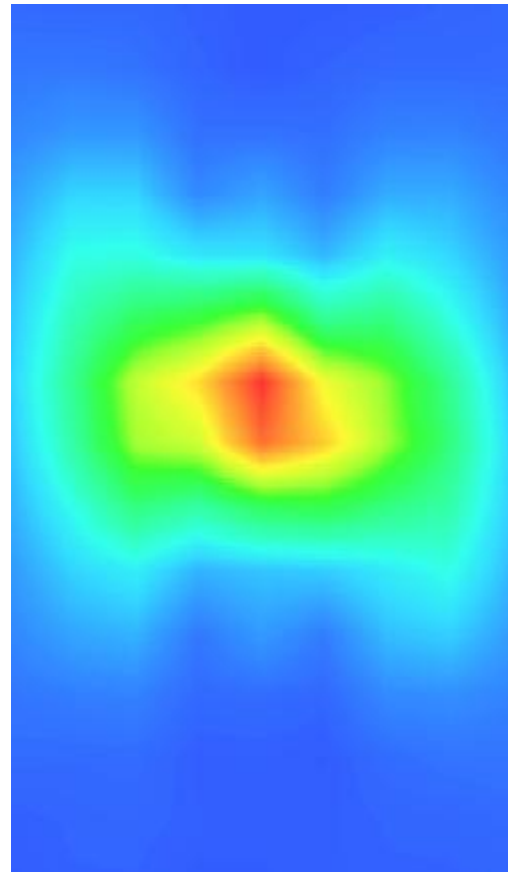

# MEASUREMENT 8

Date of measurement: 30/9/2022

## A. Experimental conditions.

<b>Area Scan</b>	<u>dx=10mm dy=10mm, h= 2.00 mm</u>
<b>ZoomScan</b>	<u>7x7x12,dx=4mm dy=4mm dz=2mm</u>
<b>Phantom</b>	<u>Validation plane</u>
<b>Device Position</b>	<u>Dipole</u>
<b>Band</b>	<u>CW5800</u>
<b>Channels</b>	<u>Middle</u>
<b>Signal</b>	<u>CW (Crest factor: 1.0)</u>
<b>ConvF</b>	<u>2.07</u>

## B. SAR Measurement Results

<b>Frequency (MHz)</b>	5800.000000
<b>Relative permittivity (real part)</b>	34.316820
<b>Relative permittivity (imaginary part)</b>	15.991300
<b>Conductivity (S/m)</b>	5.152752
<b>Variation (%)</b>	-0.500000

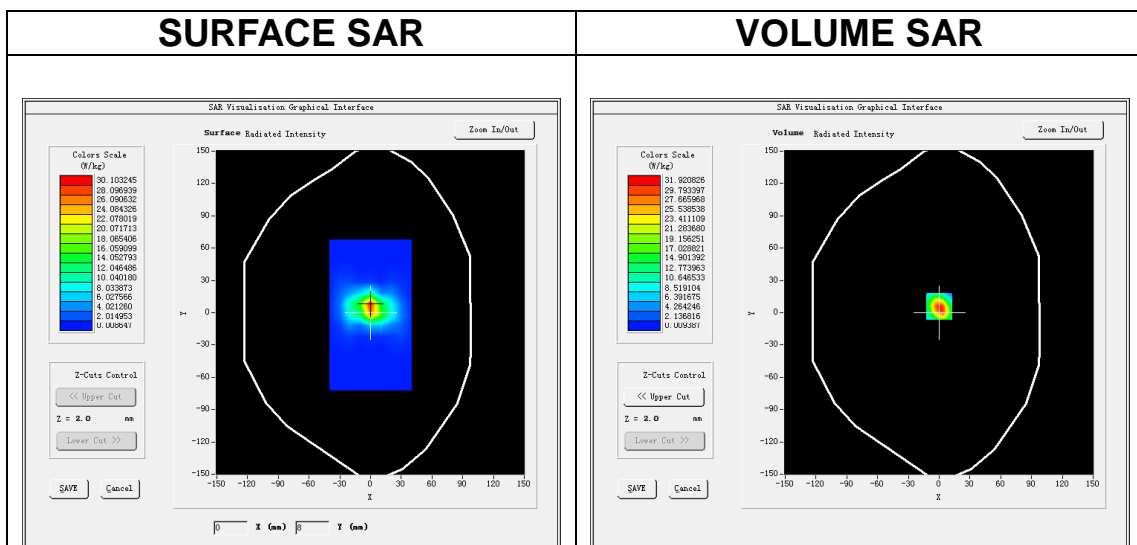

**Maximum location: X=0.00, Y=6.00**

**SAR Peak: 57.37 W/kg**

<b>SAR 10g (W/Kg)</b>	5.810228
<b>SAR 1g (W/Kg)</b>	18.992190

<b>Z (m)</b>	<b>0.00</b>	<b>2.00</b>	<b>4.00</b>	<b>6.00</b>	<b>8.00</b>	<b>10.00</b>	<b>12.00</b>	<b>14.00</b>	<b>16.00</b>	<b>18.00</b>	<b>20.00</b>	<b>22.00</b>
<b>SAR (W/Kg)</b>	<b>54.036</b>	<b>31.948</b>	<b>16.144</b>	<b>8.1766</b>	<b>4.0890</b>	<b>2.0550</b>	<b>1.0361</b>	<b>0.5144</b>	<b>0.2795</b>	<b>0.1572</b>	<b>0.0788</b>	<b>0.0438</b>

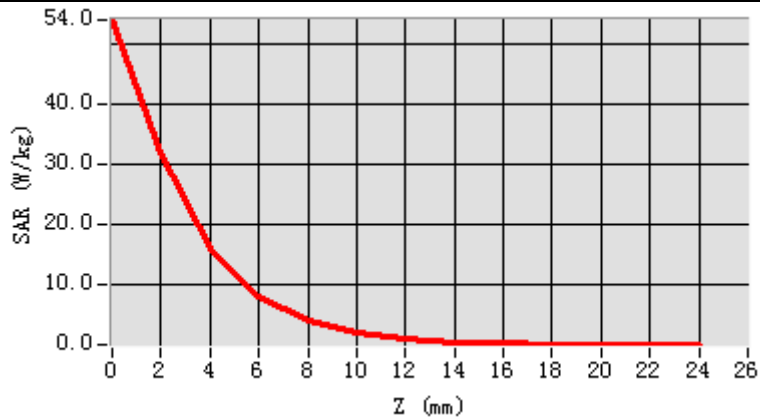

**3D screen shot**

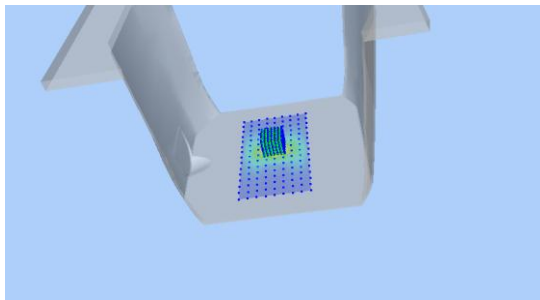

**Hot spot position**

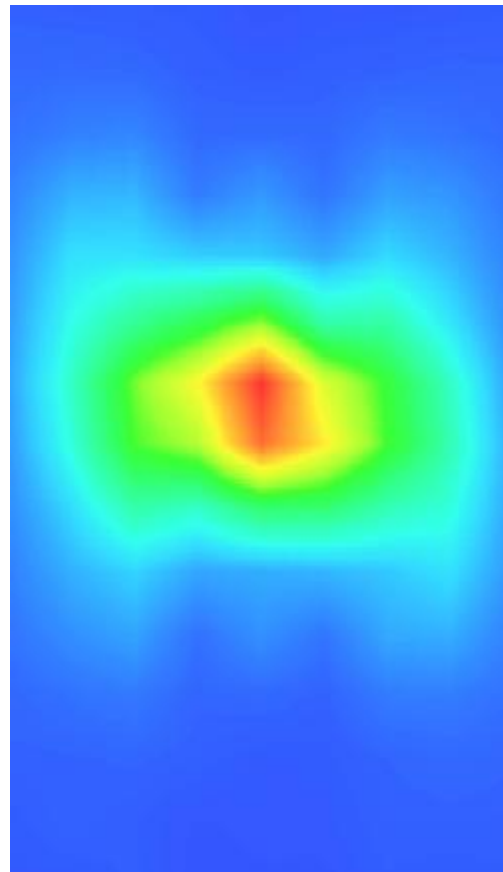

### 13. Appendix C. Plots of High SAR Measurement

Table of contents
<b>MEASUREMENT 1 GSM 850 Body</b>
<b>MEASUREMENT 2 GSM 1900 Body</b>
<b>MEASUREMENT 3 WCDMA Band 2 Body</b>
<b>MEASUREMENT 4 WCDMA Band 4 Body</b>
<b>MEASUREMENT 5 WCDMA Band 5 Body</b>
<b>MEASUREMENT 6 WLAN 5.2G Body</b>
<b>MEASUREMENT 7 WLAN 5.8G Body</b>
<b>MEASUREMENT 8 WLAN 2.4G Body</b>
<b>MEASUREMENT 9 LTE Band 2 Body</b>
<b>MEASUREMENT 10 LTE Band 4 Body</b>
<b>MEASUREMENT 11 LTE Band 5 Body</b>
<b>MEASUREMENT 12 LTE Band 7 Body</b>
<b>MEASUREMENT 13 LTE Band 12 Body</b>
<b>MEASUREMENT 14 LTE Band 17 Body</b>
<b>MEASUREMENT 15 LTE Band 25 Body</b>
<b>MEASUREMENT 16 LTE Band 26A Body</b>
<b>MEASUREMENT 17 LTE Band 26B Body</b>
<b>MEASUREMENT 18 LTE Band 41 Body</b>
<b>MEASUREMENT 19 LTE Band 66 Body</b>

# MEASUREMENT 1

Date of measurement: 23/9/2022

## A. Experimental conditions.

<b>Area Scan</b>	<u>dx=15mm dy=15mm, h= 5.00 mm</u>
<b>ZoomScan</b>	<u>5x5x7, dx=8mm dy=8mm dz=5mm</u>
<b>Phantom</b>	<u>Validation plane</u>
<b>Device Position</b>	<u>Body</u>
<b>Band</b>	<u>GSM850</u>
<b>Channels</b>	<u>Middle</u>
<b>Signal</b>	<u>TDMA (Crest factor: 2.0)</u>
<b>ConvF</b>	<u>1.50</u>

## B. SAR Measurement Results

<b>Frequency (MHz)</b>	836.400000
<b>Relative permittivity (real part)</b>	41.288811
<b>Relative permittivity (imaginary part)</b>	19.947828
<b>Conductivity (S/m)</b>	0.926909
<b>Variation (%)</b>	0.670000

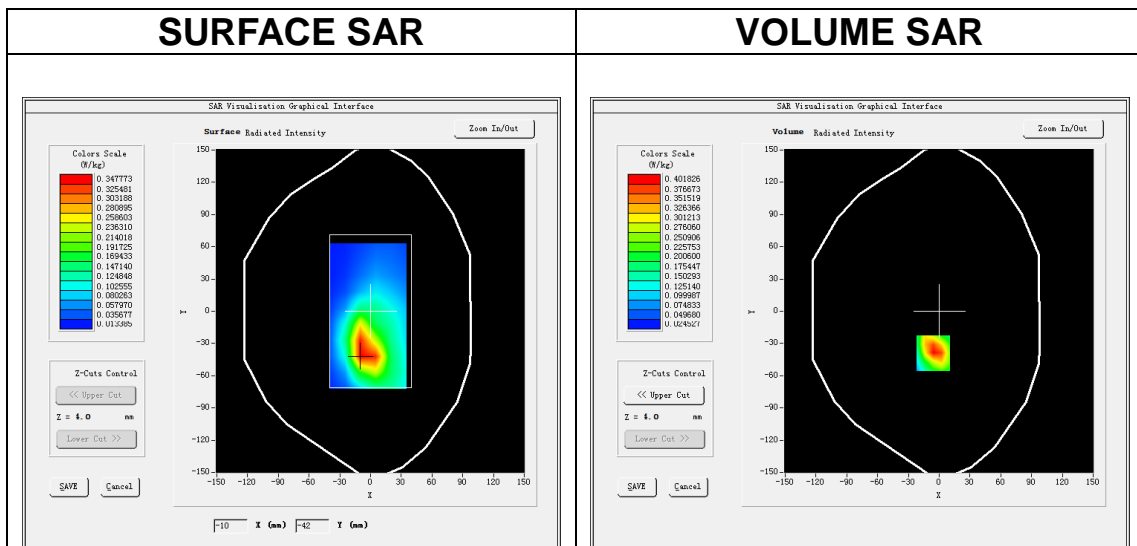

**Maximum location: X=-6.00, Y=-39.00**  
**SAR Peak: 0.64 W/kg**

<b>SAR 10g (W/Kg)</b>	0.213332
<b>SAR 1g (W/Kg)</b>	0.389297



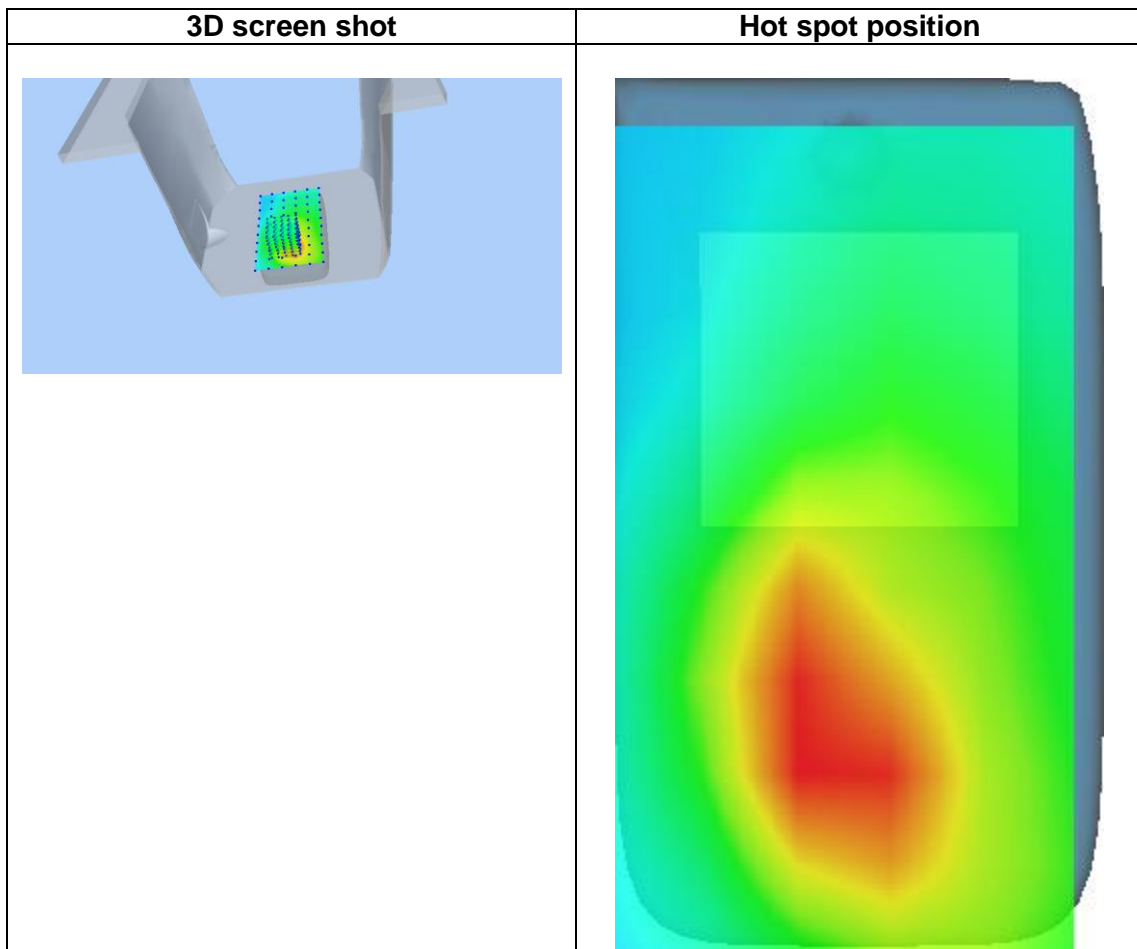
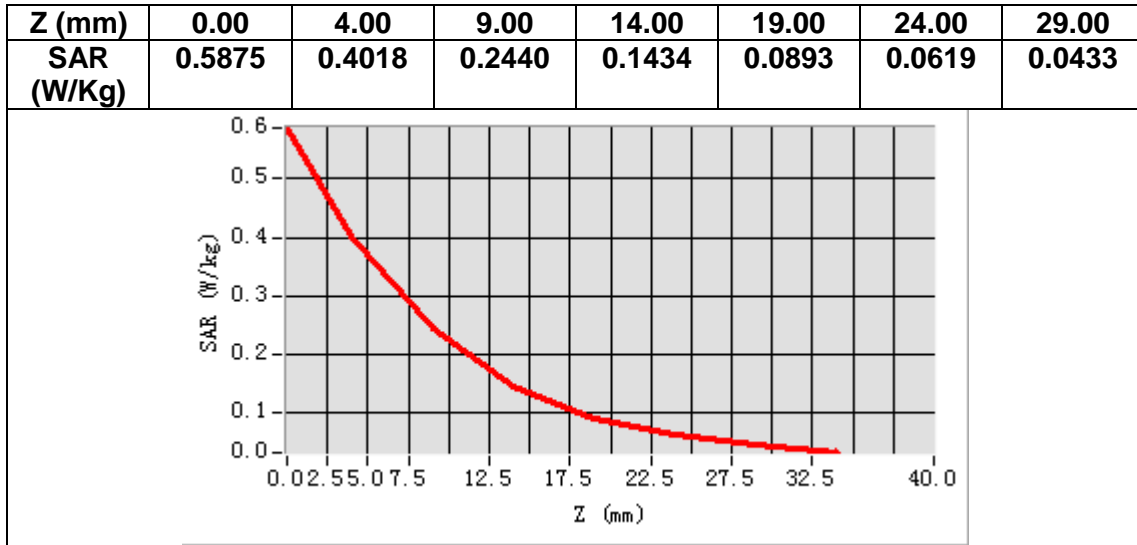

# MEASUREMENT 2

Date of measurement: 8/10/2022

## A. Experimental conditions.

<b>Area Scan</b>	<u>dx=15mm dy=15mm, h= 5.00 mm</u>
<b>ZoomScan</b>	<u>5x5x7, dx=8mm dy=8mm dz=5mm</u>
<b>Phantom</b>	<u>Validation plane</u>
<b>Device Position</b>	<u>Body</u>
<b>Band</b>	<u>GSM1900</u>
<b>Channels</b>	<u>Middle</u>
<b>Signal</b>	<u>TDMA (Crest factor: 2.0)</u>
<b>ConvF</b>	<u>1.91</u>

## B. SAR Measurement Results

<b>Frequency (MHz)</b>	1880.000000
<b>Relative permittivity (real part)</b>	38.434464
<b>Relative permittivity (imaginary part)</b>	13.801094
<b>Conductivity (S/m)</b>	1.441448
<b>Variation (%)</b>	-3.540000

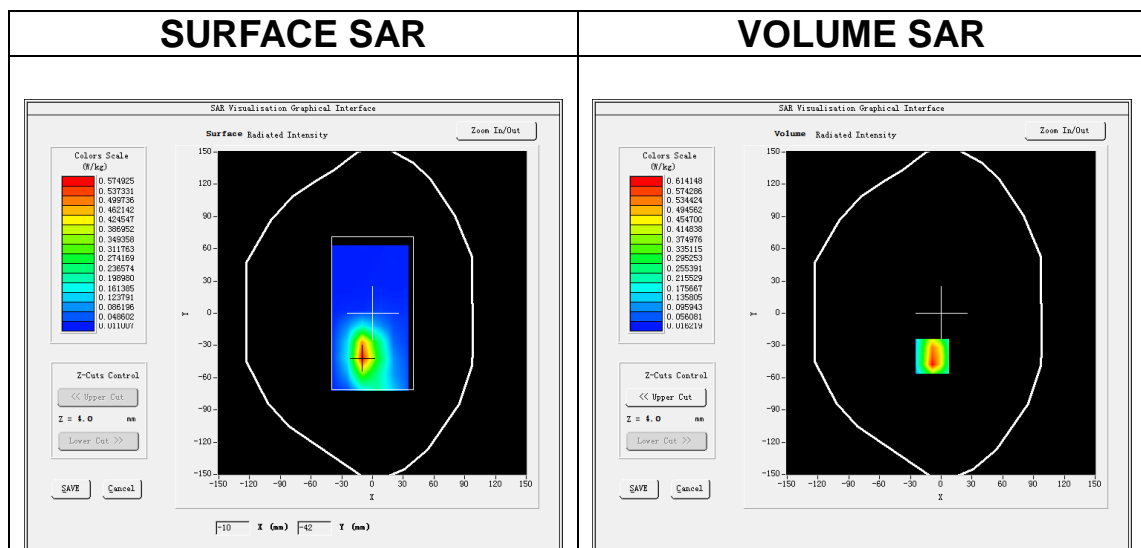

**Maximum location: X=-9.00, Y=-40.00**  
**SAR Peak: 1.09 W/kg**

<b>SAR 10g (W/Kg)</b>	0.283059
<b>SAR 1g (W/Kg)</b>	0.589569

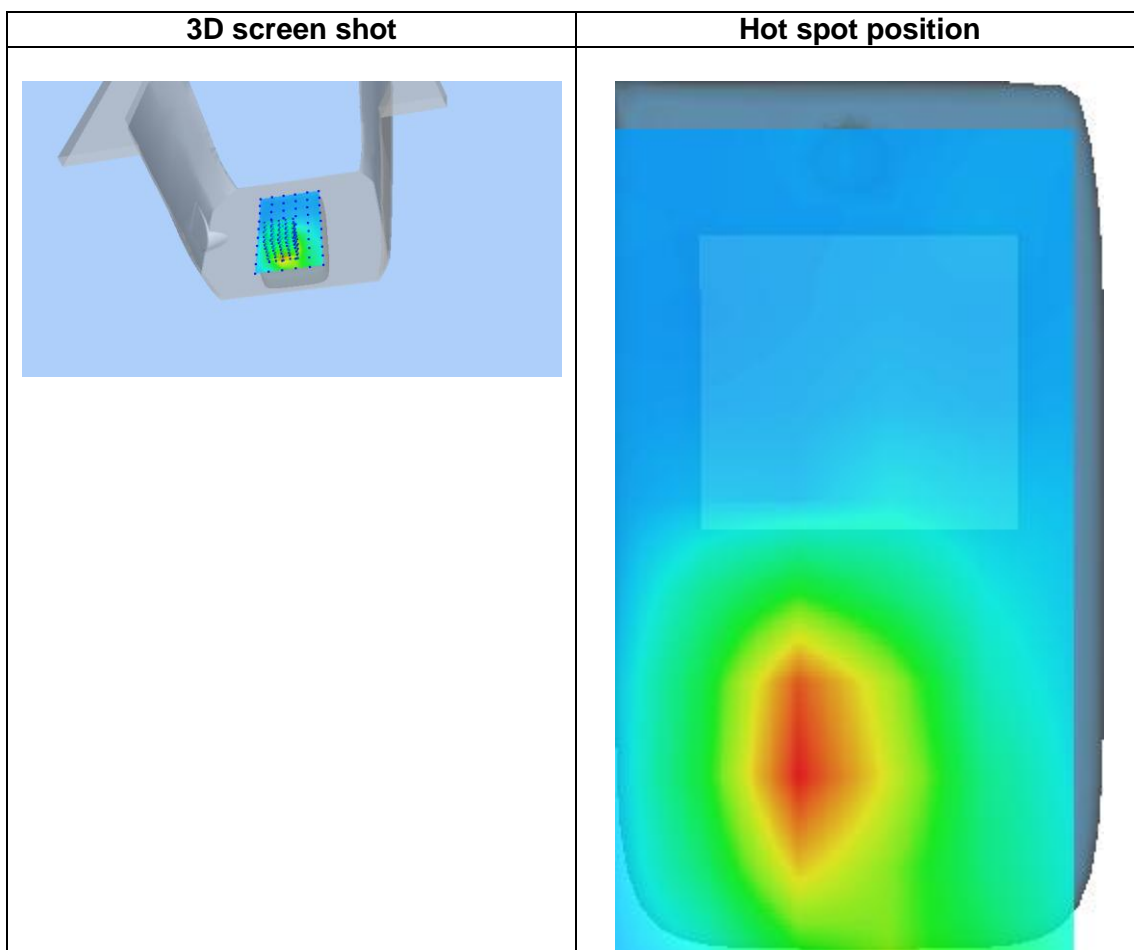
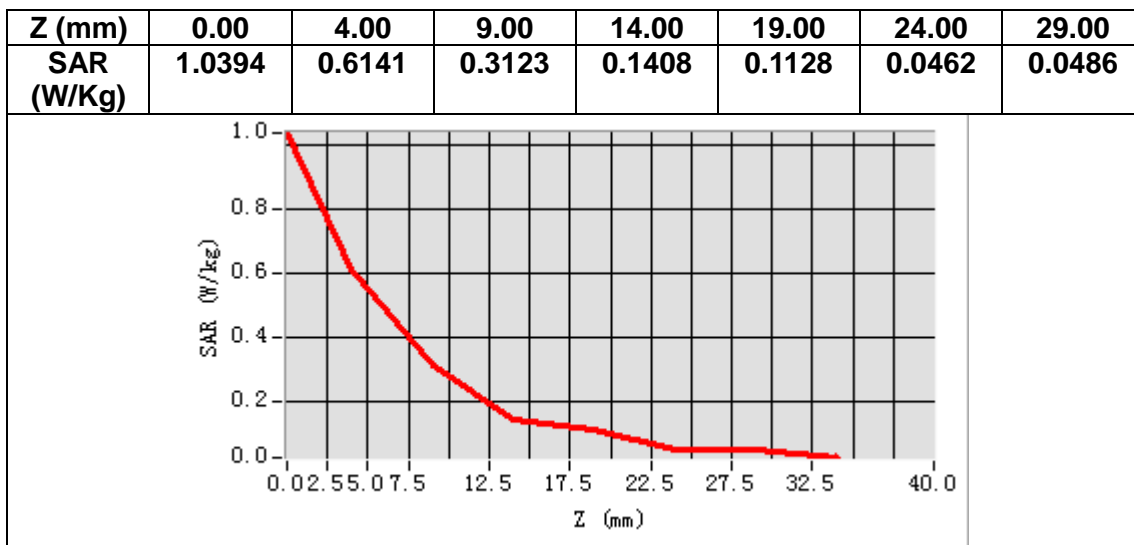

# MEASUREMENT 3

Date of measurement: 8/10/2022

## A. Experimental conditions.

<b>Area Scan</b>	<u>dx=15mm dy=15mm, h= 5.00 mm</u>
<b>ZoomScan</b>	<u>5x5x7, dx=8mm dy=8mm dz=5mm</u>
<b>Phantom</b>	<u>Validation plane</u>
<b>Device Position</b>	<u>Body</u>
<b>Band</b>	<u>Band2_WCDMA1900</u>
<b>Channels</b>	<u>Middle</u>
<b>Signal</b>	<u>WCDMA (Crest factor: 1.0)</u>
<b>ConvF</b>	<u>1.91</u>

## B. SAR Measurement Results

<b>Frequency (MHz)</b>	1880.000000
<b>Relative permittivity (real part)</b>	38.434464
<b>Relative permittivity (imaginary part)</b>	13.801094
<b>Conductivity (S/m)</b>	1.441448
<b>Variation (%)</b>	-1.130000

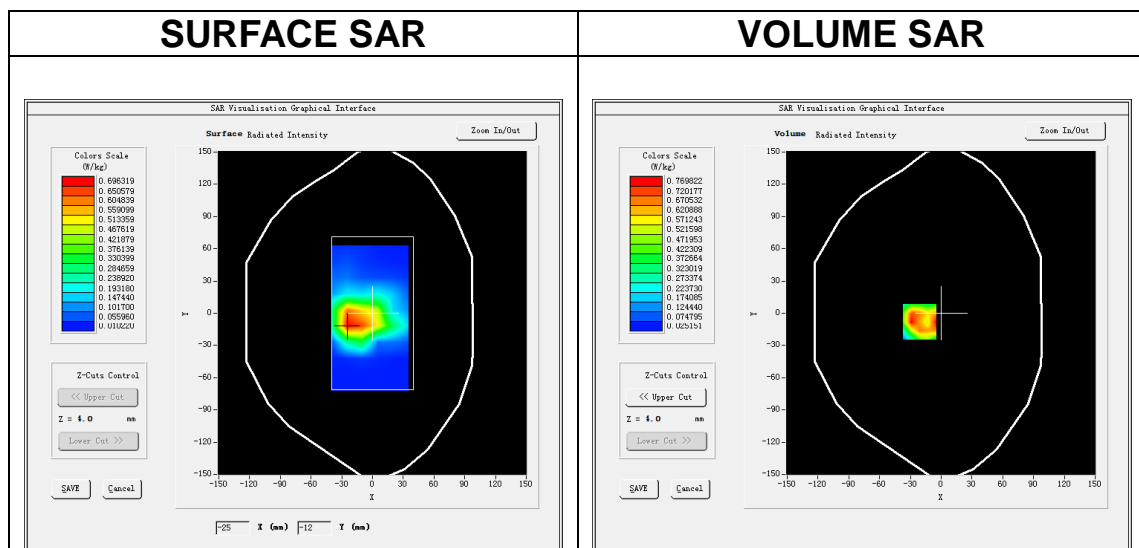

**Maximum location: X=-21.00, Y=-8.00**  
**SAR Peak: 1.28 W/kg**

<b>SAR 10g (W/Kg)</b>	0.392379
<b>SAR 1g (W/Kg)</b>	0.737639

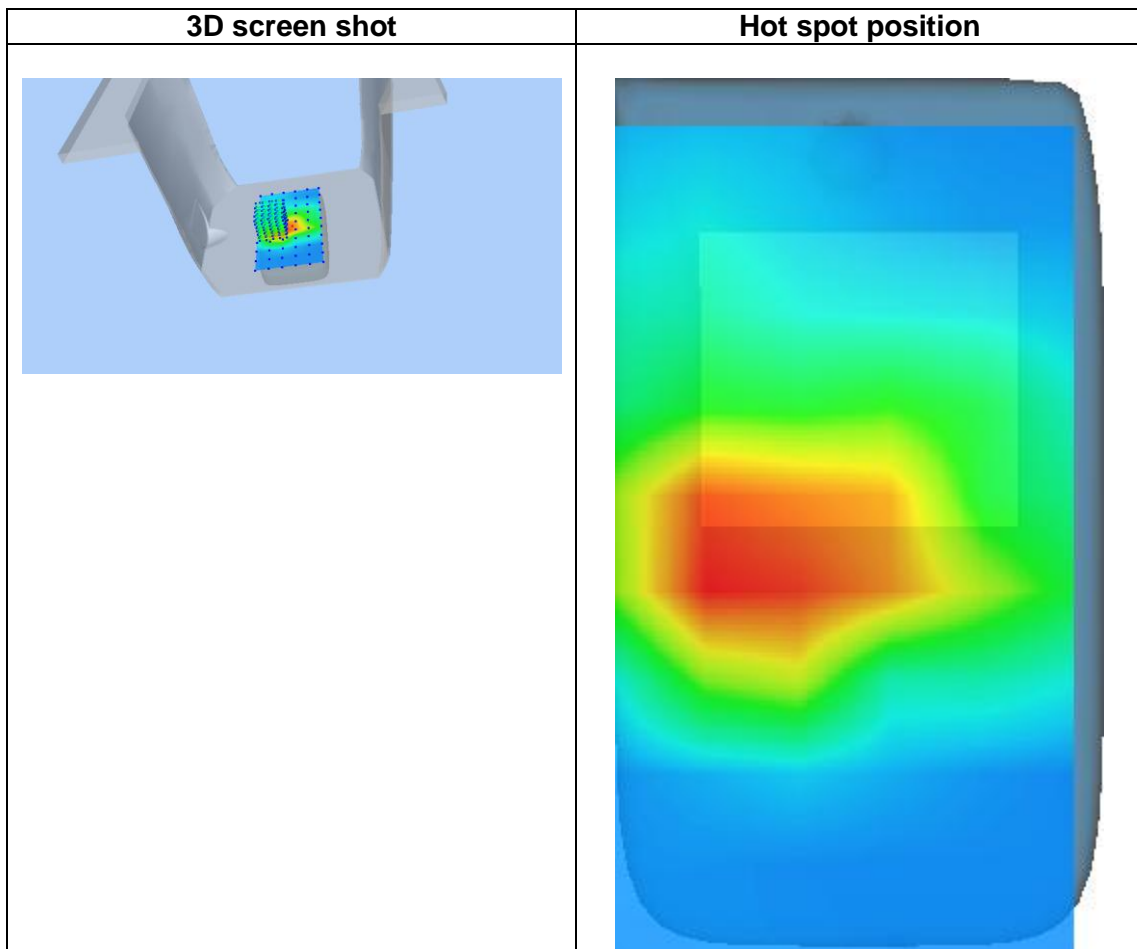
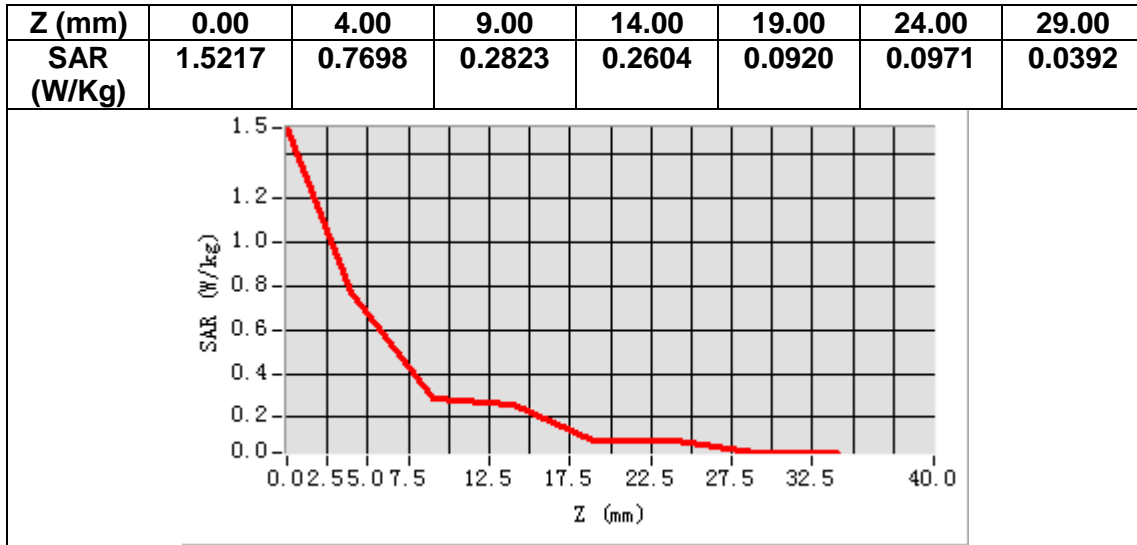

# MEASUREMENT 4

Date of measurement: 21/9/2022

## A. Experimental conditions.

<b>Area Scan</b>	<u>dx=15mm dy=15mm, h= 5.00 mm</u>
<b>ZoomScan</b>	<u>5x5x7, dx=8mm dy=8mm dz=5mm</u>
<b>Phantom</b>	<u>Validation plane</u>
<b>Device Position</b>	<u>Body</u>
<b>Band</b>	<u>Band4 WCDMA1700</u>
<b>Channels</b>	<u>Middle</u>
<b>Signal</b>	<u>WCDMA (Crest factor: 1.0)</u>
<b>ConvF</b>	<u>1.73</u>

## B. SAR Measurement Results

<b>Frequency (MHz)</b>	1732.600000
<b>Relative permittivity (real part)</b>	39.136761
<b>Relative permittivity (imaginary part)</b>	13.799881
<b>Conductivity (S/m)</b>	1.327855
<b>Variation (%)</b>	3.110000

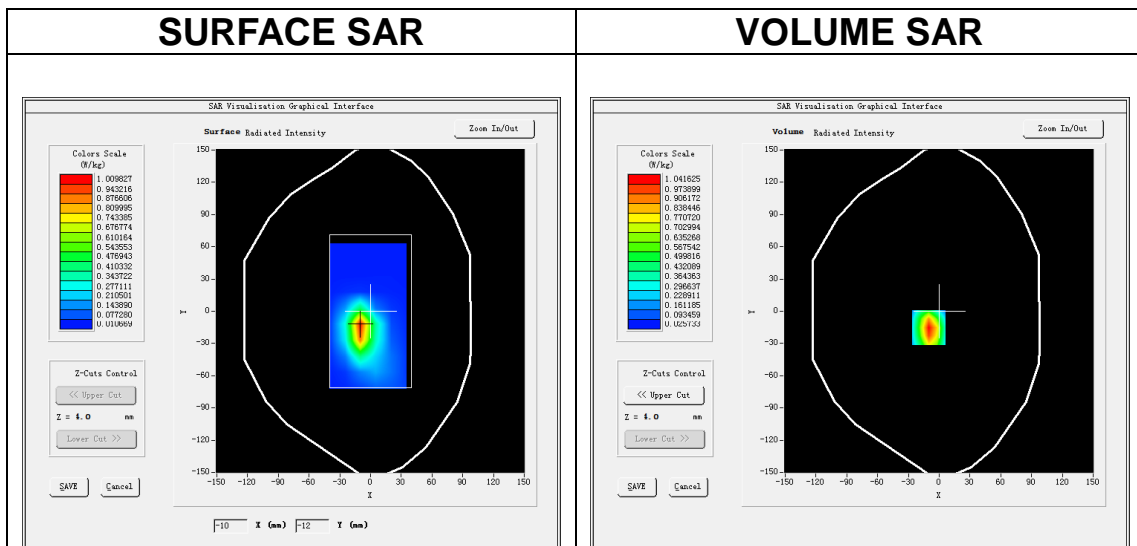

**Maximum location: X=-10.00, Y=-15.00**  
**SAR Peak: 1.60 W/kg**

<b>SAR 10g (W/Kg)</b>	0.497297
<b>SAR 1g (W/Kg)</b>	0.969741

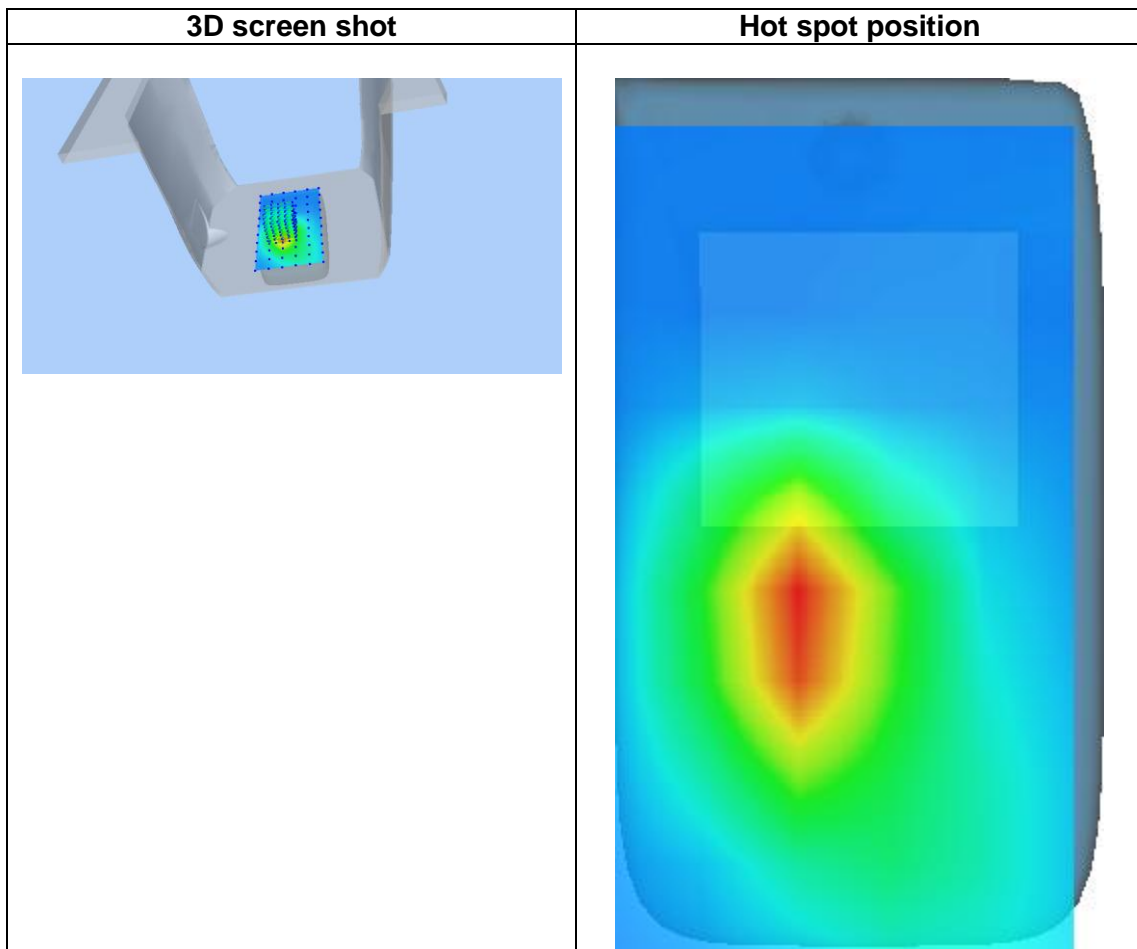
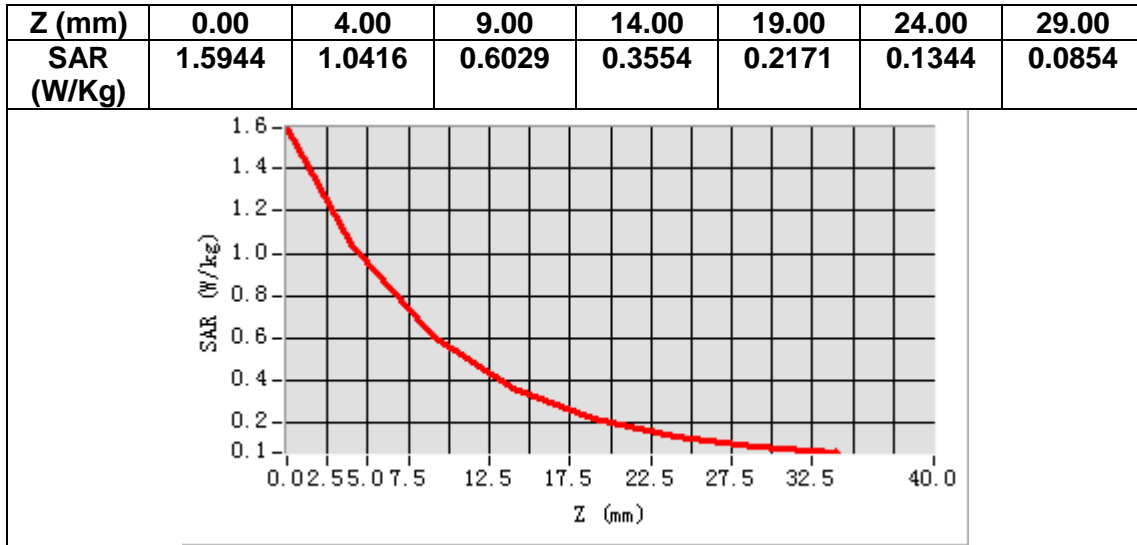

# MEASUREMENT 5

Date of measurement: 23/9/2022

## A. Experimental conditions.

<b>Area Scan</b>	<u>dx=15mm dy=15mm, h= 5.00 mm</u>
<b>ZoomScan</b>	<u>5x5x7, dx=8mm dy=8mm dz=5mm</u>
<b>Phantom</b>	<u>Validation plane</u>
<b>Device Position</b>	<u>Body</u>
<b>Band</b>	<u>Band5_WCDMA850</u>
<b>Channels</b>	<u>Middle</u>
<b>Signal</b>	<u>WCDMA (Crest factor: 1.0)</u>
<b>ConvF</b>	<u>1.50</u>

## B. SAR Measurement Results

<b>Frequency (MHz)</b>	836.400000
<b>Relative permittivity (real part)</b>	41.288811
<b>Relative permittivity (imaginary part)</b>	19.947828
<b>Conductivity (S/m)</b>	0.926909
<b>Variation (%)</b>	-1.380000

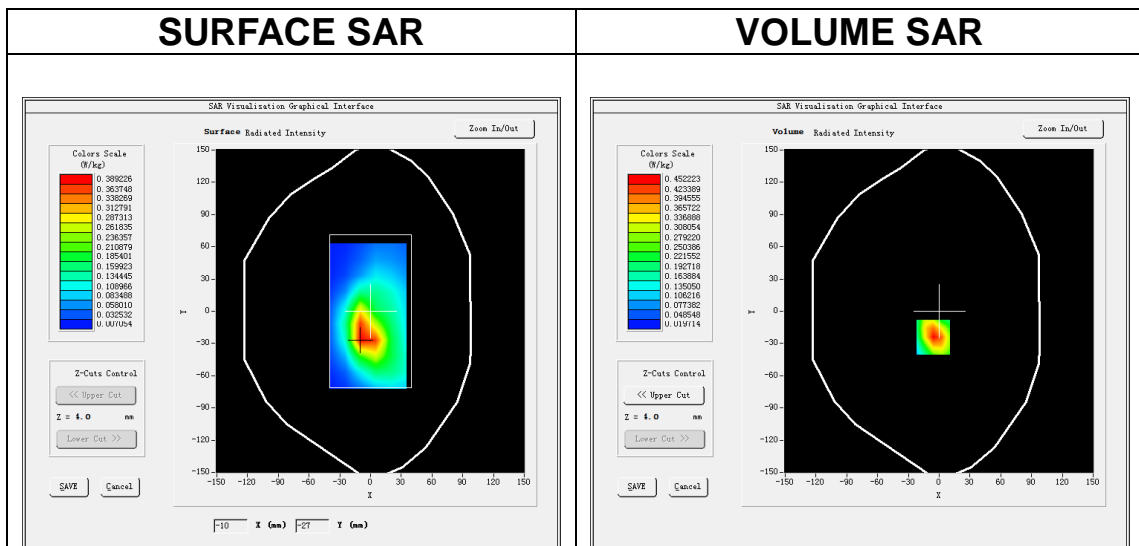

**Maximum location: X=-6.00, Y=-24.00**  
**SAR Peak: 0.72 W/kg**

<b>SAR 10g (W/Kg)</b>	0.239664
<b>SAR 1g (W/Kg)</b>	0.437128



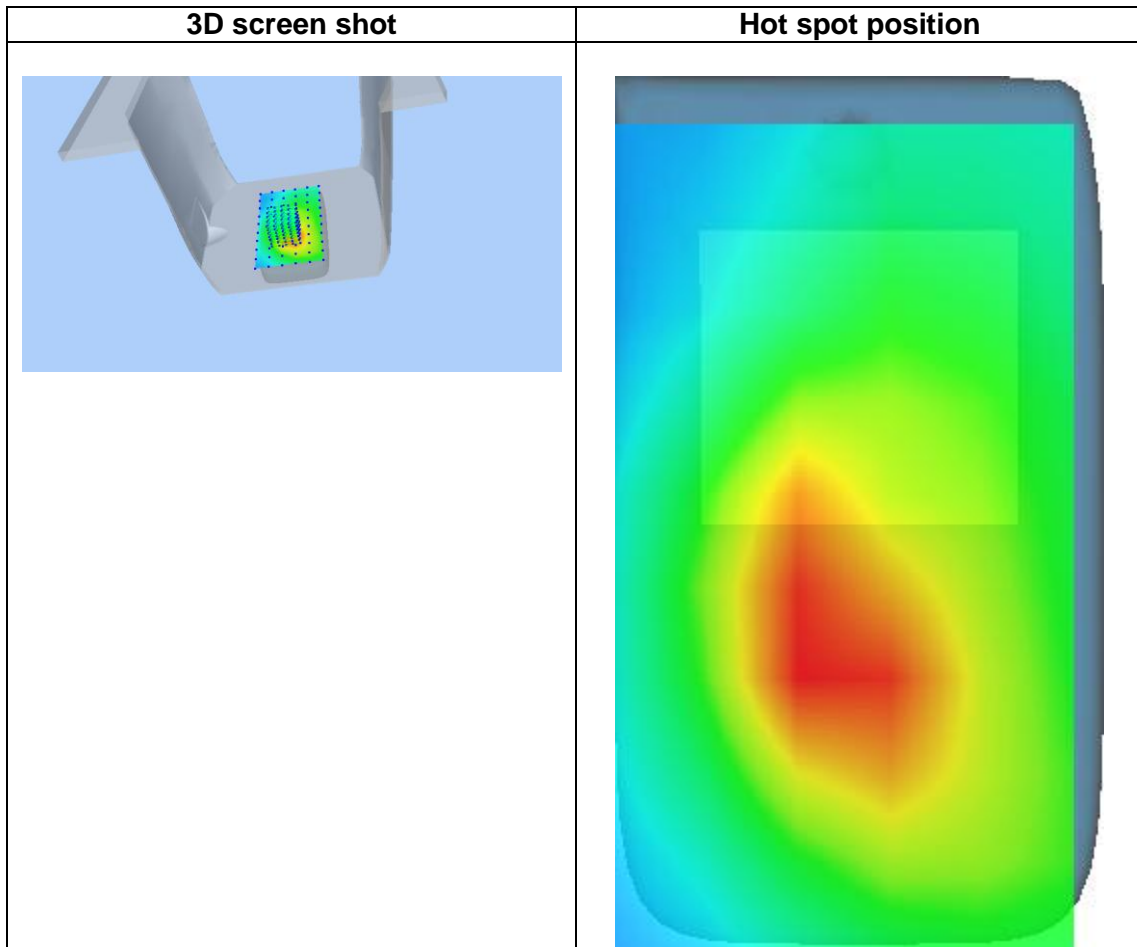
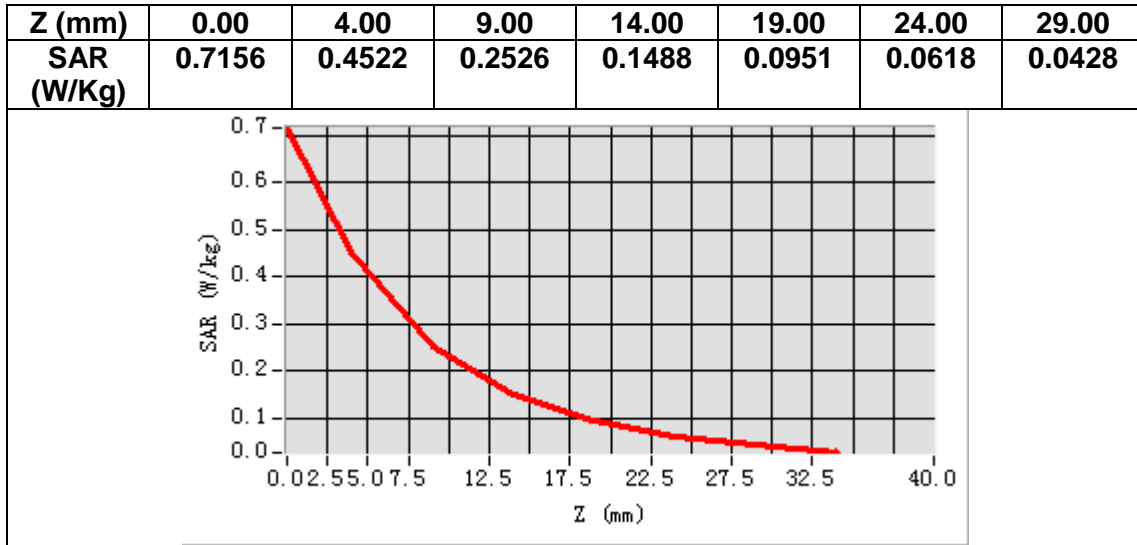

# MEASUREMENT 6

Date of measurement: 29/9/2022

## A. Experimental conditions.

<b>Area Scan</b>	<u>dx=10mm dy=10mm, h= 2.00 mm</u>
<b>ZoomScan</b>	<u>7x7x12,dx=4mm dy=4mm dz=2mm</u>
<b>Phantom</b>	<u>Validation plane</u>
<b>Device Position</b>	<u>Body</u>
<b>Band</b>	<u>IEEE 802.11a U-NII</u>
<b>Channels</b>	<u>Low</u>
<b>Signal</b>	<u>IEEE802.11a (Crest factor: 1.0)</u>
<b>ConvF</b>	<u>1.80</u>

## B. SAR Measurement Results

<b>Frequency (MHz)</b>	5180.000000
<b>Relative permittivity (real part)</b>	35.183725
<b>Relative permittivity (imaginary part)</b>	15.741231
<b>Conductivity (S/m)</b>	4.529976
<b>Variation (%)</b>	-0.060000

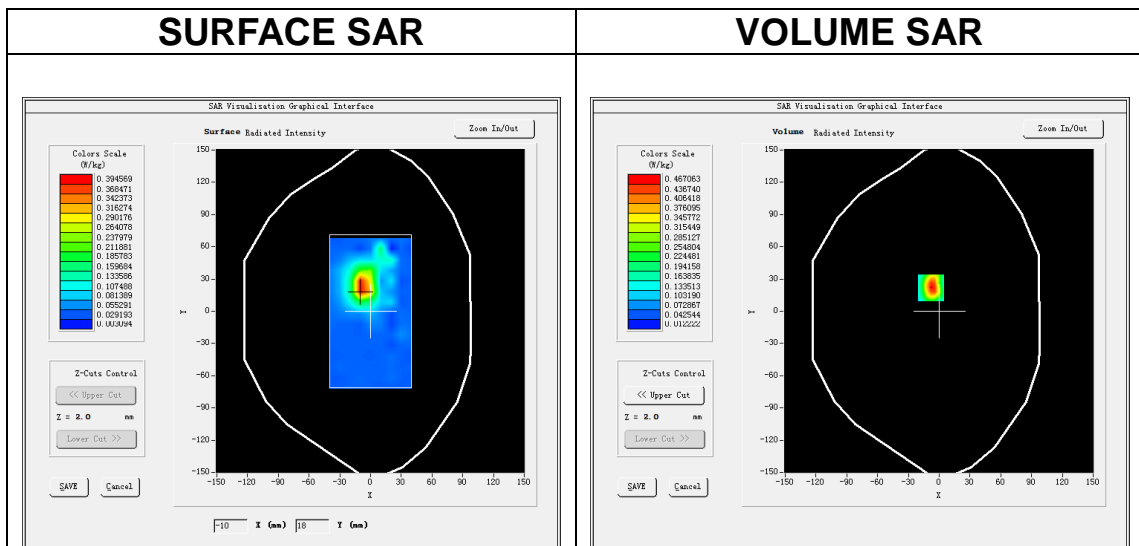

**Maximum location: X=-8.00, Y=22.00**  
**SAR Peak: 0.89 W/kg**

<b>SAR 10g (W/Kg)</b>	0.118122
<b>SAR 1g (W/Kg)</b>	0.282299

<b>Z (m)</b>	<b>0.00</b>	<b>2.00</b>	<b>4.00</b>	<b>6.00</b>	<b>8.00</b>	<b>10.0</b>	<b>12.0</b>	<b>14.0</b>	<b>16.0</b>	<b>18.0</b>	<b>20.0</b>	<b>22.0</b>
<b>SAR (W/Kg)</b>	<b>0.7825</b>	<b>0.4671</b>	<b>0.2487</b>	<b>0.1326</b>	<b>0.0998</b>	<b>0.0540</b>	<b>0.0498</b>	<b>0.0614</b>	<b>0.0302</b>	<b>0.0327</b>	<b>0.0323</b>	<b>0.0345</b>

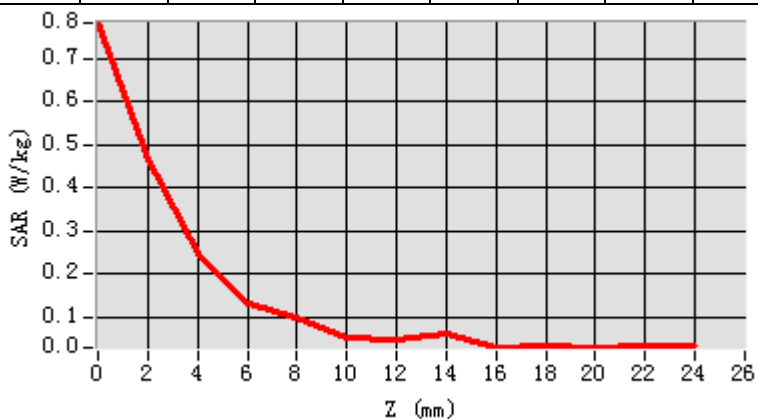

**3D screen shot**

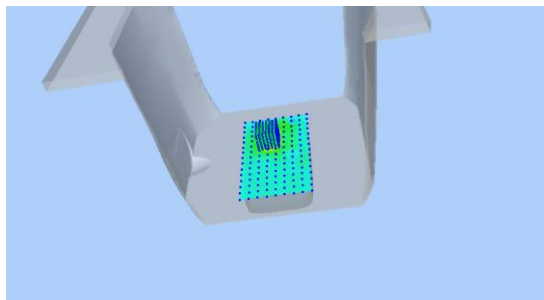

**Hot spot position**

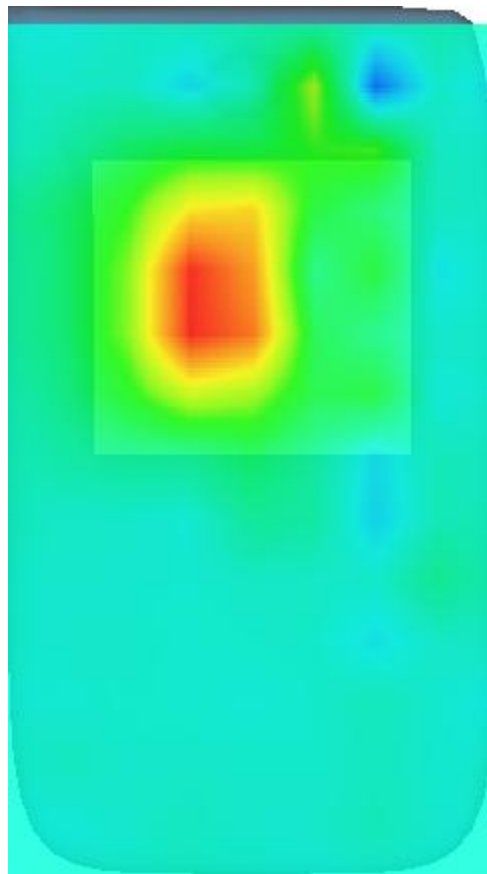

# MEASUREMENT 7

Date of measurement: 30/9/2022

## A. Experimental conditions.

<b>Area Scan</b>	<u>dx=10mm dy=10mm, h= 2.00 mm</u>
<b>ZoomScan</b>	<u>7x7x12,dx=4mm dy=4mm dz=2mm</u>
<b>Phantom</b>	<u>Validation plane</u>
<b>Device Position</b>	<u>Body</u>
<b>Band</b>	<u>IEEE 802.11n U-NII</u>
<b>Channels</b>	<u>High</u>
<b>Signal</b>	<u>IEEE802.11n (Crest factor: 1.0)</u>
<b>ConvF</b>	<u>2.07</u>

## B. SAR Measurement Results

<b>Frequency (MHz)</b>	5825.000000
<b>Relative permittivity (real part)</b>	34.250731
<b>Relative permittivity (imaginary part)</b>	15.972231
<b>Conductivity (S/m)</b>	5.168791
<b>Variation (%)</b>	-4.170000

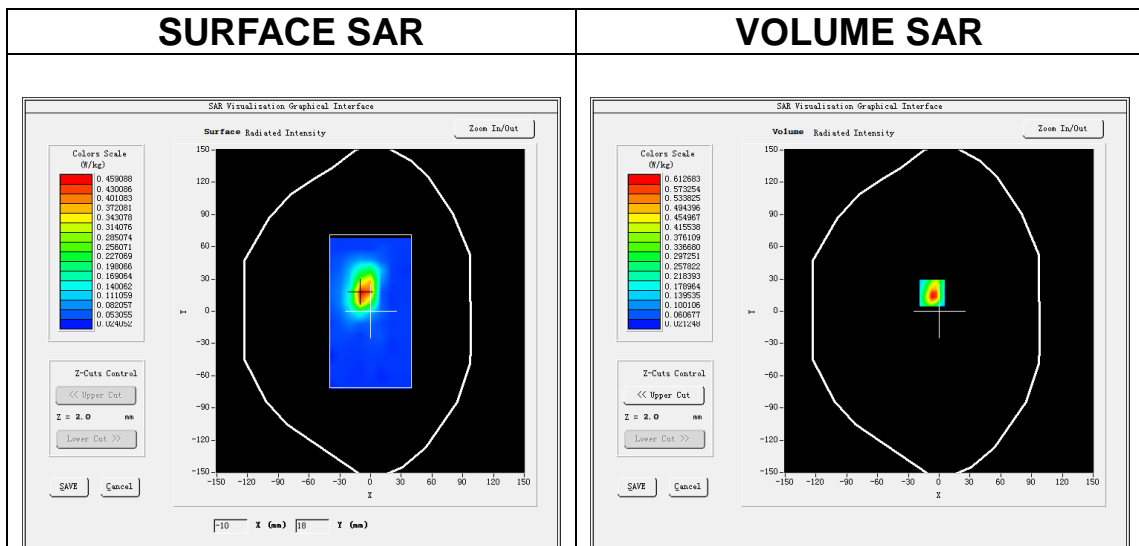

**Maximum location: X=-7.00, Y=17.00**  
**SAR Peak: 1.15 W/kg**

<b>SAR 10g (W/Kg)</b>	0.132478
<b>SAR 1g (W/Kg)</b>	0.343331

<b>Z (m m)</b>	<b>0.00</b>	<b>2.00</b>	<b>4.00</b>	<b>6.00</b>	<b>8.00</b>	<b>10.0</b>	<b>12.0</b>	<b>14.0</b>	<b>16.0</b>	<b>18.0</b>	<b>20.0</b>	<b>22.0</b>
<b>SAR (W/Kg)</b>	<b>1.0471</b>	<b>0.6127</b>	<b>0.2445</b>	<b>0.1490</b>	<b>0.1055</b>	<b>0.0654</b>	<b>0.0433</b>	<b>0.0286</b>	<b>0.0376</b>	<b>0.0333</b>	<b>0.0363</b>	<b>0.0387</b>

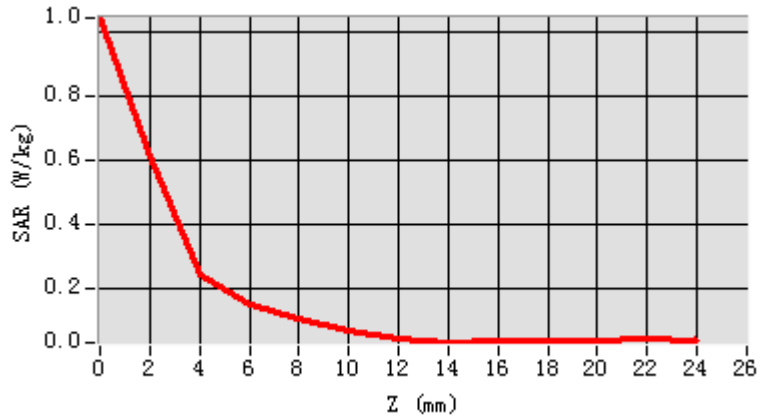

**3D screen shot**

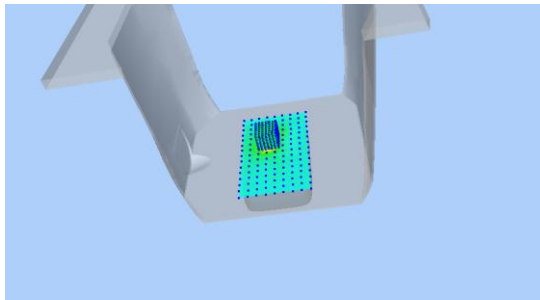

**Hot spot position**

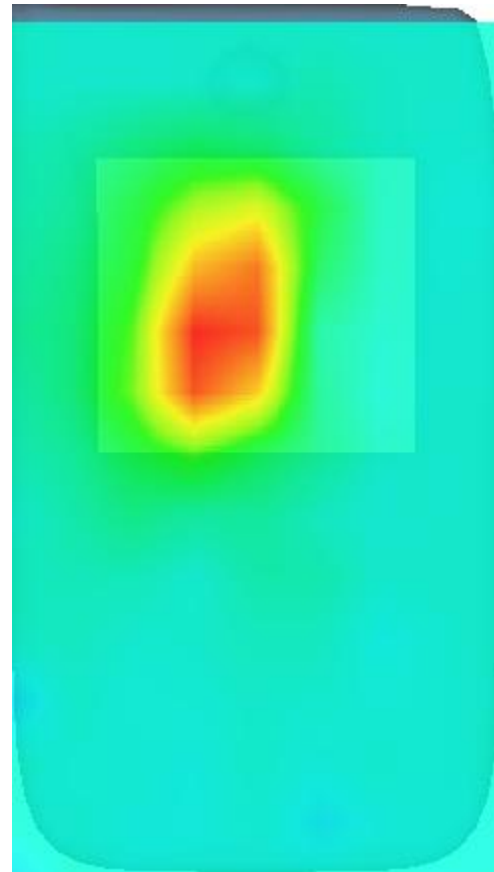

# MEASUREMENT 8

Date of measurement: 24/9/2022

## A. Experimental conditions.

<b>Area Scan</b>	<u>dx=12mm dy=12mm, h= 5.00 mm</u>
<b>ZoomScan</b>	<u>7x7x7, dx=5mm dy=5mm dz=5mm</u>
<b>Phantom</b>	<u>Validation plane</u>
<b>Device Position</b>	<u>Body</u>
<b>Band</b>	<u>IEEE 802.11b ISM</u>
<b>Channels</b>	<u>Low</u>
<b>Signal</b>	<u>IEEE802.11b (Crest factor: 1.0)</u>
<b>ConvF</b>	<u>1.98</u>

## B. SAR Measurement Results

<b>Frequency (MHz)</b>	2412.000000
<b>Relative permittivity (real part)</b>	37.891013
<b>Relative permittivity (imaginary part)</b>	12.979285
<b>Conductivity (S/m)</b>	1.739224
<b>Variation (%)</b>	-1.030000

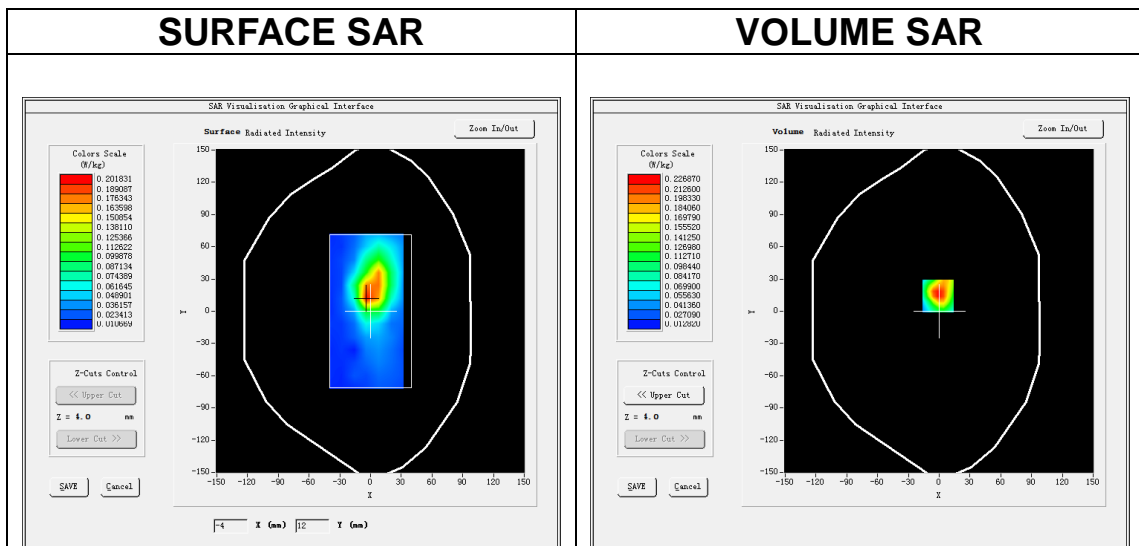

**Maximum location: X=-1.00, Y=14.00**  
**SAR Peak: 0.41 W/kg**

<b>SAR 10g (W/Kg)</b>	0.105843
<b>SAR 1g (W/Kg)</b>	0.216398

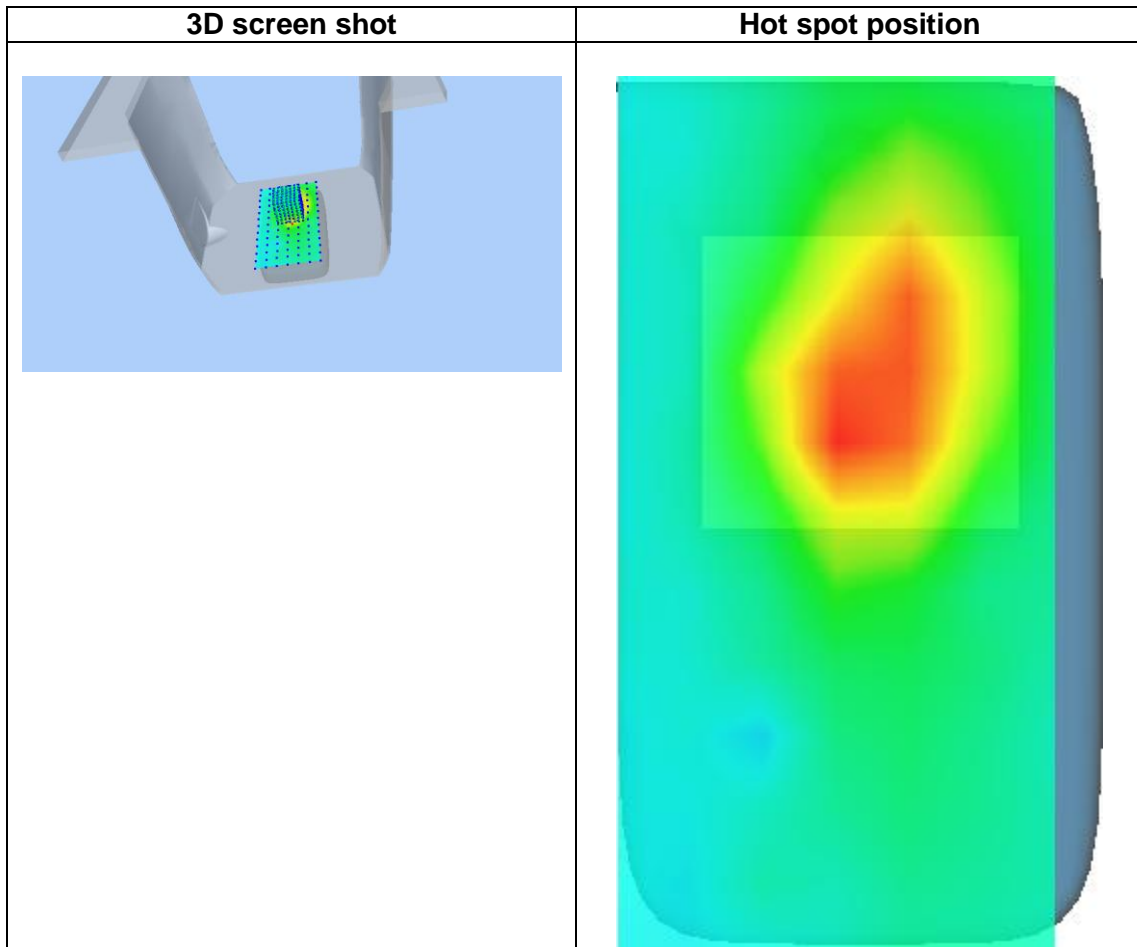
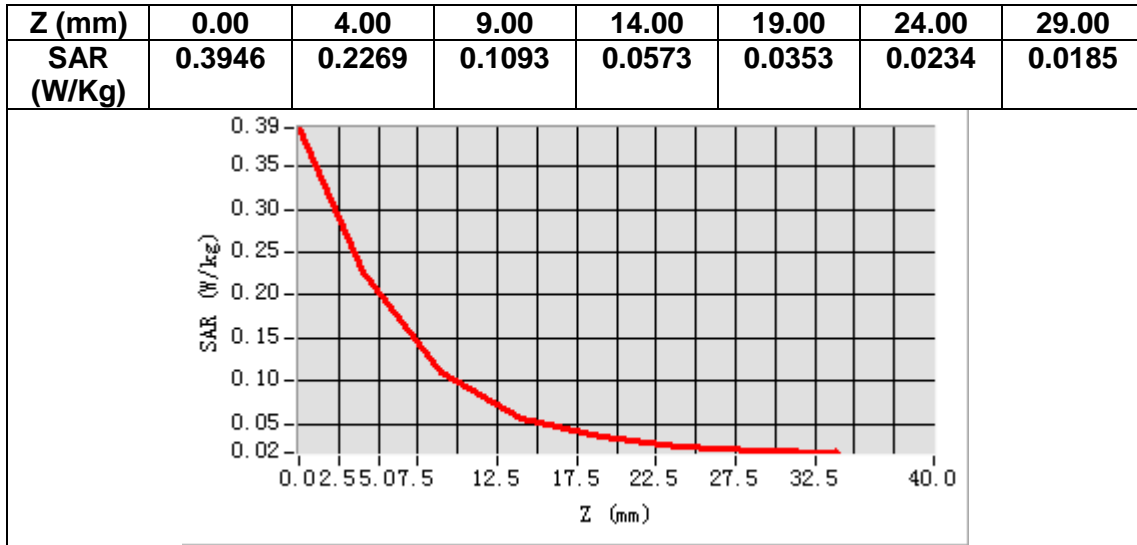

# MEASUREMENT 9

Date of measurement: 8/10/2022

## A. Experimental conditions.

<b>Area Scan</b>	<u>dx=15mm dy=15mm, h= 5.00 mm</u>
<b>ZoomScan</b>	<u>5x5x7, dx=8mm dy=8mm dz=5mm</u>
<b>Phantom</b>	<u>Validation plane</u>
<b>Device Position</b>	<u>Body</u>
<b>Band</b>	<u>LTE band 2</u>
<b>Channels</b>	<u>Middle</u>
<b>Signal</b>	<u>LTE (Crest factor: 1.0)</u>
<b>ConvF</b>	<u>1.91</u>

## B. SAR Measurement Results

<b>Frequency (MHz)</b>	1880.000000
<b>Relative permittivity (real part)</b>	38.434464
<b>Relative permittivity (imaginary part)</b>	13.801094
<b>Conductivity (S/m)</b>	1.441448
<b>Variation (%)</b>	-0.960000

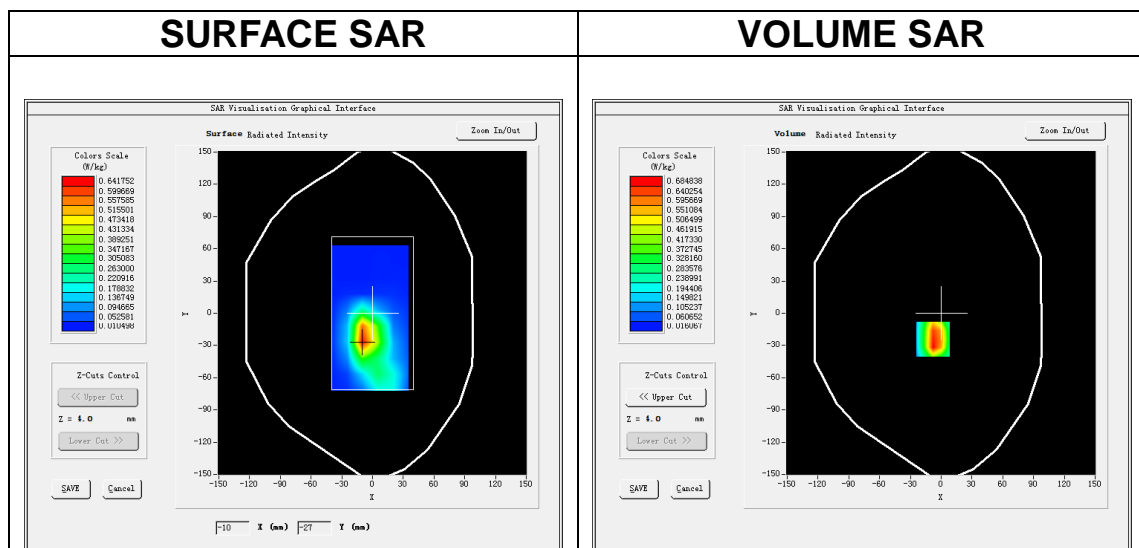

**Maximum location: X=-8.00, Y=-24.00**  
**SAR Peak: 1.24 W/kg**

<b>SAR 10g (W/Kg)</b>	0.333603
<b>SAR 1g (W/Kg)</b>	0.686223



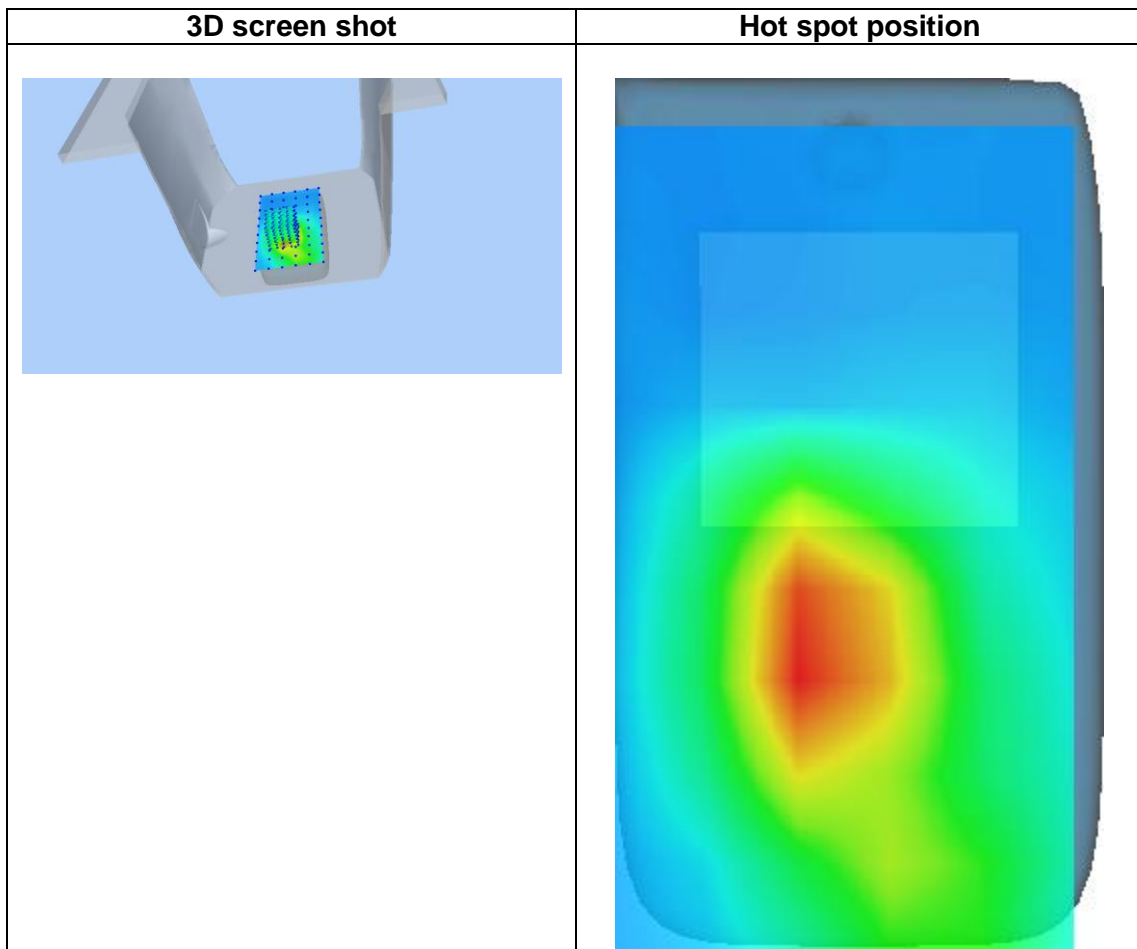
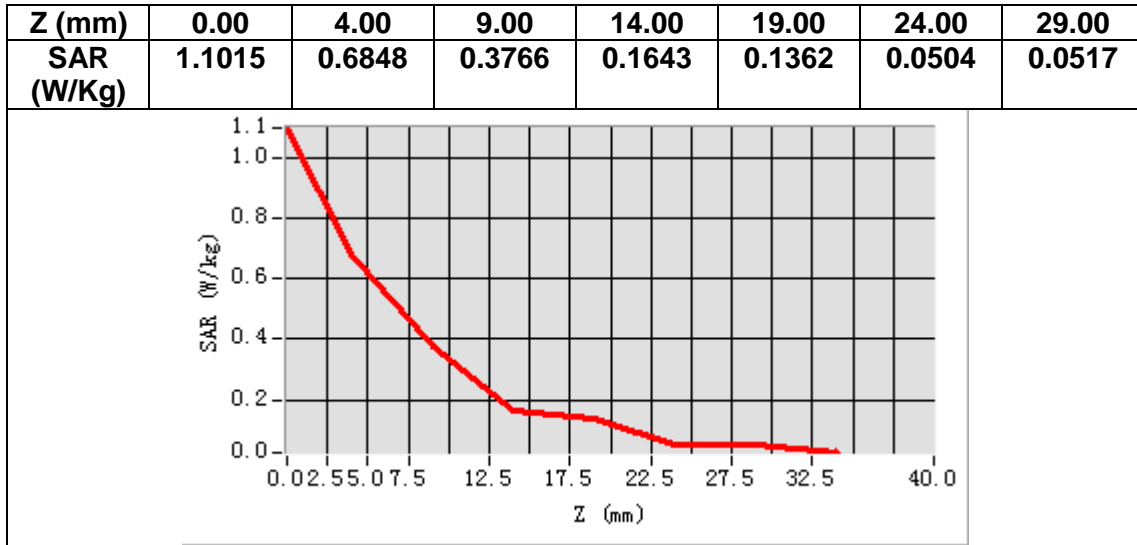

# MEASUREMENT 10

Date of measurement: 21/9/2022

## A. Experimental conditions.

<b>Area Scan</b>	<u>dx=15mm dy=15mm, h= 5.00 mm</u>
<b>ZoomScan</b>	<u>5x5x7, dx=8mm dy=8mm dz=5mm</u>
<b>Phantom</b>	<u>Validation plane</u>
<b>Device Position</b>	<u>Body</u>
<b>Band</b>	<u>LTE band 4</u>
<b>Channels</b>	<u>Middle</u>
<b>Signal</b>	<u>LTE (Crest factor: 1.0)</u>
<b>ConvF</b>	<u>1.73</u>

## B. SAR Measurement Results

<b>Frequency (MHz)</b>	1732.500000
<b>Relative permittivity (real part)</b>	39.144661
<b>Relative permittivity (imaginary part)</b>	13.784731
<b>Conductivity (S/m)</b>	1.326780
<b>Variation (%)</b>	-1.060000

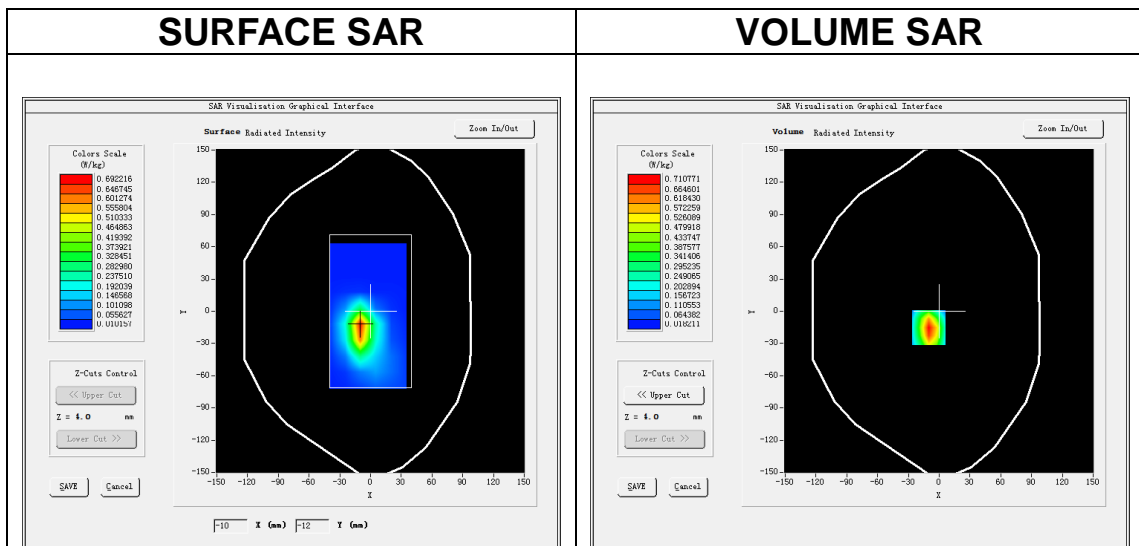

**Maximum location: X=-10.00, Y=-15.00**  
**SAR Peak: 1.10 W/kg**

<b>SAR 10g (W/Kg)</b>	0.338798
<b>SAR 1g (W/Kg)</b>	0.663340

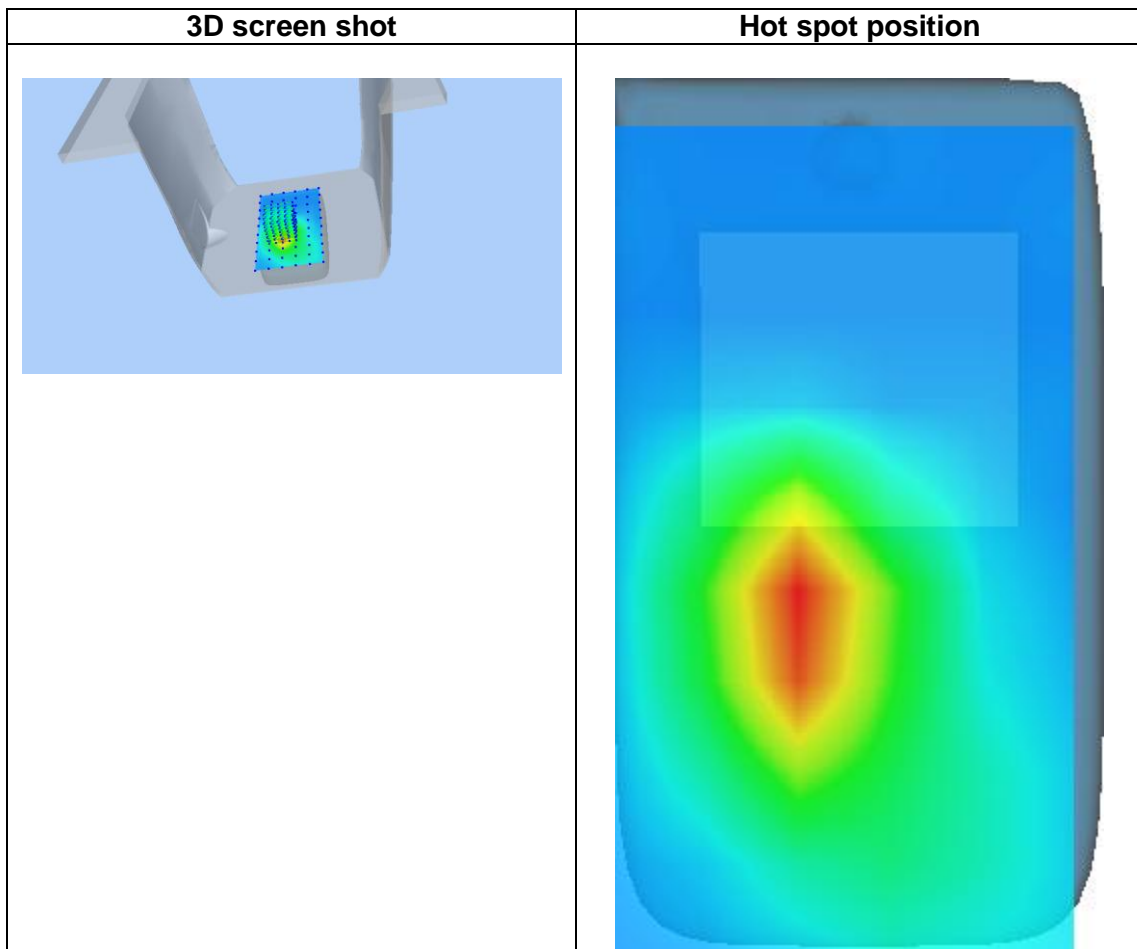
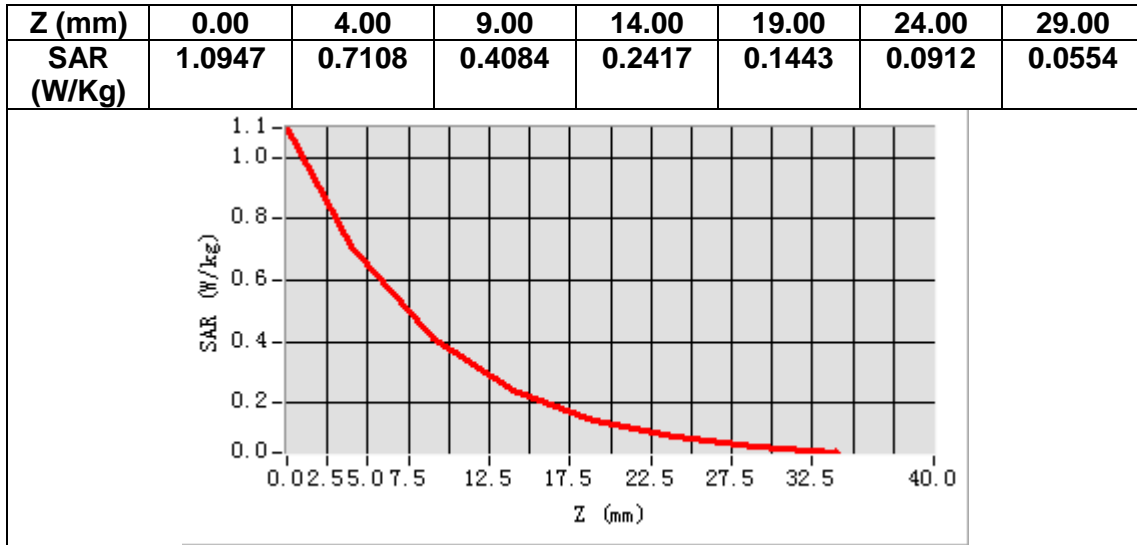

# MEASUREMENT 11

Date of measurement: 23/9/2022

## A. Experimental conditions.

<b>Area Scan</b>	<u>dx=15mm dy=15mm, h= 5.00 mm</u>
<b>ZoomScan</b>	<u>5x5x7, dx=8mm dy=8mm dz=5mm</u>
<b>Phantom</b>	<u>Validation plane</u>
<b>Device Position</b>	<u>Body</u>
<b>Band</b>	<u>LTE band 5</u>
<b>Channels</b>	<u>Middle</u>
<b>Signal</b>	<u>LTE (Crest factor: 1.0)</u>
<b>ConvF</b>	<u>1.50</u>

## B. SAR Measurement Results

<b>Frequency (MHz)</b>	836.500000
<b>Relative permittivity (real part)</b>	41.291401
<b>Relative permittivity (imaginary part)</b>	19.946489
<b>Conductivity (S/m)</b>	0.926958
<b>Variation (%)</b>	-1.380000

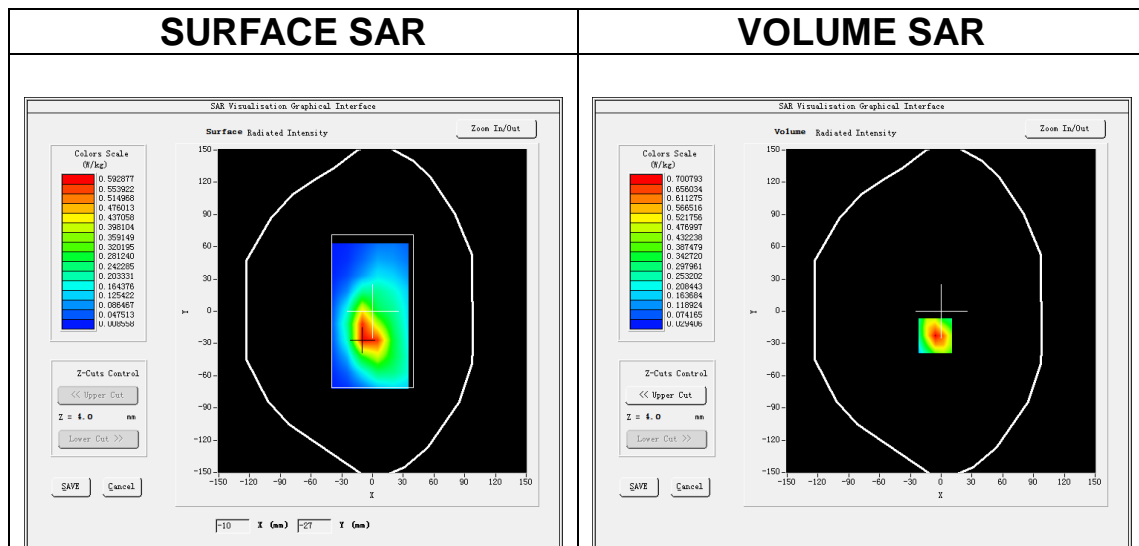

**Maximum location: X=-6.00, Y=-23.00**  
**SAR Peak: 1.12 W/kg**

<b>SAR 10g (W/Kg)</b>	0.366334
<b>SAR 1g (W/Kg)</b>	0.677137

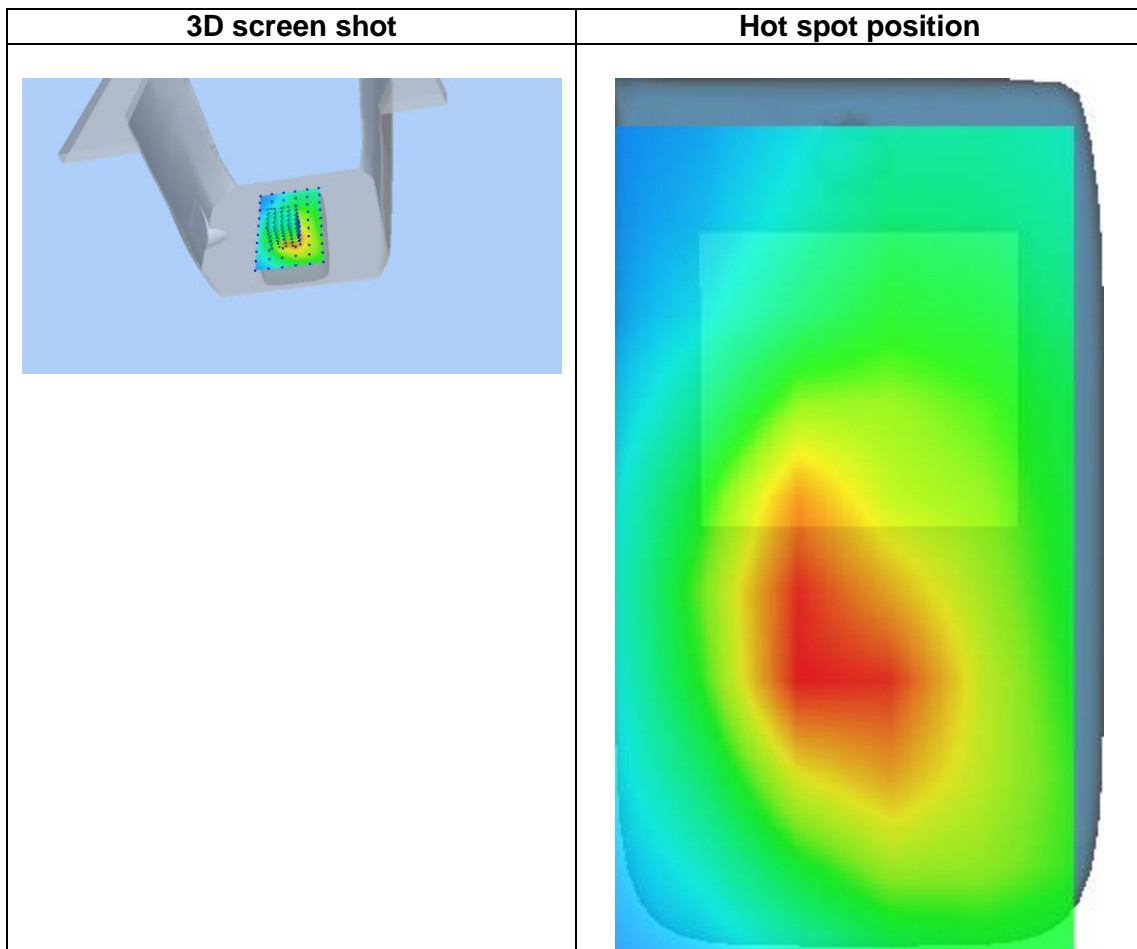
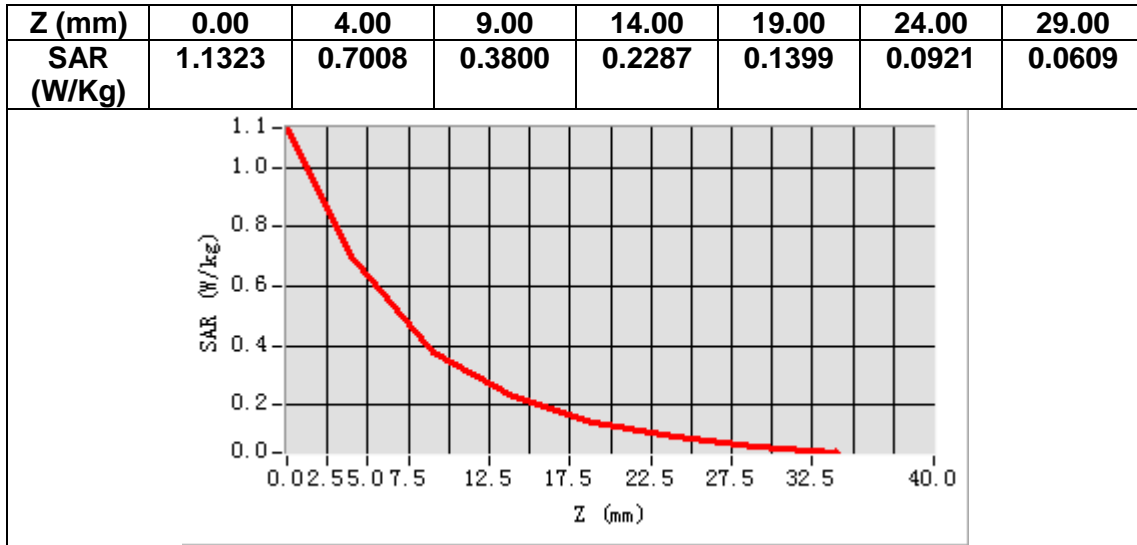

# MEASUREMENT 12

Date of measurement: 22/9/2022

## A. Experimental conditions.

<b>Area Scan</b>	<u>dx=12mm dy=12mm, h= 5.00 mm</u>
<b>ZoomScan</b>	<u>7x7x7, dx=5mm dy=5mm dz=5mm</u>
<b>Phantom</b>	<u>Validation plane</u>
<b>Device Position</b>	<u>Body</u>
<b>Band</b>	<u>LTE band 7</u>
<b>Channels</b>	<u>Low</u>
<b>Signal</b>	<u>LTE (Crest factor: 1.0)</u>
<b>ConvF</b>	<u>1.87</u>

## B. SAR Measurement Results

<b>Frequency (MHz)</b>	2510.000000
<b>Relative permittivity (real part)</b>	38.136253
<b>Relative permittivity (imaginary part)</b>	13.053935
<b>Conductivity (S/m)</b>	1.820299
<b>Variation (%)</b>	-3.250000

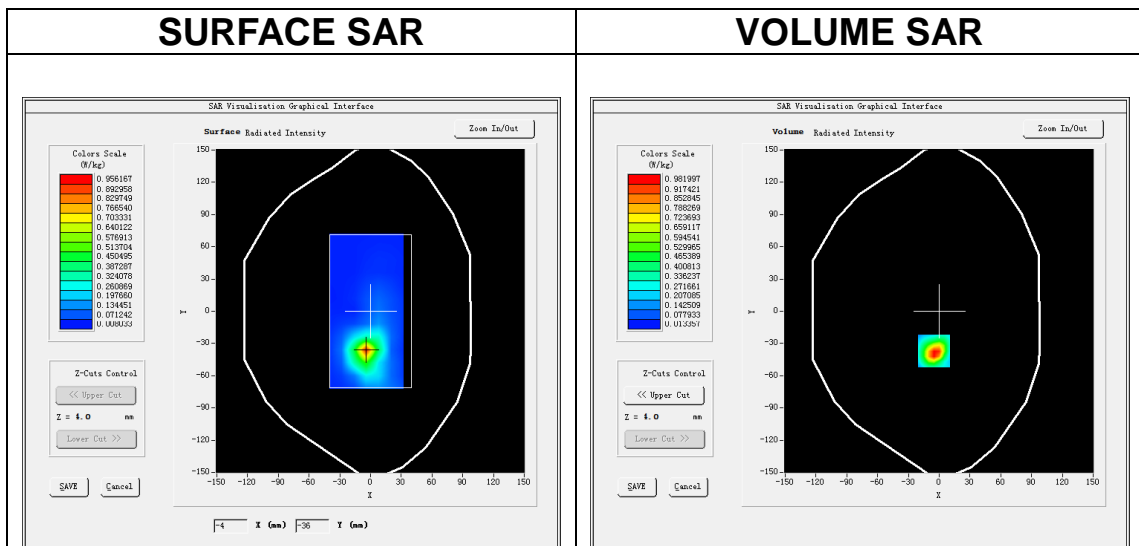

**Maximum location: X=-5.00, Y=-37.00**  
**SAR Peak: 1.84 W/kg**

<b>SAR 10g (W/Kg)</b>	0.366745
<b>SAR 1g (W/Kg)</b>	0.909561

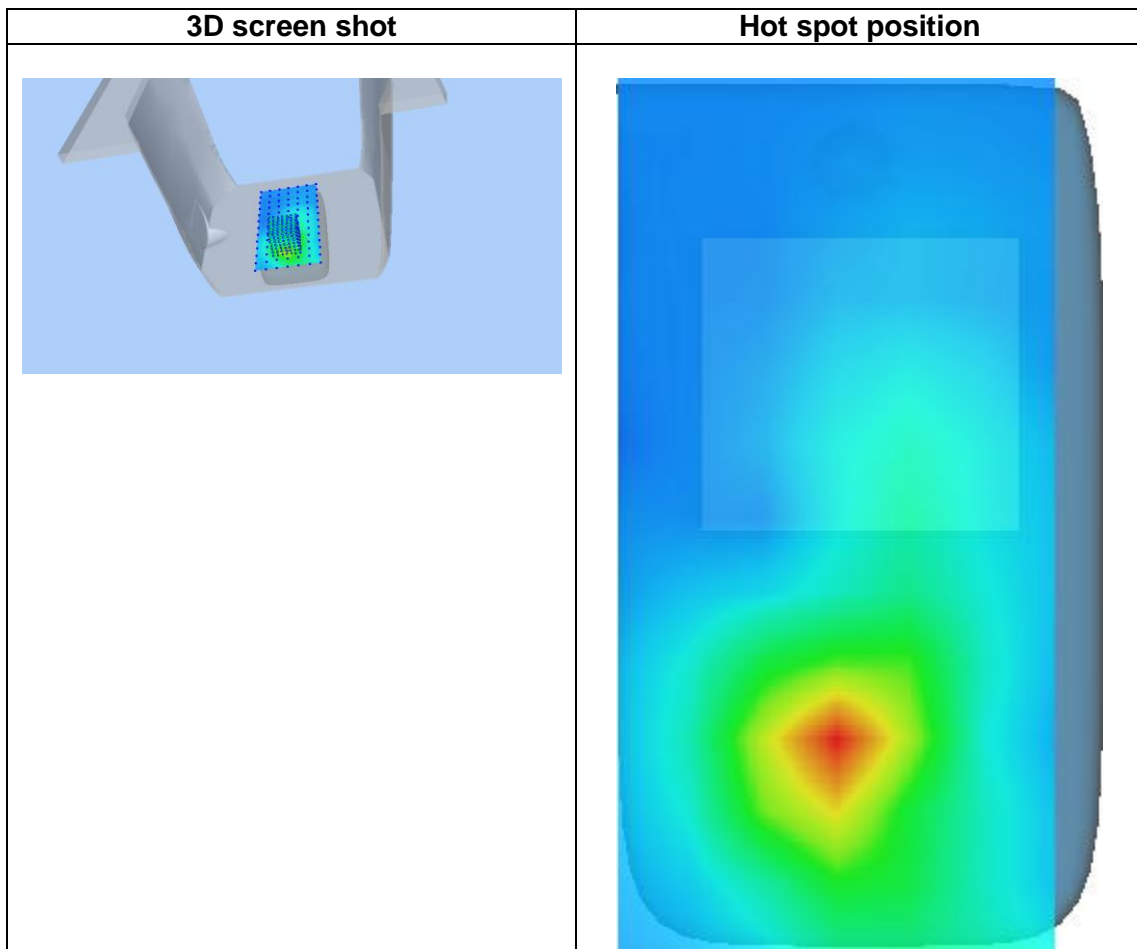
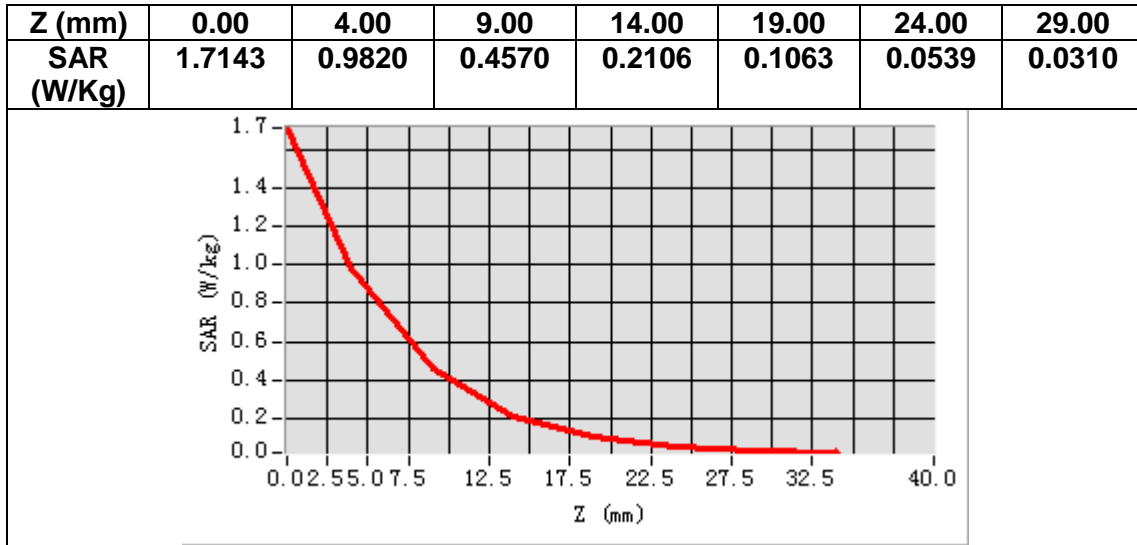

# MEASUREMENT 13

Date of measurement: 20/9/2022

## A. Experimental conditions.

<u>Area Scan</u>	<u>dx=15mm dy=15mm, h= 5.00 mm</u>
<u>ZoomScan</u>	<u>5x5x7, dx=8mm dy=8mm dz=5mm</u>
<u>Phantom</u>	<u>Validation plane</u>
<u>Device Position</u>	<u>Body</u>
<u>Band</u>	<u>LTE band 12</u>
<u>Channels</u>	<u>Middle</u>
<u>Signal</u>	<u>LTE (Crest factor: 1.0)</u>
<u>ConvF</u>	<u>1.49</u>

## B. SAR Measurement Results

<b>Frequency (MHz)</b>	707.500000
<b>Relative permittivity (real part)</b>	40.672363
<b>Relative permittivity (imaginary part)</b>	21.707848
<b>Conductivity (S/m)</b>	0.853239
<b>Variation (%)</b>	-1.490000

### SURFACE SAR

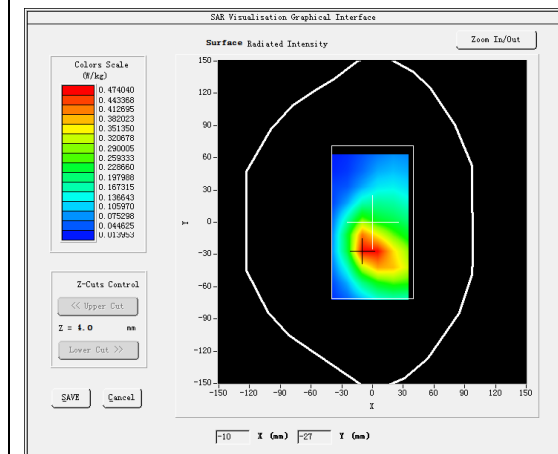

### VOLUME SAR

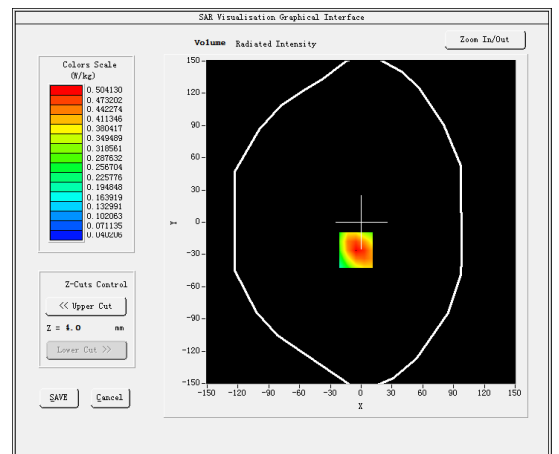

**Maximum location: X=-5.00, Y=-26.00**  
**SAR Peak: 0.72 W/kg**

<b>SAR 10g (W/Kg)</b>	0.311099
<b>SAR 1g (W/Kg)</b>	0.484215



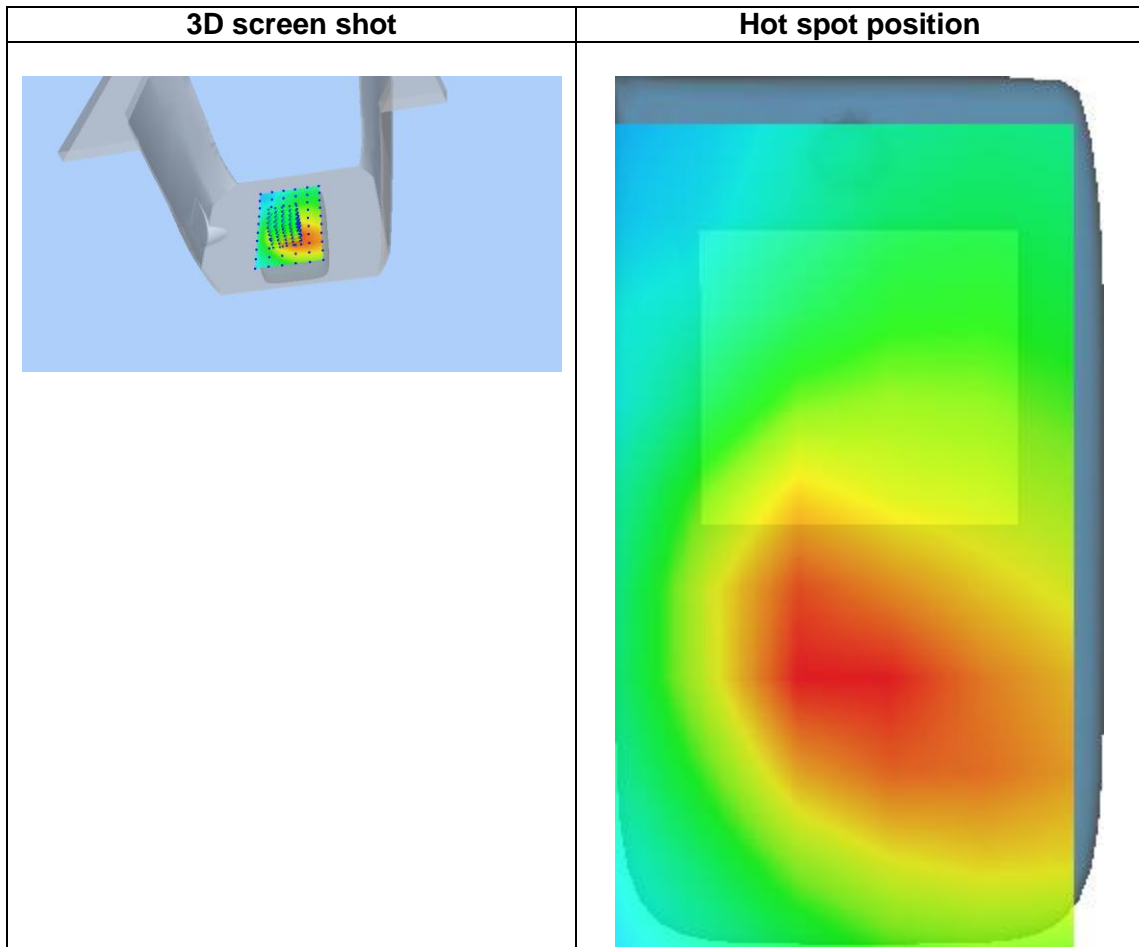
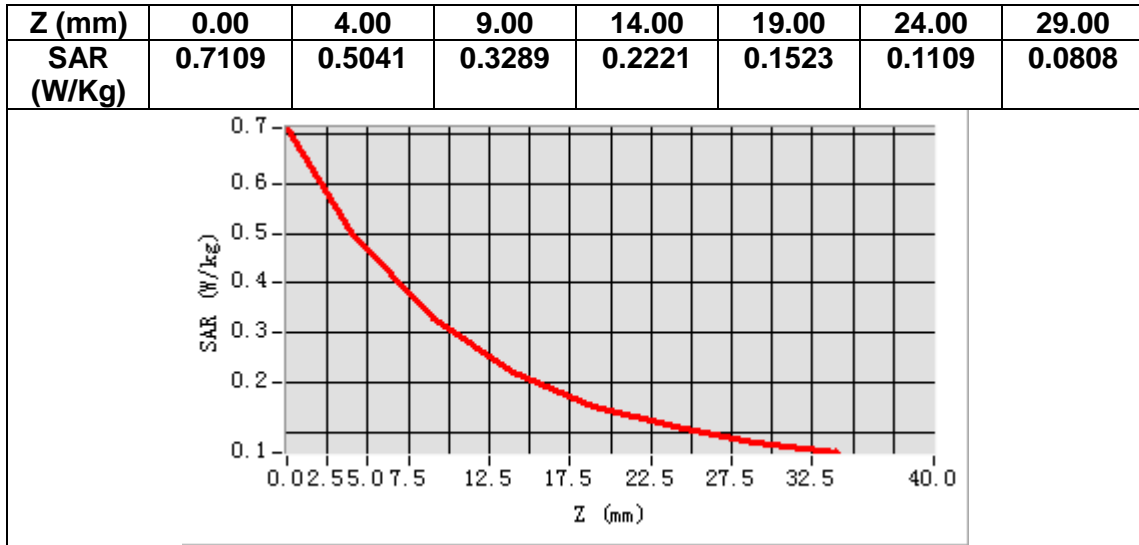

# MEASUREMENT 14

Date of measurement: 20/9/2022

## A. Experimental conditions.

<b>Area Scan</b>	<u>dx=15mm dy=15mm, h= 5.00 mm</u>
<b>ZoomScan</b>	<u>5x5x7, dx=8mm dy=8mm dz=5mm</u>
<b>Phantom</b>	<u>Validation plane</u>
<b>Device Position</b>	<u>Body</u>
<b>Band</b>	<u>LTE band 17</u>
<b>Channels</b>	<u>Middle</u>
<b>Signal</b>	<u>LTE (Crest factor: 1.0)</u>
<b>ConvF</b>	<u>1.49</u>

## B. SAR Measurement Results

<b>Frequency (MHz)</b>	710.000000
<b>Relative permittivity (real part)</b>	40.657013
<b>Relative permittivity (imaginary part)</b>	21.648298
<b>Conductivity (S/m)</b>	0.853905
<b>Variation (%)</b>	-0.920000

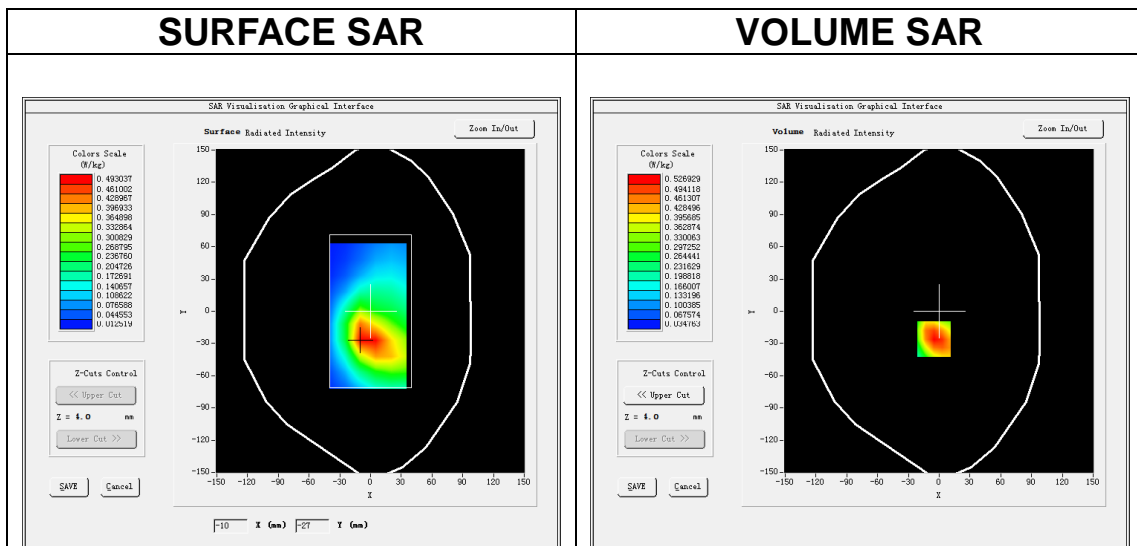

**Maximum location: X=-5.00, Y=-26.00**  
**SAR Peak: 0.76 W/kg**

<b>SAR 10g (W/Kg)</b>	0.324642
<b>SAR 1g (W/Kg)</b>	0.507378

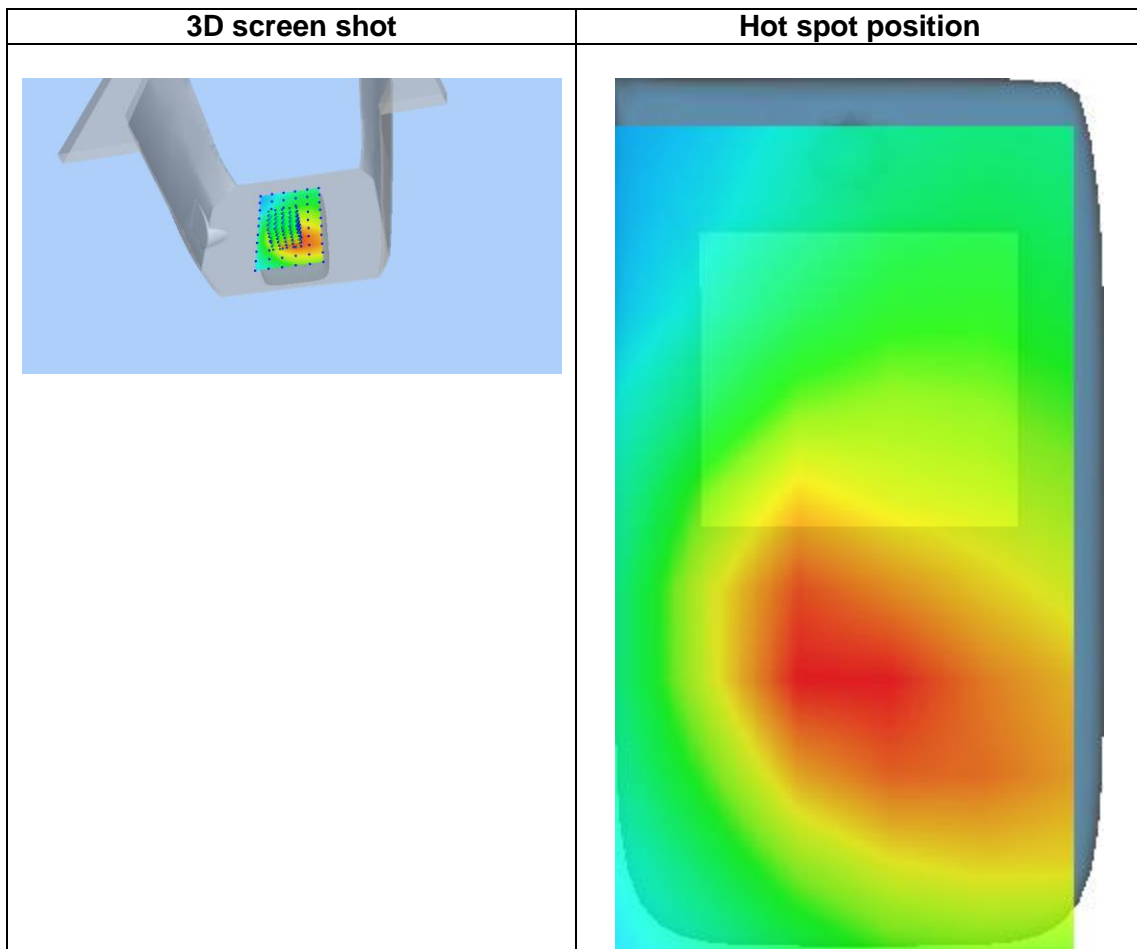
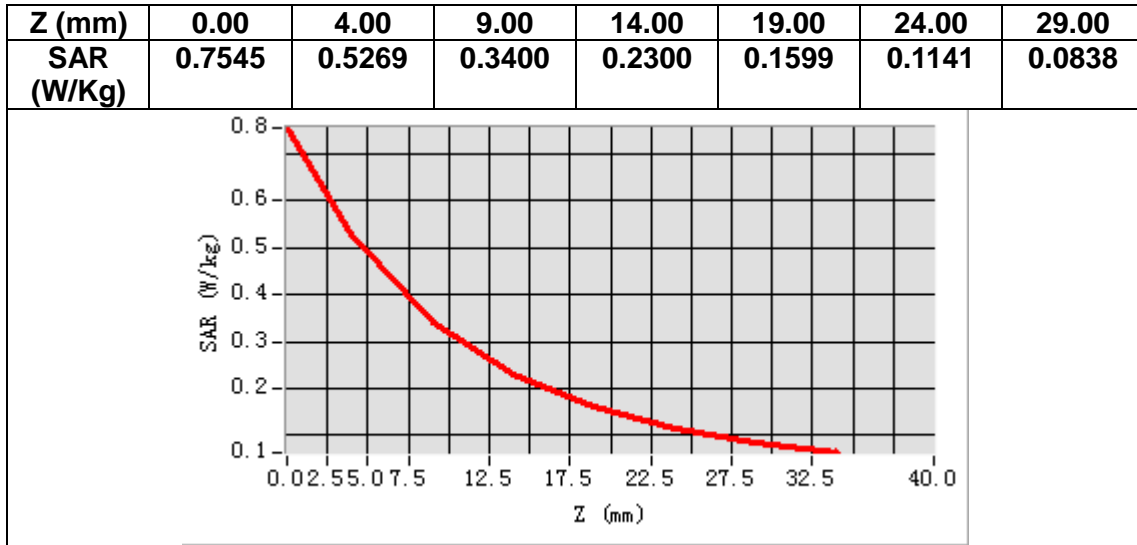

# MEASUREMENT 15

Date of measurement: 8/10/2022

## A. Experimental conditions.

<b>Area Scan</b>	<u>dx=15mm dy=15mm, h= 5.00 mm</u>
<b>ZoomScan</b>	<u>5x5x7, dx=8mm dy=8mm dz=5mm</u>
<b>Phantom</b>	<u>Validation plane</u>
<b>Device Position</b>	<u>Body</u>
<b>Band</b>	<u>LTE band 25</u>
<b>Channels</b>	<u>Middle</u>
<b>Signal</b>	<u>LTE (Crest factor: 1.0)</u>
<b>ConvF</b>	<u>1.91</u>

## B. SAR Measurement Results

<b>Frequency (MHz)</b>	1882.500000
<b>Relative permittivity (real part)</b>	38.434566
<b>Relative permittivity (imaginary part)</b>	13.829894
<b>Conductivity (S/m)</b>	1.445992
<b>Variation (%)</b>	-1.750000

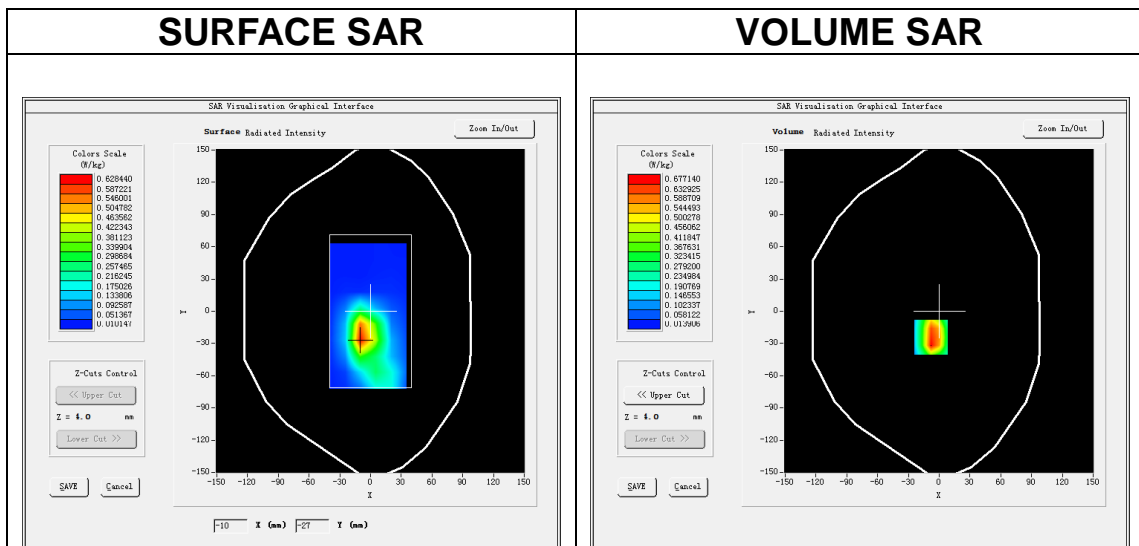

**Maximum location: X=-8.00, Y=-24.00**  
**SAR Peak: 1.22 W/kg**

<b>SAR 10g (W/Kg)</b>	0.327522
<b>SAR 1g (W/Kg)</b>	0.677947

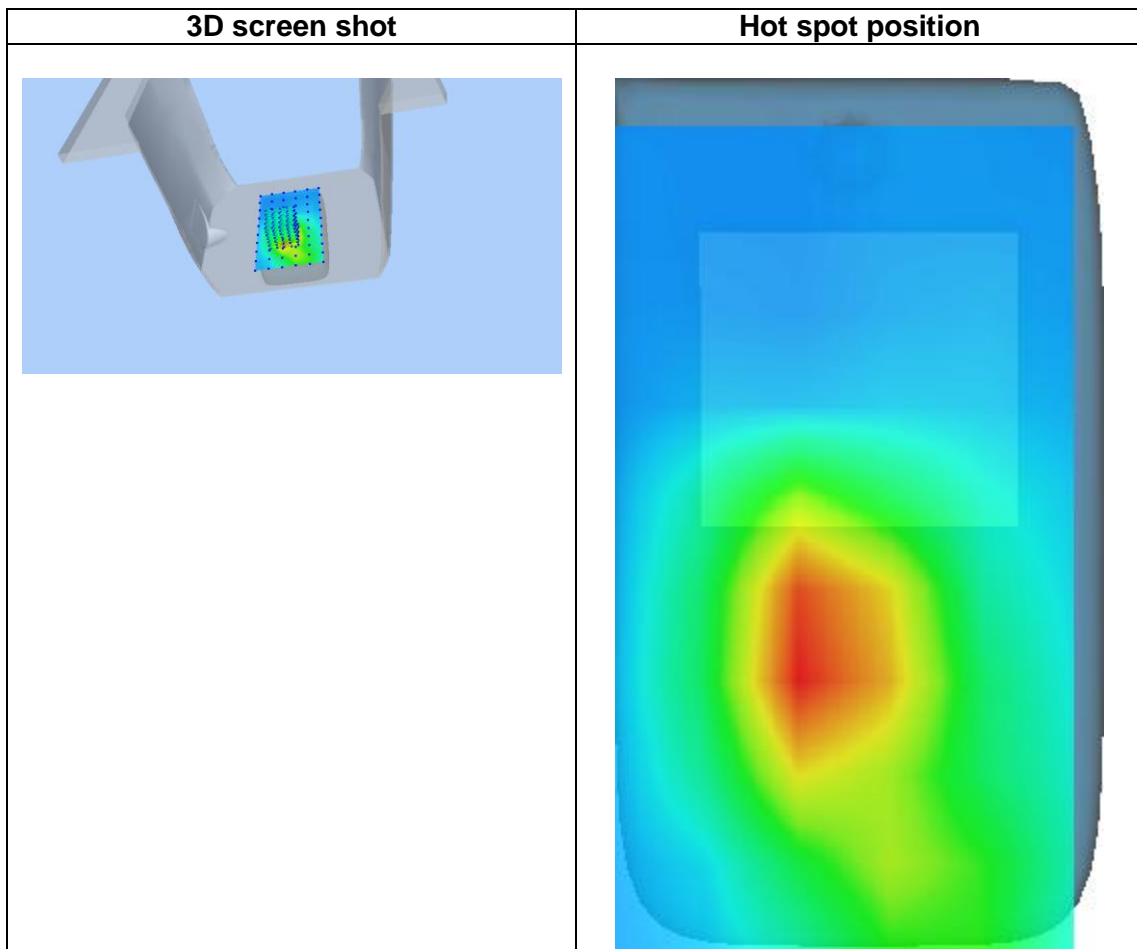
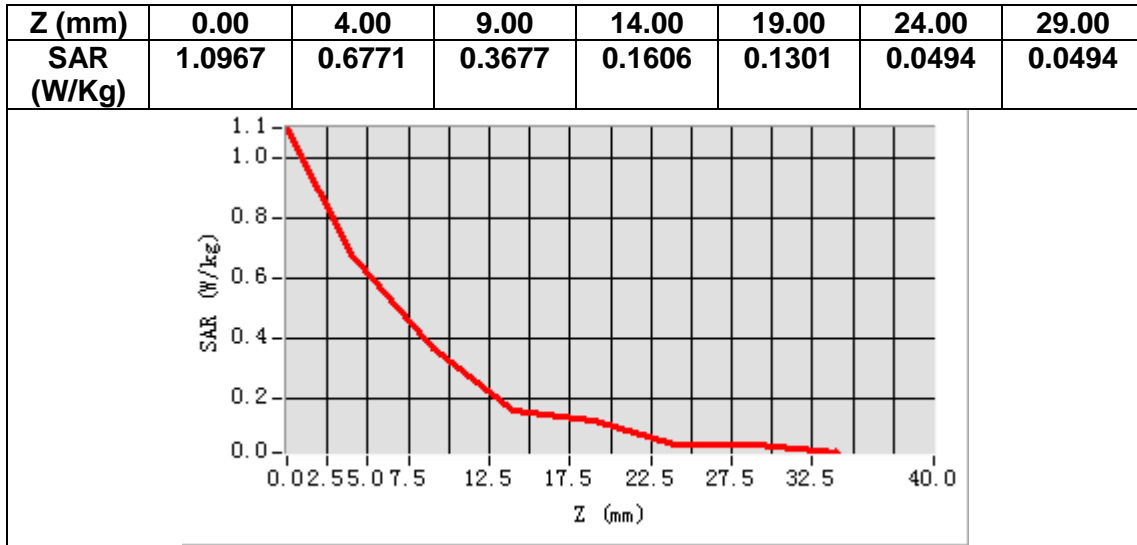

# MEASUREMENT 16

Date of measurement: 23/9/2022

## A. Experimental conditions.

<u>Area Scan</u>	<u>dx=15mm dy=15mm, h= 5.00 mm</u>
<u>ZoomScan</u>	<u>5x5x7, dx=8mm dy=8mm dz=5mm</u>
<u>Phantom</u>	<u>Validation plane</u>
<u>Device Position</u>	<u>Body</u>
<u>Band</u>	<u>LTE band 26a</u>
<u>Channels</u>	<u>Middle</u>
<u>Signal</u>	<u>LTE (Crest factor: 1.0)</u>
<u>ConvF</u>	<u>1.50</u>

## B. SAR Measurement Results

<b>Frequency (MHz)</b>	819.000000
<b>Relative permittivity (real part)</b>	41.558050
<b>Relative permittivity (imaginary part)</b>	19.930289
<b>Conductivity (S/m)</b>	0.906828
<b>Variation (%)</b>	-0.870000

### SURFACE SAR

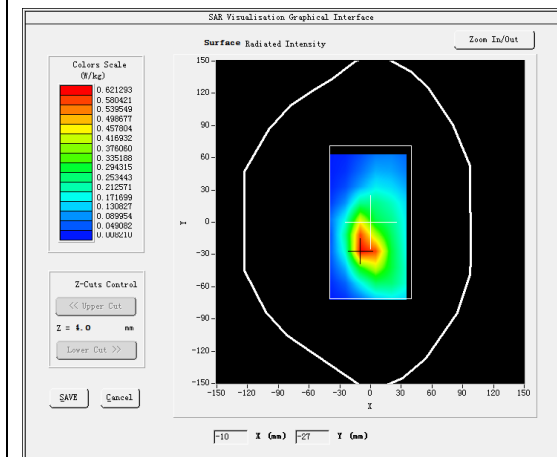

### VOLUME SAR

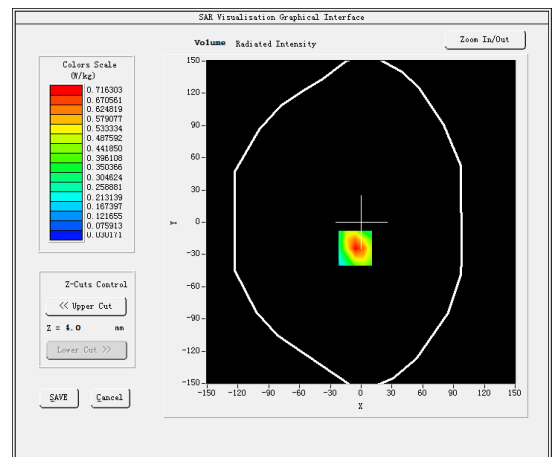

Maximum location: X=-6.00, Y=-24.00  
SAR Peak: 1.15 W/kg

<b>SAR 10g (W/Kg)</b>	0.375750
<b>SAR 1g (W/Kg)</b>	0.690433

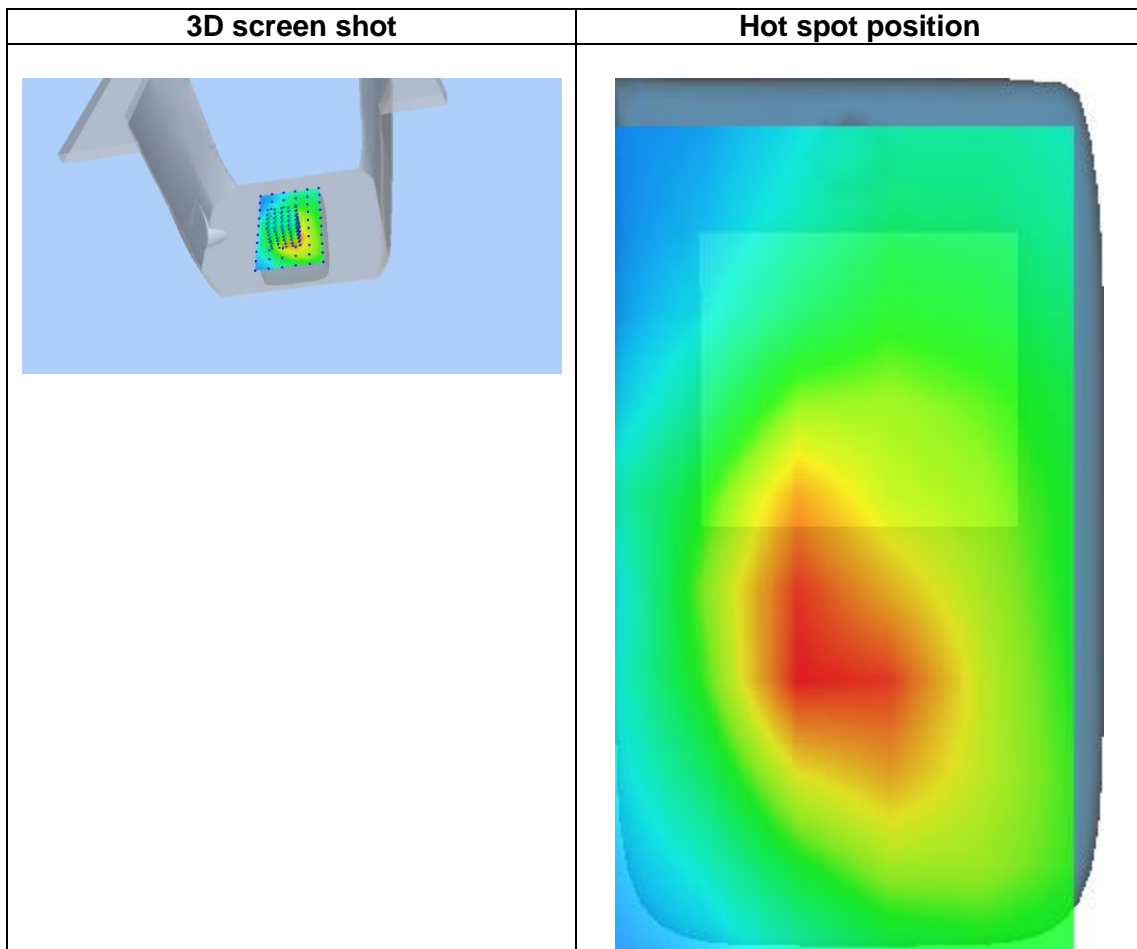
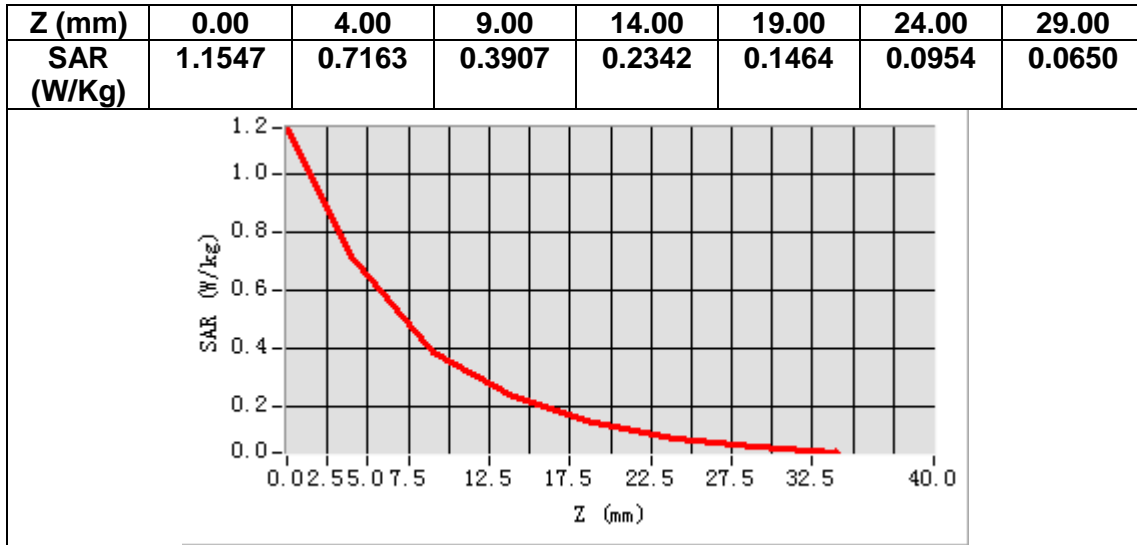

# MEASUREMENT 17

Date of measurement: 23/9/2022

## A. Experimental conditions.

<u>Area Scan</u>	<u>dx=15mm dy=15mm, h= 5.00 mm</u>
<u>ZoomScan</u>	<u>5x5x7, dx=8mm dy=8mm dz=5mm</u>
<u>Phantom</u>	<u>Validation plane</u>
<u>Device Position</u>	<u>Body</u>
<u>Band</u>	<u>LTE band 26b</u>
<u>Channels</u>	<u>Middle</u>
<u>Signal</u>	<u>LTE (Crest factor: 1.0)</u>
<u>ConvF</u>	<u>1.50</u>

## B. SAR Measurement Results

<b>Frequency (MHz)</b>	831.500000
<b>Relative permittivity (real part)</b>	41.342098
<b>Relative permittivity (imaginary part)</b>	19.936239
<b>Conductivity (S/m)</b>	0.920943
<b>Variation (%)</b>	-0.350000

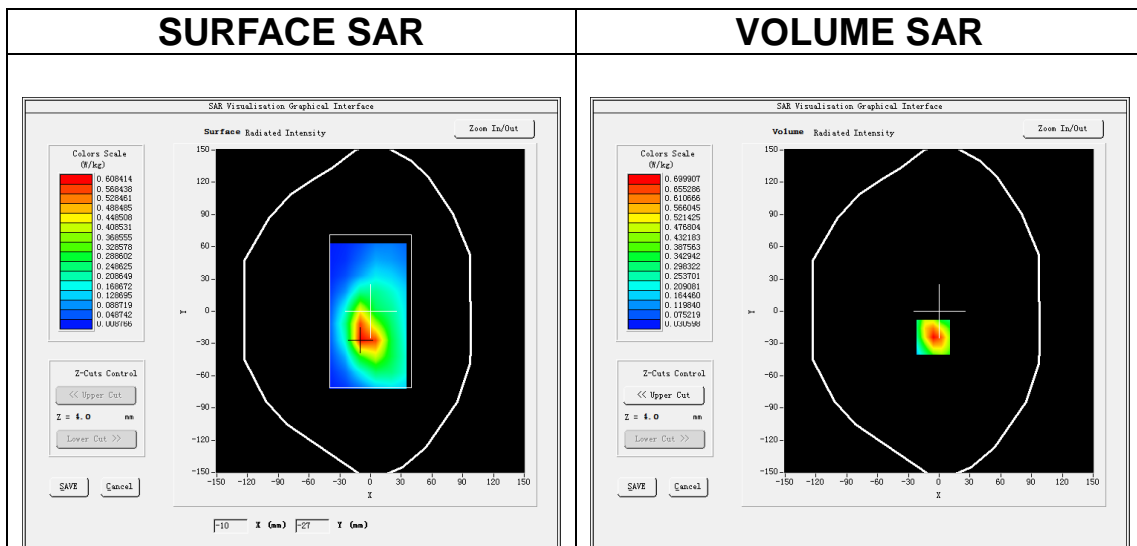

Maximum location: X=-6.00, Y=-24.00  
SAR Peak: 1.12 W/kg

<b>SAR 10g (W/Kg)</b>	0.369009
<b>SAR 1g (W/Kg)</b>	0.674372



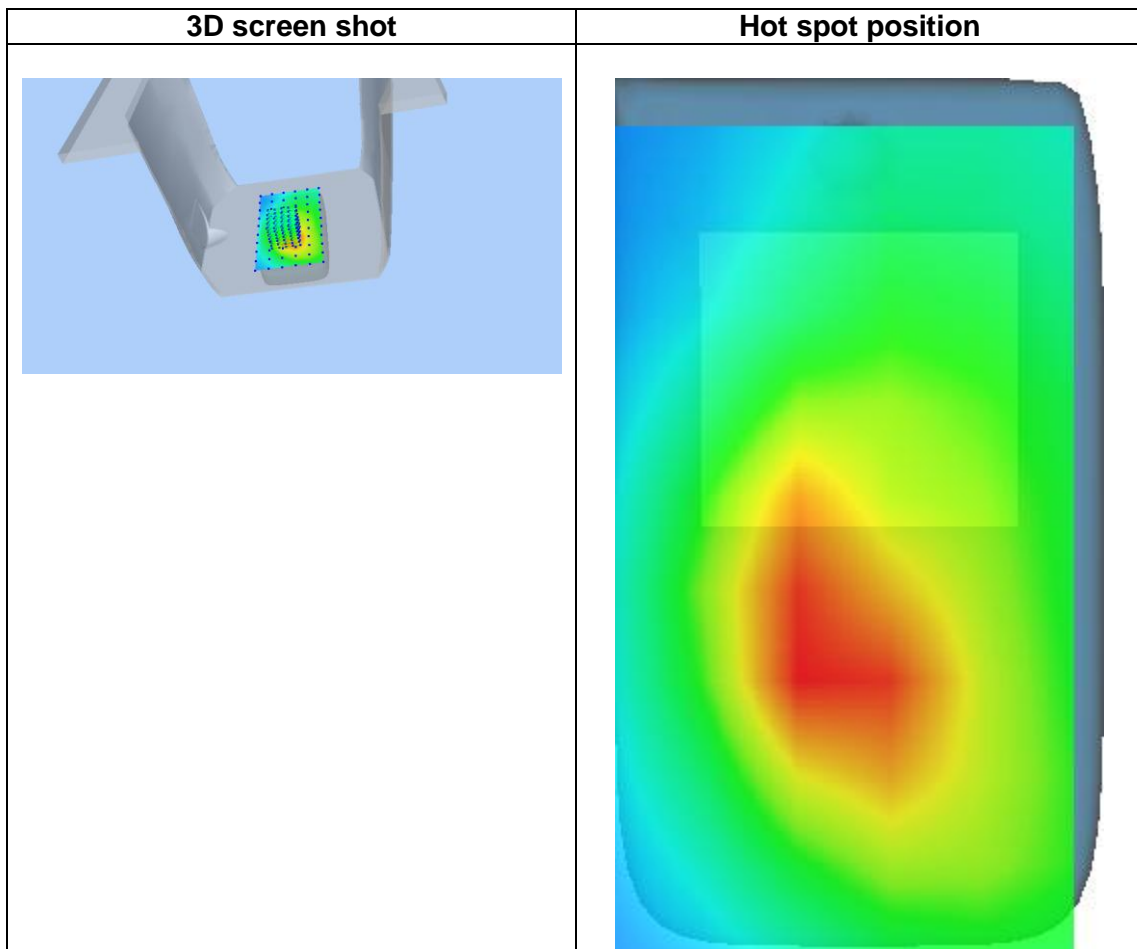
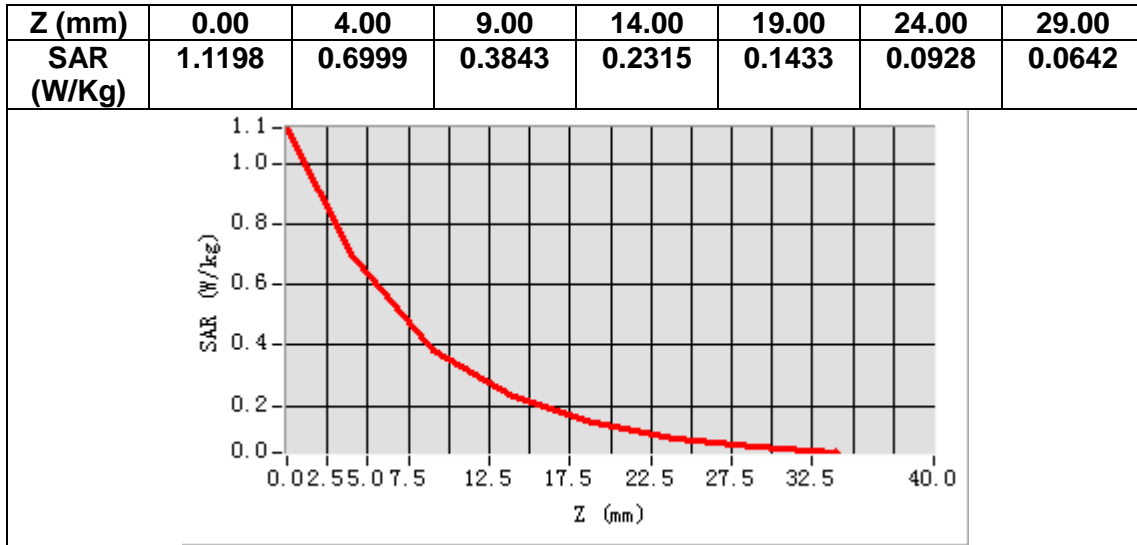

# MEASUREMENT 18

Date of measurement: 22/9/2022

## A. Experimental conditions.

<b>Area Scan</b>	<u>dx=12mm dy=12mm, h= 5.00 mm</u>
<b>ZoomScan</b>	<u>7x7x7, dx=5mm dy=5mm dz=5mm</u>
<b>Phantom</b>	<u>Validation plane</u>
<b>Device Position</b>	<u>Body</u>
<b>Band</b>	<u>LTE band 41</u>
<b>Channels</b>	<u>Low</u>
<b>Signal</b>	<u>LTE (Crest factor: 1.6)</u>
<b>ConvF</b>	<u>1.87</u>

## B. SAR Measurement Results

<b>Frequency (MHz)</b>	2595.000000
<b>Relative permittivity (real part)</b>	37.653252
<b>Relative permittivity (imaginary part)</b>	13.325035
<b>Conductivity (S/m)</b>	1.921026
<b>Variation (%)</b>	-0.480000

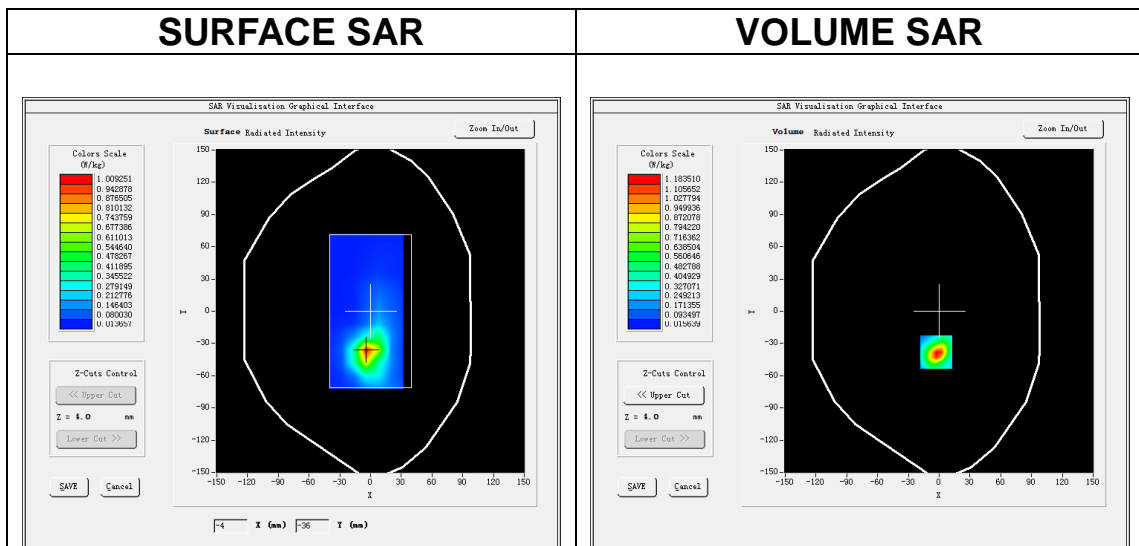

**Maximum location: X=-3.00, Y=-38.00**  
**SAR Peak: 2.23 W/kg**

<b>SAR 10g (W/Kg)</b>	0.431500
<b>SAR 1g (W/Kg)</b>	0.984827

Z (mm)	0.00	4.00	9.00	14.00	19.00	24.00	29.00
SAR (W/Kg)	2.1247	1.1835	0.5254	0.2380	0.1184	0.0599	0.0339

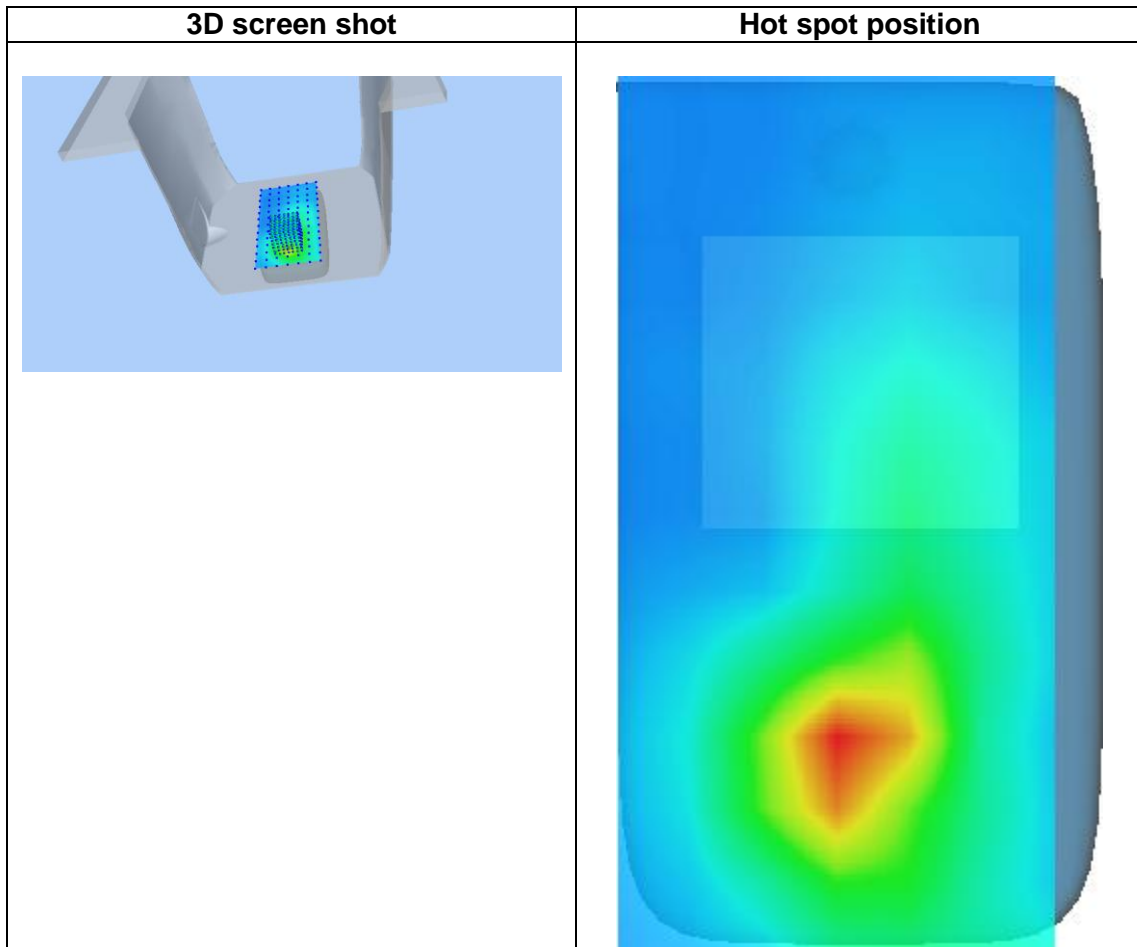
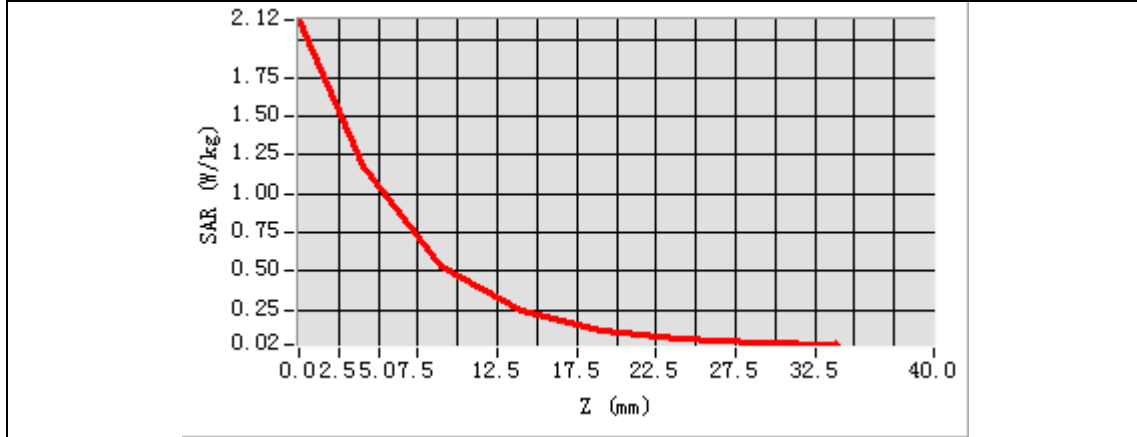

# MEASUREMENT 19

Date of measurement: 21/9/2022

## A. Experimental conditions.

<b>Area Scan</b>	<u>dx=15mm dy=15mm, h= 5.00 mm</u>
<b>ZoomScan</b>	<u>5x5x7, dx=8mm dy=8mm dz=5mm</u>
<b>Phantom</b>	<u>Validation plane</u>
<b>Device Position</b>	<u>Body</u>
<b>Band</b>	<u>LTE band 66</u>
<b>Channels</b>	<u>Middle</u>
<b>Signal</b>	<u>LTE (Crest factor: 1.0)</u>
<b>ConvF</b>	<u>1.73</u>

## B. SAR Measurement Results

<b>Frequency (MHz)</b>	1745.000000
<b>Relative permittivity (real part)</b>	39.072861
<b>Relative permittivity (imaginary part)</b>	13.782281
<b>Conductivity (S/m)</b>	1.336116
<b>Variation (%)</b>	-1.210000

### SURFACE SAR

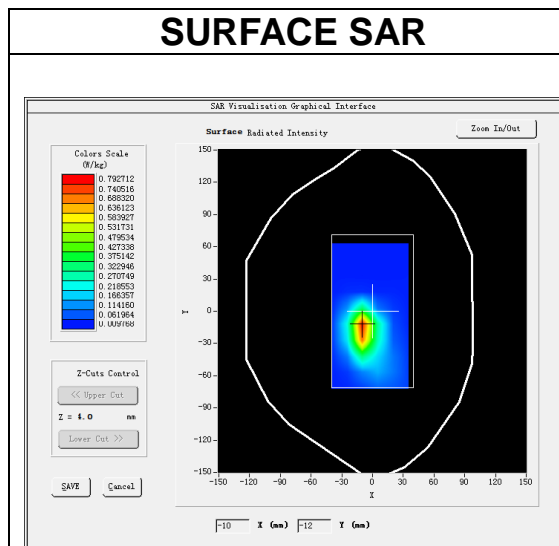

### VOLUME SAR

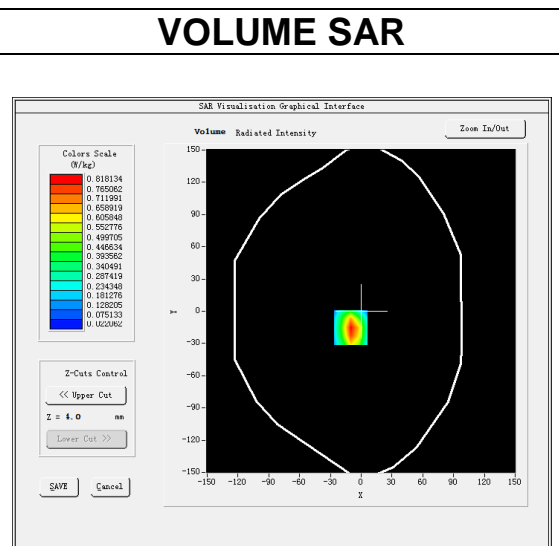

Maximum location: X=-10.00, Y=-15.00

SAR Peak: 1.27 W/kg

<b>SAR 10g (W/Kg)</b>	0.389658
<b>SAR 1g (W/Kg)</b>	0.761213

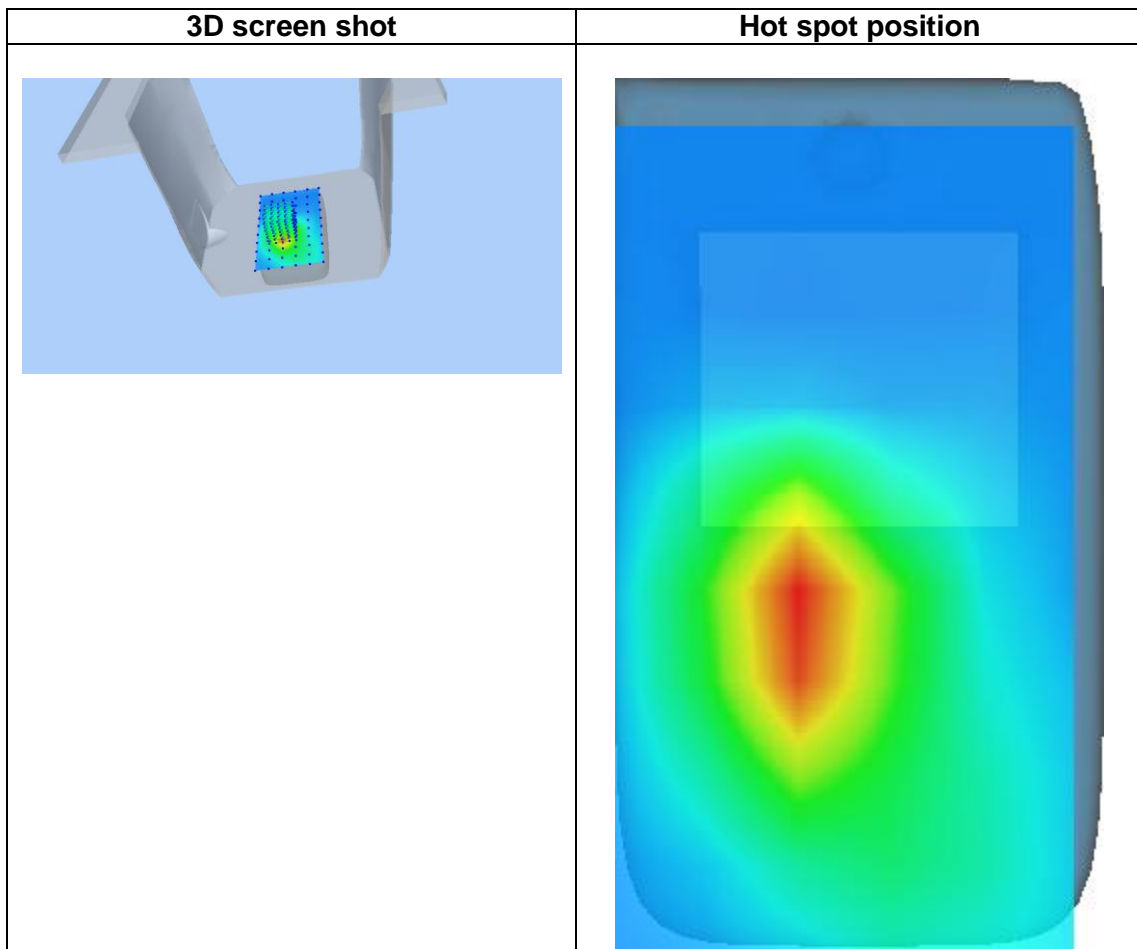
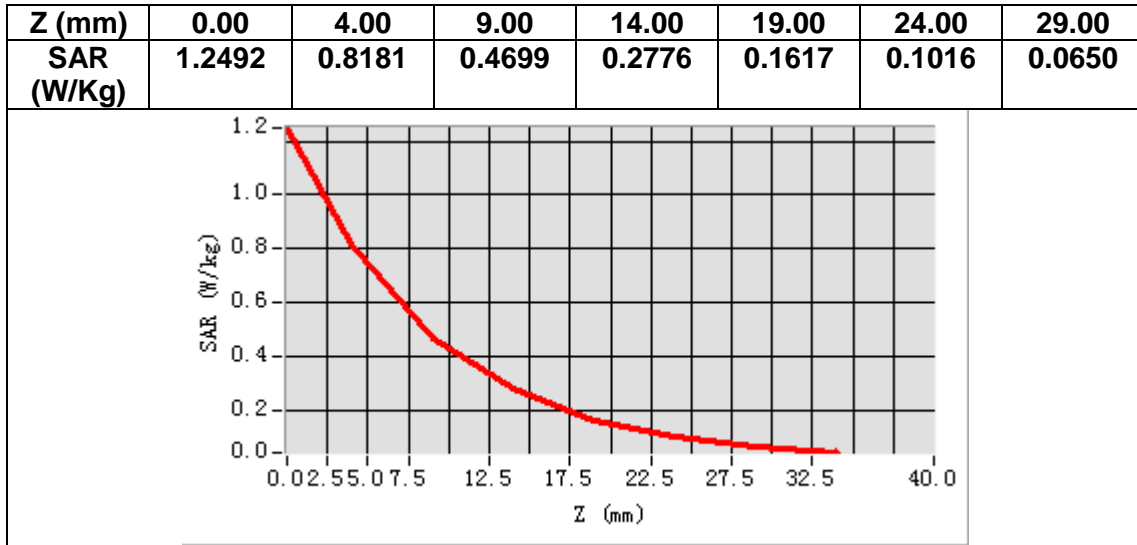

## 14. Appendix D. Calibration Certificate

<b>Table of contents</b>
E Field Probe - SN 08/16 EPGO287
750 MHz Dipole - SN 03/15 DIP 0G750-355
835 MHz Dipole - SN 03/15 DIP 0G835-347
1800 MHz Dipole - SN 03/15 DIP 1G800-349
1900 MHz Dipole - SN 03/15 DIP 1G900-350
2450 MHz Dipole - SN 03/15 DIP 2G450-352
2600 MHz Dipole - SN 03/15 DIP 2G600-356
5000-6000 MHz Dipole - SN 13/14 WGA 33
Extended Calibration Certificate



## COMOSAR E-Field Probe Calibration Report

Ref : ACR.60.1.21.MVGB.A

**SHENZHEN NTEK TESTING TECHNOLOGY  
CO., LTD.**

**BUILDING E, FENDA SCIENCE PARK, SANWEI  
COMMUNITY, XIXIANG STREET,  
BAO'AN DISTRICT, SHENZHEN GUANGDONG, CHINA  
MVG COMOSAR DOSIMETRIC E-FIELD PROBE  
SERIAL NO.: SN 08/16 EPGO287**

**Calibrated at MVG**

**Z.I. de la pointe du diable**

**Technopôle Brest Iroise – 295 avenue Alexis de Rochon  
29280 PLOUZANE - FRANCE**

**Calibration date: 02/01/2022**



Accreditations #2-6789 and #2-6814  
Scope available on [www.cofrac.fr](http://www.cofrac.fr)

*Summary:*

This document presents the method and results from an accredited COMOSAR E-Field Probe calibration performed at MVG, using the CALIPROBE test bench, for use with a MVG COMOSAR system only. The test results covered by accreditation are traceable to the International System of Units (SI).



COMOSAR E-FIELD PROBE CALIBRATION REPORT

Ref: ACR.60.1.21.MVGB.A

	Name	Function	Date	Signature
Prepared by :	Jérôme Luc	Technical Manager	2/1/2022	<i>JS</i>
Checked by :	Jérôme Luc	Technical Manager	2/1/2022	<i>JS</i>
Approved by :	Yann Toutain	Laboratory Director	2/1/2022	<i>Yann Toutain</i>

Mode d'emploi  
2022.02.0  
1 10:07:13  
+01'00'

PHILIPS

	Customer Name
Distribution :	SHENZHEN NTEK TESTING TECHNOLOGY CO., LTD.

Issue	Name	Date	Modifications
A	Jérôme Luc	2/1/2022	Initial release





COMOSAR E-FIELD PROBE CALIBRATION REPORT

Ref. ACR.60.1.21.MVGB.A

TABLE OF CONTENTS

1	Device Under Test .....	4
2	Product Description .....	4
2.1	General Information .....	4
3	Measurement Method .....	4
3.1	Linearity .....	4
3.2	Sensitivity .....	5
3.3	Lower Detection Limit .....	5
3.4	Isotropy .....	5
3.1	Boundary Effect .....	5
4	Measurement Uncertainty .....	6
5	Calibration Measurement Results .....	6
5.1	Sensitivity in air .....	6
5.2	Linearity .....	7
5.3	Sensitivity in liquid .....	8
5.4	Isotropy .....	9
6	List of Equipment .....	10



**COMOSAR E-FIELD PROBE CALIBRATION REPORT**

Ref: ACR.60.1.21.MVGB.A

**1 DEVICE UNDER TEST**

Device Under Test	
Device Type	COMOSAR DOSIMETRIC E FIELD PROBE
Manufacturer	MVG
Model	SSE2
Serial Number	SN 08/16 EPGO287
Product Condition (new / used)	Used
Frequency Range of Probe	0.15 GHz-6GHz
Resistance of Three Dipoles at Connector	Dipole 1: R1=0.211 MΩ Dipole 2: R2=0.199 MΩ Dipole 3: R3=0.199 MΩ

**2 PRODUCT DESCRIPTION**

**2.1 GENERAL INFORMATION**

MVG’s COMOSAR E field Probes are built in accordance to the IEEE 1528, FCC KDB865664 D01, CENELEC EN62209 and CEI/IEC 62209 standards.



**Figure 1 – MVG COMOSAR Dosimetric E field Dipole**

Probe Length	330 mm
Length of Individual Dipoles	2 mm
Maximum external diameter	8 mm
Probe Tip External Diameter	2.5 mm
Distance between dipoles / probe extremity	1 mm

**3 MEASUREMENT METHOD**

The IEEE 1528, FCC KDB865664 D01, CENELEC EN62209 and CEI/IEC 62209 standards provide recommended practices for the probe calibrations, including the performance characteristics of interest and methods by which to assess their affect. All calibrations / measurements performed meet the fore mentioned standards.

**3.1 LINEARITY**

The evaluation of the linearity was done in free space using the waveguide, performing a power sweep to cover the SAR range 0.01W/kg to 100W/kg.



COMOSAR E-FIELD PROBE CALIBRATION REPORT

Ref: ACR.60.1.21.MVGB.A

3.2 SENSITIVITY

The sensitivity factors of the three dipoles were determined using a two step calibration method (air and tissue simulating liquid) using waveguides as outlined in the standards.

3.3 LOWER DETECTION LIMIT

The lower detection limit was assessed using the same measurement set up as used for the linearity measurement. The required lower detection limit is 10 mW/kg.

3.4 ISOTROPY

The axial isotropy was evaluated by exposing the probe to a reference wave from a standard dipole with the dipole mounted under the flat phantom in the test configuration suggested for system validations and checks. The probe was rotated along its main axis from 0 to 360 degrees in 15-degree steps. The hemispherical isotropy is determined by inserting the probe in a thin plastic box filled with tissue-equivalent liquid, with the plastic box illuminated with the fields from a half wave dipole. The dipole is rotated about its axis (0°–180°) in 15° increments. At each step the probe is rotated about its axis (0°–360°).

3.1 BOUNDARY EFFECT

The boundary effect is defined as the deviation between the SAR measured data and the expected exponential decay in the liquid when the probe is oriented normal to the interface. To evaluate this effect, the liquid filled flat phantom is exposed to fields from either a reference dipole or waveguide. With the probe normal to the phantom surface, the peak spatial average SAR is measured and compared to the analytical value at the surface.

The boundary effect uncertainty can be estimated according to the following uncertainty approximation formula based on linear and exponential extrapolations between the surface and  $d_{be} + d_{step}$  along lines that are approximately normal to the surface:

$$SAR_{uncertainty} [\%] = \Delta SAR_{be} \frac{(d_{be} + d_{step})^2}{2d_{step}} \frac{(e^{-d_{be}/\delta})}{\delta/2} \text{ for } (d_{be} + d_{step}) < 10 \text{ mm}$$

where

- $SAR_{uncertainty}$  is the uncertainty in percent of the probe boundary effect
- $d_{be}$  is the distance between the surface and the closest *zoom-scan* measurement point, in millimetre
- $\Delta_{step}$  is the separation distance between the first and second measurement points that are closest to the phantom surface, in millimetre, assuming the boundary effect at the second location is negligible
- $\delta$  is the minimum penetration depth in millimetres of the head tissue-equivalent liquids defined in this standard, i.e.,  $\delta \approx 14$  mm at 3 GHz;
- $\Delta SAR_{be}$  in percent of SAR is the deviation between the measured SAR value, at the distance  $d_{be}$  from the boundary, and the analytical SAR value.



COMOSAR E-FIELD PROBE CALIBRATION REPORT

Ref: ACR.60.1.21.MVGB.A

The measured worst case boundary effect SARuncertainty[%] for scanning distances larger than 4mm is 1.0% Limit ,2%).

**4 MEASUREMENT UNCERTAINTY**

The guidelines outlined in the IEEE 1528, OET 65 Bulletin C, CENELEC EN50361 and CEI/IEC 62209 standards were followed to generate the measurement uncertainty associated with an E-field probe calibration using the waveguide technique. All uncertainties listed below represent an expanded uncertainty expressed at approximately the 95% confidence level using a coverage factor of k=2, traceable to the Internationally Accepted Guides to Measurement Uncertainty.

Uncertainty analysis of the probe calibration in waveguide					
ERROR SOURCES	Uncertainty value (%)	Probability Distribution	Divisor	ci	Standard Uncertainty (%)
Expanded uncertainty 95 % confidence level k = 2					14 %

**5 CALIBRATION MEASUREMENT RESULTS**

Calibration Parameters	
Liquid Temperature	20 +/- 1 °C
Lab Temperature	20 +/- 1 °C
Lab Humidity	30-70 %

**5.1 SENSITIVITY IN AIR**

Normx dipole 1 (µV/(V/m) <sup>2</sup> )	Normy dipole 2 (µV/(V/m) <sup>2</sup> )	Normz dipole 3 (µV/(V/m) <sup>2</sup> )
0.72	0.66	0.77

DCP dipole 1 (mV)	DCP dipole 2 (mV)	DCP dipole 3 (mV)
107	110	110

Calibration curves ei=f(V) (i=1,2,3) allow to obtain E-field value using the formula:

$$E = \sqrt{E_1^2 + E_2^2 + E_3^2}$$