



# **FCC TEST REPORT**

**FCC ID: 2AOKM-GV11**

On Behalf of

**Remote Tech LLC**

**Remote Key**

**Model No.: PRX-GPRS5, PRX-GPRS4**

Prepared for : Remote Tech LLC  
Address : 310 ALDER RD,Dover,DE 19904,USA

Prepared By : Shenzhen Alpha Product Testing Co., Ltd.  
Address : Building i, No.2, Lixin Road, Fuyong Street, Bao'an District, 518103,  
Shenzhen, Guangdong, China

Report Number : T1904177-C02-R01  
Date of Receipt : May 09, 2019  
Date of Test : May 09, 2019-May 14, 2019  
Date of Report : May 14, 2019  
Version Number : V0

## Contents

<b>1. General Information.....</b>	<b>5</b>
1.1. Description of Device (EUT) .....	5
1.2. Accessories of Device (EUT).....	6
1.3. Tested Supporting System Details.....	6
1.4. Test Facility .....	6
<b>2. Summary of test.....</b>	<b>7</b>
2.1. Summary of test result .....	7
2.2. Block Diagram .....	8
2.3. Test mode .....	8
2.4. Test Conditions.....	8
2.5. Measurement Uncertainty (95% confidence levels, k=2).....	8
2.6. Test Equipment.....	9
<b>3. Radiation Emission.....</b>	<b>10</b>
3.1. Radiation Emission Limits(15.209&231) .....	10
3.2. Test Setup .....	10
3.3. Test Procedure .....	12
3.4. Test Equipment Setting For emission test.....	12
3.5. Test Condition .....	12
3.6. Test Result.....	12
<b>4. Power Line Conducted Emission .....</b>	<b>18</b>
4.1. Conducted Emission Limits (15.209) .....	18
4.2. Test Setup .....	18
4.3. Test Procedure .....	19
4.4. Test Results .....	19
<b>5. Occupied bandwidth.....</b>	<b>20</b>
5.1. Test limit.....	20
5.2. Method of measurement.....	20
5.3. Test Setup .....	20
5.4. Test Results .....	20
<b>6. Transmission time.....</b>	<b>22</b>
6.1. Test limit.....	22
6.2. Method of measurement.....	22
6.3. Test Setup .....	22
6.4. Test Results .....	23
<b>7. Antenna Requirement .....</b>	<b>24</b>
7.1. Standard Requirement .....	24
7.2. Antenna Connected Construction .....	24
7.3. Result.....	24
<b>8. Test setup photo .....</b>	<b>25</b>
<b>9. Photos of EUT .....</b>	<b>26</b>

### TEST REPORT DECLARATION

Applicant : Remote Tech LLC  
 Address : 310 ALDER RD,Dover,DE 19904,USA  
 Manufacturer : Qinuo Electronics Co., Ltd  
 Address : 3/F, Bldg.A, Yucheng Base, Keji Rd., High-tech Industrial Park, Fengze, Quanzhou, Fujian 362000, P.R. China  
 EUT Description : Remote Key  
 (A) Model No. : PRX-GPRS5, PRX-GPRS4  
 (B) Trademark : N/A

Measurement Standard Used:

**FCC Rules and Regulations Part 15 Subpart C Section 15.231  
ANSI C63.10-2013**

The device described above is tested by Shenzhen Alpha Product Testing Co., Ltd. to determine the maximum emission levels emanating from the device. The maximum emission levels are compared to the FCC Part 15 Subpart C limits both conducted and radiated emissions. The test results are contained in this test report and Shenzhen Alpha Product Testing Co., Ltd. is assumed of full responsibility for the accuracy and completeness of these tests.

After the test, our opinion is that EUT compliance with the requirement of the above standards.

This report applies to above tested sample only. This report shall not be reproduced in parts without written approval of Shenzhen Alpha Product Testing Co., Ltd.

Tested by (name + signature).....: Ella Liang  
 Project Engineer 

Approved by (name + signature).....: Simple Guan  
 Project Manager 

Date of issue.....: May 14, 2019

**Revision History**

Revision	Issue Date	Revisions	Revised By
V0	May 14, 2019	Initial released Issue	Simple Guan

## 1. General Information

### 1.1. Description of Device (EUT)

EUT	: Remote Key
Model No.	: PRX-GPRS5, PRX-GPRS4
DIFF.	: There is no difference between all the models, except the appearance key and model numbers, this report performs the model PRX-GPRS5.
Trade mark	: N/A
Power supply	: DC 3V by button cell
Operation frequency	: 315MHz
Modulation	: ASK
Antenna Type	: Internal Antenna, Maximum Gain is 0dBi

## 1.2. Accessories of Device (EUT)

Accessories1 : /  
Manufacturer : /  
Model : /  
Power supply : /

## 1.3. Tested Supporting System Details

No.	Description	Manufacturer	Model	Serial Number	Certification or DOC
/	/	/	/	/	/

## 1.4. Test Facility

Shenzhen Alpha Product Testing Co., Ltd  
Building i, No.2, Lixin Road, Fuyong Street, Bao'an District, 518103,  
Shenzhen, Guangdong, China

June 21, 2018 File on Federal Communication Commission  
Registration Number: 293961  
July 25, 2017 Certificated by IC  
Registration Number: 12135A

## 2. Summary of test

### 2.1. Summary of test result

<b>Description of Test Item</b>	<b>Standard</b>	<b>Results</b>
Spurious Emission	Section 15.231&15.209	PASS
Conduction Emission	Section 15.207	N/A
Occupied bandwidth	Section 15.231	PASS
Transmission time	Section 15.231	PASS
Band Edge	Section 15.231	N/A
Antenna Requirement	Section 15.203	PASS
Note : Test according to ANSI C63.10-2013		

## 2.2. Block Diagram

- For radiated emissions test: EUT was placed on a turn table, which is 0.8 meters high above ground for below 1 GHz test and 1.5 meters high above ground for below 1 GHz test . EUT was set into test mode before test. New battery is used during all test



## 2.3. Test mode

EUT work in Continuous TX mode, and select test channel, wireless mode

Tested mode, channel, and data rate information		
Mode	Channel	Frequency (MHz)
ASK	CH1	315

## 2.4. Test Conditions

Temperature range	21-25°C
Humidity range	40-75%
Pressure range	86-106kPa

## 2.5. Measurement Uncertainty (95% confidence levels, k=2)

Item	Uncertainty
Uncertainty for Power point Conducted Emissions Test	2.74dB
Uncertainty for Radiation Emission test in 3m chamber (below 30MHz)	2.13 dB(Polarize: V)
	2.57dB(Polarize: H)
Uncertainty for Radiation Emission test in 3m chamber (30MHz to 1GHz)	3.77dB(Polarize: V)
	3.80dB(Polarize: H)
Uncertainty for Radiation Emission test in 3m chamber (1GHz to 25GHz)	4.16dB(Polarize: H)
	4.13dB(Polarize: V)
Uncertainty for radio frequency	$5.4 \times 10^{-8}$
Uncertainty for conducted RF Power	0.37dB
Uncertainty for temperature	0.2°C
Uncertainty for humidity	1%
Uncertainty for DC and low frequency voltages	0.06%



## 2.6. Test Equipment

Equipment	Manufacture	Model No.	Serial No.	Last cal.	Cal Interval
9*6*6 anechoic chamber	CHENYU	9*6*6	N/A	2018.09.21	1 Year
Spectrum analyzer	ROHDE&SCHWARZ	FSU	1166.1660.26	2018.09.21	1 Year
Receiver	ROHDE&SCHWARZ	ESR	1316.3003K03-10208 2-Wa	2018.09.21	1 Year
Receiver	R&S	ESCI	101165	2018.09.21	1 Year
Bilog Antenna	Schwarzbeck	VULB 9168	VULB9168-438	2018.04.13	2Year
Horn Antenna	SCHWARZBECK	BBHA 9120 D	BBHA 9120 D(1201)	2018.04.13	2Year
Active Loop Antenna	SCHWARZBECK	FMZB 1519B	00059	2018.09.26	2Year
Cable	Resenberger	N/A	No.1	2018.09.21	1 Year
Cable	Resenberger	N/A	No.2	2018.09.21	1 Year
Cable	Resenberger	N/A	No.3	2018.09.21	1 Year
Pre-amplifier	HP	HP8347A	2834A00455	2018.09.21	1 Year
Pre-amplifier	Agilent	8449B	3008A02664	2018.09.21	1 Year
20db Attenuator	ICPROBING	IATS1	82347	2018.09.21	1 Year
Horn Antenna	A-INFOMW	LB-180100-KF	J211020657	2018.09.21	2 Year
Preamplifier	SKET	LNPA_1840-50	SK2018101801	2018.09.21	1 Year
Power Meter	Agilent	E9300A	MY41496625	2018.09.21	1 Year
Temp. & Humid. Chamber	Weihuang	WHTH-1000-40-8 80	100631	2018.9.11	1 Year
Switching Mode Power Supply	JUNKE	JK12010S	20140927-6	2018.09.11	1 Year

### 3. Radiation Emission

#### 3.1. Radiation Emission Limits(15.209&231)

Frequency (MHz)	Field Strength Limits at 3 metres (watts, e.i.r.p.)		
	uV/m	dB uV/m	Measurement distance(m)
0.009-0.490	2400/F(kHz)	XX	300
0.490-1.705	24000/F(kHz)	XX	30
1.705-30	30	29.5	30
30~88	100(3nW)	40	3
88~216	150(6.8nW)	43.5	3
216~960	200(12nW)	46	3
Above960	500(75nW)	54	3
Fundamental frequency		75.6(AV) 95.6(PK)	3
spurious emissions frequencies		55.6(AV) 75.6(PK)	3

**NOTE:**

- a) The tighter limit applies at the band edges.
- b) Emission Level(dB uV/m)=20log Emission Level(Uv/m)

#### 3.2. Test Setup

See the next page.

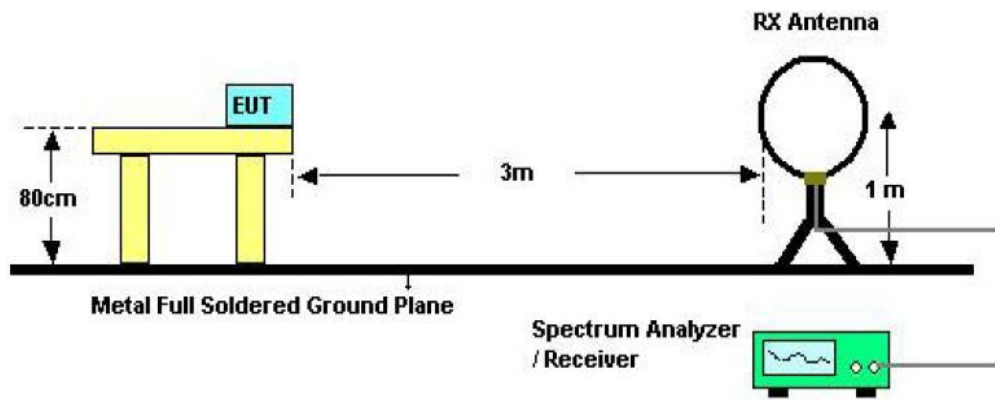

Below 30MHz Test Setup

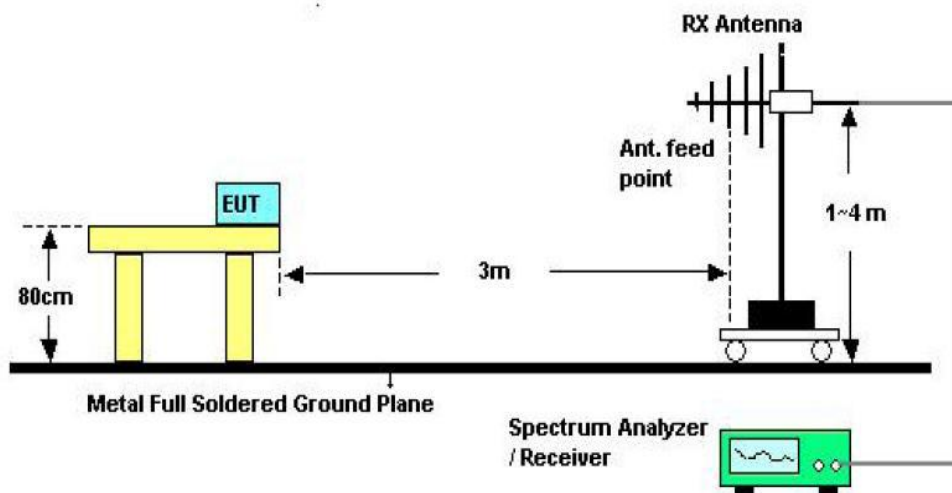

Above 30MHz Test Setup

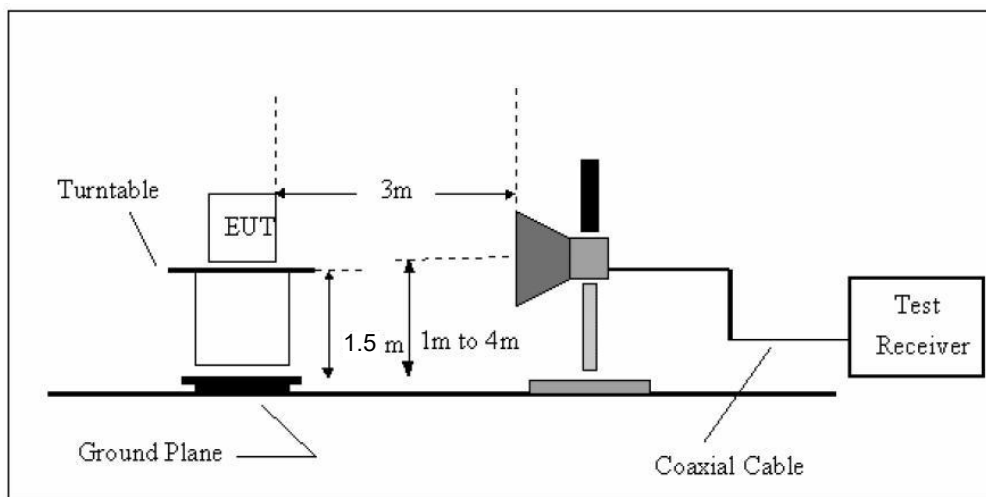

Above 1GHz Test Setup

### 3.3. Test Procedure

- a) The measuring distance of 3m shall be used for measurements at frequency up to 1GHz and above 1GHz, The EUT was placed on a rotating 0.8 m high above ground, The table was rotated 360 degrees to determine the position of the highest radiation
- b) The Test antenna shall vary between 1m and 4m, Both Horizontal and Vertical antenna are set to make measurement.
- c) The initial step in collecting conducted emission data is a spectrum analyzer Peak detector mode pre-scanning the measurement frequency range. Significant Peaks are then marked. and then Quasi Peak Detector mode re-measured
- d) If Peak value comply with QP limit Below 1GHz. The EUT deemed to comply with QP limit. But the Peak value and average value both need to comply with applicable limit above 1GHz.
- e) For the actual test configuration, please see the test setup photo.

### 3.4. Test Equipment Setting For emission test.

9KHz~150KHz	RBW 200Hz	VBW 1KHz
150KHz~30MHz	RBW 9KHz	VBW 30KHz
30MHz~1GHz	RBW 120KHz	VBW 300KHz
Above 1GHz	RBW 1MHz	VBW 3MHz

### 3.5. Test Condition

Continual Transmitting in maximum power (The new battery be used during Test)

### 3.6. Test Result

We have scanned the 10th harmonic from 9KHz to the EUT.  
Detailed information please see the following page.

From 9KHz to 30MHz: Conclusion: PASS

Note: The amplitude of spurious emissions which are attenuated by more than 20dB below the permissible value has no need to be reported.

**Notes:** 1 --Means other frequency and mode comply with standard requirements and at least have 20dB margin.

Correct Factor=Cable Loss+Antenna Factor-Amplifier Gain

Measurement Result=Reading + Correct Factor

Margin=Measurement Result-Limit

2 –Spectrum setting:

a. Peak setting 30MHz-1GHz, RBW=100KHz, VBW=300KHz.

3- PK measure result values is less than the AVG limit values, so AV measure result values test not applicable.

## Radiated Emissions Result of Inside band

### Below 1GHz

<b>EUT Description</b>	Remote Key	<b>Model No.</b>	PRX-GPRS5
<b>Temperature</b>	24°C	<b>Humidity</b>	56%
<b>Pol</b>	Vertical	<b>Distance</b>	3M
<b>Test Voltage</b>	DC 3V by button cell	<b>Test date</b>	May 13, 2019
<b>Test mode</b>	TX 315MHz		

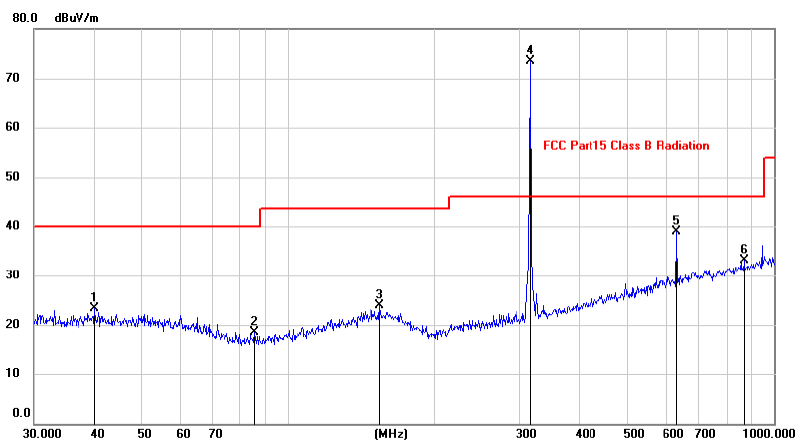

No.	Mk.	Freq.	Reading	Correct	Measure-	Limit	Margin	Antenna	Table
		MHz	dBuV	Factor	ment	dBuV/m	dB	Height	Degree
				dB	dBuV/m	dBuV/m		cm	degree
1		39.9942	9.01	14.24	23.25	40.00	-16.75	peak	
2		85.5976	8.83	9.69	18.52	40.00	-21.48	peak	
3		154.2786	9.33	14.56	23.89	43.50	-19.61	peak	
4	*	315.0000	59.69	13.79	73.48	46.00	27.48	peak	
5		630.0000	19.05	19.85	38.90	46.00	-7.10	peak	
6		869.1302	10.40	22.69	33.09	46.00	-12.91	peak	

No.	Frequency (MHz)	Reading (dBuV)	Factor (dB)	Results (dBuV/m)	Limit (dBuV/m)	Margin (dB)	Detector
1	315	59.69	13.79	73.48	95.6	-22.12	PK
2	315	/	/	/	75.6	/	AV
3	630	19.05	19.85	38.90	75.6	-36.70	PK
4	630	/	/	/	55.6	/	AV

Note:

- When the PK measure result value is less than the AVG limit value, the AV measure result values test not applicable.
- Margin = Result (Result =Reading + Factor )-Limit

<b>Pol</b>	<b>Horizontal</b>	<b>Test date</b>	May 13, 2019
------------	-------------------	------------------	--------------

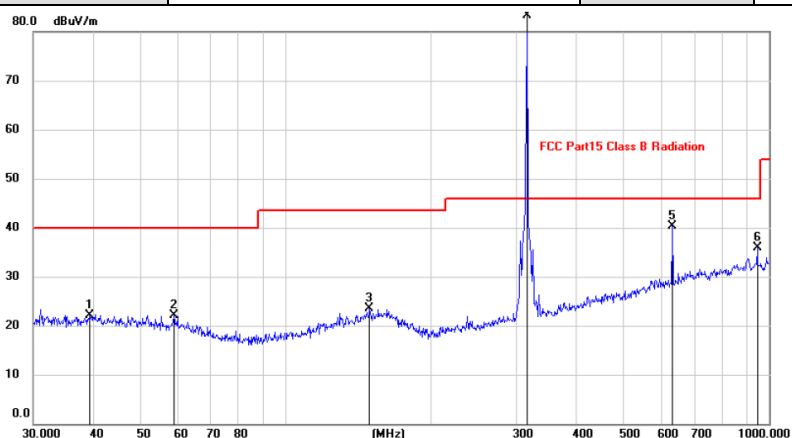

No. Mk.	Freq.	Reading Level	Correct Factor	Measurement	Limit	Margin	Antenna Height	Table Degree
	MHz	dBuV	dB	dBuV/m	dBuV/m	dB	cm	degree
1	39.2991	7.97	14.21	22.18	40.00	-17.82	peak	
2	58.6126	8.91	13.10	22.01	40.00	-17.99	peak	
3	148.9625	8.98	14.47	23.45	43.50	-20.05	peak	
4 *	315.0000	69.76	13.79	83.55	46.00	37.55	peak	
5	630.0000	20.37	19.85	40.22	46.00	-5.78	peak	
6	945.0000	12.58	23.30	35.88	46.00	-10.12	peak	

No.	Frequency (MHz)	Reading (dBuV)	Factor (dB)	Results (dBuV/m)	Limit (dBuV/m)	Margin (dB)	Detector
1	315	69.76	13.79	83.55	95.6	-12.05	PK
2	315	/	/	70.33	75.6	-5.27	AV
3	630	20.37	19.85	40.22	75.6	-35.38	PK
4	630	/	/	/	55.6	/	AV

**Note:**

- Spurious Emission AVG value= Peak Value - 20\*LOG(1/Duty cycle) =83.55-20\*LOG(1/0.2185) =70.33dBuV/m<75.6dBuV/m
- When the PK measure result value is less than the AVG limit value, the AV measure result values test not applicable.
- Margin = Result (Result =Reading + Factor )-Limit

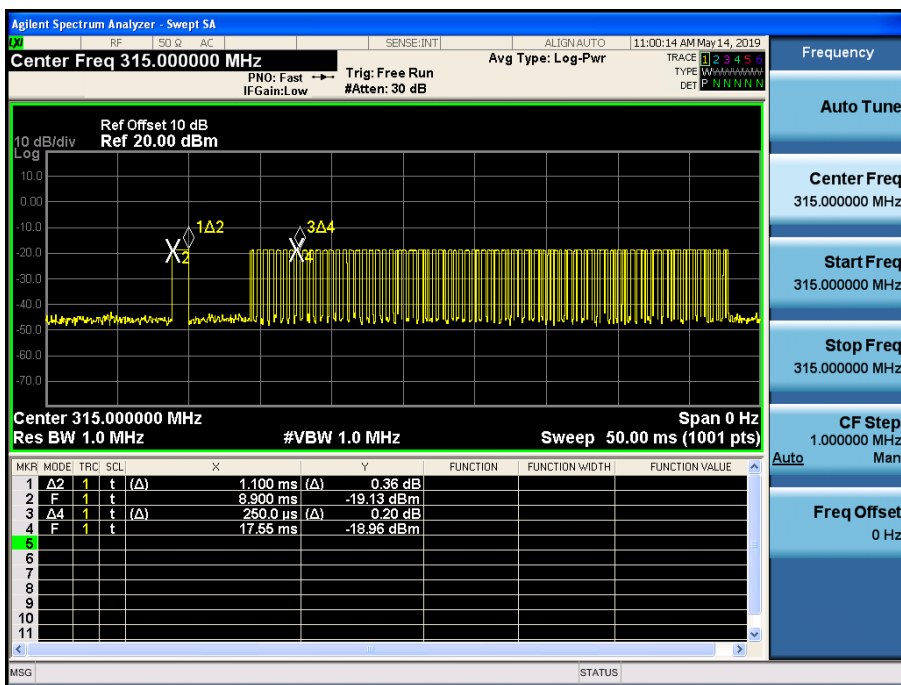
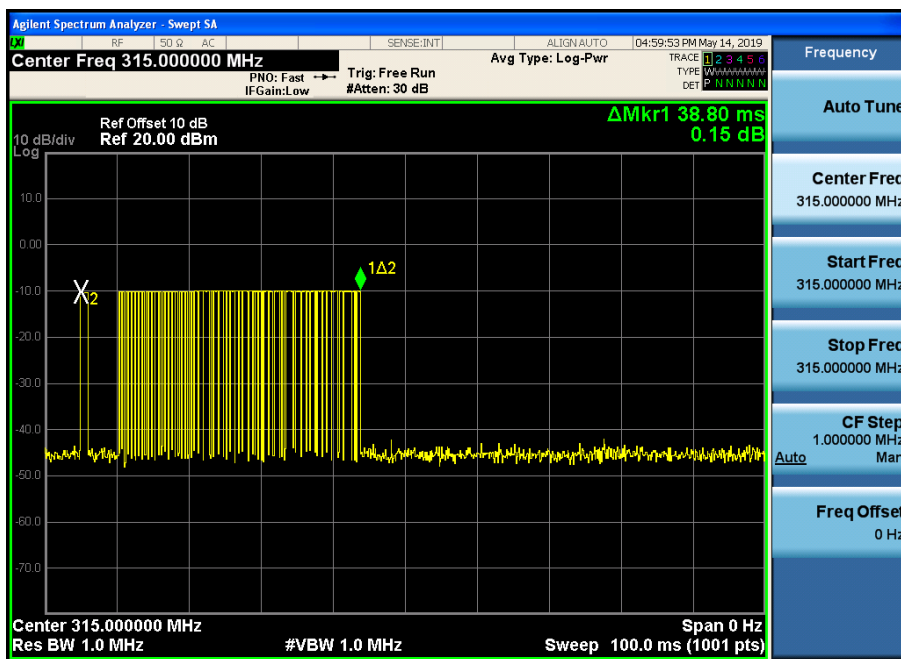

Ton = 1.1 + 0.25 \* 83 = 21.85  
 Duty Cycle = 21.85 / 100 = 0.2185



Above 1GHz

<b>EUT Description</b>	Remote Key	<b>Model No.</b>	PRX-GPRS5
<b>Temperature</b>	24°C	<b>Humidity</b>	56%
<b>Pol</b>	Vertical	<b>Distance</b>	3M
<b>Test Voltage</b>	DC 3V by button cell	<b>Test date</b>	May 13, 2019
<b>Test mode</b>	TX 315MHz		

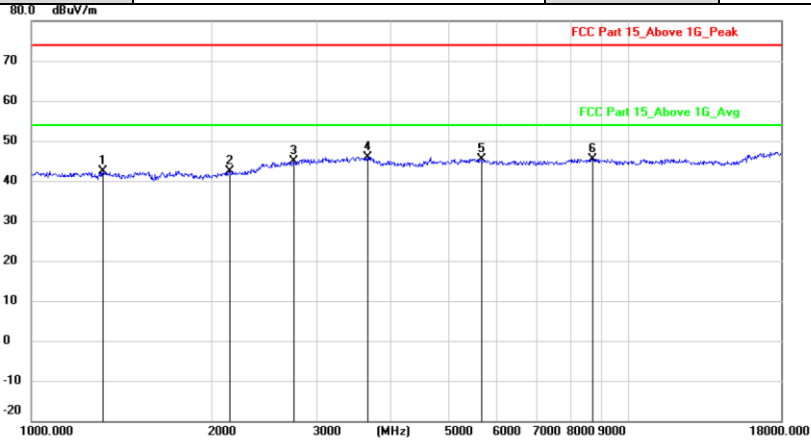

No.	Mk.	Freq.	Reading Level	Correct Factor	Measurement	Limit	Margin	Antenna Height	Table Degree	
		MHz	dBuV	dB	dBuV/m	dBuV/m	dB	cm	degree	Comment
1		1315.985	49.54	-7.27	42.27	74.00	-31.73			peak
2		2144.825	46.08	-3.77	42.31	74.00	-31.69			peak
3		2750.080	47.80	-2.86	44.94	74.00	-29.06			peak
4	*	3650.582	52.01	-6.01	46.00	74.00	-28.00			peak
5		5664.525	46.90	-1.41	45.49	74.00	-28.51			peak
6		8688.481	41.60	3.89	45.49	74.00	-28.51			peak

<b>Pol</b>	Horizontal	<b>Test date</b>	May 13, 2019
------------	------------	------------------	--------------

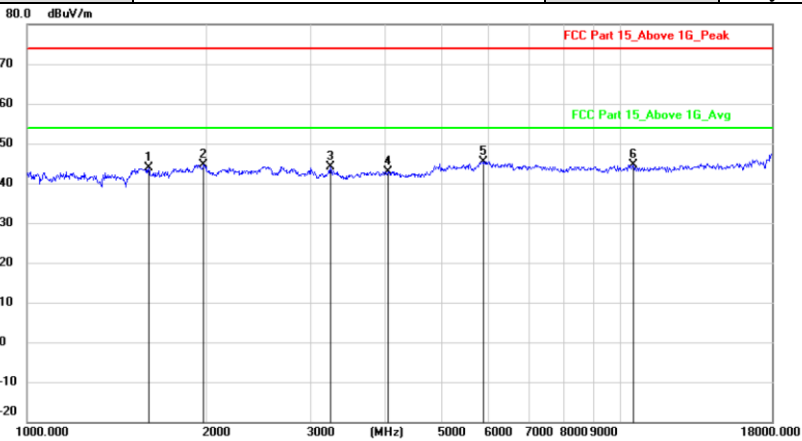

No.	Mk.	Freq.	Reading Level	Correct Factor	Measurement	Limit	Margin	Antenna Height	Table Degree	
		MHz	dBuV	dB	dBuV/m	dBuV/m	dB	cm	degree	Comment
1		1601.804	50.64	-6.83	43.81	74.00	-30.19			peak
2		1983.808	50.25	-5.53	44.72	74.00	-29.28			peak
3		3242.619	46.51	-2.28	44.23	74.00	-29.77			peak
4		4062.629	47.88	-4.91	42.97	74.00	-31.03			peak
5	*	5864.443	46.58	-1.13	45.45	74.00	-28.55			peak
6		10514.57	39.42	5.20	44.62	74.00	-29.38			peak

## 4. Power Line Conducted Emission

### 4.1. Conducted Emission Limits (15.207)

Frequency MHz	Limits dB( $\mu$ V)	
	Quasi-peak Level	Average Level
0.15 -0.50	66 -56*	56 - 46*
0.50 -5.00	56	46
5.00 -30.00	60	50

Notes: 1. \*Decreasing linearly with logarithm of frequency.

2. The lower limit shall apply at the transition frequencies.

3. The limit decreases in line with the logarithm of the frequency in the rang of 0.15 to 0.50 MHz.

### 4.2. Test Setup

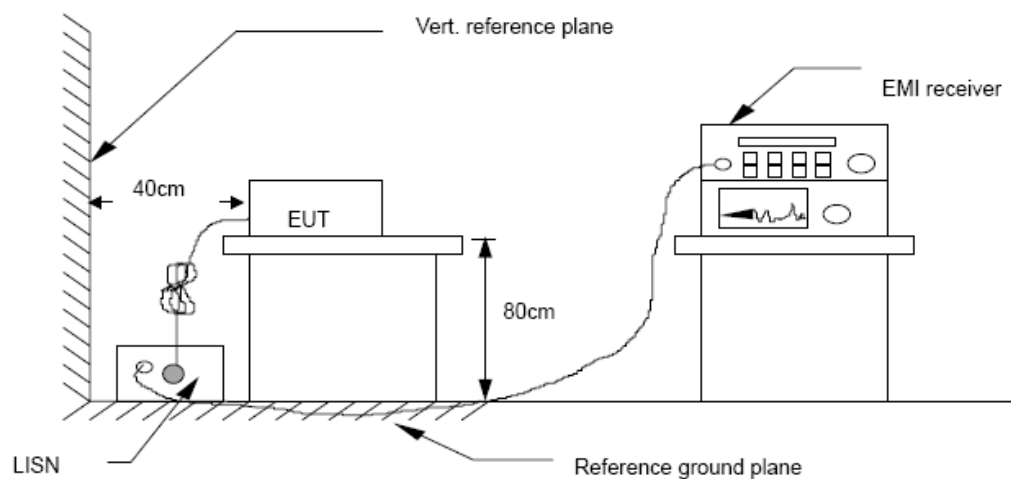

### 4.3. Test Procedure

The EUT is put on the plane 0.8m high above the ground by insulating support and is connected to the power mains through a line impedance stabilization network (L.I.S.N.). This provides a 50ohm coupling impedance for the EUT system. Please refer the block diagram of the test setup and photographs. Both sides of AC lines are checked to find out the maximum conducted emission. In order to find the maximum emission levels, the relative positions of equipment and all of the interface cables shall be changed according to ANSI C63.10:2013 on Conducted Emission Measurement.

The bandwidth of test receiver (R & S ESCI) is set at 9 kHz.

### 4.4. Test Results

EUT power supply by battery, so the test not applicable.

## 5. Occupied bandwidth

### 5.1. Test limit

Please refer section RSS-210 & 15.231

According to §15.231(C), The bandwidth of the emission shall be no wider than 0.25% of the center frequency for devices operating above 70MHz and below 900MHz.

### 5.2. Method of measurement

a)The bandwidth is measured at an amplitude level reduced 20dB from the reference level. The reference level is the level of the highest amplitude signal observed from the transmitter at the fundamental frequency. Once the reference level is established, the equipment is conditioned with typical modulating signal to produce the worst-case (i.e. the widest) bandwidth.

b)The test receiver RBW set 30KHz,VBW set 30KHz,Sweep time set auto.

### 5.3. Test Setup

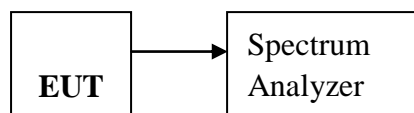

### 5.4. Test Results

Mode	Freq (MHz)	20dB Bandwidth (KHz)	99% Bandwidth	Limit (kHz)	Conclusion
ASK	315	138.2	/	787.5	PASS

Note: Limit = 315MHz \*0.25% = 787.5 kHz

315MHz

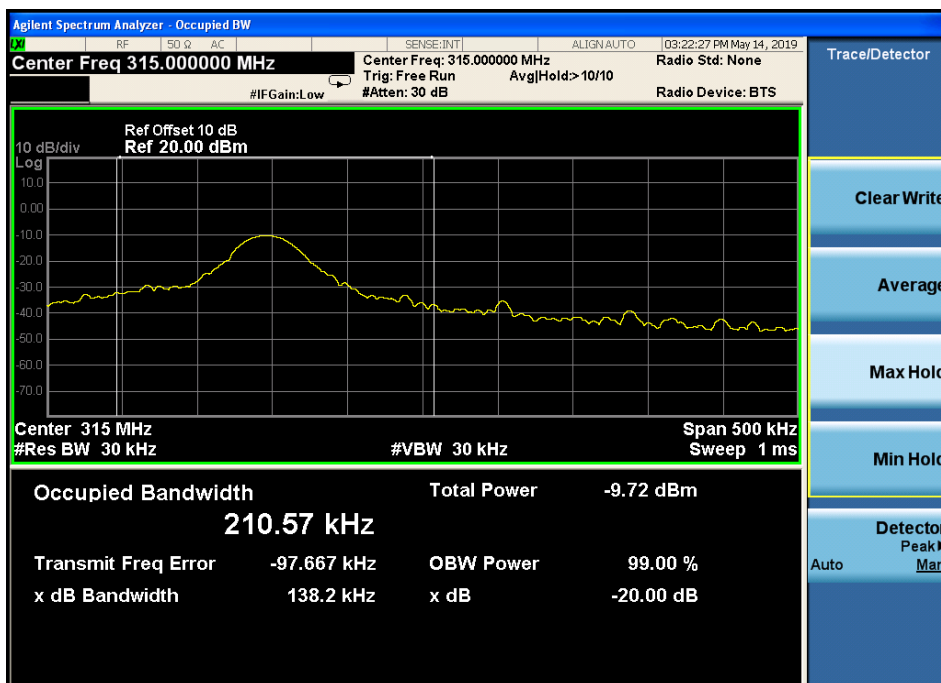

## 6. Transmission time

### 6.1. Test limit

Please refer section RSS-210 & 15.231

According to §15.231(a)(1), A manually operated transmitter shall employ a switch that will automatically deactivate the transmitter within not more than 5 seconds of being released.

### 6.2. Method of measurement

6.2.1. Place the EUT on the table and set it in transmitting mode.

6.2.2. Remove the antenna from the EUT and then connect a low loss RF cable from the antenna port to the spectrum analyzer.

6.2.3. Set spectrum analyzer Center= 315MHz, Span = 0MHz, Sweep = 5s.

6.2.4. Set the spectrum analyzer as RBW, VBW=1MHz,

6.2.5. Max hold, view and count how many channel in the band.

### 6.3. Test Setup



### 6.4. Test Results

Freq (MHz)	Test Result(s)	Limit (s)	Conclusion
315	0.520	< 5s	PASS

EUT After Release the button, EUT emission Continue 0.52 seconds, Compliance with 15.231 a(1) section.

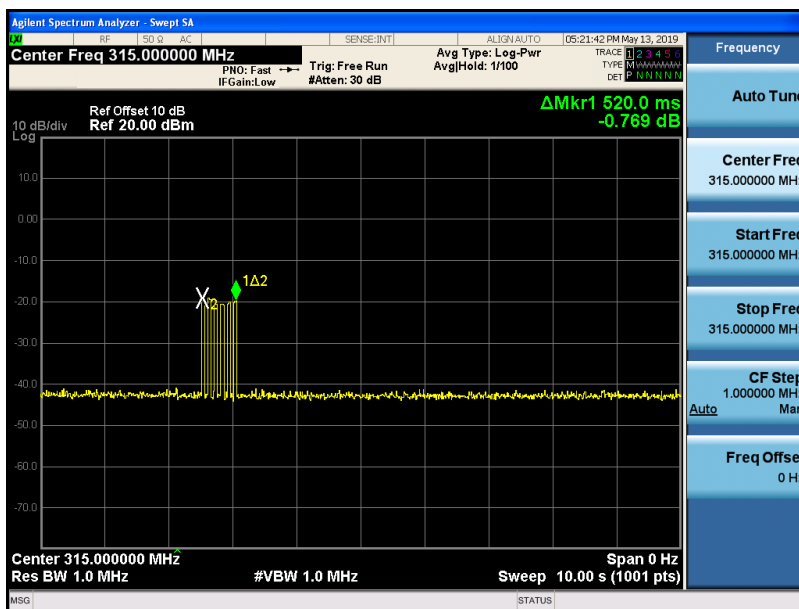

## **7. Antenna Requirement**

### **7.1. Standard Requirement**

An intentional radiator shall be designed to ensure that no antenna other than that furnished by the responsible party shall be used with the device. The use of a permanently attached antenna or of an antenna that uses a unique coupling to the intentional radiator shall be considered sufficient to comply with the provisions of this Section. The manufacturer may design the unit so that a broken antenna can be replaced by the user, but the use of a standard antenna jack or electrical connector is prohibited.

### **7.2. Antenna Connected Construction**

The directional gains of antenna used for transmitting is 0 dBi, and the antenna connector is designed with permanent attachment and no consideration of replacement. Please see EUT photo for details.

### **7.3. Result**

The EUT antenna is Internal antenna. It comply with the standard requirement.



## 8. Test setup photo

Photos of Radiated emission

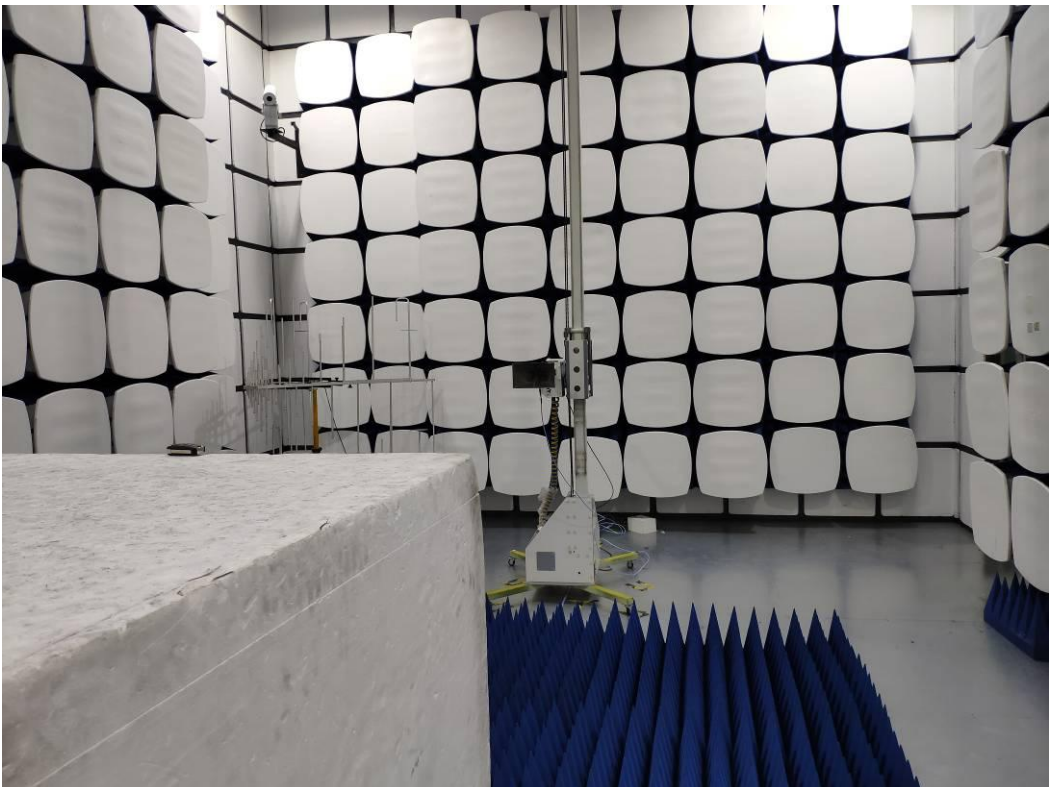
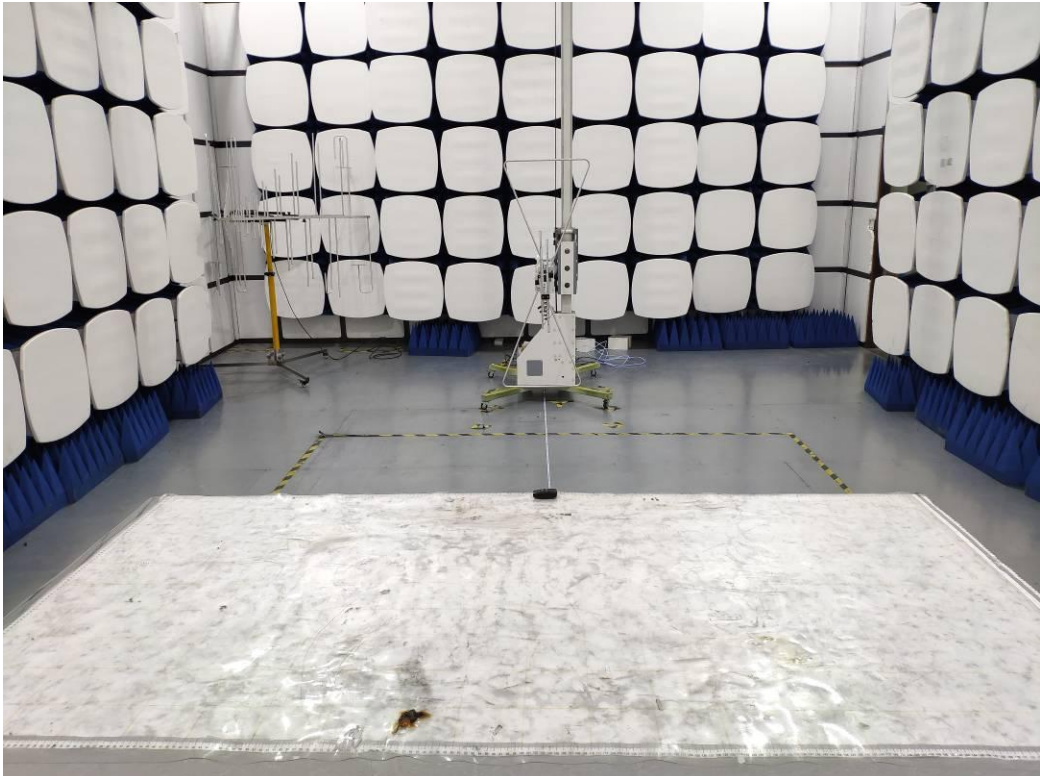

### 9. Photos of EUT

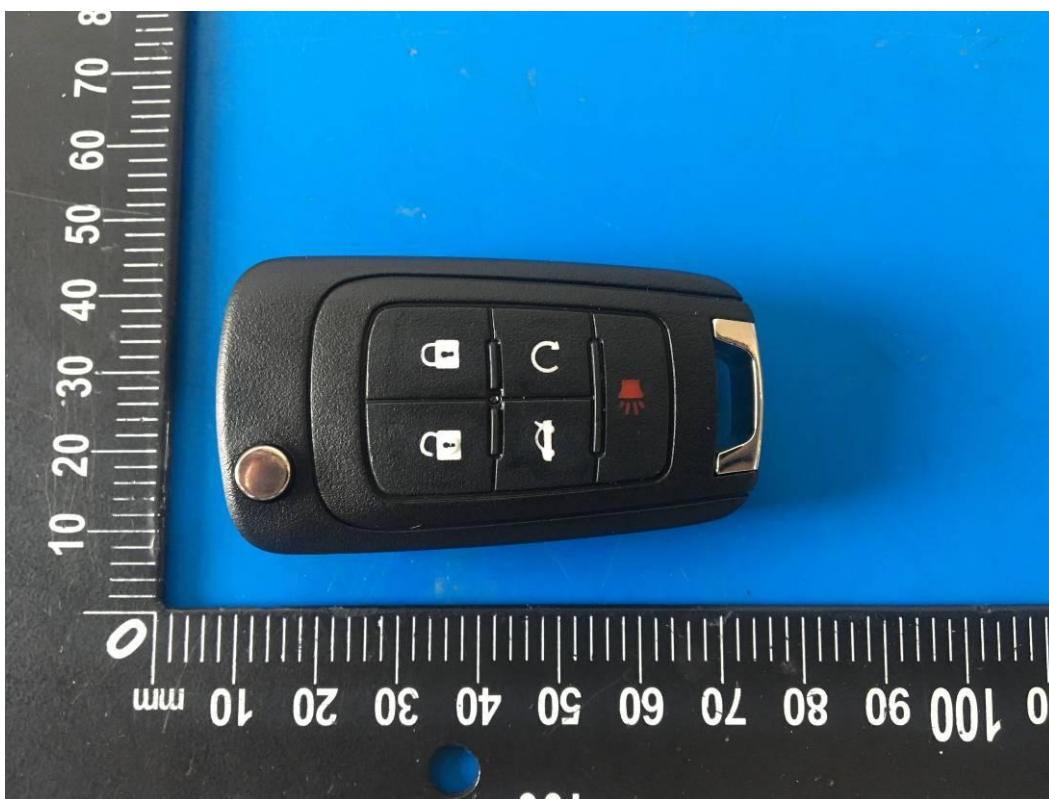







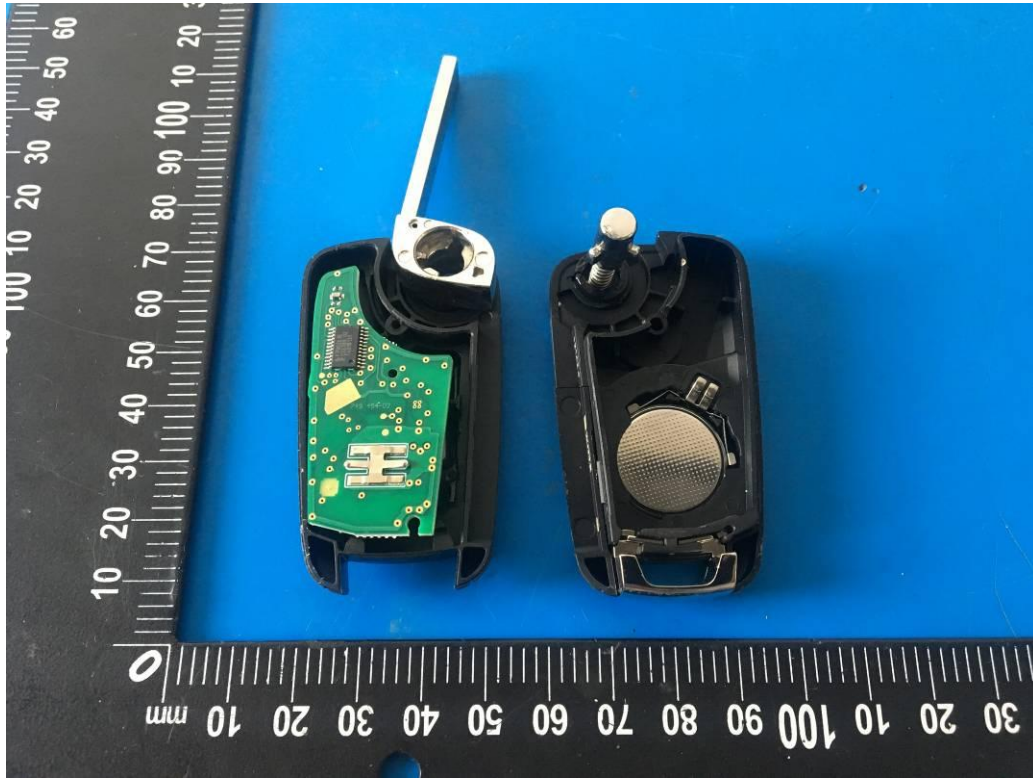

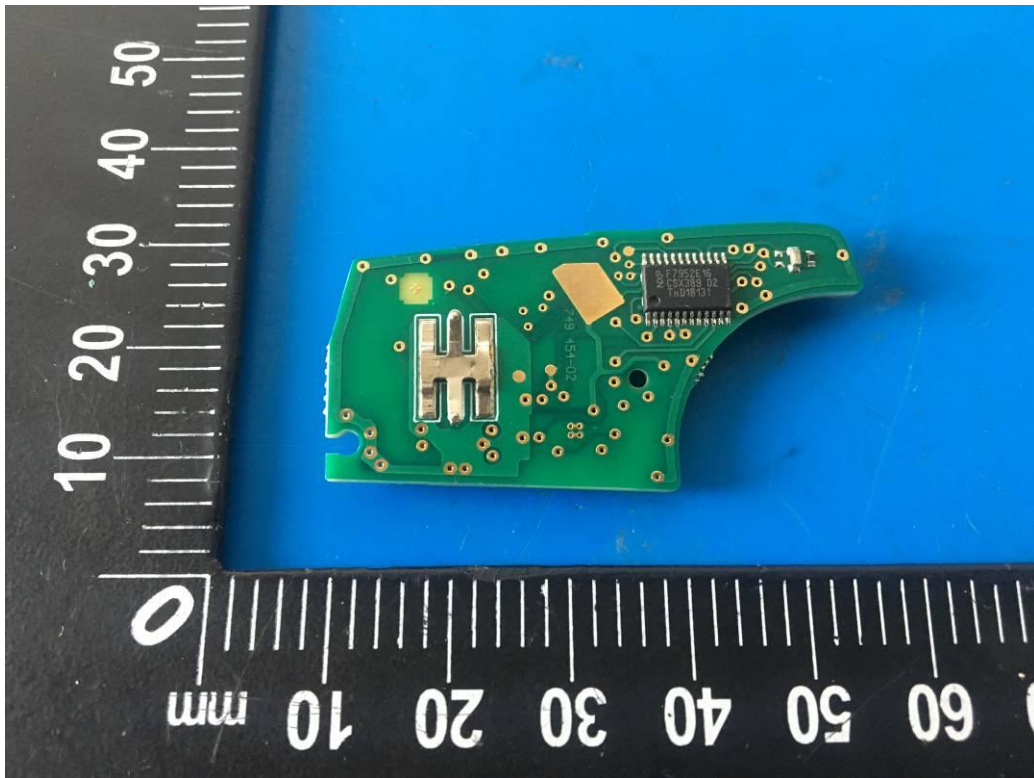
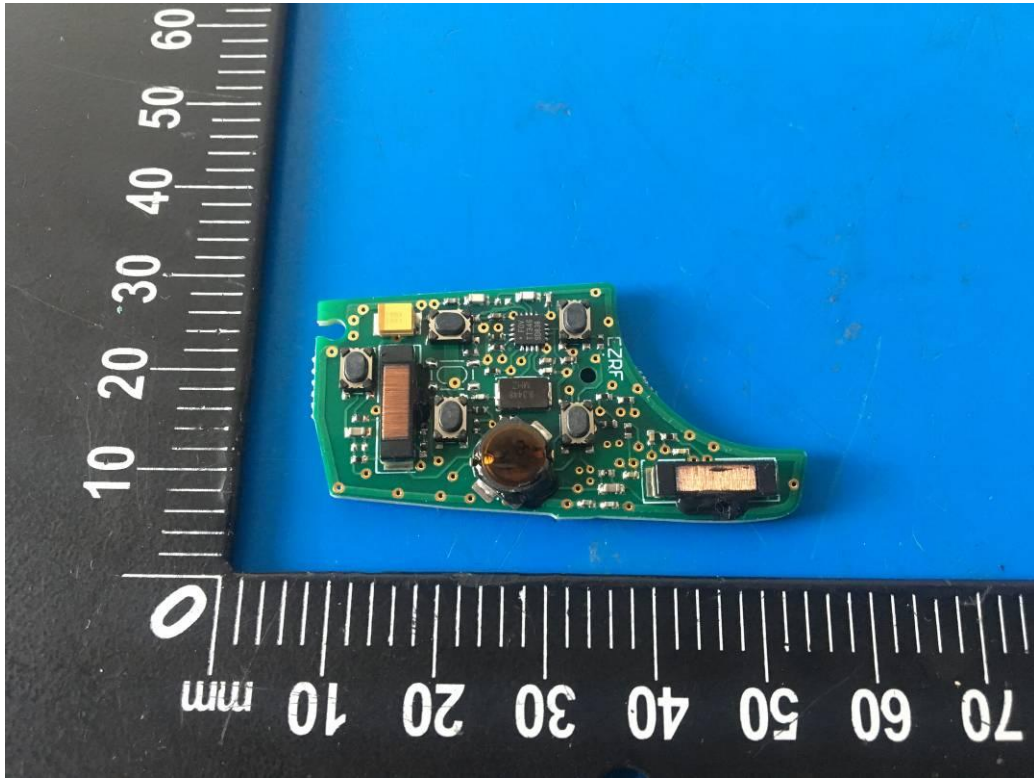

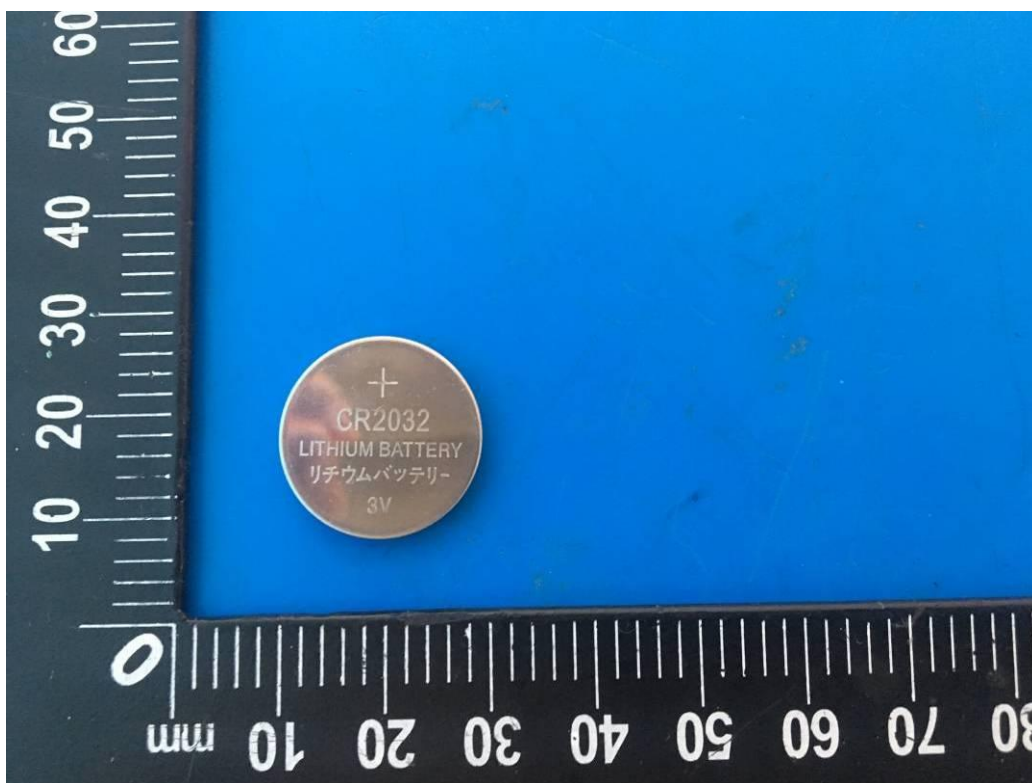

-----END OF THE REPORT-----