



FCC TEST REPORT

FCC ID: 2AOKM-G4AAC

On Behalf of

Remote Tech LLC

Remote Key

**Model No.: RT-G4AACV5T, RT-G4AACV3, RT-G4AACV5H,
RT-G4AACV4**

Prepared for : Remote Tech LLC
Address : 310 ALDER RD, Dover, DE 19904, USA

Prepared By : Shenzhen Alpha Product Testing Co., Ltd.
Address : Building i, No.2, Lixin Road, Fuyong Street, Bao'an District, 518103,
Shenzhen, Guangdong, China

Report Number : A1911062-C01-R11
Date of Receipt : November 27, 2019
Date of Test : November 27-December 11, 2019
Date of Report : December 11, 2019
Version Number : V0

Contents

1. General Information.....	5
1.1. Description of Device (EUT).....	5
1.2. Accessories of Device (EUT).....	6
1.3. Tested Supporting System Details	6
1.4. Test Facility	6
2. Summary of test	7
2.1. Summary of test result	7
2.2. Block Diagram	7
2.3. Test mode	8
2.4. Test Conditions.....	8
2.5. Measurement Uncertainty (95% confidence levels, k=2)	8
2.6. Test Equipment.....	9
3. Radiation Emission	10
3.1. Radiation Emission Limits(15.209&231)	10
3.2. Test Setup	10
3.3. Test Procedure	11
3.4. Test Equipment Setting For emission test.....	12
3.5. Test Condition	12
3.6. Test Result.....	12
4. POWER LINE CONDUCTED EMISSION	17
4.1. Conducted Emission Limits (15.209)	17
4.2. Test Setup	17
4.3. Test Procedure	17
4.4. Test Results	18
5. Occupied bandwidth.....	19
5.1. Test limit.....	19
5.2. Method of measurement.....	19
5.3. Test Setup	19
5.4. Test Results	19
6. Transmission time.....	21
6.1. Test limit.....	21
6.2. Method of measurement.....	21
6.3. Test Setup	21
6.4. Test Results	21
7. Antenna Requirement	23
7.1. Standard Requirement	23
7.2. Antenna Connected Construction	23
7.3. Result.....	23
8. Test setup photo	24
9. Photos of EUT	25

TEST REPORT DECLARATION

Applicant : Remote Tech LLC
 Address : 310 ALDER RD, Dover, DE 19904, USA
 Manufacturer : Remote Tech LLC
 Address : 310 ALDER RD, Dover, DE 19904, USA
 EUT Description : Remote Key
 (A) Model No. : RT-G4AACV5T, RT-G4AACV3, RT-G4AACV5H,
 RT-G4AACV4
 (B) Trademark : N/A

Measurement Standard Used:

FCC Rules and Regulations Part 15 Subpart C Section 15.231
ANSI C63.10-2013

The device described above is tested by Shenzhen Alpha Product Testing Co., Ltd. to determine the maximum emission levels emanating from the device. The maximum emission levels are compared to the FCC Part 15 Subpart C limits both conducted and radiated emissions. The test results are contained in this test report and Shenzhen Alpha Product Testing Co., Ltd. is assumed of full responsibility for the accuracy and completeness of these tests.

After the test, our opinion is that EUT compliance with the requirement of the above standards.

This report applies to above tested sample only. This report shall not be reproduced in parts without written approval of Shenzhen Alpha Product Testing Co., Ltd.

Tested by (name + signature).....: Lucas Pang
 Project Engineer



Approved by (name + signature).....: Simple Guan
 Project Manager



Date of issue..... : December 11, 2019

Revision History

Revision	Issue Date	Revisions	Revised By
V0	December 11, 2019	Initial released Issue	Simple Guan

1. General Information

1.1. Description of Device (EUT)

EUT	: Remote Key
Model No.	: RT-G4AACV5T, RT-G4AACV3, RT-G4AACV5H, RT-G4AACV4 All model's the software and electric circuit are the same, but the
DIFF.	: number of button is different. So all the test were performed on the model RT-G4AACV5T.
Power supply	: DC 3V by button cell
Operation frequency	: 314.9MHz
Modulation	: ASK
Antenna Type	: Internal Antenna, Maximum Gain is 0dBi

1.2. Accessories of Device (EUT)

Accessories1 : /
Manufacturer : /
Model : /
Power supply : /

1.3. Tested Supporting System Details

No.	Description	Manufacturer	Model	Serial Number	Certification or DOC
/	/	/	/	/	/

1.4. Test Facility

Shenzhen Alpha Product Testing Co., Ltd
Building i, No.2, Lixin Road, Fuyong Street, Bao'an District, 518103,
Shenzhen, Guangdong, China

June 21, 2018 File on Federal Communication Commission
Registration Number: 293961
July 15, 2019 Certificated by IC
Registration Number: CN0085

2. Summary of test

2.1. Summary of test result

Description of Test Item	Standard	Results
Spurious Emission	Section 15.231&15.209	PASS
Conduction Emission	Section 15.207	N/A
Occupied bandwidth	Section 15.231	PASS
Transmission time	Section 15.231	PASS
Band Edge	Section 15.231	N/A
Antenna Requirement	Section 15.203	PASS

Note : Test according to ANSI C63.10-2013

2.2. Block Diagram

1. For radiated emissions test: EUT was placed on a turn table, which is 0.8 meters high above ground for below 1 GHz test and 1.5 meters high above ground for below 1 GHz test. EUT was set into test mode before test. New battery is used during all test

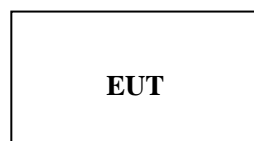

2.3. Test mode

EUT work in Continuous TX mode, and select test channel, wireless mode

Tested mode, channel, and data rate information		
Mode	Channel	Frequency (MHz)
1	CH1	314.9MHz

2.4. Test Conditions

Temperature range	21-25°C
Humidity range	40-75%
Pressure range	86-106kPa

2.5. Measurement Uncertainty (95% confidence levels, k=2)

Item	Uncertainty
Uncertainty for Power point Conducted Emissions Test	2.74dB
Uncertainty for Radiation Emission test in 3m chamber (below 30MHz)	2.13 dB(Polarize: V)
	2.57dB(Polarize: H)
Uncertainty for Radiation Emission test in 3m chamber (30MHz to 1GHz)	3.77dB(Polarize: V)
	3.80dB(Polarize: H)
Uncertainty for Radiation Emission test in 3m chamber (1GHz to 25GHz)	4.13dB(Polarize: H)
	4.16dB(Polarize: V)
Uncertainty for radio frequency	5.4×10^{-8}
Uncertainty for conducted RF Power	0.37dB
Uncertainty for temperature	0.2°C
Uncertainty for humidity	1%
Uncertainty for DC and low frequency voltages	0.06%

2.6. Test Equipment

Equipment	Manufacture	Model No.	Serial No.	Last cal.	Cal Interval
9*6*6 anechoic chamber	CHENYU	9*6*6	N/A	2019.09.06	3Year
Spectrum analyzer	ROHDE&SCHWARZ	FSV40-N	102137	2019.09.05	1 Year
Spectrum analyzer	Agilent	N9020A	MY499100060	2019.09.05	1 Year
Receiver	ROHDE&SCHWARZ	ESR	1316.3003K03-10208 2-Wa	2019.09.06	1 Year
Receiver	R&S	ESCI	101165	2019.09.05	1 Year
Bilog Antenna	Schwarzbeck	VULB 9168	VULB9168-438	2018.04.13	2Year
Horn Antenna	SCHWARZBECK	BBHA 9120 D	BBHA 9120 D(1201)	2018.04.13	2Year
Active Loop Antenna	SCHWARZBECK	FMZB 1519B	00059	2019.09.07	2Year
Cable	Resenberger	N/A	No.1	2019.09.05	1 Year
Cable	Resenberger	N/A	No.2	2019.09.05	1 Year
Cable	Resenberger	N/A	No.3	2019.09.05	1 Year
Pre-amplifier	HP	HP8347A	2834A00455	2019.09.05	1 Year
Pre-amplifier	Agilent	8449B	3008A02664	2019.09.05	1 Year
L.I.S.N.#1	Schwarzbeck	NSLK8126	8126466	2019.09.05	1 Year
L.I.S.N.#2	ROHDE&SCHWARZ	ENV216	101043	2019.09.05	1 Year
20db Attenuator	ICPROBING	IATS1	82347	2019.08.26	1 Year
Horn Antenna	SCHWARZBECK	BBHA9170	00946	2019.09.07	2 Year
Preamplifier	SKET	LNPA_1840-50	SK2018101801	2019.09.06	1 Year
Power Meter	Agilent	E9300A	MY41496625	2019.09.06	1 Year
Temp. & Humid. Chamber	Weihuang	WHTH-1000-40-8 80	100631	2019.09.06	1 Year
Switching Mode Power Supply	JUNKE	JK12010S	20140927-6	2019.09.05	1 Year

3. Radiation Emission

3.1. Radiation Emission Limits(15.209&231)

Frequency (MHz)	Field Strength Limits at 3 metres (watts, e.i.r.p.)		
	uV/m	dB uV/m	Measurement distance(m)
0.009-0.490	2400/F(kHz)	XX	300
0.490-1.705	24000/F(kHz)	XX	30
1.705-30	30	29.5	30
30~88	100(3nW)	40	3
88~216	150(6.8nW)	43.5	3
216~960	200(12nW)	46	3
Above960	500(75nW)	54	3
Carrier frequency		75.6(AV)	3
Carrier frequency		95.6(PK)	3

NOTE:

- The tighter limit applies at the band edges.
- Emission Level(dB uV/m)=20log Emission Level(Uv/m)

3.2. Test Setup

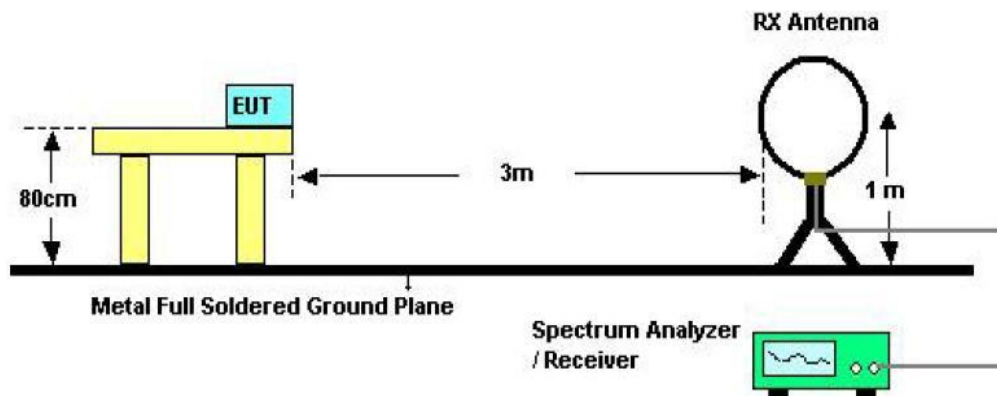

Below 30MHz Test Setup

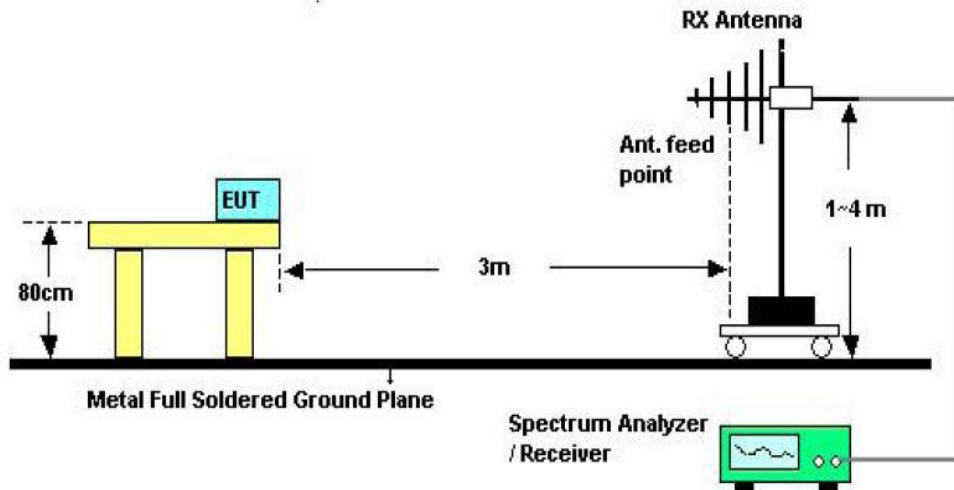

Above 30MHz Test Setup

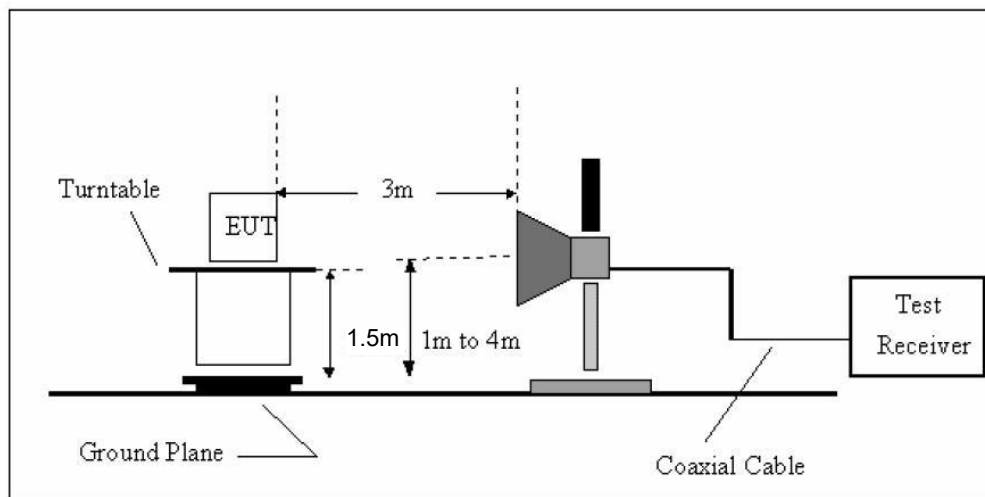

Above 1GHz Test Setup

3.3. Test Procedure

- a) The measuring distance of 3m shall be used for measurements at frequency up to 1GHz and above 1GHz, The EUT was placed on a rotating 0.8 m high above ground, The table was rotated 360 degrees to determine the position of the highest radiation
- b) The Test antenna shall vary between 1m and 4m, Both Horizontal and Vertical antenna are set to make measurement.
- c) The initial step in collecting conducted emission data is a spectrum analyzer Peak detector mode pre-scanning the measurement frequency range. Significant Peaks are then marked. and then Quasi Peak Detector mode remeasured
- d) If Peak value comply with QP limit below 1GHz. The EUT deemed to comply with QP limit. But the Peak value and average value both need to comply with applicable limit above 1GHz.
- e) For the actual test configuration, please see the test setup photo.

3.4. Test Equipment Setting For emission test.

9kHz~150kHz	RBW 200Hz	VBW 1kHz
150kHz~30MHz	RBW 9kHz	VBW 30kHz
30MHz~1GHz	RBW 120kHz	VBW 300kHz
Above 1GHz	RBW 1MHz	VBW 3MHz

3.5. Test Condition

Continual Transmitting in maximum power(The new battery be used during Test)

3.6. Test Result

We have scanned the 10th harmonic from 9KHz to the EUT.
Detailed information please see the following page.

From 9KHz to 30MHz: Conclusion: PASS

Note: The amplitude of spurious emissions which are attenuated by more than 20dB below the permissible value has no need to be reported.

Notes: 1 --Means other frequency and mode comply with standard requirements and at least have 20dB margin.

Correct Factor=Cable Loss+Antenna Factor-Amplifier Gain

Measurement Result=Reading + Correct Factor

Margin=Measurement Result-Limit

2 –Spectrum setting:

a. Peak setting 30MHz-1GHz, RBW=100kHz, VBW=300kHz.

3- PK measure result values is less than the AVG limit values, so AV measure result values test not applicable.

Radiated Emissions Result of Inside band
Below 1GHz:

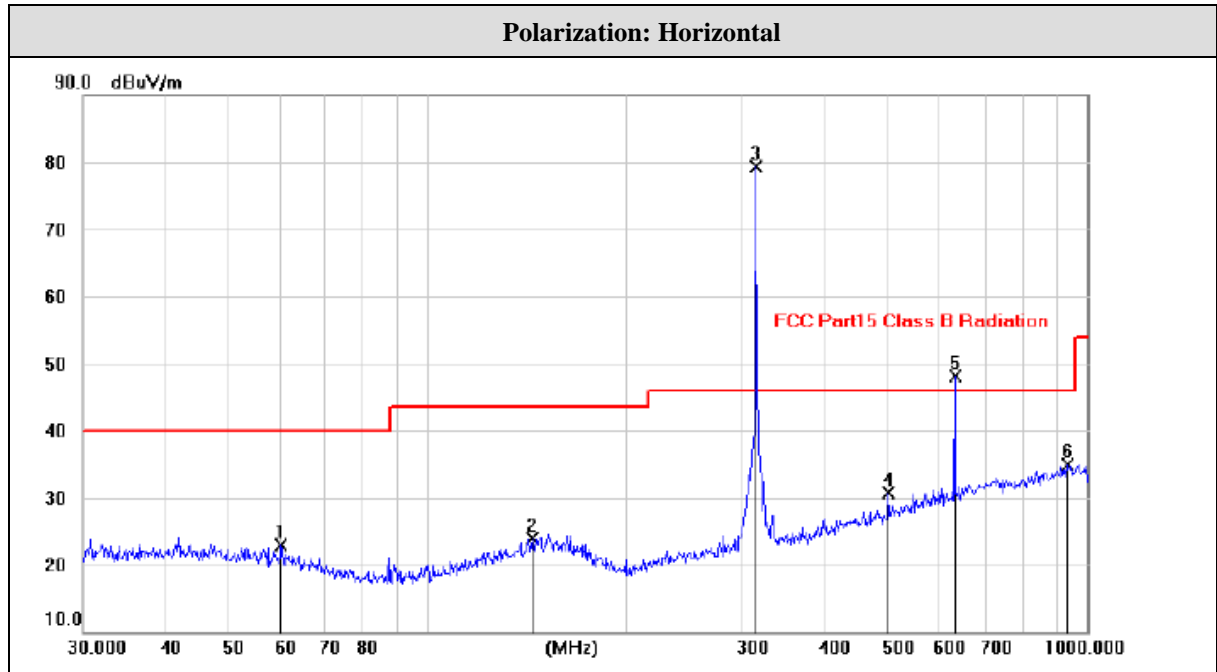

No.	Mk.	Freq.	Reading Level	Correct Factor	Measurement	Limit	Margin	Antenna Height	Table Degree
		MHz	dBuV	dB	dBuV/m	dBuV/m	dB	cm	degree
1		59.9008	9.74	13.25	22.99	40.00	-17.01		
2		144.1830	9.21	14.62	23.83	43.50	-19.67		
3	*	314.9000	64.89	14.48	79.37	46.00	33.37		
4		500.1256	12.51	18.21	30.72	46.00	-15.28		
5	X	629.8000	27.30	20.85	48.15	46.00	2.15		
6		932.2715	10.38	24.44	34.82	46.00	-11.18		

No.	Frequency (MHz)	Reading (dBuV)	Factor (dB)	Results (dBuV/m)	Limit (dBuV/m)	Margin (dB)	Detector
1	314.9	64.89	14.48	79.37	95.62	16.25	PK
2	314.9	/	/	69.97	75.62	5.62	AV
3	629.8	27.30	20.85	48.15	75.62	27.47	PK
4	629.8	/	/	/	55.62	/	AV

Remark: 1. All readings are Quasi-Peak and Average values.
 2. Margin = Result (Result =Reading + Factor)–Limi
 3. When peak value applied to AVG limit, the AVG value is not calculated.
 4. Spurious Emission AVG value= Peak Value - 20*LOG(1/Duty cycle)
 $<79.37 - 20*\text{LOG}(1/0.338) = 69.97\text{dBuV/m} <75.62\text{dBuV/m}$

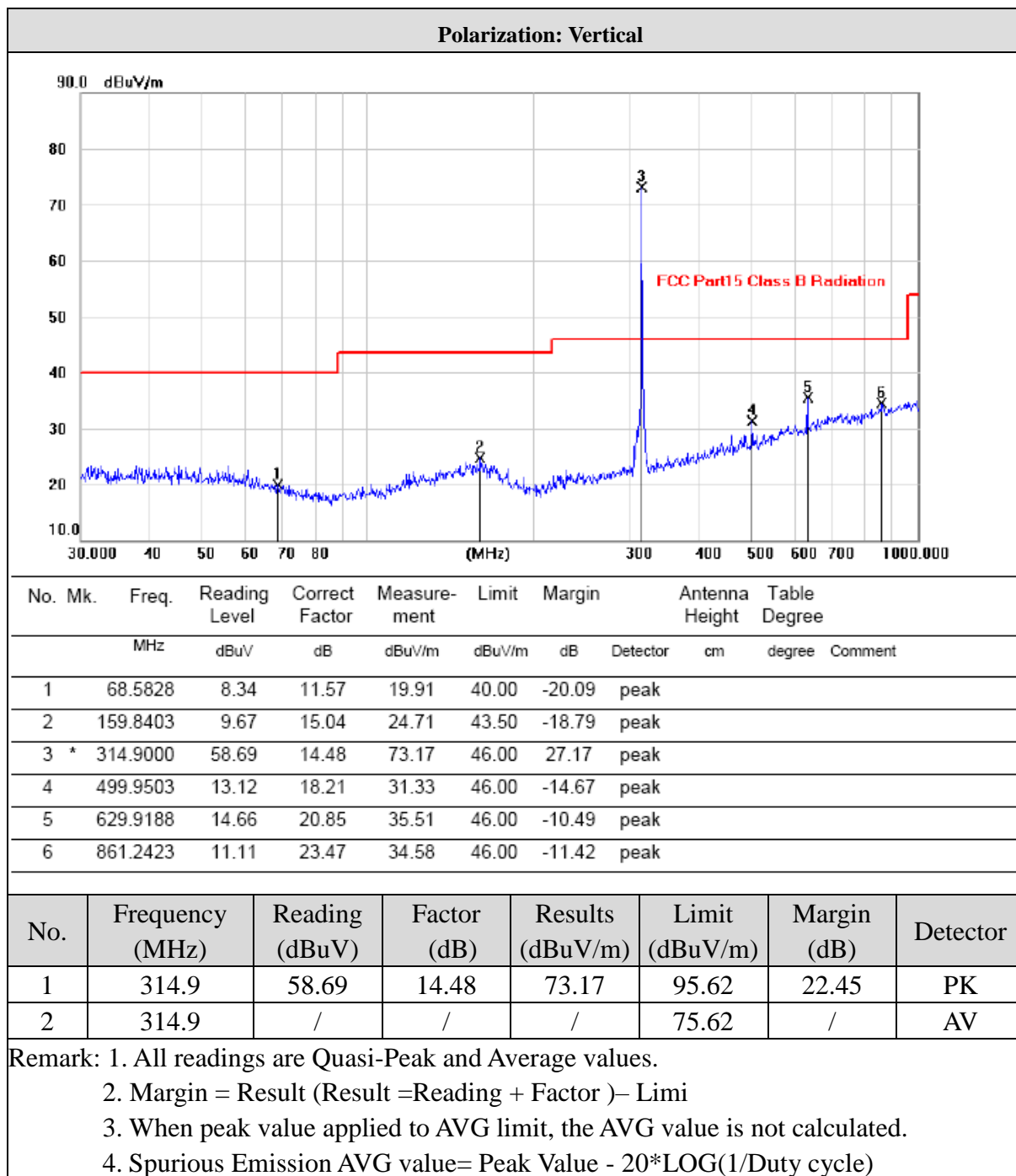

Duty Cycle:

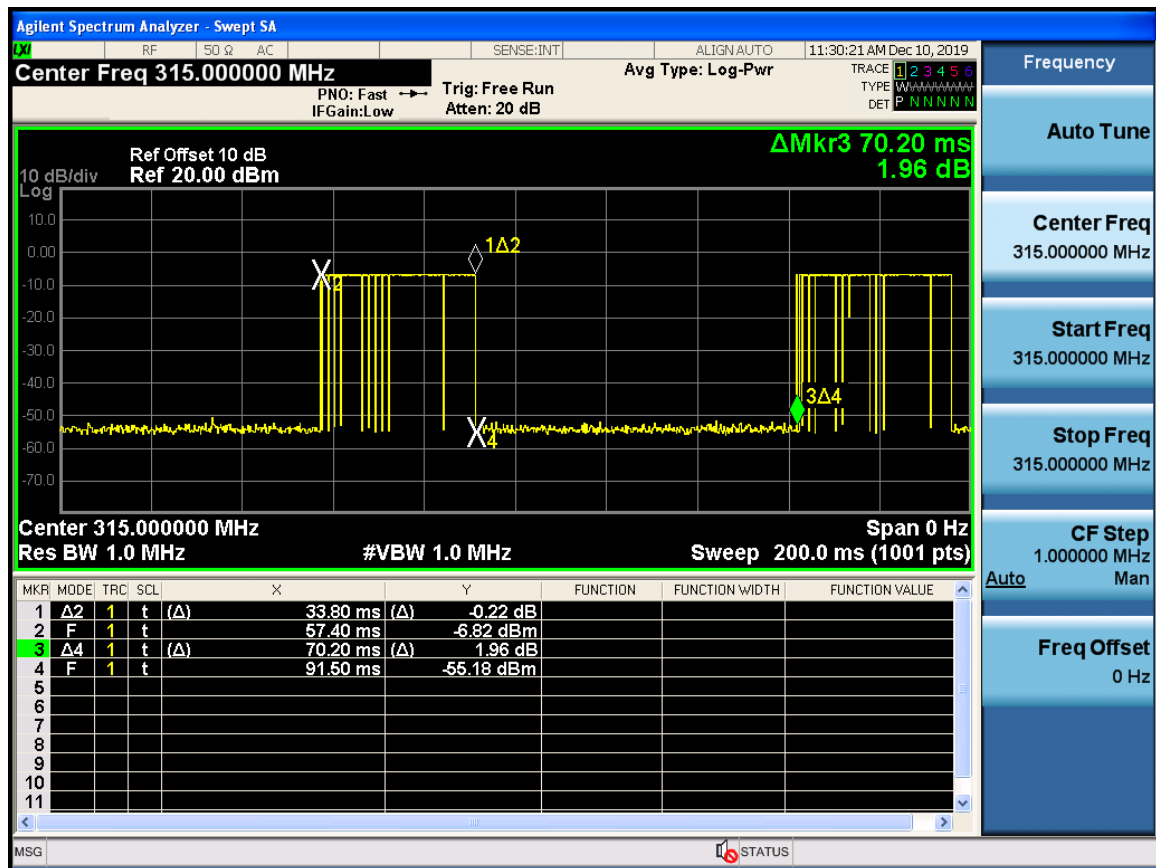

Pulse sequence period over 100ms ($33.8+70.2>100$ ms).

Ton=33.8ms

Duty Cycle $< \text{Ton}/100 = 0.338$

Above 1GHz:

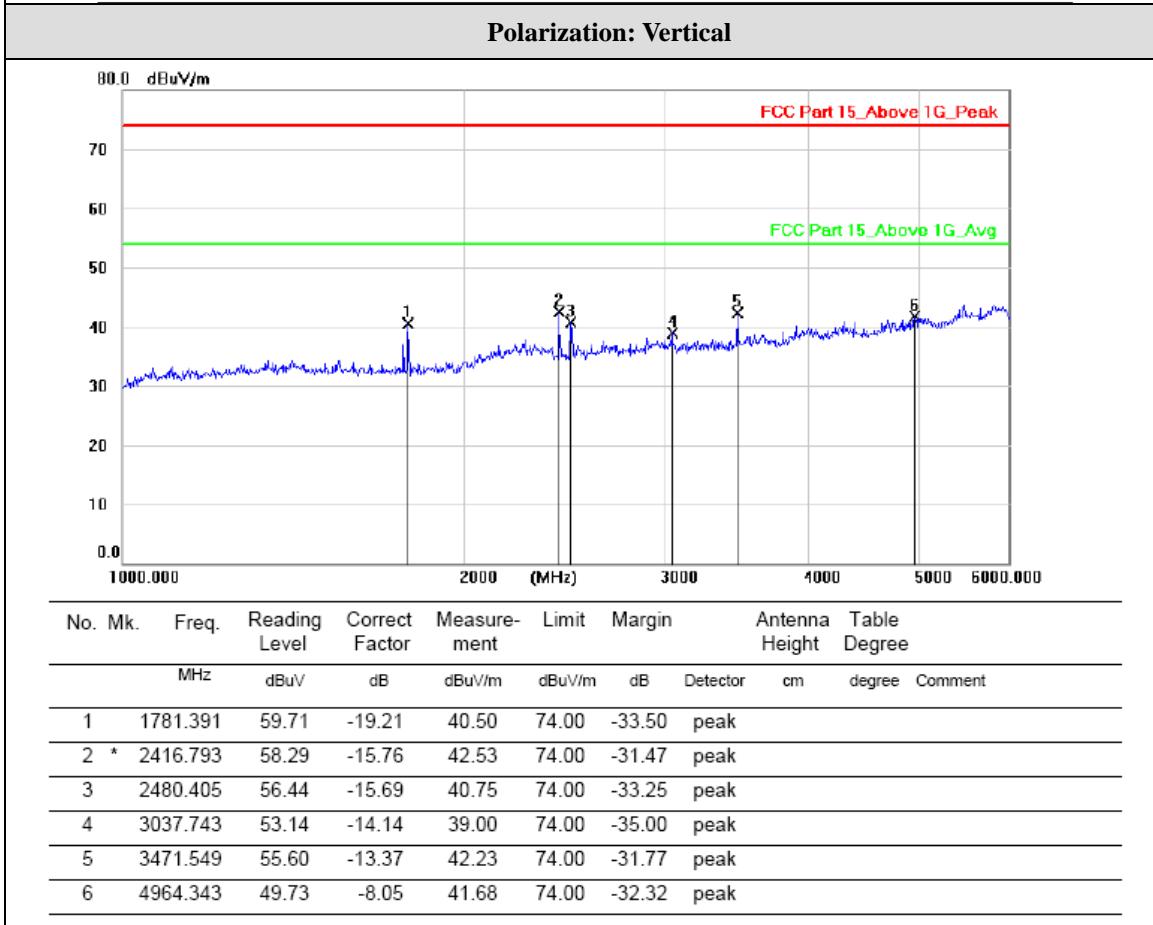
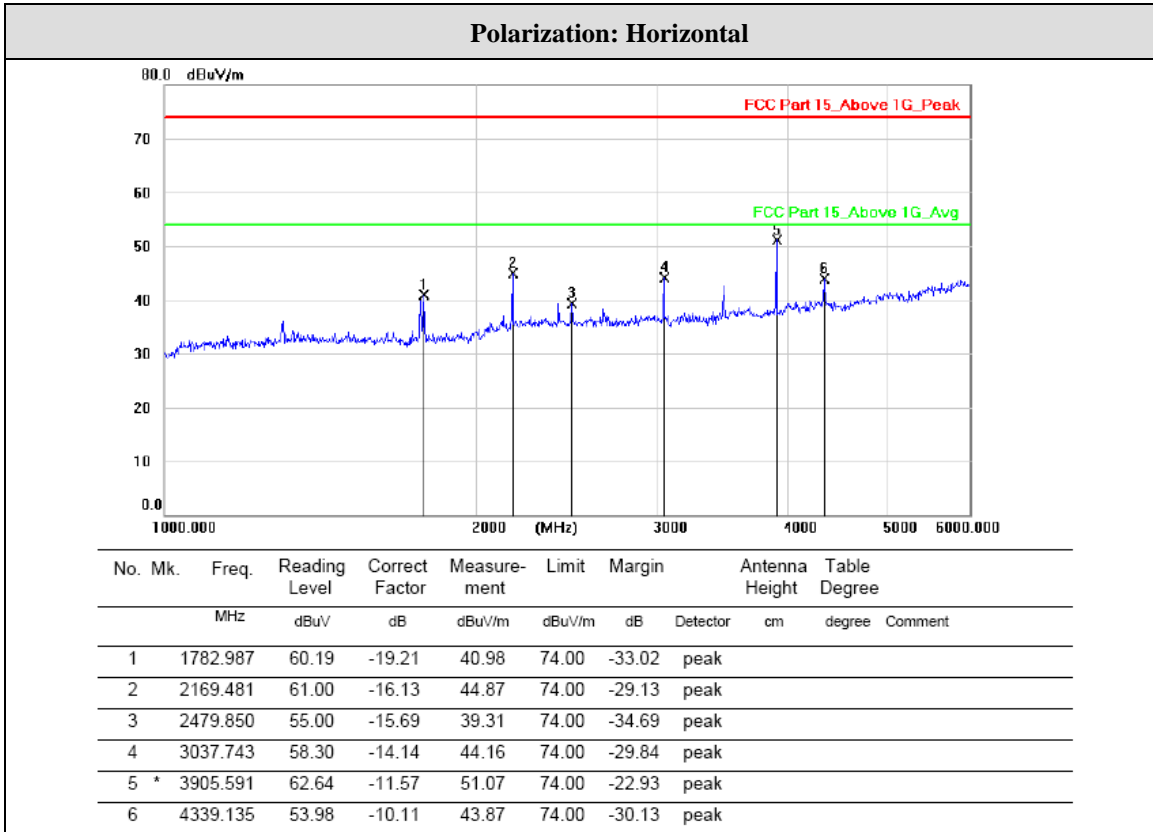

4. POWER LINE CONDUCTED EMISSION

4.1. Conducted Emission Limits (15.209)

Frequency MHz	Limits dB(μ V)	
	Quasi-peak Level	Average Level
0.15 -0.50	66 -56*	56 - 46*
0.50 -5.00	56	46
5.00 -30.00	60	50

Notes: 1. *Decreasing linearly with logarithm of frequency.

2. The lower limit shall apply at the transition frequencies.

3. The limit decreases in line with the logarithm of the frequency in the rang of 0.15 to 0.50 MHz.

4.2. Test Setup

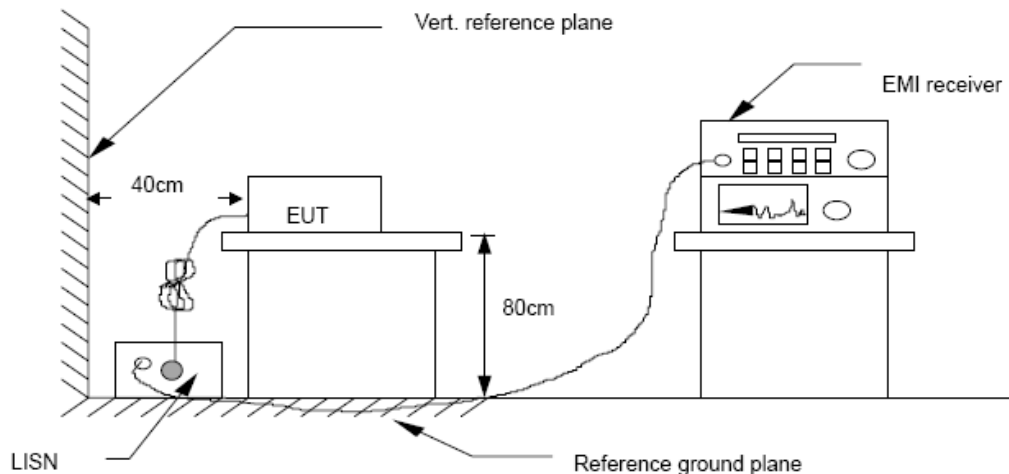

4.3. Test Procedure

The EUT is put on the plane 0.8m high above the ground by insulating support and is connected to the power mains through a line impedance stabilization network (L.I.S.N.). This provides a 50ohm coupling impedance for the EUT system. Please refer the block diagram of the test setup and photographs. Both sides of AC lines are checked to find out the maximum conducted emission. In order to find the maximum emission levels, the relative positions of equipment and all of the interface cables shall be changed according to ANSI C63.10:2013

on Conducted Emission Measurement.

The bandwidth of test receiver (R & S ESCI) is set at 9 kHz.

4.4. Test Results

EUT power supply by battery, so the test not applicable.

5. Occupied bandwidth

5.1. Test limit

Please refer section RSS-210 & 15.231

According to §15.231(C), The bandwidth of the emission shall be no wider than 0.25% of the center frequency for devices operating above 70MHz and below 900MHz.

5.2. Method of measurement

a)The bandwidth is measured at an amplitude level reduced 20dB from the reference level. The reference level is the level of the highest amplitude signal observed from the transmitter at the fundamental frequency. Once the reference level is established, the equipment is conditioned with typical modulating signal to produce the worst-case (i.e. the widest) bandwidth.

b)The test receiver RBW set 30KHz,VBW set 30KHz,Sweep time set auto.

5.3. Test Setup

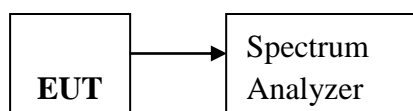

5.4. Test Results

Mode	Freq (MHz)	20dB Bandwidth (kHz)	99% Bandwidth	Limit (kHz)	Conclusion
ASK	314.9	202.6	/	787.25	PASS

Note:

Limit = 314.9MHz *0.25% = 787.25 kHz

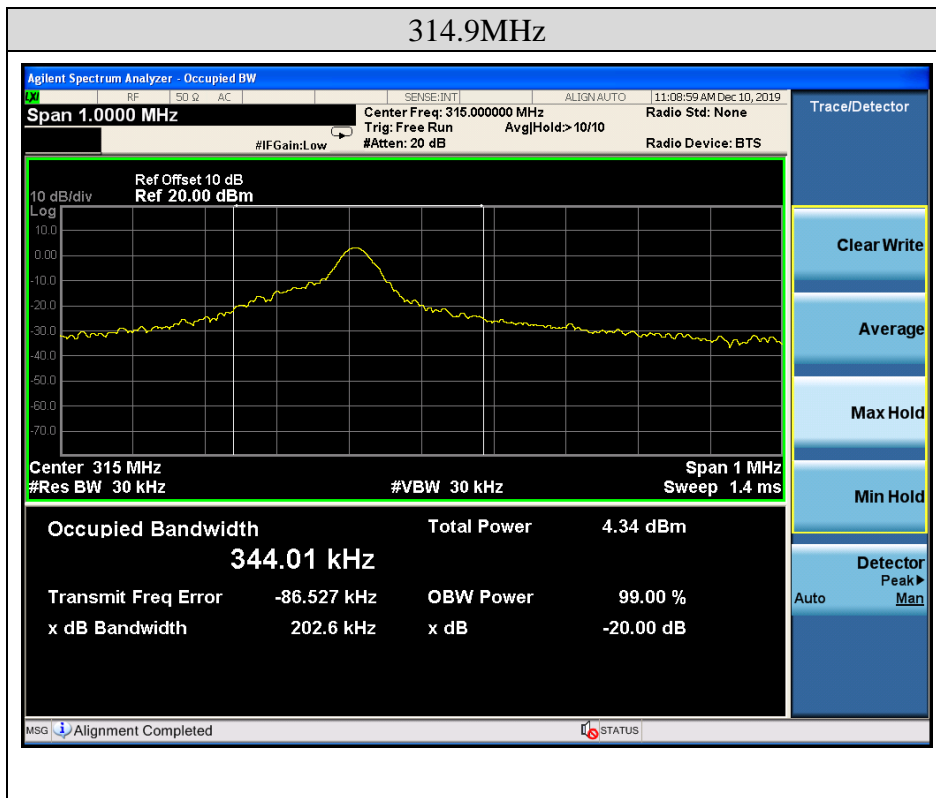

6. Transmission time

6.1. Test limit

Please refer section RSS-210 & 15.231

According to §15.231(a)(1), A manually operated transmitter shall employ a switch that will automatically deactivate the transmitter within not more than 5 seconds of being released.

6.2. Method of measurement

6.2.1. Place the EUT on the table and set it in transmitting mode.

6.2.2. Remove the antenna from the EUT and then connect a low loss RF cable from the antenna port to the spectrum analyzer.

6.2.3. Set spectrum analyzer Center= 314.9MHz, Span = 0MHz, Sweep = 5s.

6.2.4. Set the spectrum analyzer as RBW, VBW=1MHz,

6.2.5. Max hold, view and count how many channel in the band.

6.3. Test Setup

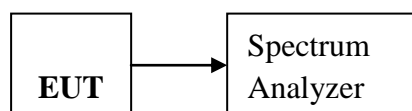

6.4. Test Results

Freq (MHz)	Test Result(s)	Limit (s)	Conclusion
314.9	0.140	< 5s	PASS

EUT After Release the button, EUT emission Continue 0.140 seconds, Compliance with 15.231 a(1) section.

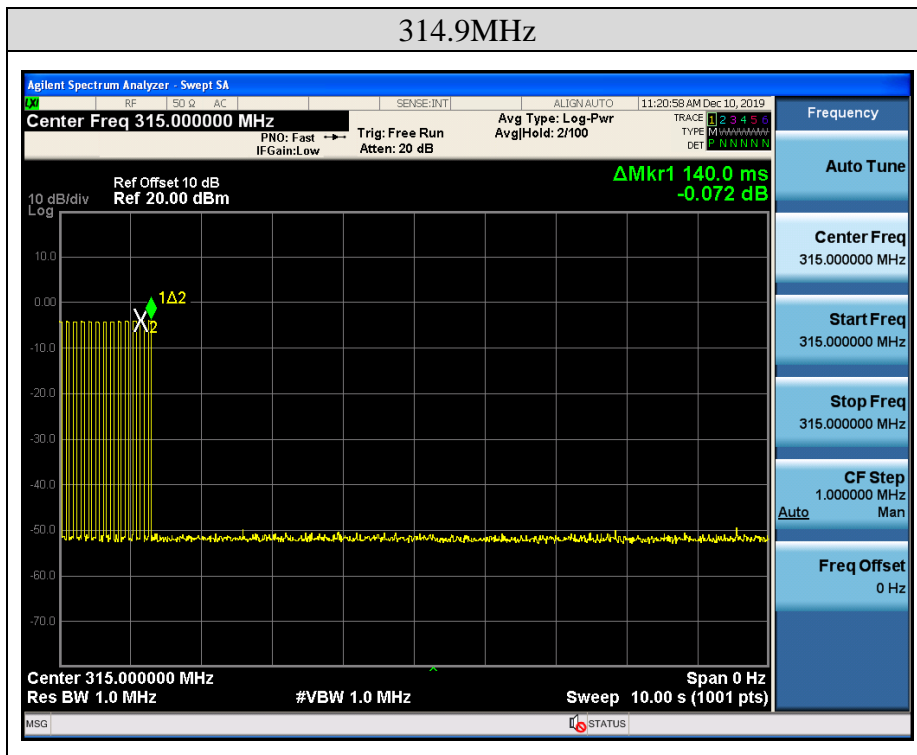

7. Antenna Requirement

7.1. Standard Requirement

An intentional radiator shall be designed to ensure that no antenna other than that furnished by the responsible party shall be used with the device. The use of a permanently attached antenna or of an antenna that uses a unique coupling to the intentional radiator shall be considered sufficient to comply with the provisions of this Section. The manufacturer may design the unit so that a broken antenna can be replaced by the user, but the use of a standard antenna jack or electrical connector is prohibited.

7.2. Antenna Connected Construction

The directional gains of antenna used for transmitting is 0 dBi, and the antenna connector is designed with permanent attachment and no consideration of replacement. Please see EUT photo for details.

7.3. Result

The EUT antenna is Internal antenna. It comply with the standard requirement.

8. Test setup photo

Photos of Radiated emission

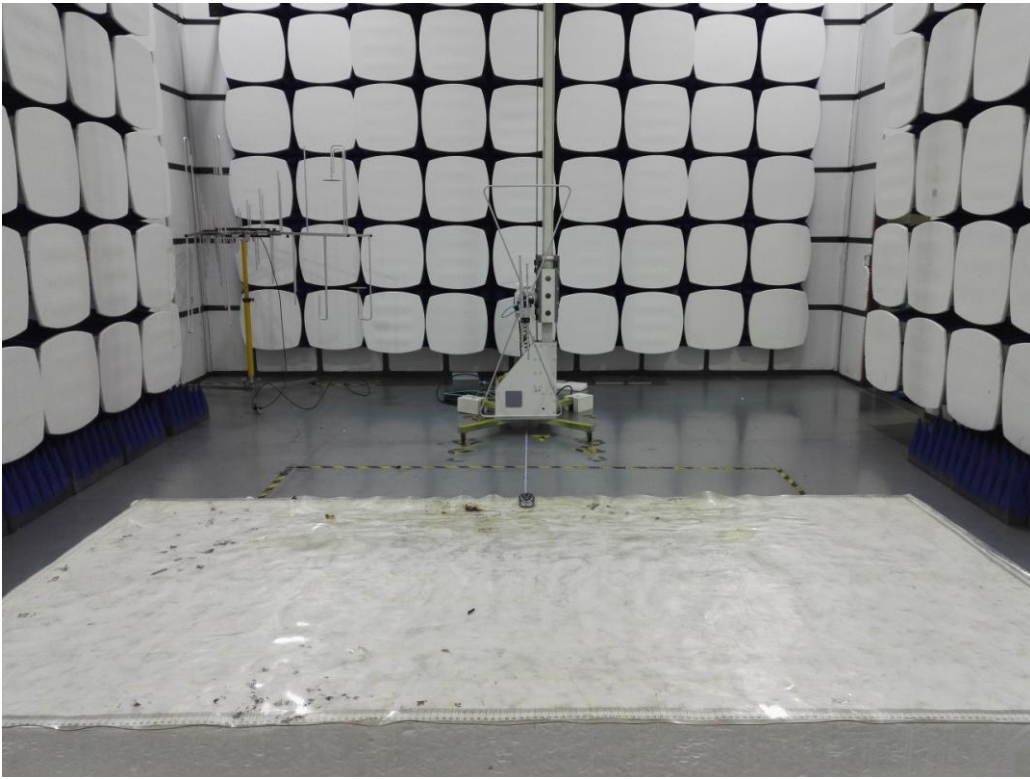

9. Photos of EUT



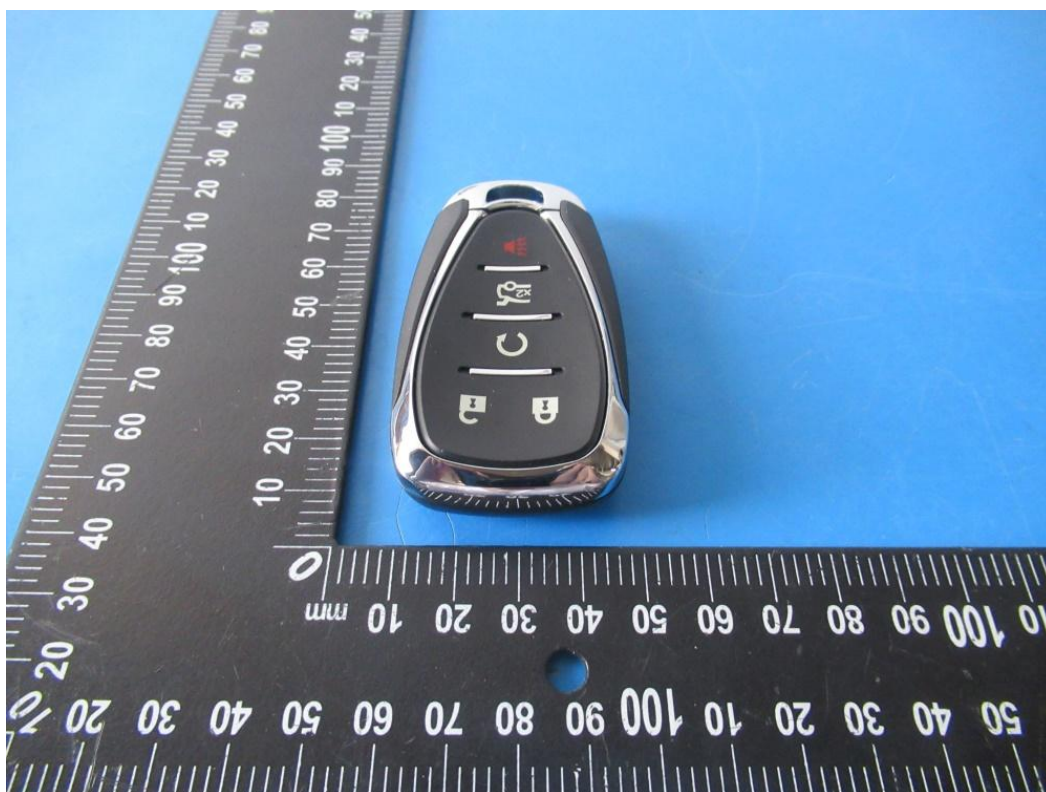





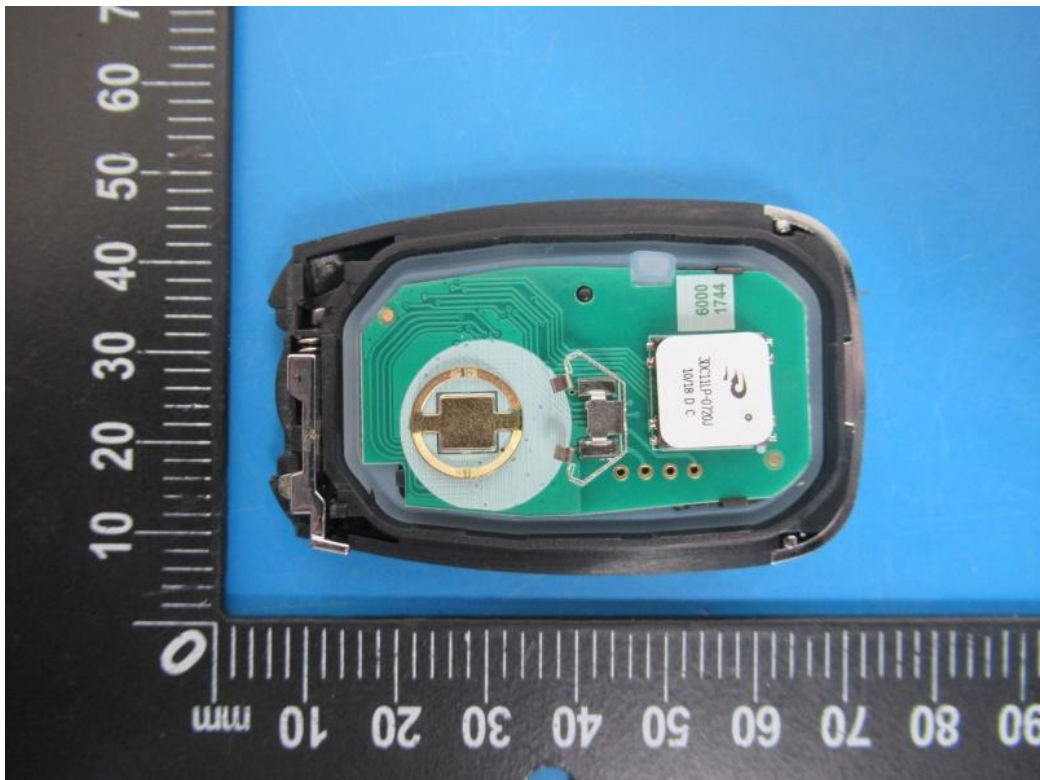
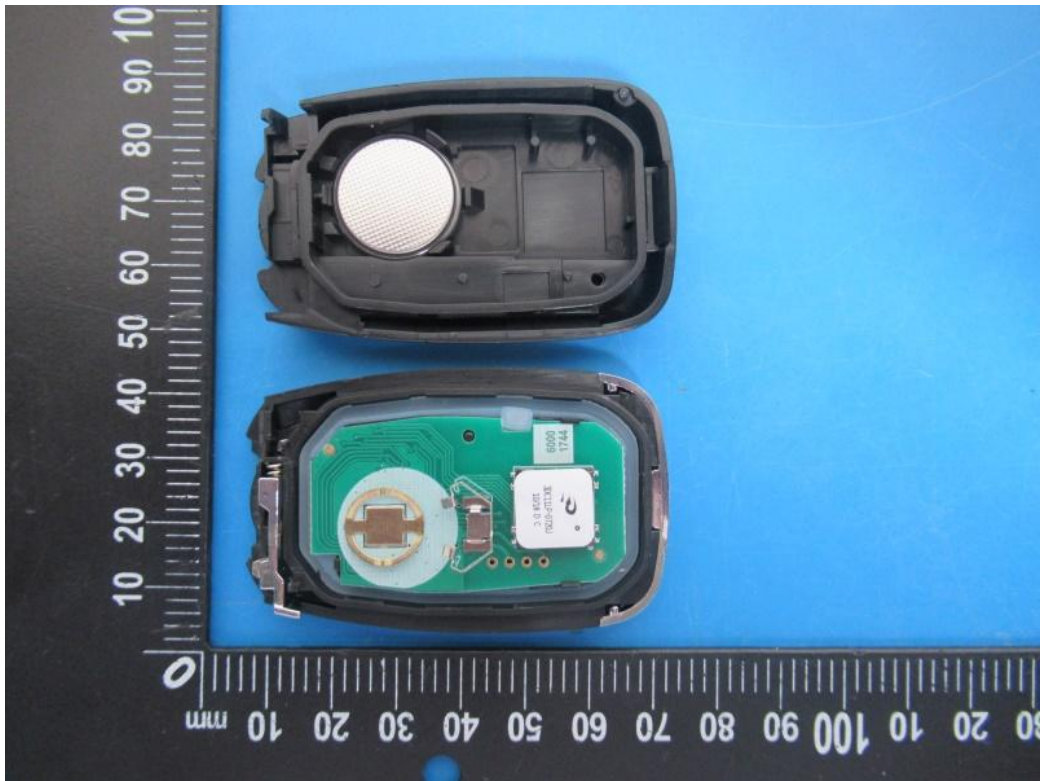

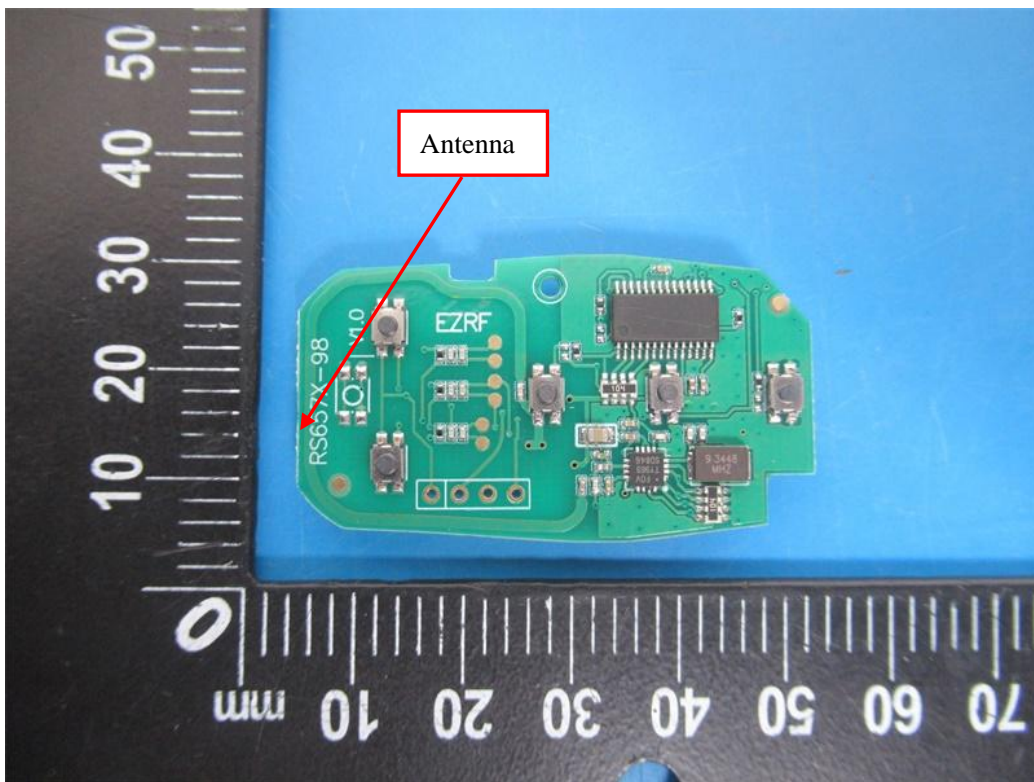
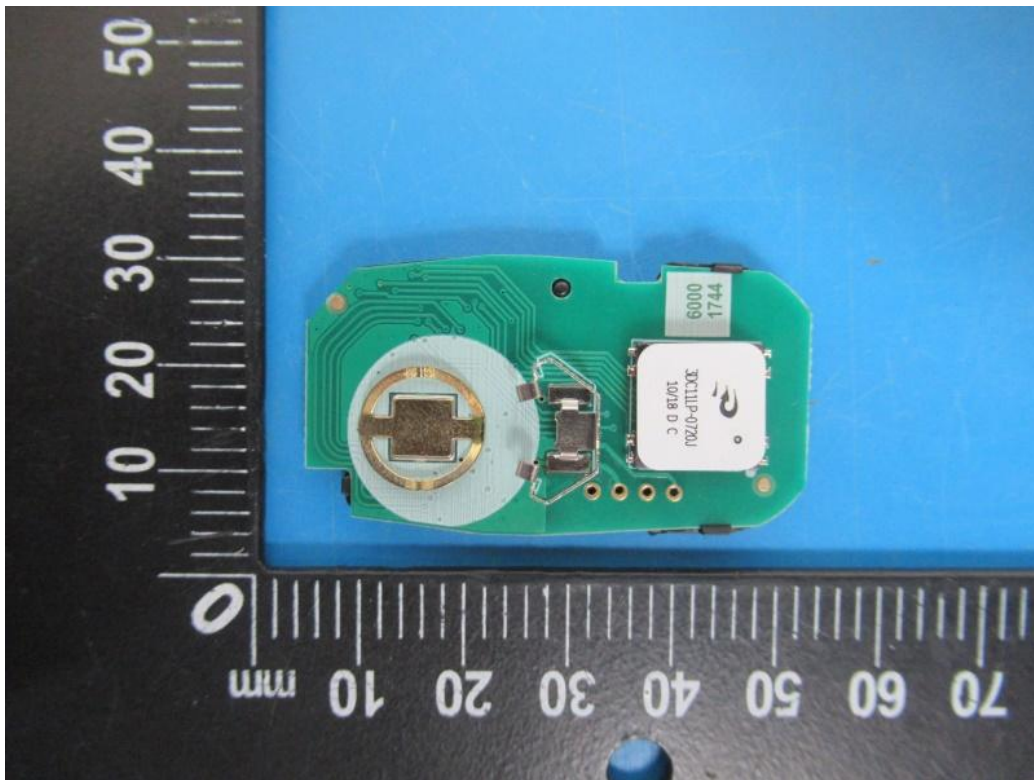



-----END OF THE REPORT-----