



Shenzhen Toby Technology Co., Ltd.

DFS Test Report

FCC ID: 2AOKI-WFM68AUWF1

IC: 23460-WFM68AUWF1

Product: WiFi Module

Model No.: WF-M68A-UWF1

Additional Model No.: N/A

Trade Mark: N/A

Report No.: TB-FCC170993

Issued Date: Dec. 10, 2019

Issued for:

Sichuan AI-Link Technology Co., Ltd.

Anzhou, Industrial park, Mianyang, Sichuan, China

Issued By:

Shenzhen Toby Technology Co., Ltd.

**1A/F., Bldg.6, Yusheng Industrial Zone, The National Road No.107 Xixiang
Section 467, Xixiang, Bao'an, Shenzhen, China**

TEL: +86 75526509301

FAX: +86 75526509195

Note: *This report shall not be reproduced except in full, without the written approval of Shenzhen Toby Technology Co., Ltd., This document may be altered or revised by Shenzhen Toby Technology Co., Ltd. personnel only, and shall be noted in the revision section of the document. The test results in the report only apply to the tested sample.*

TABLE OF CONTENTS

1. Test Certification	3
2. Test Result Summary	4
3. EUT Description	5
4. General Information	6
4.1. RF GENERAL INFORMATION.....	6
4.2. DESCRIPTION OF SUPPORT UNITS	6
4.3. TEST INSTRUMENTS LIST	7
5. Facilities and Accreditations	8
5.1. FACILITIES.....	8
5.2. LOCATION	8
5.3. MEASUREMENT UNCERTAINTY	8
6. Dynamic Frequency Selection (DFS) Test Result	9
6.1. GENERAL DFS INFORMATION	9
6.2. RADAR TEST WAVEFORM CALIBRATION	12
6.3. UNII DETECTION BANDWIDTH.....	17
6.4. CHANNEL AVAILABILITY CHECK (CAC).....	18
6.5. IN-SERVICE MONITORING	19
6.6. STATISTICAL PERFORMANCE CHECK.....	24
6.6.1. STATISTICAL PERFORMANCE CHECK LIMIT	24
6.6.2. MEASURING INSTRUMENTS	24
Appendix A: Photographs of Test Setup	27

1. Test Certification

Product:	WiFi Module
Model No.:	WF-M68A-UWF1
Additional Model No.:	N/A
Trade Mark:	N/A
Applicant:	Sichuan AI-Link Technology Co., Ltd.
Address:	Anzhou, Industrial park, Mianyang, Sichuan, China
Manufacturer:	Sichuan AI-Link Technology Co., Ltd.
Address:	Anzhou, Industrial park, Mianyang, Sichuan, China
Date of Test:	Oct. 31, 2019 – Dec. 09, 2019
Applicable Standards:	47 CFR FCC Part 15.407 RSS-247 Issue 2 KDB905462 D02 UNII DFS Compliance Procedures New Rules v02 KDB 905462 D03 UNII Clients Without Radar Detection New Rules v01r02

The above equipment has been tested by Shenzhen Toby Technology Co., Ltd., and found compliance with the requirements set forth in the technical standards mentioned above. The results of testing in this report apply only to the product/system, which was tested. Other similar equipment will not necessarily produce the same results due to production tolerance and measurement uncertainties.

Tested By: Jason Xu
Jason Xu

Date: Dec. 09, 2019

Reviewed By: Ivan Su
Ivan Su

Date: Dec. 10, 2019

Approved By: Ray Lai
Ray Lai

Date: Dec. 10, 2019

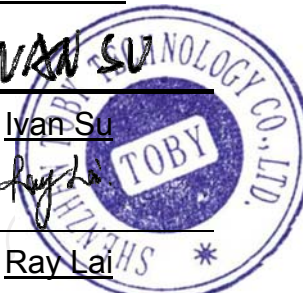

2. Test Result Summary

Conformance Test Specifications					
Report Clause	Ref. Std. Clause	Description	Measured	Limit	Result
UNII Detection Bandwidth	7.8.1	DFS: UNII Detection Bandwidth Measurement	N/A	100% of the 99% BW	N/A
Channel Availability Check	7.8.2.1	DFS: Initial Channel Availability Check Time	N/A	CAC \geq 60 sec	N/A
Channel Availability Check	7.8.2.2	DFS: Radar Burst at the Beginning of the Channel Availability Check Time	N/A	Detection Threshold: -62dBm	N/A
Channel Availability Check	7.8.2.3	DFS: Radar Burst at the End of the Channel Availability Check Time	N/A	Detection Threshold: -62dBm	N/A
In-service Monitoring	7.8.3	DFS: In-Service Monitoring for Channel Move Time (CMT)	CMT \leq 10sec	CMT \leq 10sec	Complied
In-service Monitoring	7.8.3	DFS: In-Service Monitoring for Channel Closing Transmission Time (CCTT)	CCTT \leq 60 ms starting at CMT 200ms	CCTT \leq 60 ms starting at CMT 200ms	Complied
In-service Monitoring	7.8.3	DFS: In-Service Monitoring for Non-Occupancy Period (NOP)	NOP > 30 min	NOP \geq 30 min	Complied
Statistical Performance Check	7.8.4	DFS: Statistical Performance Check	Complied	Table 5 - 7 (KDB 905462)	Complied

3. EUT Description

Product:	WiFi Module
Model No.:	WF-M68A-UWF1
Additional Model No.:	N/A
Trade Mark:	N/A
EUT type	Client only device, no radar detection Capability
Operation Frequency:	Band 2A: 5250MHz~5350MHz Band 2C: 5470MHz~5725MHz
Channel Separation:	802.11a: 20MHz 802.11n: 20MHz, 40MHz 802.11ac: 20MHz, 40MHz, 80MHz
Modulation Technology:	Orthogonal Frequency Division Multiplexing(OFDM)
Antenna Type:	Internal Antenna
Antenna Gain:	Band 2A: 5250MHz~5350MHz: 2dBi Band 2C: 5470MHz~5725MHz: 2dBi
Power Supply:	DC 3.3V
First Channel operating:	This device selects the operating frequency with randomly in the DFS operation frequency.



4. General Information

4.1. RF General information

IEEE Std. 802.11	Channel Bandwidth (MHz)
a/n/ac (HT20)	20
n/ac (HT40)	40
ac(VHT80)	80
802.11a/n/ac uses a combination of OFDM-BPSK, QPSK, 16QAM, 64QAM modulation.	
Remark: All test are performed with conducted method	

4.2. Description of Support Units

The EUT has been tested as an independent unit together with other necessary accessories or support units. The following support units or accessories were used to form a representative test configuration during the tests.

Equipment	Model No.	Serial No.	FCC ID	IC ID	Trade Name
AP	R6300v2	3GM24478A 0282	PY313200227	4054A-13200227	NTEGEAR
PC	Insprion3668	CNOYUJCX	/	/	DELL

Note:

1. All the equipment/cables were placed in the worst-case configuration to maximize the emission during the test.
2. Grounding was established in accordance with the manufacturer's requirements and conditions for the intended use.

4.3. Test Instruments List

Equipment	Manufacturer	Model No.	Serial No.	Last Cal.	Cal. Due Date
Spectrum Analyzer	Agilent	E4407B	MY45106456	Jul. 13, 2019	Jul. 12, 2020
Spectrum Analyzer	Rohde & Schwarz	ESCI	100010/007	Jul. 13, 2019	Jul. 12, 2020
MXA Signal Analyzer	Agilent	N9020A	MY49100060	Sep. 16, 2019	Sep. 15, 2020
Vector Signal Generator	Agilent	N5182A	MY50141294	Sep. 16, 2019	Sep. 15, 2020
Analog Signal Generator	Agilent	N5181A	MY50141953	Sep. 16, 2019	Sep. 15, 2020
RF Power Sensor	DARE!! Instruments	RadiPowerRPR3006W	17I00015SNO26	Sep. 16, 2019	Sep. 15, 2020
	DARE!! Instruments	RadiPowerRPR3006W	17I00015SNO29	Sep. 16, 2019	Sep. 15, 2020
	DARE!! Instruments	RadiPowerRPR3006W	17I00015SNO31	Sep. 16, 2019	Sep. 15, 2020
	DARE!! Instruments	RadiPowerRPR3006W	17I00015SNO33	Sep. 16, 2019	Sep. 15, 2020
Signal analyzer	Agilent	N9020A	MY499100060	Sep. 16, 2019	Sep. 15, 2020
Vector signal generator	Agilent	N5182A	MY49060042	Sep. 16, 2019	Sep. 15, 2020

Note: The calibration interval of the above test instruments is 12 months and the calibrations are traceable to international system unit (SI).

5. Facilities and Accreditations

5.1. Facilities

The testing report were performed by the Shenzhen Toby Technology Co., Ltd., in their facilities located at 1A/F., Bldg.6, Yusheng Industrial Zone, The National Road No.107 Xixiang Section 467, Xixiang, Bao'an, Shenzhen, Guangdong, China. At the time of testing, the following bodies accredited the Laboratory:

A2LA Certificate No.: 4750.01

The laboratory has been accredited by American Association for Laboratory Accreditation(A2LA) to ISO/IEC 17025: 2005 General Requirements for the Competence of Testing and Calibration Laboratories for the technical competence in the field of Electrical Testing. And the A2LA Certificate No.: 4750.01.

IC Registration No.: (11950A-1)

The Laboratory has been registered by Certification and Engineering Bureau of Industry Canada for radio equipment testing. The site registration: Site# 11950A-1.

5.2. Location

Shenzhen Toby Technology Co., Ltd.

Address: 1A/F., Bldg.6, Yusheng Industrial Zone, The National Road No.107 Xixiang Section 467, Xixiang, Bao'an, Shenzhen, China

TEL: +86 75526509301

5.3. Measurement Uncertainty

The reported uncertainty of measurement $y \pm U$, where expended uncertainty U is based on a standard uncertainty multiplied by a coverage factor of $k=2$, providing a level of confidence of approximately 95 %.

No.	Item	MU
1	Conducted Emission	$\pm 2.56\text{dB}$
2	RF power, conducted	$\pm 0.12\text{dB}$
3	Spurious emissions, conducted	$\pm 0.11\text{dB}$
4	All emissions, radiated(<1G)	$\pm 3.92\text{dB}$
5	All emissions, radiated(>1G)	$\pm 4.28\text{dB}$
6	Temperature	$\pm 0.1^\circ\text{C}$
7	Humidity	$\pm 1.0\%$

6. Dynamic Frequency Selection (DFS) Test Result

6.1. General DFS Information

6.1.1. DFS Parameters

Table D.1: DFS requirement values

Parameter	Value
Non-occupancy period	Minimum 30 minutes
Channel Availability Check Time	60 seconds
Channel Move Time	10 seconds See Note 1.
Channel Closing Transmission Time	200 milliseconds + an aggregate of 60 milliseconds over remaining 10 second periods. See Notes 1 and 2.
U-NII Detection Bandwidth	Minimum 100% of the 99% power bandwidth See Note 3.

Note 1: The instant that the *Channel Move Time* and the *Channel Closing Transmission Time* begins is as follows:

- For the Short pulse radar Test Signals this instant is the end of the *Burst*.
- For the Frequency Hopping radar Test Signal, this instant is the end of the last radar *Burst* generated.
- For the Long Pulse radar Test Signal this instant is the end of the 12 second period defining the radar transmission.

Note 2: The *Channel Closing Transmission Time* is comprised of 200 milliseconds starting at the beginning of the *Channel Move Time* plus any additional intermittent control signals required to facilitate *Channel* changes (an aggregate of 60 milliseconds) during the remainder of the 10 second period. The aggregate duration of control signals will not count quiet periods in between transmissions.

Note 3: During the *U-NII Detection Bandwidth* detection test, radar type 1 is used and for each frequency step the minimum percentage of detection is 90%. Measurements are performed with no data traffic.

Table D.2: Interference threshold values

Maximum Transmit Power	Value (see note)
≥ 200 milliwatt	-64 dBm
< 200 milliwatt	-62 dBm

Note 1: This is the level at the input of the receiver assuming a 0 dBi receive antenna.

Note 2: Throughout these test procedures an additional 1 dB has been added to the amplitude of the test transmission waveforms to account for variations in measurement equipment. This will ensure that the test signal is at or above the detection threshold level to trigger a DFS response.

Note 1: This is the level at the input of the receiver assuming a 0 dBi receive antenna.

Note 2: Throughout these test procedures an additional 1 dB has been added to the amplitude of the test transmission waveforms to account for variations in measurement equipment. This will ensure that the test signal is at or above the detection threshold level to trigger a DFS response.

6.1.2. Applicability of DFS Requirements Prior to Use of a Channel

Requirement	DFS Operational mode		
	Master	Client without radar detection	Client with radar detection
<i>Non-Occupancy Period</i>	Yes	Not required	Yes
<i>DFS Detection Threshold</i>	Yes	Not required	Yes
<i>Channel Availability Check Time</i>	Yes	Not required	Not required
<i>Uniform Spreading</i>	Yes	Not required	Not required
<i>U-NII Detection Bandwidth</i>	Yes	Not required	Yes

6.1.3. Applicability of DFS Requirements during Normal Operation

Requirement	DFS Operational mode		
	Master	Client without radar detection	Client with radar detection
<i>DFS Detection Threshold</i>	Yes	Not required	Yes
<i>Channel Closing Transmission Time</i>	Yes	Yes	Yes
<i>Channel Move Time</i>	Yes	Yes	Yes
<i>U-NII Detection Bandwidth</i>	Yes	Not required	Yes

6.1.4. Uniform Spreading

Manufacturer Declare the Uniform Spreading
<input checked="" type="checkbox"/> For the 5250-5350 MHz and 5470-5725 MHz bands, the Master device provides, on aggregate, uniform loading of the spectrum across all devices by selecting an operating channel among the available channels using a Gaussian random algorithm.

6.1.5. User Access Restrictions

User Access Restrictions
<input checked="" type="checkbox"/> DFS controls (hardware or software) related to radar detection are NOT accessible to the user. Manufacturer statement confirming that information regarding the parameters of the detected Radar Waveforms is not available to the end user.

6.1.6. Channel Loading/Data Streaming

<input checked="" type="checkbox"/> IP Based (Load Based) - stream the test file from the Master to the Client
The client device is link with the master device and plays the WAV audio file from master device to client device. Test file download in NTIA website (http://ntiacsd.ntia.doc.gov/dfs/)
The client device is link with the master device and plays the MPEG file (6 1/2 Magic Hours) from master device to client device. Test file download in NTIA website (http://ntiacsd.ntia.doc.gov/dfs/)
Alternative streaming e.g., FTP with about 17 to 20% loading and submit proposal to FCC.

Frame Based - stream the test file from the Master to the Client.

fixed talk/listen ratio, set the ratio to 45%/55%



6.2. Radar Test Waveform Calibration

6.2.1. Short Pulse Radar Test Waveforms

Table 5 – Short Pulse Radar Test Waveforms

Radar Type	Pulse Width (μsec)	PRI (μsec)	Number of Pulses	Minimum Percentage of Successful Detection	Minimum Number of Trials
0	1	1428	18	See Note 1	See Note 1
1	1	Test A: 15 unique PRI values randomly selected from the list of 23 PRI values in Table 5a	Roundup $\left\{ \left(\frac{1}{360} \right) \cdot \left(\frac{19 \cdot 10^6}{PRI_{\mu sec}} \right) \right\}$	60%	30
		Test B: 15 unique PRI values randomly selected within the range of 518-3066 μsec, with a minimum increment of 1 μsec, excluding PRI values selected in Test A			
2	1-5	150-230	23-29	60%	30
3	6-10	200-500	16-18	60%	30
4	11-20	200-500	12-16	60%	30
Aggregate (Radar Types 1-4)				80%	120
Note 1: Short Pulse Radar Type 0 should be used for the detection bandwidth test, channel move time, and channel closing time tests.					

A minimum of 30 unique waveforms are required for each of the short pulse radar types 2 through 4. For short pulse radar type 1, the same waveform is used a minimum of 30 times. If more than 30 waveforms are used for short pulse radar types 2 through 4, then each additional waveform must also be unique and not repeated from the previous waveforms. The aggregate is the average of the percentage of successful detections of short pulse radar types 1-4.

6.2.2. Long Pulse Radar Test Waveform

Radar Type	Pulse Width (µsec)	ChirpWidth (MHz)	PRI (µsec)	Number of Pulses per Burst	Number of Bursts	Minimum Percentage of Successful Detection	Minimum Trials
5	50-100	5-20	1000-2000	1-3	8-20	80%	30

Each waveform is defined as follows:

- ◆ The transmission period for the Long Pulse Radar test signal is 12 seconds.
- ◆ There are a total of 8 to 20 Bursts in the 12 second period, with the number of Bursts being randomly chosen. This number is Burst Count.
- ◆ Each Burst consists of 1 to 3 pulses, with the number of pulses being randomly chosen. Each Burst within the 12 second sequence may have a different number of pulses.
- ◆ The pulse width is between 50 and 100 microseconds, with the pulse width being randomly chosen. Each pulse within a Burst will have the same pulse width. Pulses in different Bursts may have different pulse widths.
- ◆ Each pulse has a linear FM chirp between 5 and 20 MHz, with the chirp width being randomly chosen. Each pulse within a Burst will have the same chirp width. Pulses in different Bursts may have different chirp widths. The chirp is centered on the pulse. For example, with a radar frequency of 5300 MHz and a 20 MHz chirped signal, the chirp starts at 5290 MHz and ends at 5310 MHz.
- ◆ If more than one pulse is present in a Burst, the time between the pulses will be between 1000 and 2000 microseconds, with the time being randomly chosen. If three pulses are present in a Burst, the time between the first and second pulses is chosen independently of the time between the second and third pulses.
- ◆ The 12 second transmission period is divided into even intervals. The number of intervals is equal to Burst_Count. Each interval is of length $(12,000,000 / \text{Burst_Count})$ microseconds. Each interval contains one Burst. The start time for the Burst, relative to the beginning of the interval, is between 1 and $[(12,000,000 / \text{Burst_Count}) - (\text{Total Burst Length}) + (\text{One Random PRI Interval})]$ microseconds, with the start time being randomly chosen. The step interval for the start time is 1 microsecond. The start time for each Burst is chosen independently.

6.2.3. Frequency Hopping Radar Test Waveform

Radar Type	Pulse Width (µsec)	PRI (µsec)	Pulses per Hop	Hopping Rate (kHz)	Hopping Sequence Length (ms)	Minimum Percentage of Successful Detection	Minimum Trials
6	1	333	9	0.333	300	70%	30

The FCC Type 6 waveform uses a static waveform with 100 bursts in the instruments ARB. In addition, the RF list mode is operated with a list containing 100 frequencies from a randomly generated list and it had be ensured that at least one of the random frequencies falls into the UNII Detection Bandwidth of the DUT. Each burst from the waveform file initiates a trigger pulse at the beginning that switches the RF list from one item to the next one.

6.2.4. DFS Threshold Level

DFS Threshold Level	
DFS Threshold level: -62 dBm	<input type="checkbox"/> at the antenna connector
	<input checked="" type="checkbox"/> in front of the antenna
The Interference Radar Detection Threshold Level is -62 dBm. That had been taken into account the output power range and antenna gain.	

6.2.5. Test Set up

Setup for Client with injection at the Master

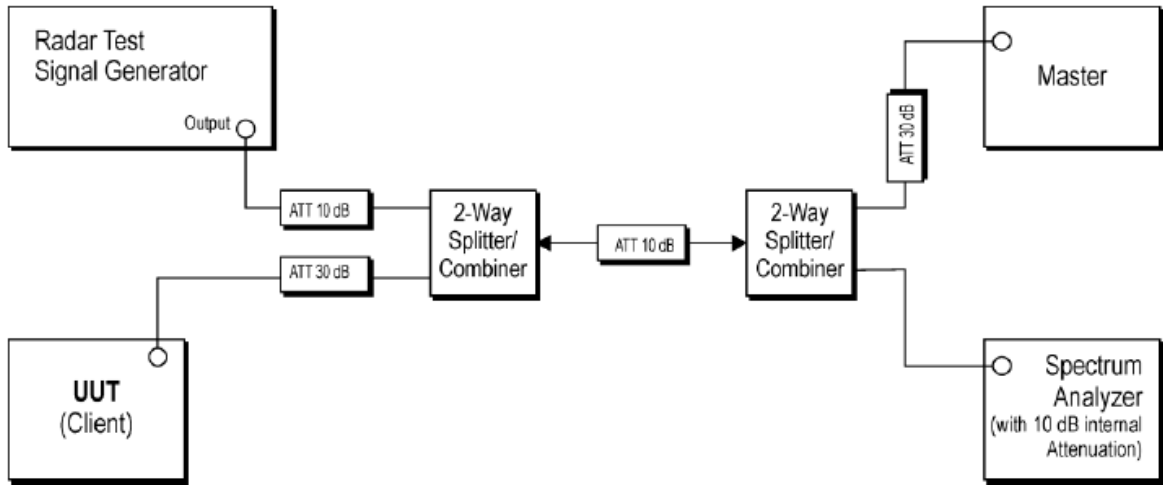

Calibration Plots

DFS signal: -62dBm

Radar # 0 DFS detection threshold level

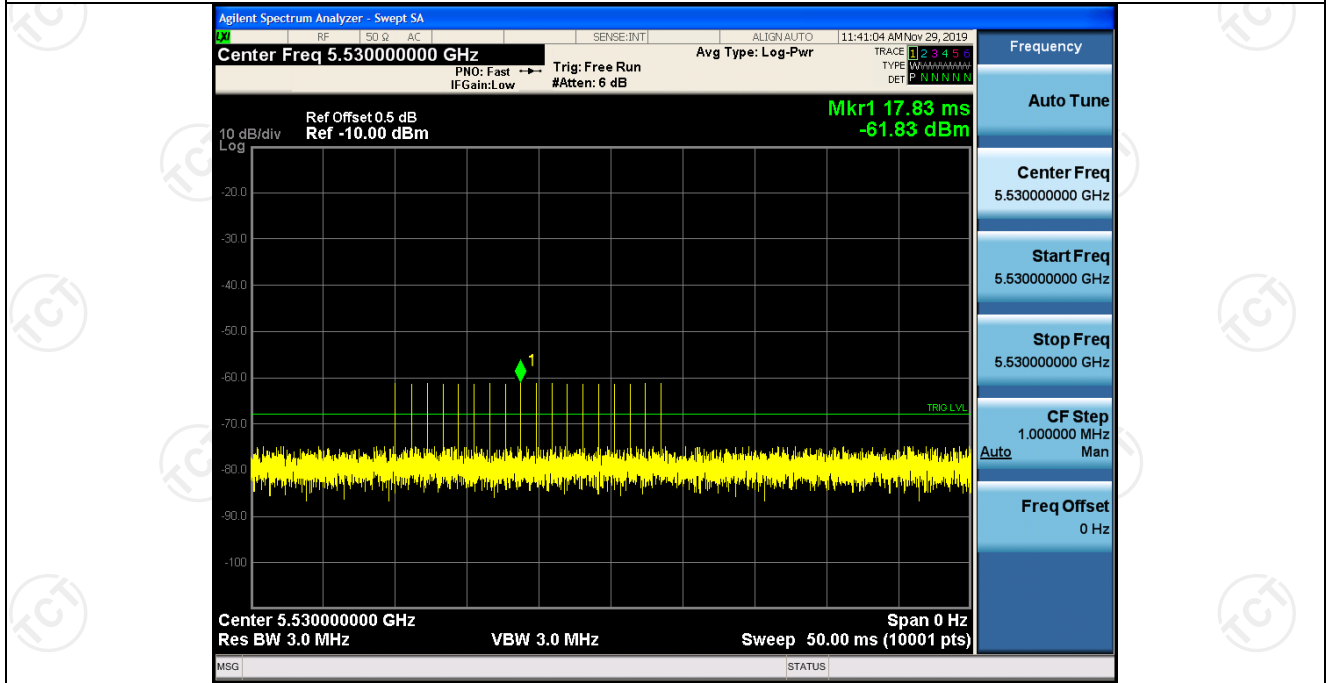

6.3. UNII Detection Bandwidth

6.3.1. UNII Detection Bandwidth Limit

Channel Bandwidth (MHz)	99% Power Bandwidth (MHz)	UNII Detection Bandwidth (MHz)
20	N/A	N/A
40	N/A	N/A
80	N/A	N/A

UNII Detection Bandwidth is minimum 100% of the 99% power bandwidth. A single radar Burst is generated for a minimum of 10 trials, and the response of the UUT is noted. The UUT must detect the Radar Waveform 90% or more of the time.

6.3.2. Measuring Instruments

Refer a test equipment and calibration data table in this test report.

6.3.3. Test Procedures

Test Method
<p>☒ Refer as KDB905462 D02 UNII DFS Compliance Procedures New Rules v02, clause 7.8.1 for UNII Detection Bandwidth test. During the U-NII Detection Bandwidth detection test, radar type 1 is used and for each frequency step the minimum percentage of detection is 90 percent. Measurements are performed with no data traffic. The EUT is set up as a standalone device (no associated Client and no traffic). The radar frequency is increased in 1 MHz steps, repeating the above test sequence, until the detection rate falls below 90%. The highest frequency at which detection is greater than or equal to 90% is denoted as FH. The radar frequency is decreased in 1 MHz steps, repeating the above test sequence, until the detection rate falls below 90%. The lowest frequency at which detection is greater than or equal to 90% is denoted as FL. UNII Detection Bandwidth = FH -FL</p>

Test result: Not required

6.4. Channel Availability Check (CAC)

6.4.1. Channel Availability Check Limit

Channel Availability Check Limit
<p><input checked="" type="checkbox"/>The EUT shall perform a Channel Availability Check to ensure that there is no radar operating on the channel. After power-up sequence, receive at least 1 minute (60 sec) on the intended operating frequency.</p>

6.4.2. Measuring Instruments

Refer a test equipment and calibration data table in this test report

6.4.3. Test Procedures

Test Method
<p><input checked="" type="checkbox"/>Refer as KDB905462 D02 UNII DFS Compliance Procedures New Rules v02, clause 7.8.2.1 for Initial Channel Availability Check Time. The EUT does not emit beacon, control, or data signals on the test Channel until the power-up sequence has been completed and the UNII device checks for Radar Waveforms for one minute on the test Channel. This test does not use any Radar Waveforms.</p>
<p><input checked="" type="checkbox"/>Refer as FCC 06-96 Appendix, clause 7.8.2.2 for Radar Burst at the Beginning of the Channel Availability Check Time. To verify successful radar detection on the selected Channel during a period equal to the Beginning of the Channel Availability Check Time.</p>
<p><input checked="" type="checkbox"/>Refer as FCC 06-96 Appendix, clause 7.8.2.3 for Radar Burst at the End of the Channel Availability Check Time. To verify successful radar detection on the selected Channel during a period equal to the End of the Channel Availability Check Time.</p>

Test result: Not required

6.5. In-service Monitoring

6.5.1. In-service Monitoring Limit

In-service Monitoring Limit	
Channel Move Time	10 sec
Channel Closing Transmission Time	200 ms + an aggregate of 60 ms over remaining 10 sec periods.
Non-occupancy period	Minimum 30 minutes

6.5.2. Measuring Instruments

Refer a test equipment and calibration data table in this test report

6.5.3. Test Procedures

Test Method
<p><input checked="" type="checkbox"/> Refer as KDB905462 D02 UNII DFS Compliance Procedures New Rules v02, clause 7.8.3 verified during In-Service Monitoring; Channel Closing Transmission Time, Channel Move Time. Client Device will associate with the EUT. Observe the transmissions of the EUT at the end of the radar Burst on the Operating Channel for duration greater than 10 seconds. Measure and record the transmissions from the EUT during the observation time (Channel Move Time). Compare the Channel Move Time and Channel Closing Transmission Time limits.</p>
<p><input checked="" type="checkbox"/> Refer as KDB905462 D02 UNII DFS Compliance Procedures New Rules v02, clause 8.3 verified during In-Service Monitoring; Channel Closing Transmission Time, Channel Move Time. One 10 sec plot needs to be reported for the Short Pulse Radar Types 1-4 and one for the Long Pulse Radar Type in a 22 sec plot. And zoom-in a 600 ms plot verified channel closing time for the aggregate transmission time starting from 200ms after the end of the radar signal to the completion of the channel move.</p>
<p><input checked="" type="checkbox"/> Refer as KDB905462 D02 UNII DFS Compliance Procedures New Rules v02, clause 7.8.3 verified during In-Service Monitoring; Non-Occupancy Period. Client Device will associate with the EUT. Observe the transmissions of the EUT at the end of the radar Burst on the Operating Channel for duration greater than 10 seconds. Measure and record the transmissions from the EUT during the observation time (Non-Occupancy Period). Compare the Non-Occupancy Period limits.</p>

6.5.4. Test Result of In-service Monitoring

Channel Closing Transmission Time and Channel Move Time Result

Modulation Mode	Freq. (MHz)	Radar Type	Channel Closing Transmission Time		Channel Move Time	
			Result(ms)	Limit (ms)	Result(S)	Limit (S)
acVHT80	5290	0	208.4	<260	0.776	<10

Note: Dwell(1.2ms)=Sweep time(12000ms)/Sweep point bins(10000)
 Channel Closing Transmission Time(200+8.4)=200 + Number(7) x Dwell(1.2ms) < 260

12 sec Timing Plot

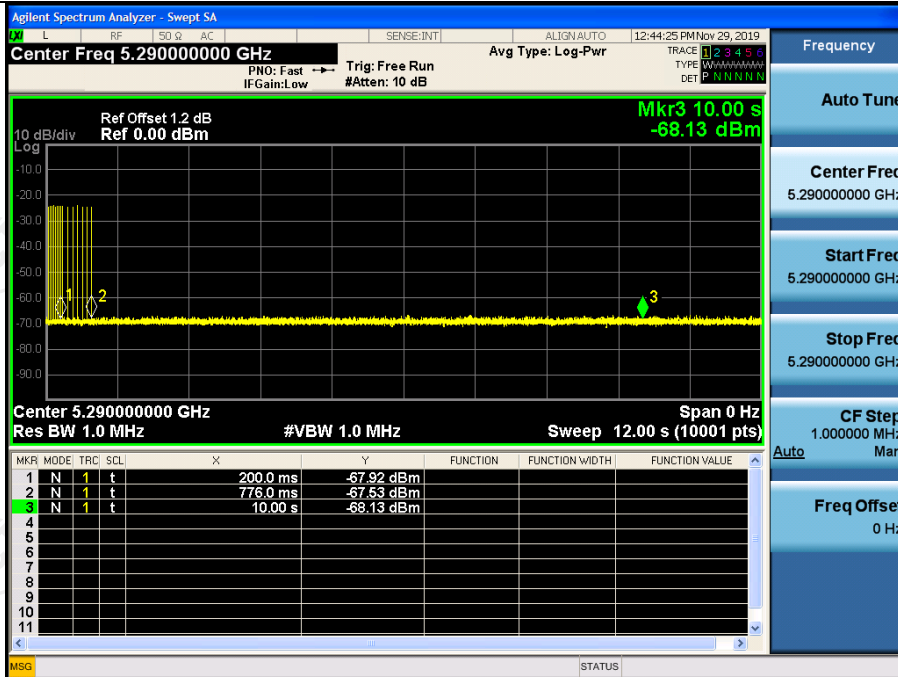

Non-Occupancy Period Result

Modulation Mode	Freq. (MHz)	Non-Occupancy Period		
		Measured	Limit	Result
acVHT80	5290	>30min	30min	Complied

2000 sec Timing Plot

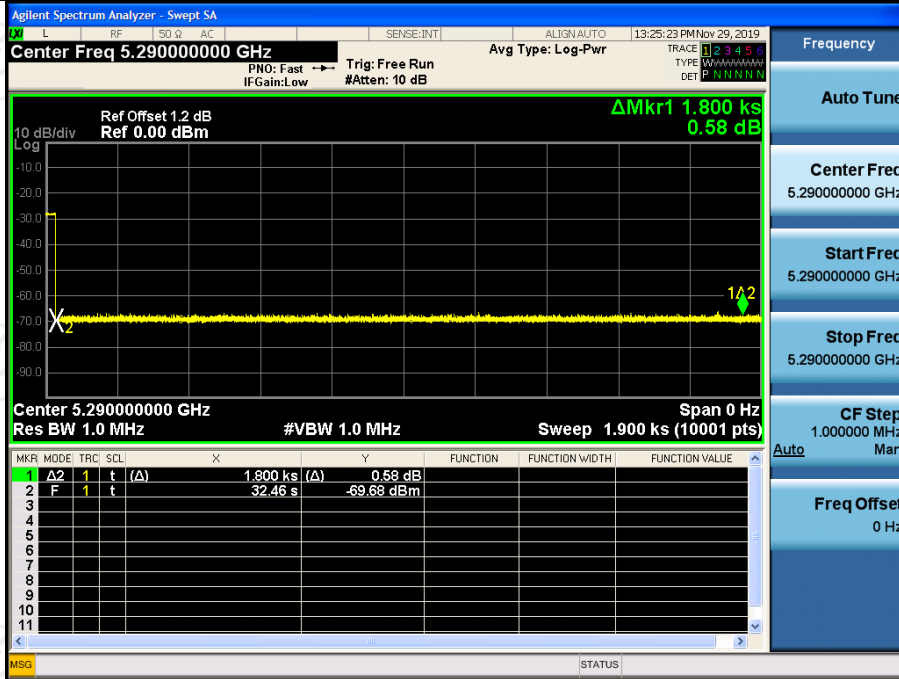

Channel Closing Transmission Time and Channel Move Time Result

Modulation Mode	Freq. (MHz)	Radar Type	Channel Closing Transmission Time		Channel Move Time	
			Result	Limit	Result	Limit
acVHT80	5530	0	216.8	<260ms	844.5ms	<10s

Note: Dwell(1.2ms)=Sweep time(12000ms)/Sweep point bins(10000)
 Channel Closing Transmission Time(200+16.8) = 200 + Number(14) x Dwell(1.2ms) < 260

Channel Closing Transmission Time & Channel Move Time

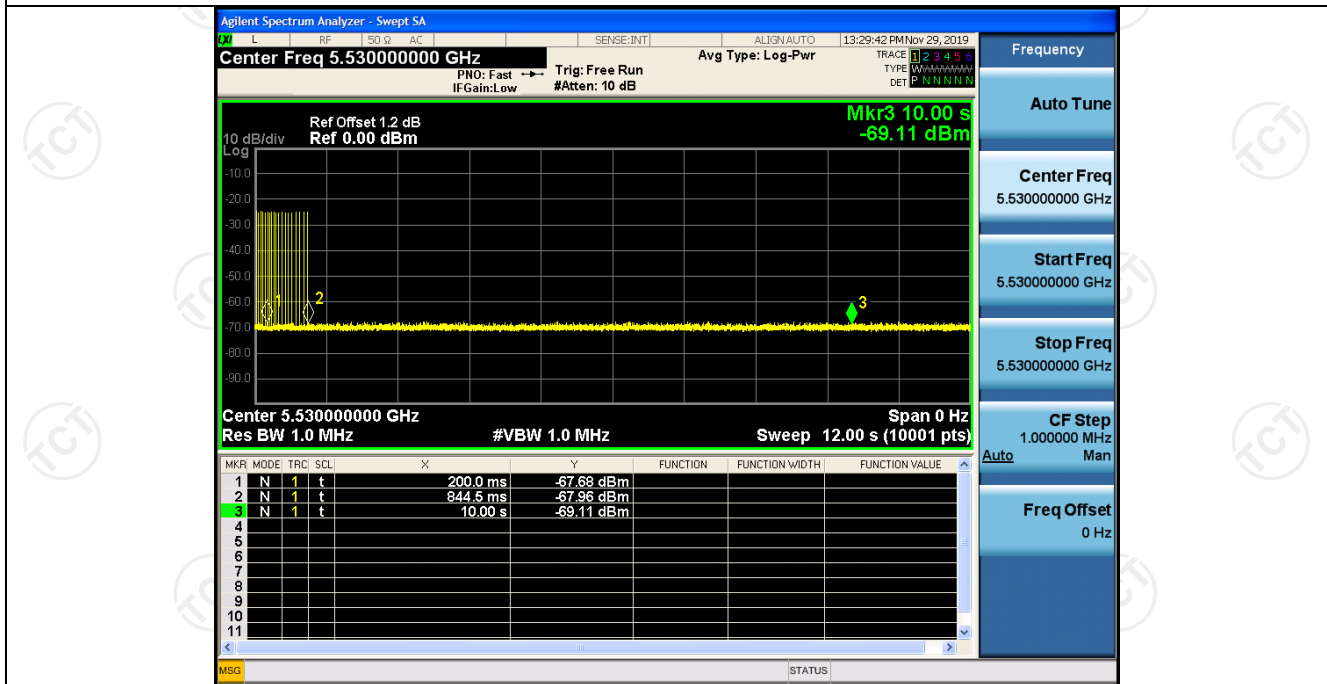

Non-Occupancy Period Result

Modulation Mode	Freq. (MHz)	Non-Occupancy Period		
		Measured	Limit	Result
acVHT80	5530	>30min	30min	Complied

2000 sec Timing Plot

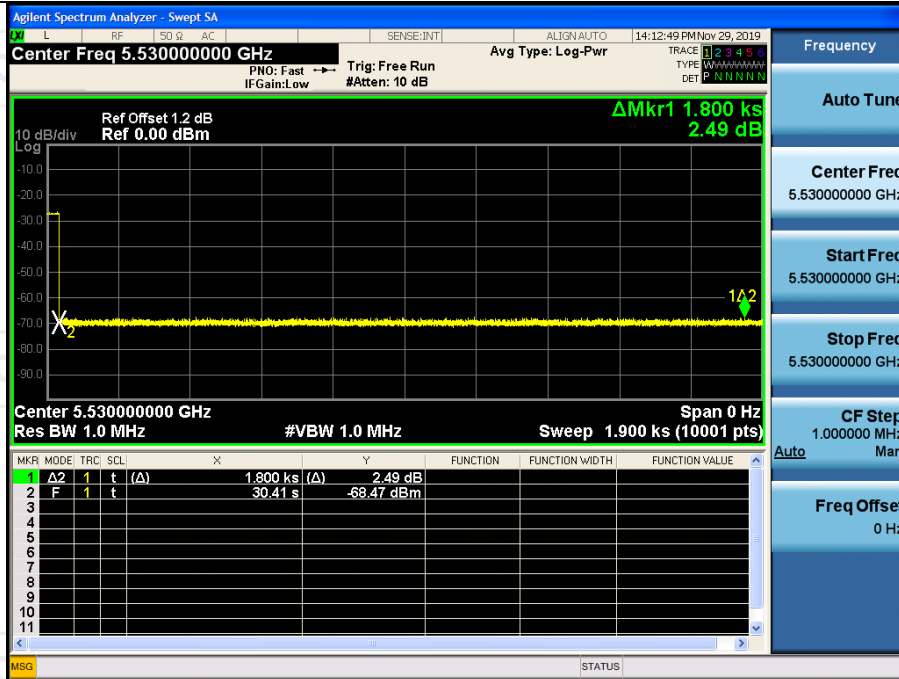

6.6. Statistical Performance Check

6.6.1. Statistical Performance Check Limit

Radar Type	Minimum Percentage of Successful Detection (Pd)	Minimum Trials
1	60%	30
2	60%	30
3	60%	30
4	60%	30
Aggregate (Radar Types 1-4)	80%	120
5	80%	30
6	70%	30

The percentage of successful detection is calculated by:

$$\frac{\text{Total Waveform Detections}}{\text{Total Waveform Trails}} \times 100 = \text{Probability of Detection Radar Waveform}$$

In addition an aggregate minimum percentage of successful detection across all Short Pulse Radar Types 1-4 is required and is calculated as follows:

$$\frac{\text{Pd1} + \text{Pd2} + \text{Pd3} + \text{Pd4}}{4}$$

6.6.2. Measuring Instruments

Refer a test equipment and calibration data table in this test report

6.6.3. Test Procedures

Test Method
<p><input checked="" type="checkbox"/> Refer as KDB905462 D02 UNII DFS Compliance Procedures New Rules v02, clause 7.8.4 for Statistical Performance Check test. Stream the MPEG test file from the Master Device to the Client Device on the test Channel for the entire period of the test. Observe the transmissions of the UUT at the end of the Burst on the Operating Channel for duration greater than 10 seconds for Short Pulse Radar Types 1-4 and 6 to ensure detection occurs. Then Observe the transmissions of the UUT at the end of the Burst on the Operating Channel for duration greater than 22 seconds for Long Pulse Radar Type 5 to ensure detection occurs. The device can utilize a test mode to demonstrate when detection occurs to prevent the need to reset the device between trial runs.</p>

6.6.4. Test Result

Statistical Performance Check Result – VHT20/5260					
Radar Signal (#)	Test Trail #	Detect Trail #	Pd (%)	Limit Pd (%)	Result
1	30	28	93.33	60	Complied
2	30	30	100.00	60	Complied
3	30	29	96.67	60	Complied
4	30	27	90.00	60	Complied
Aggregate 1 - 4	120	115	95.83	80	Complied
5	30	30	100.00	80	Complied
6	30	29	96.67	70	Complied

Statistical Performance Check Result – VHT20/5500					
Radar Signal (#)	Test Trail #	Detect Trail #	Pd (%)	Limit Pd (%)	Result
1	30	28	93.33	60	Complied
2	30	30	100.00	60	Complied
3	30	30	100.00	60	Complied
4	30	28	93.33	60	Complied
Aggregate 1 - 4	120	116	96.67	80	Complied
5	30	28	93.33	80	Complied
6	30	30	100.00	70	Complied

Statistical Performance Check Result – VHT40/5270					
Radar Signal (#)	Test Trail #	Detect Trail #	Pd (%)	Limit Pd (%)	Result
1	30	28	93.33	60	Complied
2	30	30	100.00	60	Complied
3	30	30	100.00	60	Complied
4	30	30	100.00	60	Complied
Aggregate 1 - 4	120	114	95.00	80	Complied
5	30	30	100.00	80	Complied
6	30	27	90.00	70	Complied

Statistical Performance Check Result – VHT40/5510

Radar Signal (#)	Test Trail #	Detect Trail #	Pd (%)	Limit Pd (%)	Result
1	30	30	100.00	60	Complied
2	30	28	93.33	60	Complied
3	30	29	96.67	60	Complied
4	30	30	100.00	60	Complied
Aggregate 1 - 4	120	116	96.67	80	Complied
5	30	28	93.33	80	Complied
6	30	30	100.00	70	Complied

Statistical Performance Check Result – VHT80/5290

Radar Signal (#)	Test Trail #	Detect Trail #	Pd (%)	Limit Pd (%)	Result
1	30	29	96.67	60	Complied
2	30	30	100.00	60	Complied
3	30	29	96.67	60	Complied
4	30	30	100.00	60	Complied
Aggregate 1 - 4	120	117	97.50	80	Complied
5	30	30	100.00	80	Complied
6	30	29	96.67	70	Complied

Statistical Performance Check Result – VHT80/5530

Radar Signal (#)	Test Trail #	Detect Trail #	Pd (%)	Limit Pd (%)	Result
1	30	30	100.00	60	Complied
2	30	28	93.33	60	Complied
3	30	30	100.00	60	Complied
4	30	28	93.33	60	Complied
Aggregate 1 - 4	120	115	95.83	80	Complied
5	30	29	96.67	80	Complied
6	30	28	93.33	70	Complied

Appendix A: Photographs of Test Setup

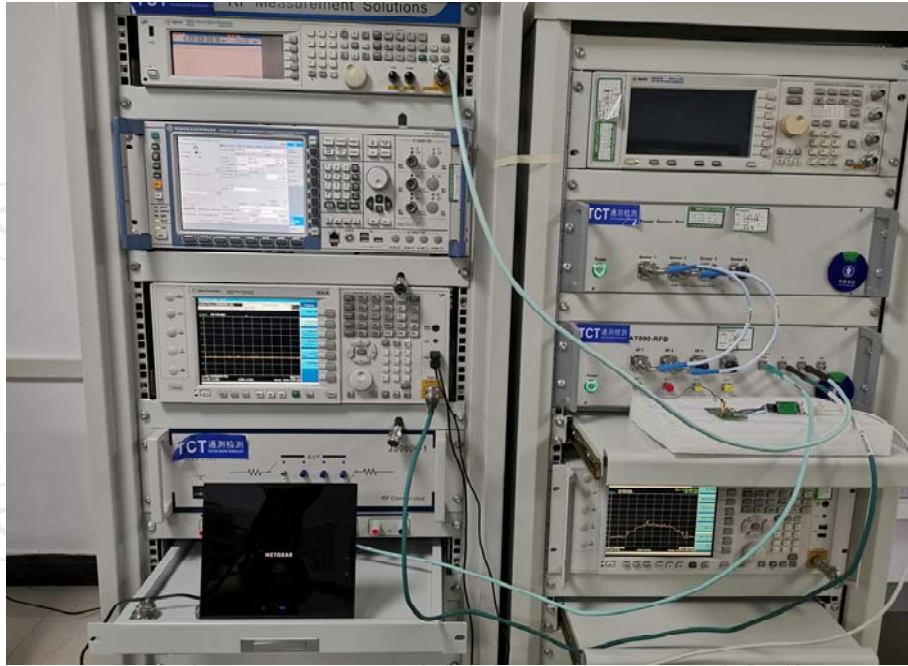

*******END OF REPORT*******