

Sichuan AI-Link Technology Co., Ltd.

RF TEST REPORT

Report Type:

FCC Part 15.247 & ISED RSS-247 RF report

Model:

WF-M620-RSD2

REPORT NUMBER:

210401186SHA-001

ISSUE DATE:

May 26, 2021

DOCUMENT CONTROL NUMBER:

TTRF15.247-03_V1 © 2018 Intertek



Applicant: Sichuan AI-Link Technology Co., Ltd.
Anzhou, Industrial park, Mianyang, Sichuan, China

Manufacturer: Sichuan AI-Link Technology Co., Ltd.
Anzhou, Industrial park, Mianyang, Sichuan, China

Product Name: WIFI Module

Type/Model: WF-M620-RSD2

FCC ID: 2AOKI-WFM620RSD2

IC: 23460-WFM620RSD2

SUMMARY:

The equipment complies with the requirements according to the following standard(s) or Specification:

47CFR Part 15 (2019): Radio Frequency Devices (Subpart C)

ANSI C63.10 (2013): American National Standard of Procedures for Compliance Testing of Unlicensed Wireless Devices

RSS-247 Issue 2 (February 2017): Digital Transmission Systems (DTSs), Frequency Hopping Systems (FHSs) and Licence-Exempt Local Area Network (LE-LAN) Devices

RSS-Gen Issue 5 (February 2021) Amendment 2: General Requirements for Compliance of Radio Apparatus

PREPARED BY:

REVIEWED BY:



Project Engineer
Dylan Tang



Reviewer
Daniel Zhao

This report is for the exclusive use of Intertek's Client and is provided pursuant to the agreement between Intertek and its Client. Intertek's responsibility and liability are limited to the terms and conditions of the agreement. Intertek assumes no liability to any party, other than to the Client in accordance with the agreement, for any loss, expense or damage occasioned by the use of this report. Only the Client is authorized to permit copying or distribution of this report and then only in its entirety. Any use of the Intertek name or one of its marks for the sale or advertisement of the tested material, product or service must first be approved in writing by Intertek. The observations and test results in this report are relevant only to the sample tested. This report by itself does not imply that the material, product, or service is or has ever been under an Intertek certification program.

TEST REPORT

Content

REVISION HISTORY..... 5

MEASUREMENT RESULT SUMMARY 6

1 GENERAL INFORMATION 7

1.1 DESCRIPTION OF EQUIPMENT UNDER TEST (EUT) 7

1.2 TECHNICAL SPECIFICATION 7

1.3 ANTENNA INFORMATION..... 8

1.4 DESCRIPTION OF TEST FACILITY 8

2 TEST SPECIFICATIONS..... 9

2.1 STANDARDS OR SPECIFICATION 9

2.2 MODE OF OPERATION DURING THE TEST..... 9

2.3 TEST SOFTWARE LIST 10

2.4 TEST PERIPHERALS LIST 10

2.5 TEST ENVIRONMENT CONDITION:..... 10

2.6 INSTRUMENT LIST 11

2.7 MEASUREMENT UNCERTAINTY 12

3 MINIMUM 6DB BANDWIDTH..... 13

3.1 LIMIT 13

3.2 MEASUREMENT PROCEDURE 13

3.3 TEST CONFIGURATION 13

3.4 TEST RESULTS OF MINIMUM 6DB BANDWIDTH 13

4 MAXIMUM CONDUCTED OUTPUT POWER AND E.I.R.P..... 14

4.1 LIMIT 14

4.2 MEASUREMENT PROCEDURE 14

4.3 TEST CONFIGURATION 15

4.4 TEST RESULTS OF MAXIMUM CONDUCTED OUTPUT POWER..... 15

5 POWER SPECTRUM DENSITY 16

5.1 LIMIT 16

5.2 MEASUREMENT PROCEDURE 16

5.3 TEST CONFIGURATION 17

5.4 TEST RESULTS OF POWER SPECTRUM DENSITY 17

6 EMISSION OUTSIDE THE FREQUENCY BAND 18

6.1 LIMIT 18

6.2 MEASUREMENT PROCEDURE 18

6.3 TEST CONFIGURATION 19

6.4 THE RESULTS OF EMISSION OUTSIDE THE FREQUENCY BAND..... 19

7 RADIATED EMISSIONS IN RESTRICTED FREQUENCY BANDS..... 20

7.1 LIMIT 20

7.2 MEASUREMENT PROCEDURE 20

7.3 TEST CONFIGURATION 22

7.4 TEST RESULTS OF RADIATED EMISSIONS 24

8 POWER LINE CONDUCTED EMISSION..... 28

8.1 LIMIT 28

8.2 TEST CONFIGURATION 28

8.3 MEASUREMENT PROCEDURE 29

TEST REPORT

8.4	TEST RESULTS OF POWER LINE CONDUCTED EMISSION.....	30
9	OCCUPIED BANDWIDTH	32
9.1	LIMIT	32
9.2	MEASUREMENT PROCEDURE	32
9.3	TEST CONFIGURATION	32
9.4	THE RESULTS OF OCCUPIED BANDWIDTH	32
10	ANTENNA REQUIREMENT	33

Revision History

Report No.	Version	Description	Issued Date
210401186SHA-001	Rev. 01	Initial issue of report	May 26, 2021

Measurement result summary

TEST ITEM	FCC REFERANCE	IC REFERANCE	RESULT
Minimum 6dB Bandwidth	15.247(a)(2)	RSS-247 Issue 2 Clause 5.2	Pass
Maximum conducted output power and e.i.r.p.	15.247(b)(3)	RSS-247 Issue 2 Clause 5.4	Pass
Power spectrum density	15.247(e)	RSS-247 Issue 2 Clause 5.2	Pass
Emission outside the frequency band	15.247(d)	RSS-247 Issue 2 Clause 5.5	Pass
Radiated Emissions in restricted frequency bands	15.247(d), 15.205&15.209	RSS-Gen Issue 5 Clause 8.9&8.10	Pass
Power line conducted emission	15.207(a)	RSS-Gen Issue 5 Clause 8.8	Pass
Occupied bandwidth	-	RSS-Gen Issue 5 Clause 6.6	Tested
Antenna requirement	15.203	-	Pass

Notes: 1: NA =Not Applicable

2. Determination of the test conclusion is based on IEC Guide 115 in consideration of measurement uncertainty.

3: Additions, Deviations and Exclusions from Standards: None.

TEST REPORT

1 GENERAL INFORMATION

1.1 Description of Equipment Under Test (EUT)

Product name:	WIFI Module
Type/Model:	WF-M620-RSD2
Description of EUT:	The EUT is a WIFI module which supports 802.11a/b/g/n mode.
Rating:	DC 3.3V
EUT type:	<input checked="" type="checkbox"/> Table top <input type="checkbox"/> Floor standing
Sample number:	6023A4EBA33A
Software Version:	MT3620_eFuse_N9_V5_20180321_24G_5G_NoDPDT_20200528
Hardware Version:	JUI7.820.0713
Sample received date:	April 25, 2021
Date of test:	April 28, 2021 ~ May 25, 2021

1.2 Technical Specification

Frequency Band:	2400MHz ~ 2483.5MHz
Support Standards:	IEEE 802.11b, IEEE 802.11g, IEEE 802.11n(HT20)
Type of Modulation:	IEEE 802.11b: DSSS (CCK, DQPSK, DBPSK) IEEE 802.11g: OFDM (64-QAM, 16-QAM, QPSK, BPSK) IEEE 802.11n(HT20): OFDM (64-QAM, 16-QAM, QPSK, BPSK)
Operating Frequency:	2412MHz to 2462MHz for IEEE 802.11b/g/n(HT20)
Channel Number:	11 Channels for 802.11b, 802.11g and 802.11n(HT20)
Channel Separation:	5 MHz

TEST REPORT

1.3 Antenna information

No.	Antenna Type	Gain	Note
1	dipole Antenna	4.51dBi	External type

Mode	Tx/Rx Function	Beamforming function	CDD function	Directional gain (dBi)
802.11b	1Tx/1Rx	NO	NO	-
802.11g	1Tx/1Rx	NO	NO	-
802.11n(HT20)	1Tx/1Rx	NO	NO	-

Note: For 802.11b and 802.11g mode, it only supports 1TX.
 For 802.11n modes, it can support 2TX, all the two transmit signals are completely uncorrelated with each other, so the directional gain = $10 \log ((10^{G1/10} + 10^{G2/10} + \dots + 10^{Gn/10}) / N_{ANT})$

1.4 Description of Test Facility

Name:	Intertek Testing Services Shanghai
Address:	Building 86, No. 1198 Qinzhou Road(North), Shanghai 200233, P.R. China
Telephone:	86 21 61278200
Telefax:	86 21 54262353

The test facility is recognized, certified, or accredited by these organizations:	CNAS Accreditation Lab Registration No. CNAS L0139
	FCC Accredited Lab Designation Number: CN1175
	IC Registration Lab CAB identifier.: CN0051
	VCCI Registration Lab Registration No.: R-14243, G-10845, C-14723, T-12252
	A2LA Accreditation Lab Certificate Number: 3309.02

TEST REPORT
2 TEST SPECIFICATIONS
2.1 Standards or specification

47CFR Part 15 (2019)
 ANSI C63.10 (2013)
 KDB 662911 D01 (v02r01)
 KDB 558074 (v05r02)
 RSS-247 Issue 2 (February 2017)
 RSS-Gen Issue 5 (February 2021) Amendment 2

2.2 Mode of operation during the test

While testing transmitting mode of EUT, the internal modulation and continuously transmission was applied.

Software name	Manufacturer	Version	Supplied by
cmd	Windows	-	Client

The lowest, middle and highest channel were tested as representatives.

Frequency Band (MHz)	Mode	Lowest (MHz)	Middle (MHz)	Highest (MHz)
2400-2483.5	802.11b	2412	2437	2462
	802.11g	2412	2437	2462
	802.11n(HT20)	2412	2437	2462

Data rate and Power setting:

The pre-scan for the conducted power with all rates in each modulation and bands was used, and the worst case was found and used in all test cases. After this pre-scan, we choose the following table of the data rata as the worst case.

Frequency Band (MHz)	Mode	Worst case data rate
2400-2483.5	802.11b	1Mbps
	802.11g	6Mbps
	802.11n(HT20)	MCS0

TEST REPORT

2.3 Test software list

Test Items	Software	Manufacturer	Version
Conducted emission	ESxS-K1	R&S	V2.1.0
Radiated emission	ES-K1	R&S	V1.71

2.4 Test peripherals list

Item No.	Name	Band and Model	Description
1	Laptop computer	DELL 5480	-
2	RF cable	/	0.2m length; 0.8dB loss
3	M620-RSD1	/	test fixture
4	Micro USB	/	

2.5 Test environment condition:

Test items	Temperature	Humidity
Minimum 6dB Bandwidth	18°C	51%RH
Maximum conducted output power and e.i.r.p.		
Power spectrum density		
Emission outside the frequency band		
Occupied bandwidth		
Radiated Emissions in restricted frequency bands	19°C	52%RH
Power line conducted emission	19°C	52%RH

TEST REPORT

2.6 Instrument list

Conducted Emission					
Used	Equipment	Manufacturer	Type	Internal no.	Due date
<input checked="" type="checkbox"/>	Test Receiver	R&S	ESCS 30	EC 2107	2021-07-14
<input checked="" type="checkbox"/>	A.M.N.	R&S	ESH2-Z5	EC 3119	2021-11-09
Radiated Emission					
Used	Equipment	Manufacturer	Type	Internal no.	Due date
<input checked="" type="checkbox"/>	Test Receiver	Keysight	N9030B	EC 6078	2022-6-10
<input checked="" type="checkbox"/>	Bilog Antenna	TESEQ	CBL 6112D	EC 4206	2021-09-25
<input checked="" type="checkbox"/>	Horn antenna	R&S	HF 906	EC 3049	2022-01-16
<input checked="" type="checkbox"/>	Horn antenna	ETS	3117	EC 4792-1	2022-03-14
<input checked="" type="checkbox"/>	Horn antenna	ETS	3116C	EC 5955	2022-01-17
<input checked="" type="checkbox"/>	Pre-amplifier	R&S	Pre-amp 18	EC5262	2021-06-11
<input checked="" type="checkbox"/>	Semi-anechoic chamber	Albatross project	-	EC 3048	2021-07-14
RF test					
Used	Equipment	Manufacturer	Type	Internal no.	Due date
<input checked="" type="checkbox"/>	PXA Signal Analyzer	Keysight	N9030A	EC 5338	2022-03-15
<input checked="" type="checkbox"/>	PXA Signal Analyzer	Keysight	N9030B	EC 6078	2022-06-09
<input checked="" type="checkbox"/>	Power sensor	Agilent	U2021XA	EC 5338-1	2022-03-15
<input checked="" type="checkbox"/>	Vector Signal Generator	Agilent	N5182B	EC 5175	2022-03-15
<input checked="" type="checkbox"/>	MXG Analog Signal Generator	Agilent	N5181A	EC 5338-2	2022-03-15
<input checked="" type="checkbox"/>	Test Receiver	R&S	ESCI 7	EC 4501	2021-09-16
<input type="checkbox"/>	Universal Radio Communication Tester	R&S	CMW500	EC5944	2021-12-09
<input type="checkbox"/>	Universal Radio Communication Tester	R&S	CMW500	Ec6209	2021-12-30
<input checked="" type="checkbox"/>	Signal generator	Agilent	N5182A	Ec6172	2021-08-21
<input checked="" type="checkbox"/>	Signal generator	Agilent	N5181A	Ec6171	2021-08-21
<input checked="" type="checkbox"/>	Climate chamber	GWS	MT3065	EC 6021	2022-03-04
Additional instrument					
Used	Equipment	Manufacturer	Type	Internal no.	Due date
<input checked="" type="checkbox"/>	Therom-Hygrograph	ZJ1-2A	S.M.I.F.	EC 3783	2022-03-04
<input checked="" type="checkbox"/>	Pressure meter	YM3	Shanghai Mengde	EC 4620	2021-09-09

TEST REPORT**2.7 Measurement uncertainty**

The measurement uncertainty represents an expanded uncertainty expressed at approximately the 95% confidence level using a coverage factor of k=2.

Test item	Measurement uncertainty
Maximum peak output power	$\pm 0.74\text{dB}$
Radiated Emissions in restricted frequency bands below 1GHz	$\pm 4.90\text{dB}$
Radiated Emissions in restricted frequency bands above 1GHz	$\pm 5.02\text{dB}$
Emission outside the frequency band	$\pm 2.89\text{dB}$
Power line conducted emission	$\pm 3.19\text{dB}$

TEST REPORT**3 Minimum 6dB bandwidth****Test result: Pass****3.1 Limit**

For systems using digital modulation techniques that may operate in the 902 - 928 MHz, 2400 - 2483.5 MHz and 5725 - 5850 MHz bands, the minimum 6 dB bandwidth shall be at least 500 kHz.

3.2 Measurement Procedure

The EUT was tested according to Subclause 11.8 of ANSI C63.10.

- a) Set RBW = 100 kHz.
- b) Set the video bandwidth (VBW) $\geq 3 \times$ RBW.
- c) Detector = Peak.
- d) Trace mode = max hold.
- e) Sweep = auto couple.
- f) Allow the trace to stabilize.
- g) Measure the maximum width of the emission that is constrained by the frequencies associated with the two outermost amplitude points (upper and lower frequencies) that are attenuated by 6 dB relative to the maximum level measured in the fundamental emission.

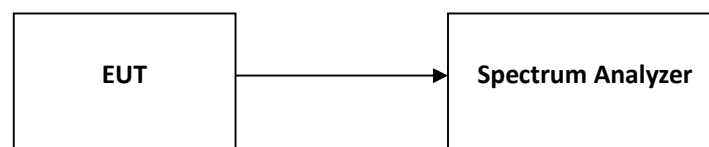
3.3 Test Configuration**3.4 Test Results of Minimum 6dB bandwidth**

Please refer to Appendix A

4 Maximum conducted output power and e.i.r.p.

Test result: Pass

4.1 Limit

For systems using digital modulation in the 902-928 MHz, 2400-2483.5 MHz, and 5725-5850 MHz bands: 1 W. (The e.i.r.p. shall not exceed 4 W)

If the transmitting antenna of directional gain greater than 6dBi is used, the power shall be reduced by the amount in dB that the directional gain of the antenna exceeds 6dBi. If there have a beam forming type, the limit should be the minimum of 30dBm and 30+ (6 –antenna gain-beam forming gain).

4.2 Measurement Procedure

The EUT was tested according to Subclause 11.9.2.2 of ANSI C63.10.

- a) Measure the duty cycle, x , of the transmitter output signal as described in Section 6.0.
- b) Set span to at least $1.5 \times \text{OBW}$.
- c) Set RBW = 1 % to 5 % of the OBW, not to exceed 1 MHz.
- d) Set VBW $\geq 3 \times \text{RBW}$.
- e) Number of points in sweep $\geq 2 \times \text{span} / \text{RBW}$. (This gives bin-to-bin spacing $\leq \text{RBW}/2$, so that narrowband signals are not lost between frequency bins.)
- f) Sweep time = auto.
- g) Detector = RMS (i.e., power averaging), if available. Otherwise, use sample detector mode.
- h) Do not use sweep triggering. Allow the sweep to “free run”.
- i) Trace average at least 100 traces in power averaging (i.e., RMS) mode; however, the number of traces to be averaged shall be increased above 100 as needed such that the average accurately represents the true average over the on and off periods of the transmitter.
- j) Compute power by integrating the spectrum across the OBW of the signal using the instrument’s band power measurement function with band limits set equal to the OBW band edges. If the instrument does not have a band power function, sum the spectrum levels (in power units) at intervals equal to the RBW extending across the entire OBW of the spectrum.
- k) Add $10 \log (1/x)$, where x is the duty cycle, to the measured power in order to compute the average power during the actual transmission times (because the measurement represents an average over both the on- and off-times of the transmission). For example, add $10 \log (1/0.25) = 6 \text{ dB}$ if the duty cycle is 25 %.

4.3 Test Configuration

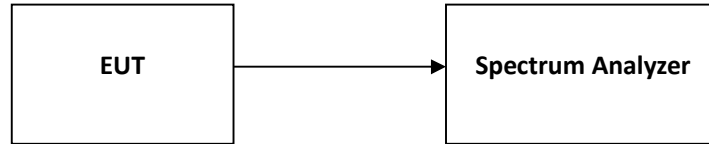

4.4 Test Results of Maximum conducted output power

Please refer to Appendix A

TEST REPORT**5 Power spectrum density****Test result: Pass****5.1 Limit**

For digitally modulated systems, the power spectral density conducted from the intentional radiator to the antenna shall not be greater than 8dBm in any 3 kHz band during any time interval of continuous transmission.

If the transmitting antenna of directional gain greater than 6dBi is used, the power shall be reduced by the amount in dB that the directional gain of the antenna exceeds 6dBi. If there have a beam forming type, the limit should be the minimum of 8dBm/MHz and 8+ (6 –antenna gain-beam forming gain).

5.2 Measurement Procedure

The EUT was tested according to Subclause 11.10 of ANSI C63.10.

This procedure is applicable when the EUT cannot be configured to transmit continuously (i.e., duty cycle < 98 %), and when sweep triggering/signal gating cannot be used to measure only when the EUT is transmitting at its maximum power control level, and when the transmission duty cycle is constant (i.e., duty cycle variations are less than ± 2 %):

- a) Measure the duty cycle (x) of the transmitter output signal as described in Section 6.0.
- b) Set instrument center frequency to DTS channel center frequency.
- c) Set span to at least $1.5 \times \text{OBW}$.
- d) Set RBW to: $3 \text{ kHz} \leq \text{RBW} \leq 100 \text{ kHz}$.
- e) Set VBW $\geq 3 \times \text{RBW}$.
- f) Detector = power averaging (RMS) or sample detector (when RMS not available).
- g) Ensure that the number of measurement points in the sweep $\geq 2 \times \text{span}/\text{RBW}$.
- h) Sweep time = auto couple.
- i) Do not use sweep triggering. Allow sweep to “free run”.
- j) Employ trace averaging (RMS) mode over a minimum of 100 traces.
- k) Use the peak marker function to determine the maximum amplitude level.
- l) Add $10 \log (1/x)$, where x is the duty cycle measured in step (a), to the measured PSD to compute the average PSD during the actual transmission time.
- m) If resultant value exceeds the limit, then reduce RBW (no less than 3 kHz) and repeat (note that this may require zooming in on the emission of interest and reducing the span in order to meet the minimum measurement point requirement as the RBW is reduced).

5.3 Test Configuration



5.4 Test Results of Power spectrum density

Please refer to Appendix A

TEST REPORT

6 Emission outside the frequency band

Test result: Pass

6.1 Limit

In any 100 kHz bandwidth outside the frequency band in which the spread spectrum intentional radiator is operating, the radio frequency power that is produced by the intentional radiator shall be at least 30 dB below that in the 100 kHz bandwidth within the band that contains the highest level of the desired power.

6.2 Measurement Procedure

The EUT was tested according to Subclause 11.11 of ANSI C63.10.

Reference level measurement

Establish a reference level by using the following procedure:

- a) Set instrument center frequency to DTS channel center frequency.
- b) Set the span to ≥ 1.5 times the DTS bandwidth.
- c) Set the RBW = 100 kHz.
- d) Set the VBW $\geq 3 \times$ RBW.
- e) Detector = peak.
- f) Sweep time = auto couple.
- g) Trace mode = max hold.
- h) Allow trace to fully stabilize.
- i) Use the peak marker function to determine the maximum PSD level.

Emission level measurement

- a) Set the center frequency and span to encompass frequency range to be measured.
- b) Set the RBW = 100 kHz.
- c) Set the VBW $\geq 3 \times$ RBW.
- d) Detector = peak.
- e) Sweep time = auto couple.
- f) Trace mode = max hold.
- g) Allow trace to fully stabilize.
- h) Use the peak marker function to determine the maximum amplitude level.

Ensure that the amplitude of all unwanted emissions outside of the authorized frequency band (excluding restricted frequency bands) are attenuated by at least the minimum requirements specified in 11.1 a) or 11.1 b). Report the three highest emissions relative to the limit.

6.3 Test Configuration

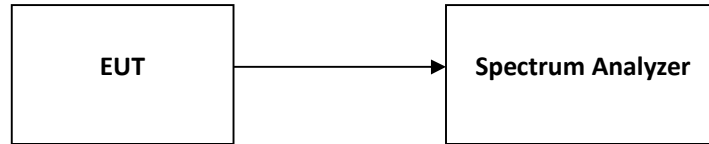

6.4 The results of Emission outside the frequency band

Please refer to Appendix A

7 Radiated Emissions in restricted frequency bands

Test result: Pass

7.1 Limit

The radiated emissions which fall in the restricted bands, must also comply with the radiated emission limits specified showed as below:

Frequencies (MHz)	Field Strength (microvolts/meter)	Measurement Distance (meters)
0.009 ~ 0.490	2400/F(kHz)	300
0.490 ~ 1.705	24000/F(kHz)	30
1.705 ~ 30.0	30	30
30 ~ 88	100	3
88 ~ 216	150	3
216 ~ 960	200	3
Above 960	500	3

7.2 Measurement Procedure

The EUT was tested according to Subclause 11.12 of ANSI C63.10.

For Radiated emission below 30MHz:

- a) The EUT was placed on the top of a rotating table 0.8 meters above the ground at a 3 meters chamber room. The table was rotated 360 degrees to determine the position of the highest radiation.
- b) The EUT was set 3 meters away from the interference-receiving antenna, which was mounted on the top of a variable-height antenna tower.
- c) Both X and Y axes of the antenna are set to make the measurement.
- d) For each suspected emission, the EUT was arranged to its worst case and the rotatable table was turned from 0 degrees to 360 degrees to find the maximum reading.
- e) The test-receiver system was set to Quasi-Peak Detect Function and Specified Bandwidth with Maximum Hold Mode.

NOTE:

1. The resolution bandwidth and video bandwidth of test receiver/spectrum analyzer is 9kHz at frequency below 30MHz.

TEST REPORT**For Radiated emission above 30MHz:**

- a) The EUT was placed on the top of a rotating table 0.8 meters (for 30MHz ~ 1GHz) / 1.5 meters (for above 1GHz) above the ground at 3 meters chamber room for test. The table was rotated 360 degrees to determine the position of the highest radiation.
- b) The EUT was set 3 meters away from the interference-receiving antenna, which was mounted on the top of a variable-height antenna tower.
- c) The height of antenna is varied from one meter to four meters above the ground to determine the maximum value of the field strength. Both horizontal and vertical polarizations of the antenna are set to make the measurement.
- d) For each suspected emission, the EUT was arranged to its worst case and then the antenna was tuned to heights from 1 meter to 4 meters and the rotatable table was turned from 0 degrees to 360 degrees to find the maximum reading.
- e) The test-receiver system was set to quasi-peak detect function and specified bandwidth with maximum hold mode when the test frequency is below 1 GHz.
- f) The test-receiver system was set to peak and average detector function and specified bandwidth with maximum hold mode when the test frequency is above 1 GHz. If the peak reading value also meets average limit, measurement with the average detector is unnecessary.

Note:

1. The resolution bandwidth and video bandwidth of test receiver/spectrum analyzer is 120kHz for Quasi-peak detection (QP) at frequency below 1GHz.
2. The resolution bandwidth of test receiver/spectrum analyzer is 1 MHz and the video bandwidth is 3 MHz for Peak detection (PK) at frequency above 1GHz.
3. The resolution bandwidth of test receiver/spectrum analyzer is 1 MHz and the video bandwidth is $\geq 1/T$ (Duty cycle < 98%) or $3 \times \text{RBW}$ (Duty cycle $\geq 98\%$) for Average detection (AV) at frequency above 1GHz.
4. All modes of operation were investigated and the worst-case emissions were reported.

7.3 Test Configuration

For Radiated emission below 30MHz:

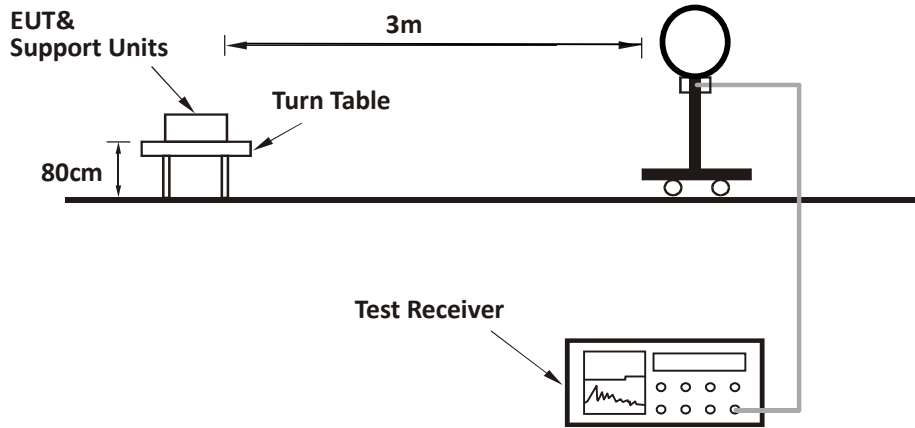

For Radiated emission 30MHz to 1GHz:

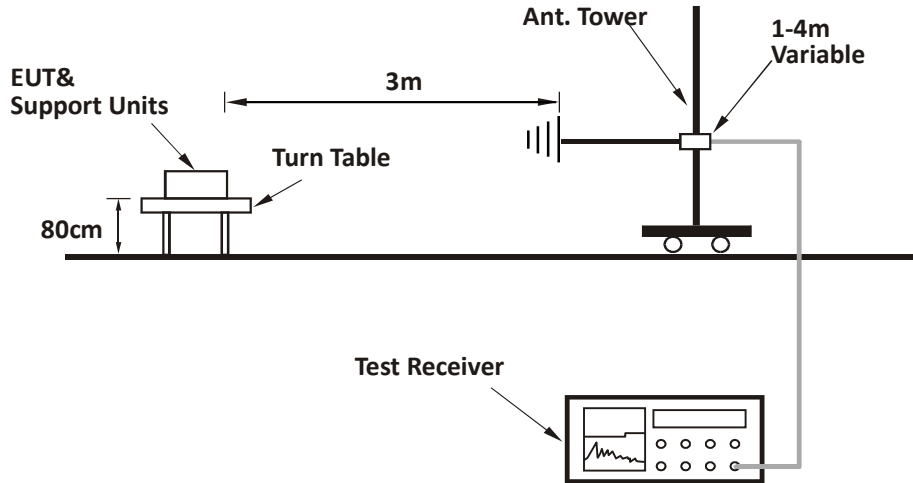

TEST REPORT

For Radiated emission above 1GHz:

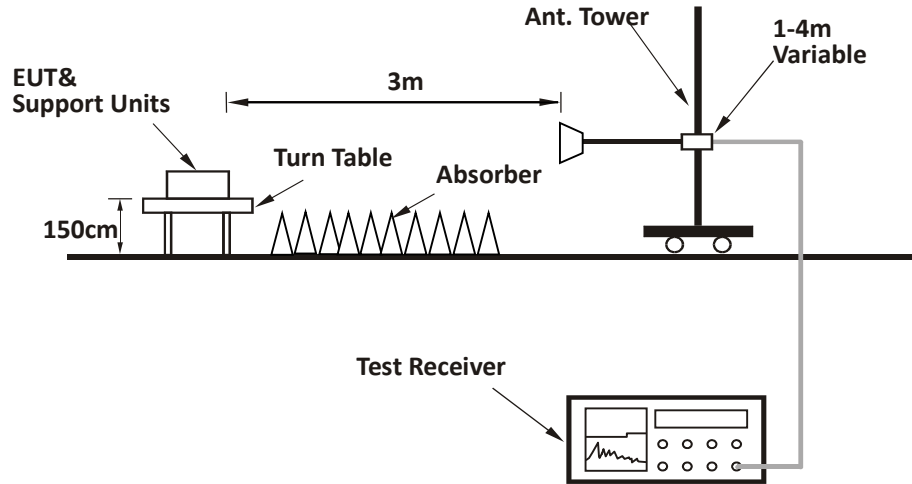

TEST REPORT

7.4 Test Results of Radiated Emissions

The low frequency, which started from 9 kHz to 30MHz, was pre-scanned and the result which was 20dB lower than the limit line per 15.31(o) was not reported.

Horizontal

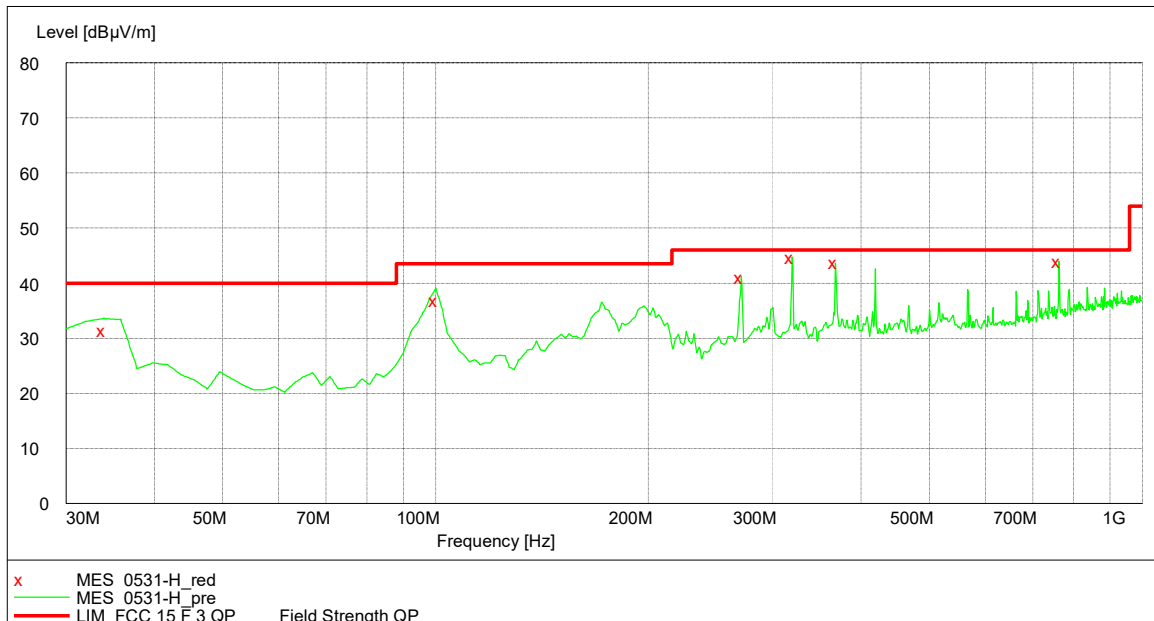

Vertical

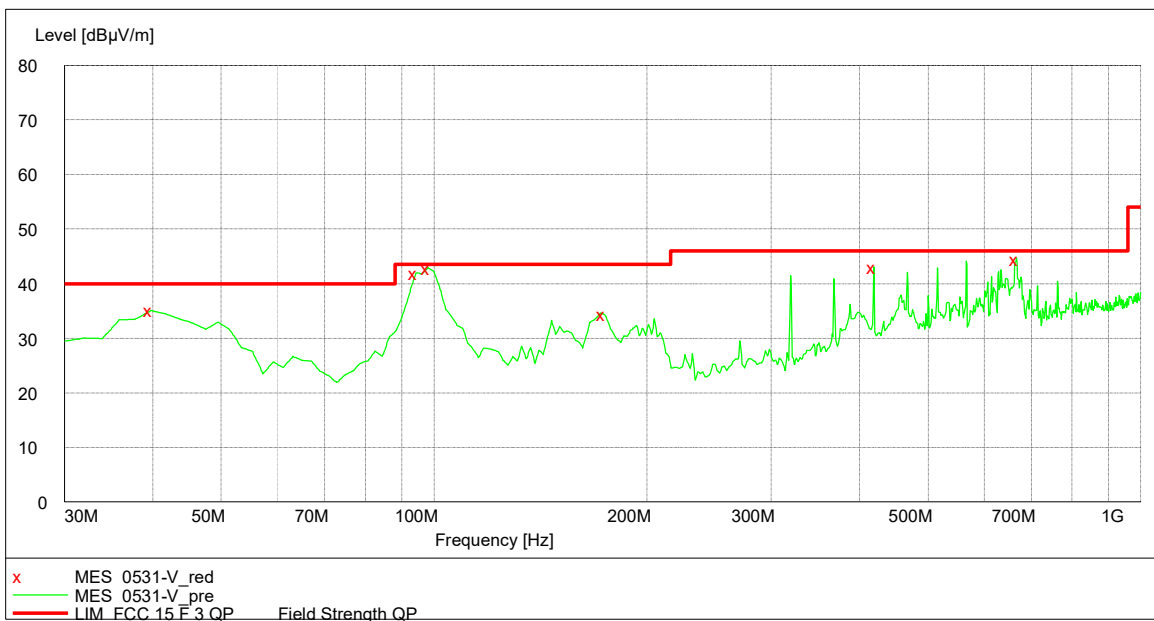

TEST REPORT
Test data below 1GHz

Antenna	Frequency (MHz)	Corrected Reading (dBuV/m)	Correct Factor (dB/m)	Limit (dBuV/m)	Margin (dB)	Detector
H	33.88	31.60	16.90	40.00	8.4	QP
H	99.97	37.10	18.20	43.50	6.4	QP
H	271.04	41.20	20.70	46.0	4.8	QP
H	319.63	44.80	21.40	46.0	1.2	QP
H	762.84	43.90	21.80	46.0	2.1	QP
H	478.64	44.00	28.60	46.0	2	QP
V	39.71	35.10	19.80	40.00	4.9	QP
V	94.14	41.90	17.00	43.50	1.6	QP
V	98.03	42.90	17.80	43.50	0.6	QP
V	173.84	34.40	17.10	43.50	9.1	QP
V	418.78	43.10	23.80	46.00	2.9	QP
V	667.59	44.60	27.60	46.00	1.4	QP

TEST REPORT

Test result above 1GHz:

The emission was conducted from 1GHz to 25GHz

802.11b

CH	Antenna	Frequency (MHz)	Measure Level (dBuV/m)	Reading Level (dBuV)	Over Limit (dB)	Limit (dBuV/m)	Factor (dB)	Type
L	H	2390.00	46.76	28.57	-27.24	74.00	31.20	PK
	V	2390.00	68.84	28.57	-5.16	74.00	31.20	PK
	V	2390.00	52.76	21.15	-1.24	54.00	31.20	AV
	H	4824.00	50.78	46.66	-23.22	74.00	2.70	PK
	V	4824.00	49.55	45.94	-24.45	74.00	2.70	PK
M	H	4874.00	52.05	47.74	-21.95	74.00	2.68	AV
	V	4874.00	50.19	48.92	-23.81	74.00	2.68	AV
H	H	2483.50	48.18	25.22	-25.82	74.00	31.19	PK
	V	2483.50	64.33	25.22	-9.67	74.00	31.19	PK
	V	2483.50	53.37	18.25	-0.63	54.00	31.19	AV
	H	4924.00	50.90	46.65	-23.10	74.00	2.77	PK
	V	4924.00	48.50	45.78	-25.50	74.00	2.77	PK

802.11g

CH	Antenna	Frequency (MHz)	Measure Level (dBuV/m)	Reading Level (dBuV)	Over Limit (dB)	Limit (dBuV/m)	Factor (dB)	Type
L	H	2390.00	53.99	30.23	-20.01	74.00	31.20	PK
	V	2390.00	70.26	30.23	-3.74	74.00	31.20	PK
	V	2390.00	53.03	21.14	-0.97	54.00	31.20	AV
	H	4824.00	51.25	46.84	-22.75	74.00	2.70	PK
	V	4824.00	49.55	46.73	-24.45	74.00	2.70	PK
M	H	4874.00	52.09	43.63	-1.91	54.00	2.68	AV
	V	4874.00	50.15	44.75	-3.85	54.00	2.68	AV
	H	7326.00	53.55	37.35	-20.45	74.00	7.99	PK
	V	7326.00	51.15	38.75	-22.85	74.00	7.99	PK

TEST REPORT

H	H	2483.50	64.16	29.36	-9.84	74.00	31.19	PK
	H	2483.50	52.15	19.24	-1.85	54.00	31.19	AV
	V	2483.50	72.34	29.36	-1.66	74.00	31.19	PK
	V	2483.50	53.27	19.24	-0.73	54.00	31.19	AV
	H	4924.00	50.70	45.66	-23.30	74.00	2.77	PK
	V	4924.00	58.50	45.74	-15.50	74.00	2.77	PK

802.11n(HT20)

CH	Antenna	Frequency (MHz)	Measure Level (dBuV/m)	Reading Level (dBuV)	Over Limit (dB)	Limit (dBuV/m)	Factor (dB)	Type
L	H	2390.00	49.89	32.43	-24.11	74.00	-0.29	PK
	V	2390.00	70.80	32.43	-3.20	74.00	-0.29	PK
	V	2390.00	50.88	21.32	-3.12	54.00	-1.46	AV
	H	4824.00	50.45	44.72	-23.55	74.00	-23.88	PK
	V	4824.00	48.80	45.92	-25.20	74.00	-25.45	PK
M	H	4874.00	50.55	46.64	-3.45	54.00	-3.73	AV
	V	4874.00	49.25	47.80	-4.75	54.00	-4.99	AV
H	H	2483.50	50.74	31.17	-23.26	74.00	-3.74	PK
	V	2483.50	70.23	31.17	-3.77	74.00	-3.74	PK
	V	2483.50	50.60	21.48	-3.40	54.00	-3.12	AV
	H	4924.00	49.75	44.37	-24.25	74.00	-24.23	PK
	V	4924.00	48.50	45.58	-25.50	74.00	-25.88	PK

- Remark: 1. Correct Factor = Antenna Factor + Cable Loss (+ Amplifier, for higher than 1GHz), the value was added to Original Receiver Reading by the software automatically.
 2. Corrected Reading = Original Receiver Reading + Correct Factor
 3. Margin = Limit - Corrected Reading
 4. If the PK Corrected Reading is lower than AV limit, the AV test can be elided.

Example: Assuming Antenna Factor = 30.20dB/m, Cable Loss = 2.00dB,
 Gain of Preamplifier = 32.00dB, Original Receiver Reading = 10.00dBuV,
 Limit = 40.00dBuV/m.
 Then Correct Factor = 30.20 + 2.00 – 32.00 = 0.20dB/m;
 Corrected Reading = 10dBuV + 0.20dB/m = 10.20dBuV/m;
 Margin = 40.00dBuV/m - 10.20dBuV/m = 29.80dB.

TEST REPORT

8 Power line conducted emission

Test result: Pass

8.1 Limit

Frequency of Emission (MHz)	Conducted Limit (dBuV)	
	QP	AV
0.15-0.5	66 to 56*	56 to 46 *
0.5-5	56	46
5-30	60	50

* Decreases with the logarithm of the frequency.

8.2 Test Configuration

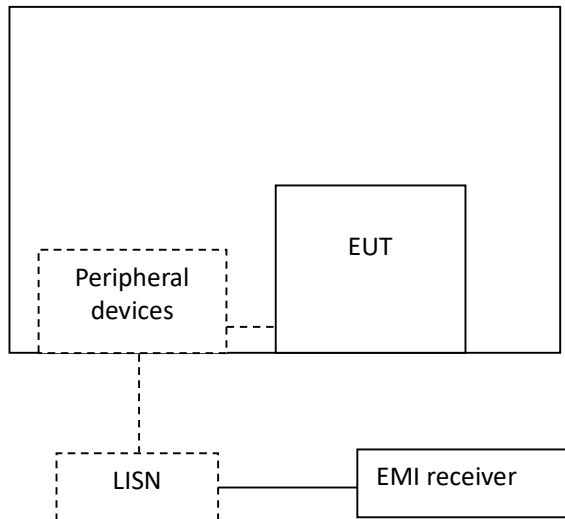

TEST REPORT**8.3 Measurement Procedure**

Measured levels of ac power-line conducted emission shall be the emission voltages from the voltage probe, where permitted, or across the 50 Ω LISN port (to which the EUT is connected), where permitted, terminated into a 50 Ω measuring instrument. All emission voltage and current measurements shall be made on each current-carrying conductor at the plug end of the EUT power cord by the use of mating plugs and receptacles on the LISN, if used. Equipment shall be tested with power cords that are normally supplied or recommended by the manufacturer and that have electrical and shielding characteristics that are the same as those cords normally supplied or recommended by the manufacturer. For those measurements using a LISN, the 50 Ω measuring port is terminated by a measuring instrument having 50 Ω input impedance. All other ports are terminated in 50 Ω loads.

Tabletop devices shall be placed on a platform of nominal size 1 m by 1.5 m, raised 80 cm above the reference ground plane. The vertical conducting plane or wall of an RF-shielded (screened) room shall be located 40 cm to the rear of the EUT. Floor-standing devices shall be placed either directly on the reference ground-plane or on insulating material as described in ANSI C63.4. All other surfaces of tabletop or floor-standing EUTs shall be at least 80 cm from any other grounded conducting surface, including the case or cases of one or more LISNs.

The bandwidth of the test receiver is set at 9 kHz.

TEST REPORT

8.4 Test Results of Power line conducted emission

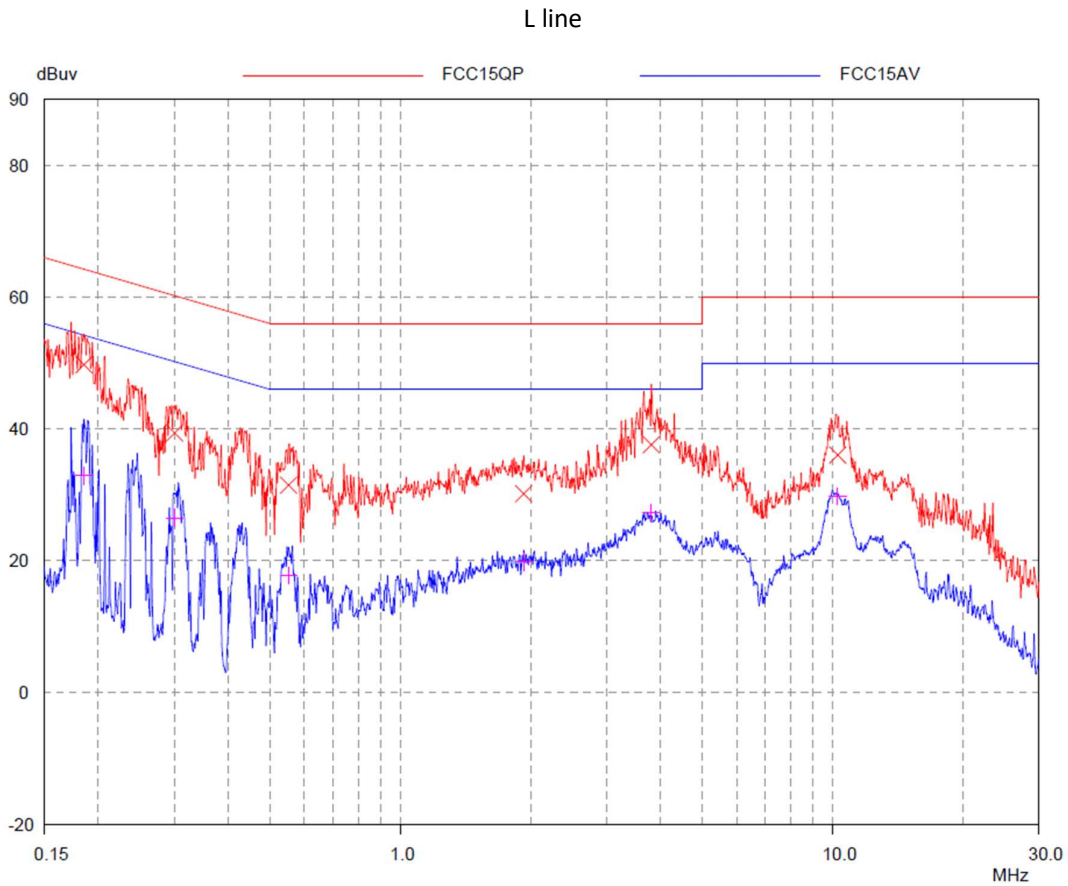

Test Data:

Frequency (MHz)	Quasi-peak			Average		
	level dB(μV)	Limit dB(μV)	Margin (dB)	level dB(μV)	limit dB(μV)	Margin (dB)
0.185	49.77	64.24	14.47	32.94	54.24	21.30
0.300	39.41	60.23	20.82	26.52	50.23	23.71
0.551	31.48	56.00	24.52	17.75	46.00	28.25
1.930	30.19	56.00	25.81	19.86	46.00	26.14
3.805	37.62	56.00	18.38	27.25	46.00	18.75
10.282	36.07	60.00	23.93	29.80	50.00	20.20

TEST REPORT

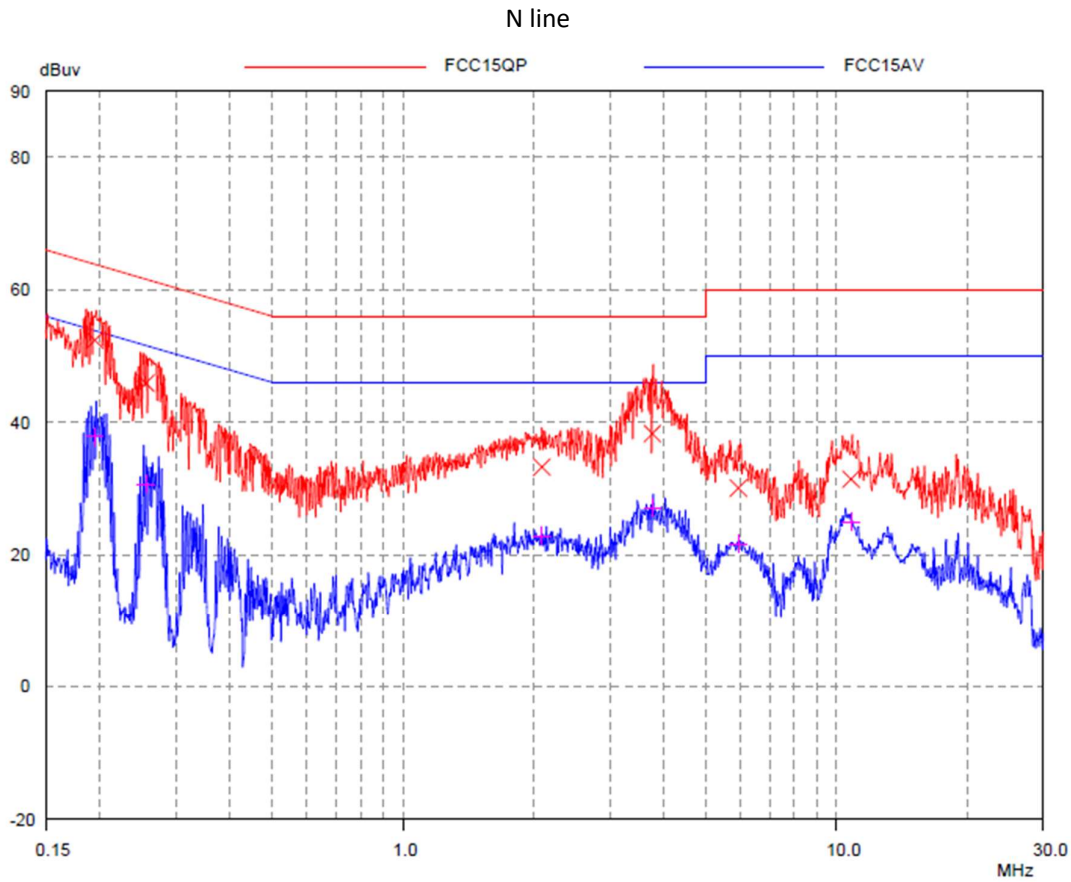

Test Data:

Frequency (MHz)	Quasi-peak			Average		
	level dB(μV)	Limit dB(μV)	Margin (dB)	level dB(μV)	limit dB(μV)	Margin (dB)
0.194	52.39	63.85	11.46	37.84	53.85	16.01
0.255	45.88	61.59	15.71	30.66	51.59	20.93
2.090	33.24	56.00	22.76	22.81	46.00	23.19
3.760	38.30	56.00	17.70	27.09	46.00	18.91
5.927	30.04	60.00	29.96	21.64	50.00	28.36
10.786	31.41	60.00	28.59	24.96	50.00	25.04

Remark: 1. Correct Factor = LISN Factor + Cable Loss, the value was added to Original Receiver Reading by the software automatically.

2. Corrected Reading = Original Receiver Reading + Correct Factor

3. Margin = Limit - Corrected Reading

4. If the PK Corrected Reading is lower than AV limit, the AV test can be elided.

TEST REPORT**9 Occupied Bandwidth****Test result: Tested****9.1 Limit**

None

9.2 Measurement Procedure

The occupied bandwidth per RSS-Gen Issue 4 Clause 6.6 was measured using the Spectrum Analyzer.

The span of the analyzer shall be set to capture all products of the modulation process, including the emission skirts.

The resolution bandwidth (RBW) shall be in the range of 1% to 5% of the occupied bandwidth (OBW) and video bandwidth (VBW) shall be approximately 3x RBW.

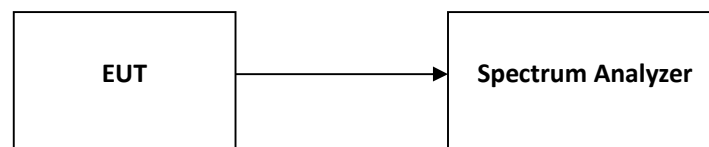
9.3 Test Configuration**9.4 The results of Occupied Bandwidth**

Please refer to Appendix A

10 Antenna requirement

Requirement:

An intentional radiator shall be designed to ensure that no antenna other than that furnished by the responsible party shall be used with the device. The use of a permanently attached antenna or of an antenna that uses a unique coupling to the intentional radiator shall be considered sufficient to comply with the provisions of this section.

Result:

EUT users a unique coupling to the intentional radiator, so it can comply with the provisions of this section.

***** END *****