

**FCC 47 CFR PART 15 SUBPART C**  
**CERTIFICATION TEST REPORT**

*For*

Wireless module

MODEL No.: WF-M603-UWC1

FCC ID: 2AOKI-WFM603UWC1

Trade Mark: N/A

REPORT NO: ES190702029W

ISSUE DATE: July 19, 2019

Prepared for

Sichuan AI-Link Technology Co.,Ltd.

Anzhou, Industrial park, Mianyang, Sichuan, China

*Prepared by*

EMTEK(SHENZHEN) CO., LTD.  
Bldg 69, Majialong Industry Zone, Nanshan District,  
Shenzhen, Guangdong, China  
TEL: 86-755-26954280  
FAX: 86-755-26954282

## TABLE OF CONTENTS

<b>1</b>	<b>TEST RESULT CERTIFICATION</b> .....	<b>3</b>
<b>2</b>	<b>EUT TECHNICAL DESCRIPTION</b> .....	<b>4</b>
<b>3</b>	<b>SUMMARY OF TEST RESULT</b> .....	<b>5</b>
<b>4</b>	<b>TEST METHODOLOGY</b> .....	<b>6</b>
4.1	GENERAL DESCRIPTION OF APPLIED STANDARDS .....	6
4.2	MEASUREMENT EQUIPMENT USED .....	6
4.3	DESCRIPTION OF TEST MODES.....	7
<b>5</b>	<b>FACILITIES AND ACCREDITATIONS</b> .....	<b>8</b>
5.1	FACILITIES .....	8
5.2	LABORATORY ACCREDITATIONS AND LISTINGS .....	8
<b>6</b>	<b>TEST SYSTEM UNCERTAINTY</b> .....	<b>9</b>
<b>7</b>	<b>SETUP OF EQUIPMENT UNDER TEST</b> .....	<b>10</b>
7.1	RADIO FREQUENCY TEST SETUP 1 .....	10
7.2	RADIO FREQUENCY TEST SETUP 2.....	10
7.3	CONDUCTED EMISSION TEST SETUP .....	11
7.4	BLOCK DIAGRAM CONFIGURATION OF TEST SYSTEM .....	12
7.5	SUPPORT EQUIPMENT.....	12
<b>8</b>	<b>TEST REQUIREMENTS</b> .....	<b>13</b>
8.1	DTS(6DB)BANDWIDTH.....	13
8.2	MAXIMUM PEAK CONDUCTED OUTPUT POWER .....	20
8.3	MAXIMUM POWER SPECTRAL DENSITY .....	21
8.4	UNWANTED EMISSIONS IN NON-RESTRICTED FREQUENCY BANDS .....	34
8.5	RADIATED SPURIOUS EMISSION .....	39
8.6	CONDUCTED EMISSIONS TEST .....	51
8.7	ANTENNA APPLICATION.....	54

## 1 TEST RESULT CERTIFICATION

Applicant : Sichuan AI-Link Technology Co., Ltd.  
 Address : Anzhou, Industrial park, Mianyang, Sichuan, China  
 Manufacturer : Sichuan AI-Link Technology Co., Ltd.  
 Address : Anzhou, Industrial park, Mianyang, Sichuan, China  
 EUT : Wireless module  
 Model Name : WF-M603-UWC1  
 Trademark : N/A

Measurement Procedure Used:

APPLICABLE STANDARDS	
STANDARD	TEST RESULT
FCC 47 CFR Part 2 , Subpart J FCC 47 CFR Part 15 , Subpart C	PASS

The above equipment was tested by EMTEK (SHENZHEN) CO., LTD. The test data, data evaluation, test procedures, and equipment configurations shown in this report were made in accordance with the procedures given in ANSI C63.10 (2013) and the energy emitted by the sample EUT tested as described in this report is in compliance with the requirements of FCC Rules Part 2 and Part 15.247

The test results of this report relate only to the tested sample identified in this report.

Date of Test : July 06, 2019 to July 18, 2019

Prepared by :   
Sewen Guo /Editor

Reviewer :   
Joe Xia/Editor

Approve & Authorized Signer :   
Lisa Wang/Manager



## 2 EUT TECHNICAL DESCRIPTION

Characteristics	Description
<b>IEEE 802.11 WLAN Mode Supported</b>	<input checked="" type="checkbox"/> 802.11b <input checked="" type="checkbox"/> 802.11g <input checked="" type="checkbox"/> 802.11n(20MHz channel bandwidth) <input checked="" type="checkbox"/> 802.11n(40MHz channel bandwidth)
<b>Data Rate</b>	802.11 b:1,2,5.5,11Mbps; 802.11 g:6,9,12,18,24,36,48,54Mbps; 802.11n(HT20): 6.5M,13M,19.5M,26M,39M,52M,58.5M,65M; 802.11n(HT40): 13.5M,27M,40.5M,54M,81M,108M,121.5M,135M;
<b>Modulation</b>	DSSS with DBPSK/DQPSK/CCK for 802.11b; OFDM with BPSK/QPSK/16QAM/64QAM for 802.11g/n;
<b>Operating Frequency Range</b>	2412-2462MHz for 802.11b/g/n(HT20); 2422-2452MHz for 802.11n(HT40);
<b>Number of Channels</b>	11 channels for 802.11b/g n(HT20); 7 Channels for 802.11n(HT40);
<b>Transmit Power Max</b>	Ant 1: 21.49 dBm Ant 2: 20.89 dBm MIMO: 24.15 dBm
<b>Smart system</b>	<input checked="" type="checkbox"/> SISO for 802.11 b/g/n(HT20)/n(HT40) <input checked="" type="checkbox"/> MIMO for 802.11 n(HT20)/n(HT40)
<b>Antenna Type</b>	Metal Antenna
<b>Antenna Gain</b>	Ant 1: 2 dBi Ant 2: 2 dBi
<b>Direction Gain</b>	5.01 dBi
<b>Power supply</b>	DC 3.3V
<b>Temperature Range</b>	-10°C ~ +55°C

**Note:** for more details, please refer to the User's manual of the EUT.

### 3 SUMMARY OF TEST RESULT

FCC PartClause	Test Parameter	Verdict	Remark
15.247(a)(2)	DTS (6dB) Bandwidth	PASS	
15.247(b)(3)	Maximum Peak Conducted Output Power	PASS	
15.247(e)	Maximum Power Spectral Density Level	PASS	
15.247(d)	Unwanted Emission Into Non-Restricted Frequency Bands	PASS	
15.247(d) 15.209	Unwanted Emission Into Restricted Frequency Bands (conducted)	PASS	
15.247(d) 15.209	Radiated Spurious Emission	PASS	
15.207	Conducted Emission Test	PASS	
15.247(b)	Antenna Application	PASS	
	NOTE1:N/A (Not Applicable) NOTE2: According to FCC OET KDB 558074, the report use radiated measurements in the restricted frequency bands. In addition, the radiated test is also performed to ensure the emissions emanating from the device cabinet also comply with the applicable limits.		

RELATED SUBMITTAL(S) / GRANT(S):

This submittal(s) (test report) is intended for FCC ID: 2AOKI-WFM603UWC1 filing to comply with Section 15.247 of the FCC Part 15, Subpart C Rules.

## 4 TEST METHODOLOGY

### 4.1 GENERAL DESCRIPTION OF APPLIED STANDARDS

According to its specifications, the EUT must comply with the requirements of the following standards:

FCC 47 CFR Part 2, Subpart J

FCC 47 CFR Part 15, Subpart C

FCC KDB 558074 D01 15.247 Meas Guidance v05r02

FCC KDB 662911 D01 Multiple Transmitter Output v02r01

### 4.2 MEASUREMENT EQUIPMENT USED

#### 4.2.1 Conducted Emission Test Equipment

EQUIPMENT TYPE	MFR	MODEL NUMBER	SERIAL NUMBER	LASTCAL.	DUE CAL.
Test Receiver	Rohde & Schwarz	ESCS30	828985/018	05/19/2019	05/18/2020
L.I.S.N.	Schwarzbeck	NNLK8129	8129203	05/19/2019	05/18/2020
50Ω Coaxial Switch	Anritsu	MP59B	M20531	05/19/2019	05/18/2020
Pulse Limiter	Rohde & Schwarz	ESH3-Z2	100006	05/19/2019	05/18/2020
Voltage Probe	Rohde & Schwarz	TK9416	N/A	05/19/2019	05/18/2020
I.S.N	Rohde & Schwarz	ENY22	1109.9508.02	05/19/2019	05/18/2020

#### 4.2.2 Radiated Emission Test Equipment

EQUIPMENT TYPE	MFR	MODEL NUMBER	SERIAL NUMBER	LAST CAL.	DUE CAL.
EMI Test Receiver	Rohde & Schwarz	ESU	1302.6005.26	05/19/2019	05/18/2020
Pre-Amplifier	HP	8447D	2944A07999	05/19/2019	05/18/2020
Bilog Antenna	Schwarzbeck	VULB9163	142	05/19/2019	05/18/2020
Loop Antenna	ARA	PLA-1030/B	1029	05/19/2019	05/18/2020
Horn Antenna	Schwarzbeck	BBHA 9170	BBHA9170399	05/19/2019	05/18/2020
Horn Antenna	Schwarzbeck	BBHA 9120	D143	05/19/2019	05/18/2020
Cable	Schwarzbeck	AK9513	ACRX1	05/19/2019	05/18/2020
Cable	Rosenberger	N/A	FP2RX2	05/19/2019	05/18/2020
Cable	Schwarzbeck	AK9513	CRPX1	05/19/2019	05/18/2020
Cable	Schwarzbeck	AK9513	CRRX2	05/19/2019	05/18/2020

#### 4.2.3 Radio Frequency Test Equipment

EQUIPMENT TYPE	MFR	MODEL NUMBER	SERIAL NUMBER	LASTCAL.	DUE CAL.
Spectrum Analyzer	Agilent	E4407B	88156318	05/19/2019	05/18/2020
Signal Analyzer	Agilent	N9010A	My53470879	05/19/2019	05/18/2020
Power meter	Anritsu	ML2495A	0824006	05/19/2019	05/18/2020
Power sensor	Anritsu	MA2411B	0738172	05/19/2019	05/18/2020

**Remark:** Each piece of equipment is scheduled for calibration once a year.

### 4.3 DESCRIPTION OF TEST MODES

The EUT has been tested under its typical operating condition.

The EUT configuration for testing is installed on RF field strength measurement to meet the Commissions requirement and operating in a manner which intends to maximize its emission characteristics in a continuous normal application.

The Transmitter was operated in the normal operating mode. The TX frequency was fixed which was for the purpose of the measurements.

Test of channel included the lowest and middle and highest frequency to perform the test, then record on this report.

Those data rates (802.11b: 1 Mbps; 802.11g: 6 Mbps; 802.11n (HT20)/ 802.11n (HT40): MCS0 were used for all test.

Pre-defined engineering program for regulatory testing used to control the EUT for staying in continuous transmitting and receiving mode is programmed.

Frequency and Channel list for 802.11 b/g/n (HT20):

Channel	Frequency (MHz)	Channel	Frequency (MHz)	Channel	Frequency (MHz)
1	2412	5	2432	9	2452
2	2417	6	2437	10	2457
3	2422	7	2442	11	2462
4	2427	8	2447		

Frequency and Channel list for 802.11n (HT40):

Channel	Frequency (MHz)	Channel	Frequency (MHz)	Channel	Frequency (MHz)
3	2422	6	2437	9	2452
4	2427	7	2442		
5	2432	8	2447		

Test Frequency and Channel for 802.11 b/g/n (HT20):

Lowest Frequency		Middle Frequency		Highest Frequency	
Channel	Frequency (MHz)	Channel	Frequency (MHz)	Channel	Frequency (MHz)
1	2412	6	2437	11	2462

Test Frequency and channel for 802.11n (HT40):

Lowest Frequency		Middle Frequency		Highest Frequency	
Channel	Frequency (MHz)	Channel	Frequency (MHz)	Channel	Frequency (MHz)
3	2422	6	2437	9	2452

## 5 FACILITIES AND ACCREDITATIONS

### 5.1 FACILITIES

All measurement facilities used to collect the measurement data are located at

Bldg 69, Majialong Industry Zone District, Nanshan District, Shenzhen, China

The sites are constructed in conformance with the requirements of ANSI C63.7, ANSI C63.10 and CISPR Publication 22.

### 5.2 LABORATORY ACCREDITATIONS AND LISTINGS

#### Site Description

EMC Lab. : Accredited by CNAS, 2018.11.30  
The certificate is valid until 2022.10.28  
The Laboratory has been assessed and proved to be in compliance with CNAS-CL01:2006 (identical to ISO/IEC 17025:2017)  
The Certificate Registration Number is L2291.

Accredited by TUV Rheinland Shenzhen 2018.03.30  
The Laboratory has been assessed according to the requirements ISO/IEC 17025.

Accredited by FCC, August 08, 2018  
Designation Number: CN1204  
Test Firm Registration Number: 882943  
Accredited by A2LA, August 31, 2020  
The Certificate Registration Number is 4321.01.

Accredited by Industry Canada, November 09, 2018  
The Conformity Assessment Body Identifier is CN0008.

Name of Firm : EMTEK(SHENZHEN) CO., LTD.  
Site Location : Bldg 69, Majialong Industry Zone,  
Nanshan District, Shenzhen, Guangdong, China



## 6 TEST SYSTEM UNCERTAINTY

The following measurement uncertainty levels have been estimated for tests performed on the apparatus:

Parameter	Uncertainty
Radio Frequency	$\pm 1 \times 10^{-5}$
Maximum Peak Output Power Test	$\pm 1.0\text{dB}$
Conducted Emissions Test	$\pm 2.0\text{dB}$
Radiated Emission Test	$\pm 2.0\text{dB}$
Power Density	$\pm 2.0\text{dB}$
Occupied Bandwidth Test	$\pm 1.0\text{dB}$
Band Edge Test	$\pm 3\text{dB}$
All emission, radiated	$\pm 3\text{dB}$
Antenna Port Emission	$\pm 3\text{dB}$
Temperature	$\pm 0.5^\circ\text{C}$
Humidity	$\pm 3\%$

Measurement Uncertainty for a level of Confidence of 95%

## 7 SETUP OF EQUIPMENT UNDER TEST

### 7.1 RADIO FREQUENCY TEST SETUP 1

The WLAN component's antenna ports(s) of the EUT are connected to the measurement instrument per an appropriate attenuator. The EUT is controlled by PC/software to emit the specified signals for the purpose of measurements.

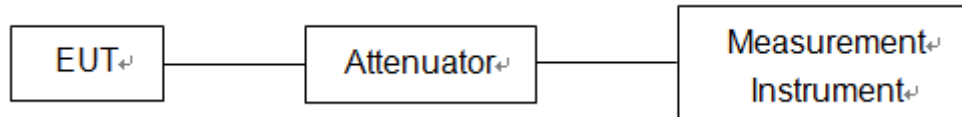

### 7.2 RADIO FREQUENCY TEST SETUP 2

The test site semi-anechoic chamber has met the requirement of NSA tolerance 4 dB according to the standards: ANSI C63.10. The test distance is 3m. The setup is according to the requirements in Section 13.1.4.1 of ANSI C63.10-2013 and CAN/CSA-CEI/IEC CISPR 22.

Below 30MHz:

The EUT is placed on a turntable 0.8 meters above the ground in the chamber, 3 meter away from the antenna (loop antenna). The Antenna should be positioned with its plane vertical at the specified distance from the EUT and rotated about its vertical axis for maximum response at each azimuth about the EUT. The center of the loop shall be 1 m above the ground. For certain applications, the loop antenna plane may also need to be positioned horizontally at the specified distance from the EUT.

30MHz-1GHz:

The EUT is placed on a turntable 0.8 meters above the ground in the chamber, 3 meter away from the antenna. The maximal emission value is acquired by adjusting the antenna height, polarisation and turntable azimuth. Normally, the height range of antenna is 1 m to 4 m, the azimuth range of turntable is 0° to 360°, and the receive antenna has two polarizations Vertical (V) and Horizontal (H).

Above 1GHz:

The EUT is placed on a turntable 1.5 meters above the ground in the chamber, 3 meter away from the antenna. The maximal emission value is acquired by adjusting the antenna height, polarisation and turntable azimuth. Normally, the height range of antenna is 1 m to 4 m, the azimuth range of turntable is 0° to 360°, and the receive antenna has two polarizations Vertical (V) and Horizontal (H).

(a) Radiated Emission Test Set-Up, Frequency Below 30MHz

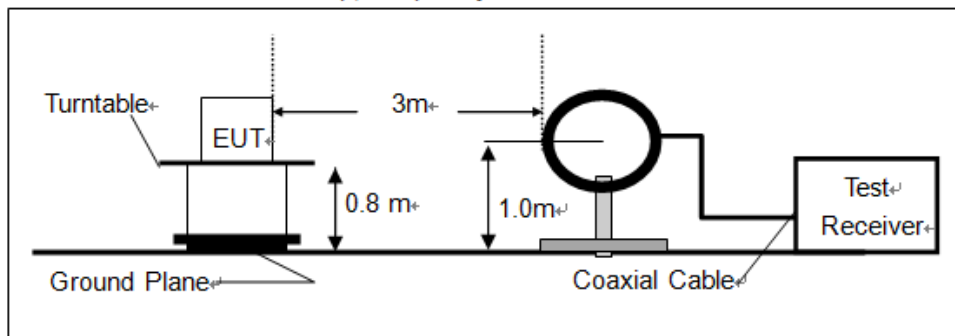

(b) Radiated Emission Test Set-Up, Frequency Below 1000MHz

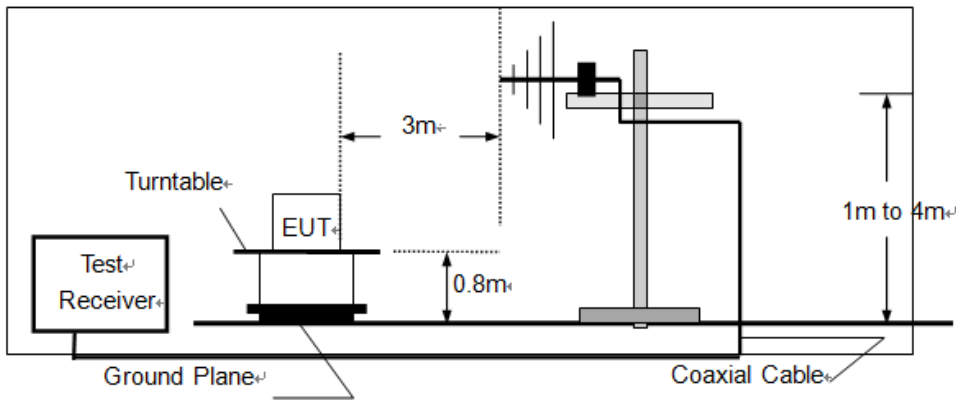

(c) Radiated Emission Test Set-Up, Frequency above 1000MHz

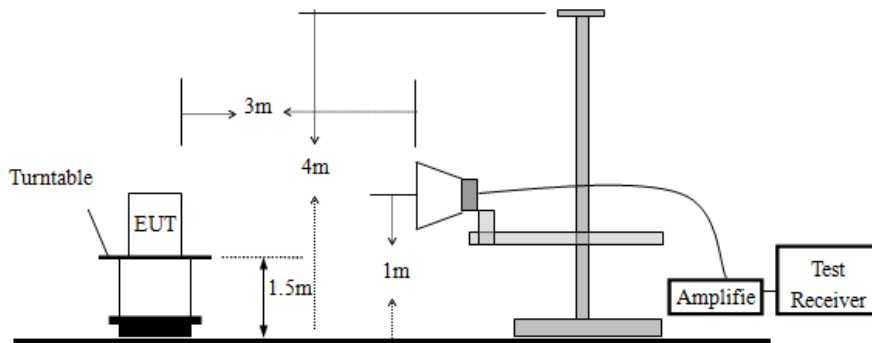

### 7.3 CONDUCTED EMISSION TEST SETUP

The mains cable of the EUT (maybe per AC/DC Adapter) must be connected to LISN. The LISN shall be placed 0.8 m from the boundary of EUT and bonded to a ground reference plane for LISN mounted on top of the ground reference plane. This distance is between the closest points of the LISN and the EUT. All other units of the EUT and associated equipment shall be at least 0.8m from the LISN.

Ground connections, where required for safety purposes, shall be connected to the reference ground point of the LISN and, where not otherwise provided or specified by the manufacturer, shall be of same length as the mains cable and run parallel to the mains connection at a separation distance of not more than 0.1 m.

According to the requirements in Section 13.1.4.1 of ANSI C63.10-2013 Conducted emissions from the EUT measured in the frequency range between 0.15 MHz and 30 MHz using CISPR Quasi-Peak and average detector mode.

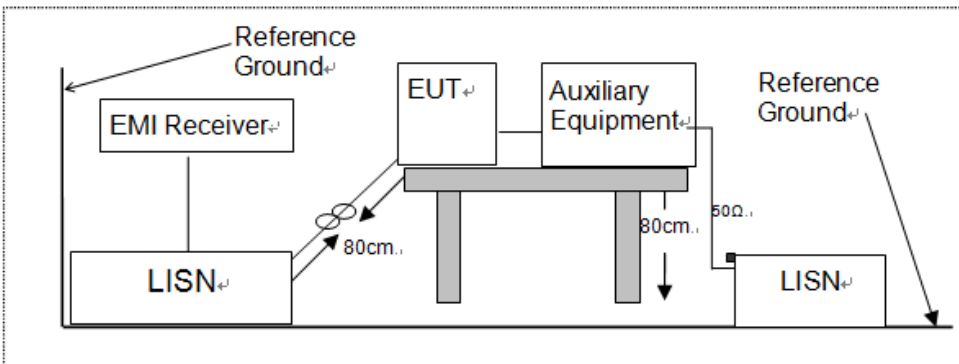

**7.4 BLOCK DIAGRAM CONFIGURATION OF TEST SYSTEM**

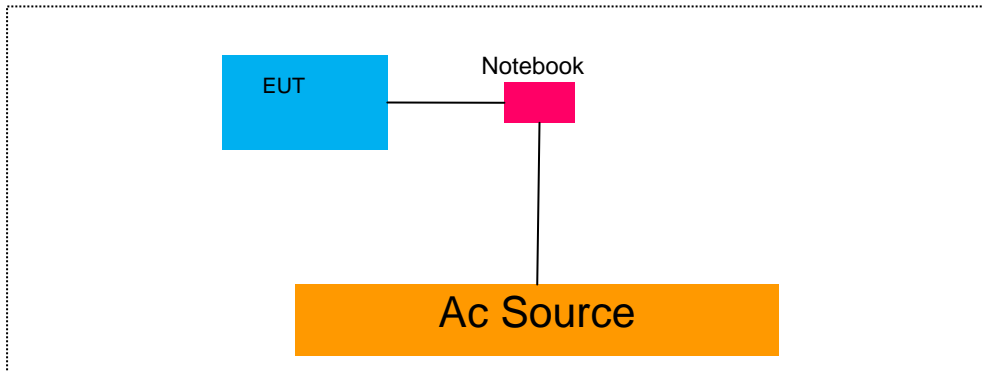

**7.5 SUPPORT EQUIPMENT**

EUT Cable List and Details			
Cable Description	Length (m)	Shielded/Unshielded	With / Without Ferrite
/	/	/	/

Auxiliary Cable List and Details			
Cable Description	Length (m)	Shielded/Unshielded	With / Without Ferrite
/	/	/	/

Auxiliary Equipment List and Details			
Description	Manufacturer	Model	Serial Number
Notebook	acer	ZR1	LXTECOCO76643158 372500

**Notes:**

1. All the equipment/cables were placed in the worst-case configuration to maximize the emission during the test.
2. Grounding was established in accordance with the manufacturer's requirements and conditions for the intended use.
3. Unless otherwise denoted as EUT in [Remark] column, device(s) used in tested system is a support equipment

## 8 TEST REQUIREMENTS

### 8.1 DTS(6DB)BANDWIDTH

#### 8.1.1 Applicable Standard

According to FCC Part15.247 (a) (2) and KDB 558074 D01 15.247 Meas Guidance v05r02

#### 8.1.2 Conformance Limit

The minimum -6 dB bandwidth shall be at least 500 kHz.

#### 8.1.3 Test Configuration

Test according to clause 7.1 radio frequency test setup 1

#### 8.1.4 Test Procedure

The EUT was operating in IEEE 802.11b/g/n mode and controlled its channel. Printed out the test result from the spectrum by hard copy function.

The RF output of EUT was connected to the spectrum analyzer by RF cable and attenuator. The path loss was compensated to the results for each measurement.

Set to the maximum power setting and enable the EUT transmit continuously

Set RBW = 100 kHz.

Set the video bandwidth (VBW) =300 kHz.

Set Span=2 times OBW

Set Detector = Peak.

Set Trace mode = max hold.

Set Sweep = auto couple.

Allow the trace to stabilize.

Measure the maximum width of the emission that is constrained by the frequencies associated with the two outermost amplitude points (upper and lower frequencies) that are attenuated by 6 dB relative to the maximum level measured in the fundamental emission.

Measure and record the results in the test report.

#### 8.1.5 Test Results

Temperature:	26° C
Relative Humidity:	54%
ATM Pressure:	1011 mbar

Operation Mode	Channel Number	Channel Frequency (MHz)	Measurement Bandwidth (MHz)	Limit (kHz)	Verdict
802.11b	1	2412	9.594	>500	PASS
	6	2437	9.600	>500	PASS
	11	2462	9.614	>500	PASS
802.11g	1	2412	15.15	>500	PASS
	6	2437	15.15	>500	PASS
	11	2462	15.15	>500	PASS
802.11n (HT20)	1	2412	15.73	>500	PASS
	6	2437	15.75	>500	PASS
	11	2462	15.15	>500	PASS
802.11n (HT40)	3	2422	35.11	>500	PASS
	6	2437	35.14	>500	PASS
	9	2452	35.13	>500	PASS

Test Model DTS (6dB) Bandwidth  
802.11b  
Channel 1: 2412MHz

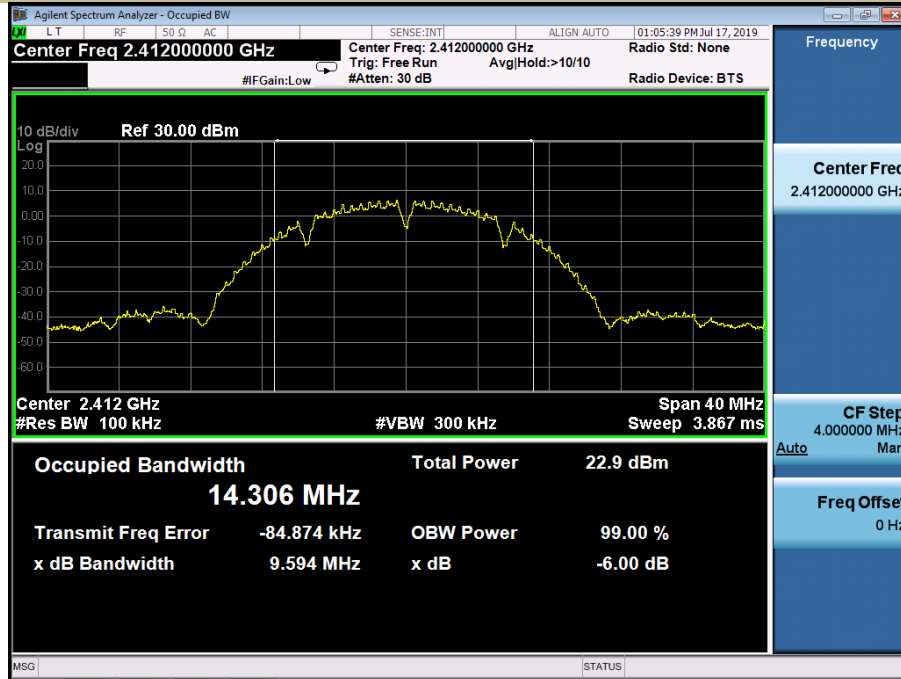

Test Model DTS (6dB) Bandwidth  
802.11b  
Channel 6: 2437MHz

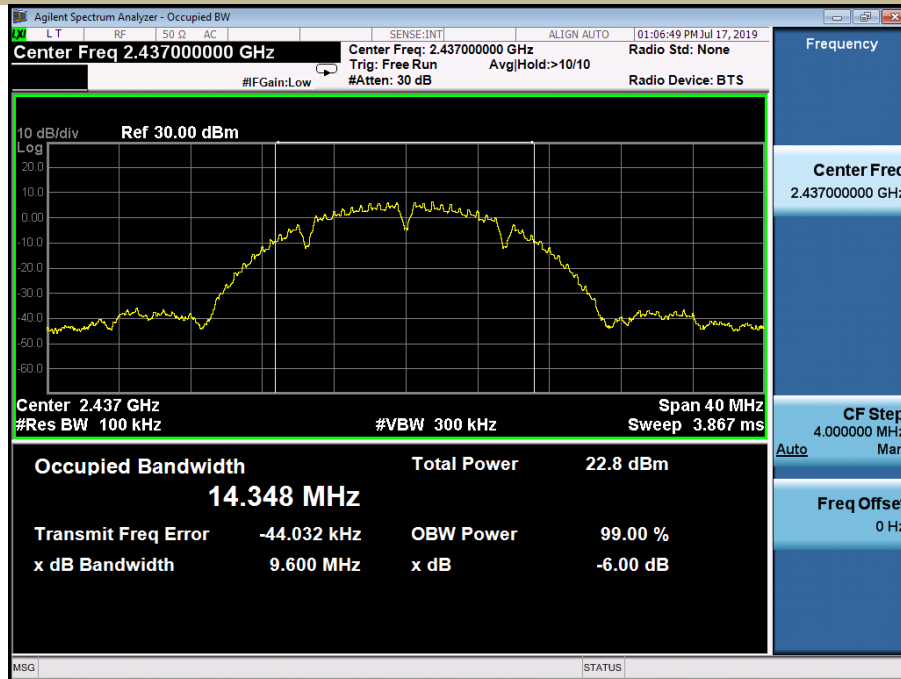

Test Model DTS (6dB) Bandwidth  
802.11b  
Channel 11: 2462MHz

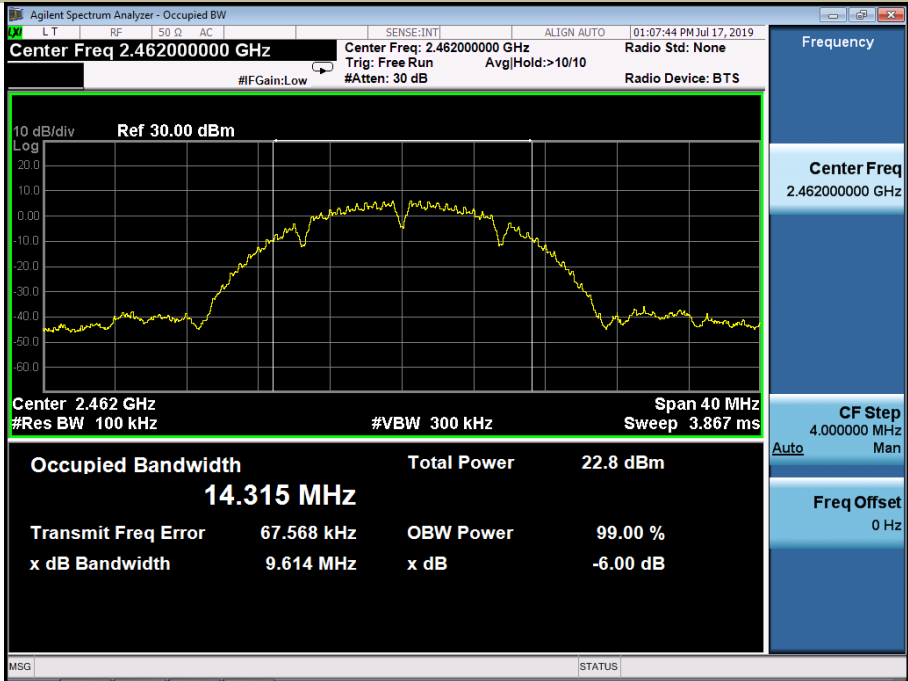

Test Model DTS (6dB) Bandwidth  
802.11g  
Channel 1: 2412MHz

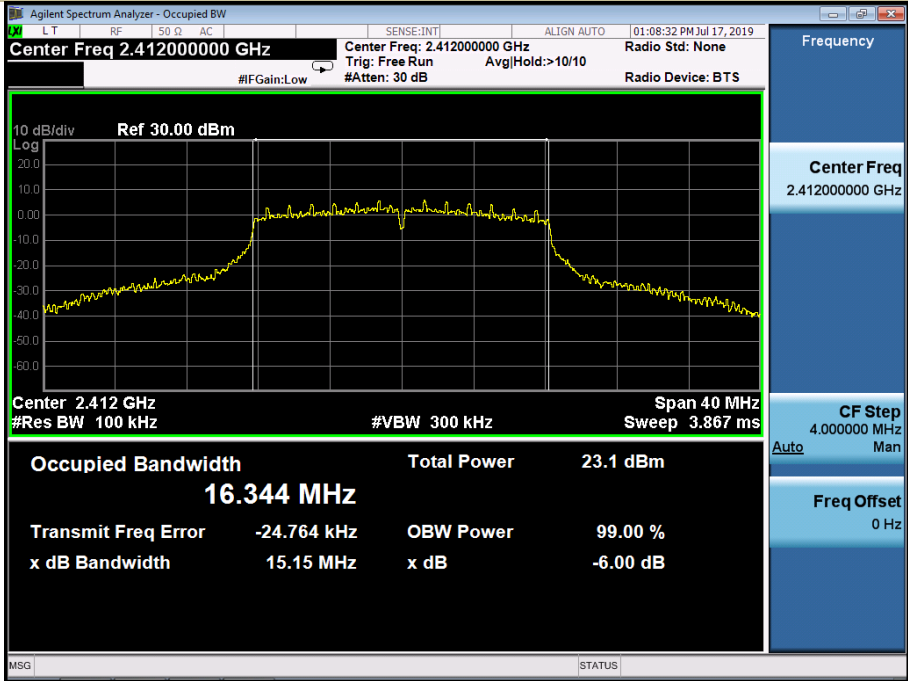

Test Model DTS (6dB) Bandwidth  
802.11g  
Channel 6: 2437MHz

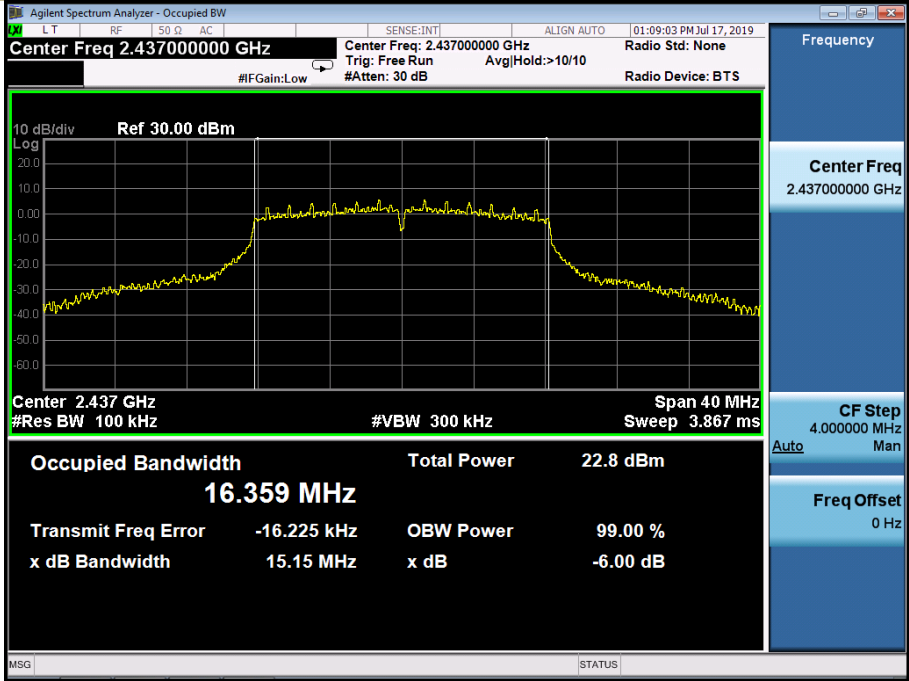

Test Model DTS (6dB) Bandwidth  
802.11g  
Channel 11: 2462MHz

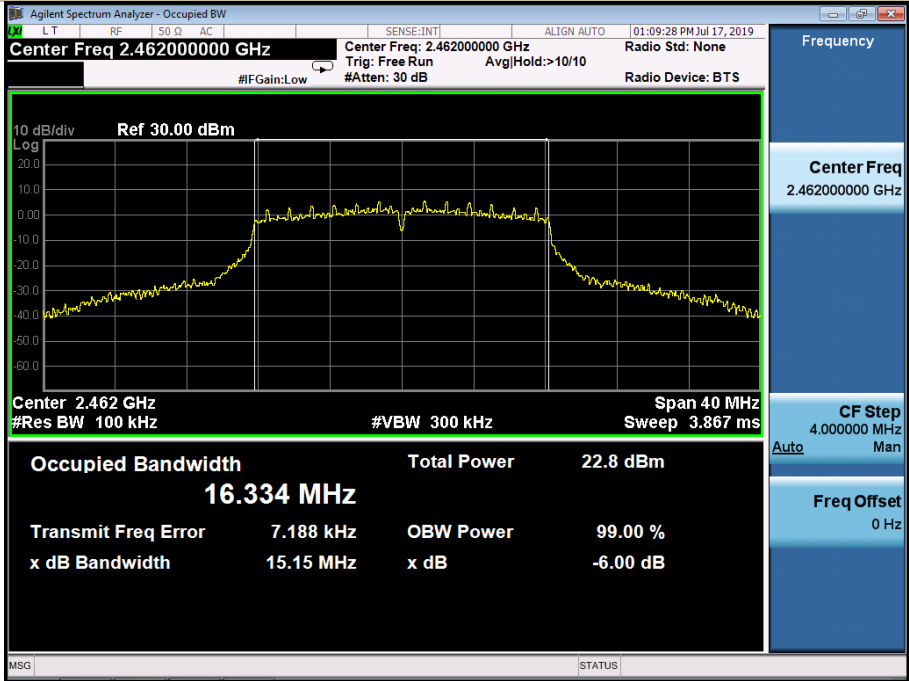



Test Model DTS (6dB) Bandwidth  
802.11n (HT20)  
Channel 1: 2412MHz

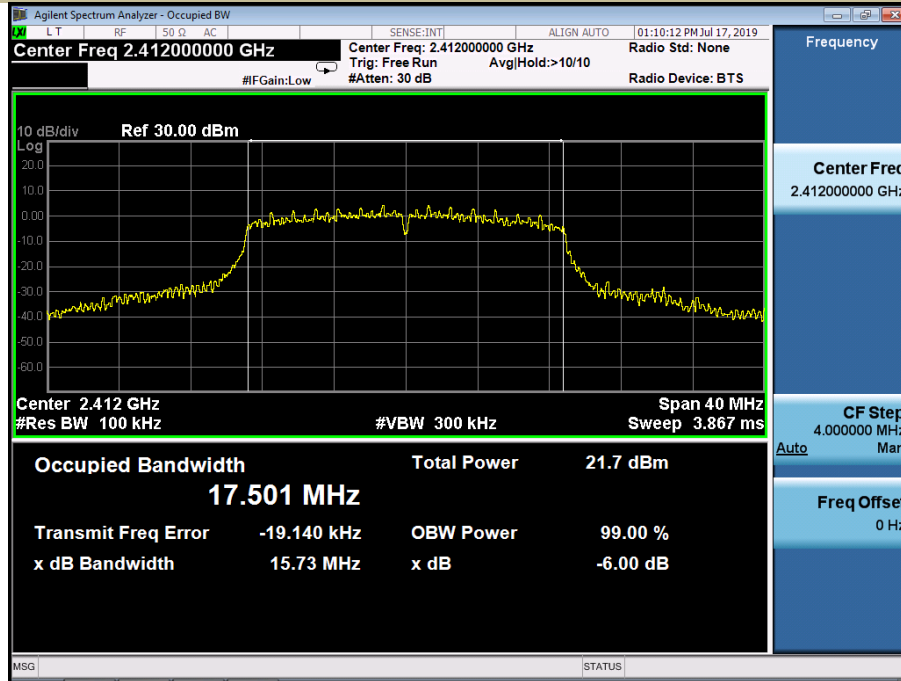

Test Model DTS (6dB) Bandwidth  
802.11n (HT20)  
Channel 6: 2437MHz

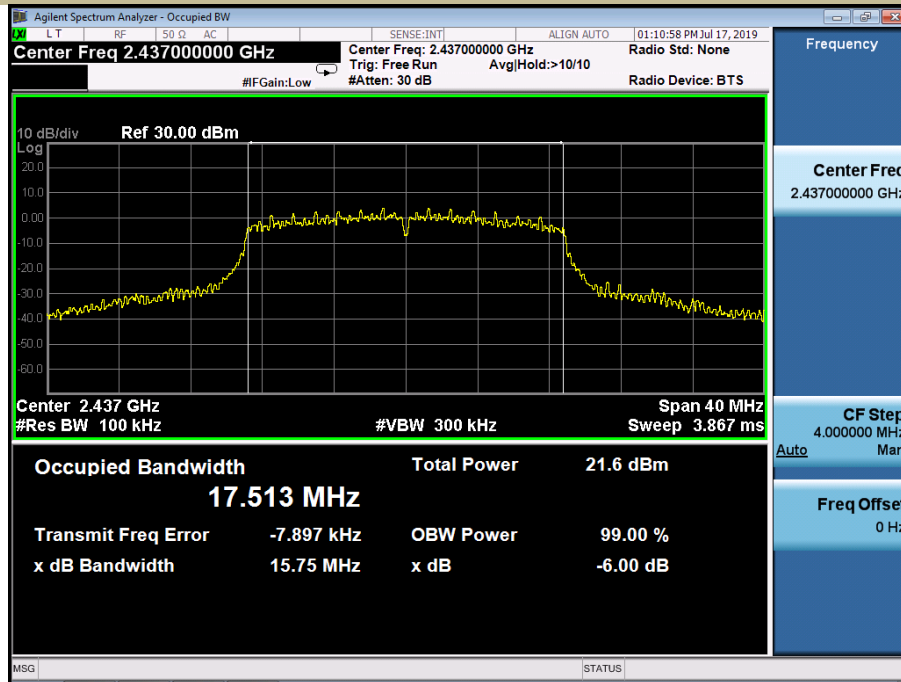

Test Model DTS (6dB) Bandwidth  
802.11n (HT20)  
Channel 11: 2462MHz

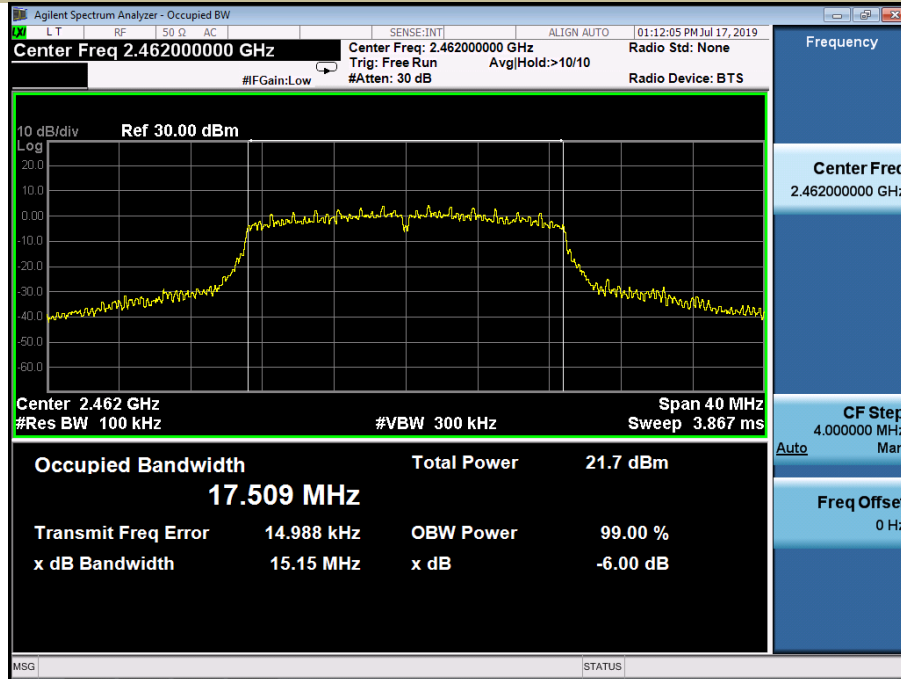

Test Model DTS (6dB) Bandwidth  
802.11n (HT40)  
Channel 3: 2422MHz

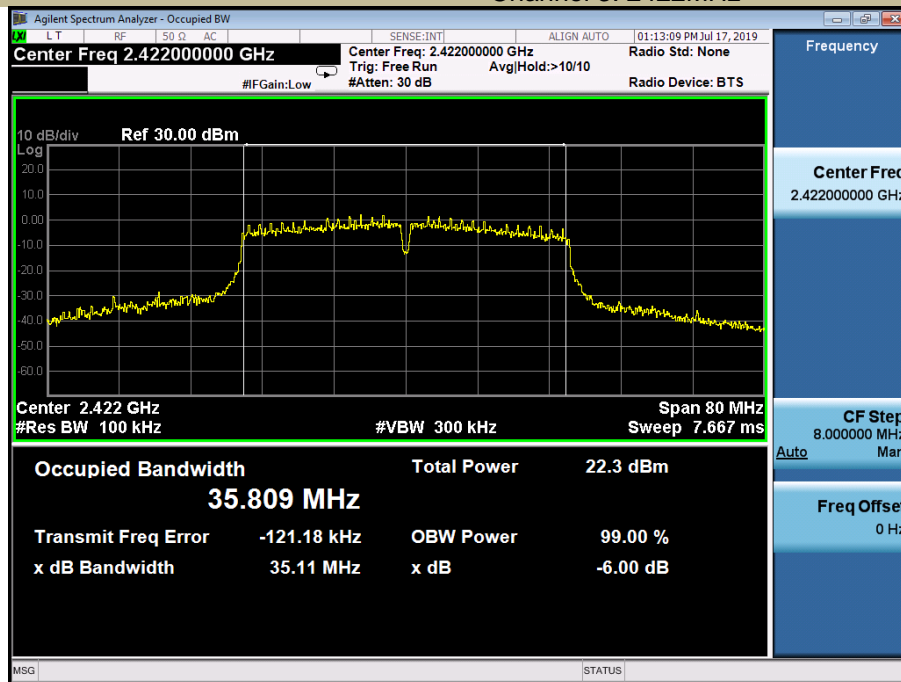

Test Model DTS (6dB) Bandwidth  
802.11n (HT40)  
Channel 6: 2437MHz

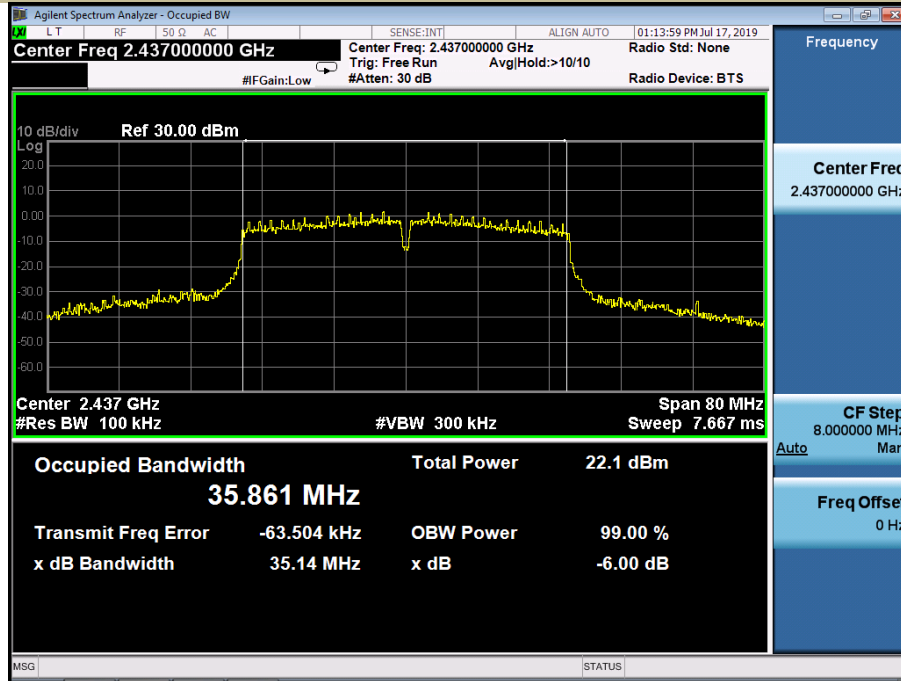

Test Model DTS (6dB) Bandwidth  
802.11n (HT40)  
Channel 9: 2452MHz

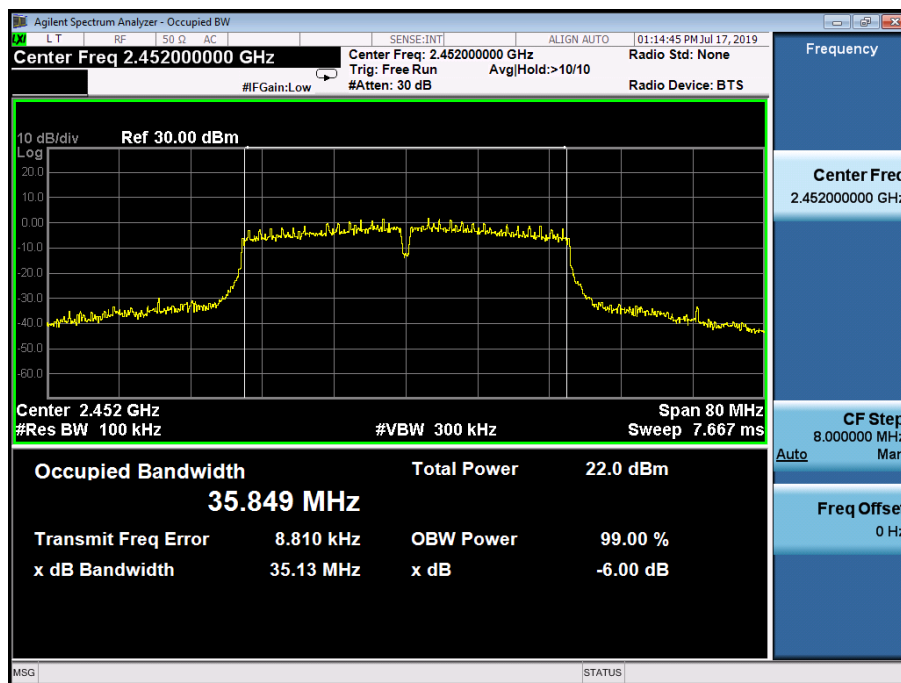

## 8.2 MAXIMUM PEAK CONDUCTED OUTPUT POWER

### 8.2.1 Applicable Standard

FCC Part15.247 (b)(3)  
 KDB 558074 D01 15.247 Meas Guidance v05r02  
 FCC KDB 662911 D01 Multiple Transmitter Output v02r01

### 8.2.2 Conformance Limit

The maximum peak conducted output power of the intentional radiator for systems using digital modulation in the 2400 - 2483.5 MHz bands shall not exceed: 1 Watt (30dBm).

### 8.2.3 Test Configuration

Test according to clause 7.1 radio frequency test setup 1

### 8.2.4 Test Procedure

■ According to FCC Part15.247(b)(3)

The maximum peak conducted output power may be measured using a broadband peak RF power meter. The power meter shall have a video bandwidth that is greater than or equal to the DTS bandwidth and shall utilize a fast-responding diode detector.

The testing follows FCC public Notice DA 00-705 Measurement Guidelines.

The RF output of EUT was connected to the power meter by RF cable and attenuator. The path loss was compensated to the results for each measurement.

Set to the maximum output power setting and enable the EUT transmit continuously.

Measure the conducted output power with cable loss and record the results in the test report.

Measure and record the results in the report.

■ According to FCC Part 15.247(b)(4):

Conducted output power limit specified in paragraph (b) of this section is based on the use of antennas with directional gains that do not exceed 6 dBi. If transmitting antennas of directional gain greater than 6 dBi are used, the conducted output power from the intentional radiator shall be reduced below the stated values in paragraphs (b)(3) of this section, as appropriate, by the amount in dB that the directional gain of the antenna exceeds 6 dBi.

Note: If antenna Gain exceeds 6 dBi, then Output power Limit=30-(Gain- 6)

### 8.2.5 Test Results

Temperature:	26° C
Relative Humidity:	54%
ATM Pressure:	1011 mbar

Operation Mode	Channel Number	Channel Frequency (MHz)	Measurement Level (dBm)			Limit (dBm)	Verdict
			Ant1	Ant2	Ant1+Ant2		
802.11b	1	2412	16.81	16.62	-	30	PASS
	6	2437	16.66	16.75	-	30	PASS
	11	2462	16.73	16.75	-	30	PASS
802.11g	1	2412	21.49	20.49	-	30	PASS
	6	2437	21.32	20.71	-	30	PASS
	11	2462	21.37	20.89	-	30	PASS
802.11n (HT20)	1	2412	20.67	18.54	22.74	30	PASS
	6	2437	20.62	18.83	22.83	30	PASS
	11	2462	20.63	18.96	22.89	30	PASS
802.11n (HT40)	3	2422	20.58	18.94	22.85	30	PASS
	6	2437	20.64	19.05	22.93	30	PASS
	9	2452	20.44	19.27	22.90	30	PASS

Note: For smart antenna systems, Maximum Conducted Output Power is summed at the total transmit power delivered to all antennas.

### 8.3 MAXIMUM POWER SPECTRAL DENSITY

#### 8.3.1 Applicable Standard

FCC Part15.247 (e)  
 KDB 558074 D01 15.247 Meas Guidance v05r02  
 FCC KDB 662911 D01 Multiple Transmitter Output v02r01

#### 8.3.2 Conformance Limit

The transmitter power spectral density conducted from the transmitter to the antenna shall not be greater than 8 dBm in any 3 kHz band during any time interval of continuous transmission.

#### 8.3.3 Test Configuration

Test according to clause 7.1 radio frequency test setup 1

#### 8.3.4 Test Procedure

This procedure shall be used if maximum peak conducted output power was used to demonstrate compliance

The transmitter output (antenna port) was connected to the spectrum analyzer

Set analyzer center frequency to DTS channel center frequency.

Set the span to 1.5 times the DTS bandwidth.

Set the RBW to: 3 kHz

Set the VBW to:10 kHz.

Set Detector = peak.

Set Sweep time = auto couple.

Set Trace mode = max hold.

Allow trace to fully stabilize.

Use the peak marker function to determine the maximum amplitude level within the RBW.

Note: If antenna Gain exceeds 6 dBi, then PSD Limit=8-(Gain- 6)

#### 8.3.5 Test Results

Temperature:	26° C
Relative Humidity:	54%
ATM Pressure:	1011 mbar

Operation Mode	Channel Number	Channel Frequency (MHz)	Measurement Level (dBm/3kHz)			Limit (dBm/3kHz)	Verdict
			Ant1	Ant2	Ant1+Ant2		
802.11b	1	2412	-10.680	-10.596	-	8	PASS
	6	2437	-9.090	-10.386	-	8	PASS
	11	2462	-9.029	-9.598	-	8	PASS
802.11g	1	2412	-10.210	-11.336	-	8	PASS
	6	2437	-11.221	-11.193	-	8	PASS
	11	2462	-10.520	-10.616	-	8	PASS
802.11n (HT20)	1	2412	-12.803	-13.512	-10.13	8	PASS
	6	2437	-11.715	-11.013	-8.34	8	PASS
	11	2462	-11.763	-12.847	-9.26	8	PASS
802.11n (HT40)	3	2422	-15.298	-14.796	-12.03	8	PASS
	6	2437	-14.343	-15.254	-11.76	8	PASS
	9	2452	-13.839	-14.236	-11.02	8	PASS

Note: For smart antenna systems, Maximum Power Spectral Density is summed at the total transmit density delivered to all antennas.

Test Model Power Spectral Density  
802.11b  
Channel 1: 2412MHz

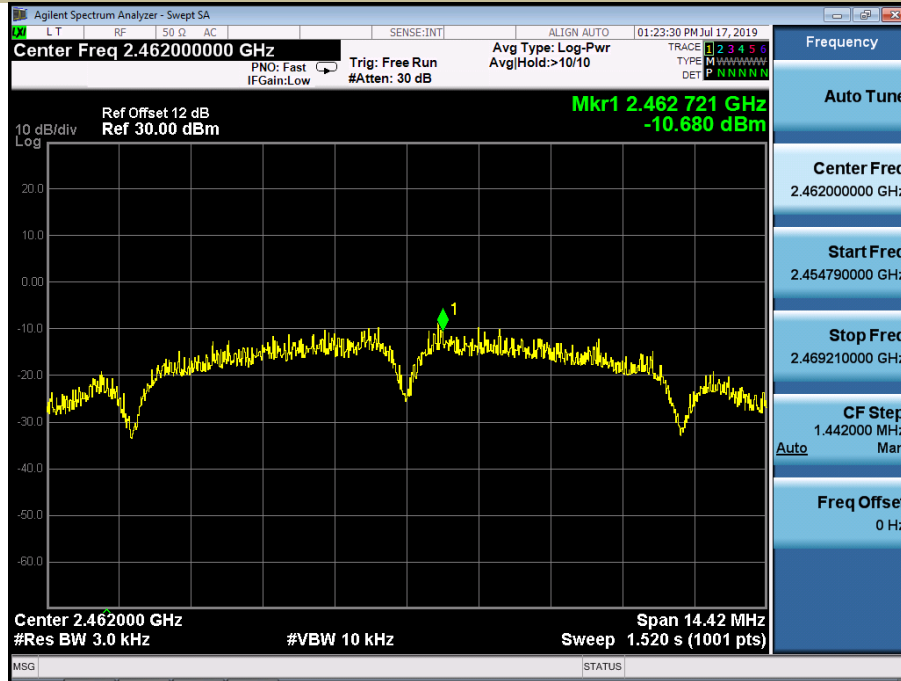

Test Model Power Spectral Density  
802.11b  
Channel 6: 2437MHz

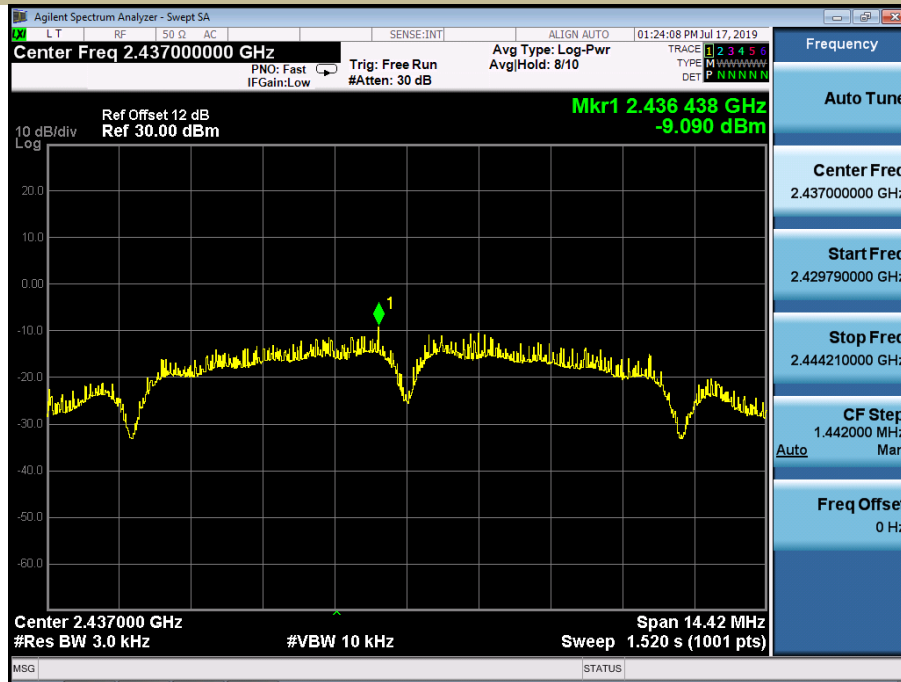

Test Model Power Spectral Density  
802.11b  
Channel 11: 2462MHz

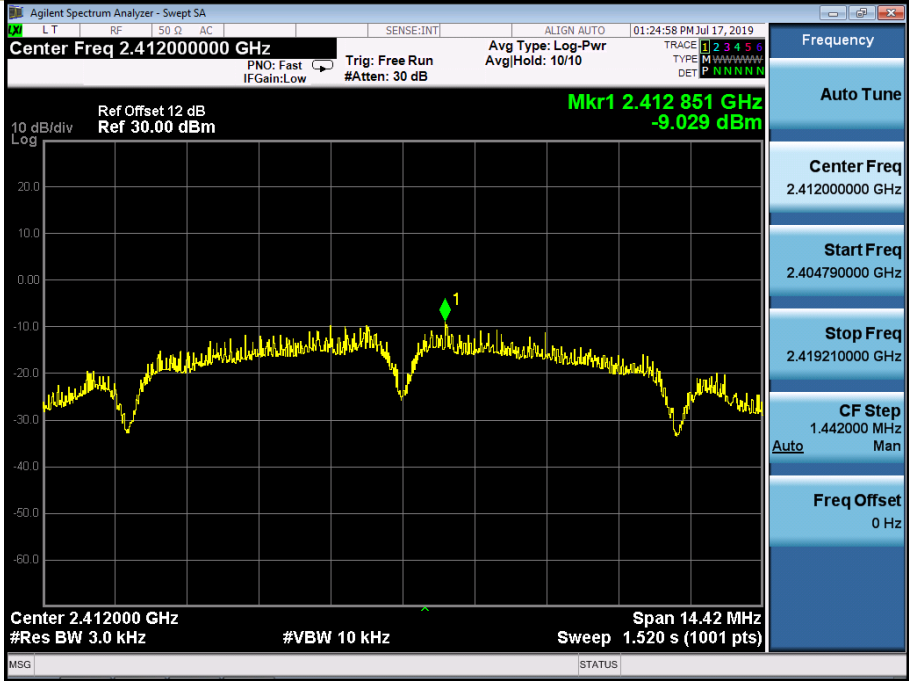

Test Model Power Spectral Density  
802.11g  
Channel 1: 2412MHz

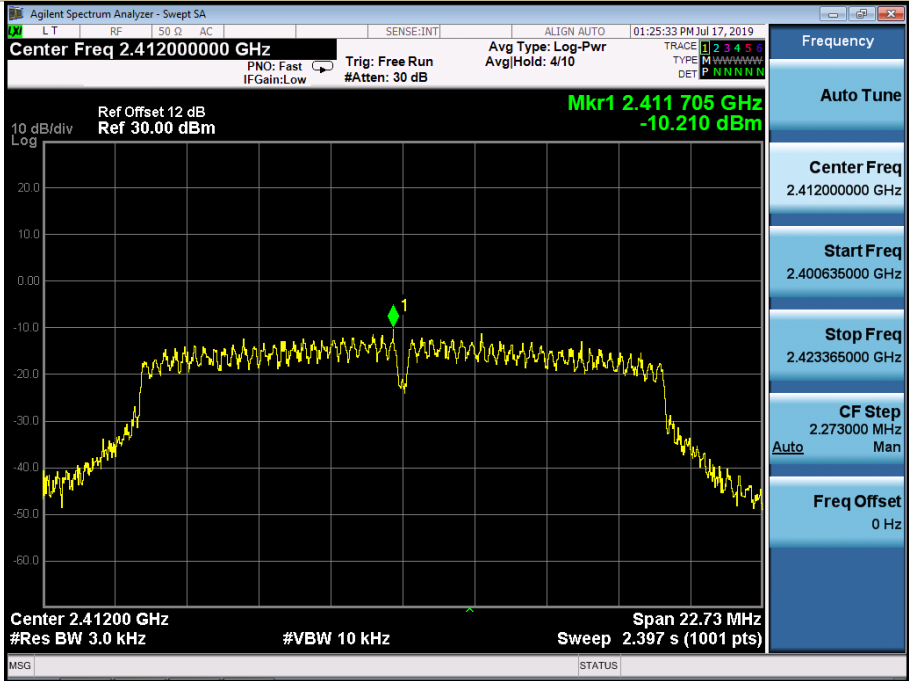

Test Model Power Spectral Density  
802.11g  
Channel 6: 2437MHz

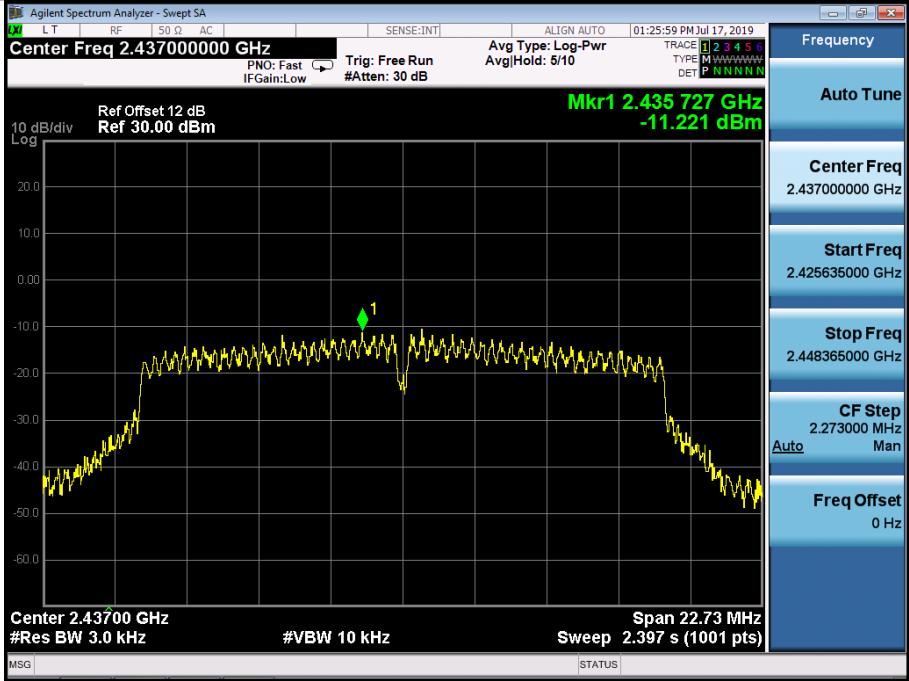

Test Model Power Spectral Density  
802.11g  
Channel 11: 2462MHz

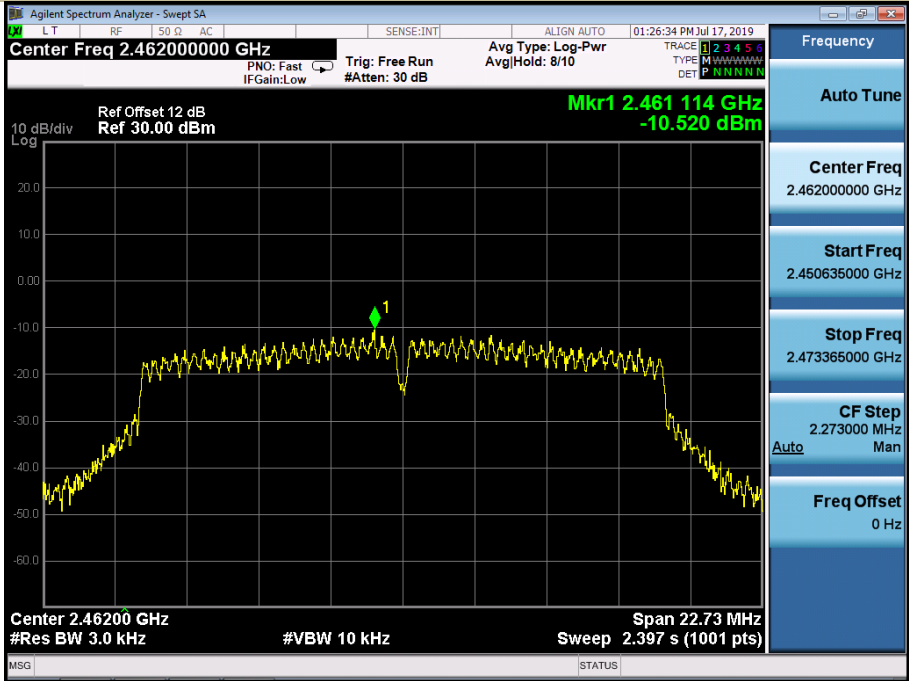



Test Model Power Spectral Density  
802.11n (HT20)  
Channel 1: 2412MHz

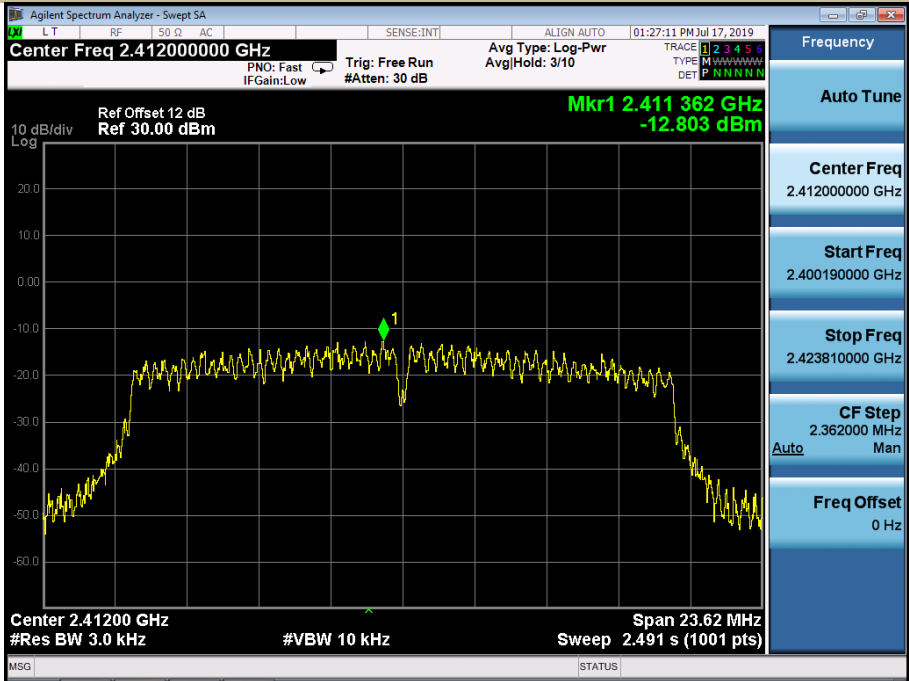

Test Model Power Spectral Density  
802.11n (HT20)  
Channel 6: 2437MHz

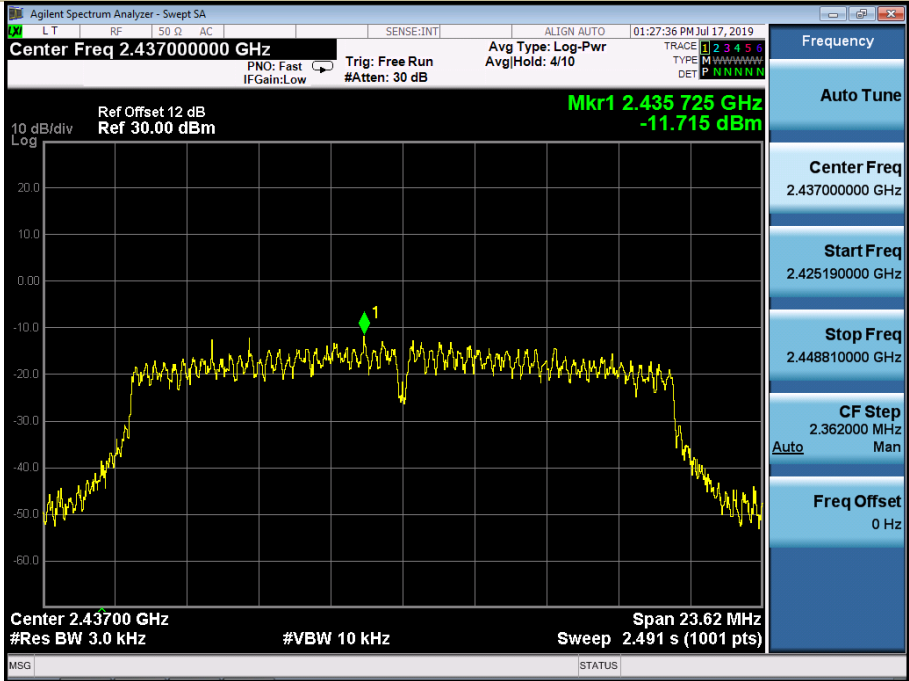

Test Model Power Spectral Density  
802.11n (HT20)  
Channel 11: 2462MHz

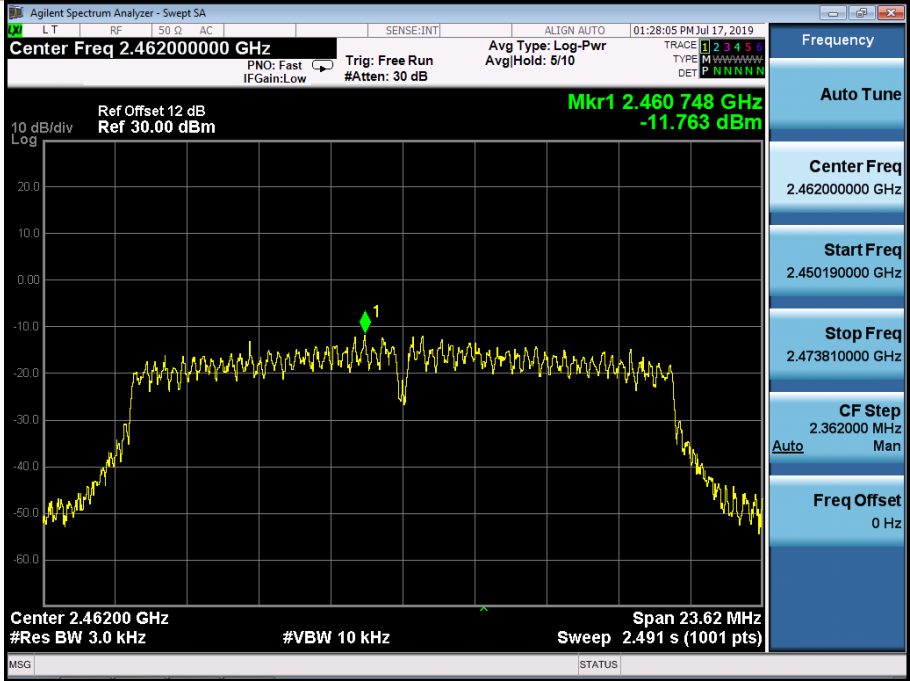

Test Model Power Spectral Density  
802.11n (HT40)  
Channel 3: 2422MHz

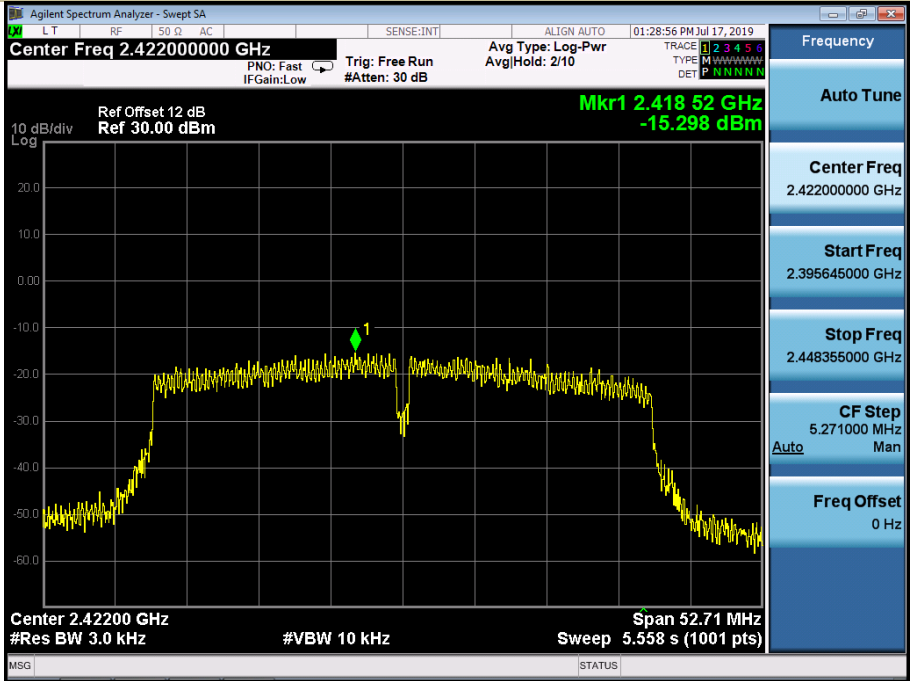

Test Model Power Spectral Density  
802.11n (HT40)  
Channel 6: 2437MHz

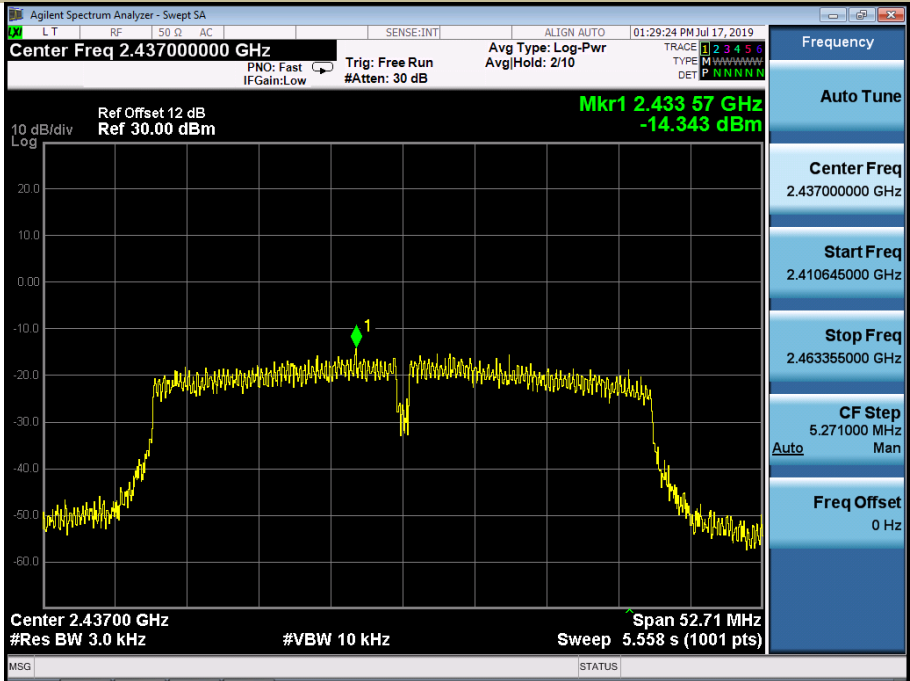

Test Model Power Spectral Density  
802.11n (HT40)  
Channel 9: 2452MHz

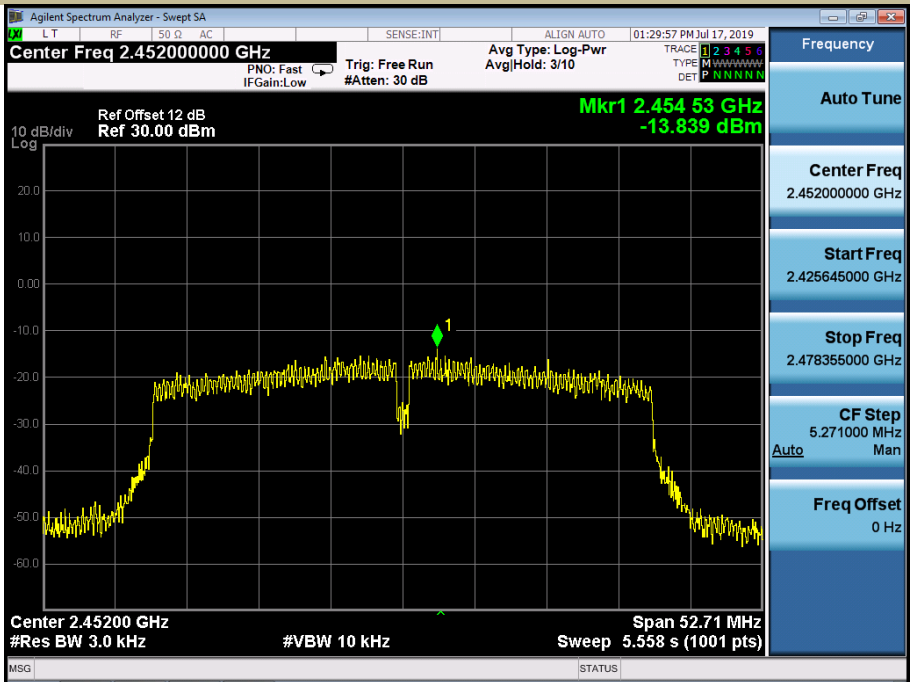

ANT 2

Test Model Power Spectral Density  
802.11b  
Channel 1: 2412MHz

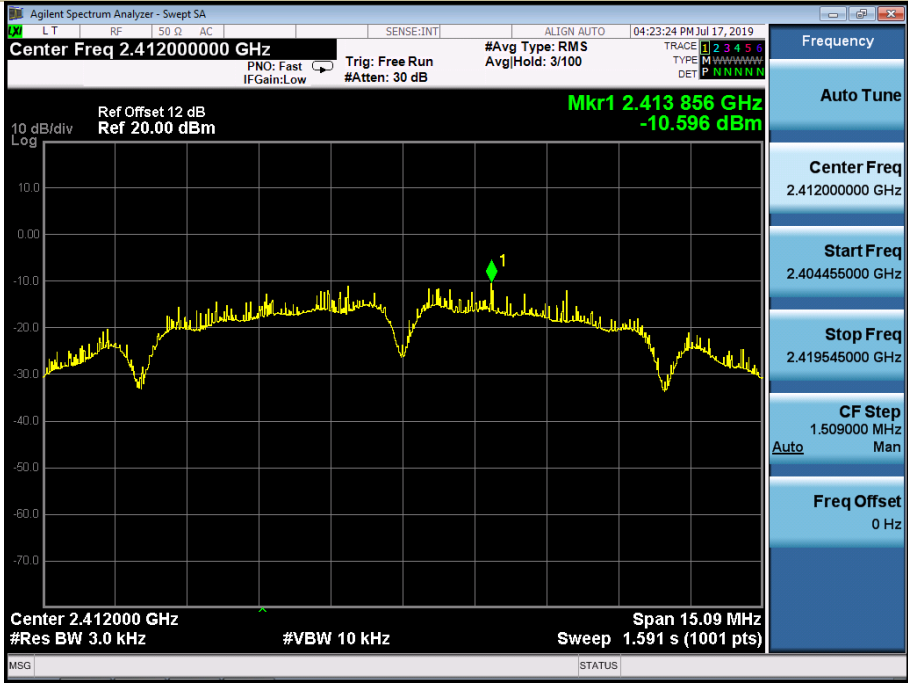

Test Model Power Spectral Density  
802.11b  
Channel 6: 2437MHz

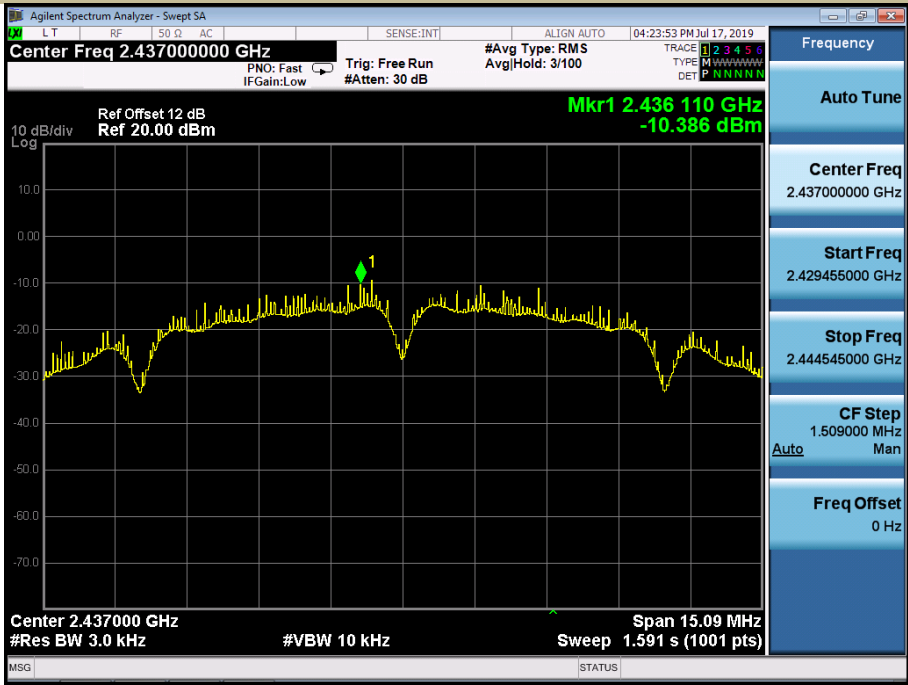

Test Model Power Spectral Density  
802.11b  
Channel 11: 2462MHz

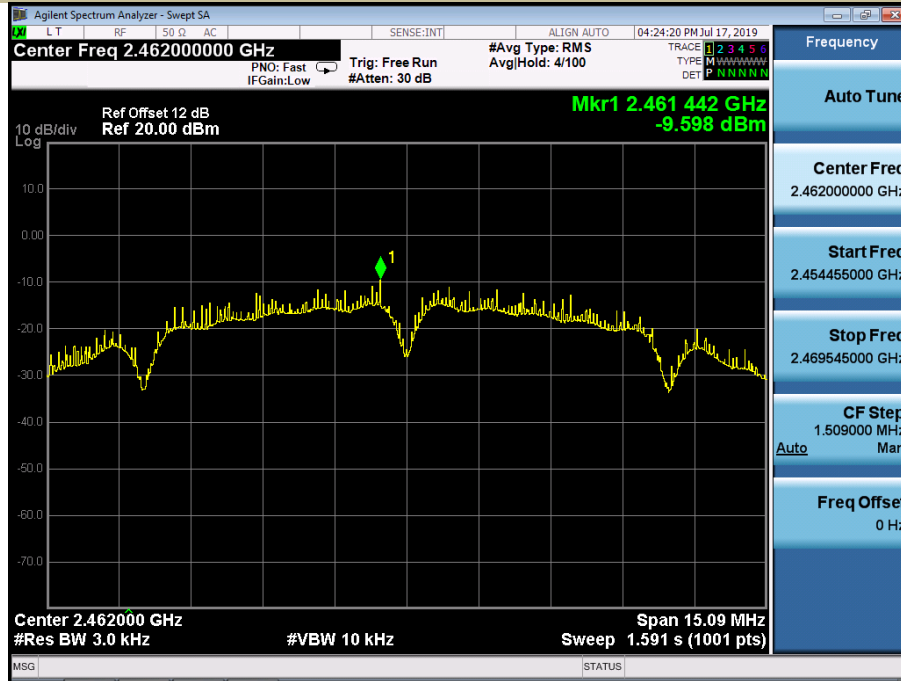

Test Model Power Spectral Density  
802.11g  
Channel 1: 2412MHz

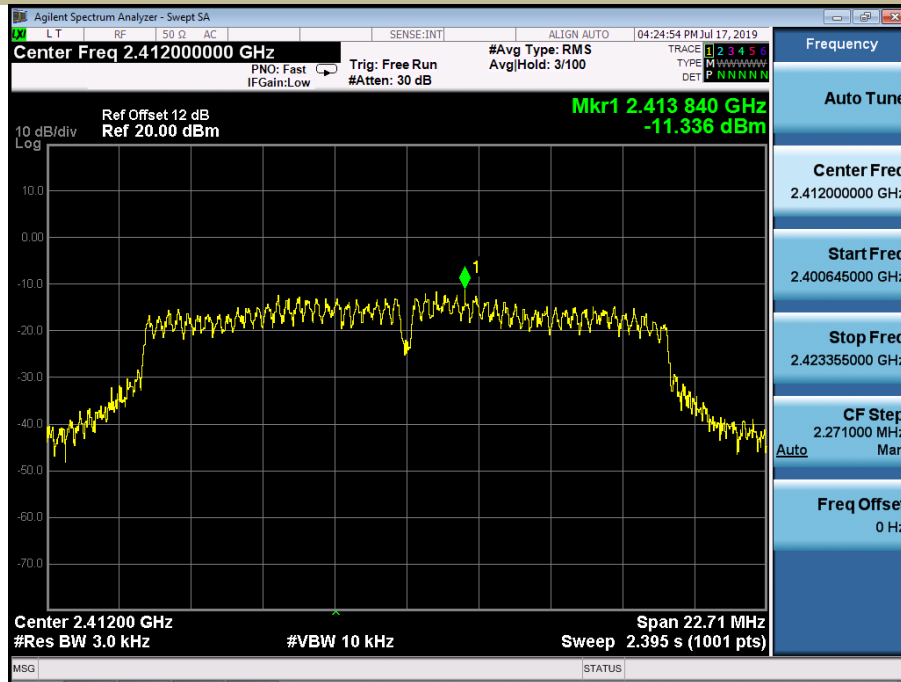

Test Model Power Spectral Density  
802.11g  
Channel 6: 2437MHz

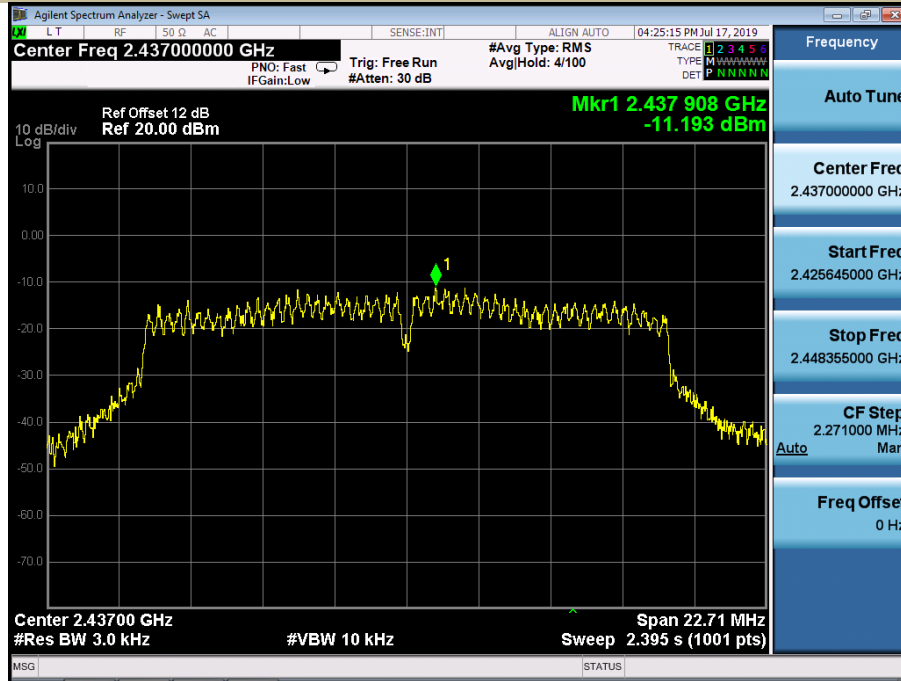

Test Model Power Spectral Density  
802.11g  
Channel 11: 2462MHz

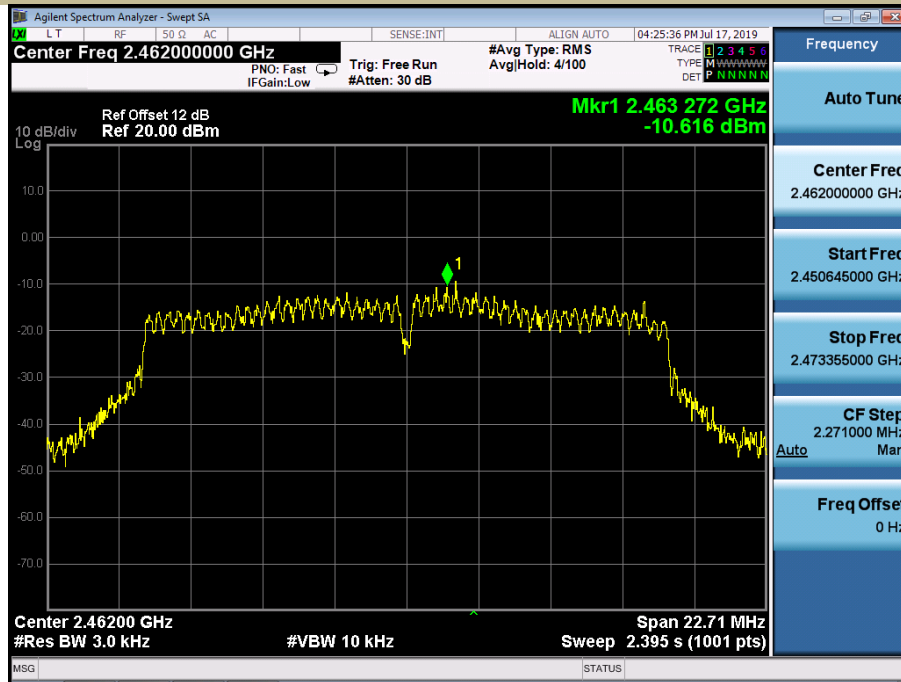

Test Model Power Spectral Density  
802.11n (HT20)  
Channel 1: 2412MHz

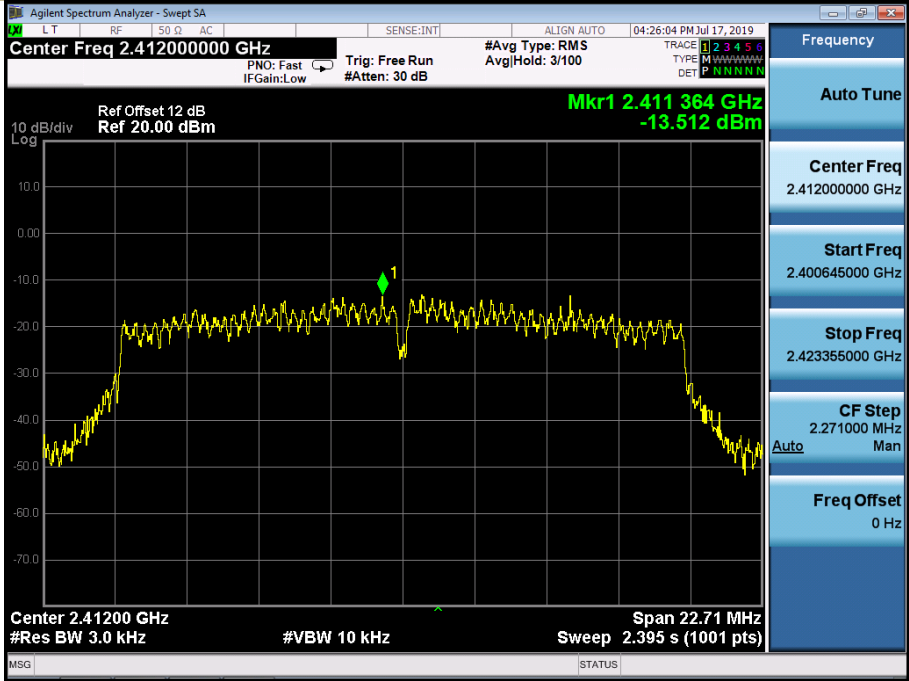

Test Model Power Spectral Density  
802.11n (HT20)  
Channel 6: 2437MHz

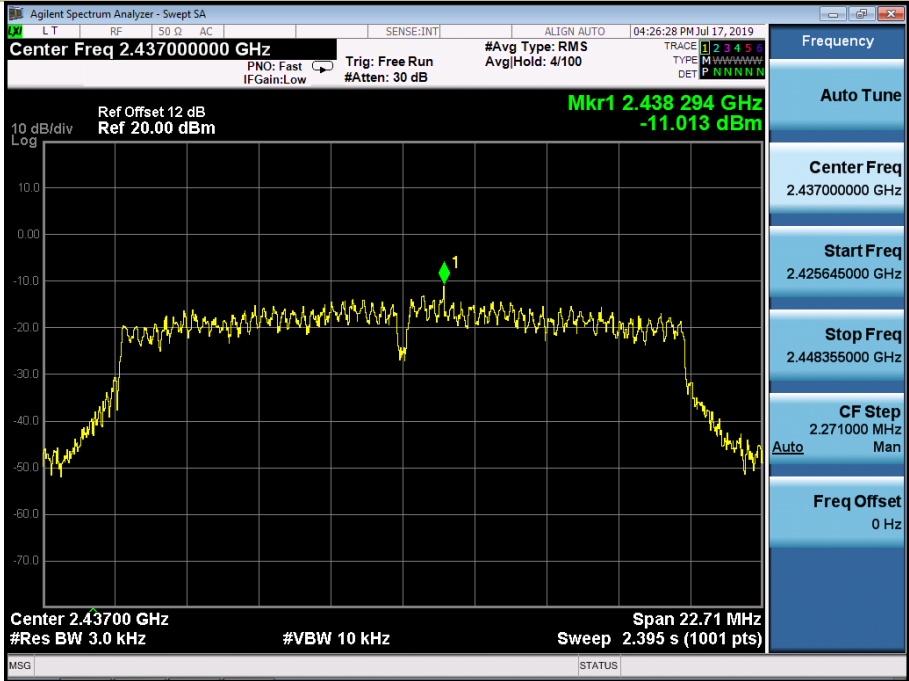

Test Model Power Spectral Density  
802.11n (HT20)  
Channel 11: 2462MHz

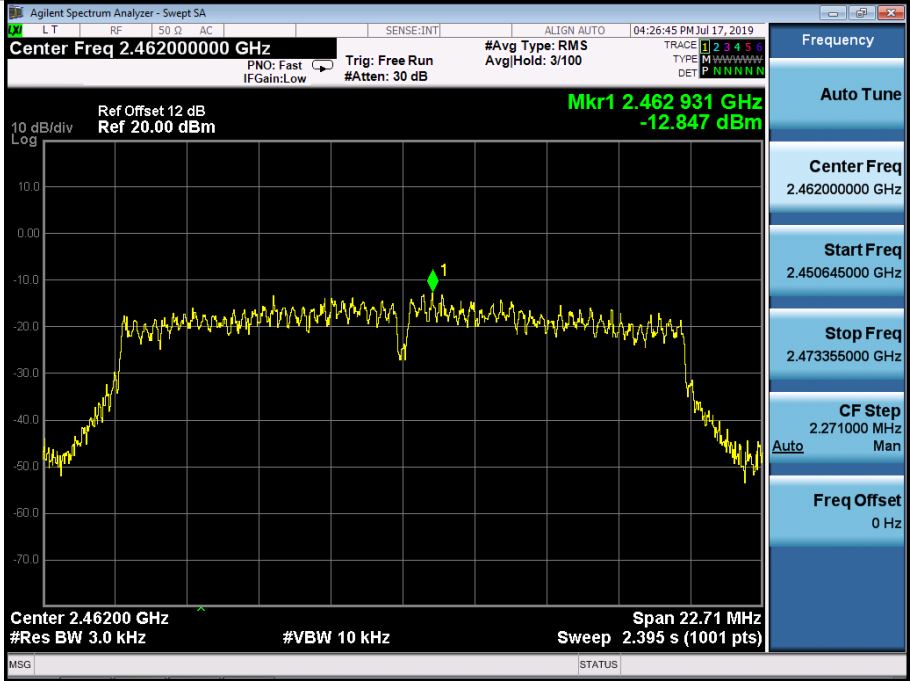

Test Model Power Spectral Density  
802.11n (HT40)  
Channel 3: 2422MHz

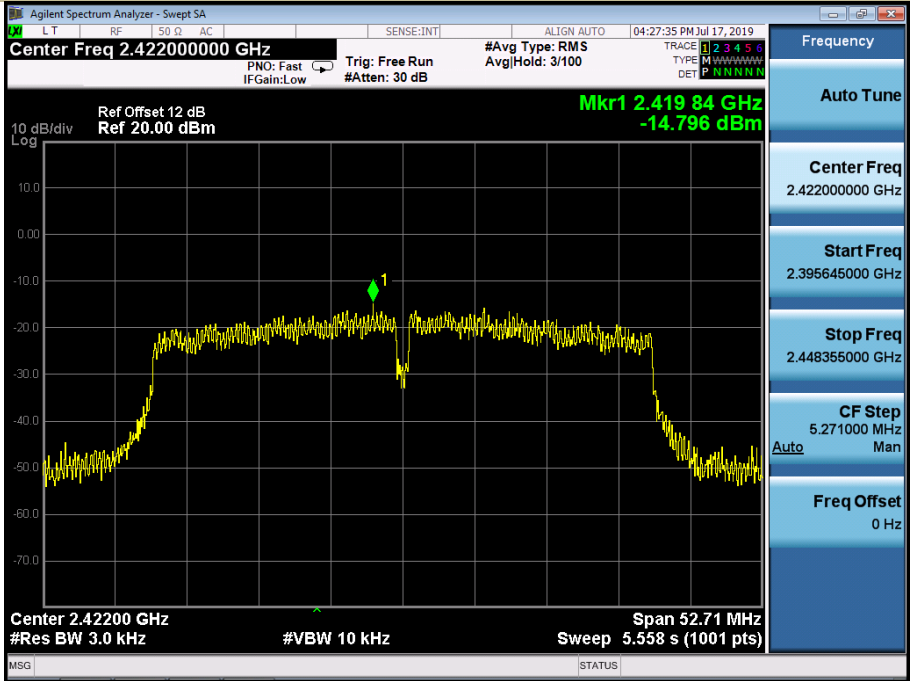



Test Model Power Spectral Density  
802.11n (HT40)  
Channel 6: 2437MHz

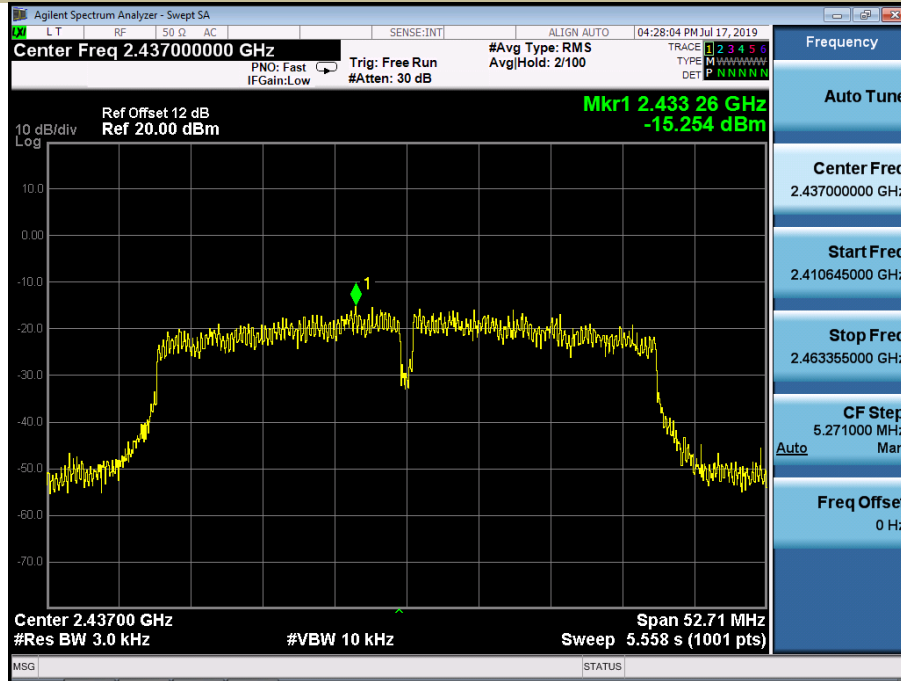

Test Model Power Spectral Density  
802.11n (HT40)  
Channel 9: 2452MHz

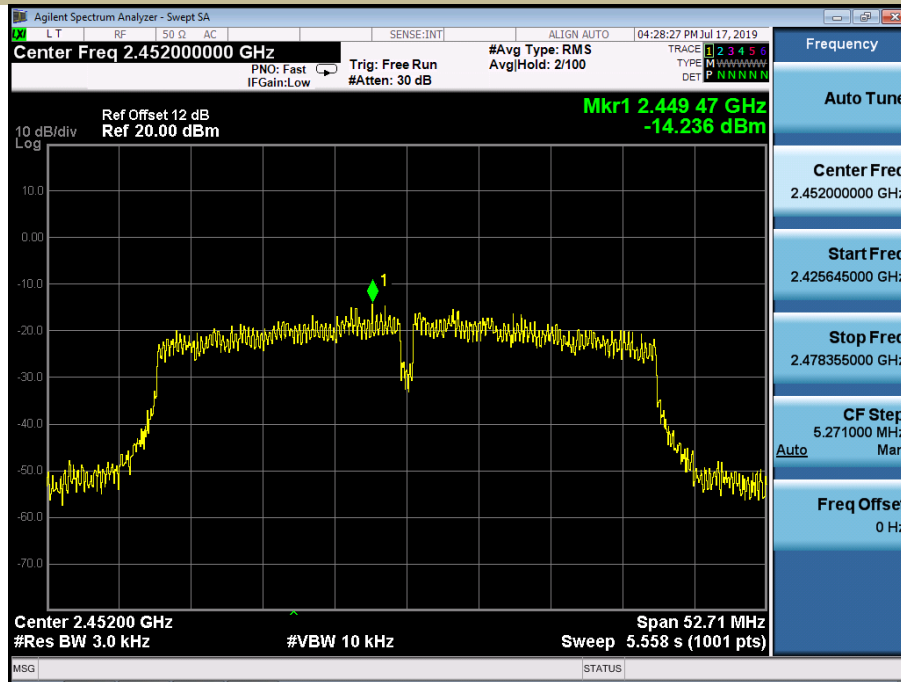

## 8.4 UNWANTED EMISSIONS IN NON-RESTRICTED FREQUENCY BANDS

### 8.4.1 Applicable Standard

According to FCC Part 15.247 (d) and KDB 558074 D01 15.247 Meas Guidance v05r02

### 8.4.2 Conformance Limit

According to FCC Part 15.247(d):

In any 100 kHz bandwidth outside the frequency band in which the spread spectrum or digitally modulated intentional radiator is operating, the radio frequency power that is produced by the intentional radiator shall be at least 20 dB below that in the 100 kHz bandwidth within the band that contains the highest level of the desired power, based on either an RF conducted or a radiated measurement, provided the transmitter demonstrates compliance with the peak conducted power limits. If the transmitter complies with the conducted power limits based on the use of RMS averaging over a time interval, as permitted under paragraph (b)(3) of this section, the attenuation required under this paragraph shall be 30 dB instead of 20 dB.

### 8.4.3 Test Configuration

Test according to clause 7.1 radio frequency test setup 1

### 8.4.4 Test Procedure

The transmitter output (antenna port) was connected to the spectrum analyzer

#### ■ Reference level measurement

Establish a reference level by using the following procedure:

Set instrument center frequency to DTS channel center frequency.

Set the span to  $\geq 1.5$  times the DTS bandwidth.

Set the RBW = 100 kHz.

Set the VBW  $\geq 3 \times$  RBW.

Set Detector = peak.

Set Sweep time = auto couple.

Set Trace mode = max hold.

Allow trace to fully stabilize.

Use the peak marker function to determine the maximum PSD level.

Note that the channel found to contain the maximum PSD level can be used to establish the reference level.

#### ■ Emission level measurement

Set the center frequency and span to encompass frequency range to be measured.

Set the RBW = 100 kHz.

Set the VBW = 300 kHz.

Set Detector = peak

Sweep time = auto couple.

Trace mode = max hold.

Allow trace to fully stabilize.

Use the peak marker function to determine the maximum amplitude level.

Ensure that the amplitude of all unwanted emissions outside of the authorized frequency band (excluding restricted frequency bands) are attenuated by at least the minimum requirements. Report the three highest emissions relative to the limit.

### 8.4.5 Test Results

All 2.4G 802.11b/g/n SISO and MIMO Modes have been tested, and the worst result recorded was report as below:

PSD(Power Spectral Density) RBW=100kHz

Test Model      802.11b      802.11g      802.11n(HT20)      802.11n(HT40)

Channel 1: 2412MHz      Channel 3: 2422MHz

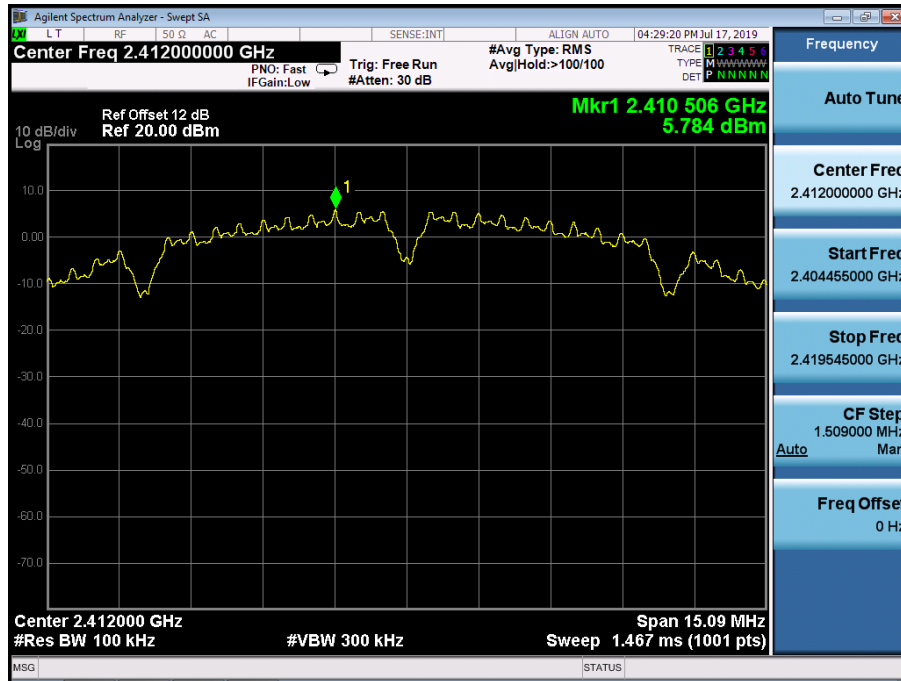

Unwanted Emissions in non-restricted frequency bands

Test Model      802.11b      802.11g      802.11n(HT20)      802.11n(HT40)

Channel 1: 2412MHz      Channel 3: 2422MHz

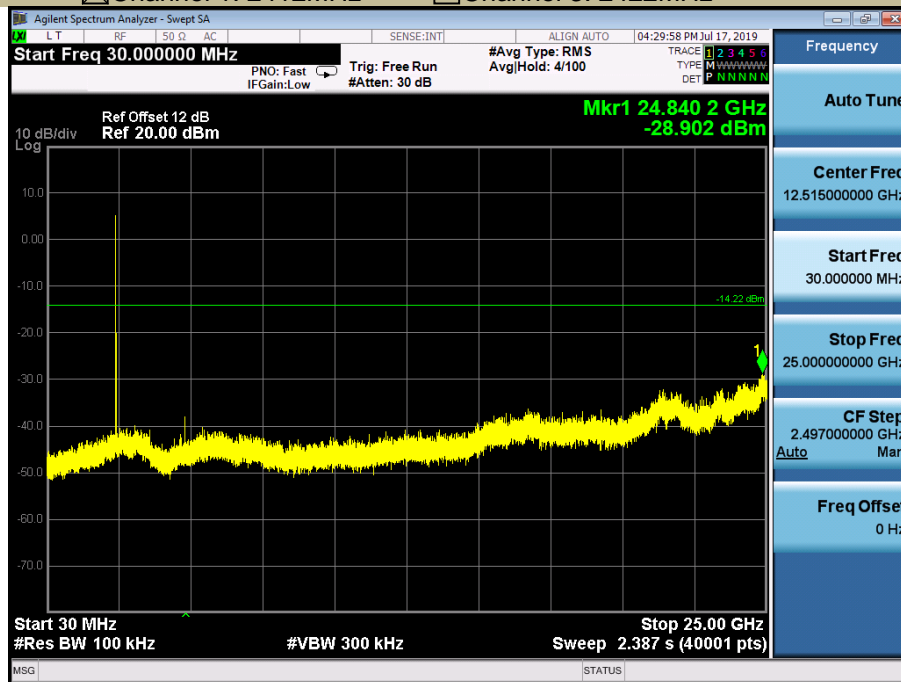

Test Model  802.11b  802.11g  802.11n(HT20)  802.11n(HT40)  
 Channel 1: 2412MHz  Channel 3: 2422MHz

Band edge



Test Model  802.11b  802.11g  802.11n(HT20)  802.11n(HT40)  
 Channel 6: 2437MHz

PSD(Power Spectral Density ) RBW=100kHz

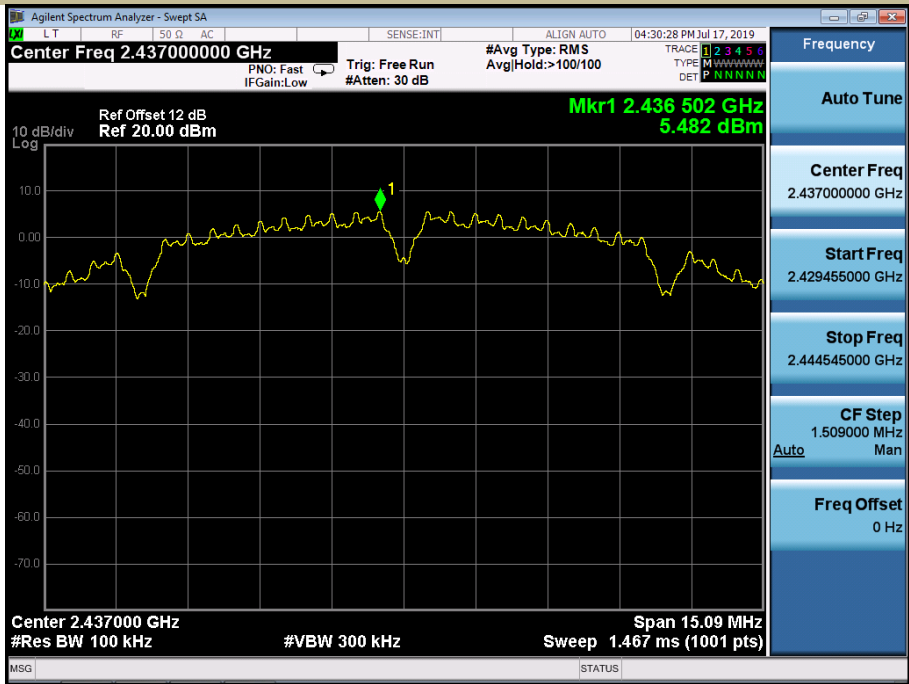

Unwanted Emissions In Non-Restricted Frequency Bands

Test Model     802.11b     802.11g     802.11n(HT20)     802.11n(HT40)

Channel 6: 2437MHz

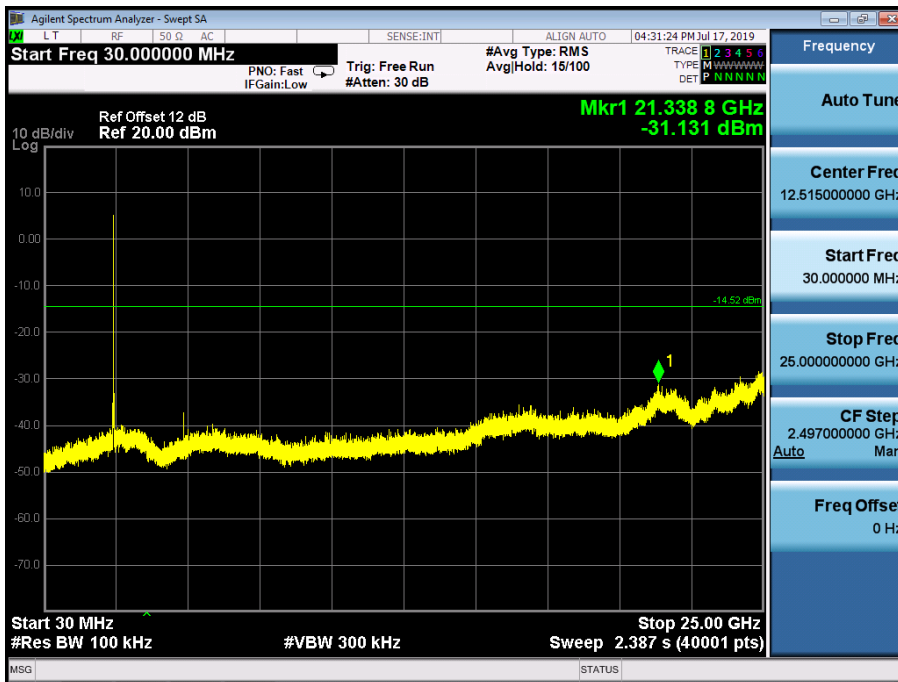

PSD(Power Spectral Density) RBW=100kHz

Test Model     802.11b     802.11g     802.11n(HT20)     802.11n(HT40)

Channel 11: 2462MHz     Channel 9: 2452MHz

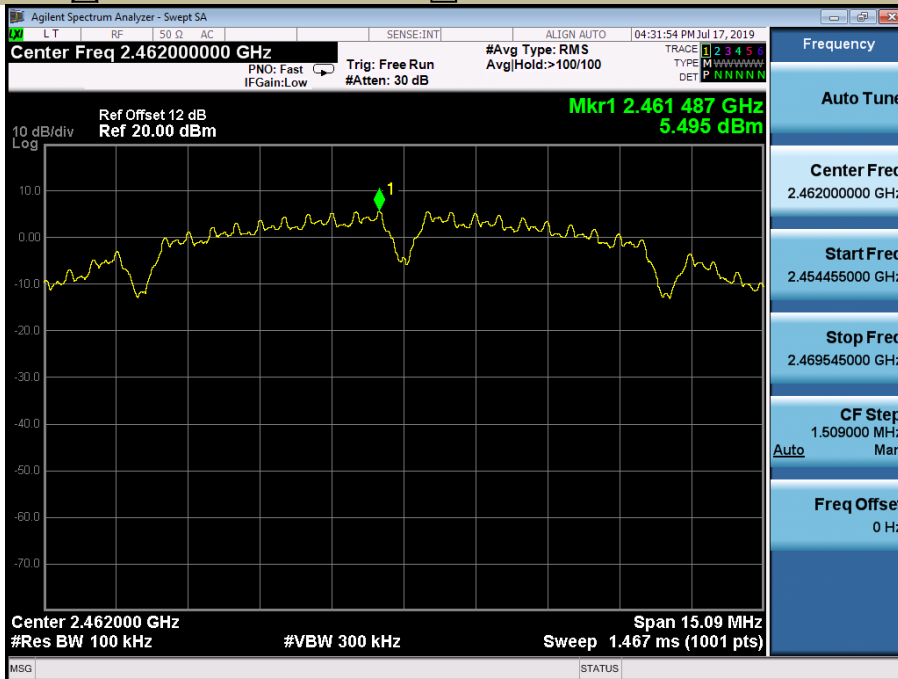

Unwanted Emissions In Non-Restricted Frequency Bands

Test Model  802.11b  802.11g  802.11n(HT20)  802.11n(HT40)

Channel 11: 2462MHz  Channel 9: 2452MHz

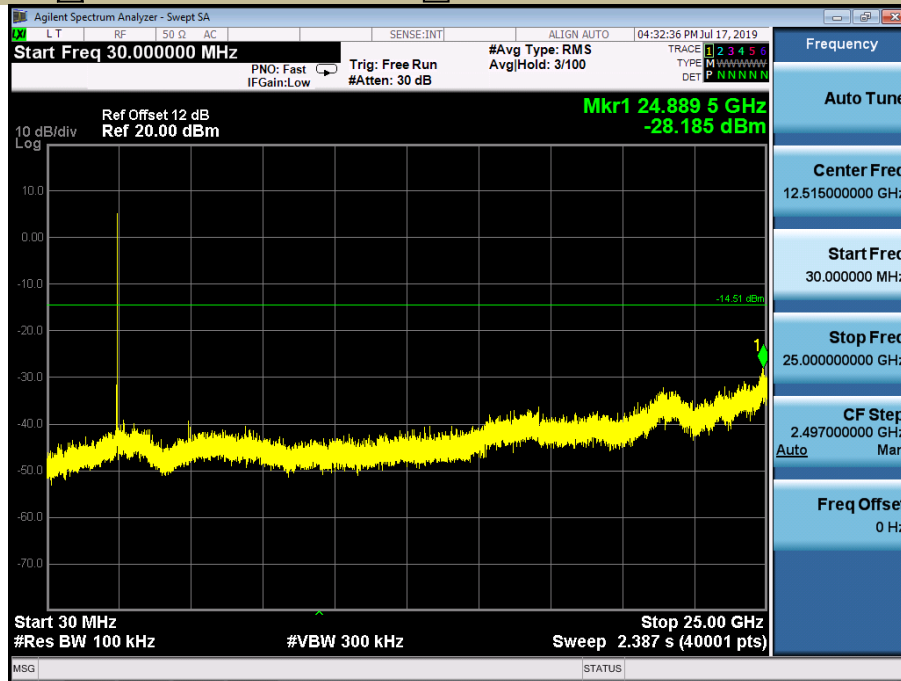

Band edge

Test Model  802.11b  802.11g  802.11n(HT20)  802.11n(HT40)

Channel 11: 2462MHz  Channel 9: 2452MHz

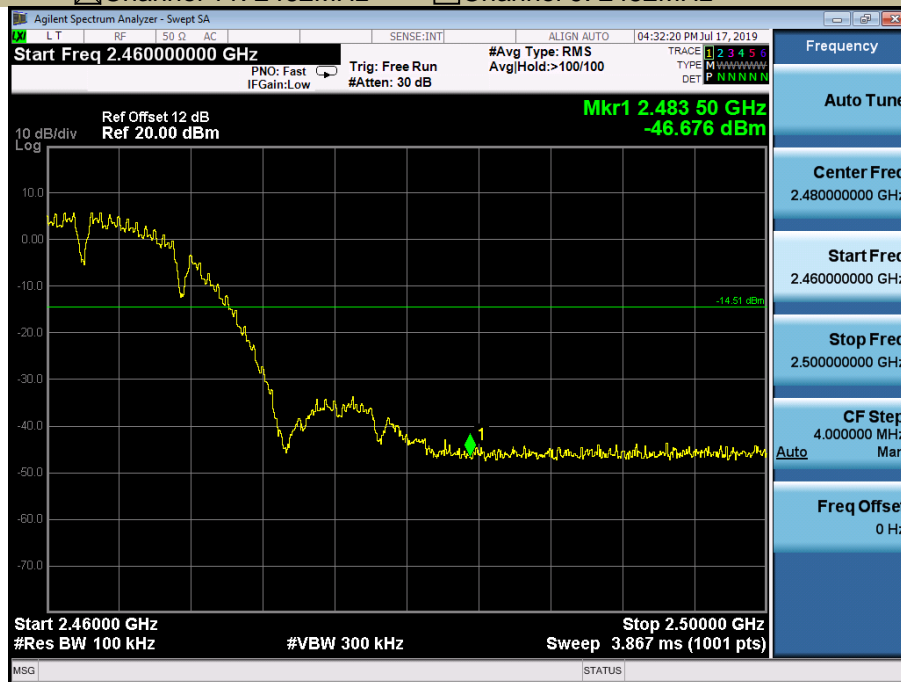

## 8.5 RADIATED SPURIOUS EMISSION

### 8.5.1 Applicable Standard

According to FCC Part 15.247(d) and 15.209 and KDB 558074 D01 15.247 Meas Guidance v05r02

### 8.5.2 Conformance Limit

According to FCC Part 15.247(d): radiated emissions which fall in the restricted bands, as defined in §15.205(a), must also comply with the radiated emission limits specified in §15.209(a) (see §15.205(c)).

According to FCC Part 15.205, Restricted bands

MHz	MHz	MHz	GHz
0.090-0.110	16.42-16.423	399.9-410	4.5-5.15
10.495-0.505	16.69475-16.69525	608-614	5.35-5.46
2.1735-2.1905	16.80425-16.80475	960-1240	7.25-7.75
4.125-4.128	25.5-25.67	1300-1427	8.025-8.5
4.17725-4.17775	37.5-38.25	1435-1626.5	9.0-9.2
4.20725-4.20775	73-74.6	1645.5-1646.5	9.3-9.5
6.215-6.218	74.8-75.2	1660-1710	10.6-12.7
6.26775-6.26825	123-138	2200-2300	14.47-14.5
8.291-8.294	149.9-150.05	2310-2390	15.35-16.2
8.362-8.366	156.52475-156.52525	2483.5-2500	17.7-21.4
8.37625-8.38675	156.7-156.9	2690-2900	22.01-23.12
8.41425-8.41475	162.0125-167.17	3260-3267	23.6-24.0
12.29-12.293	167.72-173.2	3332-3339	31.2-31.8
12.51975-12.52025	240-285	3345.8-3358	36.43-36.5
12.57675-12.57725	322-335.4	3600-4400	(2)
13.36-13.41			

According to FCC Part 15.205, the level of any transmitter spurious emission in Restricted bands shall not exceed the level of the emission specified in the following table

Restricted Frequency(MHz)	Field Strength ( $\mu\text{V/m}$ )	Field Strength ( $\text{dB}\mu\text{V/m}$ )	Measurement Distance
0.009-0.490	2400/F(KHz)	20 log ( $\mu\text{V/m}$ )	300
0.490-1.705	2400/F(KHz)	20 log ( $\mu\text{V/m}$ )	30
1.705-30	30	29.5	30
30-88	100	40	3
88-216	150	43.5	3
216-960	200	46	3
Above 960	500	54	3

### 8.5.3 Test Configuration

Test according to clause 7.2 radio frequency test setup 2

### 8.5.4 Test Procedure

This test is required for any spurious emission that falls in a Restricted Band, as defined in Section 15.205. It must be performed with the highest gain of each type of antenna proposed for use with the EUT. Use the following spectrum analyzer settings:

The EUT was placed on a turn table which is 0.8m above ground plane.

Maximum procedure was performed on the highest emissions to ensure EUT compliance.

Span = wide enough to fully capture the emission being measured

RBW = 1 MHz for  $f \geq 1$  GHz (1GHz to 25GHz), 100 kHz for  $f < 1$  GHz (30MHz to 1GHz), 200Hz for  $f < 150$  KHz (9KHz to 150KHz), 9KHz for  $f < 30$  MHz (150KHz to 30KHz)

VBW  $\geq$  RBW

Sweep = auto

Detector function = peak

Trace = max hold

Follow the guidelines in ANSI C63.10-2013 with respect to maximizing the emission by rotating the EUT, measuring the emission while the EUT is situated in three orthogonal planes (if appropriate), adjusting the

measurement antenna height and polarization, etc. A pre-amp and a high pass filter are required for this test, in order to provide the measuring system with sufficient sensitivity. Allow the trace to stabilize. The peak reading of the emission, after being corrected by the antenna factor, cable loss, pre-amp gain, etc., is the peak field strength, which must comply with the limit specified in Section 15.35(b). Submit this data. Now set the VBW to 10 Hz, while maintaining all of the other instrument settings. This peak level, once corrected, must comply with the limit specified in Section 15.209. If the dwell time per channel of the hopping signal is less than 100 ms, then the reading obtained with the 10 Hz VBW may be further adjusted by a “duty cycle correction factor”, derived from  $20\log(\text{dwell time}/100 \text{ ms})$ , in an effort to demonstrate compliance with the 15.209 limit. Submit this data. Repeat above procedures until all frequency measured was complete.

### 8.5.5 Test Results

Temperature:	26° C
Relative Humidity:	54%
ATM Pressure:	1011 mbar

#### ■ Spurious Emission below 30MHz(9KHz to 30MHz)

Freq. (MHz)	Ant.Pol. H/V	Emission Level(dBuV/m)		Limit 3m(dBuV/m)		Over(dB)	
		PK	AV	PK	AV	PK	AV
--	--	--	--	--	--	--	--

Note: the amplitude of spurious emission that is attenuated by more than 20dB below the permissible limit has no need to be reported.

Distance extrapolation factor =  $40\log(\text{Specific distance}/ \text{test distance})$  (dB);

Limit line=Specific limits(dBuV) + distance extrapolation factor

#### ■ Spurious Emission Above 1GHz(1GHz to 25GHz)

All 2.4G 802.11b/g/n SISO and MIMO Modes have been tested, and the worst result recorded was report as below:

Test mode: 802.11 b Frequency: Channel 1: 2412MHz

Freq. (MHz)	Ant.Pol. H/V	Emission Level(dBuV/m)		Limit 3m(dBuV/m)		Over(dB)	
		PK	AV	PK	AV	PK	AV
7237.30	V	57.38	50.31	74	54	-16.62	-3.69
11126.05	V	60.45	45.95	74	54	-13.55	-8.05
14668.00	V	62.12	47.65	74	54	-11.88	-6.35
8251.35	H	53.79	43.12	74	54	-20.21	-10.88
11209.35	H	59.90	44.95	74	54	-14.10	-9.05
15084.50	H	61.85	46.35	74	54	-12.15	-7.65

Test mode: 802.11 b Frequency: Channel 6: 2437MHz

Freq. (MHz)	Ant.Pol. H/V	Emission Level(dBuV/m)		Limit 3m(dBuV/m)		Over(dB)	
		PK	AV	PK	AV	PK	AV
7309.55	V	57.72	50.42	74	54	-16.28	-3.58
11313.90	V	59.80	46.26	74	54	-14.20	-7.74
14586.40	V	62.04	50.36	74	54	-11.96	-3.64
7312.10	H	53.83	50.66	74	54	-20.17	-3.34
11509.40	H	60.37	45.26	74	54	-13.63	-8.74
14662.90	H	62.31	47.35	74	54	-11.69	-6.65



Test mode: 802.11 b Frequency: Channel 11: 2462MHz

Freq. (MHz)	Ant.Pol. H/V	Emission Level(dBuV/m)		Limit 3m(dBuV/m)		Over(dB)	
		PK	AV	PK	AV	PK	AV
7388.60	V	57.49	50.86	74	54	-16.51	-3.14
12170.70	V	60.30	45.95	74	54	-13.70	-8.05
14035.60	V	62.42	47.36	74	54	-11.58	-6.64
7386.90	H	56.75	50.77	74	54	-17.25	-3.23
11702.35	H	60.23	45.40	74	54	-13.77	-8.60
14601.70	H	62.85	47.32	74	54	-11.15	-6.68

- Note:** (1) All Readings are Peak Value (VBW=3MHz) and Peak Value (VBW=10Hz).  
(2) Emission Level= Reading Level+Correct Factor +Cable Loss.  
(3) Correct Factor= Ant\_F + Cab\_L - Preamp  
(4)Data of measurement within this frequency range shown “ -- ” in the table above means the reading of emissions are attenuated more than 20dB below the permissible limits or the field strength is too small to be measured.

■ Spurious Emission in Restricted Band 2310-2390MHz and 2483.5-2500MHz

All 2.4G 802.11b/g/n SISO and MIMO Modes have been tested, and the worst result recorded was report as below:

Test mode: 802.11 b Frequency: Channel 1: 2412MHz

Frequency (MHz)	Polarity	PK(dBuV/m) (VBW=3MHz)	Limit 3m (dBuV/m)	Over(dB)	AV(dBuV/m) (VBW=10Hz)	Limit 3m (dBuV/m)	Over(dB)
2384.020	V	52.18	74	-21.82	43.99	54	-10.01
2387.804	H	52.02	74	-21.98	44.29	54	-9.71

Test mode: 802.11 b Frequency: Channel 11: 2462MHz

Frequency (MHz)	Polarity	PK(dBuV/m) (VBW=3MHz)	Limit 3m (dBuV/m)	Over(dB)	AV(dBuV/m) (VBW=10Hz)	Limit 3m (dBuV/m)	Over(dB)
2484.008	V	52.49	74	-21.51	44.76	54	-9.24
2484.574	H	52.19	74	-21.81	44.26	54	-9.74

- Note:**
- (1) All Readings are Peak Value (VBW=3MHz) and Peak Value (VBW=10Hz).
  - (2) Emission Level= Reading Level+Correct Factor +Cable Loss.
  - (3) Correct Factor= Ant\_F + Cab\_L - Preamp
  - (4)Data of measurement within this frequency range shown “ -- ” in the table above means the reading of emissions are attenuated more than 20dB below the permissible limits or the field strength is too small to be measured.

**Spurious Emission in Restricted Band 2310-2390MHz**

Test Model     802.11b     802.11g     802.11n(HT20)     802.11n(HT40)  
 Channel 1: 2412MHz     Channel 3: 2422MHz    Polarity: V  
 VBW=3MHz

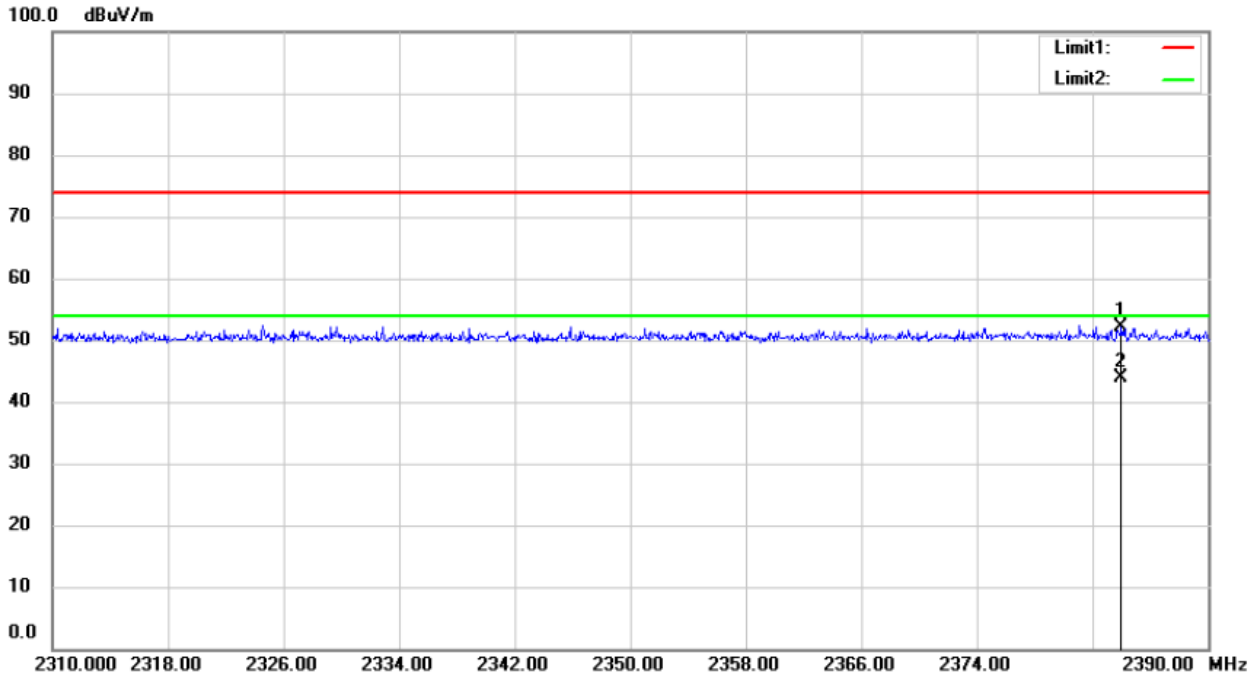

**Spurious Emission in Restricted Band 2310-2390MHz**

Test Model     802.11b     802.11g     802.11n(HT20)     802.11n(HT40)  
 Channel 1: 2412MHz     Channel 3: 2422MHz    Polarity:H  
 VBW=3MHz

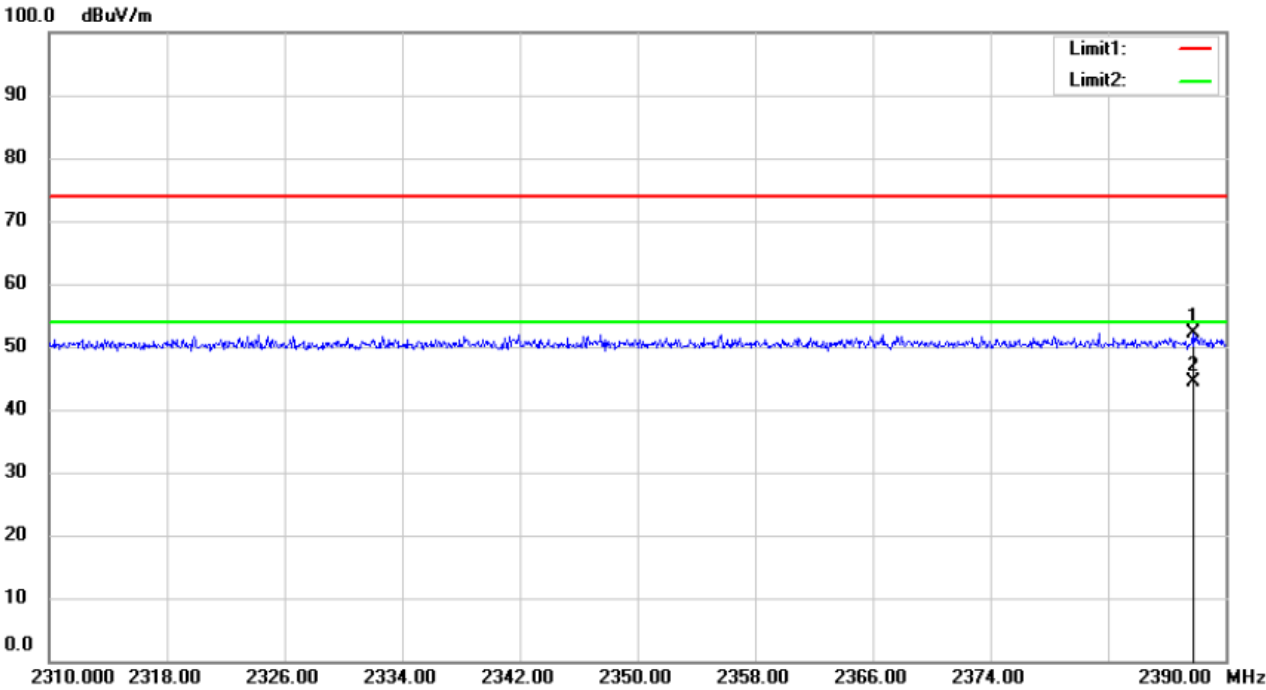

Spurious Emission in Restricted Band 2483.5-2500MHz

Test Model	<input checked="" type="checkbox"/> 802.11b	<input type="checkbox"/> 802.11g	<input type="checkbox"/> 802.11n(HT20)	<input type="checkbox"/> 802.11n(HT40)
	<input checked="" type="checkbox"/> Channel 11: 2462MHz	<input type="checkbox"/> Channel 9: 2452MHz	Polarity: V	
	VBW=3MHz			

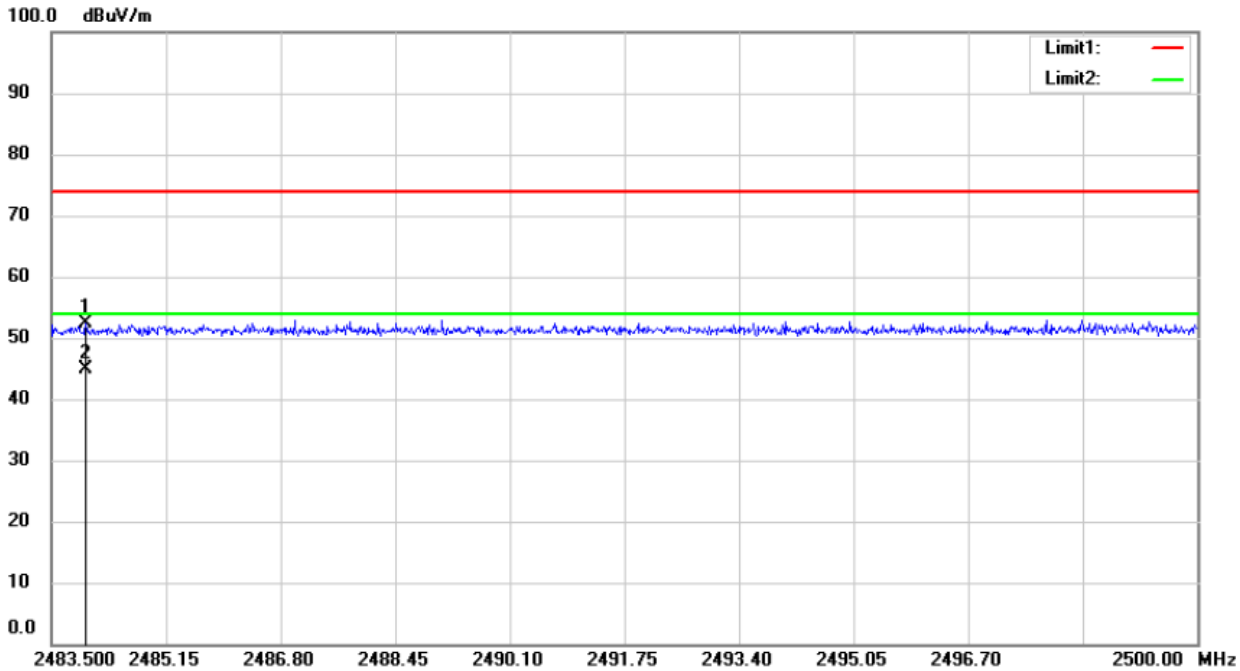

Spurious Emission in Restricted Band 2483.5-2500MHz

Test Model	<input checked="" type="checkbox"/> 802.11b	<input type="checkbox"/> 802.11g	<input type="checkbox"/> 802.11n(HT20)	<input type="checkbox"/> 802.11n(HT40)
	<input checked="" type="checkbox"/> Channel 11: 2462MHz	<input type="checkbox"/> Channel 9: 2452MHz	Polarity: H	
	VBW=3MHz			

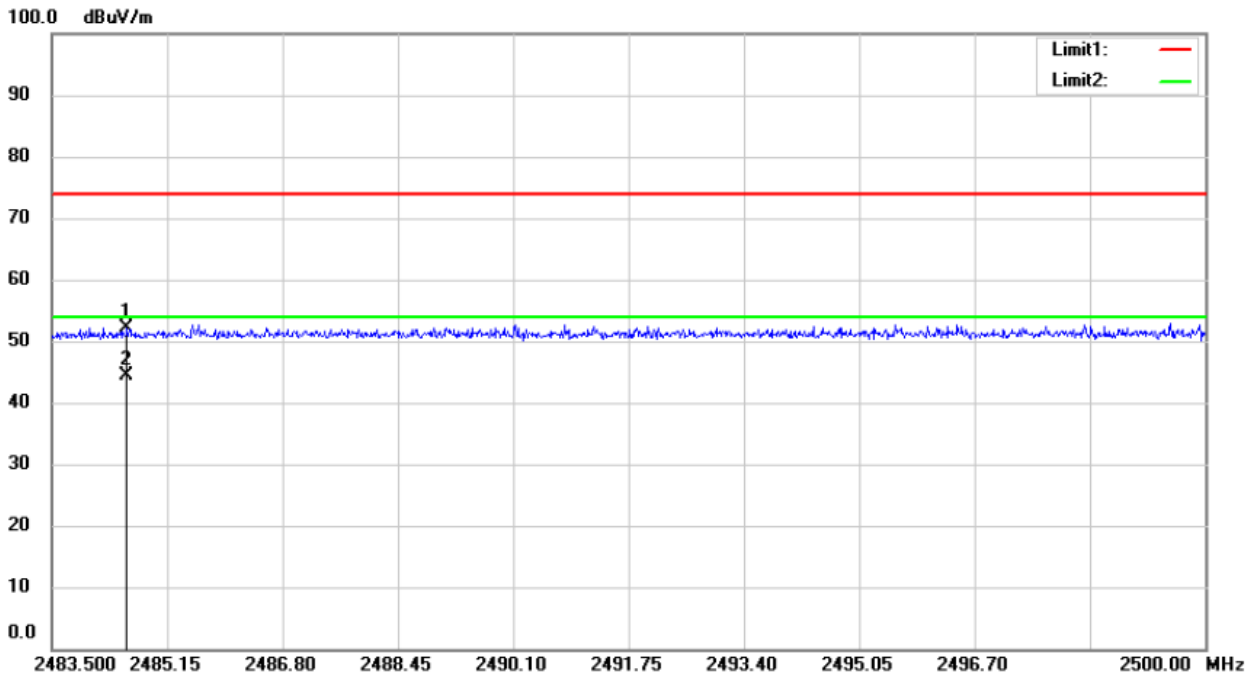

■ Spurious Emission below 1GHz (30MHz to 1GHz)

All modes have been tested, and the worst result (802.11b siso mode ant 1) recorded was report as below:

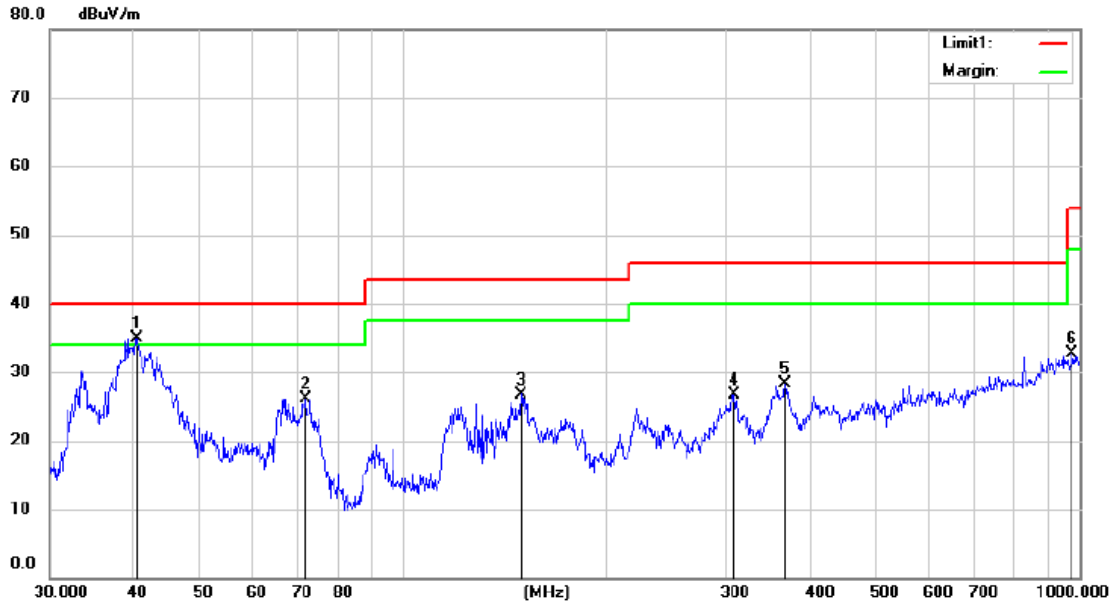

Site: 3m Chamber #1      Polarization: **Vertical**      Temperature: 29.5 C  
 Limit: (RE)FCC PART 15 C      Power: AC 230V/50Hz      Humidity: 48 %  
 Mode: 802.11b Low channel  
 Note:

No.	Mk.	Freq. MHz	Reading Level dBuV	Correct Factor dB	Measure- ment dBuV/m	Limit dBuV/m	Over dB	Detector	Antenna Height cm	Table Degree	Comment
1	*	40.3640	47.15	-12.19	34.96	40.00	-5.04	QP			
2		71.8950	42.12	-15.92	26.20	40.00	-13.80	QP			
3		149.6168	42.15	-15.35	26.80	43.50	-16.70	QP			
4		308.9125	34.83	-8.13	26.70	46.00	-19.30	QP			
5		367.9503	35.26	-8.89	28.37	46.00	-17.63	QP			
6		976.1806	29.31	3.41	32.72	54.00	-21.28	QP			

\*:Maximum data    x:Over limit    !:over margin

Operator: CTR

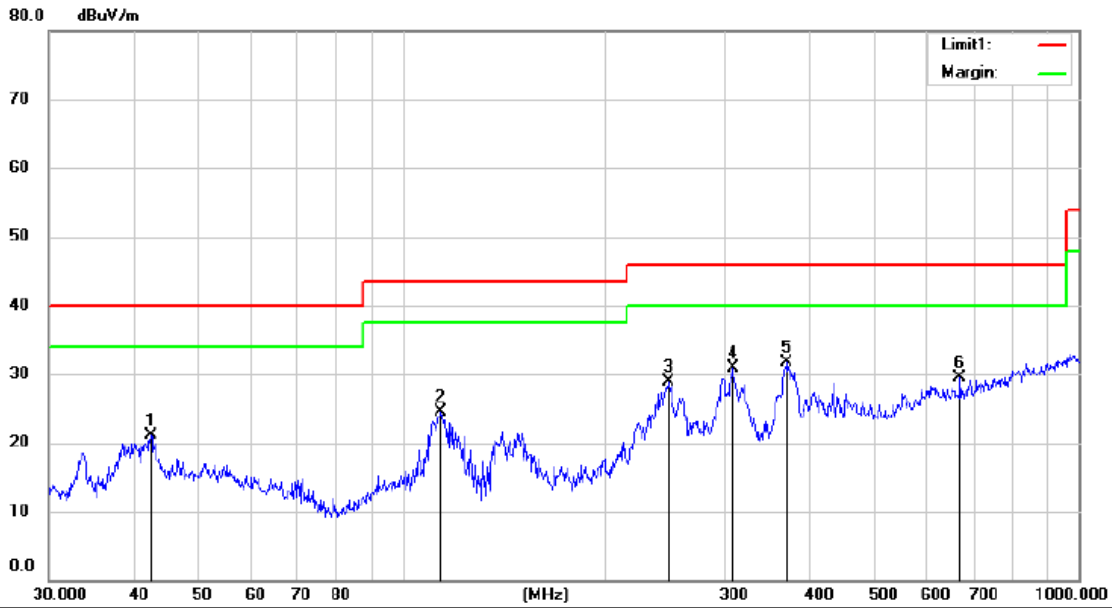

Site: 3m Chamber #1      Polarization: **Horizontal**      Temperature: 29.5 C  
 Limit: (RE)FCC PART 15 C      Power: AC 230V/50Hz      Humidity: 48 %  
 Mode: 802.11b Low channel  
 Note:

No.	Mk.	Freq. MHz	Reading Level dBuV	Correct Factor dB	Measure- ment dBuV/m	Limit dBuV/m	Over dB	Antenna Height cm	Table Degree degree	Detector	Comment
1		42.5067	32.61	-11.55	21.06	40.00	-18.94			QP	
2		114.1638	37.57	-13.16	24.41	43.50	-19.09			QP	
3		248.4430	38.75	-9.93	28.82	46.00	-17.18			QP	
4		308.5067	39.14	-8.14	31.00	46.00	-15.00			QP	
5	*	371.0274	38.55	-6.87	31.68	46.00	-14.32			QP	
6		668.7282	31.00	-1.50	29.50	46.00	-16.50			QP	

\*:Maximum data    x:Over limit    !:over margin

Operator: CTR

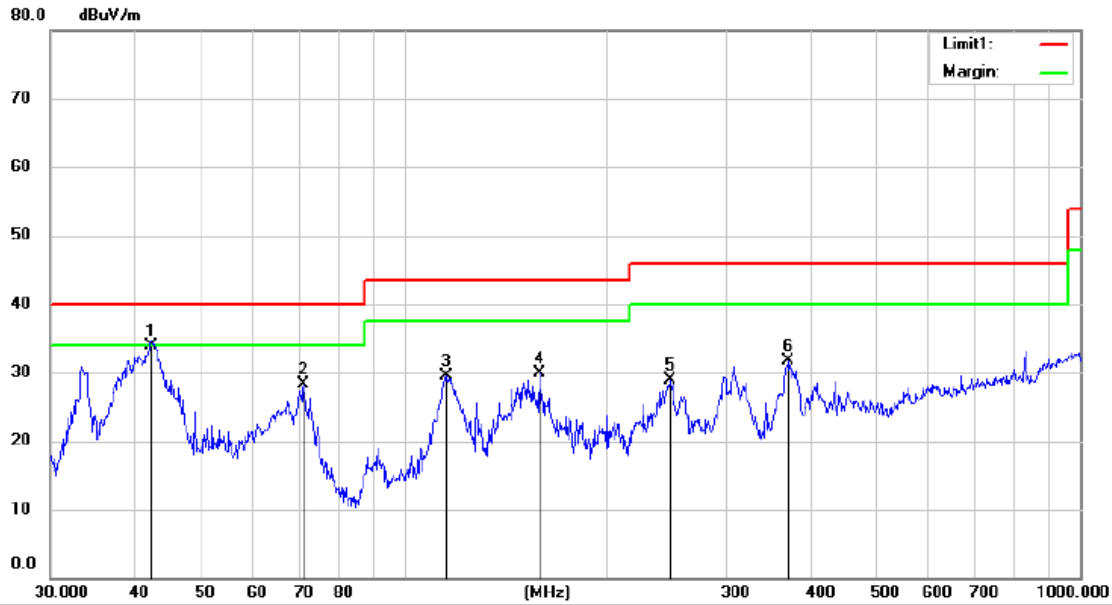

Site: 3m Chamber #1      Polarization: **Vertical**      Temperature: 29.5 C  
 Limit: (RE)FCC PART 15 C      Power: AC 230V/50Hz      Humidity: 48 %  
 Mode: 802.11b Mid channel  
 Note:

No.	Mk.	Freq. MHz	Reading Level dBuV	Correct Factor dB	Measure- ment dBuV/m	Limit dBuV/m	Over dB	Antenna Height cm	Table Degree degree	Comment
1	*	42.4136	45.46	-11.56	33.90	40.00	-6.10	QP		
2		71.1115	44.01	-15.68	28.33	40.00	-11.67	QP		
3		115.7764	42.93	-13.39	29.54	43.50	-13.96	QP		
4		158.7373	44.65	-14.81	29.84	43.50	-13.66	QP		
5		248.4430	38.75	-9.93	28.82	46.00	-17.18	QP		
6		371.0274	38.55	-8.87	31.68	46.00	-14.32	QP		

\*:Maximum data    x:Over limit    !:over margin

Operator: CTR

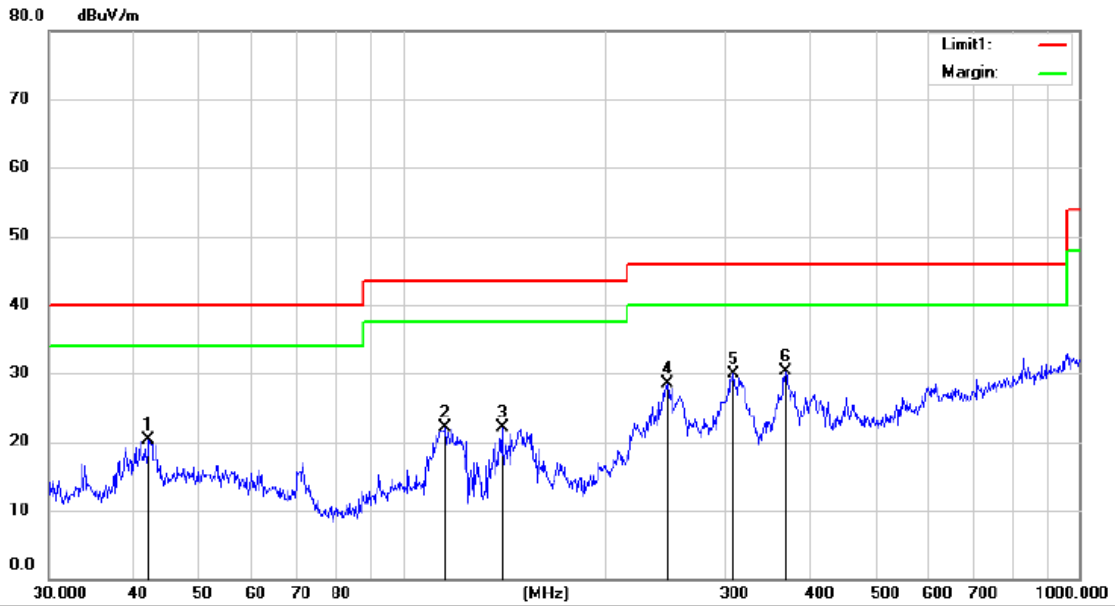

Site: 3m Chamber #1      Polarization: **Horizontal**      Temperature: 29.5 C  
 Limit: (RE)FCC PART 15 C      Power: AC 230V/50Hz      Humidity: 48 %  
 Mode: 802.11b Mid channel  
 Note:

No.	Mk.	Freq. MHz	Reading Level dBuV	Correct Factor dB	Measure- ment dBuV/m	Limit dBuV/m	Over dB	Antenna Height cm	Table Degree	Detector	Comment
1		42.2096	31.88	-11.59	20.29	40.00	-19.71			QP	
2		115.7763	35.58	-13.39	22.19	43.50	-21.31			QP	
3		140.3420	37.79	-15.61	22.18	43.50	-21.32			QP	
4		247.5733	38.37	-9.96	28.41	46.00	-17.59			QP	
5		309.7260	38.06	-8.13	29.93	46.00	-16.07			QP	
6	*	368.2730	37.26	-6.90	30.36	46.00	-15.64			QP	

\*:Maximum data    x:Over limit    !:over margin

Operator: CTR



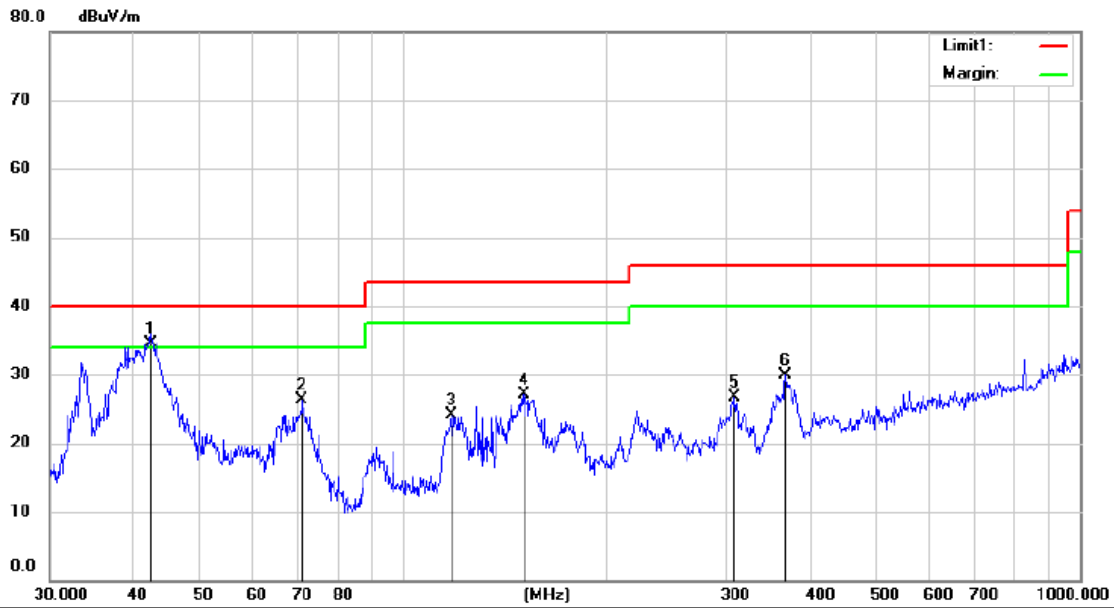

Site: 3m Chamber #1      Polarization: **Vertical**      Temperature: 29.5 C  
 Limit: (RE)FCC PART 15 C      Power: AC 230V/50Hz      Humidity: 48 %  
 Mode: 802.11b high channel  
 Note:

No.	Mk.	Freq. MHz	Reading Level dBuV	Correct Factor dB	Measure- ment dBuV/m	Limit dBuV/m	Over dB	Antenna Height cm	Table Degree	Comment
1	*	42.3022	46.07	-11.57	34.50	40.00	-5.50	QP		
2		70.9247	41.92	-15.62	26.30	40.00	-13.70	QP		
3		118.1344	37.91	-13.78	24.13	43.50	-19.37	QP		
4		151.4643	42.42	-15.25	27.17	43.50	-16.33	QP		
5		308.9125	34.83	-8.13	26.70	46.00	-19.30	QP		
6		367.9503	36.76	-6.89	29.87	46.00	-16.13	QP		

\*:Maximum data    x:Over limit    !:over margin

Operator: CTR

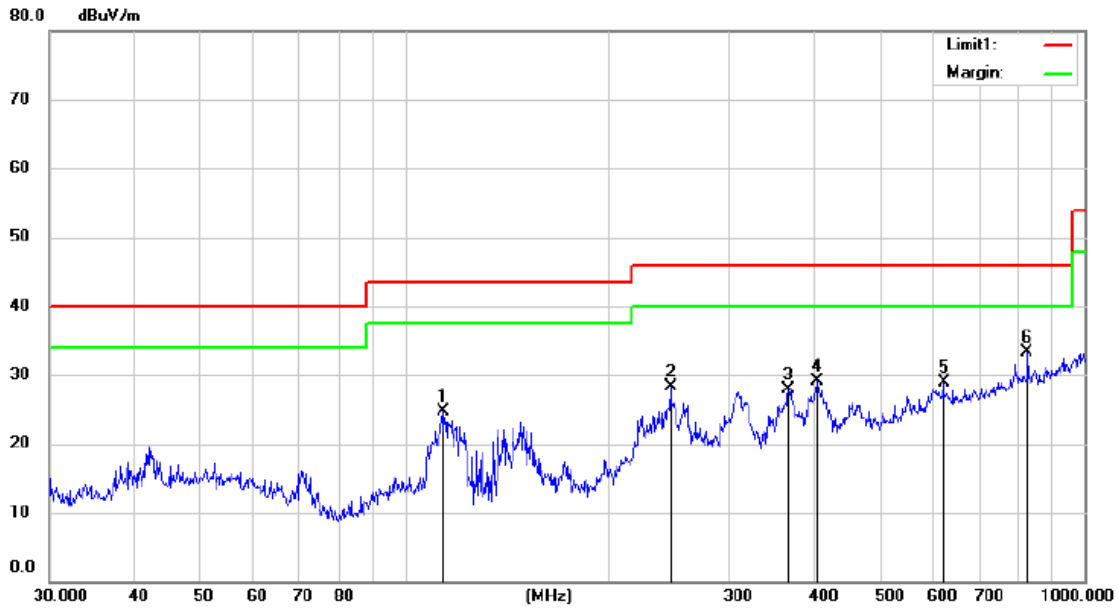

Site: 3m Chamber #1      Polarization: *Horizontal*      Temperature: 29.5 C  
 Limit: (RE)FCC PART 15 C      Power: AC 230V/50Hz      Humidity: 48 %  
 Mode: 802.11b high channel  
 Note:

No.	Mk.	Freq. MHz	Reading Level dBuV	Correct Factor dB	Measure- ment dBuV/m	Limit dBuV/m	Over dB	Antenna Height cm	Table Degree	Comment
1		113.8640	37.76	-13.11	24.65	43.50	-18.85	QP		
2		246.3825	38.35	-9.98	28.37	46.00	-17.63	QP		
3		367.9503	34.87	-6.89	27.98	46.00	-18.02	QP		
4		405.3766	34.97	-5.87	29.10	46.00	-16.90	QP		
5		622.6170	30.78	-1.90	28.88	46.00	-17.12	QP		
6	*	827.1308	32.70	0.54	33.24	46.00	-12.76	QP		

\*:Maximum data    x:Over limit    !:over margin

Operator: CTR

**8.6 CONDUCTED EMISSIONS TEST**

8.6.1 Applicable Standard

According to FCC Part 15.207(a)

8.6.2 Conformance Limit

Frequency(MHz)	Conducted Emission Limit	
	Quasi-peak	Average
0.15-0.5	66-56	56-46
0.5-5.0	56	46
5.0-30.0	60	50

Note: 1. The lower limit shall apply at the transition frequencies  
 2. The limit decreases in line with the logarithm of the frequency in the range of 0.15 to 0.50MHz.

8.6.3 Test Configuration

Test according to clause 7.3conducted emission test setup

8.6.4 Test Procedure

The EUT was placed on a table which is 0.8m above ground plane.  
 Maximum procedure was performed on the highest emissions to ensure EUT compliance.  
 Repeat above procedures until all frequency measured were complete.

8.6.5 Test Results

Pass

The 120V &240V voltagehave been tested, and the worst result recorded was report as below:

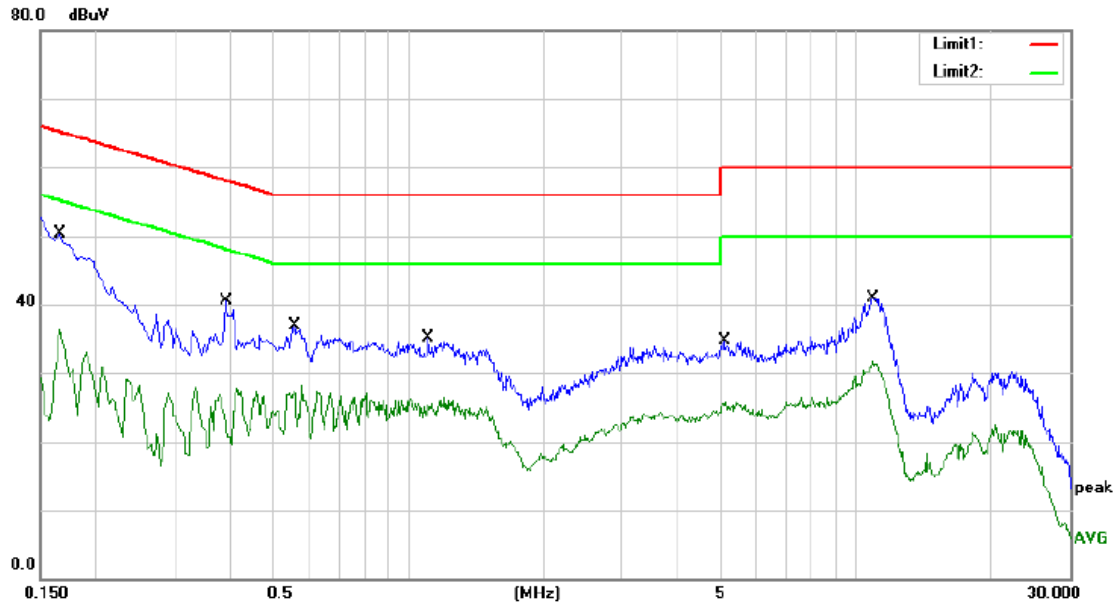

Site: Conduction #1  
 Limit: (CE)FCC PART 15 class B\_QP  
 Mode: Wifi Mode  
 Note:

Phase: **L1**  
 Power: AC 120V/60Hz

Temperature: 24.9  
 Humidity: 54 %

No.	Mk.	Freq. MHz	Reading Level dBuV	Correct Factor dB	Measure- ment dBuV	Limit dBuV	Over dB	Detector	Comment
1	*	0.1680	40.65	9.57	50.22	65.16	-14.94	QP	
2		0.1680	26.72	9.57	36.29	55.16	-18.87	AVG	
3		0.3900	30.86	9.57	40.43	58.06	-17.63	QP	
4		0.3900	16.80	9.57	26.37	48.06	-21.69	AVG	
5		0.5580	27.31	9.57	36.88	56.00	-19.12	QP	
6		0.5580	17.63	9.57	27.20	46.00	-18.80	AVG	
7		1.1100	25.56	9.59	35.15	56.00	-20.85	QP	
8		1.1100	15.87	9.59	25.46	46.00	-20.54	AVG	
9		5.0740	24.96	9.66	34.62	60.00	-25.38	QP	
10		5.0740	16.08	9.66	25.74	50.00	-24.26	AVG	
11		10.9100	31.17	9.81	40.98	60.00	-19.02	QP	
12		10.9100	21.86	9.81	31.67	50.00	-18.33	AVG	

\*:Maximum data    x:Over limit    !:over margin    Comment: Factor build in receiver.    Operator: wolf

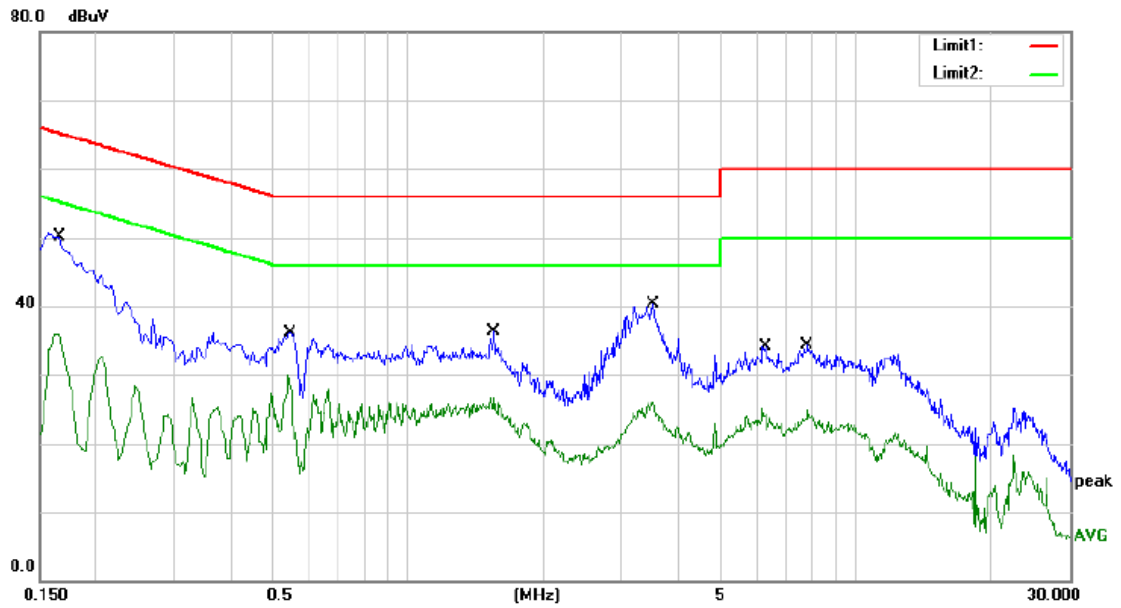

Site Conduction #1 Phase: **N** Temperature: 24.9  
 Limit: (CE)FCC PART 15 class B\_QP Power: AC 120V/60Hz Humidity: 54 %  
 Mode: Wfi Mode  
 Note:

No.	Mk.	Freq. MHz	Reading Level dBuV	Correct Factor dB	Measure- ment dBuV	Limit dBuV	Over dB	Detector	Comment
1	*	0.1660	40.58	9.57	50.15	65.16	-15.01	QP	
2		0.1660	26.39	9.57	35.96	55.16	-19.20	AVG	
3		0.5460	26.57	9.57	36.14	56.00	-19.86	QP	
4		0.5460	20.27	9.57	29.84	46.00	-16.16	AVG	
5		1.5580	26.71	9.59	36.30	56.00	-19.70	QP	
6		1.5580	17.09	9.59	26.68	46.00	-19.32	AVG	
7		3.5260	30.69	9.63	40.32	56.00	-15.68	QP	
8		3.5260	16.55	9.63	26.18	46.00	-19.82	AVG	
9		6.2780	24.50	9.70	34.20	60.00	-25.80	QP	
10		6.2780	15.35	9.70	25.05	50.00	-24.95	AVG	
11		7.7980	24.51	9.74	34.25	60.00	-25.75	QP	
12		7.7980	15.25	9.74	24.99	50.00	-25.01	AVG	

\*:Maximum data x:Over limit !:over margin Comment: Factor build in receiver. Operator: wolf

**8.7 ANTENNA APPLICATION**

8.7.1 Antenna Requirement

Standard	Requirement
FCC CRF Part15.203	An intentional radiator shall be designed to ensure that no antenna other than that furnished by the responsible party shall be used with the device. The use of a permanently attached antenna or of an antenna that uses a unique coupling to the intentional radiator shall be considered sufficient to comply with the provisions of this section. The manufacturer may design the unit so that a broken antenna can be replaced by the user, but the use of a standard antenna jack or electrical connector is prohibited. This requirement does not apply to carrier current devices or to devices operated under the provisions of §15.211, §15.213, §15.217, §15.219, or §15.221. Further, this requirement does not apply to intentional radiators that must be professionally installed, such as perimeter protection systems and some field disturbance sensors, or to other intentional radiators which, in accordance with §15.31(d), must be measured at the installation site. However, the installer shall be responsible for ensuring that the proper antenna is employed so that the limits in this part are not exceeded.

For intentional device, according to FCC 47 CFR Section 15.203, an intentional radiator shall be designed to ensure that no antenna other than that furnished by the responsible party shall be used with the device. And according to FCC 47 CFR Section 15.247 (b), if transmitting antennas of directional gain greater than 6dBi are used, the power shall be reduced by the amount in dB that the directional gain of the antenna exceeds 6dBi.

8.7.2 Result

PASS.

- The EUT has two antennas: an metal Antenna for WIFI 2.4G, the gain is 2 dBi

- Note:
- Antenna uses a permanently attached antenna which is not replaceable.
  - Not using a standard antenna jack or electrical connector for antenna replacement
  - The antenna has to be professionally installed (please provide method of installation)

Which in accordance to section 15.203, please refer to the internal photos.

Detail of factor for radiated emission

Frequency(MHz)	Ant_F(dB)	Cab_L(dB)	Preamp(dB)	Correct Factor(dB)
0.009	20.6	0.03	\	20.63
0.15	20.7	0.1	\	20.8
1	20.9	0.15	\	21.05
10	20.1	0.28	\	20.38
30	18.8	0.45	\	19.25
30	11.7	0.62	27.9	-15.58
100	12.5	1.02	27.8	-14.28
300	12.9	1.91	27.5	-12.69
600	19.2	2.92	27	-4.88
800	21.1	3.54	26.6	-1.96
1000	22.3	4.17	26.2	0.27
1000	25.6	1.76	41.4	-14.04
3000	28.9	3.27	43.2	-11.03
5000	31.1	4.2	44.6	-9.3
8000	36.2	5.95	44.7	-2.55
10000	38.4	6.3	43.9	0.8
12000	38.5	7.14	42.3	3.34
15000	40.2	8.15	41.4	6.95
18000	45.4	9.02	41.3	13.12
18000	37.9	1.81	47.9	-8.19
21000	37.9	1.95	48.7	-8.85
25000	39.3	2.01	42.8	-1.49
28000	39.6	2.16	46.0	-4.24
31000	41.2	2.24	44.5	-1.06
34000	41.5	2.29	46.6	-2.81
37000	43.8	2.30	46.4	-0.3
40000	43.2	2.50	42.2	3.5