



Test Report No.:  
**FCCSZ2024-0007-RF2**

## RF Test Report

**FCC ID** : 2AOKI-AL7663BWGA  
**EUT** : WIFI Module  
**MODEL** : See Section 2.2  
**BRAND NAME** : N/A  
**APPLICANT** : Sichuan AI-Link Technology Co.,Ltd.  
**Classification Of Test** : N/A

**CVC Testing Technology (Shenzhen) Co., Ltd.**

<b>Applicant</b>		Name: Sichuan AI-Link Technology Co.,Ltd. Address:Anzhou Industrial Park, Mianyang, Sichuan, P.R.C	
<b>Manufacturer</b>		Name: Sichuan AI-Link Technology Co.,Ltd. Address:Anzhou Industrial Park, Mianyang, Sichuan, P.R.C	
<b>Equipment Under Test</b>		Product Name:WIFI Module Model/Type: See Section 2.2 Brand Name: N/A Serial NO.: N/A Sample NO.:3-1	
Date of Receipt.	2024.02.21	Date of Testing	2024.02.21~2024.03.20
<b>Test Specification</b>		<b>Test Result</b>	
FCC Part 15, Subpart E (15.407)		PASS	
<b>Evaluation of Test Result</b>	The equipment under test was found to comply with the requirements of the standards applied.  Seal of CVC <b>Issue Date:2024.03.20</b>		
Tested by: <i>Cai Jianyu</i> <u>Cai Jianyu</u> Name      Signature	Reviewed by: <i>Mo Xianbiao</i> <u>Mo Xianbiao</u> Name      Signature	Approved by: <i>Dong Sanbi</i> <u>Dong Sanbi</u> Name      Signature	
<b>Other Aspects: NONE.</b>			
Abbreviations:OK, Pass= passed      Fail = failed      N/A= not applicable      EUT= equipment, sample(s) under tested			

This test report relates only to the EUT, and shall not be reproduced except in full, without written approval of CVC.

## TABLE OF CONTENTS

<b>RELEASE CONTROL RECORD .....</b>	<b>4</b>
<b>1 SUMMARY OF TEST RESULTS .....</b>	<b>5</b>
1.1 LIST OF TEST AND MEASUREMENT INSTRUMENTS .....	6
1.2 MEASUREMENT UNCERTAINTY .....	7
1.3 TEST LOCATION .....	7
<b>2 GENERAL INFORMATION .....</b>	<b>8</b>
2.1 GENERAL PRODUCT INFORMATION .....	8
2.2 CARRIER FREQUENCY AND CHANNEL .....	10
2.3 TEST MODE APPLICABILITY AND TESTED CHANNEL DETAIL .....	13
2.4 DESCRIPTION OF SUPPORT UNITS .....	14
2.5 GENERAL DESCRIPTION OF APPLIED STANDARDS .....	14
<b>3 TEST TYPES AND RESULTS .....</b>	<b>15</b>
3.1 CONDUCTED EMISSION MEASUREMENT .....	15
3.2 RADIATED EMISSION AND BANDEDGE MEASUREMENT .....	18
3.3 OCCUPIED BANDWIDTH MEASUREMENT .....	45
3.4 26DB EMISSION BANDWIDTH .....	46
3.5 6DB EMISSION BANDWIDTH .....	47
3.6 TRANSMIT POWER MEASUREMENT .....	48
3.7 POWER SPECTRAL DENSITY MEASUREMENT .....	49
3.8 FREQUENCY STABILITY .....	50
3.9 ANTENNA REQUIREMENT .....	51
<b>4 PHOTOGRAPHS OF TEST SETUP .....</b>	<b>52</b>
<b>5 PHOTOGRAPHS OF THE EUT .....</b>	<b>53</b>

## RELEASE CONTROL RECORD

ISSUE NO.	REASON FOR CHANGE	DATE ISSUED
FCCSZ2024-0007-RF2	Original release	2024.03.20

## 1 SUMMARY OF TEST RESULTS

The EUT has been tested according to the following specifications:

APPLIED STANDARD: FCC PART 15, SUBPARTE (SECTION 15.407)			
STANDARD SECTION	TEST TYPE	RESULT	REMARK
FCC 15.207	AC Power Conducted Emission	PASS	See section 3.1
FCC 15.403(a)(e)	6dB&26dB Emission Bandwidth	PASS	Appendix A1&A3 of FCCSZ2024-0007-RF2-A1
---	Occupied Bandwidth Measurement	ONLY FOR REPORTED	Appendix A2 of FCCSZ2024-0007-RF2-A1
FCC 15.407(b)	Radiated Emission and Bandedge	PASS	See section 3.2
FCC 15.407(a)	Transmit Power	PASS	Appendix C of FCCSZ2024-0007-RF2-A1
FCC 15.407(a)	Power Spectral Density	PASS	Appendix D of FCCSZ2024-0007-RF2-A1
FCC 15.407(g)	Frequency Stability	PASS	Appendix E of FCCSZ2024-0007-RF2-A1
FCC 15.203 FCC 15.407(a)	Antenna Requirement	PASS	See section 3.9

**1.1 LIST OF TEST AND MEASUREMENT INSTRUMENTS**

Equipment	Manufacturer	Model No.	Serial Number	Cal. interval	Cal. Due
<b>WiFi &amp; Bluetooth Test System</b>					
Signal&Spectrum Analyzer	Rohde&Schwarz	FSV 30	104408	1 year	2024.5.21
#3Shielding room	MORI	443	N/A	3 year	2026.5.16
Wideband radio communication tester	Rohde&Schwarz	CMW 500	168778	1 year	2024.5.25
Analog signal Generator (100kHz ~ 40GHz)	Rohde&Schwarz	SMB 100A	181934	1 year	2024.5.21
Vector signal Generator (9kHz ~ 6GHz)	Keysight	N5182B	MY57301451	1 year	2024.4.25
Vector signal Generator (9kHz ~ 6GHz)	Rohde&Schwarz	SGT 100A	111724	1 year	2024.5.21
RF control unit(BT/WiFi)	Tonscend	JS0806-2-8CH	20E8060261	1 year	2024.5.21
<b>Radiation Spurious(Above 1GHz)</b>					
Signal&Spectrum Analyzer	Rohde&Schwarz	FSV 40	101898	1 year	2024.5.21
EMI Test Receiver	Rohde&Schwarz	ESR3	102693	1 year	2024.5.25
Antenna(30MHz~1001MHz)	SCHWARZBECK	VULB 9168	1133	1 year	2025.2.4
Horn antenna(1GHz-18GHz)	ETS	3117	227611	1 year	2024.3.25
Horn antenna(18GHz-40GHz)	QMS	QMS-00880	22051	1 year	2024.3.25
3m anechoic chamber	MORI	966	CS0300011	3 year	2026.5.18
Filter group(RSE-BT/WiFi)	Rohde&Schwarz	WiFi /BT Variant 1	100820	1 year	2024.5.21
Filter group(RSE-Cellular)	Rohde&Schwarz	Cellular Variant 1	100768	1 year	2024.5.21
Preamplifier(10kHz-1GHz)	Rohde&Schwarz	SCU-01F	100299	1 year	2024.5.21
Preamplifier(1GHz-18GHz)	Rohde&Schwarz	SCU-18F	100799	1 year	2024.5.21
Preamplifier(1GHz-18GHz)	Rohde&Schwarz	SCU-18F	100801	1 year	2024.5.21
Preamplifier(18Gz-40GHz)	Rohde&Schwarz	SCU-40A	101209	1 year	2024.5.21
#2 control room	MORI	433	CS0300028	3 year	2024.5.21
Temperature and humidity meter	/	C193561517	C193561517	1 year	2024.5.21
<b>Radiation Spurious(Below 1GHz)</b>					
EMI Test Receiver	Rohde&Schwarz	ESR 26	101718	1 year	2024.5.25
Loop antenna (8.3k~30MHz)	Rohde&Schwarz	HFH2-Z2E	100951	1 year	2024.5.26
Antenna(30MHz~1000MHz)	SCHWARZBECK	VULB 9168	1132	1 year	2025.2.27
3m anechoic chamber	MORI	966	CS0200019	3 year	2026.5.18
Attenuator	/	SJ-5dB	607684	1 year	2025.2.4
#1 control room	MORI	433	CS0300028	3 year	2026.5.16
Temperature and humidity meter	/	C193561473	CS0200071	1 year	2024.5.21
<b>Conducted emission</b>					
EMI Test Receiver	Rohde&Schwarz	ESR3	102694	1 year	2024.5.25
limiter (10 dB)	Rohde&Schwarz	ESH3-Z2	102824	1 year	2024.5.16
Voltage probe	Rohde&Schwarz	CVP9222C	28	1 year	2024.5.16
Current probe	Rohde&Schwarz	EZ-17	101442	1 year	2024.5.21
ISN network	Rohde&Schwarz	ENV 81	100401	1 year	2024.5.16
ISN network	Rohde&Schwarz	ENV 81 Cat6	101896	1 year	2024.5.16
LISN (single-phase )	Rohde&Schwarz	ENV216	102569	1 year	2024.4.11
#1Shielding room	MORI	854	N/A	3 year	2026.5.16

## 1.2 MEASUREMENT UNCERTAINTY

Where relevant, the following measurement uncertainty levels have been estimated for tests performed on the EUT:

No.	Item	Measurement Uncertainty
1	Conducted emission test	+/-2.7 dB
2	Radiated emission 9kHz-30MHz	+/-5.6 dB
3	Radiated emission 30MHz-1GHz	+/-4.6 dB
4	Radiated emission 1GHz-18GHz	+/-4.4 dB
5	Radiated emission 18GHz-40GHz	+/-5.1 dB
6	RF power	+/-0.9 dB
7	Power Spectral Density	+/-0.8 dB
8	Conducted spurious emissions	+/-2.7 dB
9	Transmission Time	+/-0.27%
10	Occupied Bandwidth	+/-1.86%

**Remark: 95% Confidence Levels, k=2.**

## 1.3 TEST LOCATION

The tests and measurements refer to this report were performed by EMC testing Lab. of CVC Testing Technology (Shenzhen) Co., Ltd.

CABID:CN0137

Lab Address: No. 1301, Guanguang Road, Xinlan Community, Guanlan Street, Longhua District, Shenzhen City, Guangdong Province 518110 P.R.China

Post Code: 518110 Tel: 0755-23763060-8805

Fax: 0755-23763060 E-mail: sz-kf@cvc.org.cn

FCC(Test firm designation number: CN1363)

IC(Test firm CAB identifier number: CN0137)

CNAS(Test firm designation number: L16091)

## 2 GENERAL INFORMATION

### 2.1 GENERAL PRODUCT INFORMATION

<b>PRODUCT</b>	WIFI Module		
<b>BRAND</b>	N/A		
<b>TEST MODEL</b>	AL-7663B-WG-A		
<b>ADDITIONAL MODEL</b>	AL-7663B-WG-A(FCC); AL-7663B-WG-A-1(FCC); AL-7663B-WG-A-2(FCC); AL-7663B-WG-A-3(FCC); AL-7663B-WG-A-4(FCC); AL-7663B-WG-A-5(FCC);		
<b>POWER SUPPLY</b>	DC 5V		
<b>MODULATION TECHNOLOGY</b>	OFDM		
<b>MODULATION TYPE</b>	256QAM, 64QAM, 16QAM, QPSK, BPSK for OFDM		
<b>TRANSFER RATE</b>	802.11a: up to 54Mbps, 802.11n: up to 300Mbps, 802.11ac: up to 866.6Mbps,		
<b>OPERATING FREQUENCY AND MAXIMUM POWER</b>	Frequency	MAX output power(dBm)	MAX.EIPR(dBm)
	5180 ~ 5240MHz	18.03	19.99
	5260 ~ 5320MHz	18.45	20.41
	5500 ~ 5720MHz	17.76	19.72
	5745 ~ 5825MHz	17.21	19.17
<b>NUMBER OF CHANNEL</b>	See item 2.3		
<b>ANTENNA TYPE(NOTE 4)</b>	ANT 1: PIFA Antenna with 1.96dBi gain Ant 2: PIFA Antenna with 1.96dBi gain		
<b>FIX FREQUENCY SOFTWARE</b>	QATool_Dbg		
<b>I/O PORTS</b>	Refer to user's manual		
<b>CABLE SUPPLIED</b>	N/A		
<b>NOTE:</b>			
<ol style="list-style-type: none"> <li>For a more detailed features description, please refer to the manufacturer's specifications or the user's manual.</li> <li>For the test results, the EUT had been tested with all conditions. But only the worst case was shown in test report.</li> <li>EUT photo refer to report (Report NO.: FCCSZ2024-0007-EUT).</li> <li>Since the above data and/or information is provided by the client, CVC is not responsible for the authenticity, integrity and results of the data and information and/or the validity of the conclusion.</li> <li>At the same time, EUT incorporates a MIMO function. Physically, the EUT provides 2 completed transmitter and 2 receiver.</li> </ol>			



	MODULATION MODE	TX FUNCTION	
	802.11a	SISO	
	802.11n	MIMO	
	802.11ac	MIMO	

## 2.2 CARRIER FREQUENCY AND CHANNEL

### FOR 5180 ~ 5320MHz

8 channels are provided for 802.11a, 802.11n (HT20):

CHANNEL	FREQUENCY	CHANNEL	FREQUENCY
<b>36</b>	<b>5180MHz</b>	<b>40</b>	<b>5200MHz</b>
44	5220 MHz	<b>48</b>	<b>5240MHz</b>
<b>52</b>	<b>5260MHz</b>	56	5280MHz
60	5300MHz	<b>64</b>	<b>5320MHz</b>

4 channels are provided for 802.11n (HT40):

CHANNEL	FREQUENCY	CHANNEL	FREQUENCY
<b>38</b>	<b>5190MHz</b>	<b>46</b>	<b>5230 MHz</b>
<b>54</b>	<b>5270MHz</b>	<b>62</b>	<b>5310MHz</b>

2 channels are provided for 802.11ac (VHT80):

CHANNEL	FREQUENCY	CHANNEL	FREQUENCY
<b>42</b>	<b>5210MHz</b>	<b>58</b>	<b>5290 MHz</b>

### WLAN 5.50 ~ 5.72GHz

9 channels are provided for 802.11a, 802.11n (HT20):

CHANNEL	FREQUENCY	CHANNEL	FREQUENCY
<b>100</b>	<b>5500MHz</b>	124	5620MHz
104	5520MHz	128	5640MHz
108	5540MHz	132	5660MHz
112	5560MHz	136	5680MHz
<b>116</b>	<b>5580MHz</b>	<b>140</b>	<b>5700MHz</b>
120	5600MHz	<b>144</b>	<b>5720MHz</b>

4 channels are provided for 802.11n (HT40):

CHANNEL	FREQUENCY	CHANNEL	FREQUENCY
<b>102</b>	<b>5510MHz</b>	126	5630MHz
<b>110</b>	<b>5550MHz</b>	<b>134</b>	<b>5670MHz</b>
118	5590MHz	<b>142</b>	<b>5710MHz</b>

2 channels are provided for 802.11ac (VHT80):

CHANNEL	FREQUENCY	CHANNEL	FREQUENCY
<b>106</b>	<b>5530MHz</b>	<b>138</b>	<b>5690 MHz</b>
<b>122</b>	<b>5610 MHz</b>	--	--

### FOR 5745 ~ 5825MHz

5 channels are provided for 802.11a, 802.11n (20MHz):

CHANNEL	FREQUENCY	CHANNEL	FREQUENCY
<b>149</b>	<b>5745MHz</b>	153	5765MHz
<b>157</b>	<b>5785MHz</b>	161	5805MHz
<b>165</b>	<b>5825MHz</b>	--	--

2 channels are provided for 802.11n (HT40):

CHANNEL	FREQUENCY	CHANNEL	FREQUENCY
<b>151</b>	<b>5755MHz</b>	<b>159</b>	<b>5795MHz</b>

1 channels are provided for 802.11ac (VHT80):

CHANNEL	FREQUENCY
<b>155</b>	<b>5775MHz</b>

The channels which were indicated in bold type of the above channel list were selected as representative test channel. Therefore only the data of the test channels were recorded in this report.

By means of test software which provided by manufacture, the power levels during the tests were set according to the following codes:

Operated in 5180 ~ 5240MHz band							
802.11a		802.11n(HT20)		802.11n(HT40)		802.11ac (VHT80)	
FREQUENCY (MHZ)	POWER SETTING	FREQUENCY (MHZ)	POWER SETTING	FREQUENCY (MHZ)	POWER SETTING	FREQUENCY (MHZ)	POWER SETTING
5180	22	5180	22	5190	20	5210	22
5200	22	5200	22	5230	20		
5240	22	5240	22				
Operated in 5260 ~ 5320MHz band							
802.11a		802.11n(HT20)		802.11n(HT40)		802.11ac (VHT80)	
FREQUENCY (MHZ)	POWER SETTING	FREQUENCY (MHZ)	POWER SETTING	FREQUENCY (MHZ)	POWER SETTING	FREQUENCY (MHZ)	POWER SETTING
5260	22	5260	22	5270	20	5290	22
5300	22	5300	22	5310	20		
5320	22	5320	22				
Operated in 5500 ~ 5700MHz band							
802.11a		802.11n(HT20)		802.11n(HT40)		802.11ac (VHT80)	
FREQUENCY (MHZ)	POWER SETTING	FREQUENCY (MHZ)	POWER SETTING	FREQUENCY (MHZ)	POWER SETTING	FREQUENCY (MHZ)	POWER SETTING
5500	22	5500	22	5510	20	5530	22
5580	22	5550	22	5550	20	5610	22
5700	22	5700	22	5670			
Operated in 5745 ~ 5825MHz band							
802.11a		802.11n(HT20)		802.11n(HT40)		802.11ac (VHT80)	
FREQUENCY (MHZ)	POWER SETTING	FREQUENCY (MHZ)	POWER SETTING	FREQUENCY (MHZ)	POWER SETTING	FREQUENCY (MHZ)	POWER SETTING
5745	22	5745	22	5755	20	5755	22
5785	22	5785	22	5795	20		
5825	22	5825	22				

Main Model No.	Serial Model No.	Difference
AL-7663B-WG-A	AL-7663B-WG-A(FCC); AL-7663B-WG-A-1(FCC); AL-7663B-WG-A-2(FCC); AL-7663B-WG-A-3(FCC); AL-7663B-WG-A-4(FCC); AL-7663B-WG-A-5(FCC).	only difference is the model no.

**2.3 TEST MODE APPLICABILITY AND TESTED CHANNEL DETAIL**

EUT CONFIGURE MODE	APPLICABLE TO				DESCRIPTION
	RE $\geq$ 1G	RE<1G	PLC	APCM	
-	√	√	√	√	Powered by host unit with wifi(5G) link

Where **RE $\geq$ 1G**: Radiated Emission above 1GHz      **RE<1G**: Radiated Emission below 1GHz  
**PLC**: Power Line Conducted Emission      **APCM**: Antenna Port Conducted Measurement

**NOTE:**

- The EUT had been pre-tested on the positioned of each 3 axis. The worst case was found when positioned on **X-plane**.  
**NOTE:** "-" means no effect.

MODULATION	DATA RATE
802.11a	6Mbps
802.11n HT20	MCS0
802.11n HT40	MCS0
802.11ac VHT20(Covered by HT20)	MCS0
802.11ac VHT40(Covered by HT40)	MCS0
802.11ac VHT80	MCS0

**TEST CONDITION:**

APPLICABLE TO	ENVIRONMENTAL CONDITIONS	INPUT POWER	TESTED BY
RE<1G	25deg. C, 54%RH	DC 5V	Liu Yuan
RE $\geq$ 1G	25deg. C, 54%RH	DC 5V	Liu Yuan
PLC	20deg. C, 56%RH	DC 5V	Wang Zhiming
APCM	20deg. C, 55%RH	DC 5V	Cai Jianyu

## 2.4 DESCRIPTION OF SUPPORT UNITS

The EUT has been tested as an independent unit together with other necessary accessories or support units. The following support units or accessories were used to form a representative test configuration during the tests.

Support Equipment							
NO	Description	Brand	Model No.	Serial Number	Supplied by		
N/A	N/A	N/A	N/A	N/A	N/A		
Support Cable							
NO	Description	Quantity (Number)	Length (cm)	Detachable (Yes/ No)	Shielded (Yes/ No)	Cores (Number)	Supplied by
N/A	N/A	N/A	N/A	N/A	N/A	N/A	N/A

## 2.5 GENERAL DESCRIPTION OF APPLIED STANDARDS

The EUT is a RF product, according to the specifications of the manufacturers. It must comply with the requirements of the following standards:

**FCC Part 15, Subpart E (15.407)**

**KDB 789033 D02 General UNII Test Procedures New Rules v02r01**

**ANSI C63.10-2013**

All test items have been performed and recorded as per the above standards

### 3 TEST TYPES AND RESULTS

#### 3.1 CONDUCTED EMISSION MEASUREMENT

##### 3.1.1 LIMITS OF CONDUCTED EMISSION MEASUREMENT

FREQUENCY OF EMISSION (MHz)	CONDUCTED LIMIT (dB $\mu$ V)	
	Quasi-peak	Average
0.15 ~ 0.5	66 to 56	56 to 46
0.5 ~ 5	56	46
5 ~ 30	60	50

- NOTE:**
1. The lower limit shall apply at the transition frequencies.
  2. The limit decreases in line with the logarithm of the frequency in the range of 0.15 to 0.50MHz.
  3. All emanations from a class A/B digital device or system, including any network of conductors and apparatus connected thereto, shall not exceed the level of field strengths specified above.

##### 3.1.2 TEST PROCEDURES

- a. The EUT was placed 0.4 meters from the conducting wall of the shielded room with EUT being connected to the power mains through a line impedance stabilization network (LISN). Other support units were connected to the power mains through another LISN. The two LISNs provide 50 ohm/ 50uH of coupling impedance for the measuring instrument.
- b. Both lines of the power mains connected to the EUT were checked for maximum conducted interference.
- c. The frequency range from 150kHz to 30MHz was searched. Emission levels under (Limit - 20dB) were not recorded.

**NOTE:** All modes of operation were investigated and the worst-case emissions are reported.

##### 3.1.3 TEST SETUP

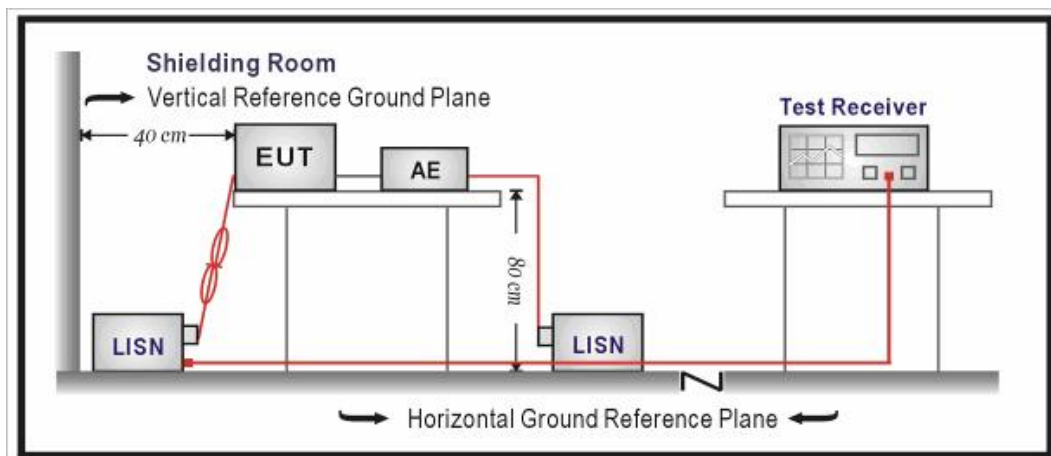

**NOTE:** For the actual test configuration, please refer to the attached file (Test Setup Photo).

**3.1.4 TEST RESULTS**

<b>Test Mode</b>	5G WIFI Link	<b>Frequency Range</b>	150KHz ~ 30MHz
<b>PHASE</b>	Line (L)		

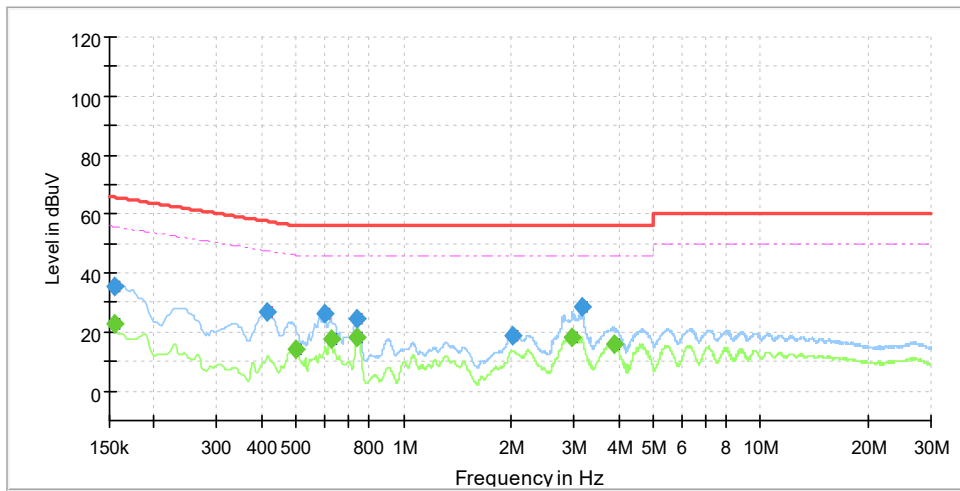

NO	Frequency (MHz)	QuasiPeak (dBuV)	Average (dBuV)	Limit (dBuV)	Margin (dB)	Line	Corr.Factor (dB)
1	0.155	35.3	---	65.8	30.4	L	10.0
2	0.155	---	22.6	55.8	33.2	L	10.0
3	0.413	26.7	---	57.6	30.9	L	9.9
4	0.497	---	14.3	46.1	31.7	L	10.0
5	0.602	26.2	---	56.0	29.8	L	10.0
6	0.625	---	17.4	46.0	28.6	L	9.9
7	0.742	---	18.4	46.0	27.6	L	10.0
8	0.742	24.5	---	56.0	31.5	L	10.0
9	2.022	18.9	---	56.0	37.1	L	10.2
10	2.972	---	18.4	46.0	27.6	L	10.1
11	3.149	28.8	---	56.0	27.2	L	10.1
12	3.901	---	15.7	46.0	30.3	L	10.1

Remark: The emission levels of other frequencies were very low against the limit.



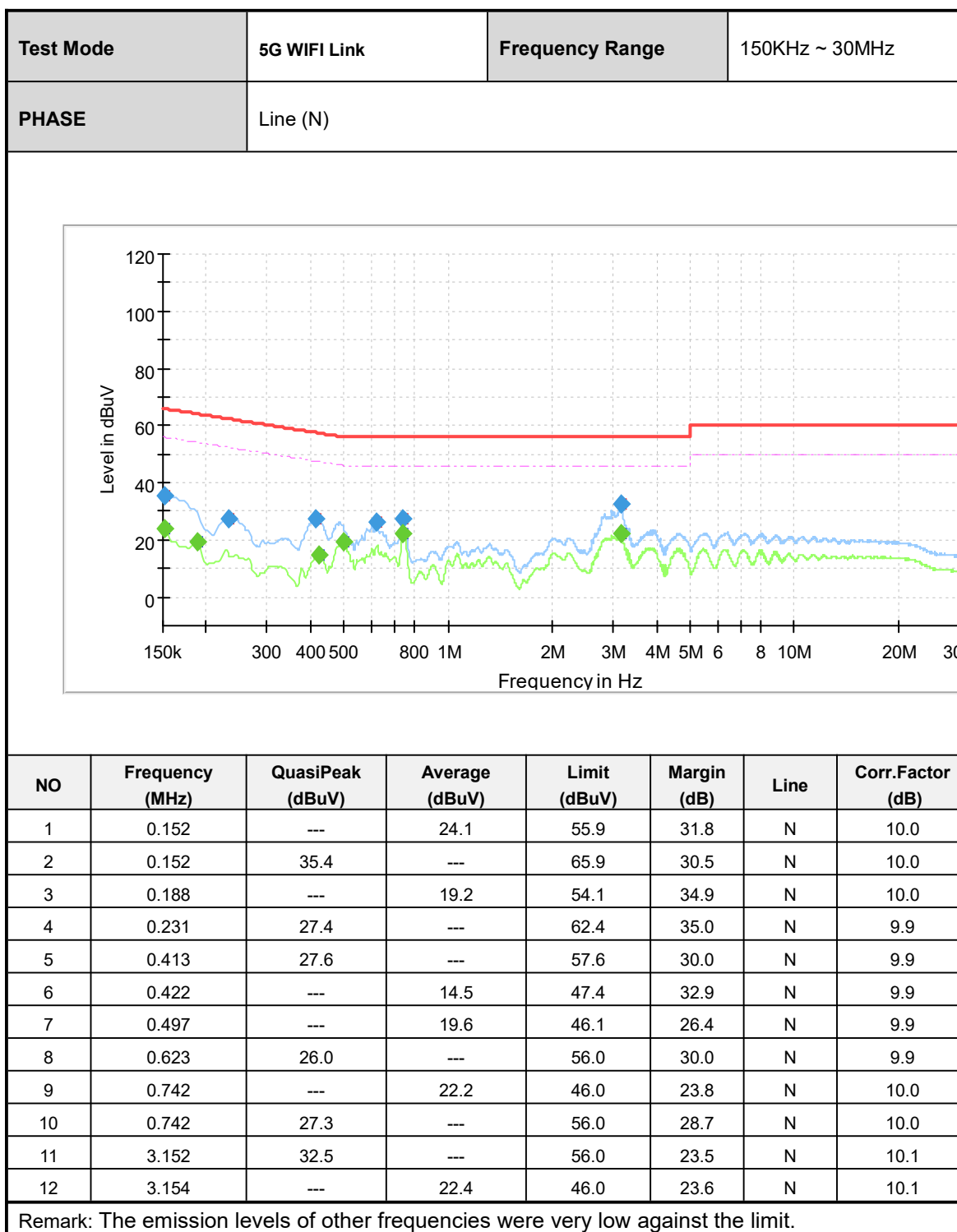

## 3.2 RADIATED EMISSION AND BANDEDGE MEASUREMENT

### 3.1.1 LIMITS OF RADIATED EMISSION AND BANDEDGE MEASUREMENT

Radiated emissions which fall in the restricted bands must comply with the radiated emission limits specified as below table:

FREQUENCIES (MHz)	FIELD STRENGTH (microvolts/meter)	MEASUREMENT DISTANCE (meters)
0.009 ~ 0.490	2400/F(kHz)	300
0.490 ~ 1.705	24000/F(kHz)	30
1.705 ~ 30.0	30	30
30 ~ 88	100	3
88 ~ 216	150	3
216 ~ 960	200	3
Above 960	500	3

**NOTE:**

1. The lower limit shall apply at the transition frequencies.
2. Emission level (dBuV/m) = 20 log Emission level (uV/m).
3. For frequencies above 1000MHz, the field strength limits are based on average detector, however, the peak field strength of any emission shall not exceed the maximum permitted average limits, specified above by more than 30dB under any condition of modulation.

**3.1.2 LIMITS OF UNWANTED EMISSION OUT OF THE RESTRICTED BANDS**

APPLICABLE TO	LIMIT	
KDB 789033 D02 General UNII Test Procedures New Rules v02r01	FIELD STRENGTH AT 3m	
	PK:74 (dBµV/m)	AV:54 (dBµV/m)
APPLICABLE TO	EIRP LIMIT	EQUIVALENT FIELD STRENGTH AT 3m
15.407(b)(1)	PK:-27 (dBm/MHz)	PK:68.2(dBµV/m)
15.407(b)(2)		
15.407(b)(3)		
15.407(b)(4)	Note	Note

**NOTE:**

For transmitters operating in the 5.725-5.85 GHz band:Section 15.407(b)(4) specifies the unwanted emissions limit for the U-NII-3 band. A band emissions mask is specified in Section 15.407(b)(4)(i). An alternative to the band emissions mask is specified in Section 15.407(b)(4)(ii). The alternative limits are based on the highest antenna gain specified in the filing. There are also marketing and importation restrictions for the alternative limit.

15.407(b)(4)(i) All emissions shall be limited to a level of -27 dBm/MHz at 75 MHz or more above or below theband edge increasing linearly to 10 dBm/MHz at 25 MHz above or below the band edge, and from 25MHz above or below the band edge increasing linearly to a level of 15.6 dBm/MHz at 5 MHz above orbelow the band edge, and from 5 MHz above or below the band edge increasing linearly to a level of 27dBm/MHz at the band edge.

The following formula is used to convert the equipment isotropic radiated power (eirp) to field strength:

$$E = \frac{1000000\sqrt{30P}}{3} \mu\text{V/m, where P is the eirp (Watts).$$

### 3.1.3 TEST PROCEDURES

- a. The EUT was placed on the top of a rotating table 1.5 meters(above 1GHz)and 0.8 meters(below 1GHz) above the ground at a 3 meters semi-anechoic chamber. The table was rotated 360 degrees to determine the position of the highest radiation.
- b. The EUT was set 3 meters away from the interference-receiving antenna, which was mounted on the top of a variable-height antenna tower.
- c. The antenna is a broadband antenna, and its height is varied from one meter to four meters above the ground to determine the maximum value of the field strength. Both horizontal and vertical polarizations of the antenna are set to make the measurement.
- d. For each suspected emission, the EUT was arranged to its worst case and then the antenna was tuned to heights from 1 meter to 4 meters and the rotatable table was turned from 0 degrees to 360 degrees to find the maximum reading.
- e. The test-receiver system was set to Peak Detect Function and Specified Bandwidth with Maximum Hold Mode.
- f. If the emission level of the EUT in peak mode was 10dB lower than the limit specified, then testing could be stopped and the peak values of the EUT would be reported. Otherwise the emissions that did not have 10dB margin would be re-tested one by one using peak, quasi-peak or average method as specified and then reported in a data sheet.

**NOTE:**

1. The resolution bandwidth and video bandwidth of test receiver/spectrum analyzer is 120kHz for Quasi-peak detection at frequency below 1GHz.
2. The resolution bandwidth of test receiver/spectrum analyzer is 1MHz and video bandwidth is 3MHz for Peak detection at frequency above 1GHz.
3. The resolution bandwidth of test receiver/spectrum analyzer is 1MHz and the video bandwidth is  $\geq 1/T$  (Duty cycle < 98%) or 10Hz(Duty cycle > 98%) for Average detection (AV) at frequency above 1GHz.
4. All modes of operation were investigated and the worst-case emissions are reported.

### 3.1.4 TEST SETUP

Below 30MHz Test Setup:

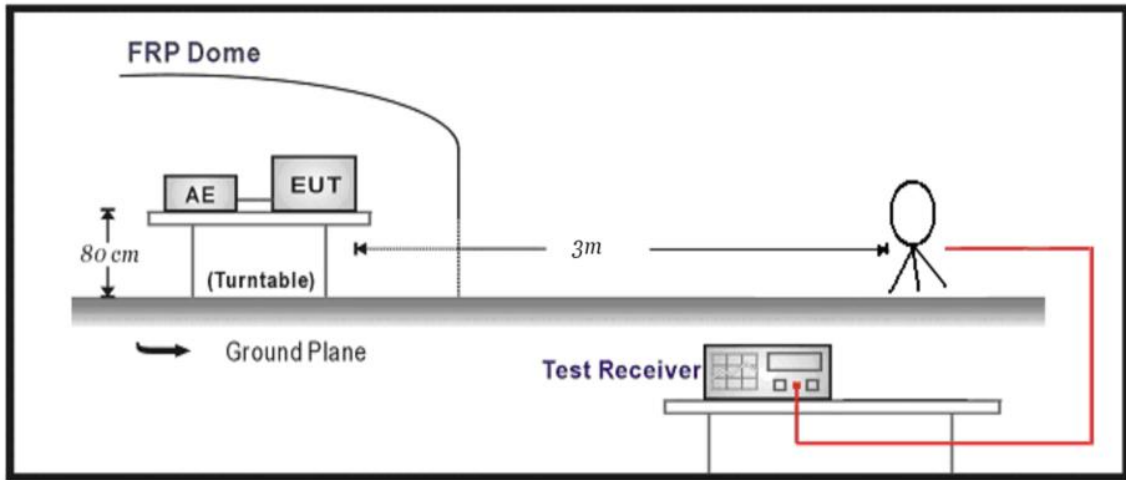

Below 1GHz Test Setup:

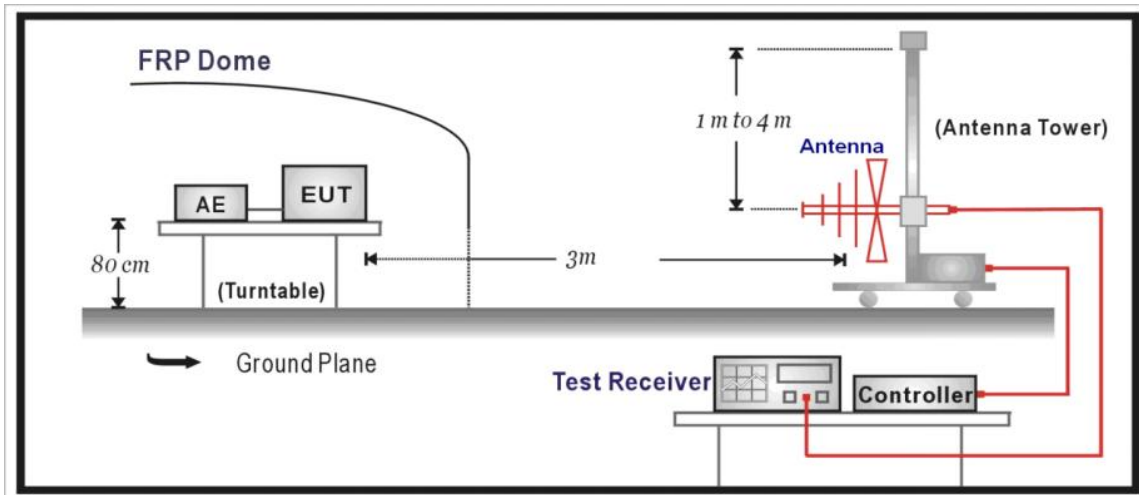

Above 1GHz Test Setup:

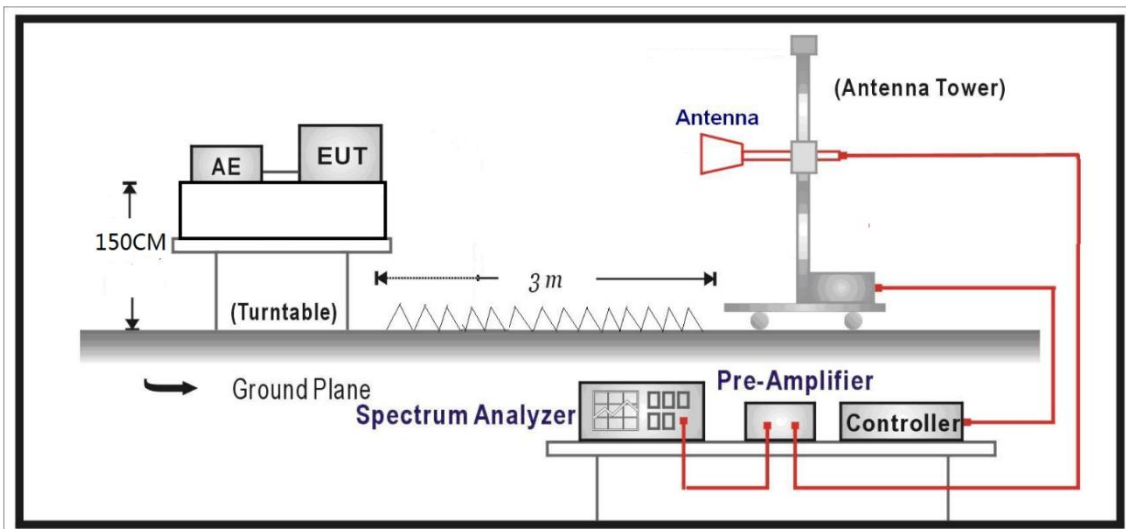

**Note:** For the actual test configuration, please refer to the related Item in this test report (Photographs of the Test Setup)

**3.1.5 TEST RESULTS - BELOW 1GHz**

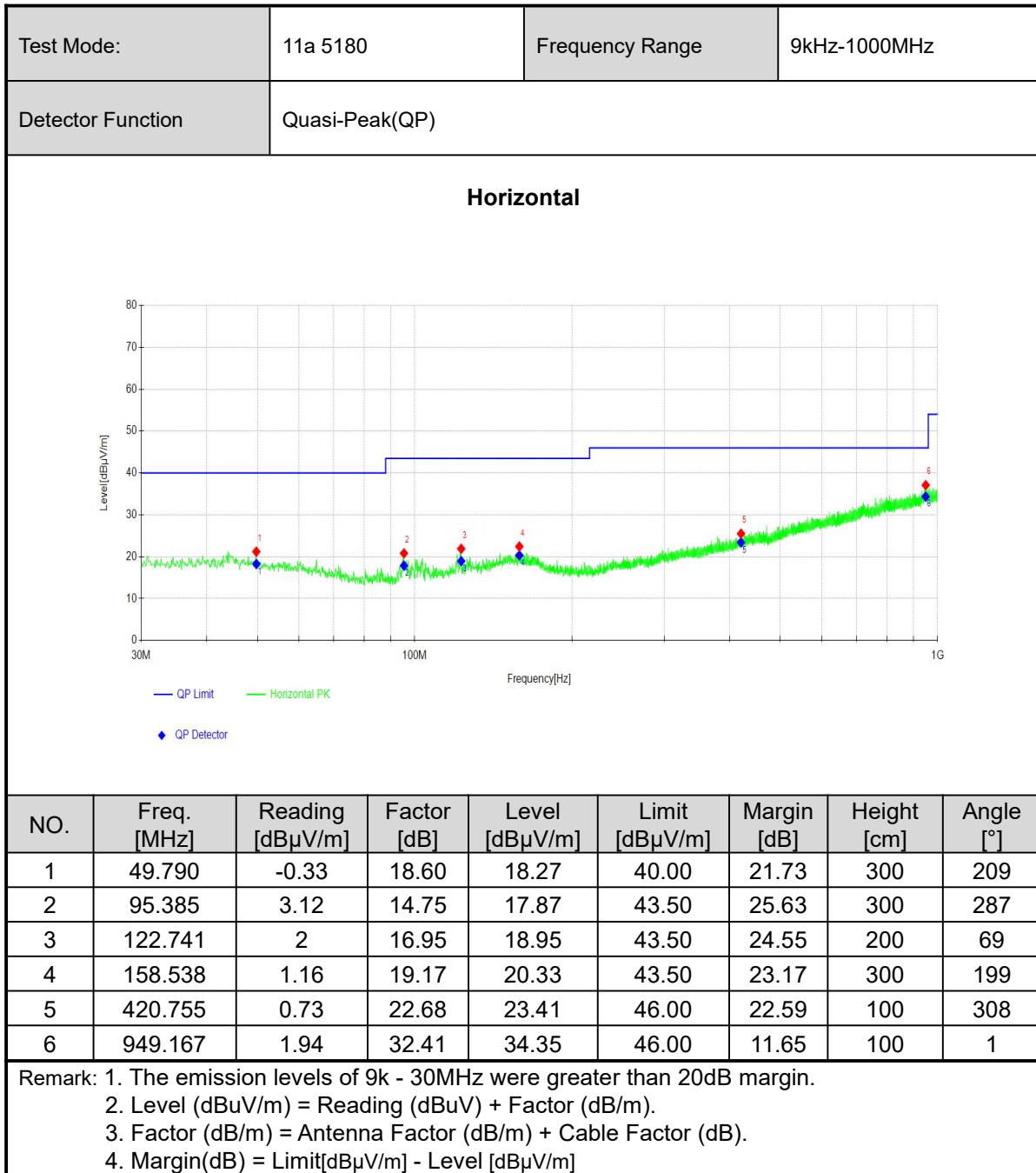

Test Mode:	11a 5180	Frequency Range	9kHz-1000MHz
Detector Function	Quasi-Peak(QP)		

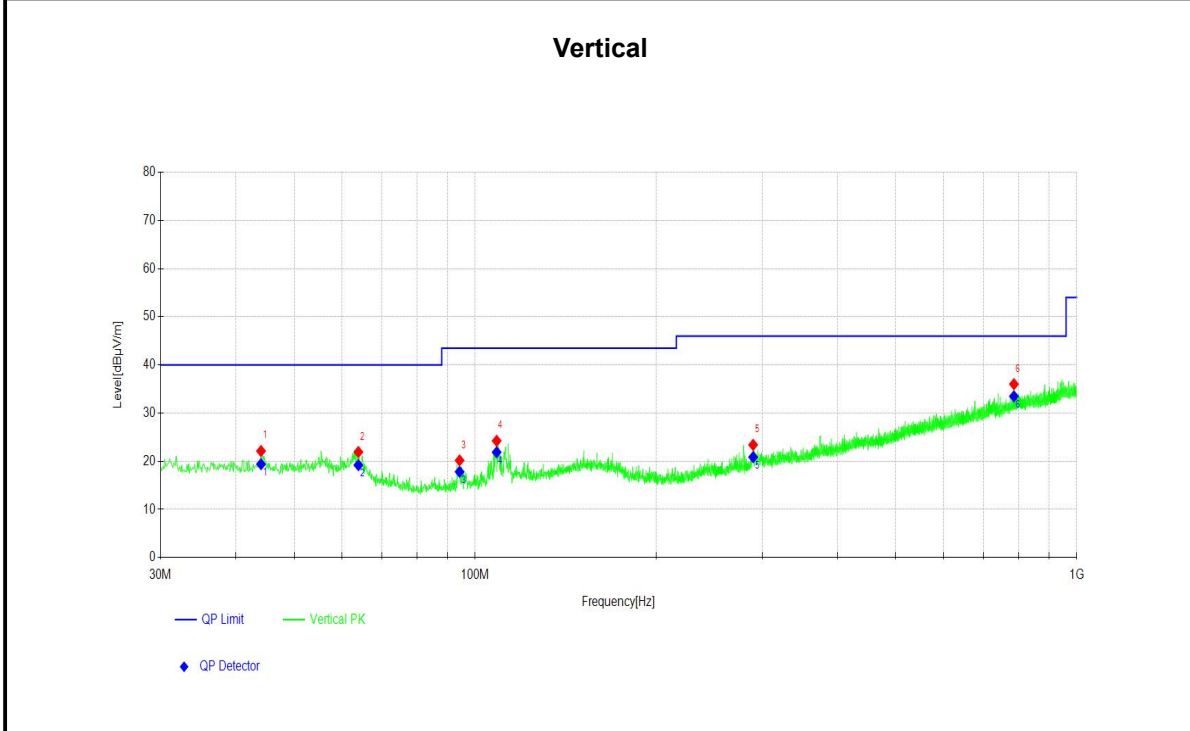

NO.	Freq. [MHz]	Reading [dBµV/m]	Factor [dB]	Level [dBµV/m]	Limit [dBµV/m]	Margin [dB]	Height [cm]	Angle [°]
1	44.066	0.51	18.89	19.40	40.00	20.60	300	282
2	63.953	2.09	17.11	19.20	40.00	20.80	100	330
3	94.220	3.11	14.70	17.81	43.50	25.69	300	264
4	108.578	6.19	15.69	21.88	43.50	21.62	300	2
5	289.792	2.52	18.35	20.87	46.00	25.13	100	355
6	786.288	3.47	30.01	33.48	46.00	12.52	300	87

Remark: 1. The emission levels of 9k - 30MHz were greater than 20dB margin.  
 2. Level (dBuV/m) = Reading (dBuV) + Factor (dB/m).  
 3. Factor (dB/m) = Antenna Factor (dB/m) + Cable Factor (dB).  
 4. Margin(dB) = Limit[dBµV/m] - Level [dBµV/m]

**3.1.6 TEST RESULTS - Band 1 (5180-5240MHz):**

**ABOVE 1GHz DATA**

All test modes have been conducted, and the report only presents the worst case.

<b>Channel</b>	<b>802.11a ANT1 CH36</b>	<b>Frequency</b>	5180 MHz
<b>Frequency Range</b>	Above 1G	<b>Detector Function</b>	PK/AV

**Horizontal**

NO.	Freq. [MHz]	Reading [dBμV]	Factor [dB/m]	Level [dBμV/m]	Limit [dBμV/m]	Margin [dB]	Detector
1	5080.13	49.51	7.82	57.33	74.00	16.67	PK
2	5111.83	35.85	8.02	43.87	54.00	10.13	AV
3	5150.00	37.42	8.03	45.45	54.00	8.55	AV
4	5150.00	48.11	8.03	56.14	74.00	17.86	PK
5	5179.54	100.66	7.92	108.58			PK
6	5179.54	93.05	7.92	100.97			AV
7	10362.65	29.72	16.25	45.97	54.00	8.03	AV
8	10363.82	39.25	16.26	55.51	68.20	12.69	PK
9	15541.58	27.15	19.21	46.36	74.00	27.64	PK
10	15541.58	18.12	19.21	37.33	54.00	16.67	AV

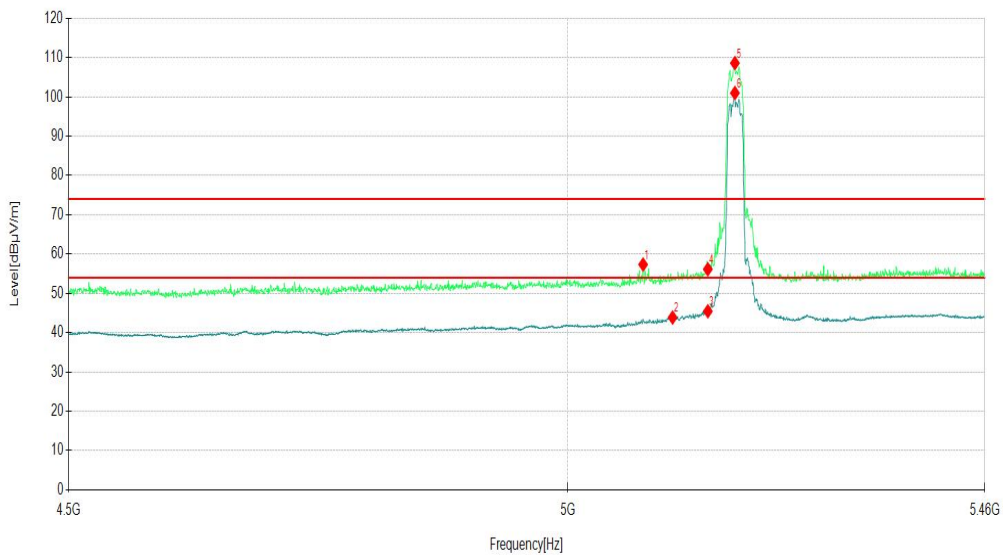

Remark: 1. The emission levels of other frequencies were greater than 20dB margin.  
 2. Level (dBuV/m) = Reading (dBuV) + Factor (dB/m).  
 3. Factor (dB/m) = Antenna Factor (dB/m) + Cable Factor (dB).  
 4. Margin(dB) = Limit[dBμV/m] - Level [dBμV/m]



<b>Channel</b>	<b>802.11a ANT1 CH36</b>	<b>Frequency</b>	5180 MHz
<b>Frequency Range</b>	Above 1G	<b>Detector Function</b>	PK/AV

**Vertical**

NO.	Freq. [MHz]	Reading [dBμV]	Factor [dB/m]	Level [dBμV/m]	Limit [dBμV/m]	Margin [dB]	Detector
1	5080.13	51.76	7.82	59.58	74.00	14.42	PK
2	5140.64	39.80	7.94	47.74	54.00	6.26	AV
3	5150.00	40.71	8.03	48.74	54.00	5.26	AV
4	5150.00	50.37	8.03	58.40	74.00	15.60	PK
5	5180.98	103.89	7.89	111.78			PK
6	5180.98	96.08	7.89	103.97			AV
7	10357.97	39.50	16.22	55.72	68.20	12.48	PK
8	10357.97	31.20	16.22	47.42	54.00	6.58	AV
9	15535.73	31.13	19.19	50.32	74.00	23.68	PK
10	15546.26	22.48	19.32	41.80	54.00	12.20	AV

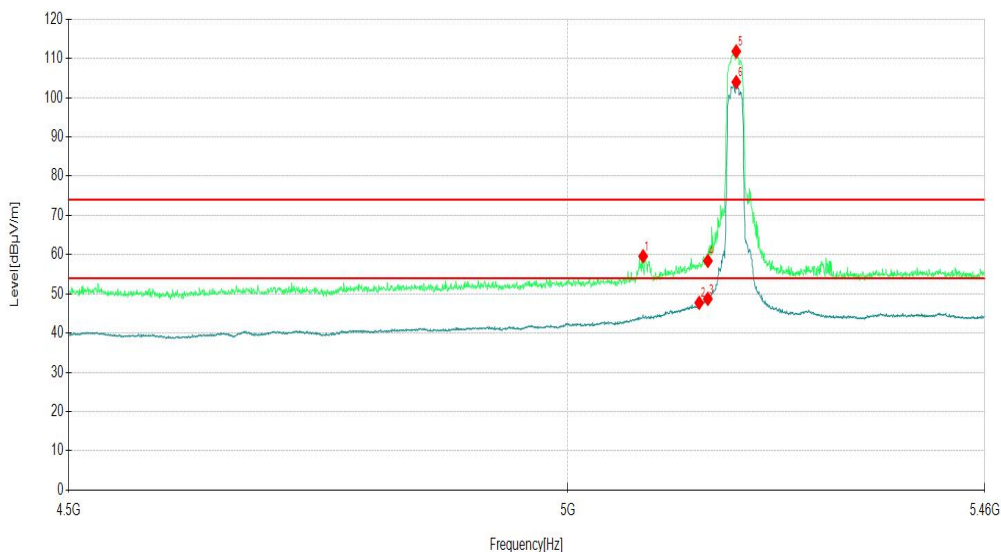

Remark: 1. The emission levels of other frequencies were greater than 20dB margin.  
 2. Level (dBuV/m) = Reading (dBuV) + Factor (dB/m).  
 3. Factor (dB/m) = Antenna Factor (dB/m) + Cable Factor (dB).  
 4. Margin(dB) = Limit[dBμV/m] - Level [dBμV/m]

<b>Channel</b>		<b>802.11a ANT1 CH 44</b>		<b>Frequency</b>		5220MHz	
<b>Frequency Range</b>		Above 1G		<b>Detector Function</b>		PK/AV	
<b>Horizontal</b>							
NO.	Freq. [MHz]	Reading [dB $\mu$ V]	Factor [dB/m]	Level [dB $\mu$ V/m]	Limit [dB $\mu$ V/m]	Margin [dB]	Detector
1	10397.75	40.48	16.50	56.98	68.20	11.22	PK
2	10402.43	33.29	16.51	49.80	54.00	4.20	AV
3	15597.75	26.44	19.46	45.90	74.00	28.10	PK
4	15598.92	17.26	19.45	36.71	54.00	17.29	AV
<b>Vertical</b>							
NO.	Freq. [MHz]	Reading [dB $\mu$ V]	Factor [dB/m]	Level [dB $\mu$ V/m]	Limit [dB $\mu$ V/m]	Margin [dB]	Detector
1	10402.43	39.81	16.51	56.32	68.20	11.88	PK
2	10402.43	31.88	16.51	48.39	54.00	5.61	AV
3	15598.92	21.67	19.45	41.12	54.00	12.88	AV
4	15603.60	29.93	19.52	49.45	74.00	24.55	PK
Remark: 1. The emission levels of other frequencies were greater than 20dB margin. 2. Level (dB $\mu$ V/m) = Reading (dB $\mu$ V) + Factor (dB/m). 3. Factor (dB/m) = Antenna Factor (dB/m) + Cable Factor (dB). 4. Margin(dB) = Limit[dB $\mu$ V/m] - Level [dB $\mu$ V/m]							

<b>Channel</b>	<b>802.11a ANT1 CH48</b>	<b>Frequency</b>	5240 MHz
<b>Frequency Range</b>	Above 1G	<b>Detector Function</b>	PK/AV

**Horizontal**

NO.	Freq. [MHz]	Reading [dBμV]	Factor [dB/m]	Level [dBμV/m]	Limit [dBμV/m]	Margin [dB]	Detector
1	5239.09	99.80	8.21	108.01			PK
2	5239.09	91.82	8.21	100.03			AV
3	5350.00	44.79	9.96	54.75	74.00	19.25	PK
4	5350.00	34.05	9.96	44.01	54.00	9.99	AV
5	5387.48	46.68	10.07	56.75	74.00	17.25	PK
6	5411.50	34.67	10.21	44.88	54.00	9.12	AV
7	10477.32	32.53	16.77	49.30	54.00	4.70	AV
8	10482.00	41.05	16.73	57.78	68.20	10.42	PK
9	15719.44	18.35	20.23	38.58	54.00	15.42	AV
10	15724.12	27.46	20.27	47.73	74.00	26.27	PK

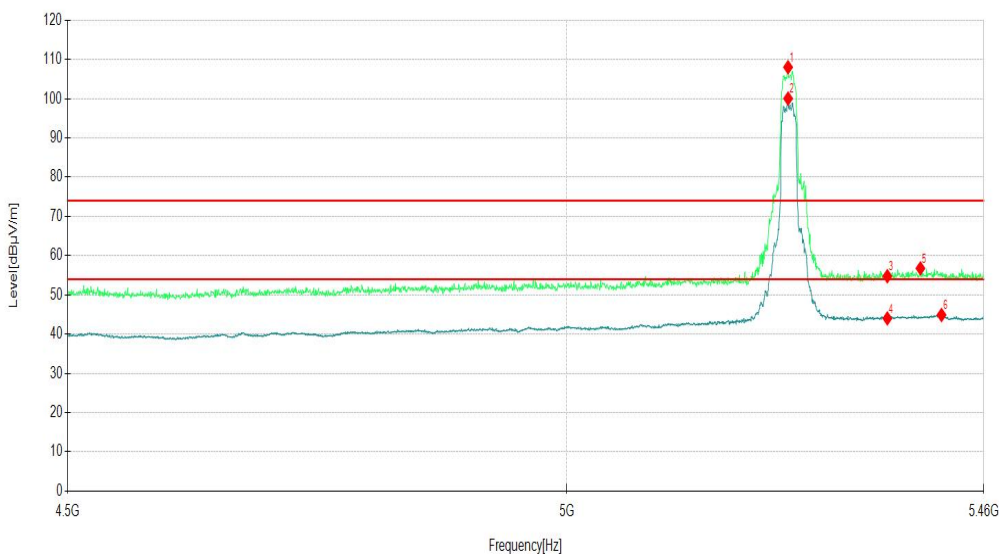

Remark: 1. The emission levels of other frequencies were greater than 20dB margin.  
 2. Level (dBμV/m) = Reading (dBμV) + Factor (dB/m).  
 3. Factor (dB/m) = Antenna Factor (dB/m) + Cable Factor (dB).  
 4. Margin(dB) = Limit[dBμV/m] - Level [dBμV/m]

<b>Channel</b>		<b>802.11a ANT1 CH48</b>		<b>Frequency</b>		5240 MHz	
<b>Frequency Range</b>		Above 1G		<b>Detector Function</b>		PK/AV	
<b>Vertical</b>							
NO.	Freq. [MHz]	Reading [dBμV]	Factor [dB/m]	Level [dBμV/m]	Limit [dBμV/m]	Margin [dB]	Detector
1	5241.01	96.32	8.22	104.54			AV
2	5241.49	105.04	8.22	113.26			PK
3	5350.00	34.86	9.96	44.82	54.00	9.18	AV
4	5350.00	46.37	9.96	56.33	74.00	17.67	PK
5	5402.85	49.50	10.10	59.60	74.00	14.40	PK
6	5406.69	35.26	10.21	45.47	54.00	8.53	AV
7	10482.00	41.04	16.73	57.77	68.20	10.43	PK
8	10482.00	32.52	16.73	49.25	54.00	4.75	AV
9	15718.27	31.78	20.24	52.02	74.00	21.98	PK
10	15719.44	21.51	20.23	41.74	54.00	12.26	AV

Remark: 1. The emission levels of other frequencies were greater than 20dB margin.  
 2. Level (dBuV/m) = Reading (dBuV) + Factor (dB/m).  
 3. Factor (dB/m) = Antenna Factor (dB/m) + Cable Factor (dB).  
 4. Margin(dB) = Limit[dBμV/m] - Level [dBμV/m]

**3.1.7 TEST RESULTS - Band 2 (5260-5320MHz):**

**ABOVE 1GHz DATA**

All test modes have been conducted, and the report only presents the worst case.

<b>Channel</b>	802.11a ANT1 CH52	<b>Frequency</b>	5260 MHz
<b>Frequency Range</b>	Above 1G	<b>Detector Function</b>	PK/AV

**Horizontal**

NO.	Freq. [MHz]	Reading [dBμV]	Factor [dB/m]	Level [dBμV/m]	Limit [dBμV/m]	Margin [dB]	Detector
1	5039.31	46.17	7.65	53.82	74.00	20.18	PK
2	5096.94	35.06	7.57	42.63	54.00	11.37	AV
3	5150.00	34.61	8.03	42.64	54.00	11.36	AV
4	5150.00	45.11	8.03	53.14	74.00	20.86	PK
5	5258.78	91.64	9.22	100.86			AV
6	5259.26	99.52	9.28	108.80			PK
7	10520.61	40.81	16.52	57.33	68.20	10.87	PK
8	10521.78	33.51	16.51	50.02	54.00	3.98	AV
9	15779.12	18.91	20.24	39.15	54.00	14.85	AV
10	15783.80	26.90	20.24	47.14	74.00	26.86	PK

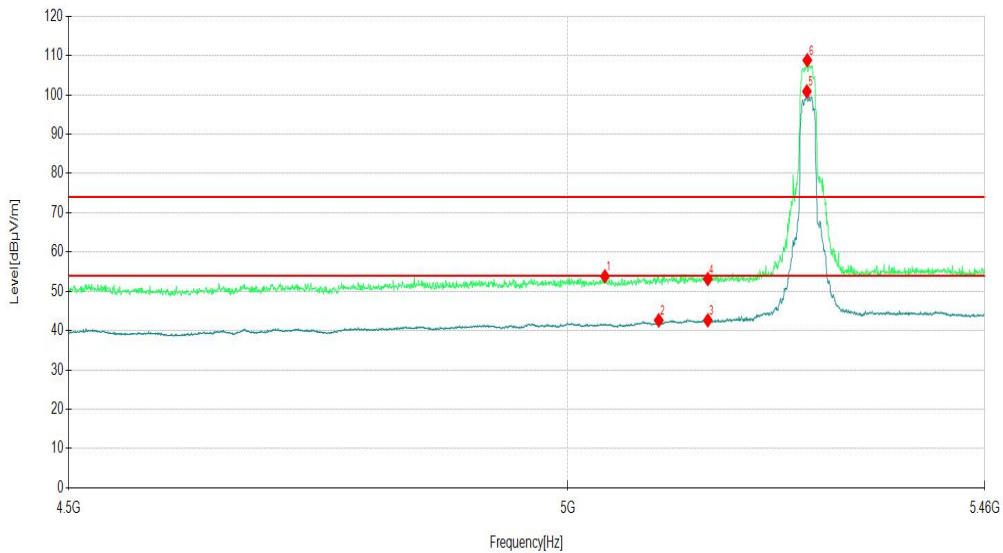

Remark: 1. The emission levels of other frequencies were greater than 20dB margin.  
 2. Level (dBuV/m) = Reading (dBuV) + Factor (dB/m).  
 3. Factor (dB/m) = Antenna Factor (dB/m) + Cable Factor (dB).  
 4. Margin(dB) = Limit[dBμV/m] - Level [dBμV/m]

<b>Channel</b>	<b>802.11a ANT1 CH52</b>	<b>Frequency</b>	5260 MHz
<b>Frequency Range</b>	Above 1G	<b>Detector Function</b>	PK/AV

**Vertical**

NO.	Freq. [MHz]	Reading [dBμV]	Factor [dB/m]	Level [dBμV/m]	Limit [dBμV/m]	Margin [dB]	Detector
1	5096.94	50.60	7.57	58.17	74.00	15.83	PK
2	5137.28	35.56	8.02	43.58	54.00	10.42	AV
3	5150.00	45.93	8.03	53.96	74.00	20.04	PK
4	5150.00	35.33	8.03	43.36	54.00	10.64	AV
5	5261.18	104.20	9.27	113.47			PK
6	5261.18	96.79	9.27	106.06			AV
7	10515.93	32.62	16.53	49.15	54.00	4.85	AV
8	10521.78	41.66	16.51	58.17	68.20	10.03	PK
9	15774.44	29.67	20.26	49.93	74.00	24.07	PK
10	15779.12	20.46	20.24	40.70	54.00	13.30	AV

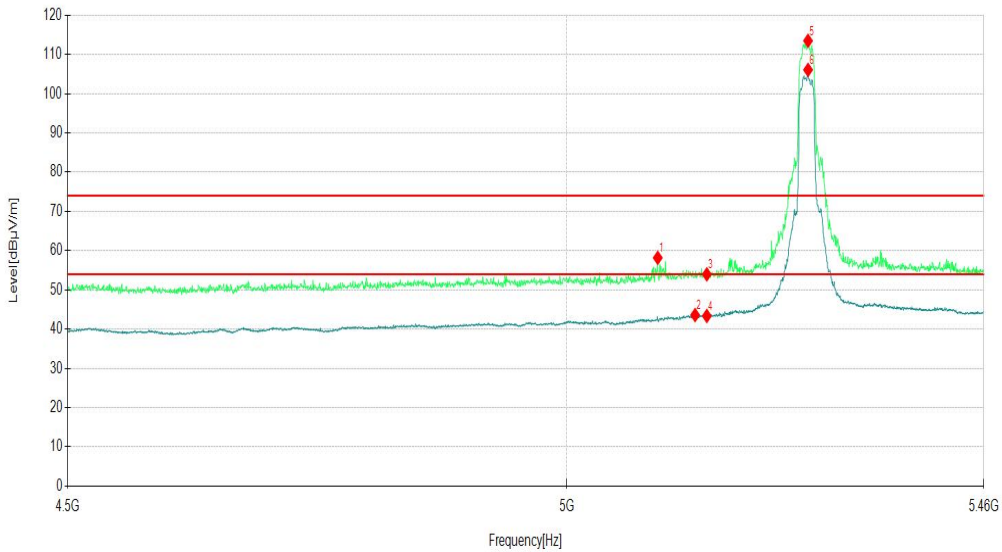

Remark: 1. The emission levels of other frequencies were greater than 20dB margin.  
 2. Level (dBuV/m) = Reading (dBuV) + Factor (dB/m).  
 3. Factor (dB/m) = Antenna Factor (dB/m) + Cable Factor (dB).  
 4. Margin(dB) = Limit[dBμV/m] - Level [dBμV/m]

<b>Channel</b>		<b>802.11a ANT1 CH60</b>		<b>Frequency</b>		5300MHz	
<b>Frequency Range</b>		Above 1G		<b>Detector Function</b>		PK/AV	
<b>Horizontal</b>							
NO.	Freq. [MHz]	Reading [dBμV]	Factor [dB/m]	Level [dBμV/m]	Limit [dBμV/m]	Margin [dB]	Detector
1	10597.84	32.98	15.98	48.96	54.00	5.04	AV
2	10602.52	43.15	16.00	59.15	74.00	14.85	PK
3	15899.64	18.56	20.42	38.98	54.00	15.02	AV
4	15899.64	27.04	20.42	47.46	74.00	26.54	PK
<b>Vertical</b>							
NO.	Freq. [MHz]	Reading [dBμV]	Factor [dB/m]	Level [dBμV/m]	Limit [dBμV/m]	Margin [dB]	Detector
1	10602.52	41.33	16.00	57.33	74.00	16.67	PK
2	10602.52	32.50	16.00	48.50	54.00	5.50	AV
3	15898.47	21.78	20.42	42.20	54.00	11.80	AV
4	15899.64	31.33	20.42	51.75	74.00	22.25	PK
Remark: 1. The emission levels of other frequencies were greater than 20dB margin. 2. Level (dBuV/m) = Reading (dBuV) + Factor (dB/m). 3. Factor (dB/m) = Antenna Factor (dB/m) + Cable Factor (dB). 4. Margin(dB) = Limit[dBμV/m] - Level [dBμV/m]							

<b>Channel</b>	<b>802.11a ANT1 CH64</b>	<b>Frequency</b>	5320 MHz
<b>Frequency Range</b>	Above 1G	<b>Detector Function</b>	PK/AV

**Horizontal**

NO.	Freq. [MHz]	Reading [dBμV]	Factor [dB/m]	Level [dBμV/m]	Limit [dBμV/m]	Margin [dB]	Detector
1	5319.29	99.50	8.99	108.49			PK
2	5319.29	91.55	8.99	100.54			AV
3	5350.00	36.92	9.96	46.88	54.00	7.12	AV
4	5350.00	49.01	9.96	58.97	74.00	15.03	PK
5	5360.11	36.36	10.05	46.41	54.00	7.59	AV
6	5374.04	48.67	10.01	58.68	74.00	15.32	PK
7	10641.13	40.59	15.79	56.38	74.00	17.62	PK
8	10642.30	33.53	15.79	49.32	54.00	4.68	AV
9	15954.64	18.19	20.62	38.81	54.00	15.19	AV
10	15959.32	26.68	20.61	47.29	74.00	26.71	PK

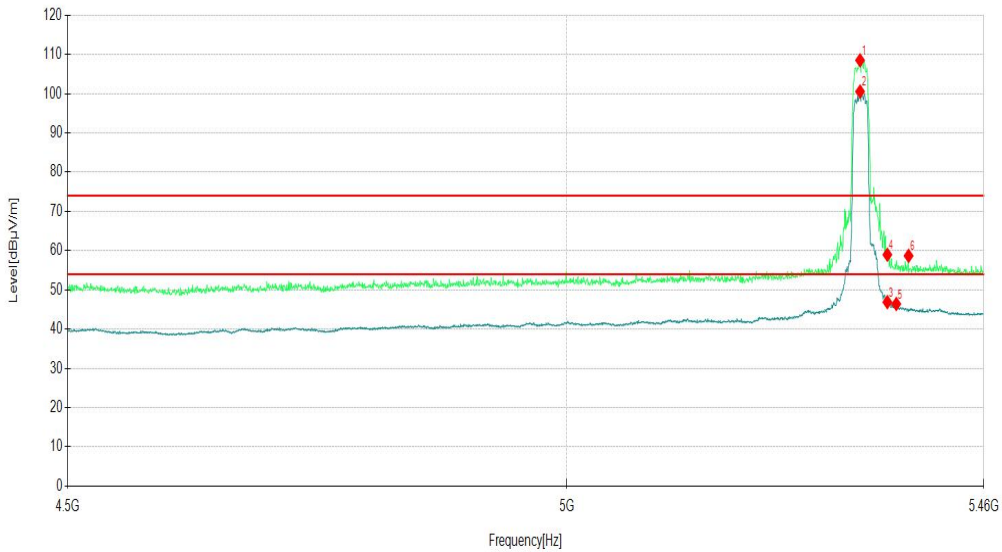

Remark: 1. The emission levels of other frequencies were greater than 20dB margin.  
 2. Level (dBμV/m) = Reading (dBμV) + Factor (dB/m).  
 3. Factor (dB/m) = Antenna Factor (dB/m) + Cable Factor (dB).  
 4. Margin(dB) = Limit[dBμV/m] - Level [dBμV/m]



<b>Channel</b>		<b>802.11a ANT1 CH64</b>		<b>Frequency</b>		5320 MHz	
<b>Frequency Range</b>		Above 1G		<b>Detector Function</b>		PK/AV	
<b>Vertical</b>							
NO.	Freq. [MHz]	Reading [dBμV]	Factor [dB/m]	Level [dBμV/m]	Limit [dBμV/m]	Margin [dB]	Detector
1	5320.73	105.56	9.01	114.57			PK
2	5320.73	97.11	9.01	106.12			AV
3	5350.00	40.31	9.96	50.27	54.00	3.73	AV
4	5350.00	53.78	9.96	63.74	74.00	10.26	PK
5	5354.83	50.62	10.01	60.63	74.00	13.37	PK
6	5361.07	38.16	10.04	48.20	54.00	5.80	AV
7	10637.62	32.31	15.81	48.12	54.00	5.88	AV
8	10646.98	41.90	15.76	57.66	74.00	16.34	PK
9	15959.32	22.86	20.61	43.47	54.00	10.53	AV
10	15964.00	31.24	20.58	51.82	74.00	22.18	PK

Remark: 1. The emission levels of other frequencies were greater than 20dB margin.  
 2. Level (dBuV/m) = Reading (dBuV) + Factor (dB/m).  
 3. Factor (dB/m) = Antenna Factor (dB/m) + Cable Factor (dB).  
 4. Margin(dB) = Limit[dBμV/m] - Level [dBμV/m]

**3.1.8 TEST RESULTS - Band 3 (5500-5700MHz):**

**ABOVE 1GHz DATA**

All test modes have been conducted, and the report only presents the worst case.

<b>Channel</b>	<b>802.11a ANT1 CH100</b>	<b>Frequency</b>	5500 MHz				
<b>Frequency Range</b>	Above 1G	<b>Detector Function</b>	PK/AV				
<b>Horizontal</b>							
NO.	Freq. [MHz]	Reading [dBμV]	Factor [dB/m]	Level [dBμV/m]	Limit [dBμV/m]	Margin [dB]	Detector
1	5410.91	35.13	10.25	45.38	54.00	8.62	AV
2	5415.03	48.57	10.02	58.59	74.00	15.41	PK
3	5464.31	51.01	9.97	60.98	68.20	7.22	PK
4	5470.00	49.34	9.95	59.29	68.20	8.91	PK
5	5500.83	99.63	9.25	108.88			PK
6	5503.08	90.58	9.37	99.95			AV
7	11002.70	26.13	14.84	40.97	54.00	13.03	AV
8	11007.38	34.96	14.85	49.81	74.00	24.19	PK
9	16500.00	20.15	23.16	43.31	68.20	24.89	PK
10	16500.00	11.46	23.16	34.62	54.00	19.38	AV

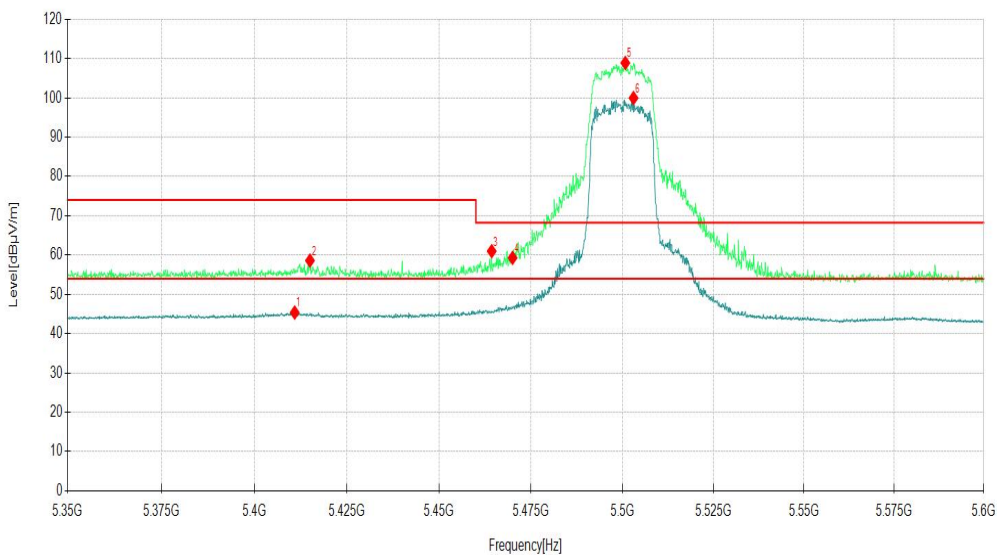

Remark: 1. The emission levels of other frequencies were greater than 20dB margin.  
 2. Level (dBμV/m) = Reading (dBμV) + Factor (dB/m).  
 3. Factor (dB/m) = Antenna Factor (dB/m) + Cable Factor (dB).  
 4. Margin(dB) = Limit[dBμV/m] - Level [dBμV/m]

<b>Channel</b>	<b>802.11a ANT1 CH100</b>	<b>Frequency</b>	5500 MHz
<b>Frequency Range</b>	Above 1G	<b>Detector Function</b>	PK/AV

**Vertical**

NO.	Freq. [MHz]	Reading [dBμV]	Factor [dB/m]	Level [dBμV/m]	Limit [dBμV/m]	Margin [dB]	Detector
1	5419.91	51.70	9.76	61.46	74.00	12.54	PK
2	5455.18	38.21	9.86	48.07	54.00	5.93	AV
3	5459.80	50.42	9.98	60.40	74.00	13.60	PK
4	5470.00	50.27	9.95	60.22	68.20	7.98	PK
5	5500.95	104.96	9.26	114.22			PK
6	5501.08	95.84	9.27	105.11			AV
7	10996.85	35.05	14.82	49.87	74.00	24.13	PK
8	10998.02	25.58	14.82	40.40	54.00	13.60	AV
9	16499.91	15.66	23.16	38.82	54.00	15.18	AV
10	16503.42	25.68	23.18	48.86	68.20	19.34	PK

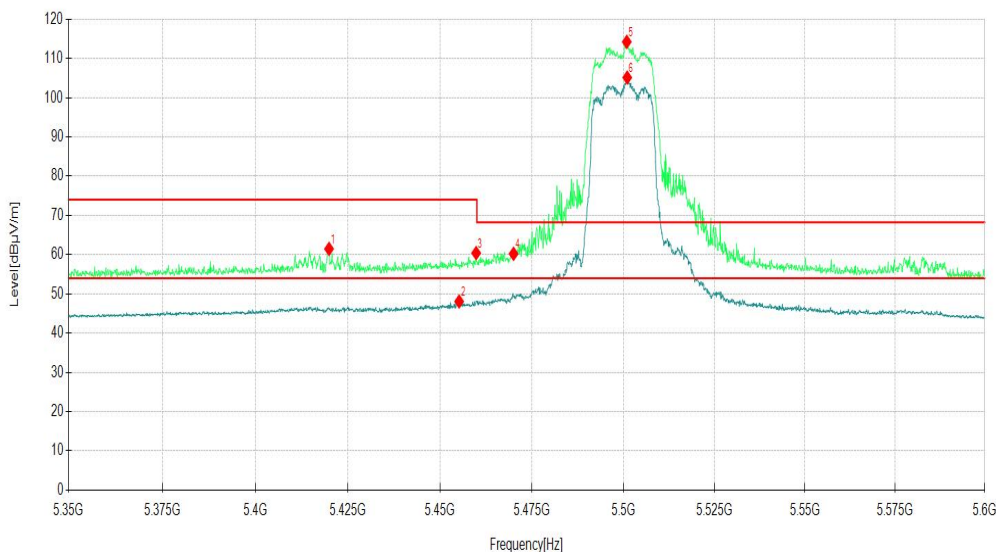

Remark: 1. The emission levels of other frequencies were greater than 20dB margin.  
 2. Level (dBuV/m) = Reading (dBuV) + Factor (dB/m).  
 3. Factor (dB/m) = Antenna Factor (dB/m) + Cable Factor (dB).  
 4. Margin(dB) = Limit[dBμV/m] - Level [dBμV/m]

<b>Channel</b>		<b>802.11a ANT1 CH 116</b>		<b>Frequency</b>		5580MHz	
<b>Frequency Range</b>		Above 1G		<b>Detector Function</b>		PK/AV	
<b>Horizontal</b>							
NO.	Freq. [MHz]	Reading [dB $\mu$ V]	Factor [dB/m]	Level [dB $\mu$ V/m]	Limit [dB $\mu$ V/m]	Margin [dB]	Detector
1	11160.00	33.30	15.23	48.53	74.00	25.47	PK
2	11160.00	24.50	15.23	39.73	54.00	14.27	AV
3	16740.00	20.93	24.44	45.37	68.20	22.83	PK
4	16740.00	12.06	24.44	36.50	54.00	17.50	AV
<b>Vertical</b>							
NO.	Freq. [MHz]	Reading [dB $\mu$ V]	Factor [dB/m]	Level [dB $\mu$ V/m]	Limit [dB $\mu$ V/m]	Margin [dB]	Detector
1	11160.00	29.04	15.23	44.27	74.00	29.73	PK
2	11160.00	20.04	15.23	35.27	54.00	18.73	AV
3	16740.00	20.56	24.44	45.00	68.20	23.20	PK
4	16740.00	11.57	24.44	36.01	54.00	17.99	AV
Remark: 1. The emission levels of other frequencies were greater than 20dB margin. 2. Level (dB $\mu$ V/m) = Reading (dB $\mu$ V) + Factor (dB/m). 3. Factor (dB/m) = Antenna Factor (dB/m) + Cable Factor (dB). 4. Margin(dB) = Limit[dB $\mu$ V/m] - Level [dB $\mu$ V/m]							

<b>Channel</b>		<b>802.11a ANT1 CH140</b>		<b>Frequency</b>		5700 MHz	
<b>Frequency Range</b>		Above 1G		<b>Detector Function</b>		PK/AV	
<b>Horizontal</b>							
NO.	Freq. [MHz]	Reading [dBμV]	Factor [dB/m]	Level [dBμV/m]	Limit [dBμV/m]	Margin [dB]	Detector
1	5700.88	97.10	8.93	106.03			PK
2	5725.00	48.36	8.89	57.25	68.20	10.95	PK
3	5726.19	48.73	8.84	57.57	68.20	10.63	PK
4	11400.00	26.57	15.10	41.67	54.00	12.33	AV
5	11400.00	33.92	15.10	49.02	74.00	24.98	PK
6	17100.00	10.67	25.93	36.60	54.00	17.40	AV
7	17100.00	18.98	25.93	44.91	68.20	23.29	PK

  

Remark: 1. The emission levels of other frequencies were greater than 20dB margin.  
 2. Level (dBuV/m) = Reading (dBuV) + Factor (dB/m).  
 3. Factor (dB/m) = Antenna Factor (dB/m) + Cable Factor (dB).  
 4. Margin(dB) = Limit[dBμV/m] - Level [dBμV/m]

<b>Channel</b>	<b>802.11a ANT1 CH140</b>	<b>Frequency</b>	5700 MHz
<b>Frequency Range</b>	Above 1G	<b>Detector Function</b>	PK/AV

**Vertical**

NO.	Freq. [MHz]	Reading [dBμV]	Factor [dB/m]	Level [dBμV/m]	Limit [dBμV/m]	Margin [dB]	Detector
1	5701.58	104.64	8.90	113.54			PK
2	5725.00	53.80	8.89	62.69	68.20	5.51	PK
3	5726.89	55.21	8.80	64.01	68.20	4.19	PK
4	11400.00	35.38	15.10	50.48	74.00	23.52	PK
5	11400.00	24.60	15.10	39.70	54.00	14.30	AV
6	17100.00	19.18	25.93	45.11	68.20	23.09	PK
7	17100.00	10.82	25.93	36.75	54.00	17.25	AV

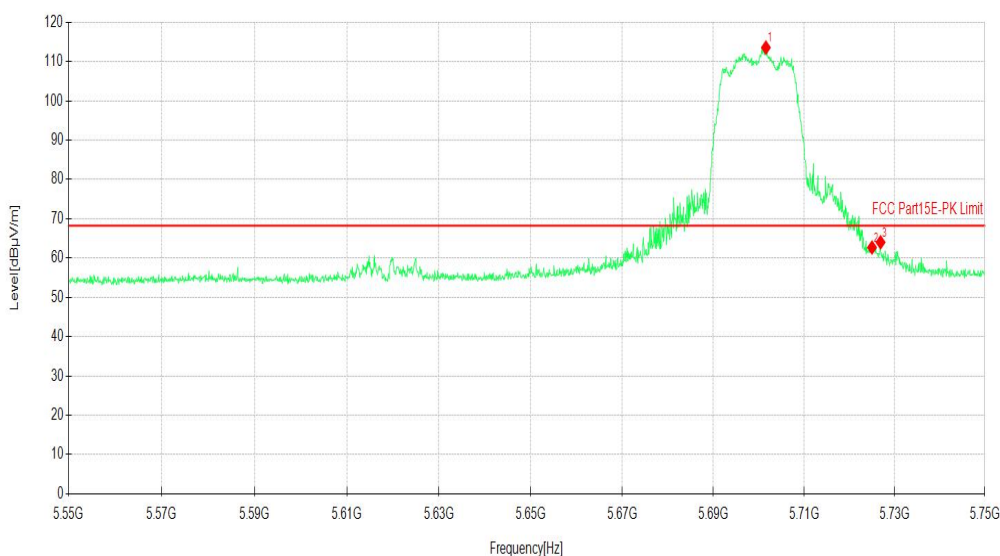

Remark: 1. The emission levels of other frequencies were greater than 20dB margin.  
 2. Level (dBuV/m) = Reading (dBuV) + Factor (dB/m).  
 3. Factor (dB/m) = Antenna Factor (dB/m) + Cable Factor (dB).  
 4. Margin(dB) = Limit[dBμV/m] - Level [dBμV/m]

<b>Channel</b>		<b>802.11a ANT1 CH144</b>		<b>Frequency</b>		5720 MHz	
<b>Frequency Range</b>		Above 1G		<b>Detector Function</b>		PK/AV	
<b>Horizontal</b>							
NO.	Freq. [MHz]	Reading [dB $\mu$ V]	Factor [dB/m]	Level [dB $\mu$ V/m]	Limit [dB $\mu$ V/m]	Margin [dB]	Detector
1	11440.00	32.46	15.04	47.50	74.00	26.50	PK
2	11440.00	24.83	15.04	39.87	54.00	14.13	AV
3	17160.00	20.82	25.86	46.68	68.20	21.52	PK
4	17160.00	10.82	25.86	36.68	54.00	17.32	AV
<b>Vertical</b>							
NO.	Freq. [MHz]	Reading [dB $\mu$ V]	Factor [dB/m]	Level [dB $\mu$ V/m]	Limit [dB $\mu$ V/m]	Margin [dB]	Detector
1	11440.00	34.46	15.04	49.50	74.00	24.50	PK
2	11440.00	26.83	15.04	41.87	54.00	12.13	AV
3	17160.00	20.47	25.86	46.33	68.20	21.87	PK
4	17160.00	12.13	25.86	37.99	54.00	16.01	AV
Remark: 1. The emission levels of other frequencies were greater than 20dB margin. 2. Level (dB $\mu$ V/m) = Reading (dB $\mu$ V) + Factor (dB/m). 3. Factor (dB/m) = Antenna Factor (dB/m) + Cable Factor (dB). 4. Margin(dB) = Limit[dB $\mu$ V/m] - Level [dB $\mu$ V/m]							

**3.1.9 TEST RESULTS - Band 4 (5745-5825MHz):**

**ABOVE 1GHz DATA**

All test modes have been conducted, and the report only presents the worst case.

<b>Channel</b>		<b>802.11a ANT1 CH149</b>		<b>Frequency</b>		5745 MHz	
<b>Frequency Range</b>		Above 1G		<b>Detector Function</b>		PK/AV	
<b>Horizontal</b>							
NO.	Freq. [MHz]	Reading [dBμV]	Factor [dB/m]	Level [dBμV/m]	Limit [dBμV/m]	Margin [dB]	Detector
1	5619.51	47.63	8.99	56.62	68.20	11.58	PK
2	5745.57	98.33	8.93	107.26			PK
3	5938.04	47.19	10.75	57.94	68.20	10.26	PK
4	11489.47	29.14	15.05	44.19	54.00	9.81	AV
5	11490.00	32.81	15.04	47.85	74.00	26.15	PK
6	17235.00	13.37	25.54	38.91	54.00	15.09	AV
7	17235.00	19.70	25.54	45.24	68.20	22.96	PK

Remark: 1. The emission levels of other frequencies were greater than 20dB margin.  
 2. Level (dBuV/m) = Reading (dBuV) + Factor (dB/m).  
 3. Factor (dB/m) = Antenna Factor (dB/m) + Cable Factor (dB).  
 4. Margin(dB) = Limit[dBμV/m] - Level [dBμV/m]



<b>Channel</b>	<b>802.11a ANT1 CH149</b>	<b>Frequency</b>	5745 MHz
<b>Frequency Range</b>	Above 1G	<b>Detector Function</b>	PK/AV

**Vertical**

NO.	Freq. [MHz]	Reading [dBμV]	Factor [dB/m]	Level [dBμV/m]	Limit [dBμV/m]	Margin [dB]	Detector
1	5631.89	47.82	8.93	56.75	68.20	11.45	PK
2	5746.14	104.86	8.93	113.79			PK
3	5941.42	47.78	10.65	58.43	68.20	9.77	PK
4	11489.47	31.85	15.05	46.90	54.00	7.10	AV
5	11494.15	40.03	15.04	55.07	74.00	18.93	PK
6	17223.04	24.45	25.56	50.01	68.20	18.19	PK
7	17232.40	17.40	25.53	42.93	54.00	11.07	AV

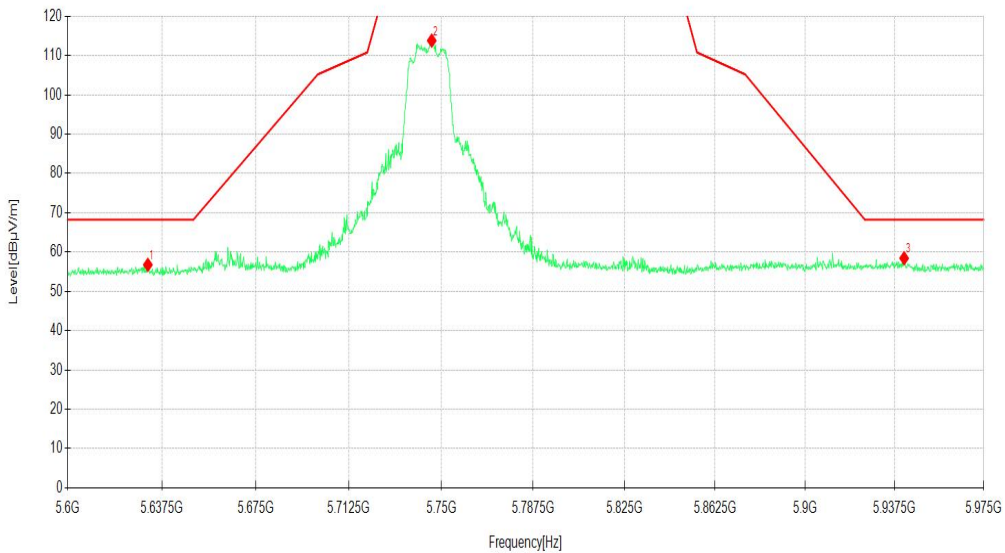

Remark: 1. The emission levels of other frequencies were greater than 20dB margin.  
 2. Level (dBuV/m) = Reading (dBuV) + Factor (dB/m).  
 3. Factor (dB/m) = Antenna Factor (dB/m) + Cable Factor (dB).  
 4. Margin(dB) = Limit[dBμV/m] - Level [dBμV/m]

<b>Channel</b>		<b>802.11a ANT1 CH157</b>		<b>Frequency</b>		5785MHz	
<b>Frequency Range</b>		Above 1G		<b>Detector Function</b>		PK/AV	
<b>Horizontal</b>							
NO.	Freq. [MHz]	Reading [dB $\mu$ V]	Factor [dB/m]	Level [dB $\mu$ V/m]	Limit [dB $\mu$ V/m]	Margin [dB]	Detector
1	11570.00	35.33	15.34	50.67	74.00	23.33	PK
2	11570.00	28.35	15.34	43.69	54.00	10.31	AV
3	17355.00	19.11	26.31	45.42	68.20	22.78	PK
4	17355.00	12.04	26.31	38.35	54.00	15.65	AV
<b>Vertical</b>							
NO.	Freq. [MHz]	Reading [dB $\mu$ V]	Factor [dB/m]	Level [dB $\mu$ V/m]	Limit [dB $\mu$ V/m]	Margin [dB]	Detector
1	11564.36	34.90	15.37	50.27	54.00	3.73	AV
2	11574.89	42.09	15.34	57.43	74.00	16.57	PK
3	17356.44	16.32	26.29	42.61	54.00	11.39	AV
4	17359.95	24.80	26.21	51.01	68.20	17.19	PK
Remark: 1. The emission levels of other frequencies were greater than 20dB margin. 2. Level (dB $\mu$ V/m) = Reading (dB $\mu$ V) + Factor (dB/m). 3. Factor (dB/m) = Antenna Factor (dB/m) + Cable Factor (dB). 4. Margin(dB) = Limit[dB $\mu$ V/m] - Level [dB $\mu$ V/m]							

<b>Channel</b>	<b>802.11a ANT1 CH165</b>	<b>Frequency</b>	5825 MHz
<b>Frequency Range</b>	Above 1G	<b>Detector Function</b>	PK/AV

**Horizontal**

NO.	Freq. [MHz]	Reading [dBμV]	Factor [dB/m]	Level [dBμV/m]	Limit [dBμV/m]	Margin [dB]	Detector
1	5623.26	46.90	9.01	55.91	68.20	12.29	PK
2	5826.80	97.90	8.77	106.67			PK
3	5939.36	46.71	10.79	57.50	68.20	10.70	PK
4	11648.60	38.82	15.20	54.02	74.00	19.98	PK
5	11649.78	30.40	15.20	45.60	54.00	8.40	AV
6	17475.00	19.37	26.05	45.42	68.20	22.78	PK
7	17475.00	10.50	26.05	36.55	54.00	17.45	AV

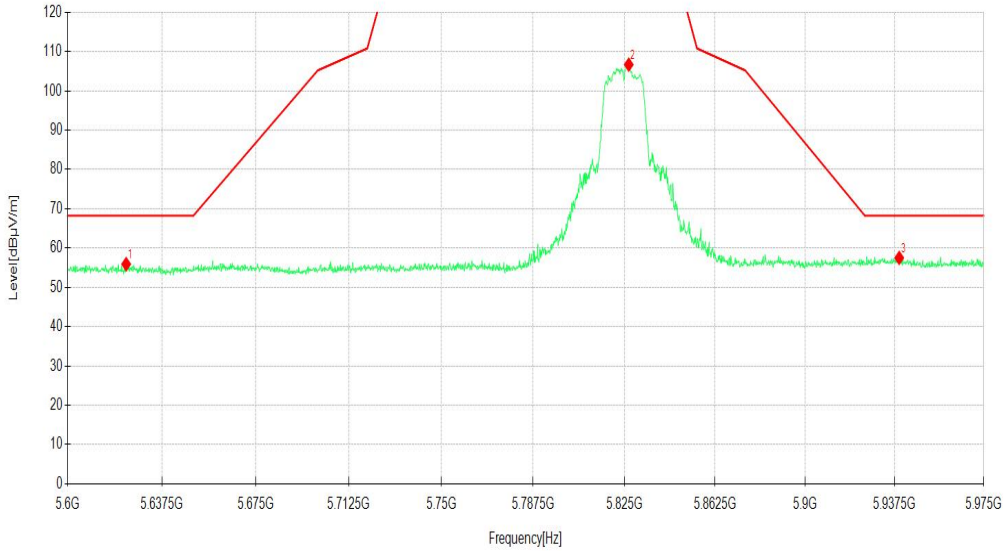

Remark: 1. The emission levels of other frequencies were greater than 20dB margin.  
 2. Level (dBuV/m) = Reading (dBuV) + Factor (dB/m).  
 3. Factor (dB/m) = Antenna Factor (dB/m) + Cable Factor (dB).  
 4. Margin(dB) = Limit[dBμV/m] - Level [dBμV/m]

<b>Channel</b>	<b>802.11a ANT1 CH165</b>	<b>Frequency</b>	5825 MHz
<b>Frequency Range</b>	Above 1G	<b>Detector Function</b>	PK/AV

**Vertical**

NO.	Freq. [MHz]	Reading [dBμV]	Factor [dB/m]	Level [dBμV/m]	Limit [dBμV/m]	Margin [dB]	Detector
1	5612.57	47.86	9.02	56.88	68.20	11.32	PK
2	5823.42	106.09	8.81	114.90			PK
3	5937.67	47.40	10.74	58.14	68.20	10.06	PK
4	11643.92	41.95	15.15	57.10	74.00	16.90	PK
5	11648.60	34.63	15.20	49.83	54.00	4.17	AV
6	17472.28	25.63	26.03	51.66	68.20	16.54	PK
7	17472.28	17.27	26.03	43.30	54.00	10.70	AV

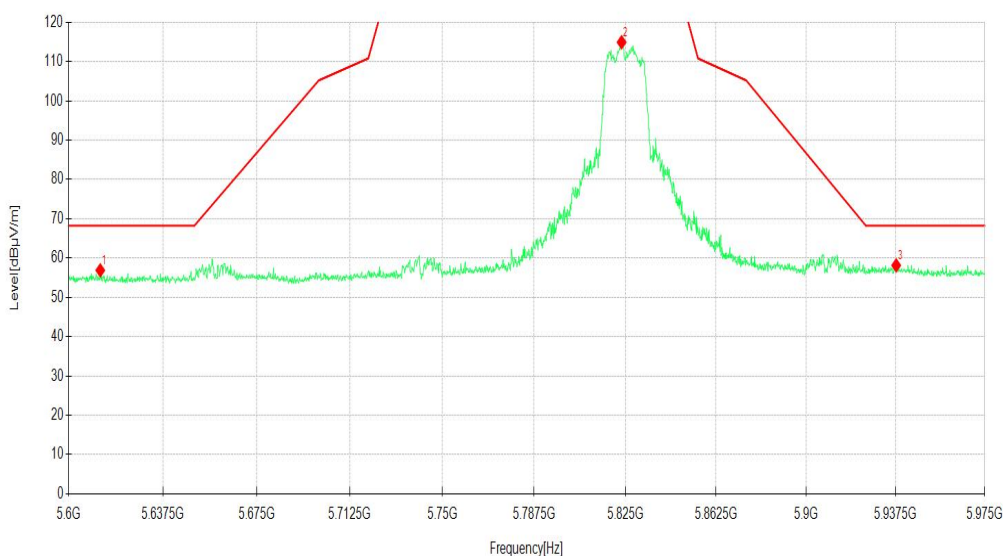

Remark: 1. The emission levels of other frequencies were greater than 20dB margin.  
 2. Level (dBuV/m) = Reading (dBuV) + Factor (dB/m).  
 3. Factor (dB/m) = Antenna Factor (dB/m) + Cable Factor (dB).  
 4. Margin(dB) = Limit[dBμV/m] - Level [dBμV/m]

### 3.3 OCCUPIED BANDWIDTH MEASUREMENT

#### 3.3.1 Measurement procedure

The transmitter antenna output was connected to the spectrum analyzer through an attenuator. The resolution bandwidth shall be set to the range of 1% to 5% of the anticipated emission bandwidth, and a video bandwidth at least 3x the resolution bandwidth. below the lower and above the upper frequency limits, the mean powers emitted are each equal to a specified percentage 0.5 %of the total mean power of a given emission.

#### 3.3.2 TEST SETUP



### 3.4 26DB EMISSION BANDWIDTH

#### 3.4.1 LIMITS OF 26DB EMISSION BANDWIDTH

This section is for reporting purpose only, there is on restriction limit of bandwidth

#### 3.4.2 TEST PROCEDURES

##### FOR 26dB BANDWIDTH

- 1) Set RBW = approximately 1% of the emission bandwidth.
- 2) Set the VBW > RBW.
- 3) Detector = Peak
- 4) Trace mode = max hold.
- 5) Measure the maximum width of the emission that is 26 dB down from the peak of the emission. Compare this with the RBW setting of the analyzer. Readjust RBW and repeat measurement as needed until the RBW/EBW ratio is approximately 1%.

#### 3.4.3 TEST SETUP

##### FOR 26dB BANDWIDTH

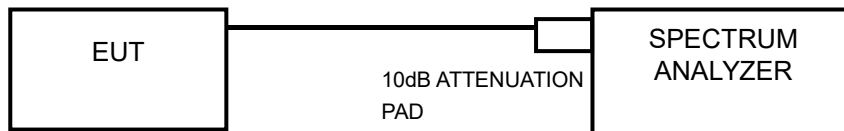

### 3.5 6DB EMISSION BANDWIDTH

#### 3.5.1 LIMITS OF 6DB EMISSION BANDWIDTH

The minimum of 6dB Bandwidth Measurement is 0.5MHz.

#### 3.5.2 TEST PROCEDURES

##### FOR 6dB BANDWIDTH

- 1)Set RBW = 100 kHz.
- 2)Set the video bandwidth (VBW)  $\geq$  3 RBW.
- 3)Detector = Peak.
- 4)Trace mode = max hold.
- 5) Sweep = auto couple.
- 6) Allow the trace to stabilize.
- 7)Measure the maximum width of the emission that is constrained by the frequencies associated with the two outermost amplitude points (upper and lower frequencies) that are attenuated by 6 dB relative to the maximum level measured in the fundamental emission.

#### 3.5.3 TEST SETUP

##### FOR 6dB BANDWIDTH

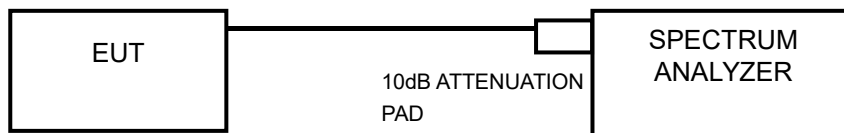

**3.6 TRANSMIT POWER MEASUREMENT**

**3.6.1 LIMITS OF TRANSMIT POWER MEASUREMENT(FCC)**

Operation Band	EUT Category		LIMIT
U-NII-1		Outdoor Access Point	1 Watt (30 dBm) (Max. e.i.r.p $\leq$ 125mW(21 dBm) at any elevation angle above 30 degrees as measured from the horizon)
		Fixed point-to-point Access Point	1 Watt (30 dBm)
		Indoor Access Point	1 Watt (30 dBm)
	√	Mobile and Portable client device	250mW (24 dBm)
U-NII-2A	√		250mW(24dBm) or 11 dBm+10LogB*
U-NII-2C	√		250mW(24dBm) or 11 dBm+10LogB*
U-NII-3	√		1 Watt (30 dBm)

**NOTE:** 1. Where B is the 26dB emission bandwidth in MHz.

**3.6.2 TEST PROCEDURES**

**FOR AVERAGE POWER MEASUREMENT**

Method PM is used to perform output power measurement, trigger and gating function of wide band power meter is enabled to measure max output power of TX on burst. Duty factor is not added to measured value.

**3.6.3 TEST SETUP**

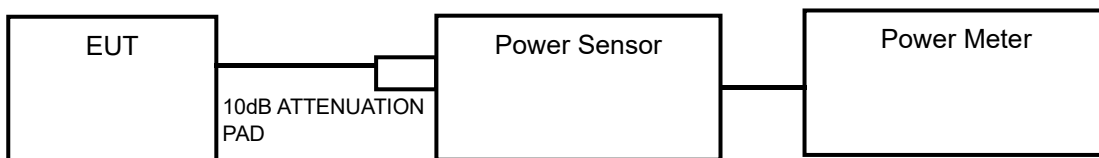



### 3.7 POWER SPECTRAL DENSITY MEASUREMENT

#### 3.7.1 LIMITS OF PEAK POWER SPECTRAL DENSITY MEASUREMENT(FCC)

Operation Band	EUT Category		LIMIT
U-NII-1		Outdoor Access Point	17dBm/ MHz
		Fixed point-to-point Access Point	
		Indoor Access Point	
	√	Mobile and Portable client device	11dBm/ MHz
U-NII-2A	√		11dBm/ MHz
U-NII-2C	√		11dBm/ MHz
U-NII-3	√		30dBm/ 500kHz

#### 3.7.2 TEST PROCEDURE

**For U-NII-1, U-NII-2A, U-NII-2Cband:**

Using method SA-2

- 1) Set span to encompass the entire emission bandwidth (EBW) of the signal.
- 2) Set RBW = 1MHz, Set VBW =3 MHz, Detector = AV
- 3) Set Channel power measure = 1MHz
- 4) Sweep time = auto, trigger set to“free run”.
- 5) Trace average at least 100 traces in power averaging mode.
- 6) Record the max value and add 10 log (1/duty cycle)

**For U-NII-3 band:**

Using method SA-2

- 1) Set span to encompass the entire emission bandwidth (EBW) of the signal.
- 2) Set RBW = 300 kHz, Set VBW =1 MHz, Detector = AV
- 3) Set Channel power measure = 1MHz
- 4) Sweep time = auto, trigger set to“free run”.
- 5) Trace average at least 100 traces in power averaging mode.
- 6) Record the max value and add 10 log (1/duty cycle)

#### 3.7.3 TEST SETUP

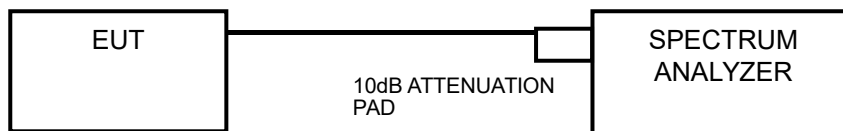

### 3.8 FREQUENCY STABILITY

#### 3.8.1 LIMITS OFFREQUENCY STABILITY

The frequency of the carrier signal shall be maintained within band of operation.

#### 3.8.2 TEST PROCEDURES

- a. The EUT was placed inside the environmental test chamber and powered by nominal AC voltage.
- b. Turn the EUT on and couple its output to a spectrum analyzer.
- c. Turn the EUT off and set the chamber to the highest temperature specified.
- d. Allow sufficient time (approximately 30 min) for the temperature of the chamber to stabilize, turn the EUT on and measure the operating frequency after 2, 5, and 10 minutes.
- e. Repeat step 2 and 3 with the temperature chamber set to the lowest temperature.
- f. The test chamber was allowed to stabilize at +20 degree C for a minimum of 30 minutes. The supply voltage was then adjusted on the EUT from 85% to 115% and the frequency record.

#### 3.8.3 TEST SETUP

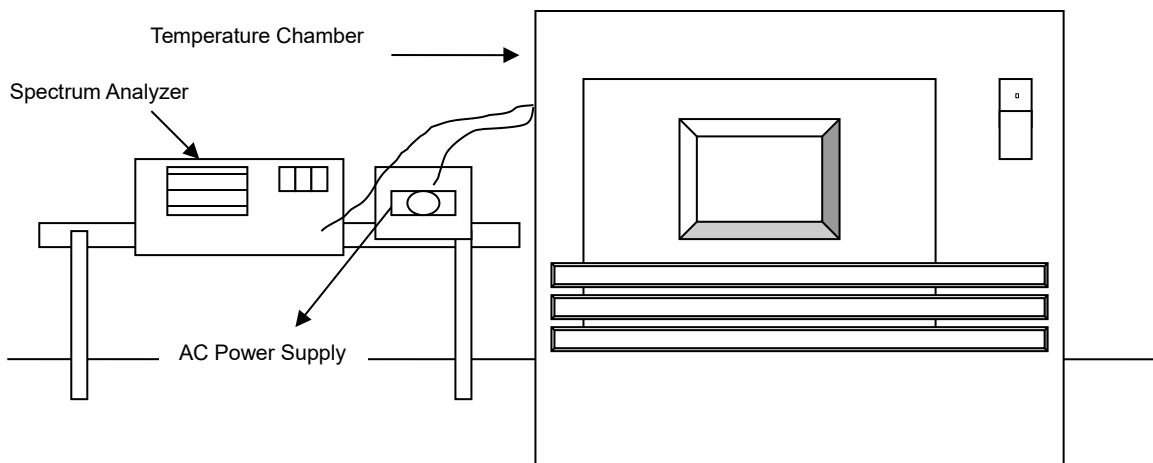

### 3.9 ANTENNA REQUIREMENT

#### 3.9.1 LIMITS OFFREQUENCY STABILITY

For intentional device, according to FCC 47 CFR Section 15.203, an intentional radiator shall be designed to ensure that no antenna other than that furnished by the responsible party shall be used with the device. According to FCC 47 CFR Section 15.407(a)(1)(2) , if transmitting antennas of directional gain greater than 6 dBi are used, the power shall be reduced by the amount in dB that the directional gain of the antenna exceeds 6 dBi.

#### 3.9.2 ANTENNA ANTI-REPLACEMENT CONSTRUCTION

The antenna used for this product is PIFA antenna and that no antenna other than that furnished by the responsible party shall be used with the device

#### 3.9.3 ANTENNA GAIN

The maximum peak gain of the transmit antenna 1 is 1.96 dBi.

The maximum peak gain of the transmit antenna 2 is 1.96dBi.

Operation Band	Chain 1 Antenna Gain(dBi)	Chain 2 Antenna Gain(dBi)	DG For Power (dBi)	Power Limit Reduction
5180 ~ 5240MHz 5260 ~ 5320MHz 5500 ~ 5720MHz 5745 ~ 5825MHz	1.96	1.96	4.97	0

Refer to KDB662911 D01 Multiple Transmitter Output v02r01.

d) *Unequal antenna gains, with equal transmit powers.* For antenna gains given by  $G_1, G_2, \dots, G_N$  dBi

(i) If transmit signals are *correlated*, then

Directional gain =  $10 \log[(10^{G_1/20} + 10^{G_2/20} + \dots + 10^{G_N/20})^2 / N_{ANT}]$  dBi [Note the “20”s in the denominator of each exponent and the square of the sum of terms; the object is to combine the signal levels coherently.]

(ii) If all transmit signals are *completely uncorrelated*, then

Directional gain =  $10 \log[(10^{G_1/10} + 10^{G_2/10} + \dots + 10^{G_N/10}) / N_{ANT}]$  dBi

#### **4 PHOTOGRAPHS OF TEST SETUP**

Please refer to the attached file (Test Setup Photo).

## **5 PHOTOGRAPHS OF THE EUT**

Please refer to the attached file (External Photos report and Internal Photos).

**----- End of the Report -----**

## Important

- (1) The test report is invalid without the official stamp of CVC;
- (2) Any part photocopies of the test report are forbidden without the written permission from CVC;
- (3) The test report is invalid without the signatures of Approval and Reviewer;
- (4) The test report is invalid if altered;
- (5) Objections to the test report must be submitted to CVC within 15 days.
- (6) Generally, commission test is responsible for the tested samples only.
- (7) As for the test result “-” or “N” means “not applicable”, “/” means “not test”, “P” means “pass” and “F” means “fail”

*\*\*The test data and test results given in this test report should only be used for purposes of scientific research, teaching and internal quality control when the CMA symbol is not presented.\*\**

Address: No. 1301, Guanguang Road, Xinlan Community, Guanlan Street,  
Longhua District, Shenzhen, Guangdong, 518110, P. R. China

Post Code: 518110 Tel: 0755-23763060-8805

Fax: 0755-23763060 E-mail: sz-kf@cvc.org.cn

<http://www.cvc.org.cn>