

TEST REPORT

Applicant: Sichuan AI-Link Technology Co., Ltd
Address: Anzhou Industrial Park, Mianyang, Sichuan, P.R.C
Equipment Type: WIFI module
Model Name: AL-7605B-WG-A (refer section 2.4)
Brand Name: AILINK
FCC ID: 2AOKI-AL7605B
IC Number: 23460-AL7605B
47 CFR Part 15 Subpart C
Test Standard: RSS-Gen Issue 5
RSS-247 Issue 2
(refer section 3.1)
Test Date: Mar. 08, 2022 ~ Mar. 18, 2022
Date of Issue: Mar. 24, 2022

ISSUED BY:

Shenzhen BALUN Technology Co., Ltd.

Tested by: Julie zhu

Checked by: Ye Hongji

Approved by: Liao Jianming
(Technical Director)

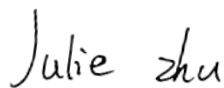

Revision History		
Version	Issue Date	Revisions
<u>Rev. 01</u>	<u>Mar. 24, 2022</u>	<u>Initial Issue</u>

TABLE OF CONTENTS

1	Administrative Data (GENERAL INFORMATION).....	4
1.1	Identification of the Testing Laboratory	4
1.2	Identification of the Responsible Testing Location	4
2	PRODUCT INFORMATION	5
2.1	Applicant Information	5
2.2	Manufacturer Information.....	5
2.3	Factory Information.....	5
2.4	General Description for Equipment under Test (EUT).....	5
2.5	Technical Information	6
2.6	Additional Instructions.....	9
3	SUMMARY OF TEST RESULTS	11
3.1	Test Standards	11
3.2	Test Verdict	12
4	GENERAL TEST CONFIGURATIONS	13
4.1	Test Environments.....	13
4.2	Test Equipment List.....	13
4.3	Test Software List.....	13
4.4	Measurement Uncertainty.....	14
4.5	Description of Test Setup	14
4.6	Measurement Results Explanation Example.....	17
5	TEST ITEMS	18
5.1	Antenna Requirements	18
5.2	Output Power	19
5.3	6dB Bandwidth	21

5.4	Conducted Spurious Emission.....	22
5.5	Band Edge (Authorized-band band-edge).....	24
5.6	Conducted Emission.....	26
5.7	Radiated Spurious Emission.....	27
5.8	Band Edge (Restricted-band band-edge).....	32
5.9	Power Spectral density (PSD)	33
ANNEX A	TEST RESULT	34
A.1	Output Power	34
A.2	Bandwidth.....	34
A.3	Conducted Spurious Emissions	34
A.4	Band Edge (Authorized-band band-edge).....	34
A.5	Conducted Emissions	34
A.6	Radiated Emission.....	35
A.7	Band Edge (Restricted-band band-edge).....	52
A.8	Power Spectral Density (PSD).....	63
ANNEX B	TEST SETUP PHOTOS	64
ANNEX C	EUT EXTERNAL PHOTOS.....	64
ANNEX D	EUT INTERNAL PHOTOS.....	64

1 Administrative Data (GENERAL INFORMATION)

1.1 Identification of the Testing Laboratory

Company Name	Shenzhen BALUN Technology Co., Ltd.
Address	Block B, 1/F, Baisha Science and Technology Park Shahe Xi Road, Nanshan District Shenzhen, Guangdong Province, People's Republic of China
Phone Number	+86 755 6685 0100

1.2 Identification of the Responsible Testing Location

Test Location	Shenzhen BALUN Technology Co., Ltd.
Address	Block B, 1/F, Baisha Science and Technology Park Shahe Xi Road, Nanshan District Shenzhen, Guangdong Province, People's Republic of China
Accreditation Certificate	The laboratory has been listed by Industry Canada to perform electromagnetic emission measurements. The recognition numbers of test site are 11524A-1. The laboratory is a testing organization accredited by FCC as a accredited testing laboratory. The designation number is CN1196.
Description	All measurement facilities used to collect the measurement data are located at Block B, 1/F, Baisha Science and Technology Park Shahe Xi Road, Nanshan District Shenzhen, Guangdong Province, People's Republic of China

2 PRODUCT INFORMATION

2.1 Applicant Information

Applicant	Sichuan AI-Link Technology Co., Ltd
Address	Anzhou Industrial Park, Mianyang, Sichuan, P.R.C

2.2 Manufacturer Information

Manufacturer	Sichuan AI-Link Technology Co., Ltd
Address	Anzhou Industrial Park, Mianyang, Sichuan, P.R.C

2.3 Factory Information

Factory	Sichuan AI-Link Technology Co., Ltd
Address	Anzhou Industrial Park, Mianyang, Sichuan, P.R.C

2.4 General Description for Equipment under Test (EUT)

EUT Name	WIFI module
Model Name Under Test	AL-7605B-WG-A
Series Model Name	WF-M605-UWD1, WF-M605-UWD2
Description of Model name differentiation	All models are same with electrical parameters and internal circuit structure, but only differ in model name.
Serial Number	2022031200002
Hardware Version	N/A
Software Version	N/A
Dimensions (Approx.)	N/A
Weight (Approx.)	N/A

2.5 Technical Information

Network and Wireless connectivity	2.4G WIFI 802.11b, 802.11g and 802.11n(HT20/40) 5G WIFI 802.11a and 802.11n(HT20/40), U-NII-1/2A/2C/3
-----------------------------------	--

The requirement for the following technical information of the EUT was tested in this report:

Frequency Range	802.11b/g/n(20 MHz): 2.412 GHz - 2.462 GHz $f_c = 2412 \text{ MHz} + (N-1)*5 \text{ MHz}$, where - f_c = "Operating Frequency" in MHz, - N = "Channel Number" with the range from 1 to 11. 802.11n(40 MHz): 2.422 GHz - 2.452 GHz $f_c = 2412 \text{ MHz} + (N-1)*5 \text{ MHz}$, where - f_c = "Operating Frequency" in MHz, - N = "Channel Number" with the range from 3 to 9.	
Modulation Type	DSSS, OFDM	
Product Type	<input checked="" type="checkbox"/> Mobile <input type="checkbox"/> Portable <input type="checkbox"/> Fix Location	
Antenna System (eg., MIMO, Smart Antenna)	Cyclic Delay Diversity (CDD) for 802.11b/g Multi Input Multi Output (MIMO) for 802.11n	
Categorization as Correlated or Completely Uncorrelated	Categorization as Correlated for 802.11b/g Categorization as Uncorrelated for 802.11n	
Antenna Type	Antenna 0 Antenna 1	PIFA Antenna
Antenna Gain	Model: TX-DM85BD113B6 3M	2.58 dBi (In test items related to antenna gain, the final results reflect this figure. This value is provided by the applicant.)
	Model: TX-DM735BD113B 63M	-0.12 dBi (In test items related to antenna gain, the final results reflect this figure. This value is provided by the applicant.)
Total directional gain	For power spectral density(PSD) measurements	Correlated: 2.58 dBi Formulas: Directional gain may be calculated by using the formulas applicable to equal gain antennas with GANT set equal to the gain of the antenna having the highest gain. Uncorrelated: 2.58 dBi Formulas: Directional gain = $10 \log(NANT/NSS) \text{ dB}$. NSS =1, GANT set equal to the gain of the antenna having the highest gain.
	For power measurements	Correlated: 2.58 dBi Formulas: Directional gain may be calculated by using the formulas applicable to equal gain antennas with GANT set equal

		to the gain of the antenna having the highest gain. Uncorrelated: 2.58dBi Formulas: Directional gain = $10 \log(NANT/NSS)$ dB. NSS =1, GANT set equal to the gain of the antenna having the highest gain.
	For Conducted Out-of-Band and Spurious Measurements	Correlated: 2.58 dBi Formulas: Directional gain may be calculated by using the formulas applicable to equal gain antennas with GANT set equal to the gain of the antenna having the highest gain. Uncorrelated: 2.58 dBi Formulas: Directional gain = $10 \log(NANT/NSS)$ dB. NSS =1, GANT set equal to the gain of the antenna having the highest gain.
About the Product		Only the WIFI 802.11b, 802.11g and 802.11n (HT20/40) was tested in this report.

Antenna Information:

Antenna Manufacturer	Model	Antenna Type	Antenna Gain
B&T	TX-DM85BD113B63M	PIFA	2.58 dBi
	TX-DM735BD113B63M	PIFA	-0.12 dBi

Note: After technology evaluation, the max gain antenna was choose as external antenna for all test.

Mode	Antenna	
	Antenna 0	Antenna 1
802.11b	√	√
802.11g	√	√
802.11n20	√	√
802.11n40	√	√

Note: All the configurations were tested, but only the worst data was shown in this report.

Modulation technology	Modulation Type	Transfer Rate (Mbps)(Single RF path)
DSSS (802.11b)	DBPSK	1
	DQPSK	2
	CCK	5.5/11
OFDM (802.11g)	BPSK	6/9
	QPSK	12/18
	16QAM	24/36
	64QAM	48/54
OFDM (802.11n-20 MHz)	BPSK	6.5/7.2
	QPSK	13/19.5/14.4/21.7
	16QAM	26/39/28.9/43.3
	64QAM	52/58.5/65/57.8/65/72.2
OFDM (802.11n-40 MHz)	BPSK	13.5/15
	QPSK	27/40.5/30/45
	16QAM	54/81/60/90
	64QAM	108/121.5/135/120/150

Note: Preliminary tests were performed in different data rate in above table to find the worst radiated emission. The data rate shown in the table below is the worst-case rate with respect to the specific test item. Investigation has been done on all the possible configurations for searching the worst cases. The following table is a list of the test modes shown in this test report.

Test Items	Mode	Data Rate	Channel	
Output Power	11b/11g/11n20/11n40	1/6/6.5/13.5 Mbps	1/6/11	3/6/9
6dB Bandwidth	11b/11g/11n20/11n40	1/6/6.5/13.5 Mbps	1/6/11	3/6/9
Conducted Spurious Emission	11b/11g/11n20/11n40	1/6/6.5/13.5 Mbps	1/6/11	3/6/9
Conducted Emission	11b/11g/11n20/11n40	1/6/6.5/13.5 Mbps	1/6/11	3/6/9
Radiated Spurious Emission	11b/11g/11n20/11n40	1/6/6.5/13.5 Mbps	1/6/11	3/6/9
Band Edge	11b/11g/11n20/11n40	1/6/6.5/13.5 Mbps	1/6/11	3/6/9
Power spectral density (PSD)	11b/11g/11n20/11n40	1/6/6.5/13.5 Mbps	1/6/11	3/6/9

Note: The above EUT information in section 2.4 and 2.6 was declared by manufacturer and for more detailed features description, please refer to the manufacturer's specifications or user's manual.

2.6 Additional Instructions

EUT Software Settings:

Mode	<input checked="" type="checkbox"/> Special software is used. The software provided by client to enable the EUT under transmission condition continuously at specific channel frequencies individually.
------	--

During testing, Channel and Power Controlling Software provided by the customer was used to control the operating channel as well as the output power level. The RF output power selection is for the setting of RF output power expected by the customer and is going to be fixed on the firmware of the final end product.

Power level setup in software			
Test Software Version	MT7663 QA 0.0.2.6		
Support Units (Software installation media)	Description	Manufacturer	Model
	Notebook	Lenovo	X220
Mode	Channel	Soft Set	
802.11 b	1	26.00	
	6	26.00	
	11	23.00	
802.11 g	1	21.00	
	6	27.00	
	10	21.00	
	11	1E	
802.11 n20	1	21.00	
	6	25.00	
	11	1E	
802.11 n40	3	1C	
	6	20.00	
	7	1C	
	8	1B	
	9	1A	

Run software:

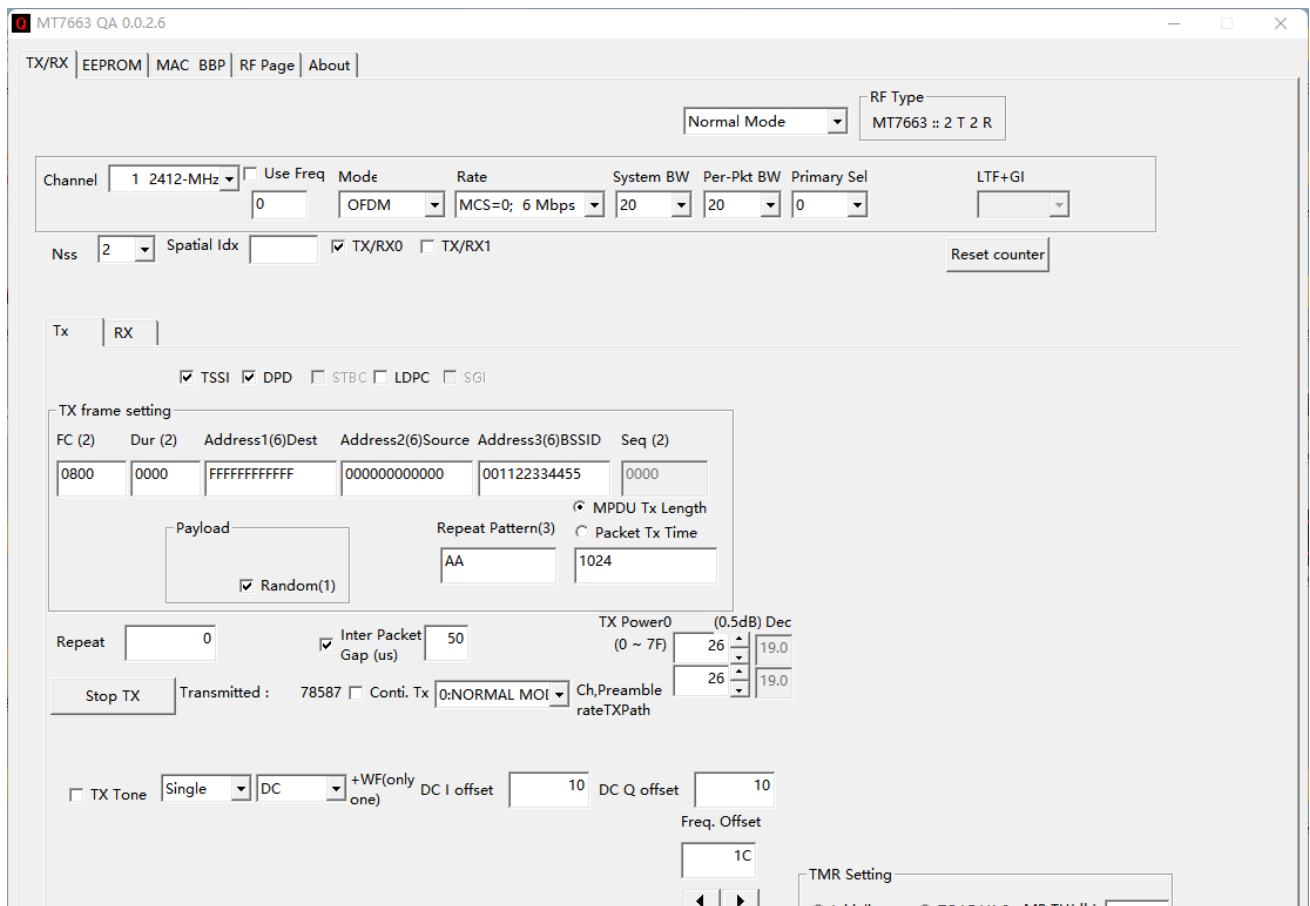

3 SUMMARY OF TEST RESULTS

3.1 Test Standards

No.	Identity	Document Title
1	47 CFR Part 15, Subpart C	Miscellaneous Wireless Communications Services
2	RSS-Gen Issue 5	General Requirements for Compliance of Radio Apparatus
3	RSS-247 Issue 2	Digital Transmission Systems (DTSs), Frequency Hopping Systems(FHSs) and Licence-Exempt Local Area Network (LE-LAN) Devices
4	KDB Publication 662911 D01v02r01	Emissions Testing of Transmitters with Multiple Outputs in the Same Band (e.g., MIMO, Smart Antenna, etc)
5	ANSI C63.10-2013	American National Standard of Procedures for Compliance Testing of Unlicensed Wireless Devices
6	KDB Publication 558074 D01v05r02	GUIDANCE FOR COMPLIANCE MEASUREMENTS ON DIGITAL TRANSMISSION SYSTEM, FREQUENCY HOPPING SPREAD SPECTRUM SYSTEM, AND HYBRID SYSTEM DEVICES OPERATING UNDER SECTION 15.247 OF THE FCC RULES

3.2 Test Verdict

No.	Description	FCC PART No.	ISED Part No.	Test Result	Verdict
1	Antenna Requirement	15.203	RSS-247, 5.4 (f)	N/A	Pass ^{Note 1}
2	Output Power	15.247 (b)	RSS-247, 5.4 (d)	ANNEX A.1	Pass ^{Note 3}
3	6dB Bandwidth	15.247 (a)	RSS-GEN, 6.7; RSS-247, 5.2 (a)	ANNEX A.2	Pass ^{Note 3}
4	Conducted Spurious Emission	15.247 (d)	RSS-247, 5.5	ANNEX A.3	Pass ^{Note 3}
5	Band Edge(Authorized-band band-edge)	15.247 (d)	RSS-GEN, 8.9; RSS-247, 5.5	ANNEX A.4	Pass ^{Note 3}
6	Conducted Emission	15.207	RSS-GEN, 8.8	ANNEX A.5	Pass ^{Note 3}
7	Radiated Spurious Emission	15.209; 15.247 (d)	RSS-247, 5.5	ANNEX A.6	Pass
8	Band Edge(Restricted-band band-edge)	15.209; 15.247 (d)	RSS-247, 5.5	ANNEX A.7	Pass
9	Power spectral density (PSD)	15.247 (e)	RSS-247, 5.2 (b)	ANNEX A.8	Pass ^{Note 3}
10	Receiver Spurious Emissions	N/A	RSS-Gen, 7.3	N/A	N/A ^{Note 2}

Note 1: Please refer to section 5.1.

Note 2: Only radio communication receivers operating in stand-alone mode within the band 30-960 MHz, as well as scanner receivers, are subject to Industry Canada requirements, so this test is not applicable.

Note 3: Compared with the EUT of test report 211001862SHA-001, the EUT of this report replacement antennas. Other hardware circuit and software are the same as EUT referred in test report 211001862SHA-001. Therefore, only the 2 test items, which include Radiated Spurious Emission and Band Edge (Restricted-band band-edge) were tested in this report, other test datas please refer to report 211001862SHA-001, which was issued by Intertek Testing Services Shanghai on Jan. 05, 2022.

4 GENERAL TEST CONFIGURATIONS

4.1 Test Environments

During the measurement, the normal environmental conditions were within the listed ranges:

Relative Humidity	45% to 55%	
Atmospheric Pressure	100 kPa to 102 kPa	
Temperature	NT (Normal Temperature)	+22°C to +25°C
Working Voltage of the EUT	NV (Normal Voltage)	3.3 V

4.2 Test Equipment List

Description	Manufacturer	Model	Serial No.	Cal. Date	Cal. Due
Spectrum Analyzer	ROHDE&SCHWARZ	FSV-40	101544	2022.01.04	2023.01.03
Spectrum Analyzer	KEYSIGHT	N9020A	MY50330200	2021.06.01	2022.05.31
Bluetooth Signaling Unit	ROHDE&SCHWARZ	CMW500	142028	2021.06.01	2022.05.31
EMI Receiver	KEYSIGHT	N9038A	MY53220118	2021.09.13	2022.09.12
EMI Receiver	ROHDE&SCHWARZ	ESRP	101036	2021.10.10	2022.10.09
LISN	SCHWARZBECK	NSLK 8127	8127-687	2021.06.08	2022.06.07
Test Antenna-Loop(9 kHz-30 MHz)	SCHWARZBECK	FMZB 1519	1519-037	2021.04.16	2024.04.15
Test Antenna-Bi-Log(30 MHz-3 GHz)	SCHWARZBECK	VULB 9163	9163-624	2021.08.20	2024.08.19
Test Antenna-Horn(1-18 GHz)	SCHWARZBECK	BBHA 9120D	9120D-1917	2019.07.02	2022.07.01
Test Antenna-Horn (18-40 GHz)	A-INFO	LB-180400KF	J211060273	2021.07.02	2024.07.01
Anechoic Chamber	RAINFORD	9m*6m*6m	N/A	2021.09.04	2024.09.09
Anechoic Chamber	EMC Electronic Co., Ltd	20.10*11.60*7.35m	N/A	2021.08.15	2024.08.14
Shielded Enclosure	ChangNing	CN-130701	130703	--	--

4.3 Test Software List

Description	Manufacturer	Software Version	Serial No.	Applicable test Setup
BL410R	BALUN	V2.1.1.488	N/A	The section 4.5.1
BL410E	BALUN	V19.8.28.435	N/A	The section 4.5.2&4.5.3&4.5.4&4.5.5

4.4 Measurement Uncertainty

The following measurement uncertainty levels have been estimated for tests performed on the EUT as specified in CISPR 16-4-2.

This uncertainty represents an expanded uncertainty expressed at approximately the 95% confidence level using a coverage factor of k=2.

Parameters	Uncertainty
Occupied Channel Bandwidth	2.8%
RF output power, conducted	1.28 dB
Power Spectral Density, conducted	1.30 dB
Unwanted Emissions, conducted	1.84 dB
All emissions, radiated	5.36 dB
Temperature	0.82°C
Humidity	4.1%

4.5 Description of Test Setup

4.5.1 For Antenna Port Test

Conducted value (dBm) = Measurement value (dBm) + cable loss (dB)

For example: the measurement value is 10 dBm and the cable 0.5dBm used, then the final result of EUT:
 Conducted value (dBm) = 10 dBm + 0.5 dB = 10.5 dBm

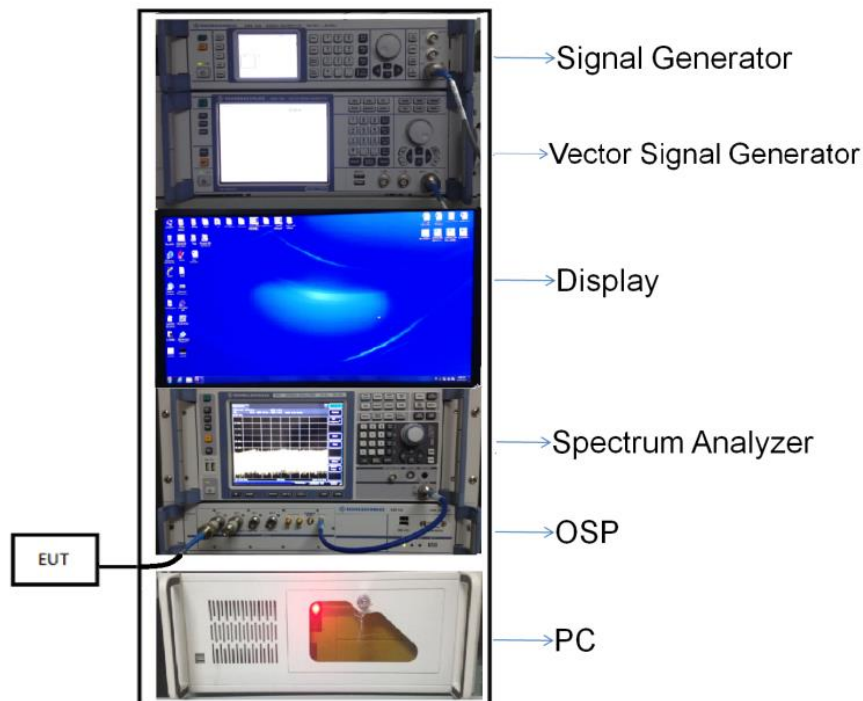

(Diagram 1)

4.5.2 For AC Power Supply Port Test

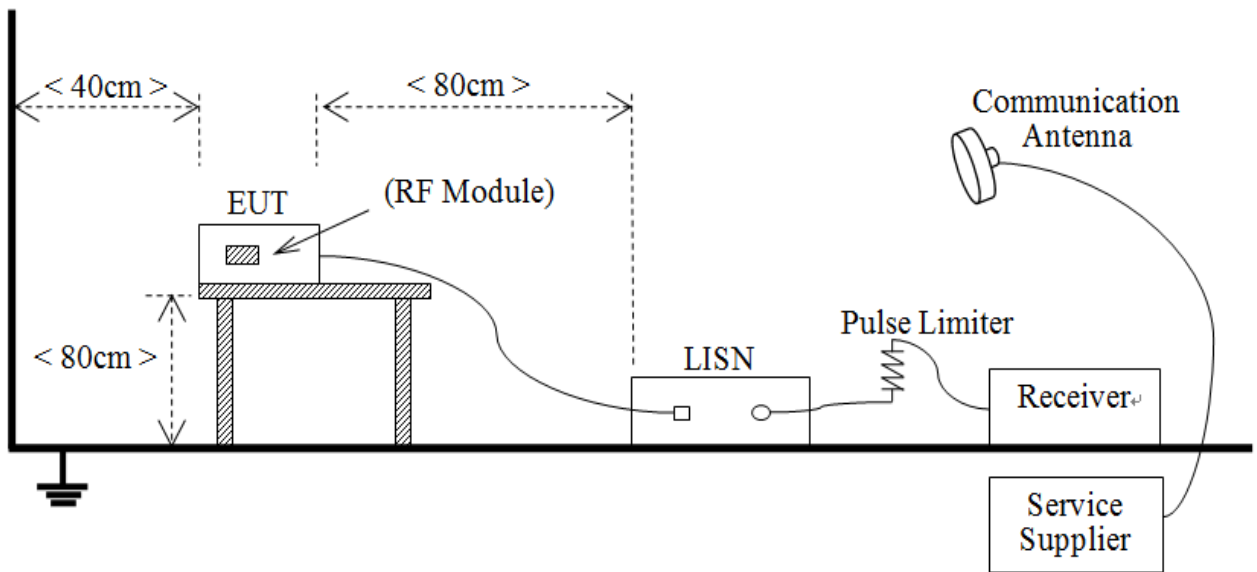

(Diagram 2)

4.5.3 For Radiated Test (Below 30 MHz)

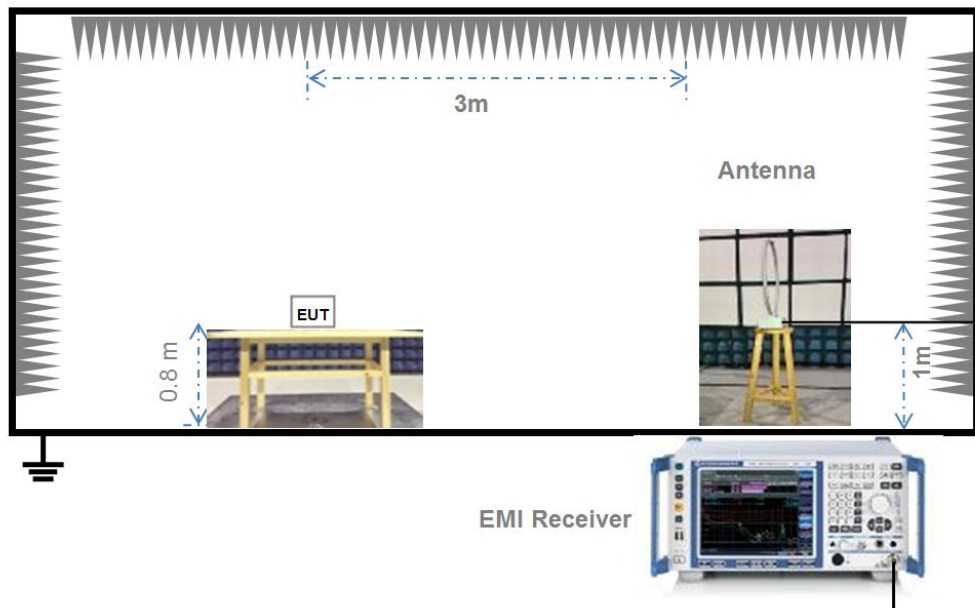

(Diagram 3)

4.5.4 For Radiated Test (30 MHz-1 GHz)

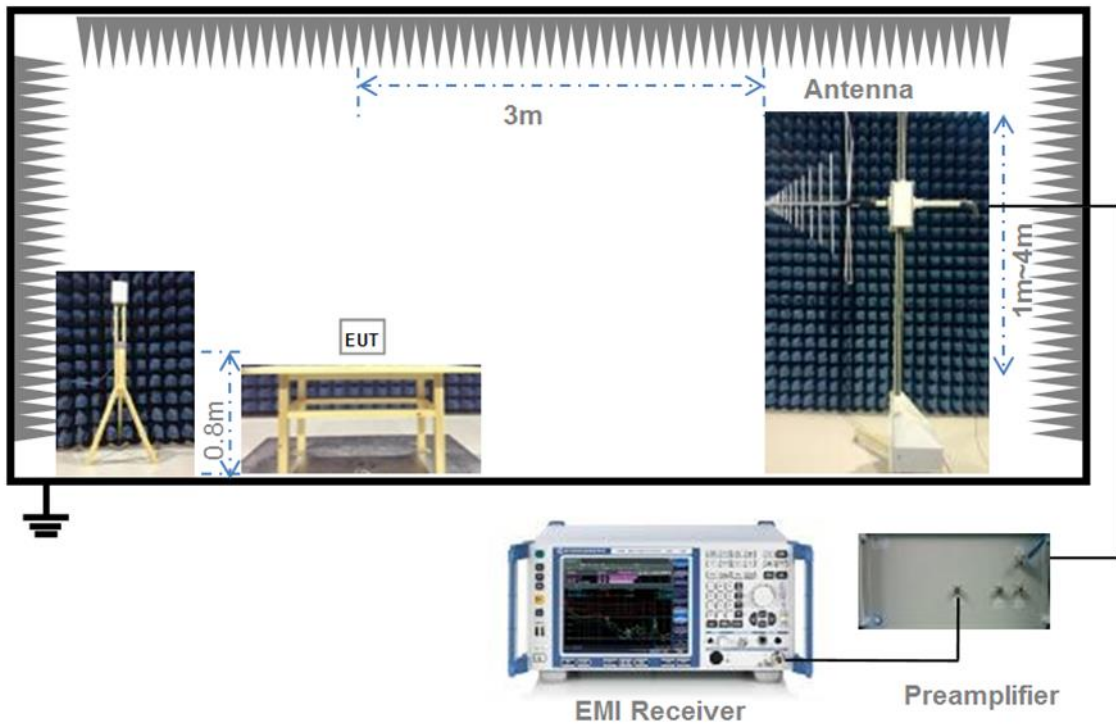

(Diagram 4)

4.5.5 For Radiated Test (Above 1 GHz)

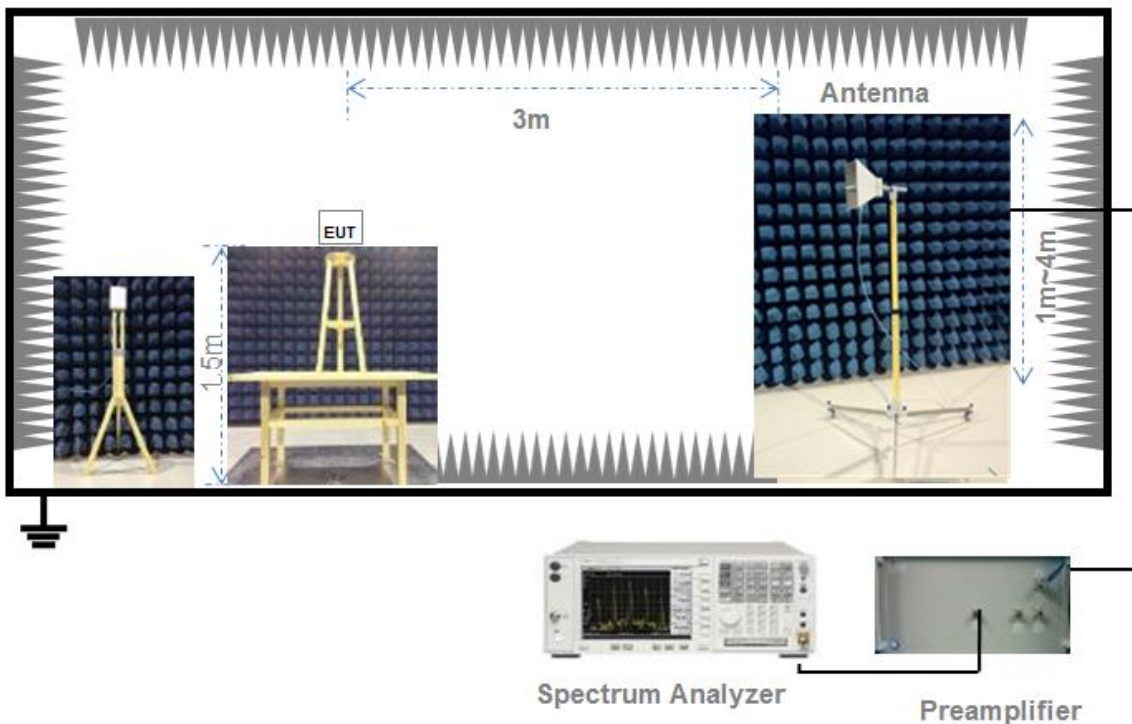

(Diagram 5)

4.6 Measurement Results Explanation Example

4.6.1 For conducted test items:

The offset level is set in the spectrum analyzer to compensate the RF cable loss and attenuator between EUT conducted output port and spectrum analyzer. With the offset compensation, the spectrum analyzer reading level is exactly the EUT RF output level.

The spectrum analyzer offset is derived from RF cable loss and attenuator factor.

Offset = RF cable loss + attenuator factor.

4.6.2 For radiated band edges and spurious emission test:

$$E = \text{EIRP} - 20 \log D + 104.8$$

where:

E = electric field strength in dB μ V/m,

EIRP = equivalent isotropic radiated power in dBm

D = specified measurement distance in meters.

EIRP = Measure Conducted output power Value (dBm) + Maximum transmit antenna gain (dBi) + the appropriate maximum ground reflection factor (dB)

5 TEST ITEMS

5.1 Antenna Requirements

5.1.1 Relevant Standards

FCC §15.203; RSS-247, 5.4 (f)

An intentional radiator shall be designed to ensure that no antenna other than that furnished by the responsible party shall be used with the device. The use of a permanently attached antenna or of an antenna that uses a unique coupling to the intentional radiator shall be considered sufficient to comply with the provisions of this section. The manufacturer may design the unit so that a broken antenna can be replaced by the user, but the use of a standard antenna jack or electrical connector is prohibited. This requirement does not apply to carrier current devices or to devices operated under the provisions of § 15.211, § 15.213, § 15.217, § 15.219, or § 15.221. Further, this requirement does not apply to intentional radiators that must be professionally installed, such as perimeter protection systems and some field disturbance sensors, or to other intentional radiators which, in accordance with § 15.31(d), must be measured at the installation site. However, the installer shall be responsible for ensuring that the proper antenna is employed so that the limits in this part are not exceeded.

If directional gain of transmitting antennas is greater than 6 dBi, the power shall be reduced by the same level in dB comparing to gain minus 6 dBi. For the fixed point-to-point operation, the power shall be reduced by one dB for every 3 dB that the directional gain of the antenna exceeds 6 dBi. The use of a permanently attached antenna or of an antenna that uses a unique coupling to the intentional radiator shall be considered sufficient to comply with the FCC rule.

5.1.2 Antenna Anti-Replacement Construction

The Antenna Anti-Replacement as following method:

Protected Method	Description
The antenna is embedded in the product.	An embedded-in antenna design is used.

Reference Documents	Item
Photo	Please refer to the EUT Photo documents.

5.1.3 Antenna Gain

The antenna peak gain of EUT is less than 6 dBi. Therefore, it is not necessary to reduce maximum peak output power limit.

5.2 Output Power

5.2.1 Test Limit

FCC § 15.247(b); RSS-247, 5.4 (d)

For systems using digital modulation in the 902-928 MHz, 2400-2483.5 MHz, and 5725-5850 MHz bands: 1 Watt. As an alternative to a peak power measurement, compliance with the one Watt limit can be based on a measurement of the maximum conducted output power. Maximum Conducted Output Power is defined as the total transmit power delivered to all antennas and antenna elements averaged across all symbols in the signaling alphabet when the transmitter is operating at its maximum power control level. Power must be summed across all antennas and antenna elements.

5.2.2 Test Setup

See section 4.5.1 for test setup description for the antenna port. The photo of test setup please refer to ANNEX B.

5.2.3 Test Procedure

Maximum peak conducted output power

The maximum peak conducted output power may be measured using a broadband peak RF power meter. The power meter shall have a video bandwidth that is greater than or equal to the DTS bandwidth and shall utilize a fast-responding diode detector.

Maximum conducted (average) output power (Reporting Only)

a) As an alternative to spectrum analyzer or EMI receiver measurements, measurements may be performed

using a wideband RF power meter with a thermocouple detector or equivalent if all of the conditions listed below are satisfied.

- 1) The EUT is configured to transmit continuously, or to transmit with a constant duty factor.
- 2) At all times when the EUT is transmitting, it shall be transmitting at its maximum power control level.
- 3) The integration period of the power meter exceeds the repetition period of the transmitted signal by at least a factor of five.

b) If the transmitter does not transmit continuously, measure the duty cycle (x) of the transmitter output signal as

described in Section 6.0.

c) Measure the average power of the transmitter. This measurement is an average over both the on and off periods of the transmitter.

d) Adjust the measurement in dBm by adding $10\log(1/x)$, where x is the duty cycle to the measurement result.

Measurements of duty cycle

The zero-span mode on a spectrum analyzer or EMI receiver if the response time and spacing between bins on the sweep are sufficient to permit accurate measurements of the on and off times of the transmitted signal.

Set the center frequency of the instrument to the center frequency of the transmission.

Set $RBW \geq OBW$ if possible; otherwise, set RBW to the largest available value.

Set $VBW \geq RBW$. Set detector = peak or average.

The zero-span measurement method shall not be used unless both RBW and VBW are $> 50/T$ and the number of sweep points across duration T exceeds 100. (For example, if VBW and/or RBW are limited to 3 MHz, then the zero-span method of measuring duty cycle shall not be used if $T \leq 16.7$ microseconds.)

5.2.4 Test Result

Please refer to ANNEX A.1.

5.3 6dB Bandwidth

5.3.1 Limit

FCC §15.247(a); RSS-GEN, 6.7; RSS-247, 5.2 (a)

Make the measurement with the spectrum analyzer's resolution bandwidth (RBW) = 100 kHz. In order to make an accurate measurement, set the span greater than RBW. The 6 dB bandwidth must be greater than 500 kHz.

5.3.2 Test Setup

See section 4.5.1 for test setup description for the antenna port. The photo of test setup please refer to ANNEX B.

5.3.3 Test Procedure

Use the following spectrum analyzer settings:

Set RBW = 100 kHz.

Set the video bandwidth (VBW) \geq 3 RBW.

Detector = Peak.

Trace mode = max hold.

Sweep = auto couple.

Allow the trace to stabilize.

Measure the maximum width of the emission that is constrained by the frequencies associated with the two outermost amplitude points (upper and lower frequencies) that are attenuated by 6 dB relative to the maximum level measured in the fundamental emission.

5.3.4 Test Result

Please refer to ANNEX A.2.

5.4 Conducted Spurious Emission

5.4.1 Limit

FCC §15.247(d); RSS-247, 5.5

In any 100 kHz bandwidth outside the frequency band in which the spread spectrum or digitally modulated intentional radiator is operating, the radio frequency power that is produced by the intentional radiator shall be at least 20 dB below that in the 100 kHz bandwidth within the band that contains the highest level of the desired power, based on either an RF conducted or a radiated measurement.

5.4.2 Test Setup

See section 4.5.1 for test setup description for the antenna port. The photo of test setup please refer to ANNEX B.

5.4.3 Test Procedure

The DTS rules specify that in any 100 kHz bandwidth outside of the authorized frequency band, the power shall be attenuated according to the following conditions:

- a) If the maximum peak conducted output power procedure was used to demonstrate compliance as described in 9.1, then the peak output power measured in any 100 kHz bandwidth outside of the authorized frequency band shall be attenuated by at least 20 dB relative to the maximum in-band peak PSD level in 100 kHz (i.e., 20 dBc).
- b) If maximum conducted (average) output power was used to demonstrate compliance as described in 9.2, then the peak power in any 100 kHz bandwidth outside of the authorized frequency band shall be attenuated by at least 30 dB relative to the maximum in-band peak PSD level in 100 kHz (i.e., 30 dBc).
- c) In either case, attenuation to levels below the 15.209 general radiated emissions limits is not required.

The following procedures shall be used to demonstrate compliance to these limits. Note that these procedures can be used in either an antenna-port conducted or radiated test set-up. Radiated tests must conform to the test site requirements and utilize maximization procedures defined herein.

Reference level measurement

Establish a reference level by using the following procedure:

Set instrument center frequency to DTS channel center frequency.

Set the span to ≥ 1.5 times the DTS bandwidth.

Set the RBW = 100 kHz.

Set the VBW $\geq 3 \times$ RBW.

Detector = peak.

Sweep time = auto couple.

Trace mode = max hold.

Allow trace to fully stabilize.

Use the peak marker function to determine the maximum PSD level.

Emission level measurement

Use the following spectrum analyzer settings:

Span = wide enough to capture the peak level of the in-band emission and all spurious emissions (e.g., harmonics) from the lowest frequency generated in the EUT up through the 10th harmonic. Typically, several plots are required to cover this entire span.

Set the RBW = 100 kHz.

Set the VBW $\geq 3 \times$ RBW.

Detector = peak.

Sweep time = auto couple.

Trace mode = max hold.

Allow trace to fully stabilize.

Use the peak marker function to determine the maximum amplitude level.

Ensure that the amplitude of all unwanted emissions outside of the authorized frequency band (excluding restricted frequency bands) are attenuated by at least the minimum requirements specified in 11.1 a) or 11.1 b). Report the three highest emissions relative to the limit.

5.4.4 Test Result

Please refer to ANNEX A.3.

5.5 Band Edge (Authorized-band band-edge)

5.5.1 Limit

FCC §15.247(d); RSS-GEN, 8.9, RSS-247, 5.5

In any 100 kHz bandwidth outside the frequency band in which the spread spectrum or digitally modulated intentional radiator is operating, the radio frequency power that is produced by the intentional radiator shall be at least 20 dB below that in the 100 kHz bandwidth within the band that contains the highest level of the desired power, based on either an RF conducted or a radiated measurement.

5.5.2 Test Setup

See section 4.5.1 for test setup description for the antenna port. The photo of test setup please refer to ANNEX B.

5.5.3 Test Procedure

The following procedures may be used to determine the peak or average field strength or power of an unwanted emission that is within 2 MHz of the authorized band edge. If a peak detector is utilized, use the procedure described in 13.2.1. Use the procedure described in 13.2.2 when using an average detector and the EUT can be configured to transmit continuously (i.e., duty cycle $\geq 98\%$). Use the procedure described in 13.2.3 when using an average detector and the EUT cannot be configured to transmit continuously but the duty cycle is constant (i.e., duty cycle variations are less than ± 2 percent). Use the procedure described in 13.2.4 when using an average detector for those cases where the EUT cannot be configured to transmit continuously and the duty cycle is not constant (duty cycle variations equal or exceed 2 percent).

When using a peak detector to measure unwanted emissions at or near the band edge (within 2 MHz of the authorized band), the following integration procedure can be used.

Set instrument center frequency to the frequency of the emission to be measured (must be within 2 MHz of the authorized band edge).

Set span to 2 MHz

RBW = 100 kHz.

VBW $\geq 3 \times$ RBW.

Detector = peak.

Sweep time = auto.

Trace mode = max hold.

Allow sweep to continue until the trace stabilizes (required measurement time may increase for low duty cycle applications)

Compute the power by integrating the spectrum over 1 MHz using the analyzer's band power measurement function with band limits set equal to the emission frequency (femission) ± 0.5 MHz. If the instrument does not have a band power function, then sum the amplitude levels (in power units) at 100 kHz intervals extending across the 1 MHz spectrum defined by femission ± 0.5 MHz.

Standard method(The 99% OBW of the fundamental emission is without 2 MHz of the authorized band):

Span: Wide enough to capture the peak level of the emission operating on the channel closest to the band edge, as well as any modulation products that fall outside of the authorized band of operation.

Reference level: As required to keep the signal from exceeding the maximum instrument input mixer level for linear operation. In general, the peak of the spectral envelope shall be more than $[10 \log(\text{OBW/RBW})]$ below the reference level. Specific guidance is given in 4.1.5.2.

Attenuation: Auto (at least 10 dB preferred).

Sweep time: Coupled.

Resolution bandwidth: 100 kHz.

Video bandwidth: 300 kHz.

Detector: Peak.

Trace: Max hold.

5.5.4 Test Result

Please refer to ANNEX A.4.

5.6 Conducted Emission

5.6.1 Limit

FCC §15.207; RSS-GEN, 8.8

For an intentional radiator that is designed to be connected to the public utility (AC) power line, the radio frequency voltage that is conducted back onto the AC power line on any frequency within the band 150 kHz to 30 MHz shall not exceed the limits in the following table, as measured using a 50 μ H/50 Ω line impedance stabilization network (LISN).

Frequency range (MHz)	Conducted Limit (dB μ V)	
	Quai-peak	Average
0.15 - 0.50	66 to 56	56 to 46
0.50 - 5	56	46
0.50 - 30	60	50

5.6.2 Test Setup

See section 4.5.2 for test setup description for the AC power supply port. The photo of test setup please refer to ANNEX B.

5.6.3 Test Procedure

The maximum conducted interference is searched using Peak (PK), if the emission levels more than the AV and QP limits, and that have narrow margins from the AV and QP limits will be re-measured with AV and QP detectors. Tests for both L phase and N phase lines of the power mains connected to the EUT are performed. Refer to recorded points and plots below.

Devices subject to Part 15 must be tested for all available U.S. voltages and frequencies (such as a nominal 120 VAC, 50/60 Hz and 240 VAC, 50/60 Hz) for which the device is capable of operation. A device rated for 50/60 Hz operation need not be tested at both frequencies provided the radiated and line conducted emissions are the same at both frequencies.

5.6.4 Test Result

Please refer to ANNEX A.5.

5.7 Radiated Spurious Emission

5.7.1 Limit

FCC §15.209&15.247(d); RSS-247, 5.5

Radiated emission outside the frequency band attenuation below the general limits specified in FCC section 15.209(a) is not required. In addition, radiated emissions which fall in the restricted bands, as defined in FCC section 15.205(a), must also comply with the radiated emission limits specified in FCC section 15.209(a).

According to FCC section 15.209 (a), except as provided elsewhere in this subpart, the emissions from an intentional radiator shall not exceed the field strength levels specified in the following table:

Frequency (MHz)	Field Strength ($\mu\text{V}/\text{m}$)	Measurement Distance (m)
0.009 - 0.490	2400/F(kHz)	300
0.490 - 1.705	24000/F(kHz)	30
1.705 - 30.0	30	30
30 - 88	100	3
88 - 216	150	3
216 - 960	200	3
Above 960	500	3

Note:

- For Above 1000 MHz, the emission limit in this paragraph is based on measurement instrumentation employing an average detector, measurement using instrumentation with a peak detector function, corresponding to 20dB above the maximum permitted average limit.
- For above 1000 MHz, limit field strength of harmonics: 54dBuV/m@3m (AV) and 74dBuV/m@3m (PK).

5.7.2 Test Setup

See section 4.5.3 to 4.5.5 for test setup description for the antenna port. The photo of test setup please refer to ANNEX B.

5.7.3 Test Procedure

Since the emission limits are specified in terms of radiated field strength levels, measurements performed to demonstrate compliance have traditionally relied on a radiated test configuration. Radiated measurements remain the principal method for demonstrating compliance to the specified limits; however antenna-port conducted measurements are also now acceptable to demonstrate compliance (see below for details). When radiated measurements are utilized, test site requirements and procedures for maximizing and measuring radiated emissions that are described in ANSI C63.10 shall be followed.

Antenna-port conducted measurements may also be used as an alternative to radiated measurements for demonstrating compliance in the restricted frequency bands. If conducted measurements are performed, then proper impedance matching must be ensured and an additional radiated test for cabinet/case spurious emissions is required.

General Procedure for conducted measurements in restricted bands

- a) Measure the conducted output power (in dBm) using the detector specified (see guidance regarding measurement procedures for determining quasi-peak, peak, and average conducted output power, respectively).
- b) Add the maximum transmit antenna gain (in dBi) to the measured output power level to determine the EIRP level (see guidance on determining the applicable antenna gain)
- c) Add the appropriate maximum ground reflection factor to the EIRP level (6 dB for frequencies ≤ 30 MHz, 4.7 dB for frequencies between 30 MHz and 1000 MHz, inclusive and 0 dB for frequencies > 1000 MHz).
- d) For devices with multiple antenna-ports, measure the power of each individual chain and sum the EIRP of all chains in linear terms (e.g., Watts, mW).
- e) Convert the resultant EIRP level to an equivalent electric field strength using the following relationship:

$$E = \text{EIRP} - 20\log D + 104.8$$

where:

E = electric field strength in dB μ V/m,

EIRP = equivalent isotropic radiated power in dBm

D = specified measurement distance in meters.

- f) Compare the resultant electric field strength level to the applicable limit.
- g) Perform radiated spurious emission test.

Quasi-Peak measurement procedure

The specifications for measurements using the CISPR quasi-peak detector can be found in Publication 16 of the International Special Committee on Radio Frequency Interference (CISPR) of the International Electrotechnical Commission.

As an alternative to CISPR quasi-peak measurement, compliance can be demonstrated to the applicable emission limits using a peak detector.

Peak power measurement procedure

Peak emission levels are measured by setting the instrument as follows:

- a) RBW = as specified in Table 1.
- b) VBW $\geq 3 \times$ RBW.
- c) Detector = Peak.
- d) Sweep time = auto.
- e) Trace mode = max hold.
- f) Allow sweeps to continue until the trace stabilizes. (Note that the required measurement time may be

longer for low duty cycle applications).

Table 1—RBW as a function of frequency

Frequency	RBW
9-150 kHz	200-300 Hz
0.15-30 MHz	9-10 kHz
30-1000 MHz	100-120 kHz
> 1000 MHz	1 MHz

If the peak-detected amplitude can be shown to comply with the average limit, then it is not necessary to perform a separate average measurement.

Trace averaging across on and off times of the EUT transmissions followed by duty cycle correction

If continuous transmission of the EUT (i.e., duty cycle ≥ 98 percent) cannot be achieved and the duty cycle is constant (i.e., duty cycle variations are less than ± 2 percent), then the following procedure shall be used:

- a) The EUT shall be configured to operate at the maximum achievable duty cycle.
- b) Measure the duty cycle, x , of the transmitter output signal as described in section 6.0.
- c) RBW = 1 MHz (unless otherwise specified).
- d) VBW $\geq 3 \times$ RBW.
- e) Detector = RMS, if $\text{span}/(\# \text{ of points in sweep}) \leq (\text{RBW}/2)$. Satisfying this condition may require increasing the number of points in the sweep or reducing the span. If this condition cannot be satisfied, then the detector mode shall be set to peak.
- f) Averaging type = power (i.e., RMS).
 - 1) As an alternative, the detector and averaging type may be set for linear voltage averaging.
 - 2) Some instruments require linear display mode in order to use linear voltage averaging. Log or dB averaging shall not be used.
- g) Sweep time = auto.
- h) Perform a trace average of at least 100 traces.
- i) A correction factor shall be added to the measurement results prior to comparing to the emission limit in order to compute the emission level that would have been measured had the test been performed at 100 percent duty cycle. The correction factor is computed as follows:
 - 1) If power averaging (RMS) mode was used in step f), then the applicable correction factor is $10 \log(1/x)$, where x is the duty cycle.
 - 2) If linear voltage averaging mode was used in step f), then the applicable correction factor is $20 \log(1/x)$, where x is the duty cycle.
 - 3) If a specific emission is demonstrated to be continuous (≥ 98 percent duty cycle) rather than turning on and off with the transmit cycle, then no duty cycle correction is required for that emission.

NOTE: Reduction of the measured emission amplitude levels to account for operational duty factor is not permitted. Compliance is based on emission levels occurring during transmission - not on an average across on and off times of the transmitter.

Determining the applicable transmit antenna gain

A conducted power measurement will determine the maximum output power associated with a restricted band emission; however, in order to determine the associated EIRP level, the gain of the transmitting antenna (in dBi) must be added to the measured output power (in dBm).

Since the out-of-band characteristics of the EUT transmit antenna will often be unknown, the use of a conservative antenna gain value is necessary. Thus, when determining the EIRP based on the measured conducted power, the upper bound on antenna gain for a device with a single RF output shall be selected as the maximum in-band gain of the antenna across all operating bands, or 2 dBi, whichever is greater. However, for devices that operate in multiple frequency bands while using the same transmit antenna, the highest gain of the antenna within the operating band nearest in frequency to the restricted band emission being measured may be used in lieu of the overall highest gain when the emission is at a frequency that is within 20 percent of the nearest band edge frequency, but in no case shall a value less than 2 dBi be used.

See KDB 662911 for guidance on calculating the additional array gain term when determining the effective antenna gain for a EUT with multiple outputs occupying the same or overlapping frequency ranges in the same band.

Radiated spurious emission test

An additional consideration when performing conducted measurements of restricted band emissions is that unwanted emissions radiating from the EUT cabinet, control circuits, power leads, or intermediate circuit elements will likely go undetected in a conducted measurement configuration. To address this concern, a radiated test shall be performed to ensure that emissions emanating from the EUT cabinet (rather than the antenna port) also comply with the applicable limits.

For these cabinet radiated spurious emission measurements the EUT transmit antenna may be replaced with a termination matching the nominal impedance of the antenna. Procedures for performing radiated measurements are specified in ANSI C63.10. All detected emissions shall comply with the applicable limits.

The measurement frequency range is from 30 MHz to the 10th harmonic of the fundamental frequency. The Turn Table is actuated to turn from 0° to 360°, and both horizontal and vertical polarizations of the Test Antenna are used to find the maximum radiated power. Mid channels on all channel bandwidth verified. Only the worst RB size/offset presented.

The power of the EUT transmitting frequency should be ignored.

All Spurious Emission tests were performed in X, Y, Z axis direction. And only the worst axis test condition was recorded in this test report.

Use the following spectrum analyzer settings:

Span = wide enough to fully capture the emission being measured

RBW = 1 MHz for $f \geq 1$ GHz, 100 kHz for $f < 1$ GHz

VBW \geq RBW

Sweep = auto

Detector function = peak

Trace = max hold

5.7.4 Test Result

Please refer to ANNEX A.6.

5.8 Band Edge (Restricted-band band-edge)

5.8.1 Limit

FCC §15.209&15.247(d); RSS-247, 5.5

Radiated emission outside the frequency band attenuation below the general limits specified in FCC section 15.209(a) is not required. In addition, radiated emissions which fall in the restricted bands, as defined in FCC section 15.205(a), must also comply with the radiated emission limits specified in FCC section 15.209(a).

5.8.2 Test Setup

See section 4.5.1 for test setup description for the antenna port. The photo of test setup please refer to ANNEX B.

5.8.3 Test Procedure

The measurement frequency range is from 9 kHz to the 10th harmonic of the fundamental frequency. The Turn Table is actuated to turn from 0° to 360°, and both horizontal and vertical polarizations of the Test Antenna are used to find the maximum radiated power. Mid channels on all channel bandwidth verified. Only the worst RB size/offset presented.

The power of the EUT transmitting frequency should be ignored.

All Spurious Emission tests were performed in X, Y, Z axis direction. And only the worst axis test condition was recorded in this test report.

Use the following spectrum analyzer settings:

Span = wide enough to fully capture the emission being measured

RBW = 1 MHz for $f \geq 1$ GHz, 100 kHz for $f < 1$ GHz

VBW \geq RBW

Sweep = auto

Detector function = peak

Trace = max hold

For measurement below 1GHz, If the emission level of the EUT measured by the peak detector is 3 dB lower than the applicable limit, the peak emission level will be reported, Otherwise, the emission measurement will be repeated using the quasi-peak detector and reported.

For transmitters operating above 1 GHz repeat the measurement with an average detector.

5.8.4 Test Result

Please refer to ANNEX A.7.

5.9 Power Spectral density (PSD)

5.9.1 Limit

FCC §15.247(e); RSS-247, 5.2 (b)

The same method of determining the conducted output power shall be used to determine the power spectral density. If a peak output power is measured, then a peak power spectral density measurement is required. If an average output power is measured, then an average power spectral density measurement should be used.

5.9.2 Test Setup

See section 4.5.1 for test setup description for the antenna port. The photo of test setup please refer to ANNEX B.

5.9.3 Test Procedure

Set analyzer center frequency to DTS channel center frequency.

Set the span to 1.5 times the DTS bandwidth.

Set the RBW to: $3 \text{ kHz} \leq \text{RBW} \leq 100 \text{ kHz}$.

Set the VBW $\geq 3 \text{ RBW}$.

Detector = peak.

Sweep time = auto couple.

Trace mode = max hold.

Allow trace to fully stabilize.

Use the peak marker function to determine the maximum amplitude level within the RBW.

If measured value exceeds limit, reduce RBW (no less than 3 kHz) and repeat.

5.9.4 Test Result

Please refer to ANNEX A.8.

ANNEX A TEST RESULT

A.1 Output Power

The Output Power please refer to report 211001862SHA-001, which was issued by Intertek Testing Services Shanghai on Jan. 05, 2022, **section 4.4 Test Results of Maximum conducted output power.**

A.2 Bandwidth

The Bandwidth please refer to report 211001862SHA-001, which was issued by Intertek Testing Services Shanghai on Jan. 05, 2022, **section 3.4 Test Results of Minimum 6dB bandwidth.**

A.3 Conducted Spurious Emissions

The Conducted Spurious Emissions please refer to report 211001862SHA-001, which was issued by Intertek Testing Services Shanghai on Jan. 05, 2022, **section 6.4 The results of Emission outside the frequency band.**

A.4 Band Edge (Authorized-band band-edge)

The Band Edge (Authorized-band band-edge) please refer to report 211001862SHA-001, which was issued by Intertek Testing Services Shanghai on Jan. 05, 2022, **section 6.4 The results of Emission outside the frequency band.**

A.5 Conducted Emissions

The Conducted Emissions please refer to report 211001862SHA-001, which was issued by Intertek Testing Services Shanghai on Jan. 05, 2022, **section 8.4 Test Results of Power line conducted emission.**

A.6 Radiated Emission

Note ¹: The symbol of "--" in the table which means not application.

Note ²: For the test data above 1 GHz, According the ANSI C63.10-2013, where limits are specified for both average and peak (or quasi-peak) detector functions, if the peak (or quasi-peak) measured value complies with the average limit, it is unnecessary to perform an average measurement.

Note ³: The low frequency, which started from 9 kHz to 30 MHz, was pre-scanned and the result which was 20 dB lower than the limit line per 15.31(o) was not reported.

Note ⁴: The EUT is working in the Normal link mode below 1 GHz. All modes have been tested and normal link mode is worst.

Test Data and Plots

30 MHz to 1 GHz, ANT H

RE Test case_FCC Part 15B_FCC Part 15B Class B 30MHz-1GHz

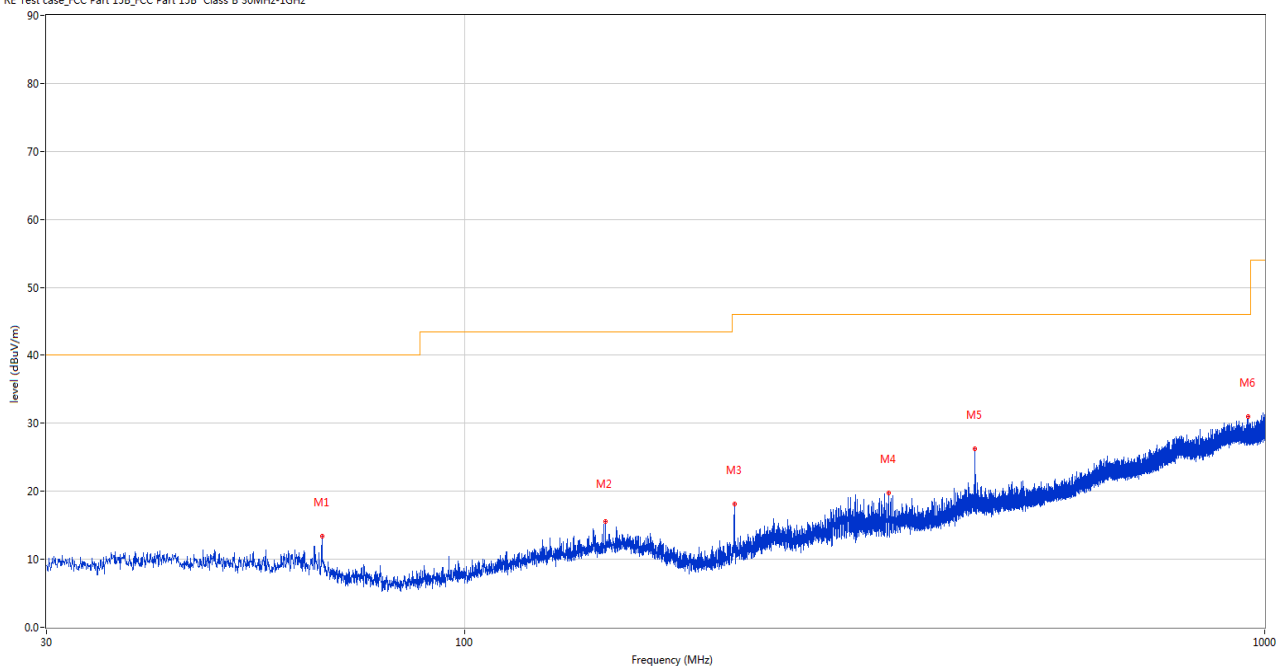

No.	Frequency (MHz)	Results (dBuV/m)	Factor (dB)	Limit (dBuV/m)	Over Limit (dB)	Detector	Table (Degree)	Height (cm)	Antenna	Verdict
1	66.278	13.37	-27.83	40.0	-26.63	Peak	58.00	100	Horizontal	Pass
2	149.941	15.53	-24.28	43.5	-27.97	Peak	0.00	200	Horizontal	Pass
3	217.307	18.11	-27.12	46.0	-27.89	Peak	360.00	100	Horizontal	Pass
4	338.799	19.81	-22.63	46.0	-26.19	Peak	260.00	100	Horizontal	Pass
5	434.587	26.31	-19.87	46.0	-19.69	Peak	260.00	100	Horizontal	Pass
6	953.343	31.00	-8.01	46.0	-15.00	Peak	360.00	200	Horizontal	Pass

30 MHz to 1 GHz, ANT V

RE Test case_FCC Part 15B_FCC Part 15B Class B 30MHz-1GHz

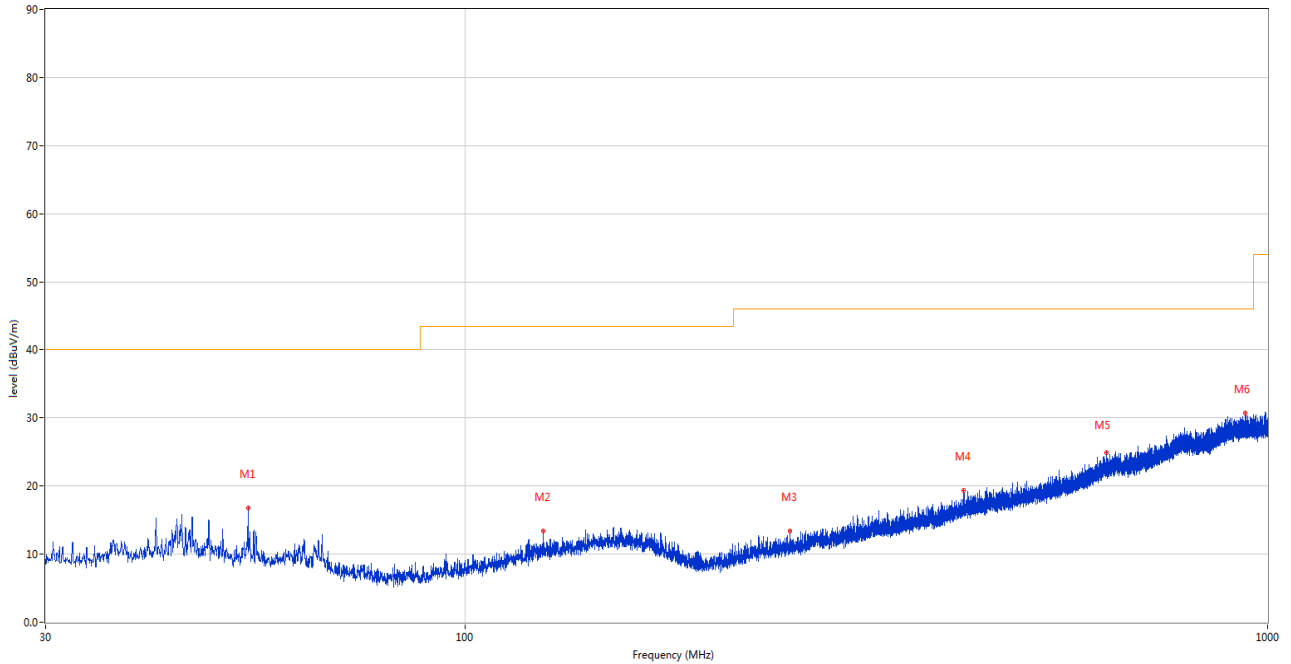

No.	Frequency (MHz)	Results (dBuV/m)	Factor (dB)	Limit (dBuV/m)	Over Limit (dB)	Detector	Table (Degree)	Height (cm)	Antenna	Verdict
1	53.620	16.76	-26.35	40.0	-23.24	Peak	264.00	100	Vertical	Pass
2	125.011	13.37	-26.01	43.5	-30.13	Peak	53.00	100	Vertical	Pass
3	254.070	13.39	-25.50	46.0	-32.61	Peak	16.00	100	Vertical	Pass
4	418.388	19.33	-20.30	46.0	-26.67	Peak	0.00	200	Vertical	Pass
5	629.460	24.84	-13.55	46.0	-21.16	Peak	360.00	100	Vertical	Pass
6	938.260	30.66	-7.90	46.0	-15.34	Peak	3.00	100	Vertical	Pass

Note 1: The marked spikes near 2400 MHz with circle should be ignored because they are Fundamental signal.

Note 2: The spurious above 18G is noise only, do not show on the report.

1 GHz to 18 GHz, ANT H 802.11b Channel 1

No.	Frequency (MHz)	Results (dBuV/m)	Factor (dB)	Limit (dBuV/m)	Over Limit (dB)	Detector	Table (Degree)	Height (cm)	Antenna	Verdict
1	1599.800	42.04	-17.74	74.0	-31.96	Peak	21.00	150	Horizontal	Pass
1**	1599.800	35.61	-17.74	54.0	-18.39	AV	21.00	150	Horizontal	Pass
2	2413.200	101.54	-13.42	74.0	27.54	Peak	140.00	150	Horizontal	N/A
2**	2413.200	98.68	-13.42	54.0	44.68	AV	140.00	150	Horizontal	N/A
3	5173.500	50.29	-2.68	74.0	-23.71	Peak	62.00	150	Horizontal	Pass
3**	5173.500	41.36	-2.68	54.0	-12.64	AV	62.00	150	Horizontal	Pass
4	7859.250	53.26	1.19	74.0	-20.74	Peak	348.00	150	Horizontal	Pass
4**	7859.250	44.23	1.19	54.0	-9.77	AV	348.00	150	Horizontal	Pass
5	9648.250	50.38	-4.62	74.0	-23.62	Peak	51.00	150	Horizontal	Pass
5**	9648.250	44.29	-4.62	54.0	-9.71	AV	51.00	150	Horizontal	Pass
6	16530.525	53.09	0.02	74.0	-20.91	Peak	65.00	150	Horizontal	Pass
6**	16530.525	43.29	0.02	54.0	-10.71	AV	65.00	150	Horizontal	Pass

1 GHz to 18 GHz, ANT V 802.11b Channel 1

No.	Frequency (MHz)	Results (dBuV/m)	Factor (dB)	Limit (dBuV/m)	Over Limit (dB)	Detector	Table (Degree)	Height (cm)	Antenna	Verdict
1	1832.400	44.24	-17.17	74.0	-29.76	Peak	87.00	150	Vertical	Pass
1**	1832.400	35.71	-17.17	54.0	-18.29	AV	87.00	150	Vertical	Pass
2	2413.200	101.11	-13.42	74.0	27.11	Peak	211.00	150	Vertical	N/A
2**	2413.200	98.30	-13.42	54.0	44.30	AV	211.00	150	Vertical	N/A
3	5178.250	50.81	-2.33	74.0	-23.19	Peak	274.00	150	Vertical	Pass
3**	5178.250	41.57	-2.33	54.0	-12.43	AV	274.00	150	Vertical	Pass
4	7837.500	52.56	2.05	74.0	-21.44	Peak	63.00	150	Vertical	Pass
4**	7837.500	43.34	2.05	54.0	-10.66	AV	63.00	150	Vertical	Pass
5	14047.537	50.96	-0.92	74.0	-23.04	Peak	22.00	150	Vertical	Pass
5**	14047.537	40.18	-0.92	54.0	-13.82	AV	22.00	150	Vertical	Pass
6	17797.349	53.55	3.19	74.0	-20.45	Peak	0.00	150	Vertical	Pass
6**	17797.349	43.86	3.19	54.0	-10.14	AV	0.00	150	Vertical	Pass

1 GHz to 18 GHz, ANT H 802.11b Channel 6

No.	Frequency (MHz)	Results (dBuV/m)	Factor (dB)	Limit (dBuV/m)	Over Limit (dB)	Detector	Table (Degree)	Height (cm)	Antenna	Verdict
1	1468.500	41.67	-17.44	74.0	-32.33	Peak	225.00	150	Horizontal	Pass
1**	1468.500	32.15	-17.44	54.0	-21.85	AV	225.00	150	Horizontal	Pass
2	2435.500	102.26	-12.09	74.0	28.26	Peak	68.00	150	Horizontal	N/A
2**	2435.500	99.37	-12.09	54.0	45.37	AV	68.00	150	Horizontal	N/A
3	5261.250	50.37	-3.79	74.0	-23.63	Peak	0.00	150	Horizontal	Pass
3**	5261.250	41.04	-3.79	54.0	-12.96	AV	0.00	150	Horizontal	Pass
4	7865.250	53.28	1.59	74.0	-20.72	Peak	38.00	150	Horizontal	Pass
4**	7865.250	43.80	1.59	54.0	-10.20	AV	38.00	150	Horizontal	Pass
5	14086.125	50.26	-0.22	74.0	-23.74	Peak	22.00	150	Horizontal	Pass
5**	14086.125	41.07	-0.22	54.0	-12.93	AV	22.00	150	Horizontal	Pass
6	16899.338	52.96	1.51	74.0	-21.04	Peak	0.00	150	Horizontal	Pass
6**	16899.338	42.54	1.51	54.0	-11.46	AV	0.00	150	Horizontal	Pass

1 GHz to 18 GHz, ANT V 802.11b Channel 6

No.	Frequency (MHz)	Results (dBuV/m)	Factor (dB)	Limit (dBuV/m)	Over Limit (dB)	Detector	Table (Degree)	Height (cm)	Antenna	Verdict
1	1778.500	42.65	-17.06	74.0	-31.35	Peak	116.00	150	Vertical	Pass
1**	1778.500	32.27	-17.06	54.0	-21.73	AV	116.00	150	Vertical	Pass
2	2436.000	102.40	-12.16	74.0	28.40	Peak	212.00	150	Vertical	N/A
2**	2436.000	99.64	-12.16	54.0	45.64	AV	212.00	150	Vertical	N/A
3	5769.500	51.32	-2.23	74.0	-22.68	Peak	46.00	150	Vertical	Pass
3**	5769.500	41.52	-2.23	54.0	-12.48	AV	46.00	150	Vertical	Pass
4	7840.750	52.75	1.79	74.0	-21.25	Peak	141.00	150	Vertical	Pass
4**	7840.750	43.71	1.79	54.0	-10.29	AV	141.00	150	Vertical	Pass
5	11787.650	48.96	-3.64	74.0	-25.04	Peak	189.00	150	Vertical	Pass
5**	11787.650	40.09	-3.64	54.0	-13.91	AV	189.00	150	Vertical	Pass
6	17547.448	53.79	3.15	74.0	-20.21	Peak	9.00	150	Vertical	Pass
6**	17547.448	43.82	3.15	54.0	-10.18	AV	9.00	150	Vertical	Pass

1 GHz to 18 GHz, ANT H 802.11b Channel 11

No.	Frequency (MHz)	Results (dBuV/m)	Factor (dB)	Limit (dBuV/m)	Over Limit (dB)	Detector	Table (Degree)	Height (cm)	Antenna	Verdict
1	1585.200	41.86	-17.49	74.0	-32.14	Peak	290.00	150	Horizontal	Pass
1**	1585.200	32.25	-17.49	54.0	-21.75	AV	290.00	150	Horizontal	Pass
2	2463.300	102.68	-12.68	74.0	28.68	Peak	67.00	150	Horizontal	N/A
2**	2463.300	99.76	-12.68	54.0	45.76	AV	67.00	150	Horizontal	N/A
3	5349.250	50.90	-3.09	74.0	-23.10	Peak	137.00	150	Horizontal	Pass
3**	5349.250	41.05	-3.09	54.0	-12.95	AV	137.00	150	Horizontal	Pass
4	7833.000	52.92	2.28	74.0	-21.08	Peak	45.00	150	Horizontal	Pass
4**	7833.000	44.39	2.28	54.0	-9.61	AV	45.00	150	Horizontal	Pass
5	13612.838	50.93	-0.03	74.0	-23.07	Peak	78.00	150	Horizontal	Pass
5**	13612.838	41.04	-0.03	54.0	-12.96	AV	78.00	150	Horizontal	Pass
6	16430.512	52.80	0.11	74.0	-21.20	Peak	359.00	150	Horizontal	Pass
6**	16430.512	43.51	0.11	54.0	-10.49	AV	359.00	150	Horizontal	Pass

1 GHz to 18 GHz, ANT V 802.11b Channel 11

No.	Frequency (MHz)	Results (dBuV/m)	Factor (dB)	Limit (dBuV/m)	Over Limit (dB)	Detector	Table (Degree)	Height (cm)	Antenna	Verdict
1	1600.400	42.33	-17.78	74.0	-31.67	Peak	354.00	150	Vertical	Pass
1**	1600.400	36.01	-17.78	54.0	-17.99	AV	354.00	150	Vertical	Pass
2	2463.200	102.99	-12.67	74.0	28.99	Peak	212.00	150	Vertical	N/A
2**	2463.200	100.03	-12.67	54.0	46.03	AV	212.00	150	Vertical	N/A
3	5210.000	49.93	-3.37	74.0	-24.07	Peak	129.00	150	Vertical	Pass
3**	5210.000	40.29	-3.37	54.0	-13.71	AV	129.00	150	Vertical	Pass
4	7819.250	53.18	1.89	74.0	-20.82	Peak	29.00	150	Vertical	Pass
4**	7819.250	44.31	1.89	54.0	-9.69	AV	29.00	150	Vertical	Pass
5	13849.349	51.00	-0.24	74.0	-23.00	Peak	121.00	150	Vertical	Pass
5**	13849.349	41.84	-0.24	54.0	-12.16	AV	121.00	150	Vertical	Pass
6	17874.786	53.47	2.67	74.0	-20.53	Peak	93.00	150	Vertical	Pass
6**	17874.786	43.55	2.67	54.0	-10.45	AV	93.00	150	Vertical	Pass

1 GHz to 18 GHz, ANT H 802.11g Channel 1

No.	Frequency (MHz)	Results (dBuV/m)	Factor (dB)	Limit (dBuV/m)	Over Limit (dB)	Detector	Table (Degree)	Height (cm)	Antenna	Verdict
1	1600.300	42.19	-17.78	74.0	-31.81	Peak	185.00	150	Horizontal	Pass
1**	1600.300	36.04	-17.78	54.0	-17.96	AV	185.00	150	Horizontal	Pass
2	2413.100	100.90	-13.42	74.0	26.90	Peak	70.00	150	Horizontal	N/A
2**	2413.100	93.99	-13.42	54.0	39.99	AV	70.00	150	Horizontal	N/A
3	5350.250	50.69	-3.09	74.0	-23.31	Peak	165.00	150	Horizontal	Pass
3**	5350.250	41.30	-3.09	54.0	-12.70	AV	165.00	150	Horizontal	Pass
4	7871.250	52.85	2.06	74.0	-21.15	Peak	80.00	150	Horizontal	Pass
4**	7871.250	43.71	2.06	54.0	-10.29	AV	80.00	150	Horizontal	Pass
5	11792.162	49.30	-3.60	74.0	-24.70	Peak	258.00	150	Horizontal	Pass
5**	11792.162	39.96	-3.60	54.0	-14.04	AV	258.00	150	Horizontal	Pass
6	16794.599	53.14	0.43	74.0	-20.86	Peak	294.00	150	Horizontal	Pass
6**	16794.599	43.06	0.43	54.0	-10.94	AV	294.00	150	Horizontal	Pass

1 GHz to 18 GHz, ANT V 802.11g Channel 1

No.	Frequency (MHz)	Results (dBuV/m)	Factor (dB)	Limit (dBuV/m)	Over Limit (dB)	Detector	Table (Degree)	Height (cm)	Antenna	Verdict
1	1828.800	43.67	-17.18	74.0	-30.33	Peak	85.00	150	Vertical	Pass
1**	1828.800	32.70	-17.18	54.0	-21.30	AV	85.00	150	Vertical	Pass
2	2413.500	101.77	-13.42	74.0	27.77	Peak	215.00	150	Vertical	N/A
2**	2413.500	94.33	-13.42	54.0	40.33	AV	215.00	150	Vertical	N/A
3	4501.750	48.33	-4.44	74.0	-25.67	Peak	63.00	150	Vertical	Pass
3**	4501.750	39.41	-4.44	54.0	-14.59	AV	63.00	150	Vertical	Pass
4	7523.500	53.02	0.90	74.0	-20.98	Peak	173.00	150	Vertical	Pass
4**	7523.500	43.91	0.90	54.0	-10.09	AV	173.00	150	Vertical	Pass
5	13650.375	50.86	0.30	74.0	-23.14	Peak	42.00	150	Vertical	Pass
5**	13650.375	40.88	0.30	54.0	-13.12	AV	42.00	150	Vertical	Pass
6	17316.712	53.72	1.97	74.0	-20.28	Peak	302.00	150	Vertical	Pass
6**	17316.712	44.08	1.97	54.0	-9.92	AV	302.00	150	Vertical	Pass

1 GHz to 18 GHz, ANT H 802.11g Channel 9

No.	Frequency (MHz)	Results (dBuV/m)	Factor (dB)	Limit (dBuV/m)	Over Limit (dB)	Detector	Table (Degree)	Height (cm)	Antenna	Verdict
1	1600.100	41.91	-17.77	74.0	-32.09	Peak	222.00	150	Horizontal	Pass
1**	1600.100	36.43	-17.77	54.0	-17.57	AV	222.00	150	Horizontal	Pass
2	2434.800	104.43	-12.11	74.0	30.43	Peak	141.00	150	Horizontal	N/A
2**	2434.800	96.78	-12.11	54.0	42.78	AV	141.00	150	Horizontal	N/A
3	5148.750	51.12	-3.59	74.0	-22.88	Peak	200.00	150	Horizontal	Pass
3**	5148.750	40.36	-3.59	54.0	-13.64	AV	200.00	150	Horizontal	Pass
4	7859.000	53.52	1.17	74.0	-20.48	Peak	268.00	150	Horizontal	Pass
4**	7859.000	43.46	1.17	54.0	-10.54	AV	268.00	150	Horizontal	Pass
5	13680.300	51.10	0.31	74.0	-22.90	Peak	360.00	150	Horizontal	Pass
5**	13680.300	41.28	0.31	54.0	-12.72	AV	360.00	150	Horizontal	Pass
6	17795.774	53.74	3.17	74.0	-20.26	Peak	52.00	150	Horizontal	Pass
6**	17795.774	44.37	3.17	54.0	-9.63	AV	52.00	150	Horizontal	Pass

1 GHz to 18 GHz, ANT V 802.11g Channel 9

No.	Frequency (MHz)	Results (dBuV/m)	Factor (dB)	Limit (dBuV/m)	Over Limit (dB)	Detector	Table (Degree)	Height (cm)	Antenna	Verdict
1	1600.000	42.17	-17.76	74.0	-31.83	Peak	343.00	150	Vertical	Pass
1**	1600.000	36.90	-17.76	54.0	-17.10	AV	343.00	150	Vertical	Pass
2	2438.000	104.42	-12.39	74.0	30.42	Peak	202.00	150	Vertical	N/A
2**	2438.000	97.44	-12.39	54.0	43.44	AV	202.00	150	Vertical	N/A
3	5184.250	50.97	-2.24	74.0	-23.03	Peak	281.00	150	Vertical	Pass
3**	5184.250	41.50	-2.24	54.0	-12.50	AV	281.00	150	Vertical	Pass
4	7515.750	53.17	0.90	74.0	-20.83	Peak	349.00	150	Vertical	Pass
4**	7515.750	44.22	0.90	54.0	-9.78	AV	349.00	150	Vertical	Pass
5	14090.588	51.95	-0.14	74.0	-22.05	Peak	52.00	150	Vertical	Pass
5**	14090.588	41.89	-0.14	54.0	-12.11	AV	52.00	150	Vertical	Pass
6	17275.501	53.69	1.97	74.0	-20.31	Peak	208.00	150	Vertical	Pass
6**	17275.501	44.44	1.97	54.0	-9.56	AV	208.00	150	Vertical	Pass

1 GHz to 18 GHz, ANT H 802.11g Channel 10

No.	Frequency (MHz)	Results (dBuV/m)	Factor (dB)	Limit (dBuV/m)	Over Limit (dB)	Detector	Table (Degree)	Height (cm)	Antenna	Verdict
1	1600.400	41.99	-17.78	74.0	-32.01	Peak	342.00	150	Horizontal	Pass
1**	1600.400	36.04	-17.78	54.0	-17.96	AV	342.00	150	Horizontal	Pass
2	2456.000	104.74	-12.81	74.0	30.74	Peak	170.00	150	Horizontal	N/A
2**	2456.000	97.99	-12.81	54.0	43.99	AV	170.00	150	Horizontal	N/A
3	5197.250	49.96	-3.27	74.0	-24.04	Peak	62.00	150	Horizontal	Pass
3**	5197.250	40.44	-3.27	54.0	-13.56	AV	62.00	150	Horizontal	Pass
4	7832.500	52.99	2.25	74.0	-21.01	Peak	105.00	150	Horizontal	Pass
4**	7832.500	44.30	2.25	54.0	-9.70	AV	105.00	150	Horizontal	Pass
5	13905.787	50.88	-0.44	74.0	-23.12	Peak	125.00	150	Horizontal	Pass
5**	13905.787	41.32	-0.44	54.0	-12.68	AV	125.00	150	Horizontal	Pass
6	16893.038	53.33	1.46	74.0	-20.67	Peak	258.00	150	Horizontal	Pass
6**	16893.038	44.54	1.46	54.0	-9.46	AV	258.00	150	Horizontal	Pass

1 GHz to 18 GHz, ANT V 802.11g Channel 10

No.	Frequency (MHz)	Results (dBuV/m)	Factor (dB)	Limit (dBuV/m)	Over Limit (dB)	Detector	Table (Degree)	Height (cm)	Antenna	Verdict
1	1327.100	41.62	-17.26	74.0	-32.38	Peak	193.00	150	Vertical	Pass
1**	1327.100	31.82	-17.26	54.0	-22.18	AV	193.00	150	Vertical	Pass
2	2460.800	103.74	-12.61	74.0	29.74	Peak	124.00	150	Vertical	N/A
2**	2460.800	96.48	-12.61	54.0	42.48	AV	124.00	150	Vertical	N/A
3	5180.000	50.14	-2.21	74.0	-23.86	Peak	299.00	150	Vertical	Pass
3**	5180.000	41.00	-2.21	54.0	-13.00	AV	299.00	150	Vertical	Pass
4	7840.000	53.14	1.88	74.0	-20.86	Peak	132.00	150	Vertical	Pass
4**	7840.000	44.48	1.88	54.0	-9.52	AV	132.00	150	Vertical	Pass
5	11800.713	49.73	-3.53	74.0	-24.27	Peak	230.00	150	Vertical	Pass
5**	11800.713	40.26	-3.53	54.0	-13.74	AV	230.00	150	Vertical	Pass
6	17575.274	53.39	3.23	74.0	-20.61	Peak	309.00	150	Vertical	Pass
6**	17575.274	43.61	3.23	54.0	-10.39	AV	309.00	150	Vertical	Pass

1 GHz to 18 GHz, ANT H 802.11g Channel11

No.	Frequency (MHz)	Results (dBuV/m)	Factor (dB)	Limit (dBuV/m)	Over Limit (dB)	Detector	Table (Degree)	Height (cm)	Antenna	Verdict
1	1599.700	41.71	-17.72	74.0	-32.29	Peak	279.00	150	Horizontal	Pass
1**	1599.700	35.37	-17.72	54.0	-18.63	AV	279.00	150	Horizontal	Pass
2	2460.900	104.38	-12.61	74.0	30.38	Peak	66.00	150	Horizontal	N/A
2**	2460.900	96.33	-12.61	54.0	42.33	AV	66.00	150	Horizontal	N/A
3	5179.500	50.74	-2.23	74.0	-23.26	Peak	95.00	150	Horizontal	Pass
3**	5179.500	41.61	-2.23	54.0	-12.39	AV	95.00	150	Horizontal	Pass
4	7834.250	52.33	2.23	74.0	-21.67	Peak	0.00	150	Horizontal	Pass
4**	7834.250	43.64	2.23	54.0	-10.36	AV	0.00	150	Horizontal	Pass
5	13400.738	50.56	-0.09	74.0	-23.44	Peak	38.00	150	Horizontal	Pass
5**	13400.738	40.14	-0.09	54.0	-13.86	AV	38.00	150	Horizontal	Pass
6	16896.713	52.99	1.49	74.0	-21.01	Peak	180.00	150	Horizontal	Pass
6**	16896.713	43.87	1.49	54.0	-10.13	AV	180.00	150	Horizontal	Pass

1 GHz to 18 GHz, ANT V 802.11g Channel11

No.	Frequency (MHz)	Results (dBuV/m)	Factor (dB)	Limit (dBuV/m)	Over Limit (dB)	Detector	Table (Degree)	Height (cm)	Antenna	Verdict
1	1329.500	43.36	-17.24	74.0	-30.64	Peak	18.00	150	Vertical	Pass
1**	1329.500	32.15	-17.24	54.0	-21.85	AV	18.00	150	Vertical	Pass
2	2463.400	104.49	-12.68	74.0	30.49	Peak	210.00	150	Vertical	N/A
2**	2463.400	97.29	-12.68	54.0	43.29	AV	210.00	150	Vertical	N/A
3	5182.000	51.19	-2.12	74.0	-22.81	Peak	360.00	150	Vertical	Pass
3**	5182.000	41.56	-2.12	54.0	-12.44	AV	360.00	150	Vertical	Pass
4	7832.750	52.69	2.28	74.0	-21.31	Peak	78.00	150	Vertical	Pass
4**	7832.750	44.15	2.28	54.0	-9.85	AV	78.00	150	Vertical	Pass
5	13644.338	51.33	0.25	74.0	-22.67	Peak	0.00	150	Vertical	Pass
5**	13644.338	42.48	0.25	54.0	-11.52	AV	0.00	150	Vertical	Pass
6	17308.312	53.34	1.99	74.0	-20.66	Peak	94.00	150	Vertical	Pass
6**	17308.312	44.79	1.99	54.0	-9.21	AV	94.00	150	Vertical	Pass

1 GHz to 18 GHz, ANT H 802.11n20 Channel 1

No.	Frequency (MHz)	Results (dBUV/m)	Factor (dB)	Limit (dBUV/m)	Over Limit (dB)	Detector	Table (Degree)	Height (cm)	Antenna	Verdict
1	1468.300	42.05	-17.45	74.0	-31.95	Peak	70.00	150	Horizontal	Pass
1**	1468.300	31.71	-17.45	54.0	-22.29	AV	70.00	150	Horizontal	Pass
2	2413.100	99.87	-13.42	74.0	25.87	Peak	82.00	150	Horizontal	N/A
2**	2413.100	92.86	-13.42	54.0	38.86	AV	82.00	150	Horizontal	N/A
3	5183.250	50.05	-2.11	74.0	-23.95	Peak	72.00	150	Horizontal	Pass
3**	5183.250	41.54	-2.11	54.0	-12.46	AV	72.00	150	Horizontal	Pass
4	7456.500	53.46	1.14	74.0	-20.54	Peak	244.00	150	Horizontal	Pass
4**	7456.500	44.45	1.14	54.0	-9.55	AV	244.00	150	Horizontal	Pass
5	14111.325	50.64	-0.08	74.0	-23.36	Peak	138.00	150	Horizontal	Pass
5**	14111.325	41.60	-0.08	54.0	-12.40	AV	138.00	150	Horizontal	Pass
6	17791.312	53.85	3.10	74.0	-20.15	Peak	360.00	150	Horizontal	Pass
6**	17791.312	44.61	3.10	54.0	-9.39	AV	360.00	150	Horizontal	Pass

1 GHz to 18 GHz, ANT V 802.11n20 Channel 1

No.	Frequency (MHz)	Results (dBUV/m)	Factor (dB)	Limit (dBUV/m)	Over Limit (dB)	Detector	Table (Degree)	Height (cm)	Antenna	Verdict
1	1827.000	45.86	-17.22	74.0	-28.14	Peak	94.00	150	Vertical	Pass
1**	1827.000	37.39	-17.22	54.0	-16.61	AV	94.00	150	Vertical	Pass
2	2409.800	100.44	-13.54	74.0	26.44	Peak	212.00	150	Vertical	N/A
2**	2409.800	93.35	-13.54	54.0	39.35	AV	212.00	150	Vertical	N/A
3	5187.250	50.60	-2.46	74.0	-23.40	Peak	344.00	150	Vertical	Pass
3**	5187.250	42.21	-2.46	54.0	-11.79	AV	344.00	150	Vertical	Pass
4	7834.000	52.86	2.24	74.0	-21.14	Peak	124.00	150	Vertical	Pass
4**	7834.000	44.24	2.24	54.0	-9.76	AV	124.00	150	Vertical	Pass
5	13559.026	50.71	0.56	74.0	-23.29	Peak	234.00	150	Vertical	Pass
5**	13559.026	40.82	0.56	54.0	-13.18	AV	234.00	150	Vertical	Pass
6	17804.964	53.62	3.18	74.0	-20.38	Peak	120.00	150	Vertical	Pass
6**	17804.964	45.65	3.18	54.0	-8.35	AV	120.00	150	Vertical	Pass

1 GHz to 18 GHz, ANT H 802.11n20 Channel 6

No.	Frequency (MHz)	Results (dBuV/m)	Factor (dB)	Limit (dBuV/m)	Over Limit (dB)	Detector	Table (Degree)	Height (cm)	Antenna	Verdict
1	1599.700	42.11	-17.72	74.0	-31.89	Peak	6.00	150	Horizontal	Pass
1**	1599.700	35.07	-17.72	54.0	-18.93	AV	6.00	150	Horizontal	Pass
2	2435.200	103.27	-12.07	74.0	29.27	Peak	60.00	150	Horizontal	N/A
2**	2435.200	95.85	-12.07	54.0	41.85	AV	60.00	150	Horizontal	N/A
3	5268.500	50.17	-3.49	74.0	-23.83	Peak	61.00	150	Horizontal	Pass
3**	5268.500	41.86	-3.49	54.0	-12.14	AV	61.00	150	Horizontal	Pass
4	7462.000	53.02	1.11	74.0	-20.98	Peak	4.00	150	Horizontal	Pass
4**	7462.000	44.14	1.11	54.0	-9.86	AV	4.00	150	Horizontal	Pass
5	13762.463	51.06	-0.28	74.0	-22.94	Peak	178.00	150	Horizontal	Pass
5**	13762.463	41.01	-0.28	54.0	-12.99	AV	178.00	150	Horizontal	Pass
6	17638.801	54.14	2.97	74.0	-19.86	Peak	164.00	150	Horizontal	Pass
6**	17638.801	44.10	2.97	54.0	-9.90	AV	164.00	150	Horizontal	Pass

1 GHz to 18 GHz, ANT V 802.11n20 Channel 6

No.	Frequency (MHz)	Results (dBuV/m)	Factor (dB)	Limit (dBuV/m)	Over Limit (dB)	Detector	Table (Degree)	Height (cm)	Antenna	Verdict
1	1600.100	42.12	-17.77	74.0	-31.88	Peak	156.00	150	Vertical	Pass
1**	1600.100	36.27	-17.77	54.0	-17.73	AV	156.00	150	Vertical	Pass
2	2435.200	104.05	-12.07	74.0	30.05	Peak	205.00	150	Vertical	N/A
2**	2435.200	96.31	-12.07	54.0	42.31	AV	205.00	150	Vertical	N/A
3	5198.750	50.15	-3.27	74.0	-23.85	Peak	62.00	150	Vertical	Pass
3**	5198.750	40.62	-3.27	54.0	-13.38	AV	62.00	150	Vertical	Pass
4	7858.500	53.39	1.13	74.0	-20.61	Peak	45.00	150	Vertical	Pass
4**	7858.500	45.07	1.13	54.0	-8.93	AV	45.00	150	Vertical	Pass
5	13404.675	51.05	-0.07	74.0	-22.95	Peak	360.00	150	Vertical	Pass
5**	13404.675	41.23	-0.07	54.0	-12.77	AV	360.00	150	Vertical	Pass
6	17787.636	53.87	3.05	74.0	-20.13	Peak	180.00	150	Vertical	Pass
6**	17787.636	45.07	3.05	54.0	-8.93	AV	180.00	150	Vertical	Pass

1 GHz to 18 GHz, ANT H 802.11n20 Channel 11

No.	Frequency (MHz)	Results (dBuV/m)	Factor (dB)	Limit (dBuV/m)	Over Limit (dB)	Detector	Table (Degree)	Height (cm)	Antenna	Verdict
1	1600.200	42.81	-17.78	74.0	-31.19	Peak	232.00	150	Horizontal	Pass
1**	1600.200	36.97	-17.78	54.0	-17.03	AV	232.00	150	Horizontal	Pass
2	2463.300	101.80	-12.68	74.0	27.80	Peak	350.00	150	Horizontal	N/A
2**	2463.300	94.73	-12.68	54.0	40.73	AV	350.00	150	Horizontal	N/A
3	5377.250	50.43	-3.39	74.0	-23.57	Peak	121.00	150	Horizontal	Pass
3**	5377.250	40.72	-3.39	54.0	-13.28	AV	121.00	150	Horizontal	Pass
4	7136.000	53.22	0.93	74.0	-20.78	Peak	305.00	150	Horizontal	Pass
4**	7136.000	43.78	0.93	54.0	-10.22	AV	305.00	150	Horizontal	Pass
5	14086.125	50.94	-0.22	74.0	-23.06	Peak	166.00	150	Horizontal	Pass
5**	14086.125	41.89	-0.22	54.0	-12.11	AV	166.00	150	Horizontal	Pass
6	16427.887	54.00	0.13	74.0	-20.00	Peak	238.00	150	Horizontal	Pass
6**	16427.887	43.33	0.13	54.0	-10.67	AV	238.00	150	Horizontal	Pass

1 GHz to 18 GHz, ANT V 802.11n20 Channel 11

No.	Frequency (MHz)	Results (dBuV/m)	Factor (dB)	Limit (dBuV/m)	Over Limit (dB)	Detector	Table (Degree)	Height (cm)	Antenna	Verdict
1	1328.400	42.81	-17.09	74.0	-31.19	Peak	229.00	150	Vertical	Pass
1**	1328.400	31.84	-17.09	54.0	-22.16	AV	229.00	150	Vertical	Pass
2	2460.500	102.71	-12.62	74.0	28.71	Peak	210.00	150	Vertical	N/A
2**	2460.500	95.06	-12.62	54.0	41.06	AV	210.00	150	Vertical	N/A
3	5236.500	51.19	-3.30	74.0	-22.81	Peak	36.00	150	Vertical	Pass
3**	5236.500	41.04	-3.30	54.0	-12.96	AV	36.00	150	Vertical	Pass
4	7851.500	52.89	1.01	74.0	-21.11	Peak	264.00	150	Vertical	Pass
4**	7851.500	43.71	1.01	54.0	-10.29	AV	264.00	150	Vertical	Pass
5	14083.763	51.21	-0.27	74.0	-22.79	Peak	152.00	150	Vertical	Pass
5**	14083.763	41.87	-0.27	54.0	-12.13	AV	152.00	150	Vertical	Pass
6	17052.637	54.09	0.94	74.0	-19.91	Peak	236.00	150	Vertical	Pass
6**	17052.637	42.81	0.94	54.0	-11.19	AV	236.00	150	Vertical	Pass

1 GHz to 18 GHz, ANT H 802.11n40 Channel 3

No.	Frequency (MHz)	Results (dBuV/m)	Factor (dB)	Limit (dBuV/m)	Over Limit (dB)	Detector	Table (Degree)	Height (cm)	Antenna	Verdict
1	1600.100	42.29	-17.77	74.0	-31.71	Peak	1.00	150	Horizontal	Pass
1**	1600.100	36.31	-17.77	54.0	-17.69	AV	1.00	150	Horizontal	Pass
2	2423.600	95.77	-12.81	74.0	21.77	Peak	171.00	150	Horizontal	N/A
2**	2423.600	88.24	-12.81	54.0	34.24	AV	171.00	150	Horizontal	N/A
3	5239.000	50.13	-3.22	74.0	-23.87	Peak	79.00	150	Horizontal	Pass
3**	5239.000	41.37	-3.22	54.0	-12.63	AV	79.00	150	Horizontal	Pass
4	7852.250	53.08	0.92	74.0	-20.92	Peak	113.00	150	Horizontal	Pass
4**	7852.250	43.65	0.92	54.0	-10.35	AV	113.00	150	Horizontal	Pass
5	12695.137	50.00	-2.33	74.0	-24.00	Peak	19.00	150	Horizontal	Pass
5**	12695.137	40.21	-2.33	54.0	-13.79	AV	19.00	150	Horizontal	Pass
6	17300.437	53.58	2.01	74.0	-20.42	Peak	54.00	150	Horizontal	Pass
6**	17300.437	44.49	2.01	54.0	-9.51	AV	54.00	150	Horizontal	Pass

1 GHz to 18 GHz, ANT V 802.11n40 Channel 3

No.	Frequency (MHz)	Results (dBuV/m)	Factor (dB)	Limit (dBuV/m)	Over Limit (dB)	Detector	Table (Degree)	Height (cm)	Antenna	Verdict
1	1566.400	42.22	-17.56	74.0	-31.78	Peak	99.00	150	Vertical	Pass
1**	1566.400	32.60	-17.56	54.0	-21.40	AV	99.00	150	Vertical	Pass
2	2425.500	95.83	-12.71	74.0	21.83	Peak	104.00	150	Vertical	N/A
2**	2425.500	87.55	-12.71	54.0	33.55	AV	104.00	150	Vertical	N/A
3	5153.750	50.10	-3.53	74.0	-23.90	Peak	4.00	150	Vertical	Pass
3**	5153.750	40.42	-3.53	54.0	-13.58	AV	4.00	150	Vertical	Pass
4	7836.500	53.72	2.11	74.0	-20.28	Peak	139.00	150	Vertical	Pass
4**	7836.500	44.39	2.11	54.0	-9.61	AV	139.00	150	Vertical	Pass
5	13596.826	50.84	-0.09	74.0	-23.16	Peak	24.00	150	Vertical	Pass
5**	13596.826	40.91	-0.09	54.0	-13.09	AV	24.00	150	Vertical	Pass
6	17328.525	53.69	1.94	74.0	-20.31	Peak	294.00	150	Vertical	Pass
6**	17328.525	43.47	1.94	54.0	-10.53	AV	294.00	150	Vertical	Pass

1 GHz to 18 GHz, ANT H 802.11n40 Channel 6

No.	Frequency (MHz)	Results (dBUV/m)	Factor (dB)	Limit (dBUV/m)	Over Limit (dB)	Detector	Table (Degree)	Height (cm)	Antenna	Verdict
1	1600.100	42.57	-17.77	74.0	-31.43	Peak	103.00	150	Horizontal	Pass
1**	1600.100	36.49	-17.77	54.0	-17.51	AV	103.00	150	Horizontal	Pass
2	2435.500	99.33	-12.09	74.0	25.33	Peak	125.00	150	Horizontal	N/A
2**	2435.500	92.06	-12.09	54.0	38.06	AV	125.00	150	Horizontal	N/A
3	5194.000	50.79	-2.96	74.0	-23.21	Peak	84.00	150	Horizontal	Pass
3**	5194.000	41.31	-2.96	54.0	-12.69	AV	84.00	150	Horizontal	Pass
4	7832.750	53.06	2.28	74.0	-20.94	Peak	93.00	150	Horizontal	Pass
4**	7832.750	44.62	2.28	54.0	-9.38	AV	93.00	150	Horizontal	Pass
5	13430.925	50.66	0.08	74.0	-23.34	Peak	196.00	150	Horizontal	Pass
5**	13430.925	41.30	0.08	54.0	-12.70	AV	196.00	150	Horizontal	Pass
6	16553.363	53.21	0.03	74.0	-20.79	Peak	224.00	150	Horizontal	Pass
6**	16553.363	43.42	0.03	54.0	-10.58	AV	224.00	150	Horizontal	Pass

1 GHz to 18 GHz, ANT V 802.11n40 Channel 6

No.	Frequency (MHz)	Results (dBUV/m)	Factor (dB)	Limit (dBUV/m)	Over Limit (dB)	Detector	Table (Degree)	Height (cm)	Antenna	Verdict
1	1824.900	44.39	-17.18	74.0	-29.61	Peak	67.00	150	Vertical	Pass
1**	1824.900	32.94	-17.18	54.0	-21.06	AV	67.00	150	Vertical	Pass
2	2434.100	98.41	-12.17	74.0	24.41	Peak	73.00	150	Vertical	N/A
2**	2434.100	90.98	-12.17	54.0	36.98	AV	73.00	150	Vertical	N/A
3	5244.000	50.62	-3.61	74.0	-23.38	Peak	305.00	150	Vertical	Pass
3**	5244.000	40.92	-3.61	54.0	-13.08	AV	305.00	150	Vertical	Pass
4	7866.000	53.24	1.54	74.0	-20.76	Peak	4.00	150	Vertical	Pass
4**	7866.000	44.36	1.54	54.0	-9.64	AV	4.00	150	Vertical	Pass
5	13926.000	51.93	-0.31	74.0	-22.07	Peak	138.00	150	Vertical	Pass
5**	13926.000	40.71	-0.31	54.0	-13.29	AV	138.00	150	Vertical	Pass
6	16505.062	54.01	0.00	74.0	-19.99	Peak	94.00	150	Vertical	Pass
6**	16505.062	44.15	0.00	54.0	-9.85	AV	94.00	150	Vertical	Pass

1 GHz to 18 GHz, ANT H 802.11n40 Channel 7

No.	Frequency (MHz)	Results (dBuV/m)	Factor (dB)	Limit (dBuV/m)	Over Limit (dB)	Detector	Table (Degree)	Height (cm)	Antenna	Verdict
1	1599.700	42.06	-17.72	74.0	-31.94	Peak	82.00	150	Horizontal	Pass
1**	1599.700	35.17	-17.72	54.0	-18.83	AV	82.00	150	Horizontal	Pass
2	2446.500	98.26	-12.70	74.0	24.26	Peak	140.00	150	Horizontal	N/A
2**	2446.500	90.35	-12.70	54.0	36.35	AV	140.00	150	Horizontal	N/A
3	5339.750	50.88	-3.46	74.0	-23.12	Peak	135.00	150	Horizontal	Pass
3**	5339.750	41.06	-3.46	54.0	-12.94	AV	135.00	150	Horizontal	Pass
4	7821.750	53.10	1.64	74.0	-20.90	Peak	168.00	150	Horizontal	Pass
4**	7821.750	43.77	1.64	54.0	-10.23	AV	168.00	150	Horizontal	Pass
5	13409.138	50.31	-0.04	74.0	-23.69	Peak	291.00	150	Horizontal	Pass
5**	13409.138	40.84	-0.04	54.0	-13.16	AV	291.00	150	Horizontal	Pass
6	16494.562	54.07	-0.00	74.0	-19.93	Peak	322.00	150	Horizontal	Pass
6**	16494.562	43.41	-0.00	54.0	-10.59	AV	322.00	150	Horizontal	Pass

1 GHz to 18 GHz, ANT V 802.11n40 Channel 7

No.	Frequency (MHz)	Results (dBuV/m)	Factor (dB)	Limit (dBuV/m)	Over Limit (dB)	Detector	Table (Degree)	Height (cm)	Antenna	Verdict
1	1600.200	42.35	-17.78	74.0	-31.65	Peak	70.00	150	Vertical	Pass
1**	1600.200	36.05	-17.78	54.0	-17.95	AV	70.00	150	Vertical	Pass
2	2451.700	97.26	-12.80	74.0	23.26	Peak	122.00	150	Vertical	N/A
2**	2451.700	89.76	-12.80	54.0	35.76	AV	122.00	150	Vertical	N/A
3	5336.500	51.19	-3.69	74.0	-22.81	Peak	120.00	150	Vertical	Pass
3**	5336.500	40.98	-3.69	54.0	-13.02	AV	120.00	150	Vertical	Pass
4	7832.500	52.88	2.25	74.0	-21.12	Peak	94.00	150	Vertical	Pass
4**	7832.500	44.02	2.25	54.0	-9.98	AV	94.00	150	Vertical	Pass
5	14090.063	51.16	-0.15	74.0	-22.84	Peak	352.00	150	Vertical	Pass
5**	14090.063	41.97	-0.15	54.0	-12.03	AV	352.00	150	Vertical	Pass
6	17643.786	53.82	2.93	74.0	-20.18	Peak	360.00	150	Vertical	Pass
6**	17643.786	43.96	2.93	54.0	-10.04	AV	360.00	150	Vertical	Pass

1 GHz to 18 GHz, ANT H 802.11n40 Channel 8

No.	Frequency (MHz)	Results (dBUV/m)	Factor (dB)	Limit (dBUV/m)	Over Limit (dB)	Detector	Table (Degree)	Height (cm)	Antenna	Verdict
1	1513.900	42.15	-17.44	74.0	-31.85	Peak	89.00	150	Horizontal	Pass
1**	1513.900	32.31	-17.44	54.0	-21.69	AV	89.00	150	Horizontal	Pass
2	2455.700	98.83	-12.88	74.0	24.83	Peak	0.00	150	Horizontal	N/A
2**	2455.700	90.97	-12.88	54.0	36.97	AV	0.00	150	Horizontal	N/A
3	5272.750	50.85	-3.20	74.0	-23.15	Peak	52.00	150	Horizontal	Pass
3**	5272.750	41.04	-3.20	54.0	-12.96	AV	52.00	150	Horizontal	Pass
4	7859.750	53.10	1.24	74.0	-20.90	Peak	23.00	150	Horizontal	Pass
4**	7859.750	43.98	1.24	54.0	-10.02	AV	23.00	150	Horizontal	Pass
5	11318.112	49.61	-4.18	74.0	-24.39	Peak	134.00	150	Horizontal	Pass
5**	11318.112	40.04	-4.18	54.0	-13.96	AV	134.00	150	Horizontal	Pass
6	16502.438	52.94	0.00	74.0	-21.06	Peak	308.00	150	Horizontal	Pass
6**	16502.438	43.38	0.00	54.0	-10.62	AV	308.00	150	Horizontal	Pass

1 GHz to 18 GHz, ANT V 802.11n40 Channel 8

No.	Frequency (MHz)	Results (dBUV/m)	Factor (dB)	Limit (dBUV/m)	Over Limit (dB)	Detector	Table (Degree)	Height (cm)	Antenna	Verdict
1	1599.900	42.21	-17.75	74.0	-31.79	Peak	151.00	150	Vertical	Pass
1**	1599.900	36.65	-17.75	54.0	-17.35	AV	151.00	150	Vertical	Pass
2	2450.100	98.01	-12.74	74.0	24.01	Peak	117.00	150	Vertical	N/A
2**	2450.100	90.75	-12.74	54.0	36.75	AV	117.00	150	Vertical	N/A
3	5197.250	50.70	-3.27	74.0	-23.30	Peak	231.00	150	Vertical	Pass
3**	5197.250	40.69	-3.27	54.0	-13.31	AV	231.00	150	Vertical	Pass
4	7841.250	53.24	1.73	74.0	-20.76	Peak	223.00	150	Vertical	Pass
4**	7841.250	43.69	1.73	54.0	-10.31	AV	223.00	150	Vertical	Pass
5	13359.000	51.22	-0.18	74.0	-22.78	Peak	352.00	150	Vertical	Pass
5**	13359.000	41.06	-0.18	54.0	-12.94	AV	352.00	150	Vertical	Pass
6	16427.625	53.67	0.13	74.0	-20.33	Peak	134.00	150	Vertical	Pass
6**	16427.625	43.40	0.13	54.0	-10.60	AV	134.00	150	Vertical	Pass

1 GHz to 18 GHz, ANT H 802.11n40 Channel 9

No.	Frequency (MHz)	Results (dBuV/m)	Factor (dB)	Limit (dBuV/m)	Over Limit (dB)	Detector	Table (Degree)	Height (cm)	Antenna	Verdict
1	1600.100	42.25	-17.77	74.0	-31.75	Peak	0.00	150	Horizontal	Pass
1**	1600.100	36.28	-17.77	54.0	-17.72	AV	0.00	150	Horizontal	Pass
2	2455.900	99.57	-12.83	74.0	25.57	Peak	167.00	150	Horizontal	N/A
2**	2455.900	91.67	-12.83	54.0	37.67	AV	167.00	150	Horizontal	N/A
3	5263.000	50.25	-3.67	74.0	-23.75	Peak	0.00	150	Horizontal	Pass
3**	5263.000	41.08	-3.67	54.0	-12.92	AV	0.00	150	Horizontal	Pass
4	7822.750	53.21	1.69	74.0	-20.79	Peak	197.00	150	Horizontal	Pass
4**	7822.750	43.73	1.69	54.0	-10.27	AV	197.00	150	Horizontal	Pass
5	14074.838	51.00	-0.45	74.0	-23.00	Peak	238.00	150	Horizontal	Pass
5**	14074.838	41.72	-0.45	54.0	-12.28	AV	238.00	150	Horizontal	Pass
6	16533.676	53.60	0.02	74.0	-20.40	Peak	196.00	150	Horizontal	Pass
6**	16533.676	43.79	0.02	54.0	-10.21	AV	196.00	150	Horizontal	Pass

1 GHz to 18 GHz, ANT V 802.11n40 Channel 9

No.	Frequency (MHz)	Results (dBuV/m)	Factor (dB)	Limit (dBuV/m)	Over Limit (dB)	Detector	Table (Degree)	Height (cm)	Antenna	Verdict
1	1333.600	46.37	-17.49	74.0	-27.63	Peak	221.00	150	Vertical	Pass
1**	1333.600	36.07	-17.49	54.0	-17.93	AV	221.00	150	Vertical	Pass
2	2454.700	98.47	-13.11	74.0	24.47	Peak	115.00	150	Vertical	N/A
2**	2454.700	91.03	-13.11	54.0	37.03	AV	115.00	150	Vertical	N/A
3	5343.000	50.53	-3.50	74.0	-23.47	Peak	109.00	150	Vertical	Pass
3**	5343.000	40.52	-3.50	54.0	-13.48	AV	109.00	150	Vertical	Pass
4	7459.500	52.63	1.14	74.0	-21.37	Peak	160.00	150	Vertical	Pass
4**	7459.500	43.88	1.14	54.0	-10.12	AV	160.00	150	Vertical	Pass
5	14081.138	50.65	-0.32	74.0	-23.35	Peak	194.00	150	Vertical	Pass
5**	14081.138	41.20	-0.32	54.0	-12.80	AV	194.00	150	Vertical	Pass
6	17276.287	54.10	1.97	74.0	-19.90	Peak	324.00	150	Vertical	Pass
6**	17276.287	44.10	1.97	54.0	-9.90	AV	324.00	150	Vertical	Pass

A.7 Band Edge (Restricted-band band-edge)

Note ¹: The lowest and highest channels are tested to verify the band edge emissions. Please refer to the following the plots for emissions values.

Note ²: The test data all are tested in the vertical and horizontal antenna which the trace is max hold. So these plots have shown the worst case.

Note ³: According the ANSI C63.10-2013, where limits are specified for both average and peak (or quasi-peak) detector functions, if the peak (or quasi-peak) measured value complies with the average limit, it is unnecessary to perform an average measurement.

Test Data and Plots

802.11b CHANNEL 1

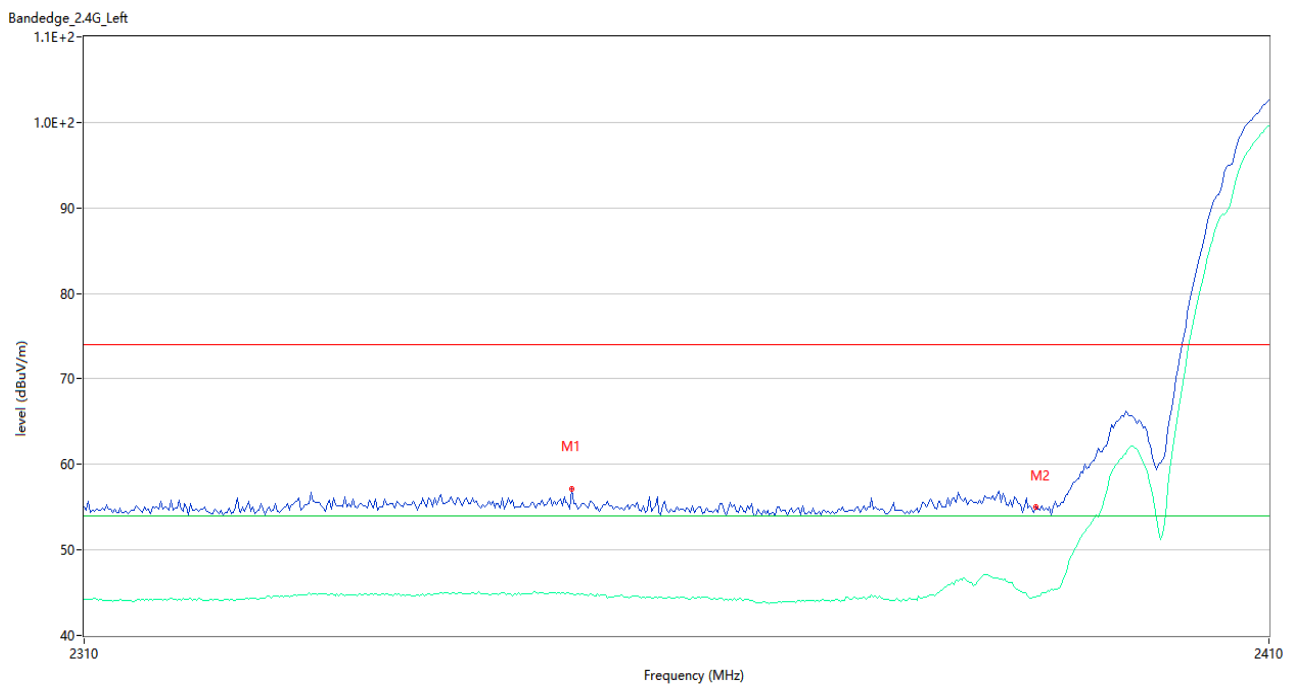

No.	Frequency (MHz)	Results (dBuV/m)	Factor (dB)	Limit (dBuV/m)	Over Limit (dB)	Detector	Table (Degree)	Height (cm)	Antenna	Verdict
1	2350.667	57.11	2.52	74.0	-16.89	Peak	323.00	150	Horizontal	Pass
1**	2350.667	44.94	2.52	54.0	-9.06	AV	323.00	150	Horizontal	Pass
2	2390.000	54.99	1.62	74.0	-19.01	Peak	117.00	150	Horizontal	Pass
2**	2390.000	44.50	1.62	54.0	-9.50	AV	117.00	150	Horizontal	Pass

802.11b CHANNEL 11

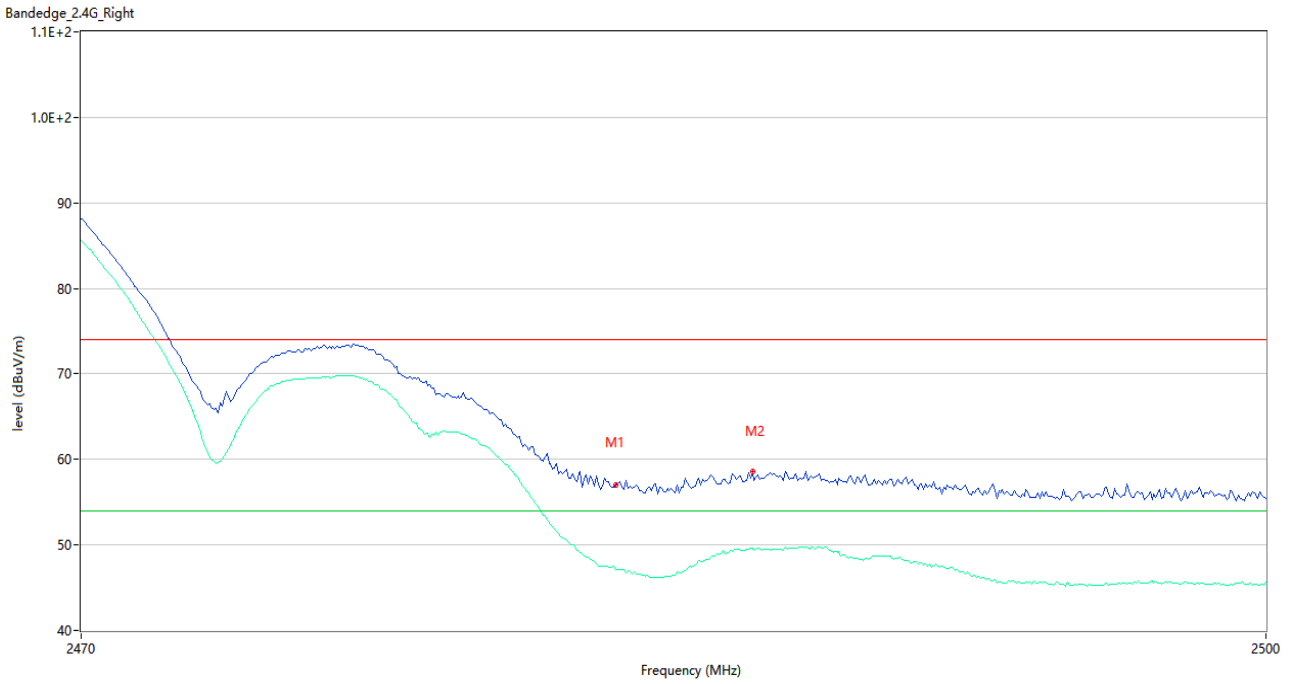

No.	Frequency (MHz)	Results (dBuV/m)	Factor (dB)	Limit (dBuV/m)	Over Limit (dB)	Detector	Table (Degree)	Height (cm)	Antenna	Verdict
1	2483.500	57.01	1.98	74.0	-16.99	Peak	295.00	150	Horizontal	Pass
1**	2483.500	47.13	1.98	54.0	-6.87	AV	295.00	150	Horizontal	Pass
2	2486.950	58.62	1.78	74.0	-15.38	Peak	110.00	150	Horizontal	Pass
2**	2486.950	49.59	1.78	54.0	-4.41	AV	110.00	150	Horizontal	Pass

802.11g CHANNEL 1

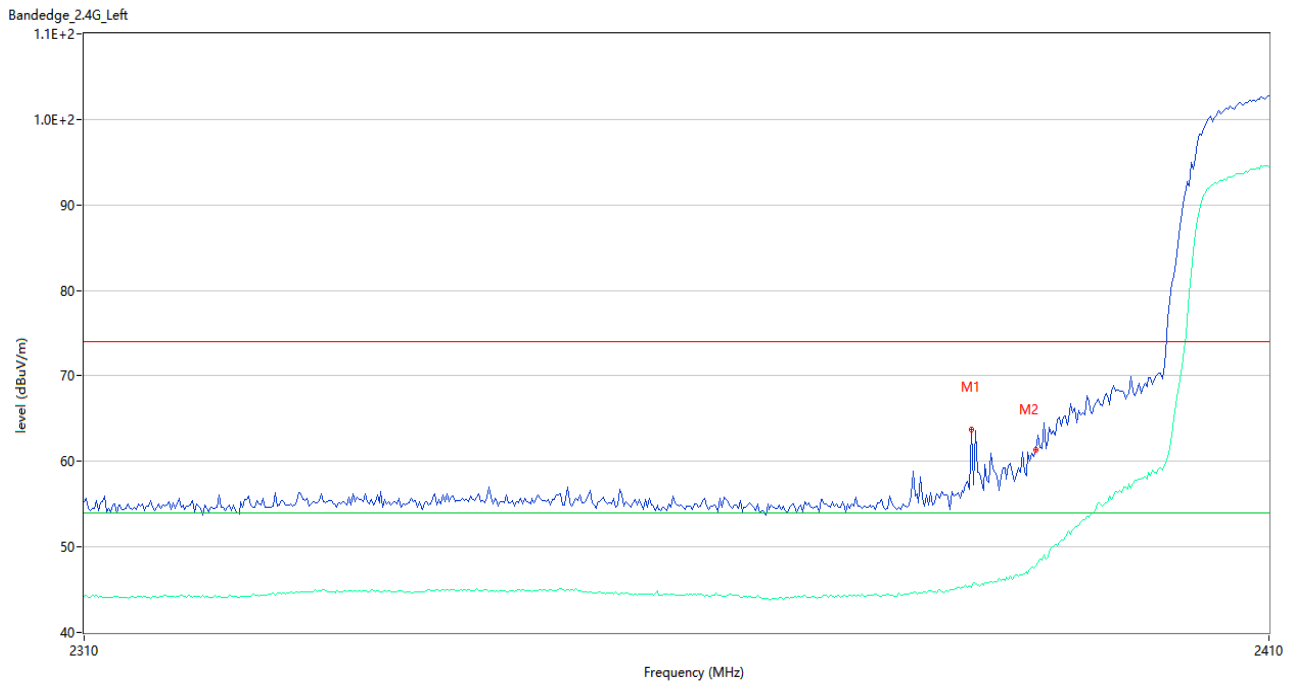

No.	Frequency (MHz)	Results (dBuV/m)	Factor (dB)	Limit (dBuV/m)	Over Limit (dB)	Detector	Table (Degree)	Height (cm)	Antenna	Verdict
1	2384.500	63.76	1.85	74.0	-10.24	Peak	117.00	150	Horizontal	Pass
1**	2384.500	45.28	1.85	54.0	-8.72	AV	117.00	150	Horizontal	Pass
2	2390.000	61.36	1.62	74.0	-12.64	Peak	112.00	150	Horizontal	Pass
2**	2390.000	47.76	1.62	54.0	-6.24	AV	112.00	150	Horizontal	Pass

802.11g CHANNEL 10

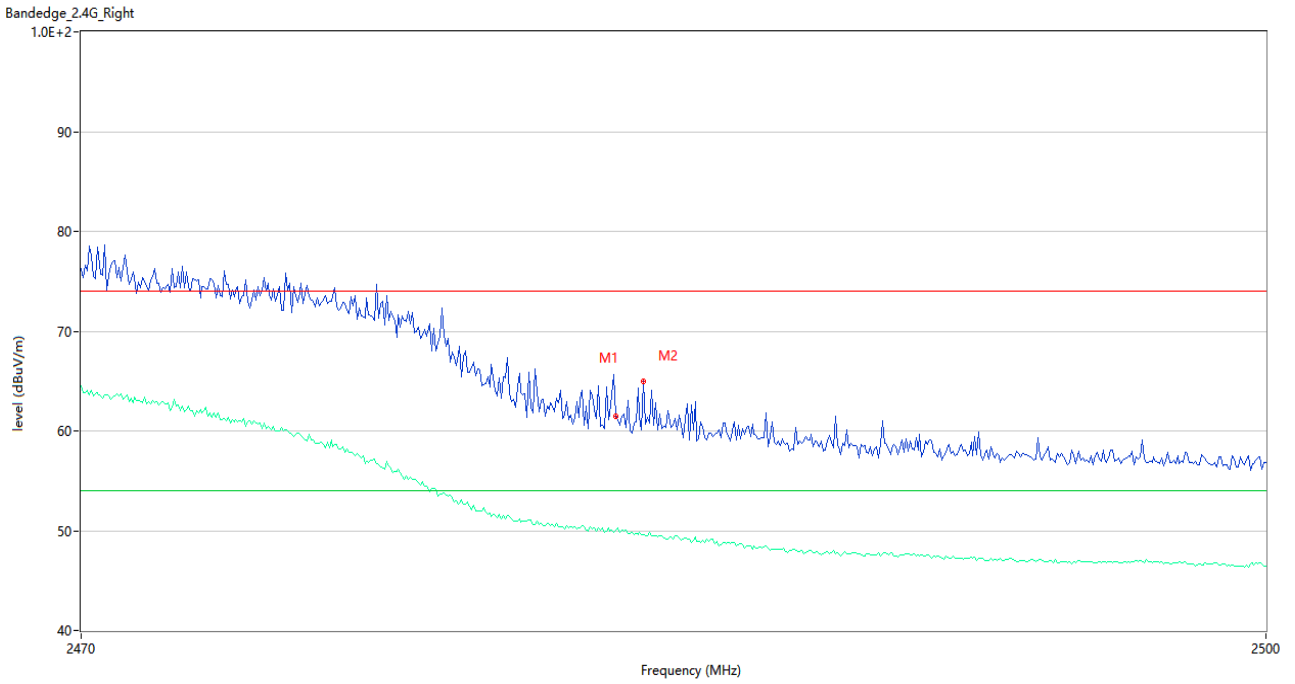

No.	Frequency (MHz)	Results (dBuV/m)	Factor (dB)	Limit (dBuV/m)	Over Limit (dB)	Detector	Table (Degree)	Height (cm)	Antenna	Verdict
1	2483.500	61.51	1.98	74.0	-12.49	Peak	352.00	150	Horizontal	Pass
1**	2483.500	50.01	1.98	54.0	-3.99	AV	352.00	150	Horizontal	Pass
2	2484.200	64.98	2.00	74.0	-9.02	Peak	360.00	150	Horizontal	Pass
2**	2484.200	49.58	2.00	54.0	-4.42	AV	360.00	150	Horizontal	Pass

802.11g CHANNEL 11

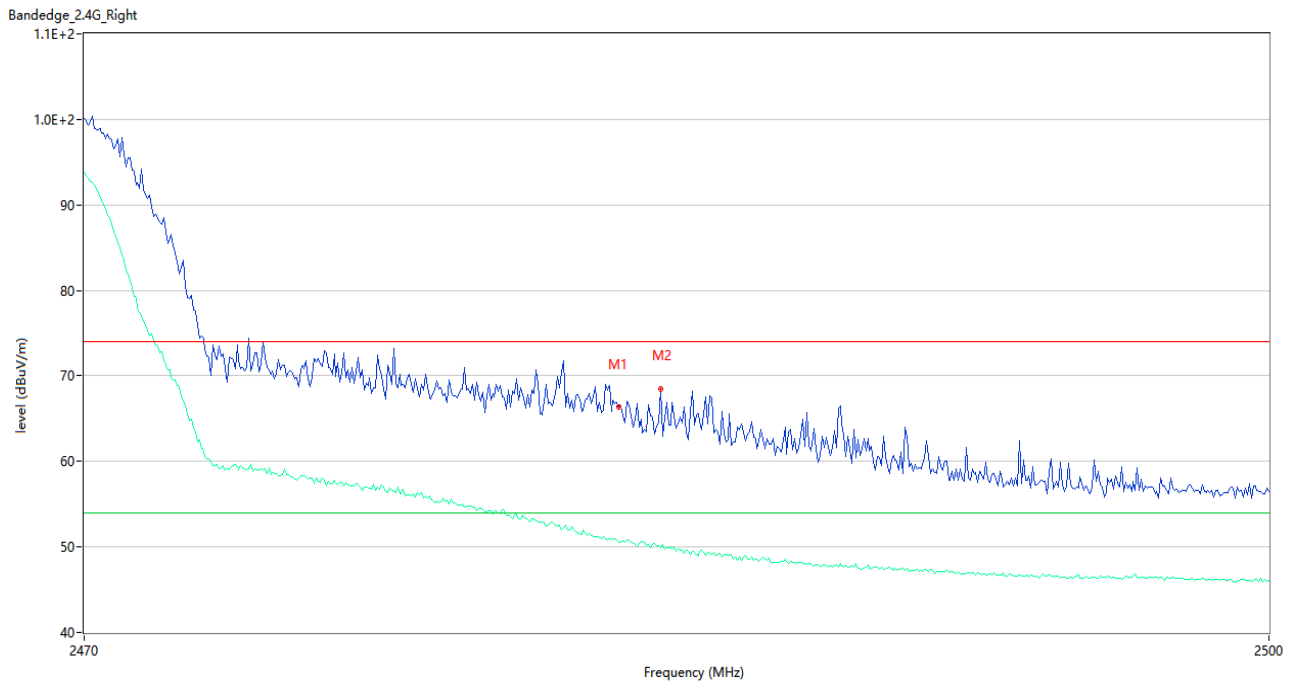

No.	Frequency (MHz)	Results (dBuV/m)	Factor (dB)	Limit (dBuV/m)	Over Limit (dB)	Detector	Table (Degree)	Height (cm)	Antenna	Verdict
1	2483.500	66.39	1.98	74.0	-7.61	Peak	184.00	150	Horizontal	Pass
1**	2483.500	50.55	1.98	54.0	-3.45	AV	184.00	150	Horizontal	Pass
2	2484.550	68.49	1.97	74.0	-5.51	Peak	6.00	150	Horizontal	Pass
2**	2484.550	49.88	1.97	54.0	-4.12	AV	6.00	150	Horizontal	Pass

802.11n20 CHANNEL 1

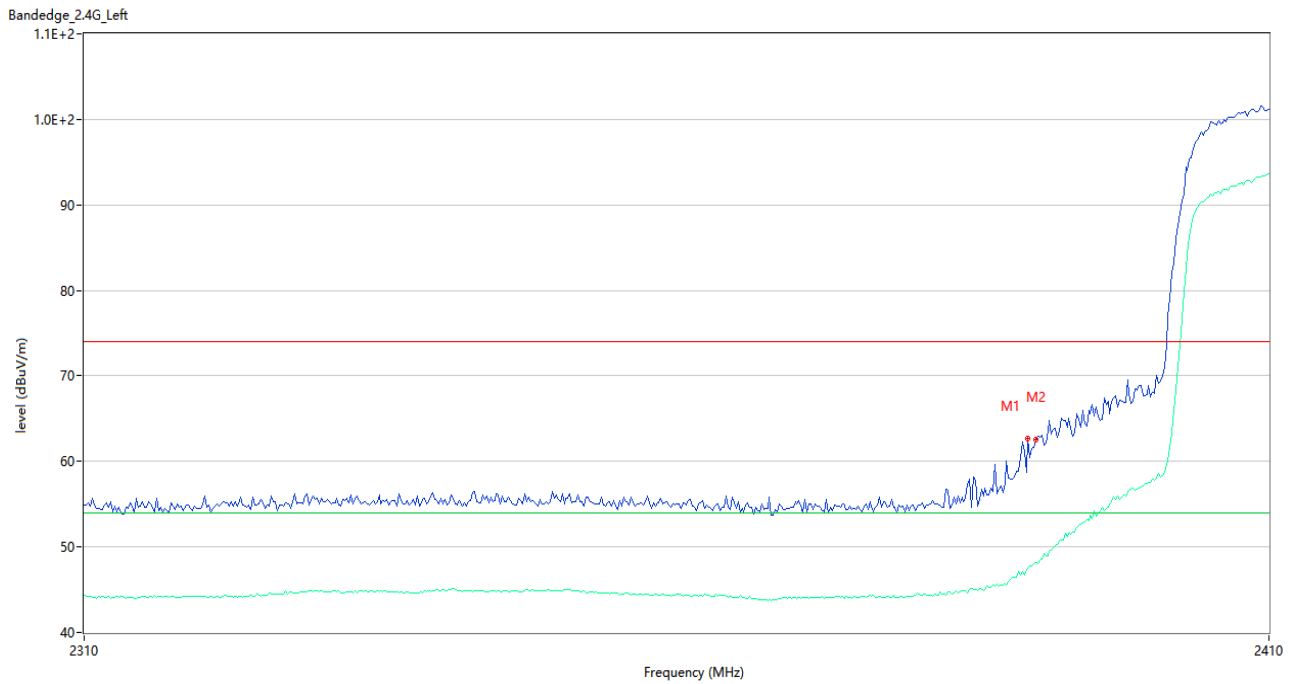

No.	Frequency (MHz)	Results (dBuV/m)	Factor (dB)	Limit (dBuV/m)	Over Limit (dB)	Detector	Table (Degree)	Height (cm)	Antenna	Verdict
1	2389.333	62.65	1.67	74.0	-11.35	Peak	119.00	150	Horizontal	Pass
1**	2389.333	47.49	1.67	54.0	-6.51	AV	119.00	150	Horizontal	Pass
2	2390.000	62.60	1.62	74.0	-11.40	Peak	119.00	150	Horizontal	Pass
2**	2390.000	48.14	1.62	54.0	-5.86	AV	119.00	150	Horizontal	Pass

802.11n20 CHANNEL 11

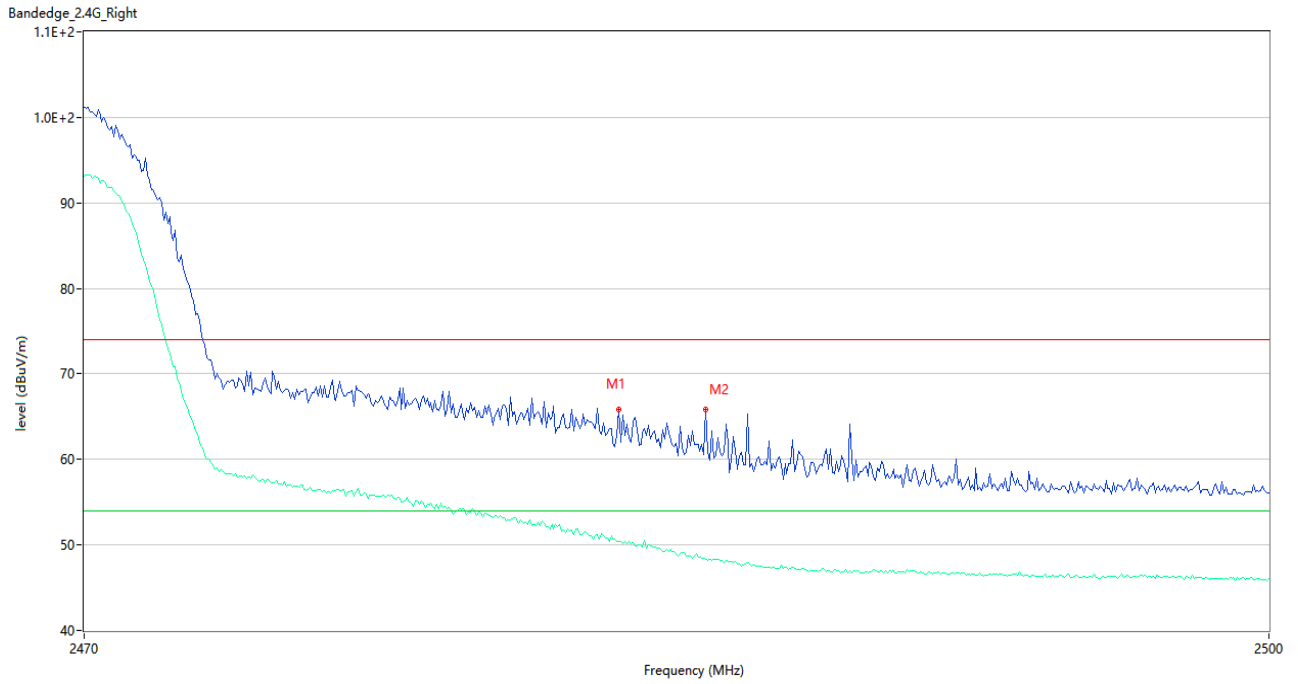

No.	Frequency (MHz)	Results (dBuV/m)	Factor (dB)	Limit (dBuV/m)	Over Limit (dB)	Detector	Table (Degree)	Height (cm)	Antenna	Verdict
1	2483.500	65.79	1.98	74.0	-8.21	Peak	126.00	150	Horizontal	Pass
1**	2483.500	50.41	1.98	54.0	-3.59	AV	126.00	150	Horizontal	Pass
2	2485.700	65.84	1.86	74.0	-8.16	Peak	360.00	150	Horizontal	Pass
2**	2485.700	48.36	1.86	54.0	-5.64	AV	360.00	150	Horizontal	Pass

802.11n40 CHANNEL 3

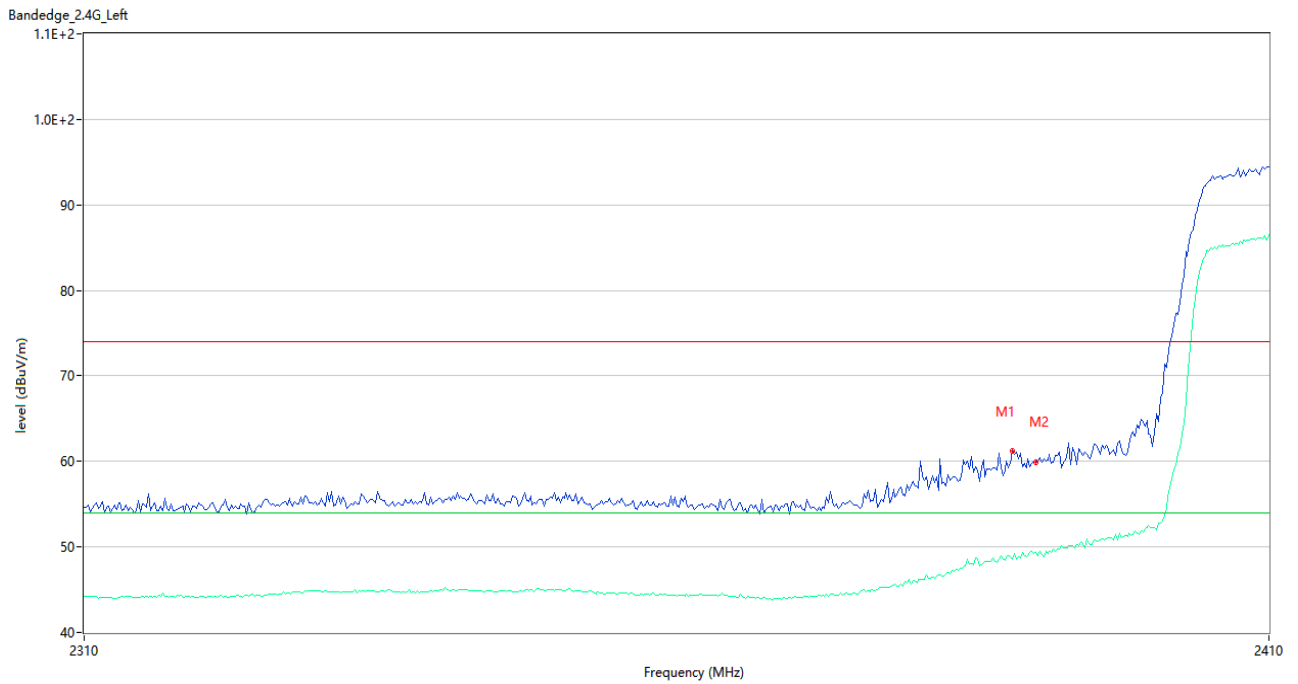

No.	Frequency (MHz)	Results (dBuV/m)	Factor (dB)	Limit (dBuV/m)	Over Limit (dB)	Detector	Table (Degree)	Height (cm)	Antenna	Verdict
1	2388.000	61.25	1.76	74.0	-12.75	Peak	125.00	150	Horizontal	Pass
1**	2388.000	48.60	1.76	54.0	-5.40	AV	125.00	150	Horizontal	Pass
2	2390.000	59.95	1.62	74.0	-14.05	Peak	132.00	150	Horizontal	Pass
2**	2390.000	49.37	1.62	54.0	-4.63	AV	132.00	150	Horizontal	Pass

802.11n40 CHANNEL 7

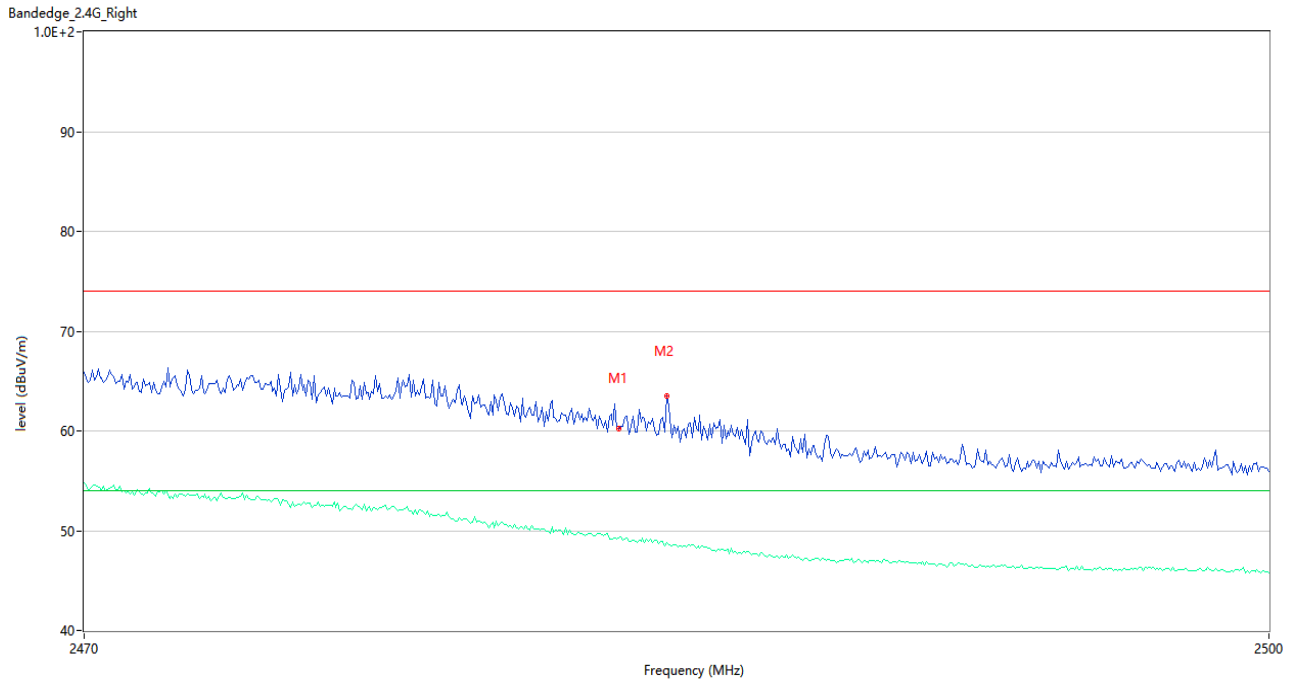

No.	Frequency (MHz)	Results (dBuV/m)	Factor (dB)	Limit (dBuV/m)	Over Limit (dB)	Detector	Table (Degree)	Height (cm)	Antenna	Verdict
1	2483.500	60.28	1.98	74.0	-13.72	Peak	293.00	150	Horizontal	Pass
1**	2483.500	49.23	1.98	54.0	-4.77	AV	293.00	150	Horizontal	Pass
2	2484.700	63.51	1.95	74.0	-10.49	Peak	137.00	150	Horizontal	Pass
2**	2484.700	48.78	1.95	54.0	-5.22	AV	137.00	150	Horizontal	Pass

802.11n40 CHANNEL 8

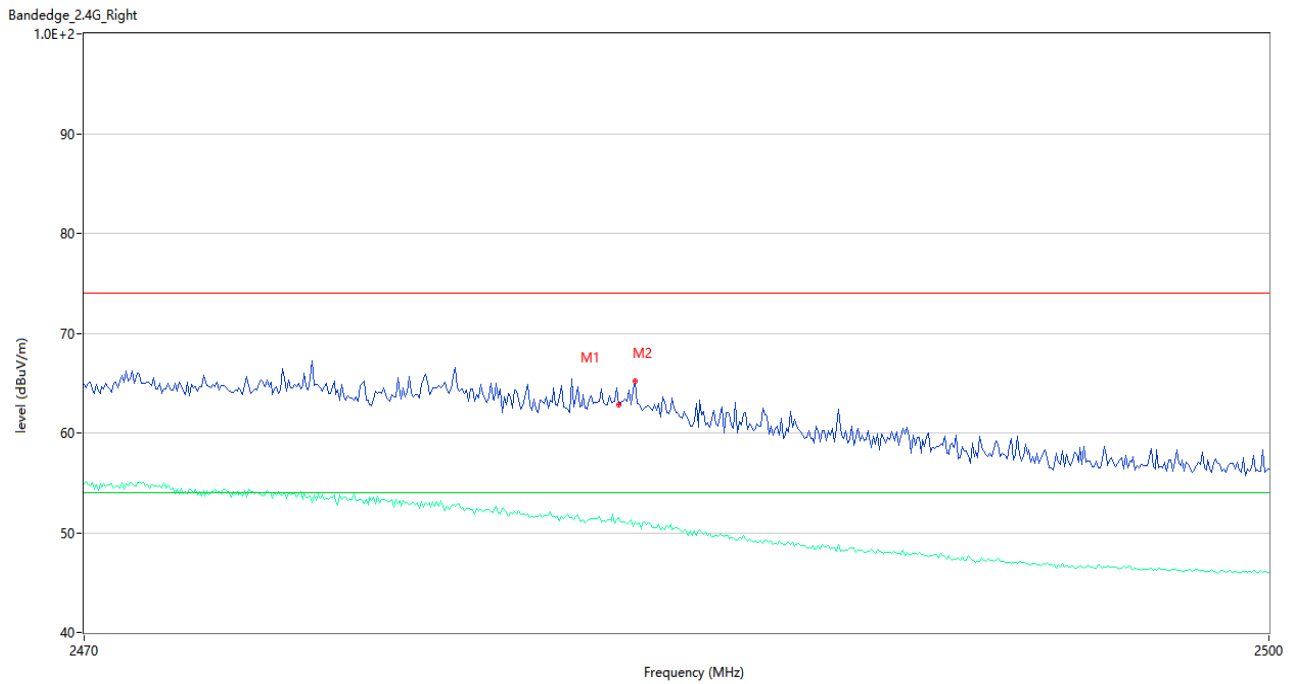

No.	Frequency (MHz)	Results (dBuV/m)	Factor (dB)	Limit (dBuV/m)	Over Limit (dB)	Detector	Table (Degree)	Height (cm)	Antenna	Verdict
1	2483.500	62.79	1.98	74.0	-11.21	Peak	136.00	150	Horizontal	Pass
1**	2483.500	50.77	1.98	54.0	-3.23	AV	136.00	150	Horizontal	Pass
2	2483.900	65.19	1.99	74.0	-8.81	Peak	124.00	150	Horizontal	Pass
2**	2483.900	50.93	1.99	54.0	-3.07	AV	124.00	150	Horizontal	Pass

802.11n40 CHANNEL 9

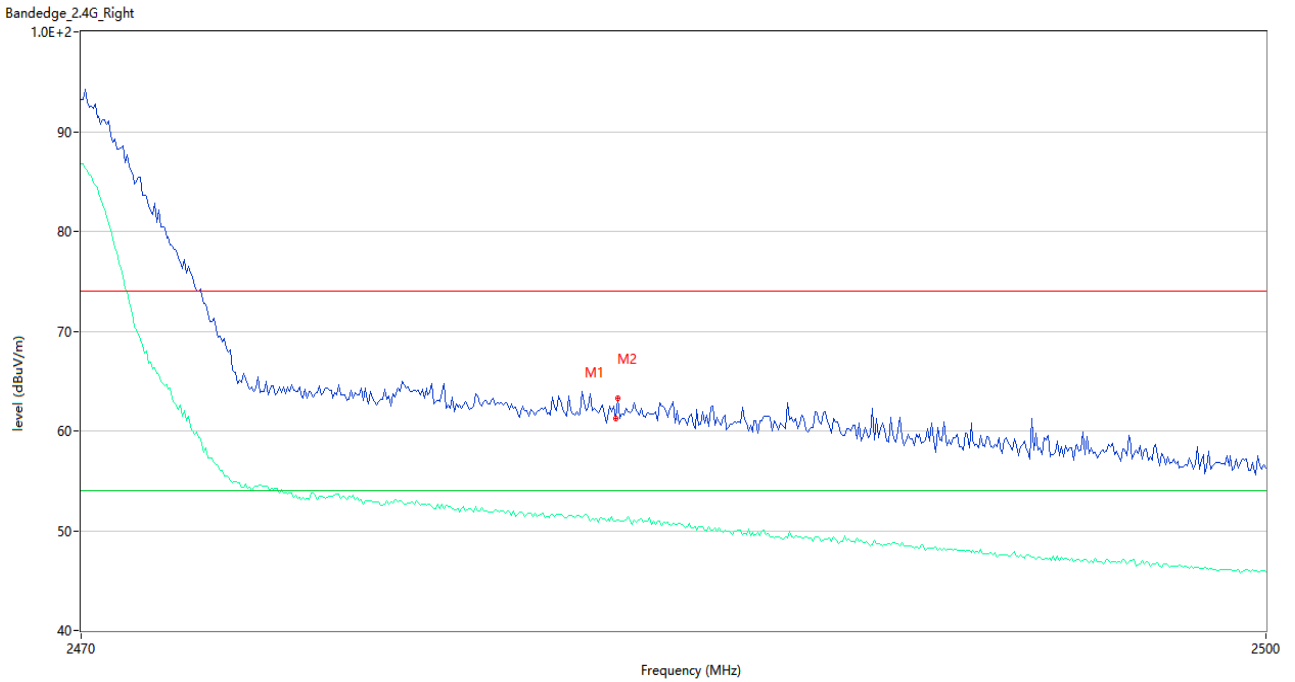

No.	Frequency (MHz)	Results (dBuV/m)	Factor (dB)	Limit (dBuV/m)	Over Limit (dB)	Detector	Table (Degree)	Height (cm)	Antenna	Verdict
1	2483.500	61.22	1.98	74.0	-12.78	Peak	333.00	150	Horizontal	Pass
1**	2483.500	50.93	1.98	54.0	-3.07	AV	333.00	150	Horizontal	Pass
2	2483.550	63.25	1.98	74.0	-10.75	Peak	337.00	150	Horizontal	Pass
2**	2483.550	50.91	1.98	54.0	-3.09	AV	337.00	150	Horizontal	Pass

A.8 Power Spectral Density (PSD)

The Power Spectral Density (PSD) please refer to report 211001862SHA-001, which was issued by Intertek Testing Services Shanghai on Jan. 05, 2022, **section 5.4 Test Results of Power spectrum density.**

ANNEX B TEST SETUP PHOTOS

Please refer the document “BL-SZ2230024-AR.PDF”.

ANNEX C EUT EXTERNAL PHOTOS

Please refer the document “BL-SZ2230024-AW.PDF”.

ANNEX D EUT INTERNAL PHOTOS

Please refer the document “BL-SZ2230024-AI.PDF”.

Statement

1. The laboratory guarantees the scientificity, accuracy and impartiality of the test, and is responsible for all the information in the report, except the information provided by the customer. The customer is responsible for the impact of the information provided on the validity of the results.
2. For the report with CNAS mark or A2LA mark, the items marked with "☆" are not within the accredited scope.
3. This report is invalid if it is altered, without the signature of the testing and approval personnel, or without the "inspection and testing dedicated stamp" or test report stamp.
4. The test data and results are only valid for the tested samples provided by the customer.
5. This report shall not be partially reproduced without the written permission of the laboratory.
6. Any objection shall be raised to the laboratory within 30 days after receiving the report.

--END OF REPORT--